

## Hava Kompresörleri ve Tamir Takımları

Air Compressors and  
Repair Kits

WE ARE THE  
TURKISH QUALITY  
AUTHORITY!

MERCEDES

MAN

VOLVO

SCANIA

DAF

RENAULT

IVECO

FORD BMC CUMMINS

MAGIRUS-İKARUS-PERKINS-ISUZU

  
**Yumak**<sup>®</sup>  
AIR BRAKE SYSTEMS

[www.mehmetyumak.com](http://www.mehmetyumak.com)

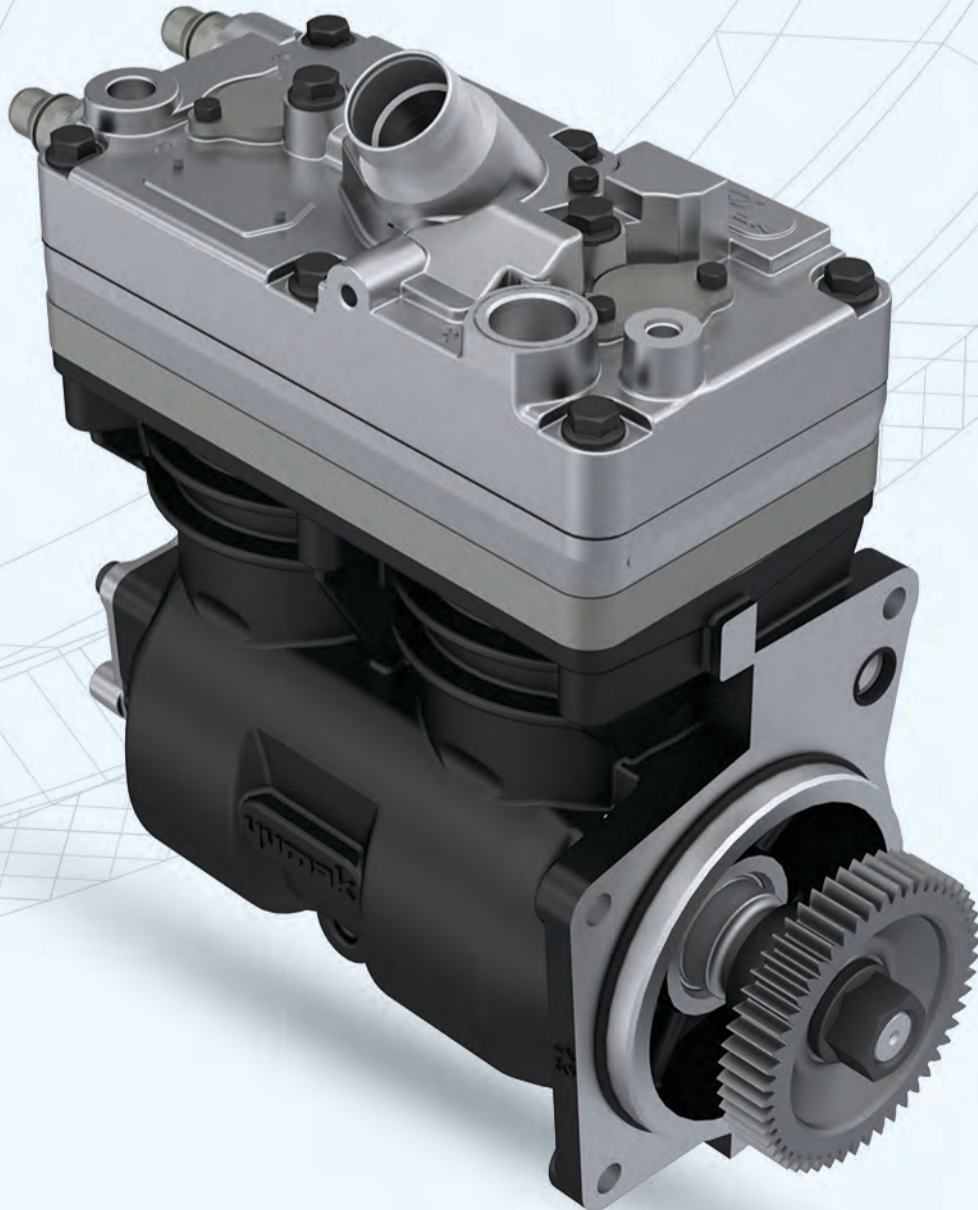

VERSİYON:1.1.9



# HOW TO FIND THE PRODUCT?

## ÜRÜNÜ NASIL BULURUM?

Yumak No	Main Part	Page
01.04.118	01.04.118	126
01.04.194	01.04.194	212
01.04.073.10	01.04.073.10	118
01.04.118.10	01.04.118.10	124
01.04.194	01.04.194	212
<b>01.06.050</b>	01.06.050	14
01.06.008	01.06.008	250
01.06.015	01.06.015	252
01.06.008	01.06.008	396
01.06.015	01.06.015	398
01.04.125	01.04.125	586
01.04.177	01.04.177	588

Oem No	Yumak No	Page
4571304515	01.06.049	4
4571304615	01.06.027	18
4571304715	01.06.032	24
4571304815	01.06.050	14
4571304815	01.06.007	20
<b>4571304915</b>	01.06.050	14
4571304915	01.06.007	20
4571305015	01.06.072	78
4571305515	01.06.030	16
4571306215	01.04.173	112
4571306315	01.04.175	112
4571306915	01.06.032	24

Oem No	Yumak No	Page
4571304515	01.06.049	4
4571304615	01.06.027	18
4571304715	01.06.032	24
4571304815	01.06.050	14
4571304815	01.06.007	20
4571304915	01.06.050	14
4571304915	01.06.007	20
4571305015	01.06.072	78
4571305515	01.06.030	16
4571306215	01.04.173	112
4571306315	01.04.175	112
4571306915	01.06.032	24

### Twin Cylinder Compressor Ø85 mm - 636 CC - Stroke 56 mm

Application - Vehicle  
MERCEDES AXOR OM 457



Yumak No	Oem No.	Wabco No.
<b>1</b> 01.06.050		
<b>2</b> 4571304915	4571304915	9125101040 9125101030 9125101010 9125101020
01.06.050.10		
<b>3</b> Without gear		

#### RK.01.479 Complete Cylinder Head

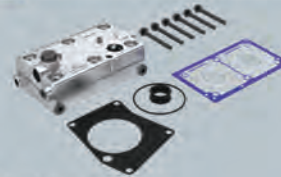

Wabco No : 9125109202

#### RK.01.349.06 Repair Kit

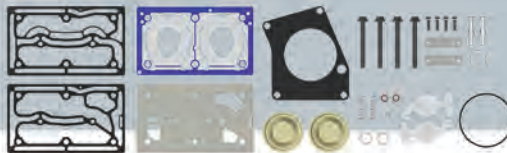

Wabco No : 9125109202

#### RK.01.349.09 Repair Kit



Wabco No : 9125109292

**3**

14

ALL ORIGINAL NUMBERS, MARKS AND MODELS FROM VEHICLE MANUFACTURERS LISTED IN THIS CATALOGUE ARE FOR COMPARISON PURPOSES ONLY



# **YUMAK** **AIR** **BRAKE** **SYSTEMS**



**yumak**<sup>®</sup>  
AIR BRAKE SYSTEMS

[www.mehmetyumak.com](http://www.mehmetyumak.com)







**yumak**<sup>®</sup>  
AIR BRAKE SYSTEMS

**WHO WE ARE**  
Biz Kimiz

**Established in 1975, Yumak is one of the largest manufacturer and direct seller of exceptional Quality Aftermarket Air Brake Equipment in Turkey. A large part of our Production is for the Export Markets that include 70 + countries on 6 continents. We are located in Konya, Turkey in the (KOS) Industrial Zone in a 14.000 m2 enclosed integrated factory facility using the most advanced state of the art German, Japanese, Italian and Turkish machinery.**

1975 yılında kurulan Yumak, Türkiye'nin en kaliteli satış sonrası havalı fren ekipmanı üreticisi ve doğrudan satıcısıdır. Üretimimiz 6 kıtada 70'den fazla ülkeyi içeriyor. En gelişmiş Alman, Japon, İtalyan ve Türk makinelerini kullanarak, Konya Organize Sanayi Bölgesinde 14.000 m2 kapalı entegre fabrika tesisimizle üretim sağlıyor, bu ülkenin gelişen endüstrisine değer katıyoruz.

**THE BEST HASN'T BEEN  
MANUFACTURED  
YET, BUT WE'RE TRYING!**

EN İYİSİ HENÜZ ÜRETİLMEDİ!





# PRODUCTION

## ÜRETİM

(14.000 METERS OF  
PRODUCTION AREA)

We mainly focus on Aftermarket Products for Heavy Duty Trucks and other Heavy Duty Vehicles like; MAN, M.Benz, Iveco, Ford, Volvo, Mack, Scania, DAF, BMC, Renault, CAT, etc... Our Products consist of Wabco, Knorr Bremse, Kongsberg, Cummins, Haldex, Bendix type Air Brake; Valves, Air Brake Equipment, Air Parts, Air Repair Kits, Clutch Master Cylinders, Clutch Servos, Clutch Repair Kits Compressors, Compressor Parts, Compressor Repair Kits and many other Heavy Duty parts including Special Projects.

Our Motto is,

**"THE BEST HASN'T BEEN  
MANUFACTURED  
YET, BUT WE'RE TRYING!"**

Özellikle ağır hizmet kamyonları ve diğer ağır hizmet araçları için satış sonrası ürünlere odaklanıyoruz. Buna örnek olarak; MAN, M.Benz, Iveco, Ford, Volvo, Mack, Scania, DAF, BMC, Renault, CAT, vb firmalarla ağır hizmet kamyonları üzerine iş ortaklığında bulunuyoruz. Ürünlerimiz Wabco, Knorr Bremse, Kongsberg, Cummins, Haldex, Bendix tip Havalı Fren; Vanalar, Hava Fren Ekipmanı, Hava Parçaları, Hava Tamir Takımları, Debriyaj Ana Silindirleri, Debriyaj Servoları, Debriyaj Tamir Takımları Kompresörleri, Kompresör Parçaları, Kompresör Tamir Takımları ve Özel Projeler de dahil olmak üzere diğer birçok ağır hizmet parçası üzerine üretim yapıyor ülke ekonomisine değer katıyoruz.

**Bu yolculuktaki mottomuz  
(Sloganımız) ise**

**" EN İYİSİ HENÜZ ÜRETİLMEDİ  
ZATEN BUNUN İÇİN  
ÇALIŞIYORUZ "**



**YUMAK**  
AIR BRAKE SYSTEMS

[www.mehmetyumak.com](http://www.mehmetyumak.com)



# QUALITY

## KALİTE

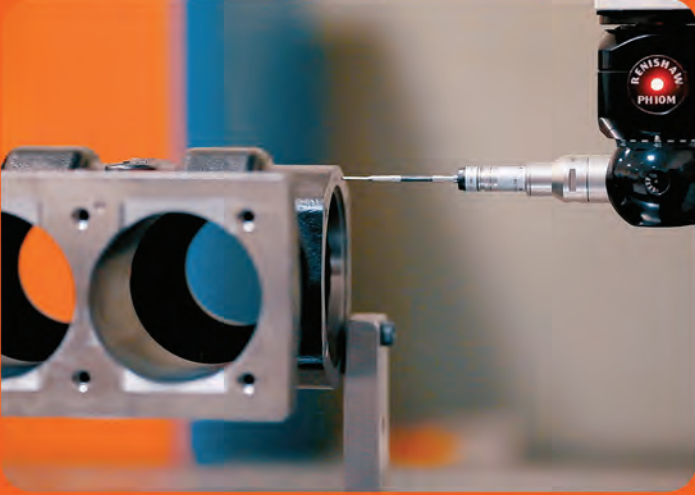

Our Quality Control Department uses the most up to date QMS systems in accordance with the Process Model. We carefully monitor all Production critical points start to finish so that non-conforming or faulty Products do not pass onto the final assembly area. We always try and instill the Notion of inclusivity of all our employees and have them share the desire to manufacture the best Quality Products possible. Also we, provide continuous education for all our employees so that they realize the importance of Quality.

Kalite Kontrol Departmanımızda, işlem modeline uygun en güncel KYS(Kaliteli Yönetim Sistemi) sistemlerini kullanıyoruz.

Tüm üretim sırasında kritik noktaları dikkatlice izliyor, uygun olmayan veya hatalı ürünlerin son montaj alanına geçmesine imkan vermiyoruz.

Daima tüm çalışanlarımıza eşit yaklaşıyor ve mümkün olan en iyi kalitede ürün üretme bilincini aşıyoruz. Ayrıca çalışma ekibimize kalitenin önemini fark etmeleri için sürekli eğitimler sunuyoruz.



**yumak**<sup>®</sup>  
AIR BRAKE SYSTEMS

[www.mehmetyumak.com](http://www.mehmetyumak.com)



MIS  
SION

# MISSION

MİSYON

Our mission is to be one of the leaders of fine Quality Air Brake Equipment manufacturers in the World. To achieve this goal, we will be trying to stay current with new Technologies, processes, equipment, continuous education and training, Quality material purchases, and to making highest Quality Products. At the end of the day, we want to make you, our Customers very happy and keep you for life. We highly regard your patronage !

Misyonumuz, dünyadaki en kaliteli Hava Fren Ekipmanı üreticilerinin liderlerinden biri olmaktır. Bu hedefe ulaşmak için yeni teknolojileri, en güncel ekipmanları, sürekli eğitimi, kaliteli malzeme tedarikini ve en yüksek kaliteli ürünleri üretme arzusunda güncelliğimizi koruyoruz. Günün sonunda sizi çok mutlu etmek ve siz değerli müşterilerimizi ömür boyu yanımızda görmek tek isteğimizdir.



**Yumak**  
AIR BRAKE SYSTEMS

[www.mehmetyumak.com](http://www.mehmetyumak.com)



6 KITA

# 6

CONTINENTS

82'DEN FAZLA  
ÜLKAYE İHRACAT

# 82

COUNTRIES  
EXPORTED  
TO

107 ÜLKEDE KAYITLI  
TİCARİ MARKA

# 107

COUNTRY  
TRADEMARK  
REGISTRATIONS







**yumak**<sup>®</sup>  
AIR BRAKE SYSTEMS

[www.mehmetyumak.com](http://www.mehmetyumak.com)





<b>MERCEDES</b>	<b>- 002 - 127 -</b>
<b>MAN</b>	<b>- 128 - 227 -</b>
<b>VOLVO</b>	<b>- 228 - 329 -</b>
<b>SCANIA</b>	<b>- 330 - 377 -</b>
<b>DAF</b>	<b>- 378 - 415 -</b>
<b>RENAULT</b>	<b>- 416 - 473 -</b>
<b>IVECO-DEUTZ</b>	<b>- 474 - 567 -</b>
<b>FORD-BMC</b>	<b>- 568 - 605 -</b>
<b>MAGIRUS-IKARUS-PERKINS-ISUZU</b>	<b>- 606 - 631 -</b>
<b>CUMMINS-VOLKS.-FORD BRASIL</b>	<b>- 632 - 733 -</b>
<b>INDEX</b>	<b>- 734 - 801 -</b>

**HAVA KOMPRESÖRLERİ  
ve TAMİR TAKIMLARI**

AIR COMPRESSORS AND REPAIR KITS

  
**yumak**<sup>®</sup>  
AIR BRAKE SYSTEMS



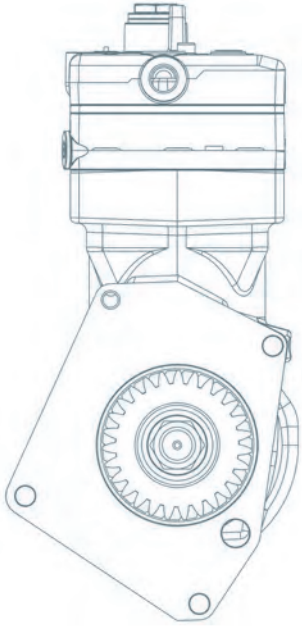

# MERCEDES

**HAVA KOMPRESÖRLERİ  
ve TAMİR TAKIMLARI**

AIR COMPRESSORS AND REPAIR KITS





# MERCEDES





## Single Cylinder Compressor Ø85 mm - 352 CC - Stroke 62 mm

Application - Vehicle  
MERCEDES AXOR OM 457

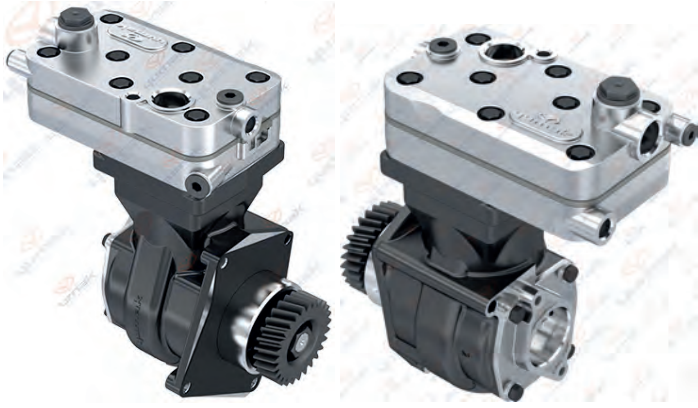

### 01.06.049

Oem. No.	Wabco No.
4571301615	4123520260
4571304415	4123520270
4571302415	
4571302315	
4571304515	
4571302615	

### 01.06.049.10

Wabco No.
4123520261
4123520271

Without gear



### 01.339

Crankcase



Wabco No : 4129050112

### RK.01.130.09

Repair Kit

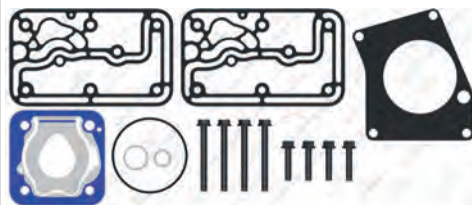

### RK.01.201

Repair Kit



### RK.01.169.10

Complete Cylinder Head



OEM No : 0011301215\* - 0011305219\*  
Wabco No : 412352922\*

### RK.01.130.06

Repair Kit

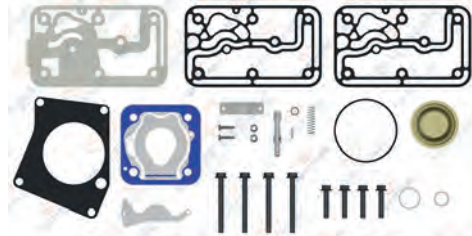

### RK.01.130.01

Repair Kit

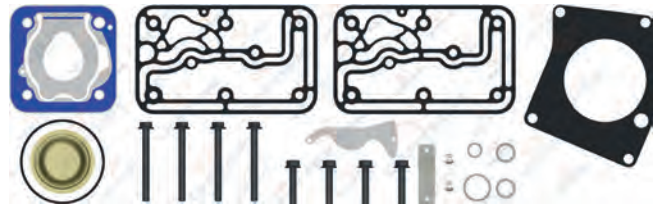

Wabco No : 412352002\*

### RK.01.130.07

Repair Kit

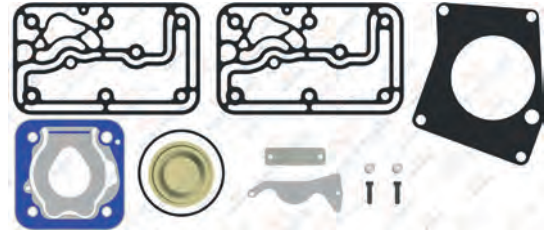

### RK.01.130.11

Repair Kit

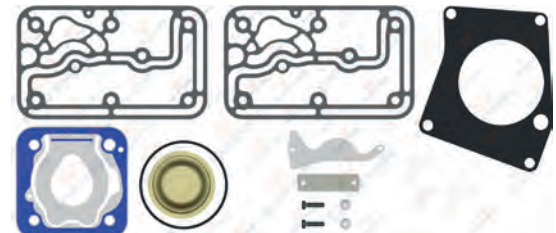

Use for old version cylinder repair kit. Yıpranmış kapaklar için.



# MERCEDES

## AIR COMPRESSOR AND REPAIR KIT

**01.367** Cylinder Head



8 680437 021681

**01.368** Valve Plate



8 680437 021704

**01.925** Crankshaft



M20X1.5 Left Hand



8 680437 028444

Wabco No : 4129056904

**01.369** Cooling Plate



8 680437 021728

**01.286** Crankshaft Flange



8 680437 020578

Oem. No : 0001312932  
Wabco No : 4111476034

**01.390** Connecting Rod



8 680437 022015

Oem. No : 0001312517 - 0001312917  
Wabco No : 9111457382

**RK.01.104.00** Piston&Ring (Ø85,00 mm)

- RK.01.104.10 85,25 mm
- RK.01.104.20 85,50 mm
- RK.01.104.30 85,75 mm
- RK.01.104.40 86,00 mm



2,00x2,00x4,00



8 680437 060277

**01.142.00** Piston (Ø85,00 mm)

- 01.142.10 85,25 mm
- 01.142.20 85,50 mm
- 01.142.30 85,75 mm
- 01.142.40 86,00 mm



2,00x2,00x4,00



8 680437 018674

**01.373.00** Ring (Ø85,00 mm)

- 01.373.10 85,25 mm
- 01.373.20 85,50 mm
- 01.373.30 85,75 mm
- 01.373.40 86,00 mm



2,00x2,00x4,00



8 680437 075431

Oem No : 0011311111  
Wabco No : 9115019202

**RK.01.800** Connecting Rod & Piston



STD.



8 680437 078302

Wabco No : 9125109272 - 4123529252  
4123529292 - 9120007302

**01.1189** Gasket



8 680437 017370

**01.360** Gear



Ø84,6 - Z:27



8 680437 021551

Oem No : 4571320905  
Wabco No : 8959051884

**RK.01.130.10** Repair Kit



8 680437 124085

**01.257** Bushing



8 680437 020233

Wabco No : 9115532044

**01.957** Nut



M20X1.5 Left Hand



8 680437 028871

Wabco No : 0029906650

## Single Cylinder Compressor Ø85 mm - 352 CC - Stroke 62 mm

Application - Vehicle  
MERCEDES AXOR OM 457

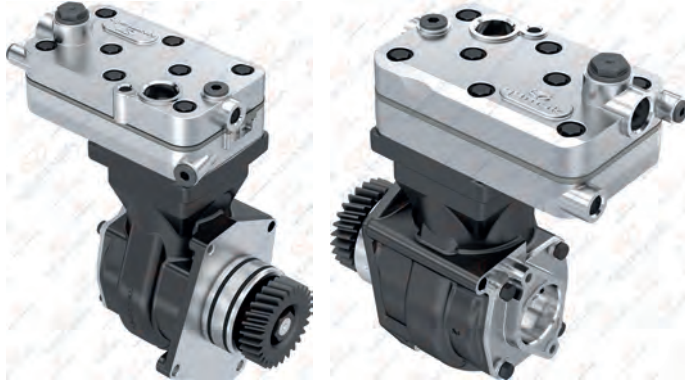

### 01.06.016

Oem. No.	Wabco No.
4571301615	4123520140
4571301715	4123520150
4571302115	4123520160

### 01.06.016.10

Without gear



### 01.339.K

Crankcase



### RK.01.130.13

Repair Kit

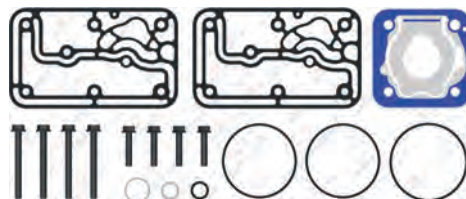

### RK.01.130.04

Repair Kit

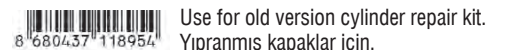
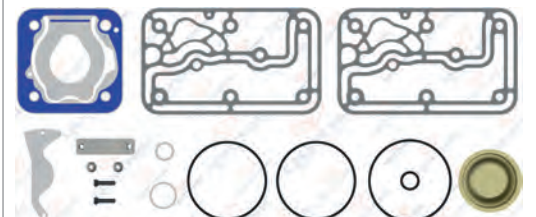

### RK.01.169

Complete Cylinder Head

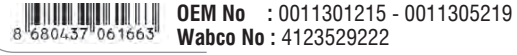

### RK.01.130.05

Repair Kit

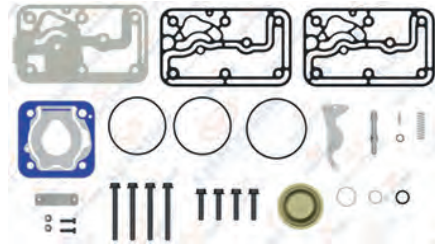

### RK.01.130.08

Repair Kit

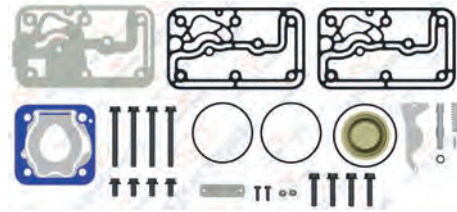

### RK.01.130.12

Repair Kit

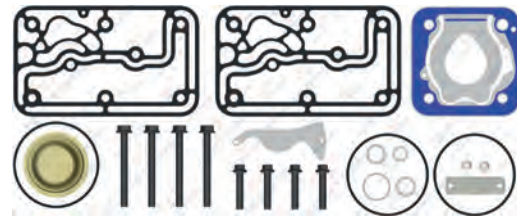

### RK.01.130

Repair Kit

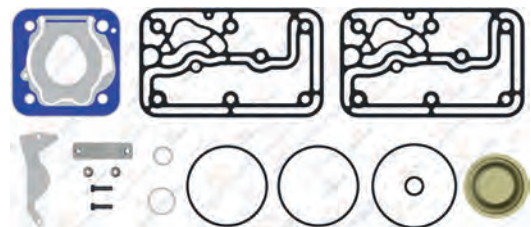



# MERCEDES

## AIR COMPRESSOR AND REPAIR KIT

**01.367** Cylinder Head



8 680437 021681

**01.368** Valve Plate



8 680437 021704

**01.925** Crankshaft



M20X1.5 Left Hand  
Wabco No : 4129056904

8 680437 028444

**01.369** Cooling Plate



8 680437 021728

**01.286** Crankshaft Flange



Oem. No : 0001312932  
Wabco No : 4111476034

8 680437 020578

**01.390** Connecting Rod



Oem. No : 0001312517 - 0001312917  
Wabco No : 9111457382

8 680437 022015

**RK.01.104.00** Piston&Ring (Ø85,00 mm)

RK.01.104.10	85,25 mm
RK.01.104.20	85,50 mm
RK.01.104.30	85,75 mm
RK.01.104.40	86,00 mm



2,00x2,00x4,00

8 680437 060277

**01.142.00** Piston (Ø85,00 mm)

01.142.10	85,25 mm
01.142.20	85,50 mm
01.142.30	85,75 mm
01.142.40	86,00 mm



2,00x2,00x4,00

8 680437 018674

**01.373.00** Ring (Ø85,00 mm)

01.373.10	85,25 mm
01.373.20	85,50 mm
01.373.30	85,75 mm
01.373.40	86,00 mm



2,00x2,00x4,00

Oem No : 0011311111  
Wabco No : 9115019202

8 680437 075431

**RK.01.800** Connecting Rod & Piston



STD.

Wabco No : 9125109272 - 4123529252  
4123529292 - 9120007302

8 680437 078302

**RK.01.909** Crankshaft Repair Kit



8 680437 109280

**01.360** Gear



Ø84,6 - Z:27

Oem No : 4571320905  
Wabco No : 8959051884

8 680437 021551

**RK.01.130.10** Repair Kit



8 680437 124085

**01.257** Bushing



Wabco No : 9115532044

8 680437 020233

**01.957** Nut



M20X1.5 Left Hand  
Wabco No : 0029906650

8 680437 028871

**RK.01.201** Repair Kit



8 680437 062110

## Single Cylinder Compressor Ø85 mm - 352 CC - Stroke 62 mm

Application - Vehicle  
MERCEDES AXOR NATO

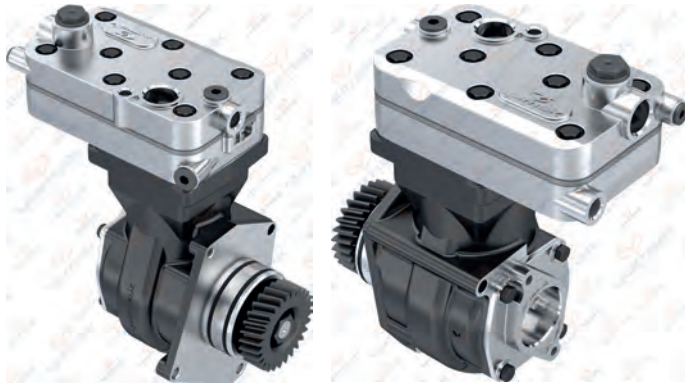

### 01.06.005

Oem. No.

Wabco No.

4123520100  
4123520110  
4123520130  
4123520170



### 01.339.K

Crankcase



### RK.01.130.13

Repair Kit

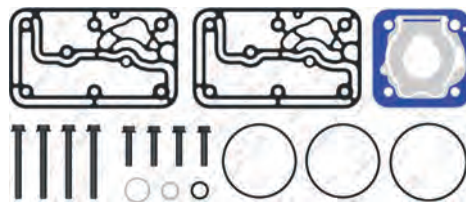

Wabco: 412352923\*

### RK.01.130.04

Repair Kit

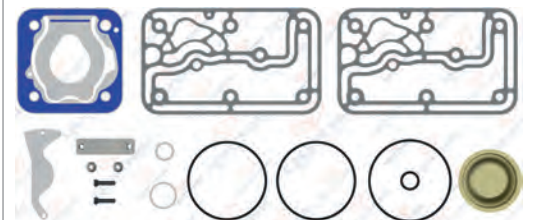

Use for old version cylinder repair kit.  
Yıpranmış kapaklar için.

### RK.01.169

Complete Cylinder Head



OEM No : 0011301215 - 0011305219  
Wabco No : 4123529222

### RK.01.130.05

Repair Kit

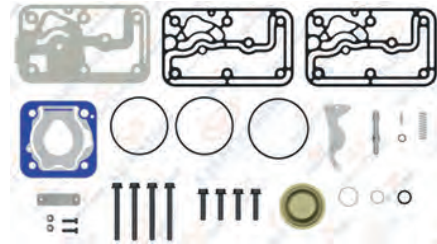

### RK.01.130.08

Repair Kit

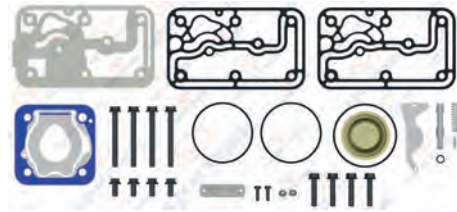

### RK.01.130.12

Repair Kit

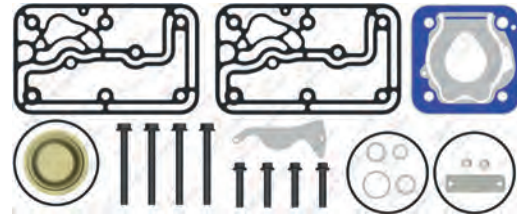

Wabco No : 4123520022

### RK.01.130

Repair Kit

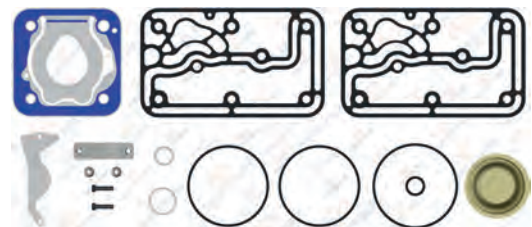





# MERCEDES

## AIR COMPRESSOR AND REPAIR KIT

**01.367** Cylinder Head

8 680437 021681

**01.368** Valve Plate



8 680437 021704

**01.359** Crankshaft





M20X1.5 Right Hand



8 680437 021537

**01.369** Cooling Plate

8 680437 021728

**01.286** Crankshaft Flange



Oem. No : 0001312932  
Wabco No : 4111476034

**01.390** Connecting Rod



Oem. No : 0001312517 - 0001312917  
Wabco No : 9111457382

**RK.01.104.00** Piston&Ring (Ø85,00 mm)

RK.01.104.10	85,25 mm
RK.01.104.20	85,50 mm
RK.01.104.30	85,75 mm
RK.01.104.40	86,00 mm



2,00x2,00x4,00



8 680437 060277

**01.142.00** Piston (Ø85,00 mm)

01.142.10	85,25 mm
01.142.20	85,50 mm
01.142.30	85,75 mm
01.142.40	86,00 mm



2,00x2,00x4,00



8 680437 018674

**01.373.00** Ring (Ø85,00 mm)

01.373.10	85,25 mm
01.373.20	85,50 mm
01.373.30	85,75 mm
01.373.40	86,00 mm



2,00x2,00x4,00



Oem No : 0011311111  
Wabco No : 9115019202

**RK.01.801** Connecting Rod & Piston



STD.



Wabco No : 4123529282

**01.257** Bushing



Wabco No : 9115532044

**01.360** Gear



Ø84,6 - Z:27





Oem No : 4571320905  
Wabco No : 8959051884

**01.302** Cap



8 680437 020769

**RK.01.130.10** Repair Kit

8 680437 124085

**01.144** Nut



M20X1.5 Right Hand



8 680437 018742

**RK.01.201** Repair Kit



8 680437 062110

## Single Cylinder Compressor Ø85 mm - 352 CC - Stroke 62 mm

Application - Vehicle  
MERCEDES AXOR

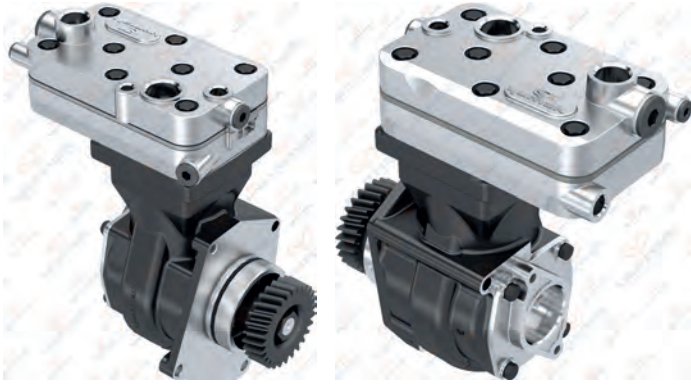

**01.06.020**

Oem. No.  
4571300815

Wabco No.  
4123520090  
4123520070  
4123520060



**01.888**

Crankcase



**RK.01.130.13**

Repair Kit

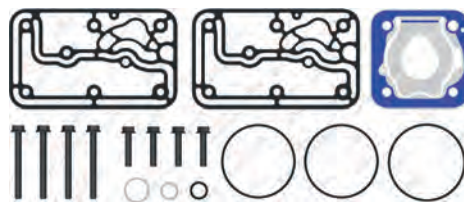

**RK.01.169** Complete Cylinder Head

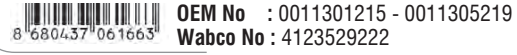

**RK.01.130.05**

Repair Kit

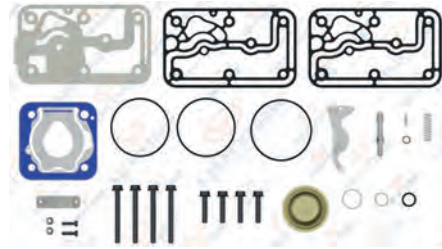

**RK.01.130.12**

Repair Kit

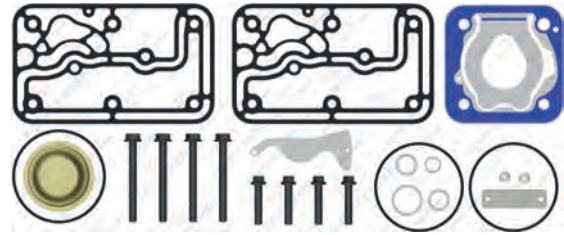

**RK.01.130**

Repair Kit

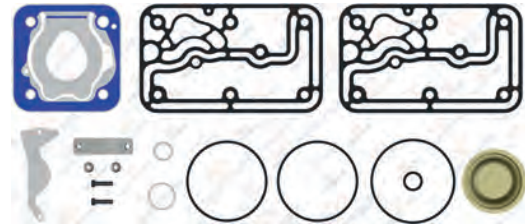

**RK.01.130.04**

Repair Kit

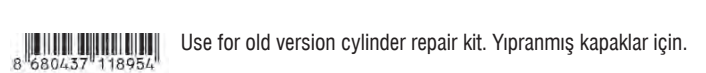
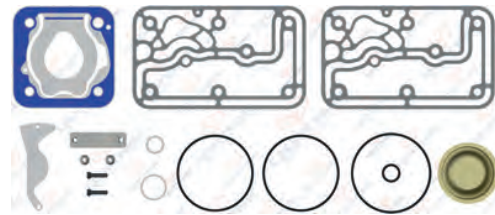

**RK.01.201**

Repair Kit





# MERCEDES

## AIR COMPRESSOR AND REPAIR KIT

**01.367** Cylinder Head



8 680437 021681

**01.368** Valve Plate



8 680437 021704

**01.359** Crankshaft



M20X1.5 Right Hand

8 680437 021537

**01.369** Cooling Plate



8 680437 021728

**01.286** Crankshaft Flange



Oem. No : 0001312932  
Wabco No : 4111476034

8 680437 020578

**01.390** Connecting Rod



Oem. No : 0001312517 - 0001312917  
Wabco No : 9111457382

8 680437 022015

**RK.01.104.00** Piston&Ring (Ø85,00 mm)

RK.01.104.10	85,25 mm
RK.01.104.20	85,50 mm
RK.01.104.30	85,75 mm
RK.01.104.40	86,00 mm



2,00x2,00x4,00

8 680437 060277

**01.142.00** Piston (Ø85,00 mm)

01.142.10	85,25 mm
01.142.20	85,50 mm
01.142.30	85,75 mm
01.142.40	86,00 mm



2,00x2,00x4,00

8 680437 018674

**01.373.00** Ring (Ø85,00 mm)

01.373.10	85,25 mm
01.373.20	85,50 mm
01.373.30	85,75 mm
01.373.40	86,00 mm



2,00x2,00x4,00

Oem No : 0011311111  
Wabco No : 9115019202

8 680437 075437

**RK.01.130.10** Connecting Rod & Piston



8 680437 124085

**01.257** Bushing



Wabco No : 9115532044

8 680437 020233

**01.360** Gear



Ø84,6 - Z:27

Oem No : 4571320905  
Wabco No : 8959051884

8 680437 021551

**01.302** Cap



8 680437 020769

**01.144** Nut



M20X1.5 Right Hand

8 680437 018742

## Single Cylinder Compressor Ø85 mm - 318 CC - Stroke 56 mm

Application - Vehicle  
MERCEDES 1840 / 3240

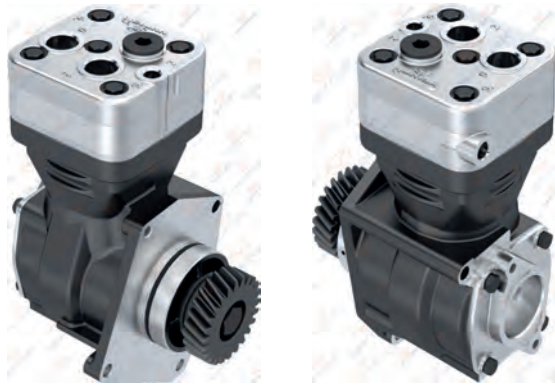

**01.04.032**

Oem. No.  
4571300515

Wabco No.  
9111530010



**01.394**

Crankcase



**RK.01.106**

Repair Kit



OEM No : 4111519212  
Wabco No : 4111519212

**RK.01.106.24**

Repair Kit



**RK.01.157**

Complete Cylinder Head



Wabco No : 911153941\*

**RK.01.099**

Complete Cylinder Head



Wabco No : 9111539412

**RK.01.158.01**

Repair Kit



**RK.01.158**

Repair Kit



**RK.01.106.20**

Repair Kit





# MERCEDES

## AIR COMPRESSOR AND REPAIR KIT

**01.376** Cylinder Head



Oem No : 0001312221  
Wabco No : 4111516544

**01.845** Valve Plate

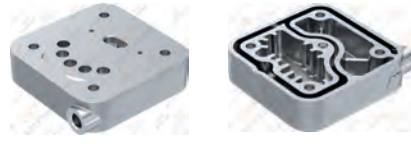

Use for RK.01.157

Oem No : 0001312221  
Wabco No : 4111516544

**01.375** Valve Plate



Use for RK.01.099

Oem No : 0001310809 - 0001310909  
Wabco No : 4111516522

**01.393** Crankshaft



M18X1.5 Right Hand

Oem No : 0001312221  
Wabco No : 4111516544

**01.286** Crankshaft Flange



Oem No : 0001312932  
Wabco No : 4111476034

**01.272** Connecting Rod



Oem No : 0001312221  
Wabco No : 4111516544

**RK.01.104.00** Piston&Ring (Ø85,00 mm)

- RK.01.104.10 85,25 mm
- RK.01.104.20 85,50 mm
- RK.01.104.30 85,75 mm
- RK.01.104.40 86,00 mm



2,00x2,00x4,00

Oem No : 0001312221  
Wabco No : 4111516544

**01.142.00** Piston (Ø85,00 mm)

- 01.142.10 85,25 mm
- 01.142.20 85,50 mm
- 01.142.30 85,75 mm
- 01.142.40 86,00 mm



2,00x2,00x4,00

Oem No : 0001312221  
Wabco No : 4111516544

**01.373.00** Ring (Ø85,00 mm)

- 01.373.10 85,25 mm
- 01.373.20 85,50 mm
- 01.373.30 85,75 mm
- 01.373.40 86,00 mm



2,00x2,00x4,00

Oem No : 0011311111  
Wabco No : 9115019202

**RK.01.158.24** Repair Kit

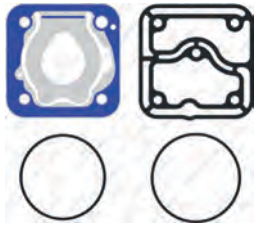

Oem No : 0001312221  
Wabco No : 4111516544

**RK.01.190** Repair Kit



Oem No : 0001312221  
Wabco No : 4111516544

**01.274** Gear



Ø79 - Z:25

Oem No : 4571320005  
Wabco No : 8959052104

**01.028** Screw



M18x30 Right Hand

Oem No : 0001312221  
Wabco No : 4111516544

**01.488** Bushing



46x42x24.5

Oem No : 0001312221  
Wabco No : 4111516544

## Twin Cylinder Compressor Ø85 mm - 636 CC - Stroke 56 mm

Application - Vehicle  
MERCEDES AXOR OM 457



**01.06.050**

Oem. No.	Wabco No.
4571304915	9125101040
4571304815	9125101030
4571303615	9125101010
	9125101020

**01.06.050.10**

Without gear



**01.1055**

Crankcase



Wabco No : 9125100172

**RK.01.349.10**

Repair Kit

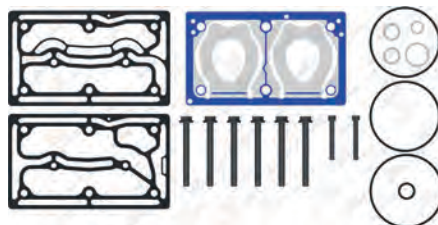

**RK.01.418**

Repair Kit

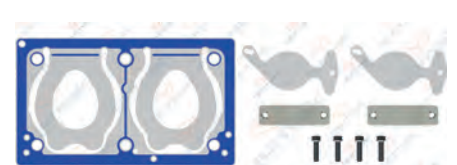

**RK.01.479**

Complete Cylinder Head



Oem. No : 0011305915  
Wabco No : 9125109202

**RK.01.349.06**

Repair Kit



**RK.01.349.09**

Repair Kit



Wabco No : 9125109292

**RK.01.349.07**

Repair Kit

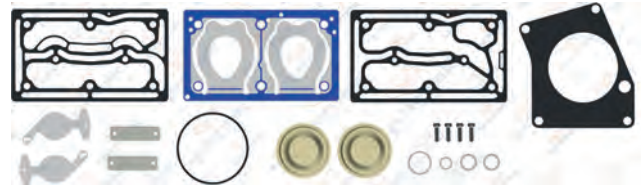

**RK.01.349.04**

Repair Kit

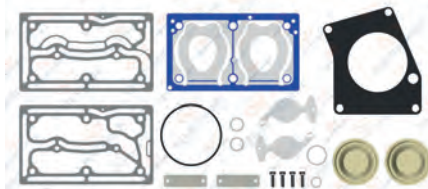

Use for old version cylinder repair kit. Yıpranmış kapaklar için.



# MERCEDES

## AIR COMPRESSOR AND REPAIR KIT

**01.822** Cylinder Head



8 680437 027072

**01.875** Valve Plate



8 680437 027850

**01.283** Crankshaft



M20X1.5 Left Hand  
Wabco No : 9115536944  
8 680437 020516

**01.884** Cooling Plate



8 680437 027973

**01.286** Crankshaft Flange



Oem. No : 0001312932  
Wabco No : 4111476034  
8 680437 020578

**01.390** Connecting Rod



Oem. No : 0001312517 - 0001312917  
Wabco No : 9111457382  
8 680437 022015

**RK.01.104.00** Piston&Ring (Ø85,00 mm)

RK.01.104.10	85,25 mm
RK.01.104.20	85,50 mm
RK.01.104.30	85,75 mm
RK.01.104.40	86,00 mm



2,00x2,00x4,00  
8 680437 060277

**01.142.00** Piston (Ø85,00 mm)

01.142.10	85,25 mm
01.142.20	85,50 mm
01.142.30	85,75 mm
01.142.40	86,00 mm



2,00x2,00x4,00  
8 680437 018674

**01.373.00** Ring (Ø85,00 mm)

01.373.10	85,25 mm
01.373.20	85,50 mm
01.373.30	85,75 mm
01.373.40	86,00 mm



2,00x2,00x4,00  
Oem No : 0011311111  
Wabco No : 9115019202  
8 680437 075431

**RK.01.800** Connecting Rod & Piston



Wabco No : 9125109272 - 4123529252  
4123529292 - 9120007302  
8 680437 078302

**RK.01.900** Crankshaft Repair Kit



Wabco No : 9125109282  
8 680437 109327

**01.360** Gear



Ø84,6 - Z:27  
Oem No : 4571320905  
Wabco No : 8959051884  
8 680437 021551

**RK.01.512** Repair Kit



8 680437 066040

**01.257** Bushing



Wabco No : 9115532044  
8 680437 020233

**01.957** Nut



M20X1.5 Left Hand  
Wabco No : 0029906650  
8 680437 028871

## Twin Cylinder Compressor Ø85 mm - 636 CC - Stroke 56 mm

Application - Vehicle  
MERCEDES AXOR

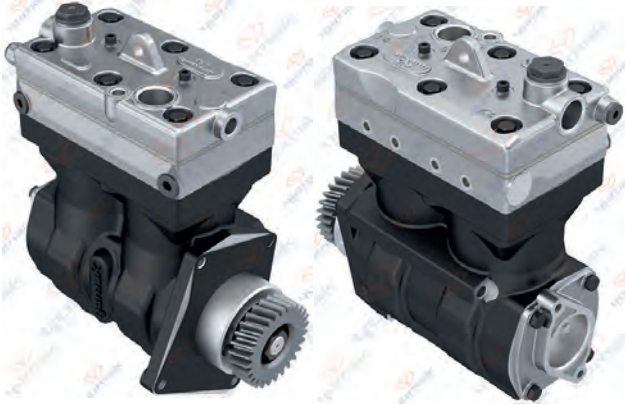

**01.06.113**

Wabco No.  
9125101070

**01.06.113.10**

Without gear



**01.1055**

Crankcase



Wabco No : 9125100172

**RK.01.349.18**

Repair Kit

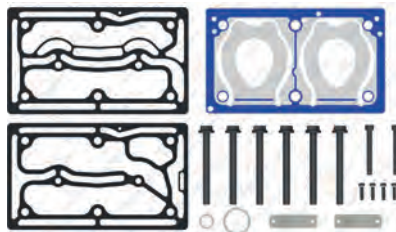

Wabco No : 9125109382

**RK.01.713**

Repair Kit

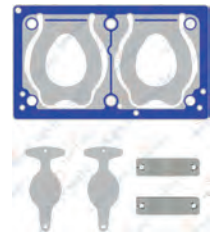

**RK.01.869**

Complete Cylinder Head



Wabco No : 9125109372

**RK.01.349.14**

Repair Kit

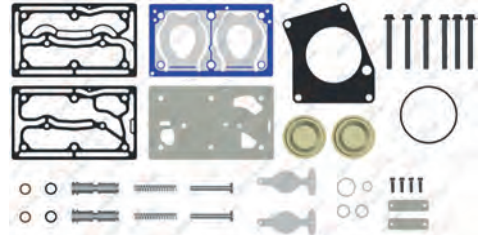

**RK.01.349.15**

Repair Kit

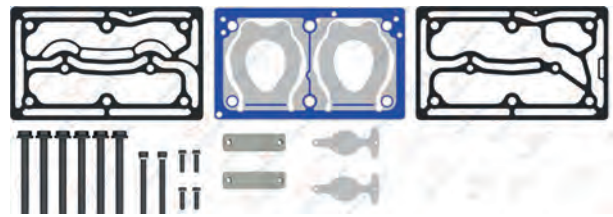

**RK.01.349.16**

Repair Kit

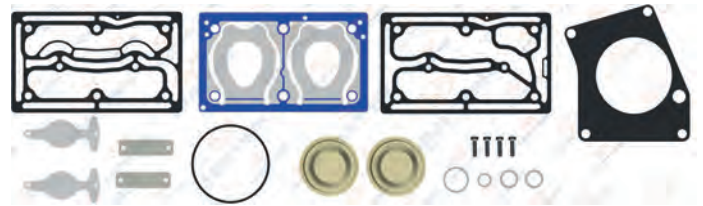

**RK.01.349.17**

Repair Kit

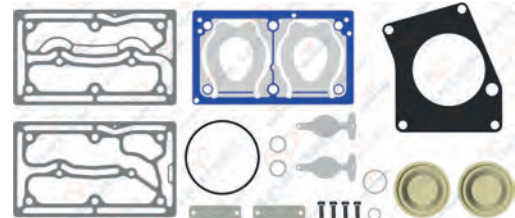

Use for old version cylinder repair kit. Yıpranmış kapaklar için.



# MERCEDES

## AIR COMPRESSOR AND REPAIR KIT

**01.822** Cylinder Head



8 680437 027072

**01.1478.10** Valve Plate



8 680437 164111

**01.283** Crankshaft



M20X1.5 Left Hand  
Wabco No : 9115536944  
8 680437 020516

**01.884** Cooling Plate



8 680437 027973

**01.286** Crankshaft Flange



Oem. No : 0001312932  
Wabco No : 4111476034  
8 680437 020578

**01.390** Connecting Rod



Oem. No : 0001312517 - 0001312917  
Wabco No : 9111457382  
8 680437 022015

**RK.01.104.00** Piston&Ring (Ø85,00 mm)

RK.01.104.10	85,25 mm
RK.01.104.20	85,50 mm
RK.01.104.30	85,75 mm
RK.01.104.40	86,00 mm



2,00x2,00x4,00  
8 680437 060277

**01.142.00** Piston (Ø85,00 mm)

01.142.10	85,25 mm
01.142.20	85,50 mm
01.142.30	85,75 mm
01.142.40	86,00 mm



2,00x2,00x4,00  
8 680437 018674

**01.373.00** Ring (Ø85,00 mm)

01.373.10	85,25 mm
01.373.20	85,50 mm
01.373.30	85,75 mm
01.373.40	86,00 mm



2,00x2,00x4,00  
Oem No : 0011311111  
Wabco No : 9115019202  
8 680437 075431

**RK.01.800** Connecting Rod & Piston



Wabco No : 9125109272 - 4123529252  
4123529292 - 9120007302  
8 680437 078302

**RK.01.900** Crankshaft Repair Kit



Wabco No : 9125109282  
8 680437 109327

**01.360** Gear



Ø84,6 - Z:27  
Oem No : 4571320905  
Wabco No : 8959051884  
8 680437 021551

**RK.01.714** Repair Kit



8 680437 077244

**01.257** Bushing



Wabco No : 9115532044  
8 680437 020233

**01.957** Nut



M20X1.5 Left Hand  
Wabco No : 0029906650  
8 680437 028871

## Twin Cylinder Compressor Ø85 mm - 636 CC - Stroke 56 mm

Application - Vehicle  
MERCEDES AXOR TRAVEGO  
0500 UA BUS

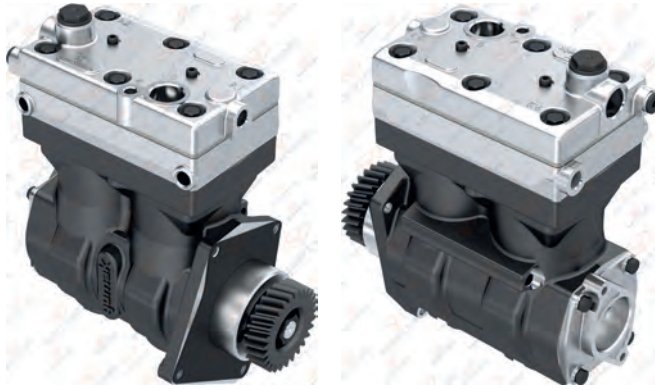

### 01.06.080

Oem. No.	Wabco No.
4761300215	9125102000
4571307215	9125102010
4571305515	9125101050

### 01.06.080.10

Wabco No.  
9125102011

Without gear



### 01.1055

Crankcase



### RK.01.703.02

Repair Kit

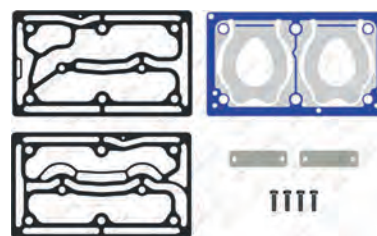

### RK.01.703.03

Repair Kit

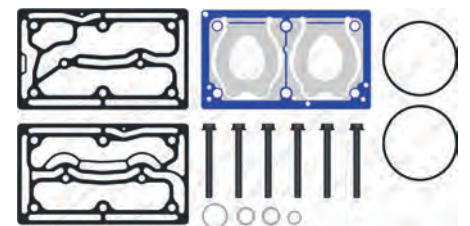

Wabco No : 9125109212

### RK.01.707

Complete Cylinder Head



Wabco No : 9125109302

### RK.01.703.06

Repair Kit

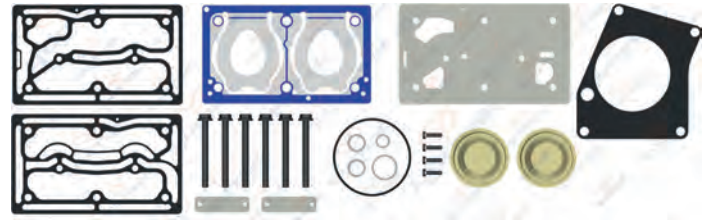

### RK.01.703.01

Repair Kit

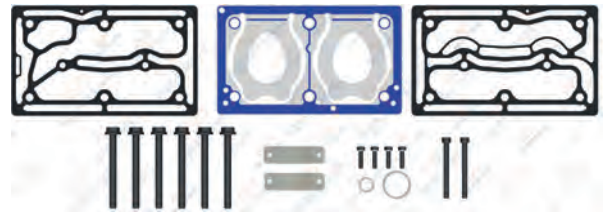

Wabco No : 9125109312

### RK.01.703

Repair Kit

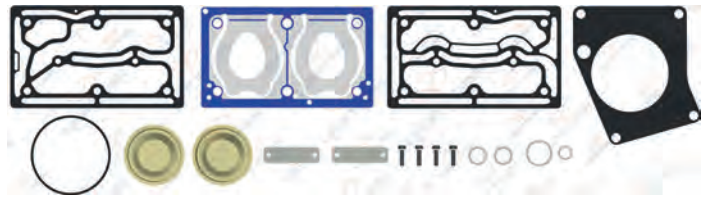

### RK.01.703.04

Repair Kit

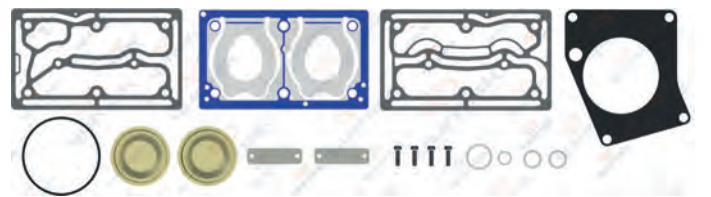

Use for old version cylinder repair kit. Yıpranmış kapaklar için.



# MERCEDES

## AIR COMPRESSOR AND REPAIR KIT

01.822

Cylinder Head



8 680437 027072

01.1489

Valve Plate



8 680437 078661

01.283

Crankshaft



M20X1.5 Left Hand



8 680437 020516

Wabco No : 9115536944

01.884

Cooling Plate



8 680437 027973

01.286

Crankshaft Flange



8 680437 020578

Oem. No : 0001312932  
Wabco No : 4111476034

01.390

Connecting Rod



8 680437 022015

Oem. No : 0001312517 - 0001312917  
Wabco No : 9111457382

RK.01.104.00

Piston&Ring (Ø85,00 mm)

- RK.01.104.10 85,25 mm
- RK.01.104.20 85,50 mm
- RK.01.104.30 85,75 mm
- RK.01.104.40 86,00 mm



2,00x2,00x4,00



8 680437 060277

01.142.00

Piston (Ø85,00 mm)

- 01.142.10 85,25 mm
- 01.142.20 85,50 mm
- 01.142.30 85,75 mm
- 01.142.40 86,00 mm



2,00x2,00x4,00



8 680437 018674

01.373.00

Ring (Ø85,00 mm)

- 01.373.10 85,25 mm
- 01.373.20 85,50 mm
- 01.373.30 85,75 mm
- 01.373.40 86,00 mm



2,00x2,00x4,00



8 680437 075431

Oem No : 0011311111  
Wabco No : 9115019202

RK.01.800

Connecting Rod & Piston



STD.



8 680437 078302

Wabco No : 9125109272 - 4123529252  
4123529292 - 9120007302

01.1189

Gasket



8 680437 017370

01.360

Gear



Ø84,6 - Z:27



8 680437 021551

Oem No : 4571320905  
Wabco No : 8959051884

RK.01.418.01

Repair Kit

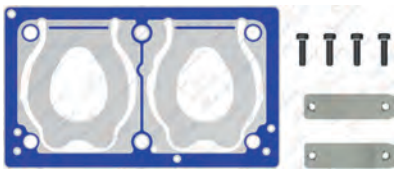

8 680437 124061

01.257

Bushing



8 680437 020233

Wabco No : 9115532044

01.957

Nut



M20X1.5 Left Hand



8 680437 028871

Wabco No : 0029906650

## Twin Cylinder Compressor Ø85 mm - 636 CC - Stroke 56 mm

Application - Vehicle  
MERCEDES AXOR

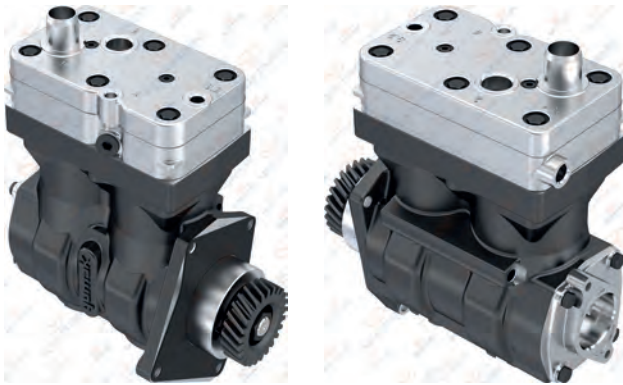

**01.06.027**

Oem. No.	Wabco No.
4571304615	9115530070
4571302015	9115530030

**01.06.027.10**

Without gear



**01.459** Crankcase



**RK.01.101** Repair Kit



**RK.01.164.10** Complete Cylinder Head

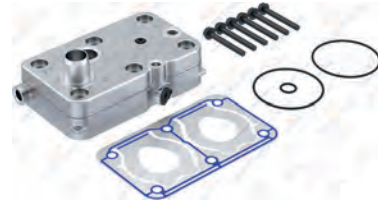

**RK.01.129.01** Repair Kit

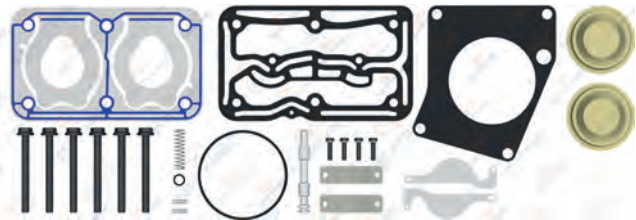

**RK.01.129.02** Repair Kit



**RK.01.129.03** Repair Kit

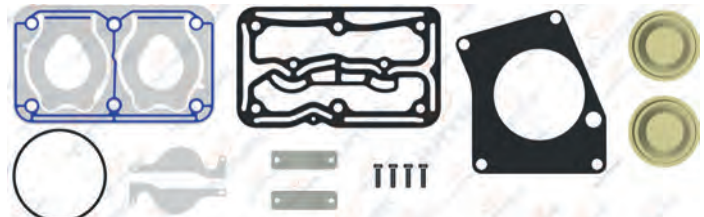

**RK.01.129.09** Repair Kit

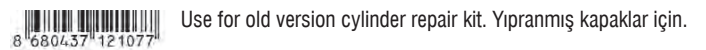
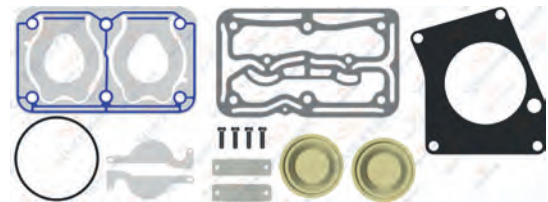

**RK.01.181** Repair Kit





# MERCEDES

## AIR COMPRESSOR AND REPAIR KIT

**01.270** Cylinder Head



8 680437 020370

**01.426** Valve Plate



8 680437 072034

**01.283** Crankshaft



M20X1.5 Left Hand



8 680437 020516

Wabco No : 9115536944

**01.257** Bushing



8 680437 020233

Wabco No : 9115532044

**01.286** Crankshaft Flange



8 680437 020578

Oem. No : 0001312932  
Wabco No : 4111476034

**01.390** Connecting Rod



8 680437 022015

Oem. No : 0001312517 - 0001312917  
Wabco No : 9111457382

**RK.01.104.00** Piston&Ring (Ø85,00 mm)

- RK.01.104.10 85,25 mm
- RK.01.104.20 85,50 mm
- RK.01.104.30 85,75 mm
- RK.01.104.40 86,00 mm



2,00x2,00x4,00



8 680437 060277

**01.142.00** Piston (Ø85,00 mm)

- 01.142.10 85,25 mm
- 01.142.20 85,50 mm
- 01.142.30 85,75 mm
- 01.142.40 86,00 mm



2,00x2,00x4,00



8 680437 018674

**01.373.00** Ring (Ø85,00 mm)

- 01.373.10 85,25 mm
- 01.373.20 85,50 mm
- 01.373.30 85,75 mm
- 01.373.40 86,00 mm



2,00x2,00x4,00



8 680437 075431

Oem No : 0011311111  
Wabco No : 9115019202

**01.302** Cap



8 680437 020769

**01.1189** Gasket



8 680437 017370

**01.912** Gear



Ø79,4 - Z:25



8 680437 028338

Oem No : 4571320605  
Wabco No : 8959051014

**01.957** Nut



M20X1.5 Left Hand



8 680437 028871

Wabco No : 0029906650

## Twin Cylinder Compressor Ø85 mm - 636 CC - Stroke 56 mm

Application - Vehicle  
MERCEDES AXOR



### 01.06.007

Oem. No.	Wabco No.
4571302515-4571302715	9115531040
4571303715-4571304815	9115531050
4571304915-4571307115	9115531030
4571301215-4571301915	9115531010
4571302215	9115531000

### 01.06.007.10

Without gear



### 01.459.K

Crankcase



### RK.01.129.22

Repair Kit

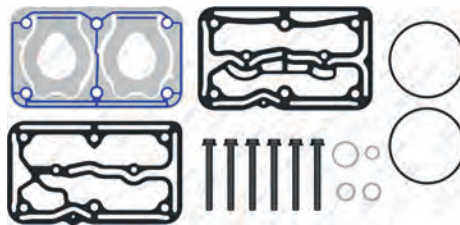

OEM No : 0011302815 - 001130231  
Wabco No : 9115539252

### RK.01.181

Repair Kit



### RK.01.166

Complete Cylinder Head

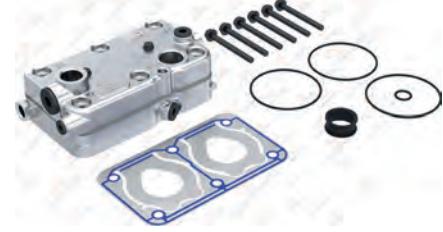

OEM No : 0011300815  
Wabco No : 9115530012

### RK.01.129.05

Repair Kit

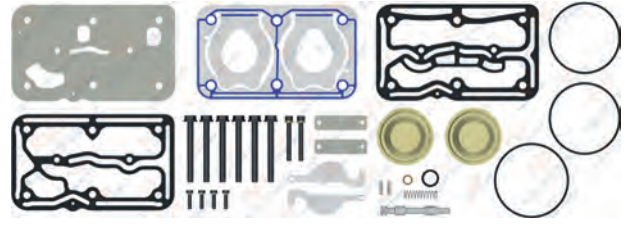

### RK.01.129.10

Repair Kit

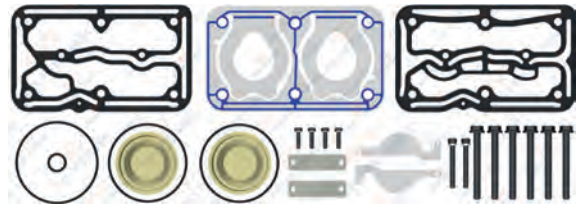

Wabco No : 9115539262

### RK.01.129

Repair Kit

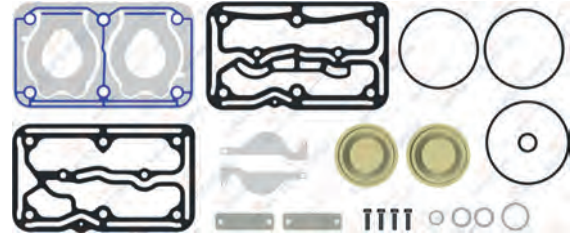

### RK.01.129.04

Repair Kit

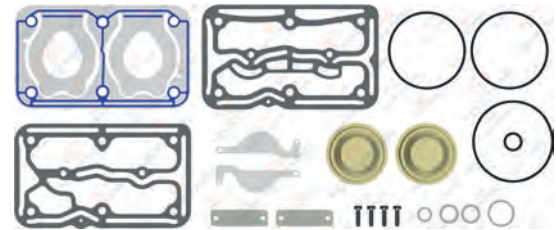

Use for old version cylinder repair kit. Yıpranmış kapaklar için.



# MERCEDES

## AIR COMPRESSOR AND REPAIR KIT

**01.458** Cylinder Head



8 680437 022855

**01.426** Valve Plate



8 680437 072034

**01.283** Crankshaft



M20X1.5 Left Hand  
Wabco No : 9115536944  
8 680437 020516

**01.464** Cooling Plate



8 680437 022961

**01.286** Crankshaft Flange



Oem. No : 0001312932  
Wabco No : 4111476034  
8 680437 020578

**01.390** Connecting Rod



Oem. No : 0001312517 - 0001312917  
Wabco No : 9111457382  
8 680437 022015

**RK.01.104.00** Piston&Ring (Ø85,00 mm)

RK.01.104.10	85,25 mm
RK.01.104.20	85,50 mm
RK.01.104.30	85,75 mm
RK.01.104.40	86,00 mm



2,00x2,00x4,00  
8 680437 060277

**01.142.00** Piston (Ø85,00 mm)

01.142.10	85,25 mm
01.142.20	85,50 mm
01.142.30	85,75 mm
01.142.40	86,00 mm



2,00x2,00x4,00  
8 680437 018674

**01.373.00** Ring (Ø85,00 mm)

01.373.10	85,25 mm
01.373.20	85,50 mm
01.373.30	85,75 mm
01.373.40	86,00 mm



2,00x2,00x4,00  
Oem No : 0011311111  
Wabco No : 9115019202  
8 680437 075431

**RK.01.800** Connecting Rod & Piston



STD.  
Wabco No : 9125109272 - 4123529252  
4123529292 - 9120007302  
8 680437 078302

**RK.01.101** Repair Kit



8 680437 060246

**01.360** Gear



Ø84,6 - Z:27  
Oem No : 4571320905  
Wabco No : 8959051884  
8 680437 021551

**RK.01.900** Crankshaft Repair Kit



Wabco No : 9125109282  
8 680437 109327

**01.257** Bushing



Wabco No : 9115532044  
8 680437 020233

**01.957** Nut



M20X1.5 Left Hand  
Wabco No : 0029906650  
8 680437 028871

## Twin Cylinder Compressor Ø85 mm - 636 CC - Stroke 56 mm

Application - Vehicle  
MERCEDES AXOR OM 457  
EVOBUS

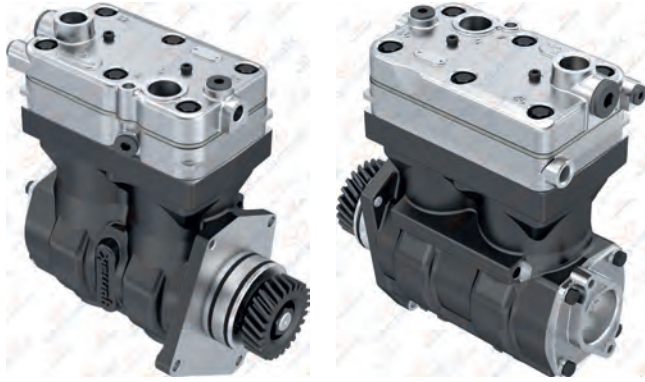

**01.06.006**

Oem. No.  
4571301815

Wabco No.  
9115530020



**01.459.K**

Crankcase



**RK.01.129.22**

Repair Kit

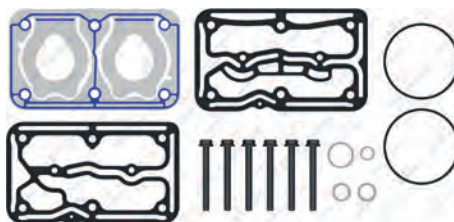

**RK.01.181**

Repair Kit



**RK.01.166**

Complete Cylinder Head



OEM No : 0011300815  
Wabco No : 9115530012

**RK.01.129.06**

Repair Kit

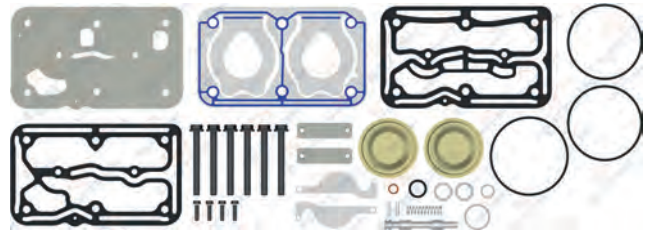

**RK.01.129.10**

Repair Kit

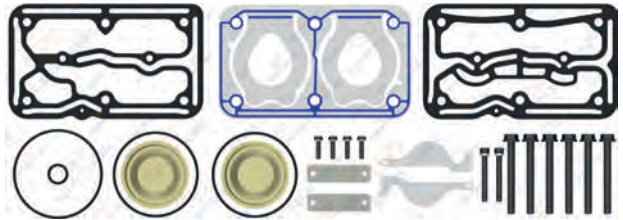

Wabco No : 9115539262

**RK.01.129**

Repair Kit

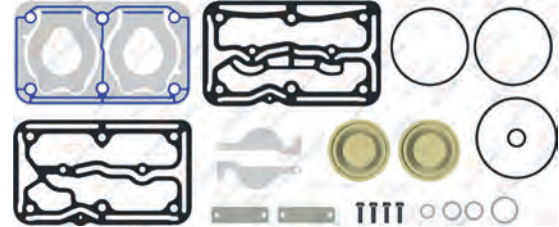

**RK.01.129.04**

Repair Kit

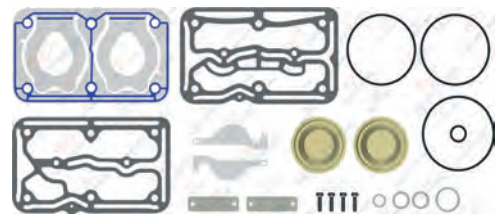

Use for old version cylinder repair kit. Yıpranmış kapaklar için.



# MERCEDES

## AIR COMPRESSOR AND REPAIR KIT

**01.458** Cylinder Head



8 680437 022855

**01.426** Valve Plate



8 680437 072034

**01.283** Crankshaft



M20X1.5 Left Hand  
Wabco No : 9115536944  
8 680437 020516

**01.464** Cooling Plate



8 680437 022961

**01.286** Crankshaft Flange



Oem. No : 0001312932  
Wabco No : 4111476034  
8 680437 020578

**01.390** Connecting Rod



Oem. No : 0001312517 - 0001312917  
Wabco No : 9111457382  
8 680437 022015

**RK.01.104.00** Piston&Ring (Ø85,00 mm)

RK.01.104.10	85,25 mm
RK.01.104.20	85,50 mm
RK.01.104.30	85,75 mm
RK.01.104.40	86,00 mm



2,00x2,00x4,00  
8 680437 060277

**01.142.00** Piston (Ø85,00 mm)

01.142.10	85,25 mm
01.142.20	85,50 mm
01.142.30	85,75 mm
01.142.40	86,00 mm



2,00x2,00x4,00  
8 680437 018674

**01.373.00** Ring (Ø85,00 mm)

01.373.10	85,25 mm
01.373.20	85,50 mm
01.373.30	85,75 mm
01.373.40	86,00 mm



2,00x2,00x4,00  
Oem No : 0011311111  
Wabco No : 9115019202  
8 680437 075431

**RK.01.800** Connecting Rod & Piston



STD.  
Wabco No : 9125109272 - 4123529252  
4123529292 - 9120007302  
8 680437 078302

**RK.01.101** Gasket



8 680437 060246

**01.912** Gear



Ø79,4 - Z:25  
Oem No : 4571320605  
Wabco No : 8959051014  
8 680437 028338

**RK.01.900** Crankshaft Repair Kit



Wabco No : 9125109282  
8 680437 109327

**01.257** Bushing



Wabco No : 9115532044  
8 680437 020233

**01.957** Nut



M20X1.5 Left Hand  
Wabco No : 0029906650  
8 680437 028871

## Twin Cylinder Compressor Ø85 mm - 636 CC - Stroke 56 mm

**Application - Vehicle**  
MERCEDES TRAVEGO 15 / TOURISMO 15  
SETRA 415 CITARO 18M

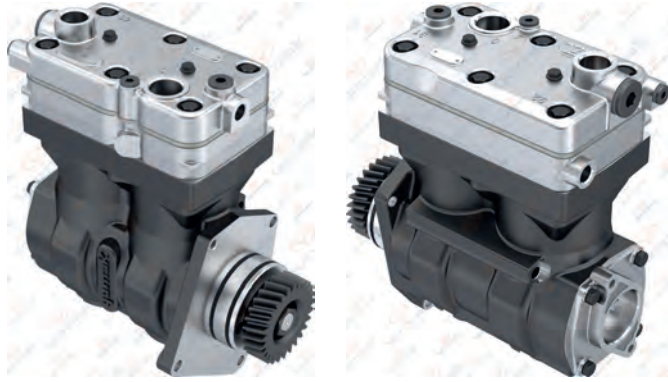

**01.06.032**

Oem. No.	Wabco No.
4571302915	9115532000
4571304715	9115532030
4571306915	

**01.06.032.10**

Without gear



**01.459.K**

Crankcase



**RK.01.129.22**

Repair Kit

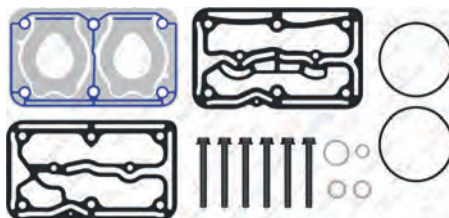

Oem No : 0011302815-0011302315  
Wabco : 9115539252

**RK.01.181.01**

Repair Kit

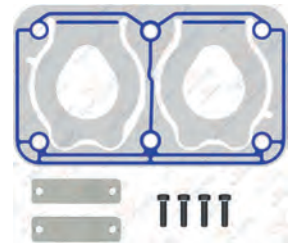

**RK.01.232**

Complete Cylinder Head



Oem. No : 0011302515  
Wabco No : 9115539242

**RK.01.342.05**

Repair Kit

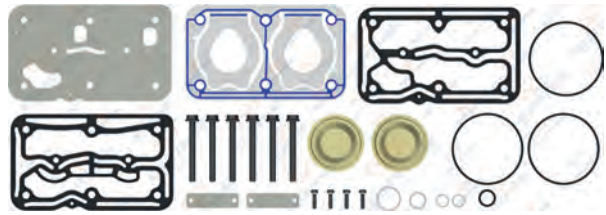

**RK.01.342.03**

Repair Kit

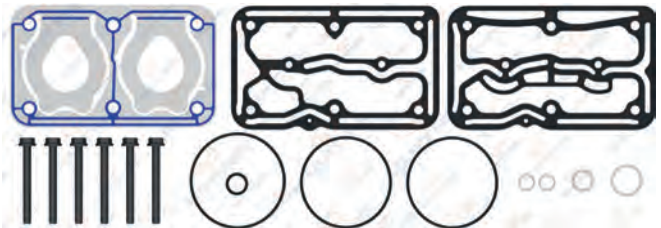

**RK.01.342**

Repair Kit

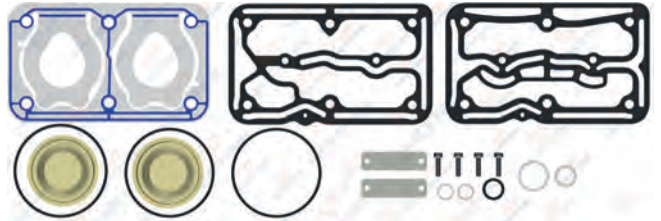

**RK.01.342.04**

Repair Kit

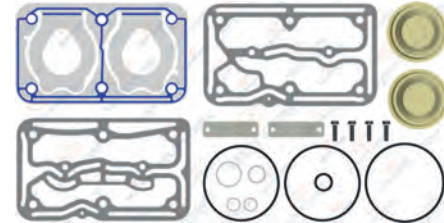

Use for old version cylinder repair kit. Yıpranmış kapaklar için.



# MERCEDES

## AIR COMPRESSOR AND REPAIR KIT

**01.458** Cylinder Head



8 680437 022855

**01.427** Valve Plate



8 680437 073482

**01.283** Crankshaft



M20X1.5 Left Hand



8 680437 020516

Wabco No : 9115536944

**01.464** Cooling Plate



8 680437 022961

**01.286** Crankshaft Flange



8 680437 020578

Oem. No : 0001312932  
Wabco No : 4111476034

**01.390** Connecting Rod



8 680437 022015

Oem. No : 0001312517 - 0001312917  
Wabco No : 9111457382

**RK.01.104.00** Piston&Ring (Ø85,00 )

- RK.01.104.10 85,25 mm
- RK.01.104.20 85,50 mm
- RK.01.104.30 85,75 mm
- RK.01.104.40 86,00 mm



2,00x2,00x4,00



8 680437 060277

**01.142.00** Piston (Ø85,00 mm)

- 01.142.10 85,25 mm
- 01.142.20 85,50 mm
- 01.142.30 85,75 mm
- 01.142.40 86,00 mm



2,00x2,00x4,00



8 680437 018674

**01.373.00** Ring (Ø85,00 mm)

- 01.373.10 85,25 mm
- 01.373.20 85,50 mm
- 01.373.30 85,75 mm
- 01.373.40 86,00 mm



2,00x2,00x4,00



8 680437 075431

Oem No : 0011311111  
Wabco No : 9115019202

**RK.01.800** Connecting Rod & Piston



STD.



8 680437 078302

Wabco No : 9125109272 - 4123529252  
4123529292 - 9120007302

**01.302** Cap



8 680437 020769

**01.360** Gear



Ø84,6 - Z:27



8 680437 021551

Oem No : 4571320905  
Wabco No : 8959051884

**RK.01.900** Crankshaft Repair Kit



8 680437 109327

Wabco No : 9125109282

**01.257** Bushing



8 680437 020233

Wabco No : 9115532044

**01.957** Nut



M20X1.5 Left Hand



8 680437 028871

Wabco No : 0029906650

## Twin Cylinder Compressor Ø85 mm - 636 CC - Stroke 56 mm

Application - Vehicle  
MERCEDES AXOR

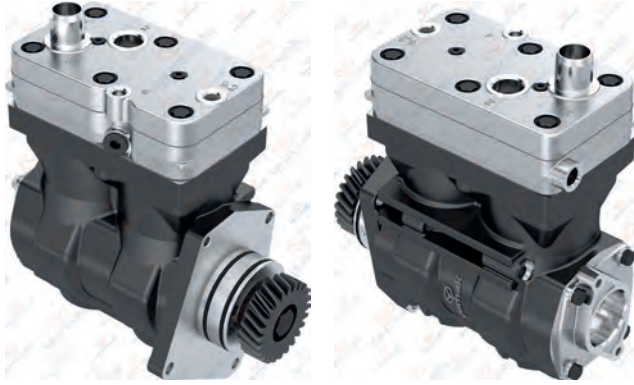

**01.06.001**

Oem. No.  
4571300415

Wabco No.  
9115530010  
9115530000



**01.271** Crankcase



**RK.01.105** Repair Kit



**RK.01.164** Complete Cylinder Head



Wabco No: 9115539202

**RK.01.100.01** Repair Kit



**RK.01.100** Repair Kit

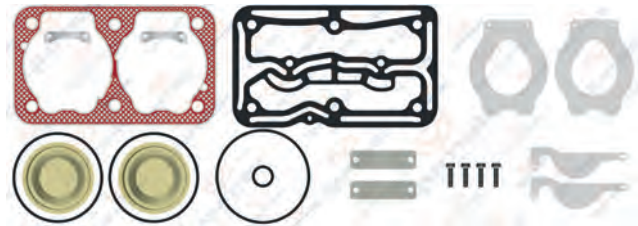

**RK.01.100.04** Repair Kit

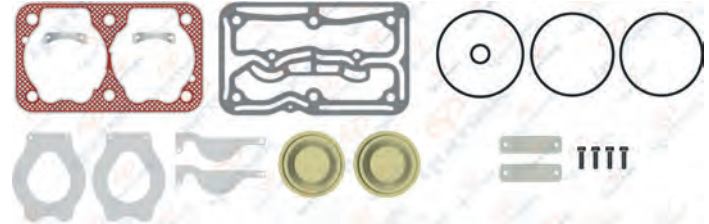

Use for old version cylinder repair kit. Yıpranmış kapaklar için.

**RK.01.100.03** Repair Kit



Wabco No: 9115530002

**RK.01.101** Repair Kit







# MERCEDES

## AIR COMPRESSOR AND REPAIR KIT

**01.270** Cylinder Head

8 680437 020370

**01.269** Valve Plate



8 680437 073086

**01.276** Crankshaft



M18x1.5 Right Hand



8 680437 020448

**01.273** Bushing



8 680437 020417

**01.286** Crankshaft Flange



Oem. No : 0001312932  
Wabco No : 4111476034



8 680437 020578

**01.272** Connecting Rod



8 680437 020400

**RK.01.104.00** Piston&Ring (Ø85,00 mm)

RK.01.104.10	85,25 mm
RK.01.104.20	85,50 mm
RK.01.104.30	85,75 mm
RK.01.104.40	86,00 mm



2,00x2,00x4,00



8 680437 060277

**01.142.00** Piston (Ø85,00 mm)

01.142.10	85,25 mm
01.142.20	85,50 mm
01.142.30	85,75 mm
01.142.40	86,00 mm



2,00x2,00x4,00



8 680437 018674

**01.373.00** Ring (Ø85,00 mm)

01.373.10	85,25 mm
01.373.20	85,50 mm
01.373.30	85,75 mm
01.373.40	86,00 mm



2,00x2,00x4,00

Oem No : 0011311111  
Wabco No : 9115019202



8 680437 075431

**01.028** Screw



M18x1.5 Right Hand



8 680437 010173

**01.302** Cap



8 680437 020769

**01.274** Gear





Ø79 - Z:25



8 680437 020424

**RK.01.556.02** Repair Kit

8 680437 121626

Empty section for additional parts.

Empty section for additional parts.

Empty section for additional parts.

## Single Cylinder Compressor Ø85 mm - 352 CC - Stroke 62 mm

Application - Vehicle  
MERCEDES ATEGO 815  
AXOR 3229-EURO4



**01.04.164**

Oem. No.	Wabco No.
9061304215	4111540040
9061302915	4111540050
9061301215	
9061304915	
9061305115	
9061306015	

**01.04.164.10**

Without gear



**01.388**

Crankcase



Wabco No: 4123520162

**RK.01.702.06**

Repair Kit



Wabco No: 4111519232

**RK.01.154.02**

Repair Kit



**RK.01.701**

Complete Cylinder Head



Wabco No: 4111540022

**RK.01.702.01**

Repair Kit



**RK.01.702.05**

Repair Kit



Wabco No: 4111540032

**RK.01.702**

Repair Kit

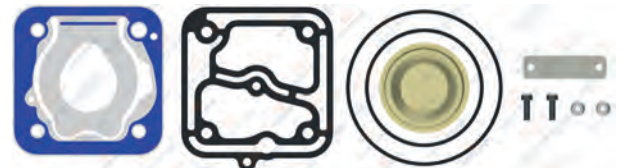

**RK.01.702.04**

Repair Kit



Use for old version cylinder repair kit. Yıpranmış kapaklar için.



# MERCEDES

## AIR COMPRESSOR AND REPAIR KIT

**01.1472** Cylinder Head



8 680437 080008

**01.1473** Valve Plate



8 680437 079804

**01.889** Crankshaft



M20X1.5 Left Hand

8 680437 028024

**RK.01.702.07** Repair Kit

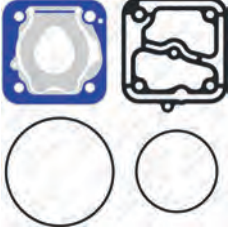

8 680437 122258

**01.286** Crankshaft Flange



Oem No : 0001312932  
Wabco No : 4111476034

8 680437 020578

**01.390** Connecting Rod



Oem No : 0001312517 - 0001312917  
Wabco No : 9111457382

8 680437 022015

**RK.01.104.00** Piston&Ring (Ø85,00 mm)

RK.01.104.10	85,25 mm
RK.01.104.20	85,50 mm
RK.01.104.30	85,75 mm
RK.01.104.40	86,00 mm



2,00x2,00x4,00

8 680437 060277

**01.142.00** Piston (Ø85,00 mm)

01.142.10	85,25 mm
01.142.20	85,50 mm
01.142.30	85,75 mm
01.142.40	86,00 mm



2,00x2,00x4,00

8 680437 018674

**01.373.00** Ring (Ø85,00 mm)

01.373.10	85,25 mm
01.373.20	85,50 mm
01.373.30	85,75 mm
01.373.40	86,00 mm



2,00x2,00x4,00

Oem No : 0011311111  
Wabco No : 9115019202

8 680437 075431

**RK.01.800** Connecting Rod & Piston



STD.

Wabco No : 9125109272 - 4123529252  
4123529292 - 9120007302

8 680437 078302

**RK.01.910** Crankshaft Repair Kit



Oem No : 4111549202

8 680437 109297

**01.263** Gear



Oem No : 9061320305  
Wabco No : 8959051694

8 680437 020295

**RK.01.702.02** Repair Kit



8 680437 076483

**01.1269** Bushing



39X35X23

Oem No : 0001314450  
Wabco No : 4111513404

8 680437 079798

**01.957** Nut



M20X1.5 Left Hand

Wabco No : 0029906650

8 680437 028871

## Single Cylinder Compressor Ø85 mm - 352 CC - Stroke 62 mm

**Application - Vehicle**  
MERCEDES ATEGO - AXOR 906  
OM 924 LA, 926 LA, 904 LA



**01.06.040**

Oem. No.	Wabco No.
9061303015	4123520250
9061304315	
9061301415	

**01.06.040.10**

Without gear



**01.388**

Crankcase



Wabco No: 4123520162

**RK.01.174.24**

Repair Kit



**RK.01.201**

Repair Kit



**RK.01.329**

Complete Cylinder Head



Oem. No : 0001315419  
Wabco No : 4123528012

**RK.01.174.01**

Repair Kit

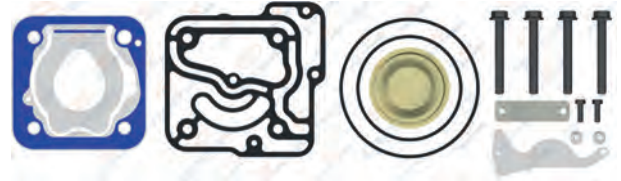

**RK.01.174**

Repair Kit

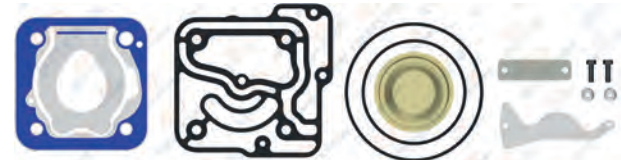

Oem. No : 0001307415  
Wabco : 4123520002-4123520062

**RK.01.174.04**

Repair Kit



Use for old version cylinder repair kit. Yıpranmış kapaklar için.

**RK.01.180**

Repair Kit





# MERCEDES

## AIR COMPRESSOR AND REPAIR KIT

**01.983** Cylinder Head



8 680437 029281

**01.984** Valve Plate



8 680437 029298

**01.889** Crankshaft



M20X1.5 Left Hand

8 680437 028024

**RK.01.800** Connecting Rod & Piston



STD.

8 680437 078302

Wabco No : 9125109272 - 4123529252  
4123529292 - 9120007302

**01.286** Crankshaft Flange



8 680437 020578

Oem. No : 0001312932  
Wabco No : 4111476034

**01.390** Connecting Rod



8 680437 022015

Oem. No : 0001312517 - 0001312917  
Wabco No : 9111457382

**RK.01.104.00** Piston&Ring (Ø85,00 mm)

RK.01.104.10	85,25 mm
RK.01.104.20	85,50 mm
RK.01.104.30	85,75 mm
RK.01.104.40	86,00 mm



2,00x2,00x4,00

8 680437 060277

**01.142.00** Piston (Ø85,00 mm)

01.142.10	85,25 mm
01.142.20	85,50 mm
01.142.30	85,75 mm
01.142.40	86,00 mm



2,00x2,00x4,00

8 680437 018674

**01.373.00** Ring (Ø85,00 mm)

01.373.10	85,25 mm
01.373.20	85,50 mm
01.373.30	85,75 mm
01.373.40	86,00 mm



2,00x2,00x4,00

8 680437 075431

Oem No : 0011311111  
Wabco No : 9115019202

**01.018** Bushing



39X35X25

8 680437 077220

**01.302** Cap



8 680437 020769

**01.263** Gear



8 680437 020295

Oem No : 9061320305  
Wabco No : 8959051694

**01.957** Nut



M20X1.5 Left Hand

8 680437 028871

Wabco No : 0029906650

## Single Cylinder Compressor Ø85 mm - 352 CC - Stroke 62 mm

**Application - Vehicle**  
MERCEDES ATEGO - AXOR 906  
OM 924 LA, 926 LA, 904 LA



**01.06.014**

**Oem. No.**  
9061301315

**Wabco No.**  
4123520010  
4123520020



**01.388**

**Crankcase**



**Wabco No:** 4123520162

**RK.01.174.24**

**Repair Kit**



**RK.01.201**

**Repair Kit**



**RK.01.329**

**Complete Cylinder Head**



**Oem. No :** 0001315419  
**Wabco No :** 4123528012

**RK.01.174.01**

**Repair Kit**



**RK.01.174**

**Repair Kit**

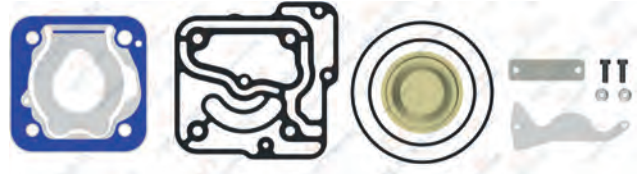

**Oem. No :** 0001307415  
**Wabco :** 4123520002-4123520062

**RK.01.174.04**

**Repair Kit**

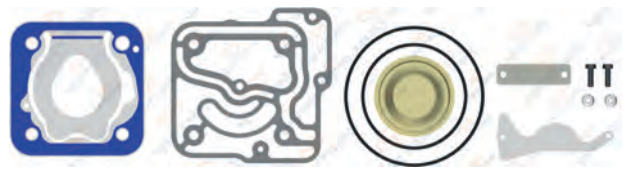

Use for old version cylinder repair kit. Yıpranmış kapaklar için.

**RK.01.180**

**Repair Kit**





# MERCEDES

## AIR COMPRESSOR AND REPAIR KIT

**01.983** Cylinder Head



8 680437 029281

**01.984** Valve Plate



8 680437 029298

**01.387** Crankshaft



M20X1.5 Right Hand

8 680437 021988

**RK.01.800** Connecting Rod & Piston



STD.

Wabco No : 9125109272 - 4123529252  
4123529292 - 9120007302

8 680437 078302

**01.286** Crankshaft Flange



Oem. No : 0001312932  
Wabco No : 4111476034

8 680437 020578

**01.390** Connecting Rod



Oem. No : 0001312517 - 0001312917  
Wabco No : 9111457382

8 680437 022015

**RK.01.104.00** Piston&Ring (Ø85,00 mm)

RK.01.104.10	85,25 mm
RK.01.104.20	85,50 mm
RK.01.104.30	85,75 mm
RK.01.104.40	86,00 mm



2,00x2,00x4,00

8 680437 060277

**01.142.00** Piston (Ø85,00 mm)

01.142.10	85,25 mm
01.142.20	85,50 mm
01.142.30	85,75 mm
01.142.40	86,00 mm



2,00x2,00x4,00

8 680437 018674

**01.373.00** Ring (Ø85,00 mm)

01.373.10	85,25 mm
01.373.20	85,50 mm
01.373.30	85,75 mm
01.373.40	86,00 mm



2,00x2,00x4,00

Oem No : 0011311111  
Wabco No : 9115019202

8 680437 075431

**01.018** Bushing



39X35X25

8 680437 077220

**01.302** Cap



8 680437 020769

**01.263** Gear



Oem No : 9061320305  
Wabco No : 8959051694

8 680437 020295

**01.144** Nut



M20X1.5 Right Hand

8 680437 018742

## Single Cylinder Compressor Ø85 mm - 352 CC - Stroke 62 mm

Application - Vehicle  
MERCEDES ATEGO 815 - AXOR 3229



**01.04.030**

Oem. No.	Wabco No.
9061304215	4111540000
9061302915	4111510030
9061301215	4111540030
9061301115	

**01.04.030.10**

Without gear



**01.388**

Crankcase



Wabco No: 4123520162

**RK.01.702.02**

Repair Kit



**RK.01.155** Complete Cylinder Head



Oem. No: 0001315119 - 0001315319  
Wabco No: 4111548002 - 4111518032

**RK.01.154.01**

Repair Kit



Wabco No: 4111519252

**RK.01.154**

Repair Kit



**RK.01.154.04**

Repair Kit



Use for old version cylinder repair kit. Yıpranmış kapaklar için.

**RK.01.154.21**

Repair Kit



Oem. No: 0001306815  
Wabco No: 4111540002

**RK.01.154.02**

Repair Kit





# MERCEDES

## AIR COMPRESSOR AND REPAIR KIT

**01.391** Cylinder Head



8 680437 022053

**01.392** Valve Plate



8 680437 022077

**01.889** Crankshaft



M20X1.5 Left Hand



8 680437 028024

**01.018** Bushing



39X35X25



8 680437 077220

**01.286** Crankshaft Flange



8 680437 020578

Oem. No : 0001312932  
Wabco No : 4111476034

**01.390** Connecting Rod



8 680437 022015

Oem. No : 0001312517 - 0001312917  
Wabco No : 9111457382

**RK.01.104.00** Piston&Ring (Ø85,00 mm)

- RK.01.104.10 85,25 mm
- RK.01.104.20 85,50 mm
- RK.01.104.30 85,75 mm
- RK.01.104.40 86,00 mm



2,00x2,00x4,00



8 680437 060277

**01.142.00** Piston (Ø85,00 mm)

- 01.142.10 85,25 mm
- 01.142.20 85,50 mm
- 01.142.30 85,75 mm
- 01.142.40 86,00 mm



2,00x2,00x4,00



8 680437 018674

**01.373.00** Ring (Ø85,00 mm)

- 01.373.10 85,25 mm
- 01.373.20 85,50 mm
- 01.373.30 85,75 mm
- 01.373.40 86,00 mm



2,00x2,00x4,00



8 680437 075431

Oem No : 0011311111  
Wabco No : 9115019202

**01.957** Nut



M20X1.5 Left Hand



8 680437 028871

Oem No : 0029906650

**01.302** Cap



8 680437 020769

**01.263** Gear



8 680437 020295

Oem No : 9061320305  
Wabco No : 8959051694

## Single Cylinder Compressor Ø92 mm-359 CC-Stroke 54 mm

Application - Vehicle  
MERCEDES ATEGO - AXOR

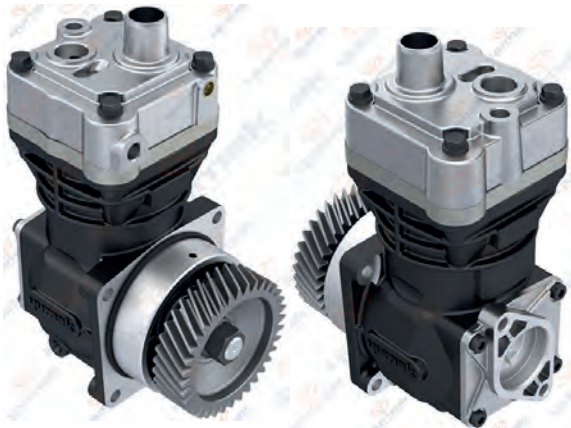

**01.04.189**

Knorr No.  
LK3964  
K013812R  
II35563  
II35563M5



**01.1789**

Crankcase



**RK.01.872**

Complete Cylinder Head



**RK.01.645.02**

Valve Plate Kit

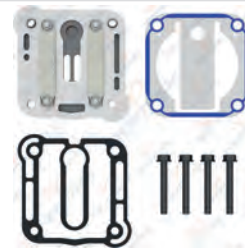

Knorr No : SEB01968K50

**RK.01.395.01**

Repair Kit

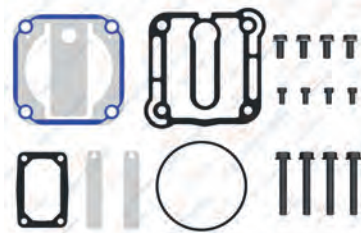

**RK.01.395.03**

Repair Kit

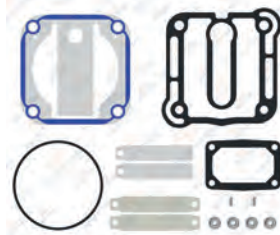

**RK.01.395.06**

Repair Kit

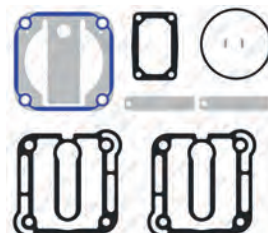

Knorr No : SEB22532



# MERCEDES

## AIR COMPRESSOR AND REPAIR KIT

01.1923

Cylinder Head



01.186

Valve Plate



OEM No : 51541246003

01.1790

Crankshaft



RK.01.802

Connecting Rod & Piston



STD.



01.1070.10

Crankshaft Flange



01.1101

Connecting Rod



RK.01.318.00

Piston&Ring (Ø92,00 mm)

- RK.01.318.10 92,25 mm
- RK.01.318.20 92,50 mm
- RK.01.318.30 92,75 mm
- RK.01.318.40 93,00 mm



2,50x2,50x4,00

Knorr No : K006026



01.862.00

Piston (Ø92,00 mm)

- 01.862.10 92,25 mm
- 01.862.20 92,50 mm
- 01.862.30 92,75 mm
- 01.862.40 93,00 mm



2,50x2,50x4,00



01.942.00

Ring (Ø92,00 mm)

- 01.942.10 92,25 mm
- 01.942.20 92,50 mm
- 01.942.30 92,75 mm
- 01.942.40 93,00 mm



2,50x2,50x4,00



# Single Cylinder Compressor Ø85 mm - 318 CC - Stroke 56 mm

Application - Vehicle  
MERCEDES AXOR OM906



**01.04.018**

Oem. No.  
9061300615

Wabco No.  
4111530000  
4111510000

**01.04.018.10**

Without gear



**01.256** Crankcase



Wabco No: 4111510102

**RK.01.190** Repair Kit



**RK.01.099** Complete Cylinder Head



Oem. No : 0001314919  
Wabco No : 4111518002 - 4111518012

**RK.01.106.01** Repair Kit

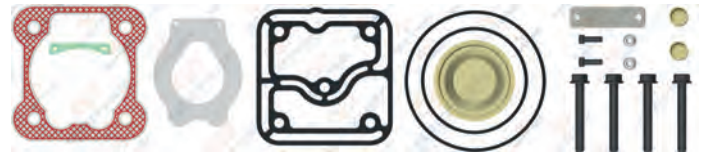

**RK.01.106** Repair Kit



Wabco No: 4111519212

**RK.01.106.04** Repair Kit



**RK.01.106.24** Repair Kit



**RK.01.106.07** Repair Kit





# MERCEDES

## AIR COMPRESSOR AND REPAIR KIT

**01.376** Cylinder Head



**Oem No** : 0001312221  
**Wabco No** : 4111516544

**01.375** Valve Plate



**Oem No** : 0001310809 - 0001310909  
**Wabco No** : 4111516522

**01.261** Crankshaft



M20X1.5 Right Hand

**Oem No** : 0001310809 - 0001310909  
**Wabco No** : 4111516522

**01.018** Bushing



39X35X25

**Oem No** : 0001312221  
**Wabco No** : 4111516544

**01.286** Crankshaft Flange



**Oem No** : 0001312932  
**Wabco No** : 4111476034

**01.272** Connecting Rod



**Oem No** : 0001312932  
**Wabco No** : 4111476034

**RK.01.104.00** Piston&Ring (Ø85,00 mm)

- RK.01.104.10 85,25 mm
- RK.01.104.20 85,50 mm
- RK.01.104.30 85,75 mm
- RK.01.104.40 86,00 mm



2,00x2,00x4,00

**Oem No** : 0001312221  
**Wabco No** : 4111516544

**01.142.00** Piston (Ø85,00 mm)

- 01.142.10 85,25 mm
- 01.142.20 85,50 mm
- 01.142.30 85,75 mm
- 01.142.40 86,00 mm



2,00x2,00x4,00

**Oem No** : 0001312221  
**Wabco No** : 4111516544

**01.373.00** Ring (Ø85,00 mm)

- 01.373.10 85,25 mm
- 01.373.20 85,50 mm
- 01.373.30 85,75 mm
- 01.373.40 86,00 mm



2,00x2,00x4,00

**Oem No** : 0011311111  
**Wabco No** : 9115019202

**01.263** Gear



**Oem No** : 9061320305  
**Wabco No** : 8959051694

**01.144** Nut



M20X1.5 Right Hand

**Oem No** : 0001312221  
**Wabco No** : 4111516544

**01.335** Pressure Valve



**Oem No** : 0001312221  
**Wabco No** : 4111516544

## Twin Cylinder Compressor Ø85 mm - 636 CC - Stroke 56 mm

### Application - Vehicle

MERCEDES AXOR EVO / TOURINO / CITARO  
INTOURO / OM 906 LA / OM 906 HLA / OM 926 LA

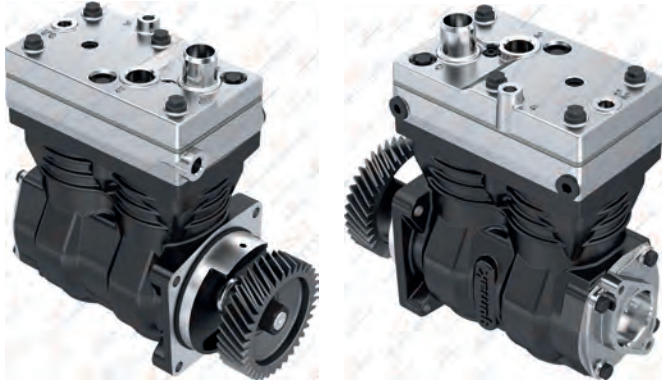

### 01.06.043

#### Oem. No.

9061301615  
9061302515  
9061306315

#### Wabco No.

9125100010

### 01.06.043.10

Without gear



### 01.855

#### Crankcase



### RK.01.512

#### Repair Kit



### RK.01.467

#### Complete Cylinder Head



Wabco No: 9125109222

### RK.01.468.05

#### Repair Kit

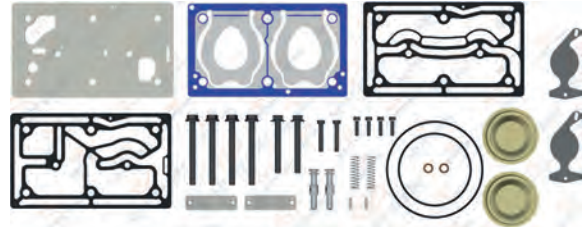

### RK.01.468

#### Repair Kit

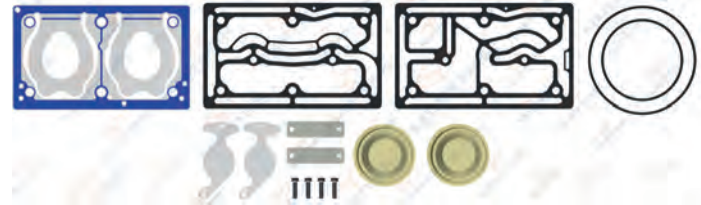

### RK.01.468.04

#### Repair Kit

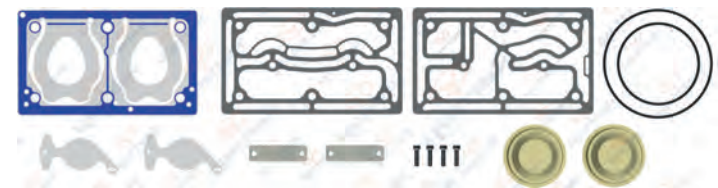

Use for old version cylinder repair kit. Yıpranmış kapaklar için.

### RK.01.418

#### Repair Kit



### RK.01.468.02

#### Repair Kit

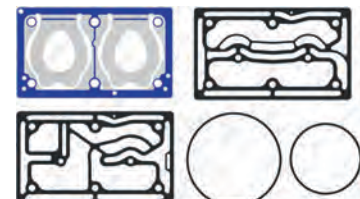



# MERCEDES

## AIR COMPRESSOR AND REPAIR KIT

**01.853** Cylinder Head



8 680437 027485

**01.875.14** Valve Plate



8 680437 079477

**01.837** Crankshaft



M20X1.5 Left Hand

8 680437 027331

**01.851** Cooling Plate



8 680437 027461

**01.286** Crankshaft Flange



Oem No : 0001312932  
Wabco No : 4111476034

8 680437 020578

**01.272** Connecting Rod



8 680437 020400

**RK.01.104.00** Piston&Ring (Ø85,00 mm)

RK.01.104.10	85,25 mm
RK.01.104.20	85,50 mm
RK.01.104.30	85,75 mm
RK.01.104.40	86,00 mm



2,00x2,00x4,00

8 680437 060277

**01.142.00** Piston (Ø85,00 mm)

01.142.10	85,25 mm
01.142.20	85,50 mm
01.142.30	85,75 mm
01.142.40	86,00 mm



2,00x2,00x4,00

8 680437 018674

**01.373.00** Ring (Ø85,00 mm)

01.373.10	85,25 mm
01.373.20	85,50 mm
01.373.30	85,75 mm
01.373.40	86,00 mm



2,00x2,00x4,00

Oem No : 0011311111  
Wabco No : 9115019202

8 680437 075431

**RK.01.901** Crankshaft Repair Kit



Wabco No : 4115539242

8 680437 109303

**RK.01.803** Connecting Rod & Piston



STD.

8 680437 114567

**01.263** Gear



Oem No : 9061320305  
Wabco No : 8959051694

8 680437 020295

**RK.01.468.03** Repair Kit

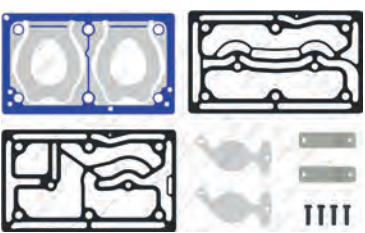

8 680437 122104

**01.1269** Bushing



39X35X23

Oem No : 0001314450  
Wabco No : 4111513404

8 680437 079798

**01.957** Nut



M20X1.5 Left Hand

Oem No : 0029906650

8 680437 028871

## Twin Cylinder Compressor Ø85 mm - 636 CC - Stroke 56 mm

### Application - Vehicle

MERCEDES AXOR EVO / TOURINO / CITARO  
INTOURO / OM 906 LA / OM 906 HLA / OM 926 LA

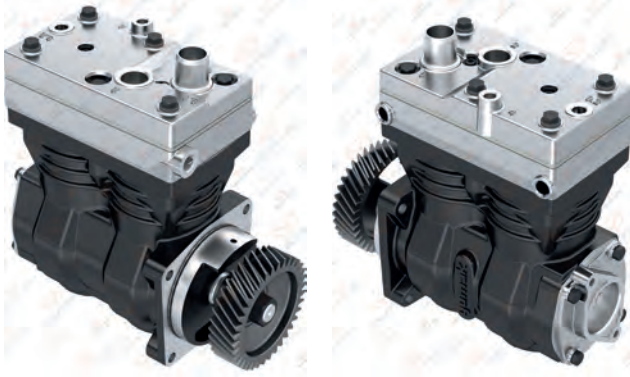

### 01.06.084

Oem. No.	Wabco No.
9061306415	9125100030
9061306715	9125100050
9061306815	

### 01.06.084.10

Wabco No.
9125100051

Without gear



### 01.855

### Crankcase



### RK.01.468.02

### Repair Kit

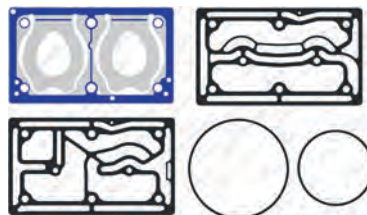

### RK.01.418.01

### Repair Kit

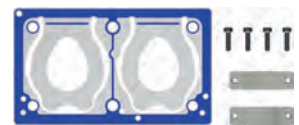

### RK.01.589

### Complete Cylinder Head



Wabco No: 9125109342

### RK.01.468.11

### Repair Kit

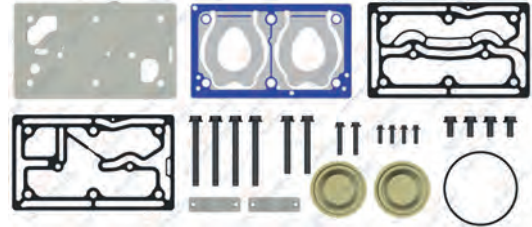

### RK.01.468.10

### Repair Kit

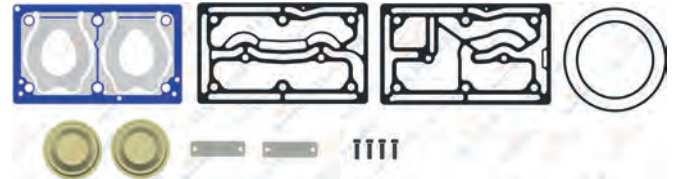

### RK.01.468.14

### Repair Kit

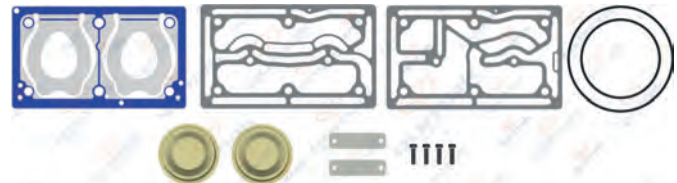

Use for old version cylinder repair kit. Yıpranmış kapaklar için.

### RK.01.468.06

### Repair Kit

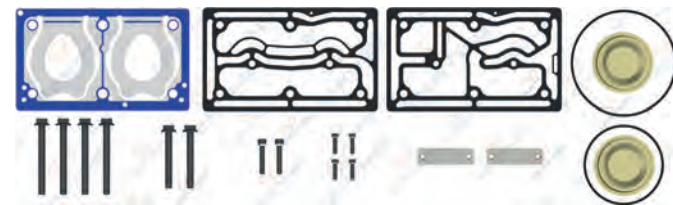

Wabco No: 9125109352



# MERCEDES

## AIR COMPRESSOR AND REPAIR KIT

**01.853** Cylinder Head



8 680437 027485

**01.1489.10** Valve Plate



8 680437 101178

**01.837** Crankshaft



M20X1.5 Left Hand



8 680437 027331

**01.851** Cooling Plate



8 680437 027461

**01.286** Crankshaft Flange



8 680437 020578

Oem No : 0001312932  
Wabco No : 4111476034

**01.272** Connecting Rod



8 680437 020400

**RK.01.104.00** Piston&Ring (Ø85,00 mm)

- RK.01.104.10 85,25 mm
- RK.01.104.20 85,50 mm
- RK.01.104.30 85,75 mm
- RK.01.104.40 86,00 mm



2,00x2,00x4,00



8 680437 060277

**01.142.00** Piston (Ø85,00 mm)

- 01.142.10 85,25 mm
- 01.142.20 85,50 mm
- 01.142.30 85,75 mm
- 01.142.40 86,00 mm



2,00x2,00x4,00



8 680437 018674

**01.373.00** Ring (Ø85,00 mm)

- 01.373.10 85,25 mm
- 01.373.20 85,50 mm
- 01.373.30 85,75 mm
- 01.373.40 86,00 mm



2,00x2,00x4,00



8 680437 075431

Oem No : 0011311111  
Wabco No : 9115019202

**01.1269** Bushing



39X35X23



8 680437 079798

Oem No : 0001314450  
Wabco No : 4111513404

**01.957** Nut



M20X1.5 Left Hand



8 680437 028871

Oem No : 0029906650

**01.263** Gear



8 680437 020295

Oem No : 9061320305  
Wabco No : 8959051694

**RK.01.901** Crankshaft Repair Kit



8 680437 109303

Wabco No : 4115539242

**RK.01.803** Connecting Rod & Piston



STD.



8 680437 114567

**01.302** Cap



8 680437 020769

## Twin Cylinder Compressor Ø85 mm - 636 CC - Stroke 56 mm

Application - Vehicle  
MERCEDES ATEGO / EVOBUS



**01.06.046**

Oem. No.  
9061301015  
9061302315

Wabco No.  
4115530000



**01.1023.10** Crankcase



**RK.01.556.03** Repair Kit

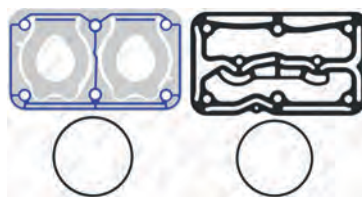

**RK.01.202** Complete Cylinder Head

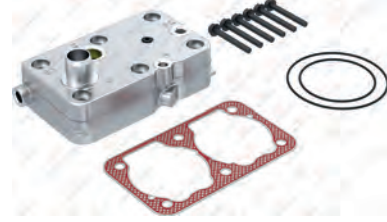

Oem. No: 0001315219  
Wabco No: 4115539202

**RK.01.556.01** Repair Kit

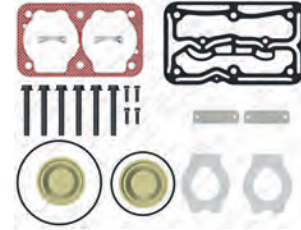

**RK.01.556** Repair Kit

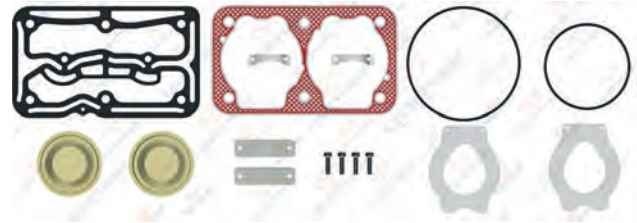

**RK.01.556.04** Repair Kit



Use for old version cylinder repair kit. Yıpranmış kapaklar için.

**RK.01.556.22** Repair Kit

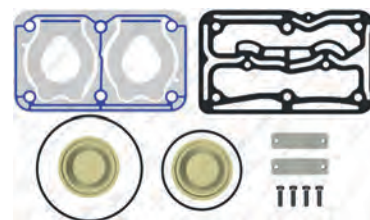

**RK.01.557** Repair Kit





# MERCEDES

## AIR COMPRESSOR AND REPAIR KIT

**01.270** Cylinder Head



8 680437 020370

**01.681** Valve Plate



8 680437 073581

**01.837** Crankshaft



M20X1.5 Left Hand



8 680437 027331

**01.263** Gear



8 680437 020295

Oem No : 9061320305  
Wabco No : 8959051694

**01.286** Crankshaft Flange



8 680437 020578

Oem. No : 0001312932  
Wabco No : 4111476034

**01.272** Connecting Rod



8 680437 020400

**RK.01.104.00** Piston&Ring (Ø85,00 mm)

- RK.01.104.10 85,25 mm
- RK.01.104.20 85,50 mm
- RK.01.104.30 85,75 mm
- RK.01.104.40 86,00 mm



2,00x2,00x4,00



8 680437 060277

**01.142.00** Piston (Ø85,00 mm)

- 01.142.10 85,25 mm
- 01.142.20 85,50 mm
- 01.142.30 85,75 mm
- 01.142.40 86,00 mm



2,00x2,00x4,00



8 680437 018674

**01.373.00** Ring (Ø85,00 mm)

- 01.373.10 85,25 mm
- 01.373.20 85,50 mm
- 01.373.30 85,75 mm
- 01.373.40 86,00 mm



2,00x2,00x4,00



8 680437 075431

Oem No : 0011311111  
Wabco No : 9115019202

**RK.01.901** Crankshaft Repair Kit



8 680437 109303

Wabco No : 4115539242

**RK.01.803** Connecting Rod & Piston



STD.



8 680437 114567

**01.957** Nut



M20X1.5 Left Hand



8 680437 028871

Oem No : 0029906650

**RK.01.556.23** Repair Kit

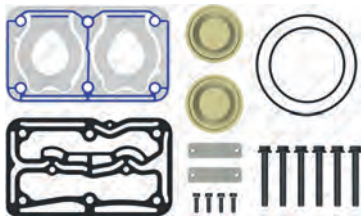

8 680437 121954

**01.302** Cap



8 680437 020769

**01.1269** Bushing



39X35X23



8 680437 079798

Oem No : 0001314450  
Wabco No : 411513404

## Twin Cylinder Compressor Ø85 mm - 636 CC - Stroke 56 mm

Application - Vehicle  
ECONIC 2628 / M 906 / CITARO 12M



**01.06.048**

Oem. No.	Wabco No.
9061304715	4115530030
9061301515	4115530040
9061303315	
9061302415	



**01.1023** Crankcase



**RK.01.442** Repair Kit



**RK.01.330** Complete Cylinder Head

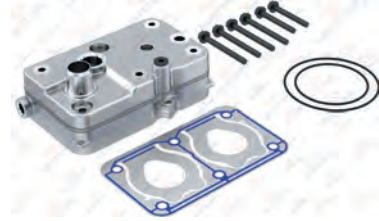

Oem. No: 0011303015  
Wabco No: 4115539212

**RK.01.555.05** Repair Kit

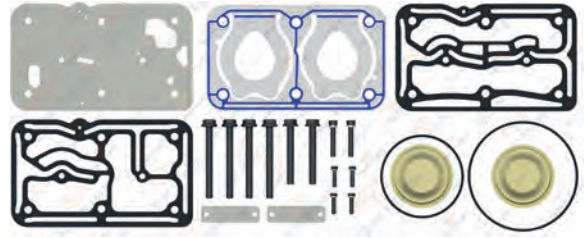

**RK.01.555.01** Repair Kit

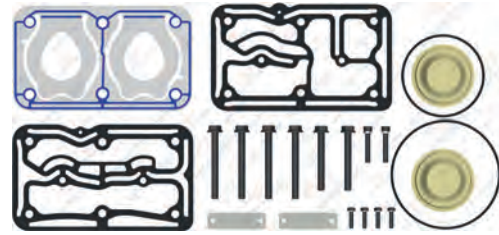

Wabco No: 4115539232

**RK.01.555** Repair Kit

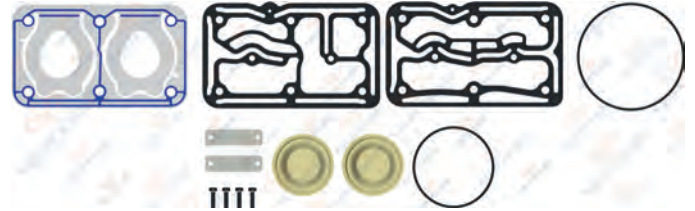

**RK.01.555.04** Repair Kit

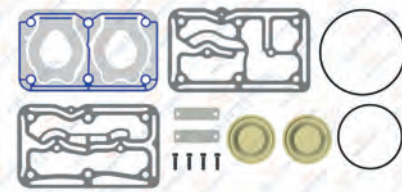

Use for old version cylinder repair kit. Yıpranmış kapaklar için.

**RK.01.555.02** Repair Kit

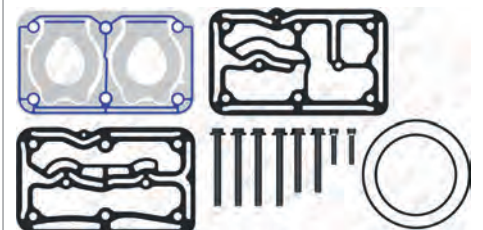

Oem No : 0011303515  
Wabco No : 4126369212



# MERCEDES

## AIR COMPRESSOR AND REPAIR KIT

**01.867** Cylinder Head



8 680437 027652

**01.1110** Valve Plate



8 680437 016205

**01.837** Crankshaft



M20X1.5 Left Hand

8 680437 027331

**01.958** Cooling Plate



8 680437 028888

**01.286** Crankshaft Flange



Oem No : 0001312932  
Wabco No : 4111476034

8 680437 020578

**01.272** Connecting Rod



8 680437 020400

**RK.01.104.00** Piston&Ring (Ø85,00 mm)

RK.01.104.10	85,25 mm
RK.01.104.20	85,50 mm
RK.01.104.30	85,75 mm
RK.01.104.40	86,00 mm



2,00x2,00x4,00

8 680437 060277

**01.142.00** Piston (Ø85,00 mm)

01.142.10	85,25 mm
01.142.20	85,50 mm
01.142.30	85,75 mm
01.142.40	86,00 mm



2,00x2,00x4,00

8 680437 018674

**01.373.00** Ring (Ø85,00 mm)

01.373.10	85,25 mm
01.373.20	85,50 mm
01.373.30	85,75 mm
01.373.40	86,00 mm

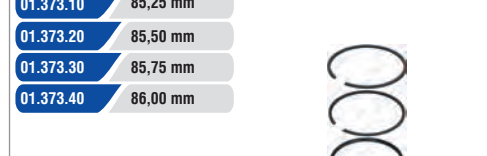

2,00x2,00x4,00

Oem No : 0011311111  
Wabco No : 9115019202

8 680437 075431

**RK.01.901** Crankshaft Repair Kit



Wabco No : 4115539242

8 680437 109303

**RK.01.803** Connecting Rod & Piston



STD.

8 680437 114567

**01.263** Gear



Oem No : 9061320305  
Wabco No : 8959051694

8 680437 020295

**RK.01.555.03** Repair Kit

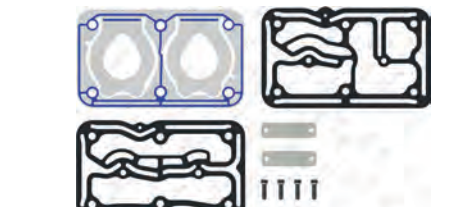

8 680437 121985

**01.1269** Bushing



39X35X23

Oem No : 0001314450  
Wabco No : 4111513404

8 680437 079798

**01.957** Nut



M20X1.5 Left Hand

Oem No : 0029906650

8 680437 028871

## Twin Cylinder Compressor Ø85 mm - 636 CC - Stroke 56 mm

**Application - Vehicle**  
EVOBUS Citaro (O530 G) Articulated Bus  
EVOBUS Citaro (O530 L) 6 x 2 Bus



### 01.06.013

Oem. No.	Wabco No.
9061304515	4126360000
9061303215	4126360030
9061300915	
9061302215	



### 01.1023.10 Crankcase



### RK.01.105 Repair Kit



### RK.01.164.01 Complete Cylinder Head

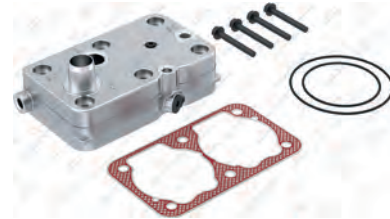

### RK.01.100.11 Repair Kit

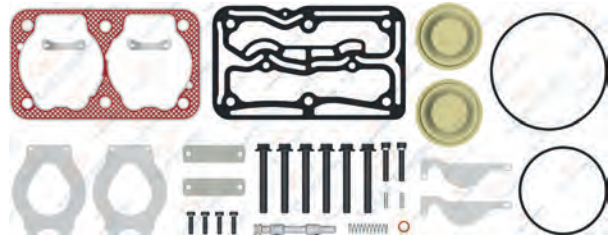

### RK.01.100.10 Repair Kit

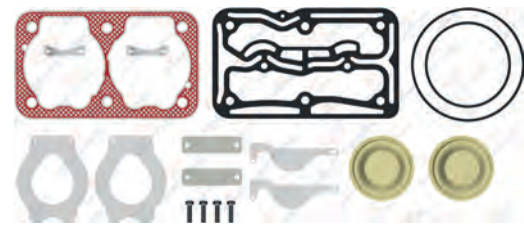

### RK.01.100.14 Repair Kit

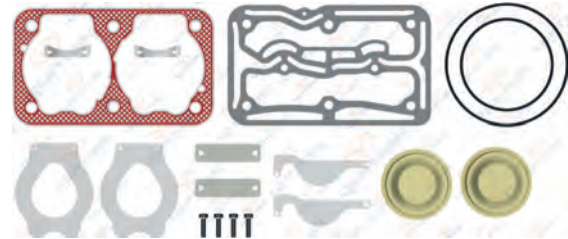

### RK.01.556.02 Repair Kit



### 01.335 Pressure Valve





# MERCEDES

## AIR COMPRESSOR AND REPAIR KIT

**01.270** Cylinder Head



8 680437 020370

**01.1109** Valve Plate



8 680437 016144

**01.837** Crankshaft



M20X1.5 Left Hand

8 680437 027331

**RK.01.101** Cooling Plate



8 680437 060246

**01.286** Crankshaft Flange



Oem No : 0001312932  
Wabco No : 4111476034

8 680437 020578

**01.272** Connecting Rod



8 680437 020400

**RK.01.104.00** Piston&Ring (Ø85,00 mm)

RK.01.104.10	85,25 mm
RK.01.104.20	85,50 mm
RK.01.104.30	85,75 mm
RK.01.104.40	86,00 mm



2,00x2,00x4,00

8 680437 060277

**01.142.00** Piston (Ø85,00 mm)

01.142.10	85,25 mm
01.142.20	85,50 mm
01.142.30	85,75 mm
01.142.40	86,00 mm



2,00x2,00x4,00

8 680437 018674

**01.373.00** Ring (Ø85,00 mm)

01.373.10	85,25 mm
01.373.20	85,50 mm
01.373.30	85,75 mm
01.373.40	86,00 mm

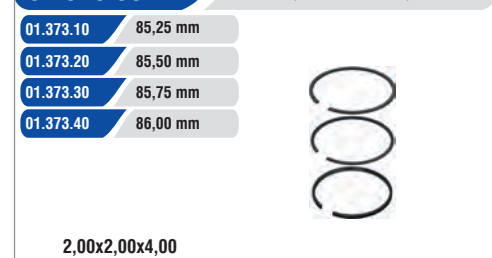

2,00x2,00x4,00

Oem No : 0011311111  
Wabco No : 9115019202

8 680437 075431

**RK.01.901** Crankshaft Repair Kit



Wabco No : 4115539242

8 680437 109303

**RK.01.803** Connecting Rod & Piston



STD.

8 680437 114567

**01.263** Gear



Oem No : 9061320305  
Wabco No : 8959051694

8 680437 020295

**01.302** Cap



8 680437 020769

**01.1269** Bushing



39X35X23

Oem No : 0001314450  
Wabco No : 4111513404

8 680437 079798

**01.957** Nut



M20X1.5 Left Hand

Oem No : 0029906650

8 680437 028871

## Twin Cylinder Compressor Ø85 mm - 636 CC - Stroke 56 mm

Application - Vehicle  
MERCEDES AXOR / EVOBUS  
CITARO - 0530G - 0530L



**01.06.044**

Oem. No.

Wabco No.  
4126360010



**01.1024**

Crankcase



**RK.01.101**

Repair Kit



**RK.01.296** Complete Cylinder Head

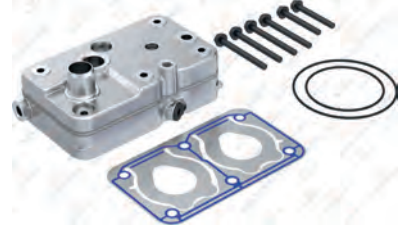

Oem No : 0011315619  
Wabco No : 4126369202

**RK.01.295.05**

Repair Kit

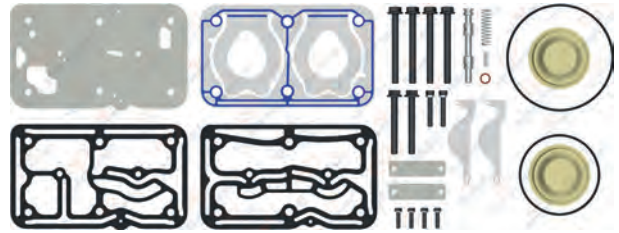

**RK.01.295.03**

Repair Kit

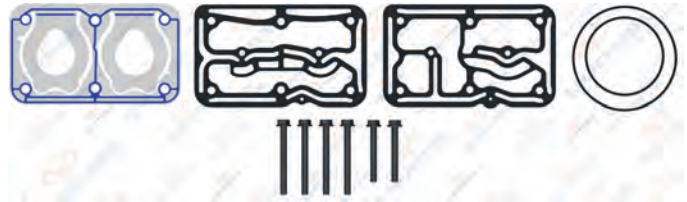

**RK.01.295**

Repair Kit

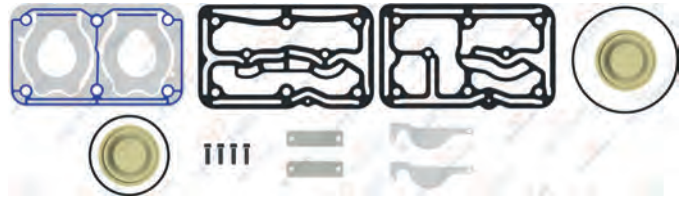

**RK.01.295.04**

Repair Kit

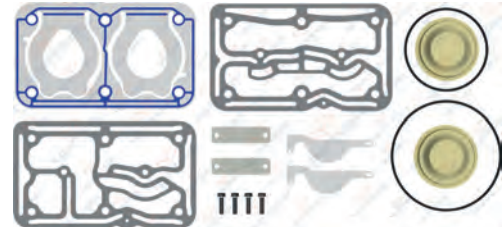

Use for old version cylinder repair kit. Yıpranmış kapaklar için.

**RK.01.181**

Repair Kit





# MERCEDES

## AIR COMPRESSOR AND REPAIR KIT

**01.867** Cylinder Head



8 680437 027652

**01.426.10** Valve Plate



8 680437 078548

**01.837** Crankshaft



M20X1.5 Left Hand

8 680437 027331

**01.958** Cooling Plate



8 680437 028888

**01.286** Crankshaft Flange



Oem No : 0001312932  
Wabco No : 4111476034

8 680437 020578

**01.272** Connecting Rod



8 680437 020400

**RK.01.104.00** Piston&Ring (Ø85,00 mm)

RK.01.104.10	85,25 mm
RK.01.104.20	85,50 mm
RK.01.104.30	85,75 mm
RK.01.104.40	86,00 mm



2,00x2,00x4,00

8 680437 060277

**01.142.00** Piston (Ø85,00 mm)

01.142.10	85,25 mm
01.142.20	85,50 mm
01.142.30	85,75 mm
01.142.40	86,00 mm



2,00x2,00x4,00

8 680437 018674

**01.373.00** Ring (Ø85,00 mm)

01.373.10	85,25 mm
01.373.20	85,50 mm
01.373.30	85,75 mm
01.373.40	86,00 mm



2,00x2,00x4,00

Oem No : 0011311111  
Wabco No : 9115019202

8 680437 075431

**RK.01.901** Crankshaft Repair Kit



Wabco No : 4115539242

8 680437 109303

**RK.01.803** Connecting Rod & Piston



STD.

8 680437 114567

**01.263** Gear



Oem No : 9061320305  
Wabco No : 8959051694

8 680437 020295

**RK.01.300** Repair Kit

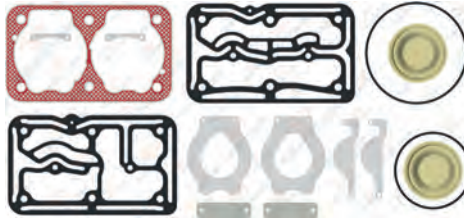

8 680437 063582

**01.1269** Bushing



39X35X23

Oem No : 0001314450  
Wabco No : 4111513404

8 680437 079798

**01.957** Nut



M20X1.5 Left Hand

Oem No : 0029906650

8 680437 028871

## Twin Cylinder Compressor Ø85 mm - 636 CC - Stroke 56 mm

Application - Vehicle  
MERCEDES ATEGO / AXOR 906 / CITARO 12M



**01.06.045**

Oem. No.  
9061301815

Wabco No.  
4115530020



**01.1024** Crankcase



**RK.01.442** Repair Kit



**RK.01.330** Complete Cylinder Head

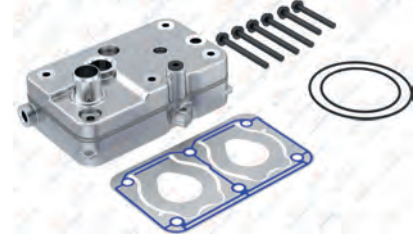

Oem No : 0011303015  
Wabco No : 4115539212

**RK.01.555.05** Repair Kit

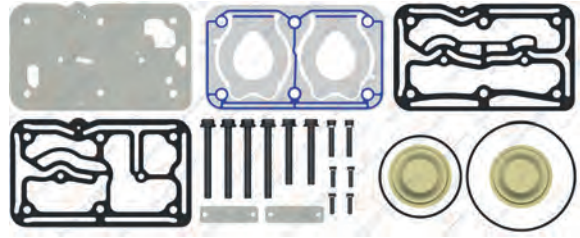

**RK.01.555.01** Repair Kit

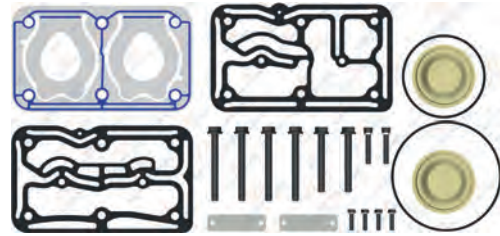

Wabco No : 4115539232

**RK.01.555** Repair Kit

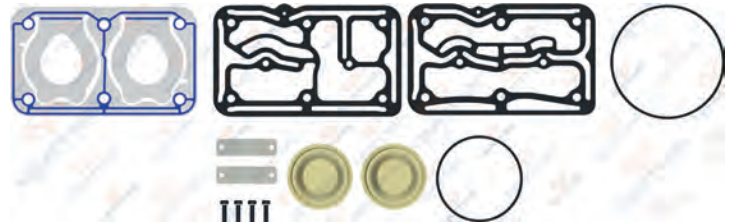

**RK.01.555.04** Repair Kit

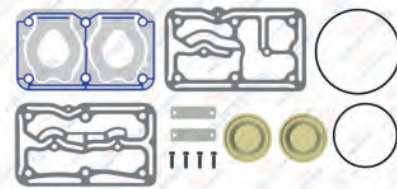

Use for old version cylinder repair kit. Yıpranmış kapaklar için.

**RK.01.555.02** Repair Kit

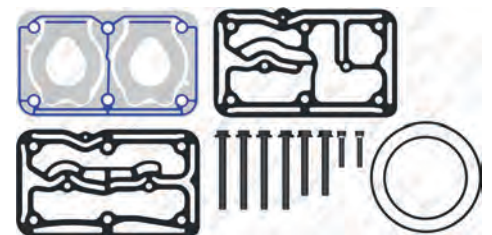

Oem No : 0011303515  
Wabco No : 4126369212



# MERCEDES

## AIR COMPRESSOR AND REPAIR KIT

**01.867** Cylinder Head



8 680437 027652

**01.1110** Valve Plate



8 680437 016205

**01.837** Crankshaft



M20X1.5 Left Hand



8 680437 027531

**01.958** Cooling Plate



8 680437 028888

**01.286** Crankshaft Flange



8 680437 020578

Oem No : 0001312932  
Wabco No : 4111476034

**01.272** Connecting Rod



8 680437 020400

**RK.01.104.00** Piston&Ring (Ø85,00 mm)

- RK.01.104.10 85,25 mm
- RK.01.104.20 85,50 mm
- RK.01.104.30 85,75 mm
- RK.01.104.40 86,00 mm



2,00x2,00x4,00



8 680437 060277

**01.142.00** Piston (Ø85,00 mm)

- 01.142.10 85,25 mm
- 01.142.20 85,50 mm
- 01.142.30 85,75 mm
- 01.142.40 86,00 mm



2,00x2,00x4,00



8 680437 018674

**01.373.00** Ring (Ø85,00 mm)

- 01.373.10 85,25 mm
- 01.373.20 85,50 mm
- 01.373.30 85,75 mm
- 01.373.40 86,00 mm



2,00x2,00x4,00



8 680437 075431

Oem No : 0011311111  
Wabco No : 9115019202

**RK.01.901** Crankshaft Repair Kit



8 680437 109303

Wabco No : 4115539242

**RK.01.803** Connecting Rod & Piston



STD.



8 680437 114567

**01.263** Gear



8 680437 020295

Oem No : 9061320305  
Wabco No : 8959051694

**01.1269** Bushing



39X35X23



8 680437 079798

Oem No : 0001314450  
Wabco No : 4111513404

**01.302** Cap



8 680437 020769

**01.957** Nut



M20X1.5 Left Hand



8 680437 028871

Oem No : 0029906650

## Single Cylinder & Horizontal Ø100 mm - 596 CC - Stroke 38 mm

Application - Vehicle  
MERCEDES ACTROS  
OM501 - 502 - V6N - V8N



**01.01.004**

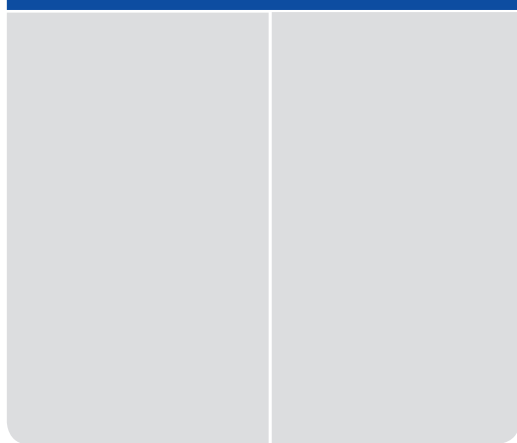

**RK.01.012** Repair Kit

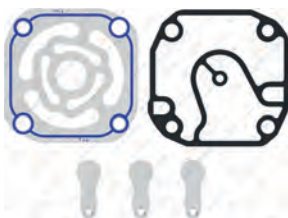

**RK.01.097.02** Repair Kit



**RK.01.097.06** Repair Kit



**RK.01.094**

Complete Cylinder Head



**01.244**

Cylinder Head



Oem No : 5411310919 -  
5411311219 - 5411311019

**RK.01.096**

Valve Plate Kit

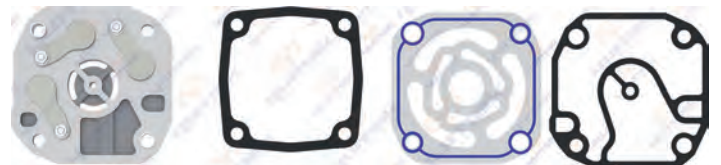

Oem No : 5411300620

**RK.01.096.20**

Valve Plate Kit

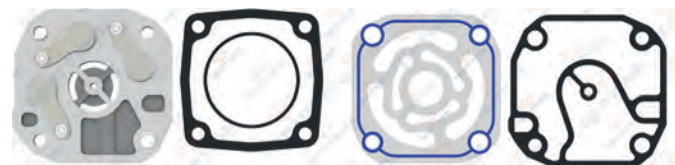

**RK.01.097**

Repair Kit





# MERCEDES

## AIR COMPRESSOR AND REPAIR KIT

**01.253** Valve Plate



**01.001** Connecting Rod



Oem No : 4421310217 - 5411310117

**01.091** Crankshaft



Oem No : 4421300314 - 5411300514

**RK.01.006.00** Piston&Ring (Ø100,00)

- RK.01.006.10 100,25 mm
- RK.01.006.20 100,50 mm
- RK.01.006.30 100,75 mm
- RK.01.006.40 101,00 mm



2,50x2,50x4,00



**01.107.00** Piston(Ø100,00mm)

- 01.107.10 100,25 mm
- 01.107.20 100,50 mm
- 01.107.30 100,75 mm
- 01.107.40 101,00 mm



2,50x2,50x4,00



**01.133.00** Ring (Ø100,00mm)

- 01.133.10 100,25 mm
- 01.133.20 100,50 mm
- 01.133.30 100,75 mm
- 01.133.40 101,00 mm



2,50x2,50x4,00



**RK.01.091.00** Piston&Ring(Ø100,00 mm)

- RK.01.091.10 100,25 mm
- RK.01.091.20 100,50 mm
- RK.01.091.30 100,75 mm
- RK.01.091.40 101,00 mm



2,50x2,50x3,00



**01.614.00** Piston (Ø100,00 mm)

- 01.614.10 100,25 mm
- 01.614.20 100,50 mm
- 01.614.30 100,75 mm
- 01.614.40 101,00 mm

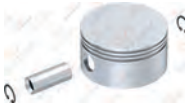

2,50x2,50x3,00



**01.104.00** Ring (Ø100,00 mm)

- 01.104.10 100,25 mm
- 01.104.20 100,50 mm
- 01.104.30 100,75 mm
- 01.104.40 101,00 mm



2,50x2,50x3,00



**RK.01.656** Cylinder Liner Set



Including RK.01.091



**RK.01.089** Cylinder Liner Set



Including RK.01.006.00



Oem No : 5411300008

**01.258** Cylinder Liner



## Twin Cyl Vertical & Horizontal Ø100 mm - 596 CC - Stroke 38 mm

Application - Vehicle  
MERCEDES ACTROS  
OM501 - 502 - V6N - V8N

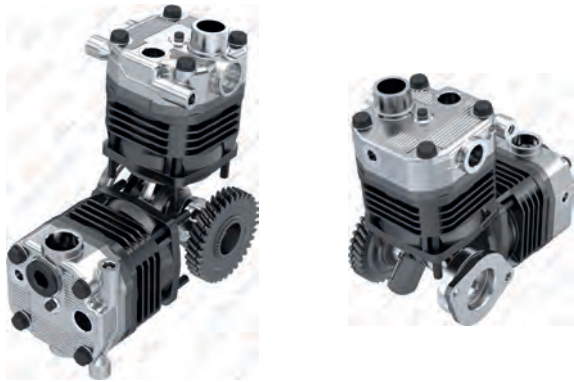

01.01.004.10

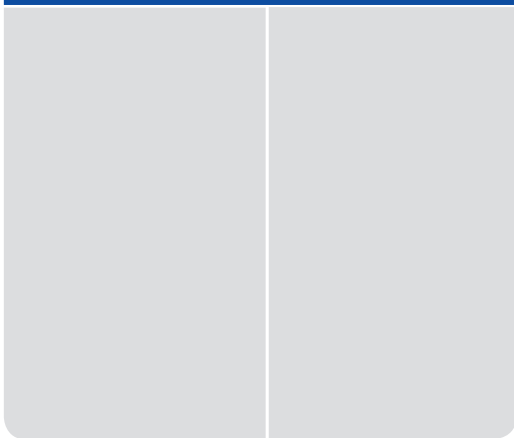

RK.01.096 Valve Plate Kit

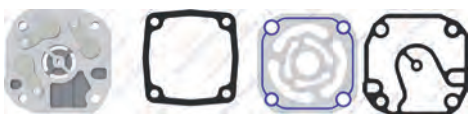

Oem No : 5411300620

RK.01.097.02 Repair Kit

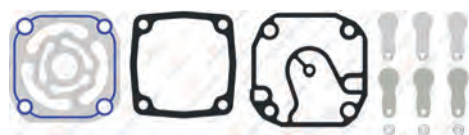

8 680437 078265

RK.01.097 Repair Kit



8 680437 060093

RK.01.094

Complete Cylinder Head



8 680437 060062

01.244

Cylinder Head



Oem No : 5411310919 - 5411311219 - 5411311019

RK.01.121

Complete Cylinder Head

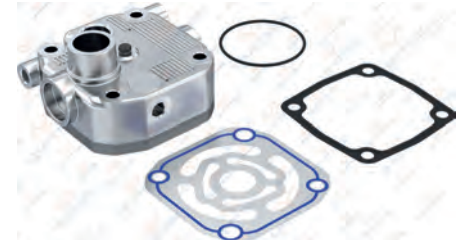

Oem No : 5411301819

01.315

Cylinder Head



Oem No : 5411310619 - 5411311119

RK.01.096.20

Valve Plate Kit

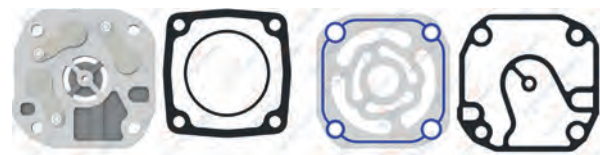

8 680437 075127



# MERCEDES

## AIR COMPRESSOR AND REPAIR KIT

**01.253** Valve Plate



**01.198** Crankshaft Flange



Oem No : 5411310242

**01.1241** Crankshaft



Oem No : 5411300214 - 5411310416

**01.051** Gear



Oem No : 4421300330 - 5411300230  
5411300630

**01.1134** Bushing



**01.1260** Connecting Rod



Oem No : 5411310617 - 5411310217

**RK.01.006.00** Piston&Ring(Ø100,00 mm)

- RK.01.006.10 100,25 mm
- RK.01.006.20 100,50 mm
- RK.01.006.30 100,75 mm
- RK.01.006.40 101,00 mm



2,50x2,50x4,00



**01.107.00** Piston(Ø100,00 mm)

- 01.107.10 100,25 mm
- 01.107.20 100,50 mm
- 01.107.30 100,75 mm
- 01.107.40 101,00 mm



2,50x2,50x4,00



**01.133.00** Ring (Ø100,00 mm)

- 01.133.10 100,25 mm
- 01.133.20 100,50 mm
- 01.133.30 100,75 mm
- 01.133.40 101,00 mm



2,50x2,50x4,00



**RK.01.091.00** Piston&Ring (Ø100,00)

- RK.01.091.10 100,25 mm
- RK.01.091.20 100,50 mm
- RK.01.091.30 100,75 mm
- RK.01.091.40 101,00 mm



2,50x2,50x3,00



**RK.01.503** Cylinder Liner Set



Including RK.01.006.00



**RK.01.502** Cylinder Liner Set



Including RK.01.091

Oem No : 5411300108



**RK.01.097.06** Repair Kit



**RK.01.012** Repair Kit

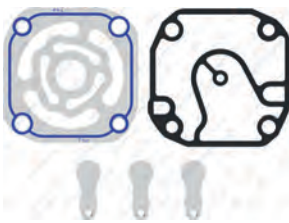

**01.652** Cylinder Liner



# Single Cylinder Vertical Compressor Ø100 mm - 596 cc - Stroke 38 mm

Application - Vehicle  
MERCEDES ACTROS OM501 - 502 - V6N - V8N



**RK.01.121** Complete Cylinder Head



**01.315** Cylinder Head



Oem No : 5411310619 - 5411311119

**RK.01.096.20** Valve Plate Kit

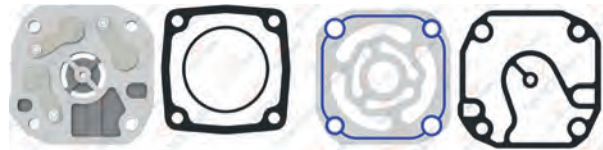

**RK.01.096.21** Valve Plate Kit



**RK.01.096** Valve Plate Kit

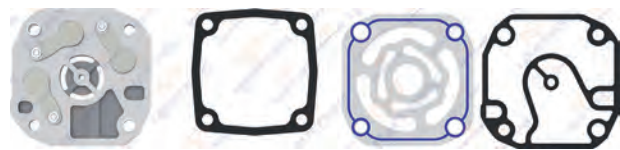

Oem No : 5411300620

**RK.01.097.06** Repair Kit



**RK.01.097** Repair Kit



**RK.01.097.02** Repair Kit





# MERCEDES

## AIR COMPRESSOR AND REPAIR KIT

01.253

Valve Plate



8 680437 020158

01.001

Connecting Rod



8 680437 009641

Oem No : 4421310217 - 5411310117

01.091

Crankshaft



8 680437 014430

Oem No : 4421300314 - 5411300514

RK.01.006.00

Piston&Ring(Ø100,00 mm)

- RK.01.006.10 100,25 mm
- RK.01.006.20 100,50 mm
- RK.01.006.30 100,75 mm
- RK.01.006.40 101,00 mm



2,50x2,50x4,00



8 680437 058243

01.107.00

Piston(Ø100,00 mm)

- 01.107.10 100,25 mm
- 01.107.20 100,50 mm
- 01.107.30 100,75 mm
- 01.107.40 101,00 mm



2,50x2,50x4,00



8 680437 015505

01.133.00

Ring (Ø100,00 mm)

- 01.133.10 100,25 mm
- 01.133.20 100,50 mm
- 01.133.30 100,75 mm
- 01.133.40 101,00 mm



2,50x2,50x4,00



8 680437 018216

RK.01.091.00

Piston&Ring(Ø100,00 mm)

- RK.01.091.10 100,25 mm
- RK.01.091.20 100,50 mm
- RK.01.091.30 100,75 mm
- RK.01.091.40 101,00 mm



2,50x2,50x3,00



8 680437 059974

01.614.00

Piston (Ø100,00 mm)

- 01.614.10 100,25 mm
- 01.614.20 100,50 mm
- 01.614.30 100,75 mm
- 01.614.40 101,00 mm



2,50x2,50x3,00



8 680437 024736

01.104.00

Ring (Ø100,00 mm)

- 01.104.10 100,25 mm
- 01.104.20 100,50 mm
- 01.104.30 100,75 mm
- 01.104.40 101,00 mm



2,50x2,50x3,00



8 680437 015109

RK.01.089

Cylinder Liner Set



Including RK.01.006.00

Oem No : 5411300008



8 680437 059950

RK.01.656

Cylinder Liner Set



Including RK.01.091



8 680437 074021

01.258

Cylinder Liner



8 680437 020240

RK.01.012

Repair Kit

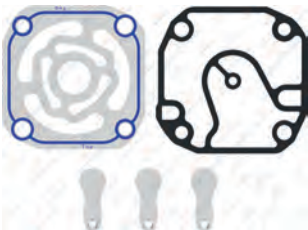

8 680437 058403

# Single Cylinder Vertical Compressor Ø100 mm - 596 cc - Stroke 38 mm

Application - Vehicle  
MERCEDES ACTROS OM501 - 502 - V6N - V8N

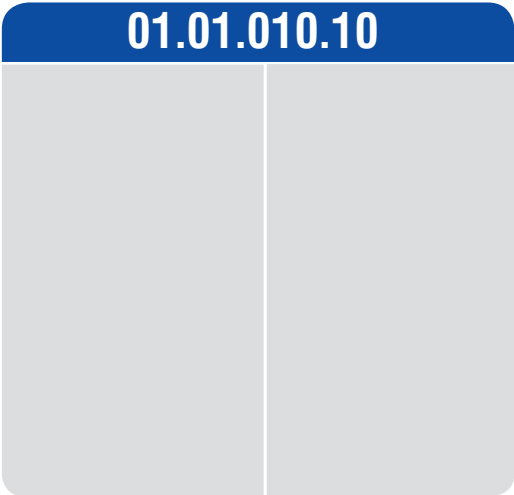
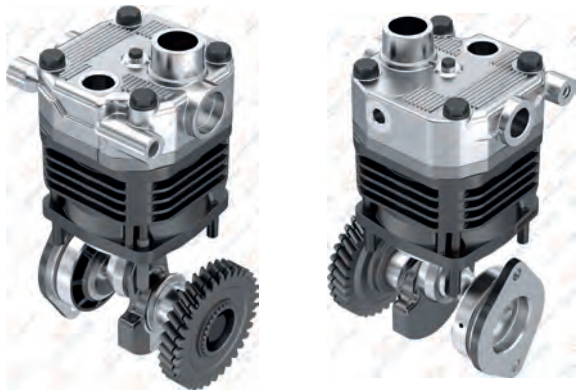

**RK.01.121** Complete Cylinder Head



**01.315** Cylinder Head



Oem No : 5411310619 - 5411311119

**RK.01.096.20** Valve Plate Kit

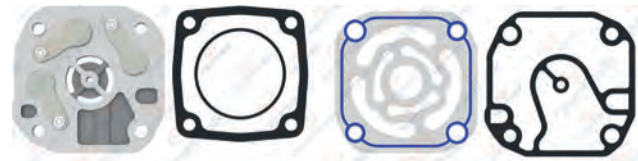

**RK.01.096.21** Valve Plate Kit



**RK.01.096** Valve Plate Kit

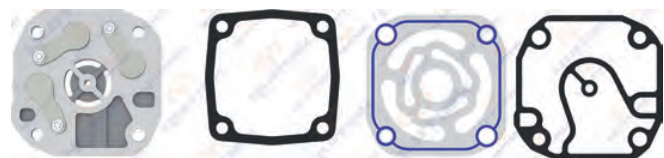

Oem No : 5411300620

**RK.01.097.06** Repair Kit



**RK.01.097** Repair Kit



**RK.01.097.02** Repair Kit

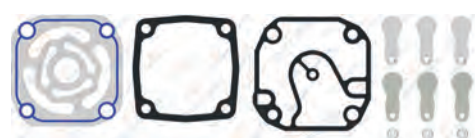



# MERCEDES

## AIR COMPRESSOR AND REPAIR KIT

**01.253** Valve Plate



**01.198** Crankshaft Flange



Oem No : 5411310242

**01.091** Crankshaft



Oem No : 4421300314 - 5411300514

**01.051** Gear



Oem No : 4421300330 - 5411300230 - 5411300630

**01.1134** Bushing



**01.001** Connecting Rod



Oem No : 4421310217 - 5411310117

**RK.01.006.00** Piston&Ring(Ø100,00 mm)

- RK.01.006.10 100,25 mm
- RK.01.006.20 100,50 mm
- RK.01.006.30 100,75 mm
- RK.01.006.40 101,00 mm



2,50x2,50x4,00



**01.107.00** Piston (Ø100,00 mm)

- 01.107.10 100,25 mm
- 01.107.20 100,50 mm
- 01.107.30 100,75 mm
- 01.107.40 101,00 mm



2,50x2,50x4,00



**01.133.00** Ring (Ø100,00 mm)

- 01.133.10 100,25 mm
- 01.133.20 100,50 mm
- 01.133.30 100,75 mm
- 01.133.40 101,00 mm



2,50x2,50x4,00



**RK.01.091.00** Piston&Ring(Ø100,00 mm)

- RK.01.091.10 100,25 mm
- RK.01.091.20 100,50 mm
- RK.01.091.30 100,75 mm
- RK.01.091.40 101,00 mm



2,50x2,50x3,00



**01.614.00** Piston (Ø100,00 mm)

- 01.614.10 100,25 mm
- 01.614.20 100,50 mm
- 01.614.30 100,75 mm
- 01.614.40 101,00 mm



2,50x2,50x3,00



**01.104.00** Ring (Ø100,00 mm)

- 01.104.10 100,25 mm
- 01.104.20 100,50 mm
- 01.104.30 100,75 mm
- 01.104.40 101,00 mm



2,50x2,50x3,00



**RK.01.089** Cylinder Liner Set



Including RK.01.006.00

Oem No : 5411300008



**RK.01.656** Cylinder Liner Set



Including RK.01.091



**01.258** Cylinder Liner



**RK.01.012** Repair Kit

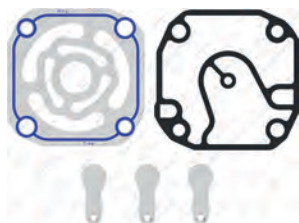

# Single Cylinder Vertical Compressor Ø100 mm - 377 CC - Stroke 48 mm

Application - Vehicle  
MERCEDES ACTROS OM501 - 502 - V6N



01.01.007

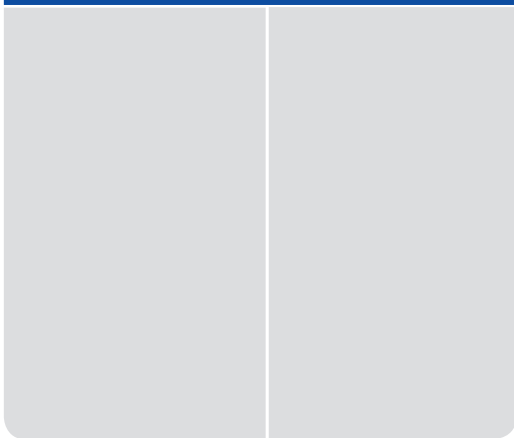

**RK.01.137** Repair Kit

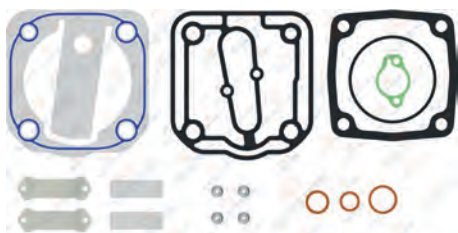

**RK.01.137.02** Repair Kit

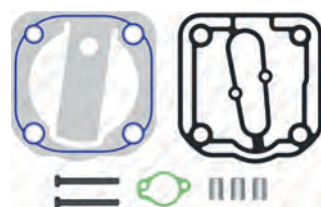

**RK.01.137.23** Repair Kit

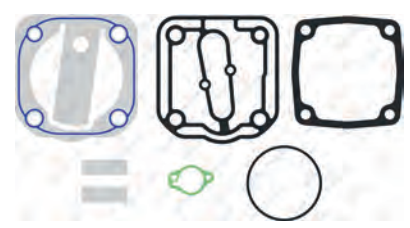

**RK.01.120** Complete Cylinder Head

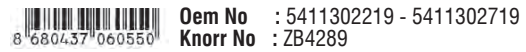

**01.316** Cylinder Head



**RK.01.119** Valve Plate Kit



**RK.01.119.21** Valve Plate Kit

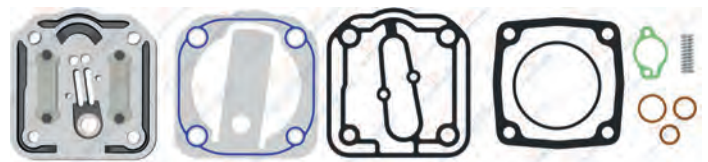

**RK.01.137.01** Repair Kit

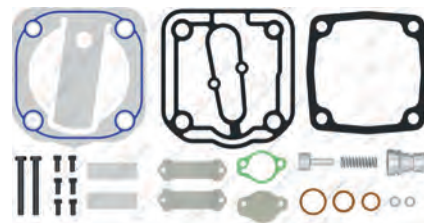

# MERCEDES

## AIR COMPRESSOR AND REPAIR KIT

**01.317** Valve Plate



**01.198** Crankshaft Flange



Oem No : 5411310242

**01.091** Crankshaft



Oem No : 4421300314 - 5411300514

**01.051** Gear



Oem No : 4421300330 - 5411300230 - 5411300630

**01.1134** Bushing



**01.001** Connecting Rod



Oem No : 4421310217 - 5411310117

**RK.01.006.00** Piston&Ring(Ø100,00 mm)

- RK.01.006.10 100,25 mm
- RK.01.006.20 100,50 mm
- RK.01.006.30 100,75 mm
- RK.01.006.40 101,00 mm



2,50x2,50x4,00



**01.107.00** Piston(Ø100,00 mm)

- 01.107.10 100,25 mm
- 01.107.20 100,50 mm
- 01.107.30 100,75 mm
- 01.107.40 101,00 mm



2,50x2,50x4,00



**01.133.00** Ring(Ø100,00 mm)

- 01.133.10 100,25 mm
- 01.133.20 100,50 mm
- 01.133.30 100,75 mm
- 01.133.40 101,00 mm



2,50x2,50x4,00



**RK.01.091.00** Piston&Ring (Ø100,00)

- RK.01.091.10 100,25 mm
- RK.01.091.20 100,50 mm
- RK.01.091.30 100,75 mm
- RK.01.091.40 101,00 mm



2,50x2,50x3,00



**RK.01.210** Cylinder Liner Set



Including RK.01.006.00



**RK.01.658** Cylinder Liner Set



Including RK.01.091



**RK.01.137.24** Repair Kit



**RK.01.198** Repair Kit



**01.753** Cylinder Liner





## Twin Cyl. Vertical & Horizontal Comp. Ø100 mm - 722 CC - Stroke 46 mm

Application - Vehicle  
MERCEDES ACTROS  
OM501 - 502 - EURO4 - EURO5 - V TYPE

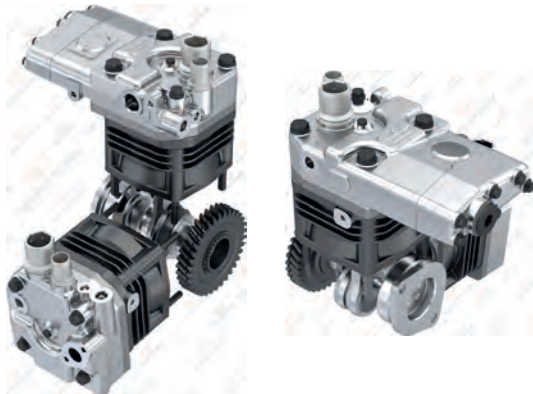

**01.01.012**

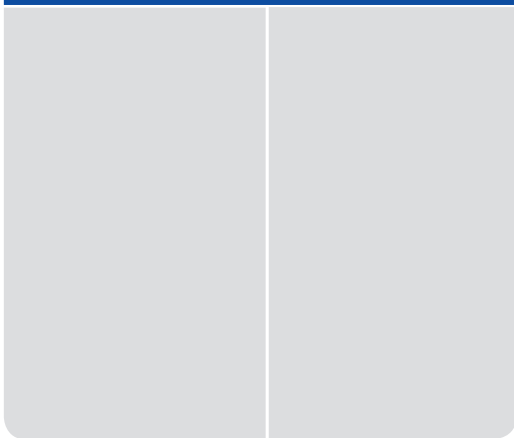

**RK.01.521.22** Valve Plate Kit



**RK.01.526.20** Repair Kit



**RK.01.520.10** Complete Cylinder Head



Oem No : 5411303619

**01.1077.10**

Cylinder Head



**RK.01.531**

Complete Cylinder Head



Oem No : 5411303719

**01.1470**

Cylinder Head



**RK.01.521**

Valve Plate Kit

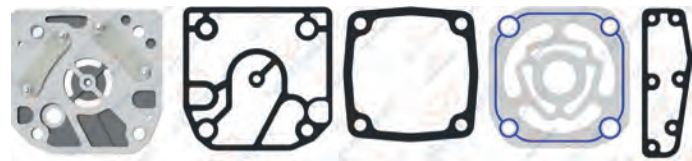

**RK.01.526**

Repair Kit

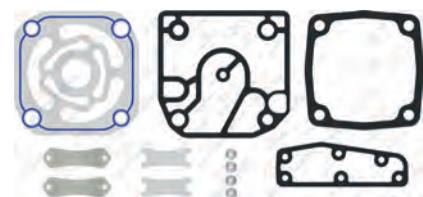

# MERCEDES

## AIR COMPRESSOR AND REPAIR KIT

**01.1130** Valve Plate



**01.198** Crankshaft Flange



Oem No : 5411310242

**01.1241** Crankshaft



Oem No : 5411300214 - 5411310416

**01.051** Gear



Oem No : 4421300330 - 5411300230  
5411300630

**01.1134** Bushing



**01.1260** Connecting Rod



Oem No : 5411310617 - 5411310217

**RK.01.006.00** Piston&Ring(Ø100,00 mm)

- RK.01.006.10 100,25 mm
- RK.01.006.20 100,50 mm
- RK.01.006.30 100,75 mm
- RK.01.006.40 101,00 mm



2,50x2,50x4,00



**01.107.00** Piston(Ø100,00 mm)

- 01.107.10 100,25 mm
- 01.107.20 100,50 mm
- 01.107.30 100,75 mm
- 01.107.40 101,00 mm



2,50x2,50x4,00



**01.133.00** Ring (Ø100,00 mm)

- 01.133.10 100,25 mm
- 01.133.20 100,50 mm
- 01.133.30 100,75 mm
- 01.133.40 101,00 mm



2,50x2,50x4,00



**RK.01.091.00** Piston&Ring (Ø100,00)

- RK.01.091.10 100,25 mm
- RK.01.091.20 100,50 mm
- RK.01.091.30 100,75 mm
- RK.01.091.40 101,00 mm



2,50x2,50x3,00



**RK.01.503** Cylinder Liner Set



Including RK.01.006.00



**RK.01.502** Cylinder Liner Set



Including RK.01.091



Oem No : 5411300108

**RK.01.526.24** Repair Kit



**RK.01.526.05** Repair Kit



**01.652** Cylinder Liner



# Single Cylinder Vertical Compressor Ø100 mm - 440 CC - Stroke 56 mm

Application - Vehicle  
OM501 - 502 - EURO4 - EURO5 - V6

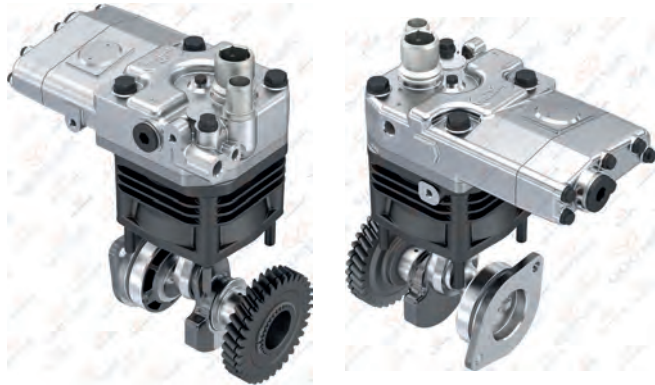

## RK.01.520

Complete Cylinder Head



Oem No : 5411303519

## 01.1077

Cylinder Head



## RK.01.521

Valve Plate Kit



## RK.01.521.21

Valve Plate Kit

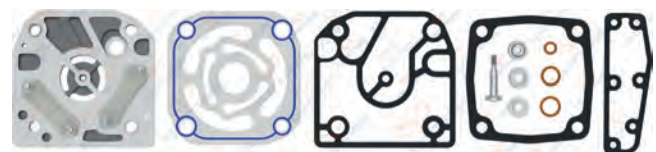

## RK.01.521.22

Valve Plate Kit



## RK.01.526.20

Repair Kit

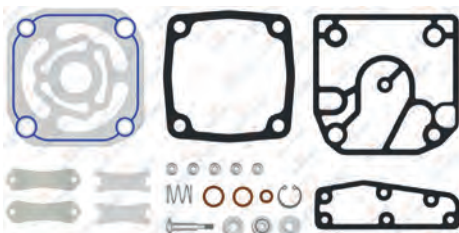

## RK.01.526

Repair Kit

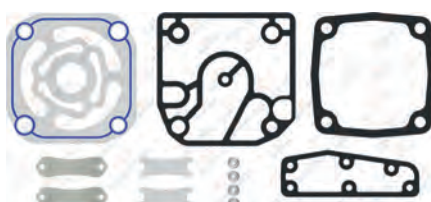

## RK.01.526.06

Repair Kit

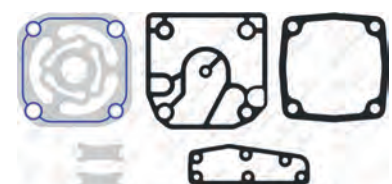



# MERCEDES

## AIR COMPRESSOR AND REPAIR KIT

**01.1130** Valve Plate



8 680437 016595

**01.198** Crankshaft Flange



Oem No : 5411310242

8 680437 019442

**01.091** Crankshaft



Oem No : 4421300314 - 5411300514

8 680437 014430

**01.051** Gear



Oem No : 4421300330 - 5411300230 - 5411300630

8 680437 013105

**01.1134** Bushing



8 680437 016663

**01.001** Connecting Rod



Oem No : 4421310217 - 5411310117

8 680437 009641

**RK.01.006.00** Piston&Ring(Ø100,00 mm)

- RK.01.006.10 100,25 mm
- RK.01.006.20 100,50 mm
- RK.01.006.30 100,75 mm
- RK.01.006.40 101,00 mm



2,50x2,50x4,00



8 680437 056243

**01.107.00** Piston (Ø100,00 mm)

- 01.107.10 100,25 mm
- 01.107.20 100,50 mm
- 01.107.30 100,75 mm
- 01.107.40 101,00 mm



2,50x2,50x4,00



8 680437 015505

**01.133.00** Ring (Ø100,00 mm)

- 01.133.10 100,25 mm
- 01.133.20 100,50 mm
- 01.133.30 100,75 mm
- 01.133.40 101,00 mm



2,50x2,50x4,00



8 680437 018216

**RK.01.091.00** Piston&Ring (Ø100,00)

- RK.01.091.10 100,25 mm
- RK.01.091.20 100,50 mm
- RK.01.091.30 100,75 mm
- RK.01.091.40 101,00 mm



2,50x2,50x3,00



8 680437 059974

**RK.01.089** Cylinder Liner Set



Including RK.01.006.00



Oem No : 5411300008

8 680437 059950

**RK.01.656** Cylinder Liner Set



Including RK.01.091



8 680437 074021

**RK.01.526.24** Repair Kit



8 680437 075264

**RK.01.526.05** Repair Kit



8 680437 117834

**01.258** Cylinder Liner



8 680437 020240

## Twin Cyl. Vertical & Horizontal Comp. Ø100 mm - 722 CC - Stroke 46 mm

Application - Vehicle  
OM501 - 502 - EURO4 - EURO5 - V8

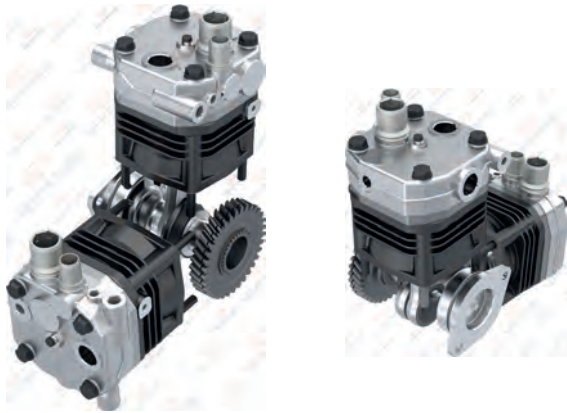

01.01.015

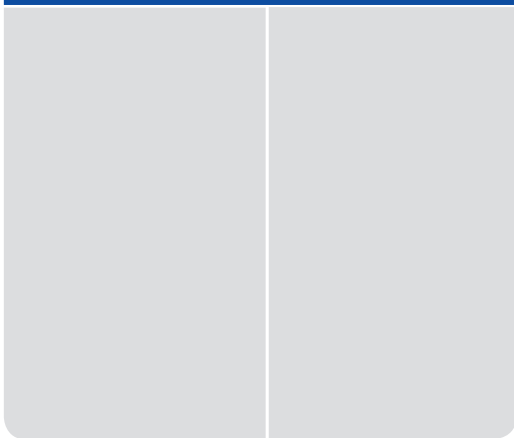

**RK.01.706** Valve Plate Kit

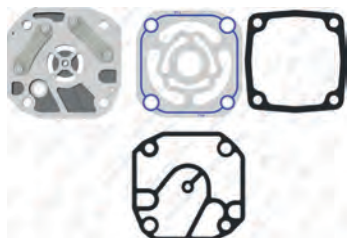

**RK.01.706.02** Valve Plate Kit

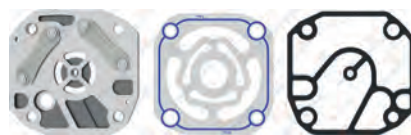

**RK.01.661.01** Repair Kit

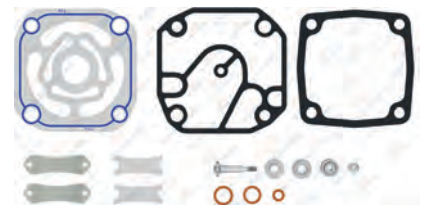

**RK.01.704**

Complete Cylinder Head



Oem No : 5411303119

**01.1482**

Cylinder Head



**RK.01.705**

Complete Cylinder Head

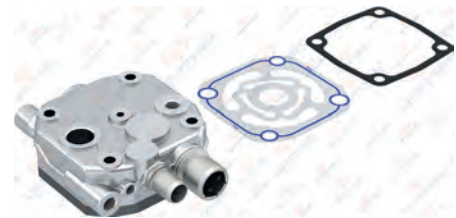

Oem No : 5411303219

**01.1483**

Cylinder Head



**RK.01.706.01**

Valve Plate Kit

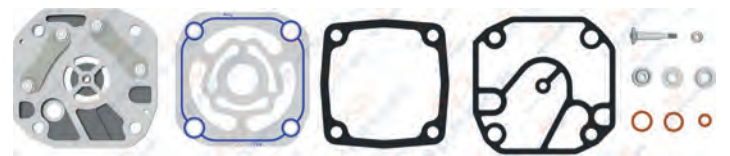

# MERCEDES

## AIR COMPRESSOR AND REPAIR KIT

**01.1556** Valve Plate



8 680437 116929

**01.198** Crankshaft Flange



Oem No : 5411310242

**01.1241** Crankshaft



Oem No : 5411300214 - 5411310416

**01.051** Gear



Oem No : 4421300330 - 5411300230  
5411300630

**01.1134** Bushing



8 680437 016663

**01.1260** Connecting Rod



Oem No : 5411310617 - 5411310217

**RK.01.091.00** Piston&Ring(Ø100,00 mm)

- RK.01.091.10 100,25 mm
- RK.01.091.20 100,50 mm
- RK.01.091.30 100,75 mm
- RK.01.091.40 101,00 mm



2,50x2,50x3,00



8 680437 059974

**01.614.00** Piston (Ø100,00 mm)

- 01.614.10 100,25 mm
- 01.614.20 100,50 mm
- 01.614.30 100,75 mm
- 01.614.40 101,00 mm



2,50x2,50x3,00



8 680437 024736

**01.104.00** Ring (Ø100,00 mm)

- 01.104.10 100,25 mm
- 01.104.20 100,50 mm
- 01.104.30 100,75 mm
- 01.104.40 101,00 mm



2,50x2,50x3,00



8 680437 015109

**RK.01.006.00** Piston&Ring (Ø100,00)

- RK.01.006.10 100,25 mm
- RK.01.006.20 100,50 mm
- RK.01.006.30 100,75 mm
- RK.01.006.40 101,00 mm



2,50x2,50x4,00



8 680437 058243

**RK.01.503** Cylinder Liner Set



Including RK.01.006.00



8 680437 065951

**RK.01.502** Cylinder Liner Set



Including RK.01.091



Oem No : 5411300108

**RK.01.661** Repair Kit

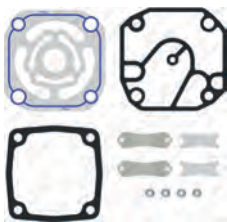

8 680437 078494

**RK.01.526.24** Repair Kit



8 680437 075264

**01.652** Cylinder Liner

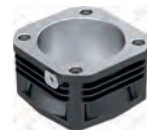

8 680437 025184



# Single Cylinder Compressor Ø100 mm - 377 CC - Stroke 48 mm

Application - Vehicle  
MERCEDES EURO2 345 BUS

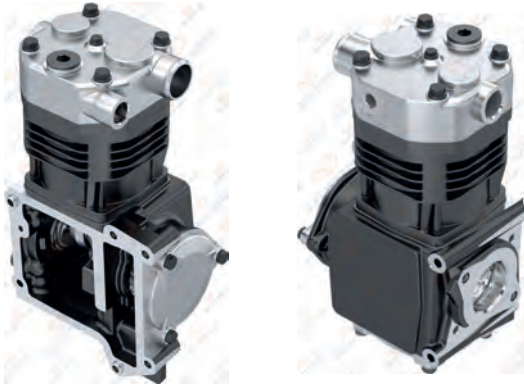

**01.01.009**

Oem. No.  
4471302815



**01.088**

Crankcase



Oem No : 4471310315

**RK.01.024**

Repair Kit



**RK.01.024.02**

Repair Kit



**RK.01.177**

Complete Cylinder Head

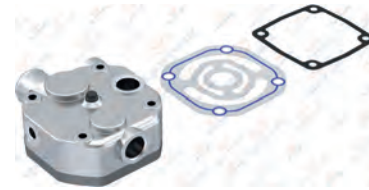

Oem No : 4421317119

**01.433**

Cylinder Head



Oem No : 4421310519

**RK.01.021.01**

Valve Plate Kit

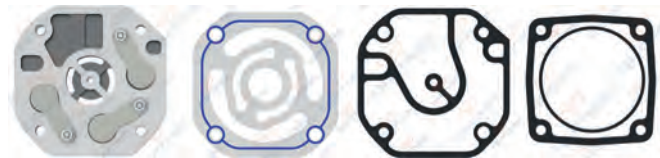

**RK.01.021**

Valve Plate Kit



Oem No : 4421301120

**RK.01.024.01**

Repair Kit

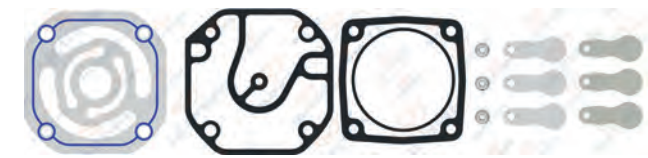

# MERCEDES

## AIR COMPRESSOR AND REPAIR KIT

**01.594** Valve Plate



8 680437 024422

**01.520** Crankshaft Flange



8 680437 023616

**01.019** Crankshaft Flange



8 680437 010050

Oem No : 4421311342

**01.001** Connecting Rod



8 680437 009641

Oem No : 4421310217 - 5411310117

**01.604** Connecting Rod



8 680437 024538

injection

**01.092** Crankshaft



8 680437 014447

M18x1.5 Right Hand

**RK.01.006.00** Piston&Ring(Ø100,00 mm)

- RK.01.006.10 100,25 mm
- RK.01.006.20 100,50 mm
- RK.01.006.30 100,75 mm
- RK.01.006.40 101,00 mm



2,50x2,50x4,00



8 680437 058243

**01.107.00** Piston(Ø100,00 mm)

- 01.107.10 100,25 mm
- 01.107.20 100,50 mm
- 01.107.30 100,75 mm
- 01.107.40 101,00 mm



2,50x2,50x4,00



8 680437 015505

**01.133.00** Ring (Ø100,00 mm)

- 01.133.10 100,25 mm
- 01.133.20 100,50 mm
- 01.133.30 100,75 mm
- 01.133.40 101,00 mm



2,50x2,50x4,00



8 680437 018216

**RK.01.005** Cylinder Liner Set



8 680437 058236

Oem No : 4411300108

**01.054** Cylinder Liner



8 680437 013136

**01.050** Gear



8 680437 013099

Oem No : 4471320205

**01.197** Bushing



8 680437 019435

**01.961** Bushing



8 680437 028949

42X38X20.5

**01.028** Screw



8 680437 010173

M18x1.5 Right Hand

# Single Cylinder Compressor Ø100 mm - 377 CC - Stroke 48 mm

Application - Vehicle  
MERCEDES EURO2 345 BUS

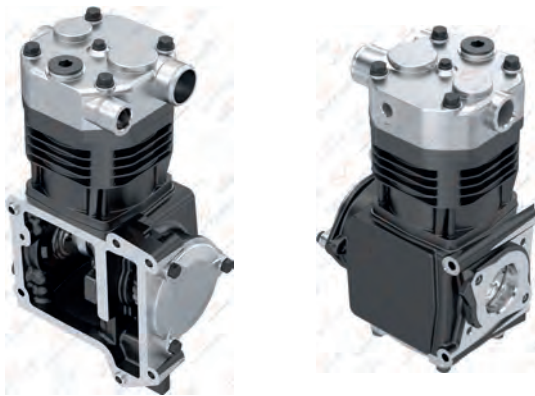

**01.01.009.10**

Oem. No.  
4471302815

Wabco No.



**01.088** Crankcase



Oem No : 447130315  
8 680437 014379

**RK.01.024** Repair Kit



8 680437 058595

**RK.01.024.02** Repair Kit



8 680437 119548

**RK.01.177** Complete Cylinder Head

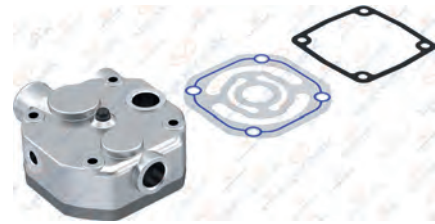

Oem No : 4421317119  
8 680437 061809

**01.433** Cylinder Head



Oem No : 4421310519  
8 680437 022534

**RK.01.021.01** Valve Plate Kit

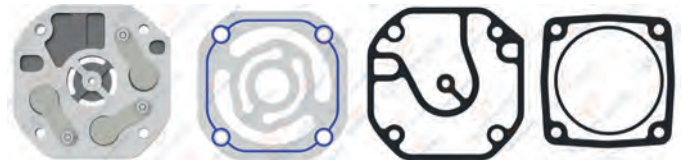

8 680437 112389

**RK.01.021** Valve Plate Kit



Oem No : 4421301120  
8 680437 058519

**RK.01.024.01** Repair Kit



8 680437 058618



# MERCEDES

## AIR COMPRESSOR AND REPAIR KIT

**01.594** Valve Plate



8 680437 024422

**01.520** Crankshaft Flange



8 680437 023616

**01.019** Crankshaft Flange



8 680437 010050

Oem No : 4421311342

**01.050** Gear



8 680437 013099

Oem No : 4471320205

**01.001** Connecting Rod



8 680437 009641

Oem No : 4421310217 - 5411310117

**01.092.10** Crankshaft



8 680437 072737

**RK.01.006.00** Piston&Ring(Ø100,00 mm)

- RK.01.006.10 100,25 mm
- RK.01.006.20 100,50 mm
- RK.01.006.30 100,75 mm
- RK.01.006.40 101,00 mm



2,50x2,50x4,00



8 680437 058243

**01.107.00** Piston(Ø100,00 mm)

- 01.107.10 100,25 mm
- 01.107.20 100,50 mm
- 01.107.30 100,75 mm
- 01.107.40 101,00 mm



2,50x2,50x4,00



8 680437 015505

**01.133.00** Ring (Ø100,00 mm)

- 01.133.10 100,25 mm
- 01.133.20 100,50 mm
- 01.133.30 100,75 mm
- 01.133.40 101,00 mm



2,50x2,50x4,00



8 680437 018216

**RK.01.005** Cylinder Liner Set



8 680437 058236

Oem No : 4411300108

**01.054** Cylinder Liner



8 680437 013136

**01.961** Bushing



42X38X20.5



8 680437 028949

**01.074** Cover



8 680437 014140

**01.075** Cover



8 680437 014157

**00.460** Roller Bearing



NUP 306



8 680437 004714

# Single Cylinder Compressor Ø100 mm - 377 CC - Stroke 48 mm

Application - Vehicle  
MERCEDES OM447 / EURO1

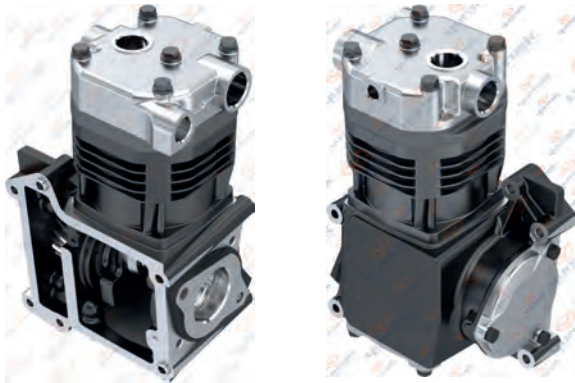

## 01.01.001

Oem. No.  
4471302215  
4471302015



8 680437 009832



## 01.088 Crankcase



Oem No : 4471310315

## RK.01.001.03 Repair Kit

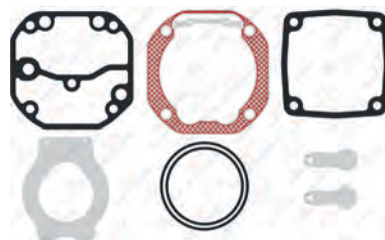

8 680437 058175

## RK.01.001 Repair Kit

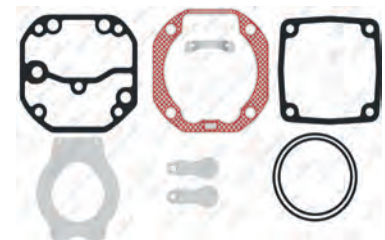

8 680437 058137

## RK.01.003.08 Complete Cylinder Head

Complete Cylinder Head



Oem No : 4421303419

## RK.01.003 Complete Cylinder Head

Complete Cylinder Head



8 680437 058205

## 01.077 Cylinder Head

Cylinder Head



Oem No : 4421303219

## RK.01.002.05 Valve Plate Kit

Valve Plate Kit



Oem No : 4411300120 - 4411300220

## RK.01.002 Valve Plate Kit

Valve Plate Kit



8 680437 058182

# MERCEDES

## AIR COMPRESSOR AND REPAIR KIT

**RK.01.001.20** Repair Kit

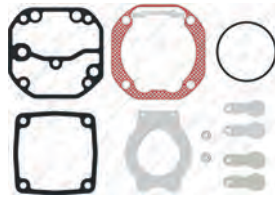

8 680437 079897

**RK.01.001.21** Repair Kit

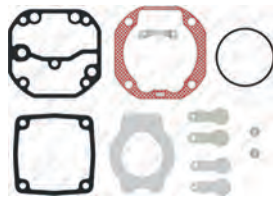

8 680437 120902

**01.092** Crankshaft



M18x1.5 Right Hand



8 680437 014447

**01.117** Valve Plate



8 680437 017141

**01.019** Crankshaft Flange



8 680437 010050

Oem No : 4421311342

**01.520** Crankshaft Flange



8 680437 023616

**RK.01.006.00** Piston&Ring(Ø100,00 mm)

- RK.01.006.10 100,25 mm
- RK.01.006.20 100,50 mm
- RK.01.006.30 100,75 mm
- RK.01.006.40 101,00 mm



2,50x2,50x4,00



8 680437 058243

**01.107.00** Piston(Ø100,00 mm)

- 01.107.10 100,25 mm
- 01.107.20 100,50 mm
- 01.107.30 100,75 mm
- 01.107.40 101,00 mm



2,50x2,50x4,00



8 680437 015505

**01.133.00** Ring (Ø100,00 mm)

- 01.133.10 100,25 mm
- 01.133.20 100,50 mm
- 01.133.30 100,75 mm
- 01.133.40 101,00 mm



2,50x2,50x4,00



8 680437 018216

**RK.01.004** Cylinder Liner Set



8 680437 058229

Oem No : 4411300008

**01.053** Cylinder Liner



8 680437 013129

**01.050** Gear



8 680437 013099

Oem No : 4471320205

**RK.01.196** Repair Kit



8 680437 062066

**01.197** Bushing



8 680437 019435

**01.961** Bushing



42X38X20.5



8 680437 028949



## Single Cylinder Compressor Ø88 mm - 225 CC - Stroke 37 mm

**Application - Vehicle**  
MERCEDES 2521 / 1520 / OM356  
OM 355 / OM 362 / OM 364 / OM 366

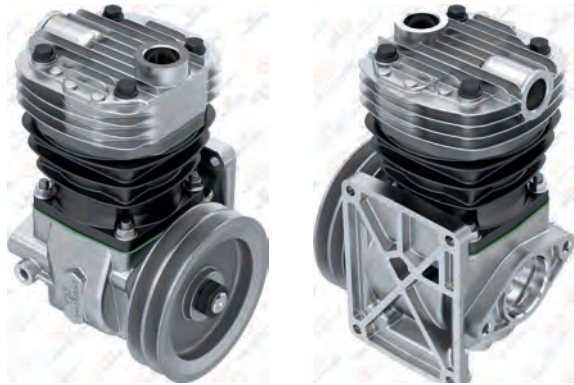

### 01.04.151

Oem. No.	Knorr No.
0041319401	LK1813
004131940180	
0041317401	
0041317701	



### 01.1357 Crankcase



### RK.01.044.01 Repair Kit

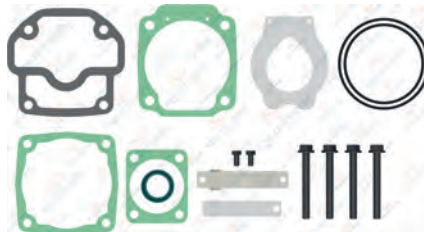

### RK.01.044 Repair Kit

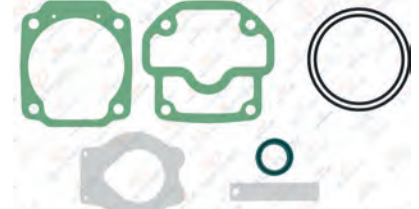

### RK.01.042.20 Complete Cylinder Head

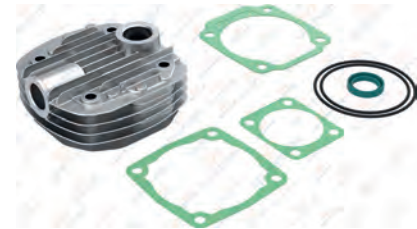

### RK.01.042 Complete Cylinder Head



### 01.187 Cylinder Head

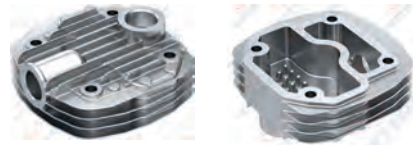

### RK.01.074.01 Valve Plate Kit



### RK.01.074 Valve Plate Kit



# MERCEDES

## AIR COMPRESSOR AND REPAIR KIT

**01.120** Valve Plate



Oem No : 0001307120  
Knorr No : I138714F004

**01.066** Crankshaft Flange



Oem No : 000130617  
Knorr No : I138714F004

**01.764** Crankshaft



M18x1.5 Right Hand  
Oem No : 0001315916 - 0001316016

**01.1345** Pulley



Oem No : 3661320015

**01.013** Bushing



34X30X16  
Oem No : 000130617  
Knorr No : I138714F004

**01.003** Connecting Rod



Oem No : 0001311817

**RK.01.034.00** Piston&Ring (Ø88,00 mm)

- RK.01.034.10 88,25 mm
- RK.01.034.20 88,50 mm
- RK.01.034.30 88,75 mm
- RK.01.034.40 89,00 mm



2,50x2,50x4,00  
Oem No : 0001302517-0001319311

**01.110.00** Piston (Ø88,00 mm)

- 01.110.10 88,25 mm
- 01.110.20 88,50 mm
- 01.110.30 88,75 mm
- 01.110.40 89,00 mm



2,50x2,50x4,00  
Oem No : 0001300617

**01.136.00** Ring (Ø88,00 mm)

- 01.136.10 88,25 mm
- 01.136.20 88,50 mm
- 01.136.30 88,75 mm
- 01.136.40 89,00 mm



2,50x2,50x4,00  
Oem No : 0011310611

**RK.01.039** Cylinder Liner Set



Knorr No : I808640061

**01.184** Cylinder Liner



Oem No : 0001314202  
Knorr No : C63059

**01.143** Nut



M18x1.5 Right Hand

**RK.01.044.25** Repair Kit

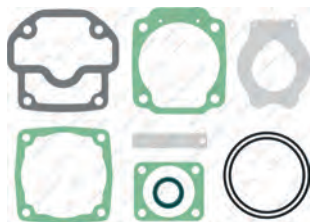

Oem No : 0001302517-0001319311

**00.486** Roller Bearing



NUP 305  
Oem No : 0001302517-0001319311

## Single Cylinder Compressor Ø88 mm - 225 CC - Stroke 37 mm

Application - Vehicle  
MERCEDES 2521 / 1520 / OM356

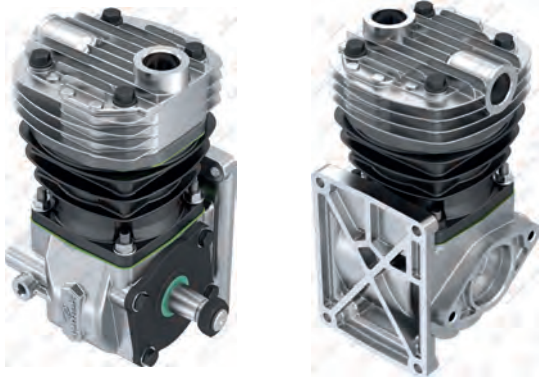

### 01.04.003 - 01.04.036

**Oem. No.**

0041319401  
004131940180  
0041319501  
004131950180  
0041317401  
0041317701

**Knor No.**

LK1813-II18355  
LK1814-II18356



### 01.1357

#### Crankcase



### RK.01.044.01

#### Repair Kit

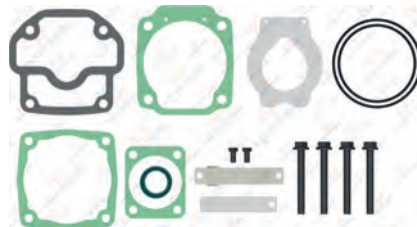

### RK.01.044

#### Repair Kit

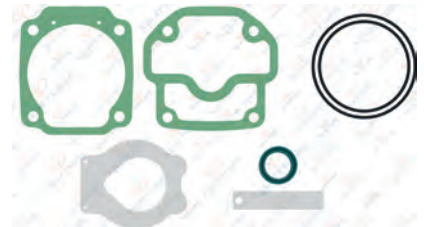

### RK.01.042.20

#### Complete Cylinder Head



### RK.01.042

#### Complete Cylinder Head



### 01.187

#### Cylinder Head

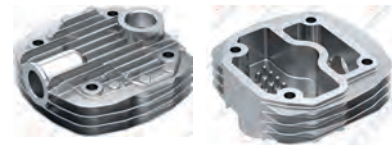

Oem No : 0001314519

### RK.01.074.01

#### Valve Plate Kit



### RK.01.074

#### Valve Plate Kit





# MERCEDES

## AIR COMPRESSOR AND REPAIR KIT

**01.120** Valve Plate



Oem No : 0001307120  
Knorr No : I138714F004

**01.066** Crankshaft Flange



Oem No : 000130617  
Knorr No : I138714F004

**01.764** Crankshaft



M18x1.5 Right Hand  
Oem No : 0001315916 - 0001316016

**00.486** Roller Bearing



NUP 305

Oem No : 0001302517-0001319311

**01.013** Bushing



34X30X16

Oem No : 0001313050

**01.003** Connecting Rod



Oem No : 0001311817

**RK.01.034.00** Piston&Ring (Ø88,00 mm)

- RK.01.034.10 88,25 mm
- RK.01.034.20 88,50 mm
- RK.01.034.30 88,75 mm
- RK.01.034.40 89,00 mm



2,50x2,50x4,00

Oem No : 0001302517-0001319311

**01.110.00** Piston (Ø88,00 mm)

- 01.110.10 88,25 mm
- 01.110.20 88,50 mm
- 01.110.30 88,75 mm
- 01.110.40 89,00 mm



2,50x2,50x4,00

Oem No : 0001300617

**01.136.00** Ring (Ø88,00 mm)

- 01.136.10 88,25 mm
- 01.136.20 88,50 mm
- 01.136.30 88,75 mm
- 01.136.40 89,00 mm



2,50x2,50x4,00

Oem No : 0011310611

**RK.01.039** Cylinder Liner Set



Knorr No : I808640061

**01.184** Cylinder Liner



Oem No : 0001314202  
Knorr No : C63059

**01.143** Nut



M18x1.5 Right Hand

Oem No : 0001315916 - 0001316016

**RK.01.044.25** Repair Kit

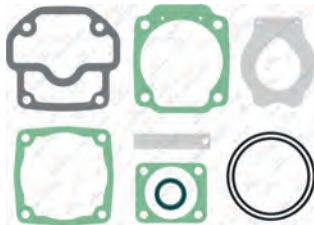

Oem No : 0001302517-0001319311

## 3 Cylinder Compressor Ø85 mm 636 CC / 210 CC Stroke 56 mm / 37 mm

### Application - Vehicle

MERCEDES AXOR OM457 (EURO 5)  
BELEDİYE OTOBÜSÜ ve METROBÜS



**01.06.073**

**Oem. No.**  
4571303815  
4571305015

**Wabco No.**  
9125103030



**01.1431** Valve Plate



**01.1430** Cylinder Head



**01.335** Pressure valve



**RK.01.694**

Complete Cylinder Head

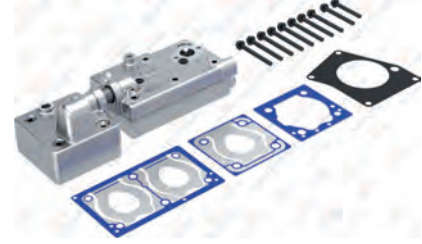

**RK.01.695**

Complete Cylinder Head



**Oem No.** : 0011305715  
**Wabco No.** : 9125109252

**RK.01.696**

Complete Cylinder Head

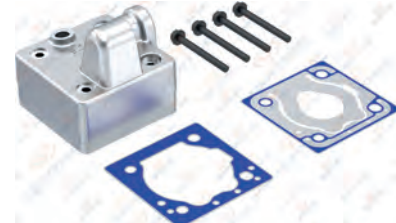

**Oem No.** : 0011305615  
**Wabco No.** : 9125109242

**01.1284.10**

Valve Plate



**01.1298**

Cylinder Head



# MERCEDES

## AIR COMPRESSOR AND REPAIR KIT

**RK.01.689.01** Repair Kit

8 680437 074519

**RK.01.689** Repair Kit

8 680437 072621

**01.390** Connecting Rod

Oem No : 0001312517 - 0001312917  
Wabco No : 9111457382

8 680437 022015

**01.1481** Cooling Plate

8 680437 116493

**01.360** Gear

Oem No : 4571320905  
Wabco No : 8959051884

8 680437 021551

**01.272** Connecting Rod

8 680437 020400

**RK.01.104.00** Piston&Ring (Ø85,00 mm)

RK.01.104.10	85,25 mm
RK.01.104.20	85,50 mm
RK.01.104.30	85,75 mm
RK.01.104.40	86,00 mm

2,00x2,00x4,00

8 680437 060277

**01.142.00** Piston (Ø85,00 mm)

01.142.10	85,25 mm
01.142.20	85,50 mm
01.142.30	85,75 mm
01.142.40	86,00 mm

2,00x2,00x4,00

8 680437 018674

**01.373.00** Ring (Ø85,00 mm)

01.373.10	85,25 mm
01.373.20	85,50 mm
01.373.30	85,75 mm
01.373.40	86,00 mm

2,00x2,00x4,00

Oem No : 0011311111  
Wabco No : 9115019202

8 680437 075431

**01.257** Bushing

8 680437 020233

**01.957** Nut

M20X1.5 Left Hand  
Wabco No : 0029906650

8 680437 028871

**01.1227** Bushing

52X48X20

8 680437 017936

**01.302** Cap

8 680437 020769

**01.1232** Cap

8 680437 018001

Blank area for product information.

Blank area for product information.

Blank area for product information.



## Single Cylinder Compressor Ø90 mm - 292 CC - Stroke 36 mm

Application - Vehicle  
MERCEDES 352 / OM 355 / 356



### 01.03.003

Oem. No.  
0011315201  
0011315401

Wabco No.  
4110345010  
4111427110



8 680437 010210



### 01.082 Crankcase



8 680437 014287

### RK.01.028 Complete Cylinder Head



8 680437 058694

### RK.01.028.01 Complete Cylinder Head



8 680437 105220

### RK.01.027.20 Valve Plate Kit



8 680437 074915

### RK.01.027 Valve Plate Kit



8 680437 058687

Oem No : 0001301320  
Wabco No : 4110345002

### RK.01.025.01 Repair Kit

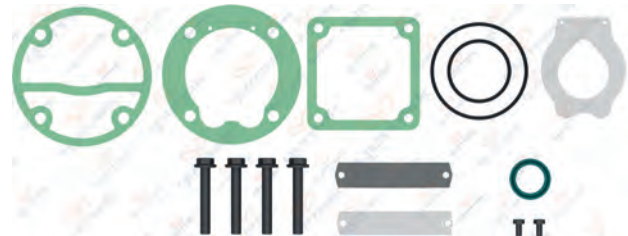

8 680437 058656

### RK.01.025 Repair Kit

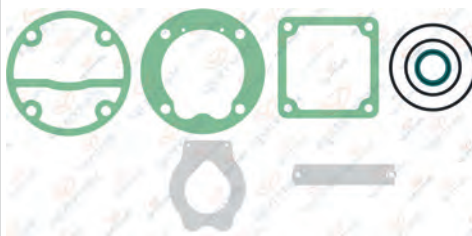

8 680437 058632

### RK.01.025.02 Repair Kit

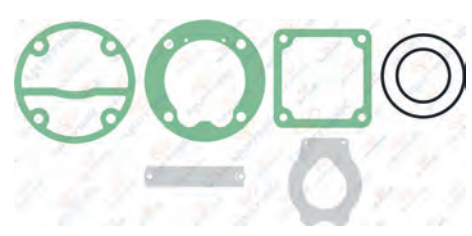

8 680437 058663

# MERCEDES

## AIR COMPRESSOR AND REPAIR KIT

**01.064** Cylinder Head



Oem No : 0001313119  
Wabco No : 4110356522

**01.118** Valve Plate



Oem No : 0001313119  
Wabco No : 4110356522

**01.095** Crankshaft



M18X1.5 Right Hand

Oem No : 0001313119  
Wabco No : 4110356522

**01.063** Pump Support



Oem No : 0001310342  
Wabco No : 4110356522

**01.065** Crankshaft Flange



Oem No : 0001300232  
Wabco No : 4110426602

**01.002** Connecting Rod



Oem No : 0001312416  
Wabco No : 4110356522

**RK.01.030.00** Piston&Ring (Ø90,00 mm)

- RK.01.030.10 90,25 mm
- RK.01.030.20 90,50 mm
- RK.01.030.30 90,75 mm
- RK.01.030.40 91,00 mm



2,50x2,50x4,00  
 Oem No : 0001301117  
Wabco No : 4110426202

**01.108.00** Piston (Ø90,00 mm)

- 01.108.10 90,25 mm
- 01.108.20 90,50 mm
- 01.108.30 90,75 mm
- 01.108.40 91,00 mm



2,50x2,50x4,00  
 Oem No : 0001301117  
Wabco No : 4110426202

**01.138.00** Ring (Ø90,00 mm)

- 01.138.10 90,25 mm
- 01.138.20 90,50 mm
- 01.138.30 90,75 mm
- 01.138.40 91,00 mm



2,50x2,50x4,00  
 Oem No : 0001301117  
Wabco No : 4110426202

**RK.01.026** Cylinder Liner Set



Oem No : 0001314560-0001300208-0011315501  
Wabco No : 4110356522

**01.055** Cylinder Liner



Oem No : 0001312802-4110345704-0011313602-0001312902  
Wabco No : 4110356522

**01.176** Connecting Rod Bearing Kit



Oem No : 0001312802-4110345704-0011313602-0001312902  
Wabco No : 4110356522

**RK.01.025.05** Repair Kit



Oem No : 0001312802-4110345704-0011313602-0001312902  
Wabco No : 4110356522

**RK.01.025.04** Repair Kit



Oem No : 0001312802-4110345704-0011313602-0001312902  
Wabco No : 4110356522

**00.138** Roller Bearing



6206  
 Oem No : 0001312802-4110345704-0011313602-0001312902  
Wabco No : 4110356522

## Single Cylinder Compressor Ø90 mm - 292 CC - Stroke 46 mm

Application - Vehicle  
MERCEDES OM 407

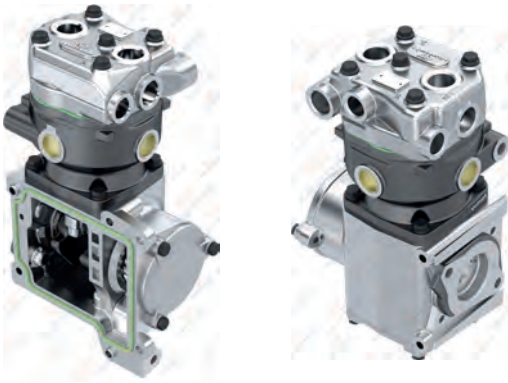

### 01.03.013

Oem. No.  
4071300615  
4071300715



8 680437 010319



### 01.083

Crankcase



Oem No : 4071300610

### RK.01.017.22

Repair Kit



8 680437 075196

### 01.577

Gasket



8 680437 024224

### RK.01.015

Complete Cylinder Head



Oem No : 0001302419 - 0001302519 - 0001302619  
Knorr No : ZB4187 - ZB4224 - ZB4229

### RK.01.015.20

Complete Cylinder Head



Oem No : 0001302419\* - 0001302519\* - 0001302619\*  
Knorr No : ZB4187\* - ZB4224\* - ZB4229\*

### RK.01.016.20

Valve Plate Kit



8 680437 074816

### RK.01.016

Valve Plate Kit



Oem No : 4021300120 - 4021300320

### RK.01.017

Repair Kit

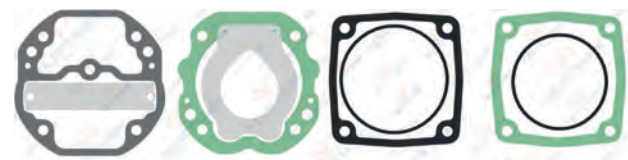

Oem No : 4025865013 - 4021300020 - 4021300220



# MERCEDES

## AIR COMPRESSOR AND REPAIR KIT

**01.069** Cylinder Head



Oem No : 4071310519

8 680437 076926

**01.020** Crankshaft Flange



Oem No : 4031301645

8 680437 010081

**01.094** Crankshaft



M18x1.5 Right Hand

Oem No : 4031310716

8 680437 014485

**01.121** Valve Plate



8 680437 017660

**01.241** Connecting Rod Bearing Kit



Oem No : 4031310233

8 680437 019985

**01.006** Connecting Rod



Oem No : 4031302816\* - 4031302216\*

8 680437 009757

**RK.01.022.00** Piston&Ring (Ø90,00 mm)

RK.01.022.10	90,25 mm
RK.01.022.20	90,50 mm
RK.01.022.30	90,75 mm
RK.01.022.40	91,00 mm



2,50x2,50x4,00

8 680437 058526

**01.112.00** Piston (Ø90,00 mm)

01.112.10	90,25 mm
01.112.20	90,50 mm
01.112.30	90,75 mm
01.112.40	91,00 mm



2,50x2,50x4,00

Oem No : 4031300517

8 680437 016342

**01.138.00** Ring (Ø90,00 mm)

01.138.10	90,25 mm
01.138.20	90,50 mm
01.138.30	90,75 mm
01.138.40	91,00 mm



2,50x2,50x4,00

8 680437 018469

**RK.01.018** Cylinder Liner Set



8 680437 058489

**01.059** Cylinder Liner



8 680437 013211

**01.052** Gear



Oem No : 4661320005

8 680437 013112

**00.460** Roller Bearing



NUP 306

8 680437 004714

**01.074** Cover



8 680437 014140

**01.075** Cover



8 680437 014157

## Single Cylinder Compressor Ø90 mm - 292 CC - Stroke 46 mm

Application - Vehicle  
MERCEDES MB 407

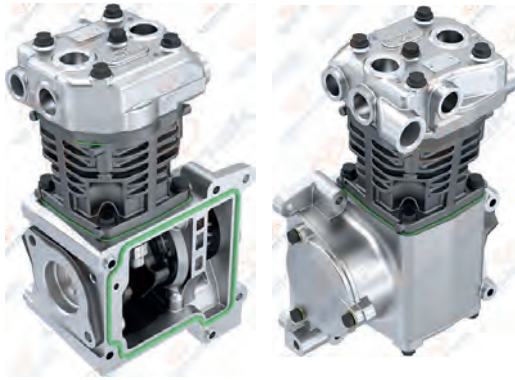

### 01.03.028

Oem. No.	Knorr No.
4751300115	
4071300115	



### 01.083 Crankcase



Oem No : 4071300610  
8 680437 014294

### RK.01.017.22 Repair Kit



8 680437 075196

### 01.577 Gasket



8 680437 024224

### RK.01.015 Complete Cylinder Head



Oem No : 0001302419 - 0001302519 - 0001302619  
Knorr No : ZB4187 - ZB4224 - ZB4229

### RK.01.015.20 Complete Cylinder Head

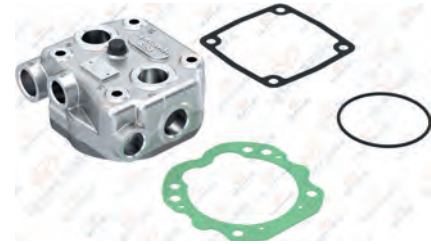

Oem No : 0001302419\* - 0001302519\* - 0001302619\*  
Knorr No : ZB4187\* - ZB4224\* - ZB4229\*

### RK.01.016.20 Valve Plate Kit



8 680437 074816

### RK.01.016 Valve Plate Kit



Oem No : 4021300120 - 4021300320  
8 680437 058441

### RK.01.017 Repair Kit

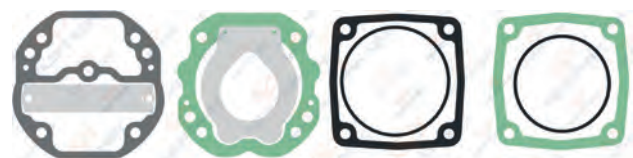

Oem No : 4025865013 - 4021300020 - 4021300220  
8 680437 058458

# MERCEDES

## AIR COMPRESSOR AND REPAIR KIT

**01.069** Cylinder Head



Oem No : 4071310519  
8 680437 076926

**01.020** Crankshaft Flange



Oem No : 4031301645  
8 680437 010081

**01.094** Crankshaft



M18x1.5 Right Hand  
Oem No : 4031310716  
8 680437 014485

**01.121** Valve Plate



8 680437 017660

**01.241** Connecting Rod Bearing Kit



Oem No : 4031310233  
8 680437 019985

**01.006** Connecting Rod



Oem No : 4031302816 - 4031302216  
8 680437 009757

**RK.01.022.00** Piston&Ring (Ø90,00 mm)

- RK.01.022.10 90,25 mm
- RK.01.022.20 90,50 mm
- RK.01.022.30 90,75 mm
- RK.01.022.40 91,00 mm



2,50x2,50x4,00

8 680437 058526

**01.112.00** Piston (Ø90,00 mm)

- 01.112.10 90,25 mm
- 01.112.20 90,50 mm
- 01.112.30 90,75 mm
- 01.112.40 91,00 mm



2,50x2,50x4,00

Oem No : 4031300517  
8 680437 016342

**01.138.00** Ring (Ø90,00 mm)

- 01.138.10 90,25 mm
- 01.138.20 90,50 mm
- 01.138.30 90,75 mm
- 01.138.40 91,00 mm



2,50x2,50x4,00

8 680437 018469

**RK.01.014** Cylinder Liner Set



8 680437 058427

**01.058** Cylinder Liner



8 680437 013198

**01.052** Gear



Oem No : 4661320005  
8 680437 013112

**00.460** Roller Bearing



NUP 306

8 680437 004714

**01.074** Cover



8 680437 014140

**01.075** Cover



8 680437 014157



# Single Cylinder Compressor Ø90 mm - 292 CC - Stroke 46 mm

Application - Vehicle  
MERCEDES MB 407



**01.03.017**

Oem. No.  
4271300515  
4471300515  
4471300715



**01.088** Crankcase



Oem No : 4071300610

**RK.01.063.20** Repair Kit



Oem No : 4421300220

**RK.01.183** Repair Kit



Oem No : 4421300220

**RK.01.059** Complete Cylinder Head



Oem No : 4071300719

**RK.01.059.21** Complete Cylinder Head

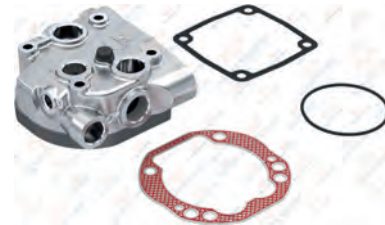

Oem No : 4421300220

**RK.01.061.21** Valve Plate Kit



Oem No : 4421300220

**RK.01.061** Valve Plate Kit



Oem No : 4421300220

**RK.01.063** Repair Kit

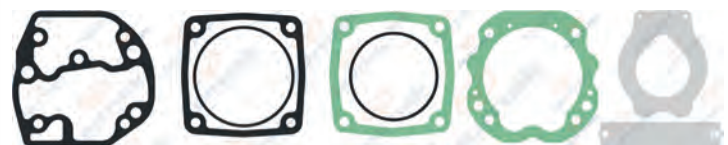

Oem No : 4421300220

# MERCEDES

## AIR COMPRESSOR AND REPAIR KIT

**01.071** Cylinder Head



**Oem No :** 4071300519  
8 680437 014096

**01.020** Crankshaft Flange



**Oem No :** 4031301645  
8 680437 010081

**01.094** Crankshaft



M18x1.5 Right Hand  
**Oem No :** 4031310716  
8 680437 014485

**01.124** Valve Plate



8 680437 018087

**01.005** Connecting Rod



**Oem No :** 4031302816 - 4031302216  
8 680437 009702

**01.006** Connecting Rod



**Oem No :** 4031302816 - 4031302216  
8 680437 009757

**RK.01.022.00** Piston&Ring (Ø90,00 mm)

- RK.01.022.10 90,25 mm
- RK.01.022.20 90,50 mm
- RK.01.022.30 90,75 mm
- RK.01.022.40 91,00 mm



2,50x2,50x4,00

8 680437 058526

**01.112.00** Piston (Ø90,00 mm)

- 01.112.10 90,25 mm
- 01.112.20 90,50 mm
- 01.112.30 90,75 mm
- 01.112.40 91,00 mm



2,50x2,50x4,00

**OEM No :** 4031300517  
8 680437 016342

**01.138.00** Ring (Ø90,00 mm)

- 01.138.10 90,25 mm
- 01.138.20 90,50 mm
- 01.138.30 90,75 mm
- 01.138.40 91,00 mm



2,50x2,50x4,00

8 680437 018469

**RK.01.018** Cylinder Liner Set



8 680437 058489

**01.059** Cylinder Liner



8 680437 013211

**01.052** Gear



**Oem No :** 4661320005  
8 680437 013112

**01.241** Connecting Rod Bearing Kit



**Oem No :** 4031310233  
8 680437 019985

**01.014** Bushing



34X30X20.5  
**Oem No :** 4031310450  
8 680437 010005

**01.028** Screw



M18x1.5 Right Hand  
8 680437 010173

# Single Cylinder Compressor Ø90 mm - 292 CC - Stroke 46 mm

Application - Vehicle  
MERCEDES AXOR OM 457



01.03.022

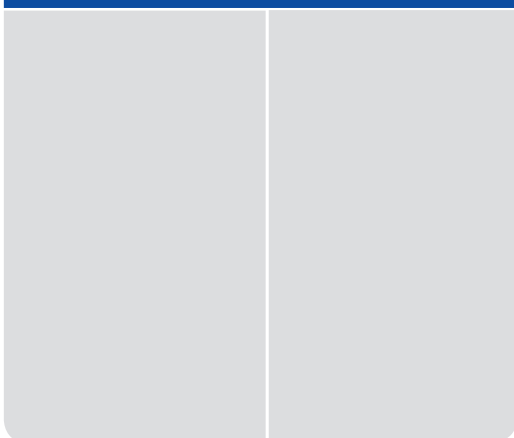

01.087 Crankcase



RK.01.017 Repair Kit

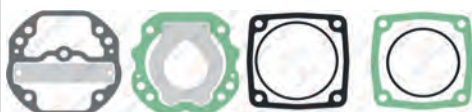

RK.01.017.22 Repair Kit



RK.01.015 Complete Cylinder Head

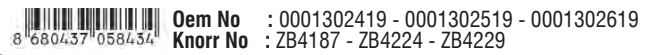

01.069 Cylinder Head



RK.01.016.20 Valve Plate Kit



RK.01.016 Valve Plate Kit



RK.01.017.01 Repair Kit

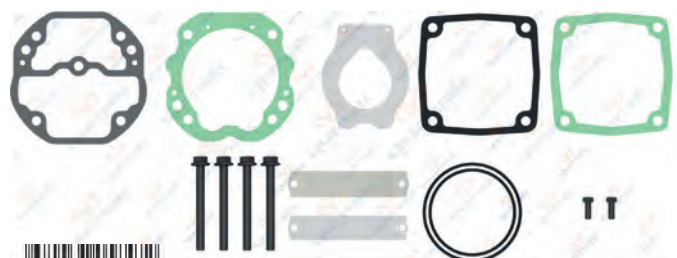



# MERCEDES

## AIR COMPRESSOR AND REPAIR KIT

**01.687** Crankshaft Flange



8 680437 025528

**01.020** Crankshaft Flange



Oem No : 4031301645

**01.093** Crankshaft



M18x1.5 Right Hand



Oem No : 4031311016-4031310616-4031300114-4031311316

**01.121** Valve Plate



8 680437 017660

**01.005** Connecting Rod



injection



Oem No : 4031302816 - 4031302216

**01.006** Connecting Rod



8 680437 009757

**RK.01.022.00** Piston&Ring (Ø90,00 mm)

- RK.01.022.10 90,25 mm
- RK.01.022.20 90,50 mm
- RK.01.022.30 90,75 mm
- RK.01.022.40 91,00 mm



2,50x2,50x4,00



8 680437 058526

**01.112.00** Piston (Ø90,00 mm)

- 01.112.10 90,25 mm
- 01.112.20 90,50 mm
- 01.112.30 90,75 mm
- 01.112.40 91,00 mm



2,50x2,50x4,00



OEM No: 4031300517

**01.138.00** Ring (Ø90,00 mm)

- 01.138.10 90,25 mm
- 01.138.20 90,50 mm
- 01.138.30 90,75 mm
- 01.138.40 91,00 mm



2,50x2,50x4,00



8 680437 018469

**RK.01.014** Cylinder Liner Set



8 680437 058427

**01.058** Cylinder Liner



8 680437 013198

**01.052** Gear



8 680437 013112

Oem No : 4661320005

**01.241** Connecting Rod Bearing Kit



8 680437 019985

Oem No : 4031310233

**01.014** Bushing



34X30X20.5



8 680437 010005

Oem No : 4031310450

**01.028** Screw



M18x1.5 Right Hand



8 680437 010173

## Single Cylinder Compressor Ø90 mm - 292 CC - Stroke 46 mm

Application - Vehicle  
MERCEDES OM 447 / EURO1 / MB 407

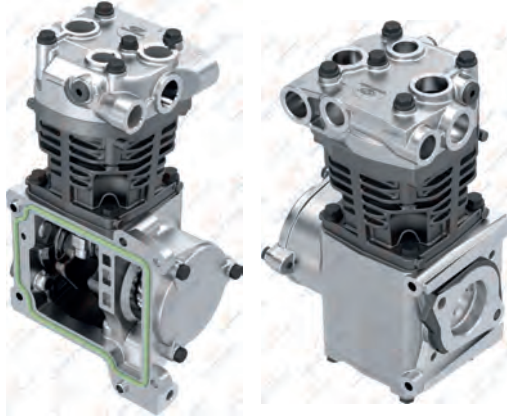

**01.03.026**

Oem. No.  
4071300115



**01.083**

Crankcase



Oem No : 4071300610



**RK.01.062.25**

Repair Kit



Oem No : 4421300720



**RK.01.058**

Complete Cylinder Head



Oem No : 4471300019



**RK.01.058.21**

Complete Cylinder Head



Oem No : 4421300720



**RK.01.060**

Valve Plate Kit



Oem No : 4421300720



**RK.01.062**

Repair Kit



Oem No : 4421300720



**RK.01.062.04**

Repair Kit

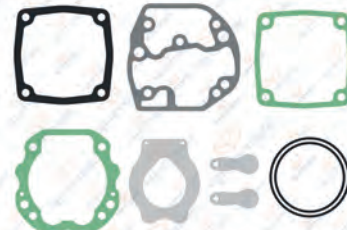

Oem No : 4421300720



Use for old version cylinder repair kit. Yıpranmış kapaklar için.

# MERCEDES

## AIR COMPRESSOR AND REPAIR KIT

**01.071** Cylinder Head

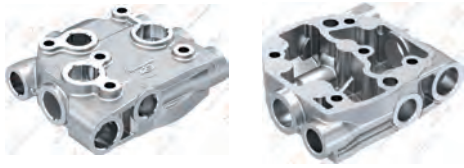

**Oem No :** 4071300519  
 8 680437 014096

**01.020** Crankshaft Flange



**Oem No :** 4031301645  
 8 680437 010081

**01.094** Crankshaft



M18x1.5 Right Hand  
**Oem No :** 4031310716  
 8 680437 014485

**01.123** Valve Plate



8 680437 017967

**01.241** Connecting Rod Bearing Kit



**Oem No :** 4031310233  
 8 680437 019985

**01.006** Connecting Rod



8 680437 009757

**RK.01.022.00** Piston&Ring (Ø90,00 mm)

- RK.01.022.10 90,25 mm
- RK.01.022.20 90,50 mm
- RK.01.022.30 90,75 mm
- RK.01.022.40 91,00 mm



2,50x2,50x4,00

8 680437 058526

**01.112.00** Piston (Ø90,00 mm)

- 01.112.10 90,25 mm
- 01.112.20 90,50 mm
- 01.112.30 90,75 mm
- 01.112.40 91,00 mm



2,50x2,50x4,00

**Oem No :** 4031300517  
 8 680437 016342

**01.138.00** Ring (Ø90,00 mm)

- 01.138.10 90,25 mm
- 01.138.20 90,50 mm
- 01.138.30 90,75 mm
- 01.138.40 91,00 mm



2,50x2,50x4,00

8 680437 018469

**RK.01.014** Cylinder Liner Set



8 680437 058427

**01.058** Cylinder Liner



8 680437 013198

**01.052** Gear



**Oem No :** 4661320005  
 8 680437 013112

**00.460** Roller Bearing



NUP 306

8 680437 004714

**01.074** Cover



8 680437 014140

**01.075** Cover



8 680437 014157



# Single Cylinder Compressor Ø90 mm - 292 CC - Stroke 46 mm

Application - Vehicle  
MERCEDES AXOR OM 457

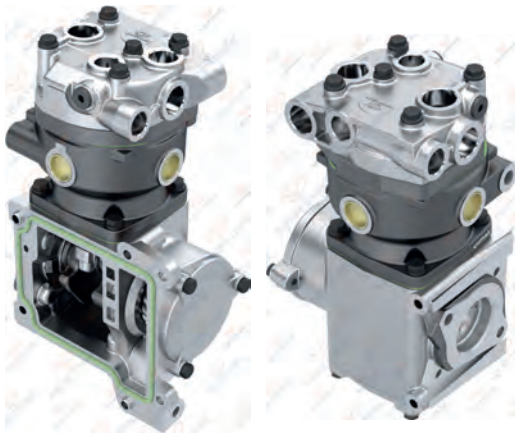

**01.03.030**

Oem. No.  
4071300515



**01.083**

Crankcase



Oem No : 4071300610



**RK.01.062.22**

Repair Kit



**RK.01.058.08**

Complete Cylinder Head



**RK.01.058.20**

Complete Cylinder Head

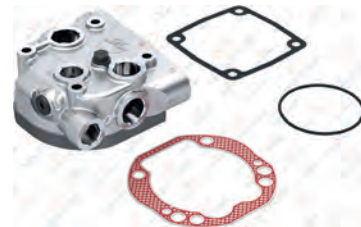

**RK.01.060.21**

Valve Plate Kit



**RK.01.060.05**

Valve Plate Kit

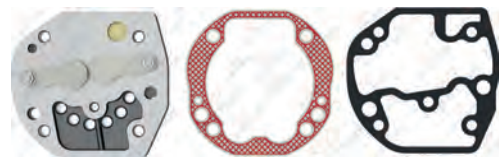

Oem No : 4421300720\*

**RK.01.062.03**

Repair Kit

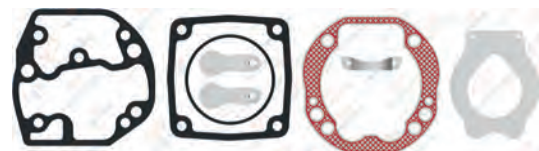

# MERCEDES

## AIR COMPRESSOR AND REPAIR KIT

**01.071** Cylinder Head



Oem No : 4071300519  
8 680437 014096

**01.020** Crankshaft Flange



Oem No : 4031301645  
8 680437 010081

**01.094** Crankshaft



M18x1.5 Right Hand  
Oem No : 4031310716  
8 680437 014485

**01.123** Valve Plate



8 680437 017967

**01.241** Connecting Rod Bearing Kit



Oem No : 4031310233  
8 680437 019985

**01.006** Connecting Rod



8 680437 009757

**RK.01.022.00** Piston&Ring (Ø90,00 mm)

- RK.01.022.10 90,25 mm
- RK.01.022.20 90,50 mm
- RK.01.022.30 90,75 mm
- RK.01.022.40 91,00 mm



2,50x2,50x4,00  
8 680437 058526

**01.112.00** Piston (Ø90,00 mm)

- 01.112.10 90,25 mm
- 01.112.20 90,50 mm
- 01.112.30 90,75 mm
- 01.112.40 91,00 mm



2,50x2,50x4,00  
Oem No : 4031300517  
8 680437 016342

**01.138.00** Ring (Ø90,00 mm)

- 01.138.10 90,25 mm
- 01.138.20 90,50 mm
- 01.138.30 90,75 mm
- 01.138.40 91,00 mm



2,50x2,50x4,00  
8 680437 018469

**RK.01.014** Connecting Rod & Piston



8 680437 058427

**01.058** Cylinder Liner



8 680437 013198

**01.052** Gear



Oem No : 4661320005  
8 680437 013112

**RK.01.280** Repair Kit



8 680437 063339

**01.074** Cover

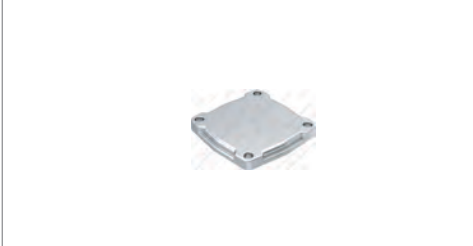

8 680437 014140

**01.075** Cover



8 680437 014157

## Single Cylinder Compressor Ø88 mm - 225 CC - Stroke 37 mm

Application - Vehicle

MERCEDES 814 / 817 / 917 / 1114 / 1314 / 1317  
1520 / 1617 / OM 355 - 362 / OM 366/A/LA



### 01.04.002

Oem. No.	Knorr. No.
0031319701	LK1808
003131970180	187904
0041310101	



8 680437 010753



### 01.314 Crankcase

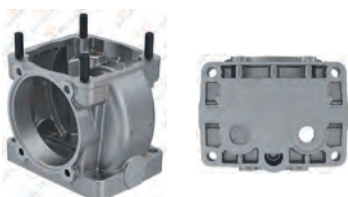

8 680437 020936

### RK.01.033.02 Repair Kit

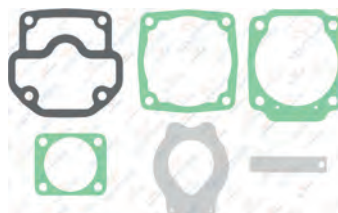

8 680437 058809

### RK.01.146 Complete Cylinder Head



8 680437 061212

### RK.01.146.01 Complete Cylinder Head



8 680437 105732

### RK.01.074.01 Valve Plate Kit



8 680437 078685

### RK.01.074 Valve Plate Kit



8 680437 059608

### RK.01.033.06 Repair Kit

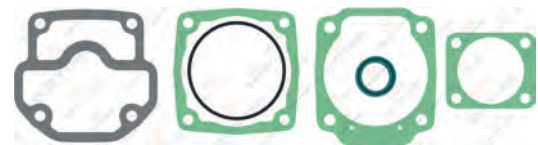

8 680437 078692

### RK.01.033 Repair Kit

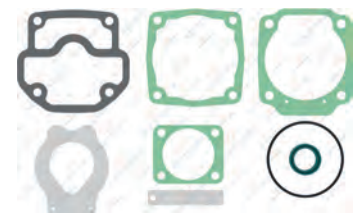

8 680437 058786



# MERCEDES

## AIR COMPRESSOR AND REPAIR KIT

**01.379** Cylinder Head



**01.120** Valve Plate



Oem No : 0001307120  
Knorr No : I138714F004

**01.764** Crankshaft



M18X1.5 Right Hand



Oem No : 0001315916 - 0001316016

**01.013** Bushing



34X30X16



Oem No : 0001313150 - B44935

**01.066** Crankshaft Flange



**01.003** Connecting Rod



Oem No : 0001311817

**RK.01.034.00** Piston&Ring (Ø88,00 mm)

- RK.01.034.10 88,25 mm
- RK.01.034.20 88,50 mm
- RK.01.034.30 88,75 mm
- RK.01.034.40 89,00 mm



2,50x2,50x4,00



Oem No : 0001302517-0001319311

**01.110.00** Piston (Ø88,00 mm)

- 01.110.10 88,25 mm
- 01.110.20 88,50 mm
- 01.110.30 88,75 mm
- 01.110.40 89,00 mm



2,50x2,50x4,00



Oem No : 0001300617

**01.136.00** Ring (Ø88,00 mm)

- 01.136.10 88,25 mm
- 01.136.20 88,50 mm
- 01.136.30 88,75 mm
- 01.136.40 89,00 mm



2,50x2,50x4,00



Oem No : 0011310611

**RK.01.039** Cylinder Liner Set



Knorr No : I808640061

**01.184** Cylinder Liner



**00.140** Roller Bearing



6305



**RK.01.033.03** Repair Kit

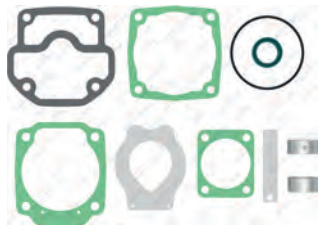

**RK.01.357** Repair Kit



**01.174** Pump Support



## Single Cylinder Compressor Ø88 mm - 225 CC - Stroke 37 mm

Application - Vehicle  
MERCEDES OM 355 / 360A



### 01.04.004

Oem. No.  
0011315401  
0021313601  
0011315201

Knorr No.  
LP1828



### 01.085

Crankcase

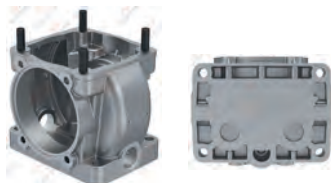

### RK.01.033.02

Repair Kit

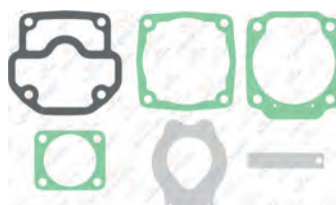

### RK.01.033

Repair Kit

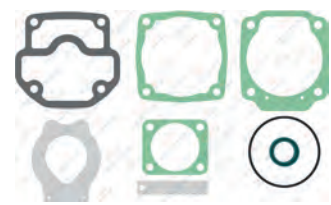

### RK.01.036

Complete Cylinder Head



### RK.01.036.01

Complete Cylinder Head



### RK.01.074.01

Valve Plate Kit



### RK.01.074

Valve Plate Kit



### RK.01.033.01

Repair Kit

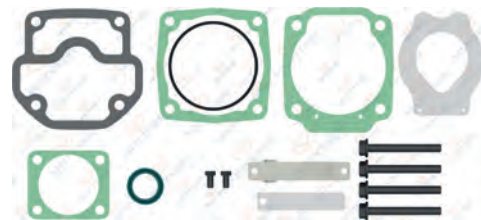

# MERCEDES

## AIR COMPRESSOR AND REPAIR KIT

**01.068** Cylinder Head



**Oem No :** 0001301719  
8 680437 014010

**01.120** Valve Plate



**Oem No :** 0001307120  
**Knorr No :** II38714F004  
8 680437 017509

**01.764** Crankshaft



**M18X1.5 Right Hand**  
**Oem No :** 0001315916 - 0001316016  
8 680437 026327

**01.409** Pump Support



8 680437 022268

**01.066** Crankshaft Flange



8 680437 013976

**01.003** Connecting Rod



**Oem No :** 0001311817  
8 680437 009672

**RK.01.034.00** Piston&Ring (Ø88,00 mm)

- RK.01.034.10** 88,25 mm
- RK.01.034.20** 88,50 mm
- RK.01.034.30** 88,75 mm
- RK.01.034.40** 89,00 mm



**2,50x2,50x4,00**  
**Oem No :** 0001302517-0001319311  
8 680437 058816

**01.110.00** Piston (Ø88,00 mm)

- 01.110.10** 88,25 mm
- 01.110.20** 88,50 mm
- 01.110.30** 88,75 mm
- 01.110.40** 89,00 mm



**2,50x2,50x4,00**  
**Oem No :** 0001300617  
8 680437 015994

**01.136.00** Ring (Ø88,00 mm)

- 01.136.10** 88,25 mm
- 01.136.20** 88,50 mm
- 01.136.30** 88,75 mm
- 01.136.40** 89,00 mm



**2,50x2,50x4,00**  
**Oem No :** 0011310611  
8 680437 018384

**RK.01.039** Cylinder Liner Set



**Knorr No :** I808640061  
8 680437 058939

**01.184** Cylinder Liner



8 680437 019145

**00.140** Roller Bearing



**6305**  
8 680437 001577

**RK.01.033.06** Repair Kit

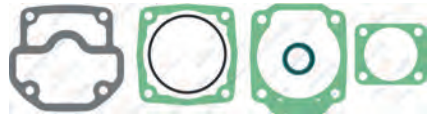

8 680437 078692

**RK.01.357** Repair Kit



8 680437 064305

**01.143** Nut



**M18x1.5 Right Hand - Sağ Diş**  
8 680437 018735



## Single Cylinder Compressor Ø88 mm - 225 CC - Stroke 37 mm

Application - Vehicle  
MERCEDES - DAIMLER SPRINTER 212D  
DAIMLER 1924 L



### 01.04.013

Oem. No.	Knorr. No.
0031315901	LK1802
003131590180	180864
0041310301	
0011315201	



### 01.085 Crankcase

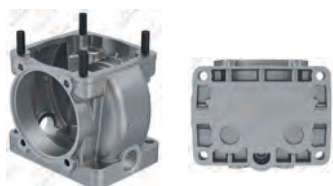

### RK.01.033.02 Repair Kit

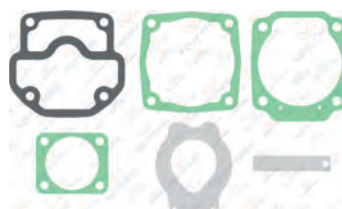

### RK.01.033 Repair Kit

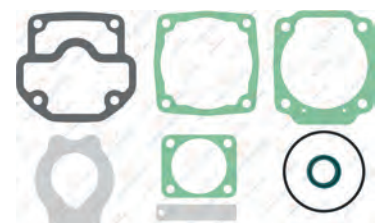

### RK.01.036 Complete Cylinder Head



### RK.01.036.01 Complete Cylinder Head

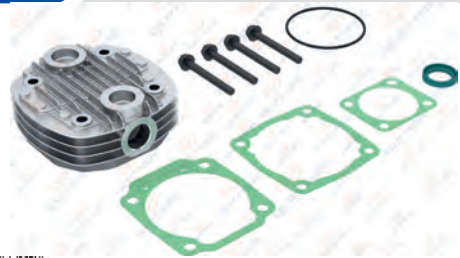

### RK.01.074.01 Valve Plate Kit



### RK.01.074 Valve Plate Kit



### RK.01.033.01 Repair Kit

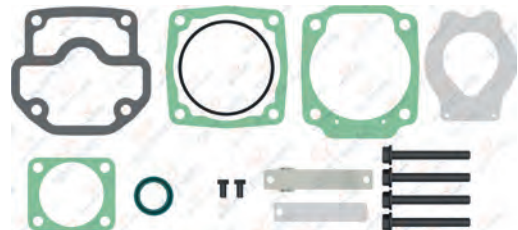

# MERCEDES

## AIR COMPRESSOR AND REPAIR KIT

**01.068** Cylinder Head



**Oem No :** 0001301719  
 8 680437 014010

**01.120** Valve Plate



**Oem No :** 0001307120  
**Knorr No :** II38714F004  
 8 680437 017509

**01.188** Crankshaft



**M18X1.5 Right Hand**  
**Oem No :** 0001314616  
 8 680437 019251

**01.409** Pump Support



8 680437 022268

**01.194** Crankshaft Flange



8 680437 019398

**01.003** Connecting Rod



**Oem No :** 0001311817  
 8 680437 009672

**RK.01.034.00** Piston&Ring (Ø88,00 mm)

- RK.01.034.10 88,25 mm
- RK.01.034.20 88,50 mm
- RK.01.034.30 88,75 mm
- RK.01.034.40 89,00 mm



2,50x2,50x4,00  
**Oem No :** 0001302517-0001319311  
 8 680437 058816

**01.110.00** Piston (Ø88,00 mm)

- 01.110.10 88,25 mm
- 01.110.20 88,50 mm
- 01.110.30 88,75 mm
- 01.110.40 89,00 mm



2,50x2,50x4,00  
**Oem No :** 0001300617  
 8 680437 015994

**01.136.00** Ring (Ø88,00 mm)

- 01.136.10 88,25 mm
- 01.136.20 88,50 mm
- 01.136.30 88,75 mm
- 01.136.40 89,00 mm



2,50x2,50x4,00  
**Oem No :** 0011310611  
 8 680437 018384

**RK.01.039** Cylinder Liner Set



**Knorr No :** I808640061  
 8 680437 058939

**01.184** Cylinder Liner



8 680437 019145

**01.195** Bushing



34X30X16  
 8 680437 019411

**RK.01.033.06** Repair Kit

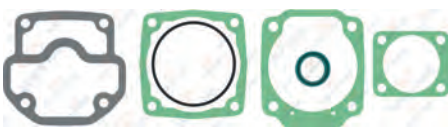

8 680437 078692

**RK.01.357** Repair Kit



8 680437 064305

**01.013** Bushing



34X30X16  
**Oem No :** 0001313150 - B44935  
 8 680437 009993

## Single Cylinder Compressor Ø88 mm - 225 CC - Stroke 37 mm

Application - Vehicle  
MERCEDES OM 355 / OM 360



**01.04.014**

Knorr No.  
LK1811  
I94362



8 680437 010876



**01.314**

Crankcase

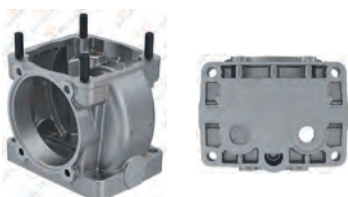

8 680437 020936

**RK.01.033.02**

Repair Kit



8 680437 058809

**RK.01.033**

Repair Kit

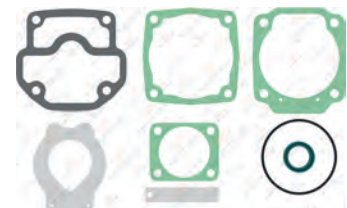

8 680437 058786

**RK.01.146**

Complete Cylinder Head



8 680437 061212

**RK.01.146.01**

Complete Cylinder Head



8 680437 105732

**RK.01.074.01**

Valve Plate Kit



8 680437 078685

**RK.01.074**

Valve Plate Kit



8 680437 059608

**RK.01.033.06**

Repair Kit

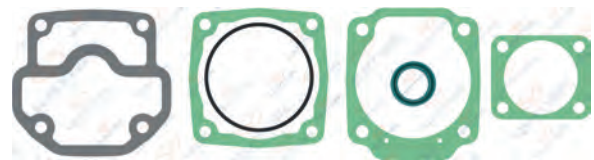

8 680437 078692



# MERCEDES

## AIR COMPRESSOR AND REPAIR KIT

**01.379** Cylinder Head



**01.120** Valve Plate



Oem No : 0001307120  
Knorr No : II38714F004

**01.188** Crankshaft



M18X1.5 Right Hand



Oem No : 0001314616

**01.174** Pump Support



**01.194** Crankshaft Flange



**01.003** Connecting Rod



Oem No : 0001311817 - 0001301916  
0001312617

**RK.01.034.00** Piston&Ring (Ø88,00 mm)

- RK.01.034.10 88,25 mm
- RK.01.034.20 88,50 mm
- RK.01.034.30 88,75 mm
- RK.01.034.40 89,00 mm



2,50x2,50x4,00



Oem No : 0001302517-0001319311

**01.110.00** Piston (Ø88,00 mm)

- 01.110.10 88,25 mm
- 01.110.20 88,50 mm
- 01.110.30 88,75 mm
- 01.110.40 89,00 mm



2,50x2,50x4,00



Oem No : 0001300617

**01.136.00** Ring (Ø88,00 mm)

- 01.136.10 88,25 mm
- 01.136.20 88,50 mm
- 01.136.30 88,75 mm
- 01.136.40 89,00 mm



2,50x2,50x4,00



Oem No : 0011310611

**RK.01.039** Cylinder Liner Set



Knorr No : I808640061

**01.184** Cylinder Liner



**01.195** Bushing



34X30X16



**RK.01.033.03** Repair Kit

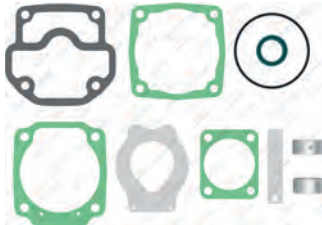

**RK.01.357** Repair Kit



**01.013** Bushing



34X30X16



Oem No : 0001313150 - B44935

## Twin Cylinder Compressor Ø86 mm - 720 CC - Stroke 62 mm

Application - Vehicle  
MERCEDES - AROCS EURO6  
OM471 LA  
OM473 LA



**01.04.112**

Oem. No.  
4711303715  
A47113037150001

Knorr No.  
LK4972  
K066254N00



**01.1168** Crankcase



**RK.01.571**

Complete Cylinder Head



**RK.01.667**

Valve Plate Kit

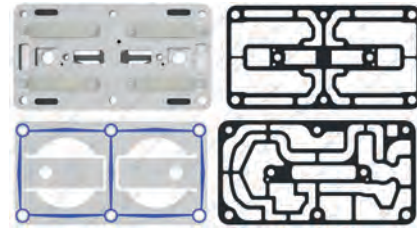

**RK.01.668.01**

Repair Kit

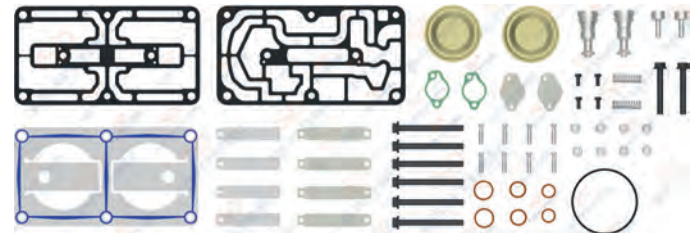

**RK.01.668**

Repair Kit

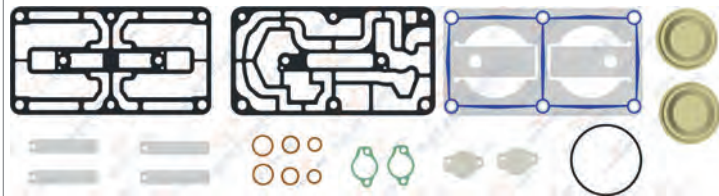

**RK.01.668.04**

Repair Kit

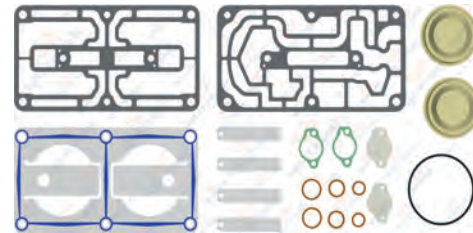

Use for old version cylinder repair kit. Yıpranmış kapaklar için.

**RK.01.558**

Repair Kit

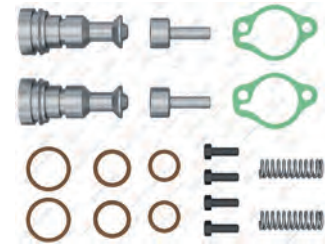

# MERCEDES

## AIR COMPRESSOR AND REPAIR KIT

01.1169

Cylinder Head



01.1144

Valve Plate



01.1166

Crankshaft



01.1170

Cooling Plate



01.1167

Crankshaft Flange



01.1165

Connecting Rod



RK.01.272.00

Piston&Ring (Ø86,00 mm)

RK.01.272.10 86,25 mm

RK.01.272.20 86,50 mm

RK.01.272.30 86,75 mm

RK.01.272.40 87,00 mm



01.868.00

Piston (Ø86,00 mm)

01.868.10 86,25 mm

01.868.20 86,50 mm

01.868.30 86,75 mm

01.868.40 87,00 mm



01.869.00

Ring (Ø86,00 mm)

01.869.10 86,25 mm

01.869.20 86,50 mm

01.869.30 86,75 mm

01.869.40 87,00 mm



01.1171

Gear





## Single Cylinder Compressor Ø92 mm - 360 CC - Stroke 54 mm

Application - Vehicle  
MERCEDES OM 472



### 01.04.122

Oem. No.  
4721300515  
4721300815



**RK.01.614.05** Repair Kit



**RK.01.614.03** Repair Kit

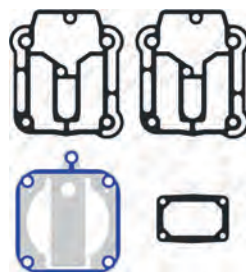

**01.1213**

Valve Plate



**RK.01.611**

Valve Plate Kit

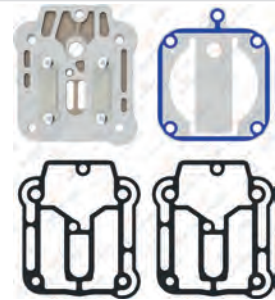

**RK.01.614.01**

Repair Kit

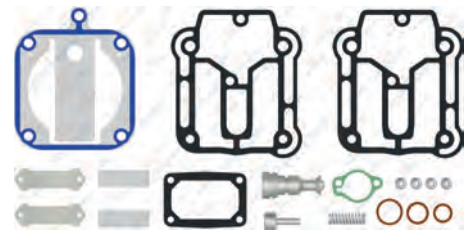

**RK.01.614**

Repair Kit

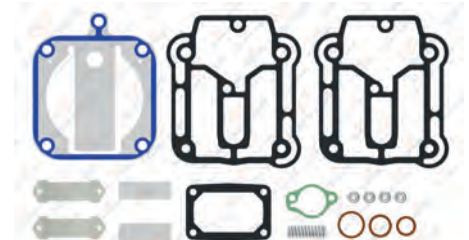

# MERCEDES

## AIR COMPRESSOR AND REPAIR KIT

### RK.01.318.00 Piston&Ring (Ø92,00 mm)

- RK.01.318.10 92,25 mm
- RK.01.318.20 92,50 mm
- RK.01.318.30 92,75 mm
- RK.01.318.40 93,00 mm



2,50x2,50x4,00

Knorr No : K006026



### 01.862.00 Piston (Ø92,00 mm)

- 01.862.10 92,25 mm
- 01.862.20 92,50 mm
- 01.862.30 92,75 mm
- 01.862.40 93,00 mm



2,50x2,50x4,00



### 01.942.00 Ring (Ø92,00 mm)

- 01.942.10 92,25 mm
- 01.942.20 92,50 mm
- 01.942.30 92,75 mm
- 01.942.40 93,00 mm



2,50x2,50x4,00



## Single Cylinder Compressor Ø75 mm - 155 CC - Stroke 35 mm

**Application - Vehicle**  
MERCEDES OM 355/OM 362/OM 366  
LA8.09 - 9.14 - 15.20 - 1314



### 01.05.002

Oem. No.	Knorr No.
0041310501	LK1511 - I83539
0041315801	LK1527 - I88770
0041311901	LK1532
0031316301	LK1550 - I99942
0031314801	



### 01.314 Crankcase



### RK.01.046.01 Repair Kit

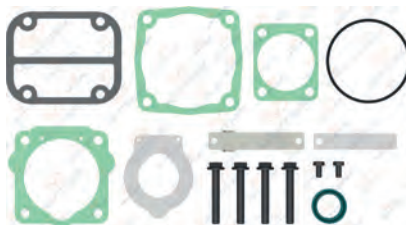

### RK.01.046 Repair Kit

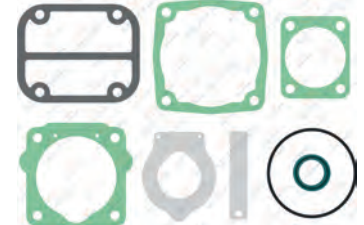

### RK.01.048 Complete Cylinder Head



Knorr No : STW63841

### RK.01.048.20 Complete Cylinder Head



### 01.067 Cylinder Head



### RK.01.047.20 Repair Kit

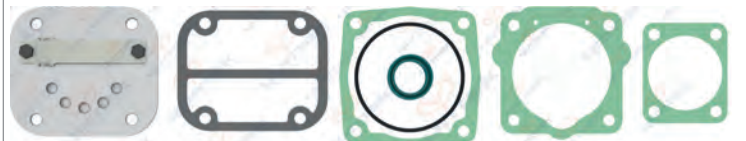

### RK.01.047 Valve Plate Kit



Oem No : 0001304920  
Knorr No : II3871F004



# MERCEDES

## AIR COMPRESSOR AND REPAIR KIT

**RK.01.046.02** Repair Kit

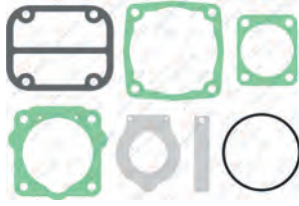

8 680437 072843

**RK.01.046.21** Repair Kit

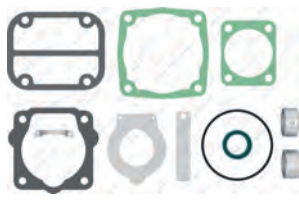

8 680437 120766

**01.089** Crankshaft



M18x1.5 Right Hand



8 680437 014386

**01.119** Valve Plate



8 680437 017387

Knorr No : II38717F004

**01.066** Crankshaft Flange



8 680437 013976

**01.003** Connecting Rod



8 680437 009672

Oem No : 0001311817 - 0001301916  
0001312617

**RK.01.073.00** Piston&Ring (Ø75,00 mm)

- RK.01.073.10 75,25 mm
- RK.01.073.20 75,50 mm
- RK.01.073.30 75,75 mm
- RK.01.073.40 76,00 mm



2,00x2,00x4,00



8 680437 059547

**01.193.00** Piston (Ø75,00 mm)

- 01.193.10 75,25 mm
- 01.193.20 75,50 mm
- 01.193.30 75,75 mm
- 01.193.40 76,00 mm



2,00x2,00x4,00



8 680437 019336

**01.134.00** Ring (Ø75,00 mm)

- 01.134.10 75,25 mm
- 01.134.20 75,50 mm
- 01.134.30 75,75 mm
- 01.134.40 76,00 mm



2,00x2,00x4,00



8 680437 018278

**RK.01.045** Cylinder Liner Set



8 680437 059004

Knorr No : I77246

**01.056** Cylinder Liner



8 680437 013174

**01.013** Bushing



34X30X16



8 680437 009993

Oem No : 0001313150 - B44935

**RK.01.316** Repair Kit



8 680437 063759

**01.143** Nut



M18x1.5 Right Hand



8 680437 018735

**01.174** Pump Support



8 680437 019046

## Single Cylinder Compressor Ø75 mm - 155 CC - Stroke 35 mm

Application - Vehicle  
MERCEDES OM 362 LA



**01.05.064**

Oem. No.

Knorr No.

LK1551  
II14575



**01.314**

Crankcase



**RK.01.046.01**

Repair Kit

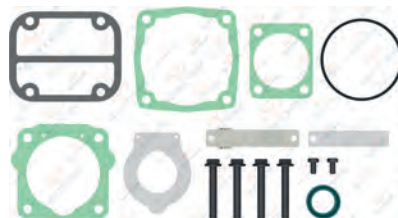

**RK.01.046**

Repair Kit

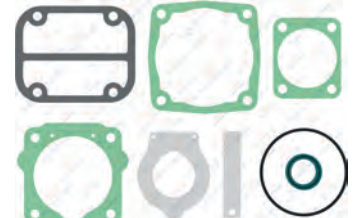

**RK.01.048**

Complete Cylinder Head



Knorr No : STW63841

**RK.01.048.20**

Complete Cylinder Head



**01.067**

Cylinder Head



**RK.01.047.20**

Valve Plate Kit

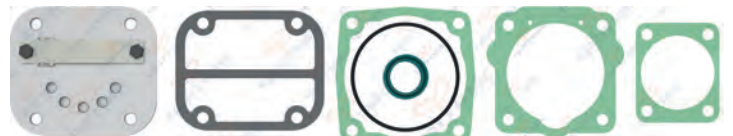

**RK.01.047**

Valve Plate Kit



Oem No : 0001304920  
Knorr No : II3871F004

# MERCEDES

## AIR COMPRESSOR AND REPAIR KIT

**RK.01.046.02** Repair Kit

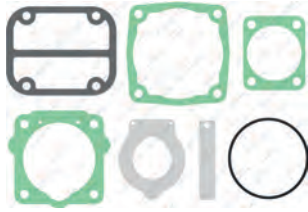

**RK.01.046.21** Repair Kit

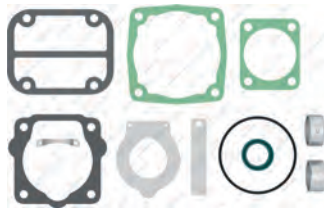

**01.206** Crankshaft



M18x1.5 Right Hand



**01.119** Valve Plate



Knorr No : II38717F004

**01.194** Crankshaft Flange



**01.003** Connecting Rod



Oem No : 0001311817 - 0001301916  
0001312617

**RK.01.073.00** Piston&Ring (Ø75,00 mm)

- RK.01.073.10 75,25 mm
- RK.01.073.20 75,50 mm
- RK.01.073.30 75,75 mm
- RK.01.073.40 76,00 mm



2,00x2,00x4,00



**01.193.00** Piston (Ø75,00 mm)

- 01.193.10 75,25 mm
- 01.193.20 75,50 mm
- 01.193.30 75,75 mm
- 01.193.40 76,00 mm



2,00x2,00x4,00



**01.134.00** Ring (Ø75,00 mm)

- 01.134.10 75,25 mm
- 01.134.20 75,50 mm
- 01.134.30 75,75 mm
- 01.134.40 76,00 mm



2,00x2,00x4,00



**RK.01.045** Cylinder Liner Set



Knorr No : I77246

**01.056** Cylinder Liner



**01.013** Bushing



34X30X16



Oem No : 0001313150 - B44935

**01.174** Pump Support



**01.143** Nut



M18x1.5 Right Hand



**01.195** Bushing



34X30X16





## Single Cylinder Compressor Ø90 mm - 229 CC - Stroke 36 mm

Application - Vehicle  
MERCEDES



### 01.05.116

Oem. No.	Wabco No.
0041310101	4111428160
0041315901	4111428180
0031319701	4111428190
0051311601	



### 01.1251 Crankcase



### RK.01.224.02 Repair Kit

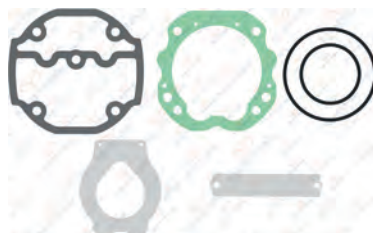

### RK.01.634 Complete Cylinder Head



### RK.01.634.10 Complete Cylinder Head



### RK.01.440 Valve Plate Kit



Wabco No : 4111429242

### RK.01.224.01 Repair Kit



### RK.01.224 Repair Kit



# MERCEDES

## AIR COMPRESSOR AND REPAIR KIT

**01.1256** Cylinder Head



8 680437 100201

**01.1256.10** Cylinder Head



8 680437 100188

**01.1254** Crankshaft



M18x1.5 Right Hand



8 680437 076759

**01.689** Valve Plate



8 680437 025542

**01.234** Crankshaft Flange



8 680437 019916

**01.230.10** Connecting Rod



8 680437 072522

**RK.01.635.00** Piston&Ring (Ø90,00 mm)

- RK.01.635.10 90,25 mm
- RK.01.635.20 90,50 mm
- RK.01.635.30 90,75 mm
- RK.01.635.40 91,00 mm



2,50x2,50x4,00



8 680437 074526

**01.1255.00** Piston (Ø90,00 mm)

- 01.1255.10 90,25 mm
- 01.1255.20 90,50 mm
- 01.1255.30 90,75 mm
- 01.1255.40 91,00 mm



2,50x2,50x4,00



8 680437 077053

**01.138.00** Ring (Ø90,00 mm)

- 01.138.10 90,25 mm
- 01.138.20 90,50 mm
- 01.138.30 90,75 mm
- 01.138.40 91,00 mm



2,50x2,50x4,00



8 680437 018469

**01.073** Cover



8 680437 014133

**01.437** Bushing



39X35X20



8 680437 022589

**01.143** Nut



M18x1.5 Right Hand



8 680437 018735

## Single Cylinder Compressor Ø75 mm - 160 CC - Stroke 36 mm

Application - Vehicle  
MERCEDES UNIMOG



**01.05.012**

Oem. No.

Wabco No.  
4111410000



**01.235**

Crankcase



**RK.01.087.20**

Repair Kit

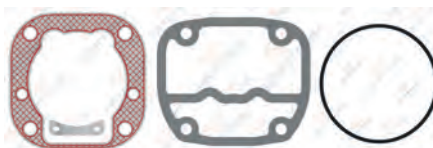

**RK.01.087.21**

Repair Kit

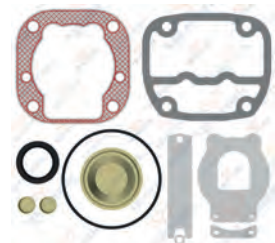

**RK.01.084**

Complete Cylinder Head



Wabco No : 4111419262

**RK.01.085**

Valve Plate Kit



**RK.01.087.01**

Repair Kit



**RK.01.087**

Repair Kit



**RK.01.087.02**

Repair Kit





# MERCEDES

## AIR COMPRESSOR AND REPAIR KIT

**01.229** Cylinder Head



8 680437 019862

**01.909** Valve Plate



8 680437 028253

**01.1254** Crankshaft



M18x1.5 Right Hand

8 680437 076759

**01.437** Bushing



39X35X20

8 680437 022589

**01.234** Crankshaft Flange



Wabco No : 4111419232

8 680437 019916

**01.230** Connecting Rod



8 680437 072935

**RK.01.118.00** Piston&Ring (Ø75,00 mm)

RK.01.118.10	75,25 mm
RK.01.118.20	75,50 mm
RK.01.118.30	75,75 mm
RK.01.118.40	76,00 mm



2,00x2,00x4,00

Wabco No : 4111416232 - 4115226202

8 680437 060482

**01.911.00** Piston (Ø75,00 mm)

01.911.10	75,25 mm
01.911.20	75,50 mm
01.911.30	75,75 mm
01.911.40	76,00 mm



2,00x2,00x4,00

8 680437 028277

**01.134.00** Ring (Ø75,00 mm)

01.134.10	75,25 mm
01.134.20	75,50 mm
01.134.30	75,75 mm
01.134.40	76,00 mm



2,00x2,00x4,00

8 680437 018278

**RK.01.087.22** Repair Kit



8 680437 120933

**RK.01.087.05** Repair Kit

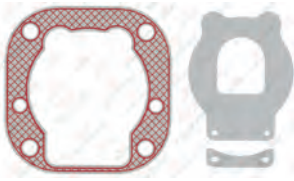

8 680437 128434

**01.515** Cover



8 680437 116165

## Twin Cylinder Compressor Ø92 / Ø60 - 490 CC - Stroke 60/30 mm

Application - Vehicle  
MERCEDES OM 457 EURO 5

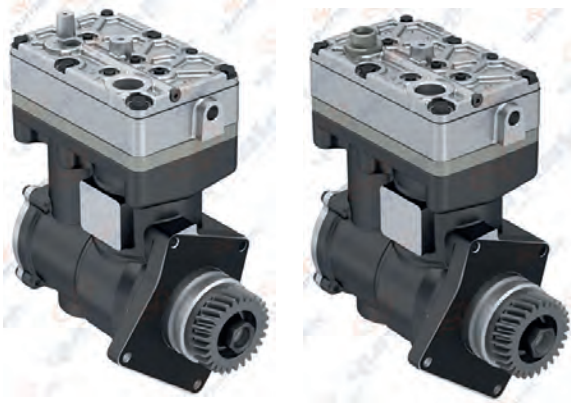

01.04.173  
For Truck

01.04.175  
For Bus

### 01.04.173 - 01.04.175

Oem. No.	Voith No.
(01.04.173) 4571306215	LP490 149.00056411 14900056411
(01.04.175) 0009257710 4571306315	



### 01.1657 Crankcase



### RK.01.537.02 Repair Kit



### RK.01.538 Complete Cylinder Head (01.04.173)



For Truck



OEM No : 0011309615

### RK.01.538.10 Complete Cylinder Head (01.04.175)



For Bus



OEM No : 0011308815

### RK.01.734 Valve Plate Kit



### RK.01.537.01 Repair Kit

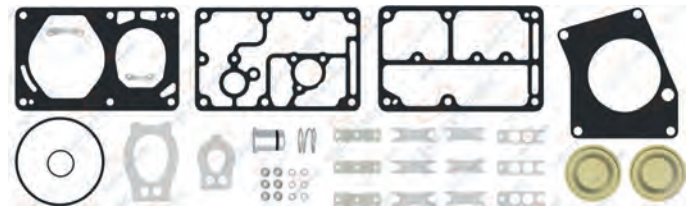

### RK.01.537 Repair Kit

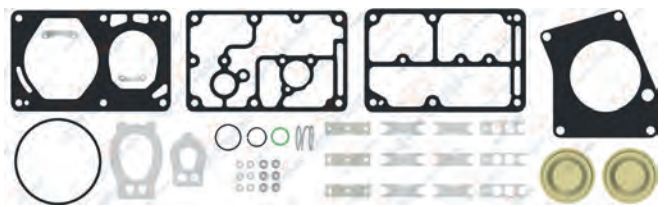

### RK.01.537.03 Repair Kit

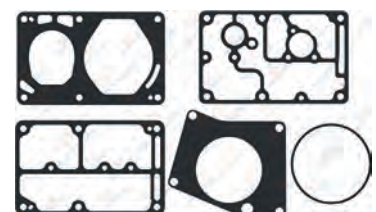

# MERCEDES

## AIR COMPRESSOR AND REPAIR KIT

**01.1539** Cylinder Head



For Truck



OEM No : 14900024020 - 14900024021

**01.1540** Cooling Plate

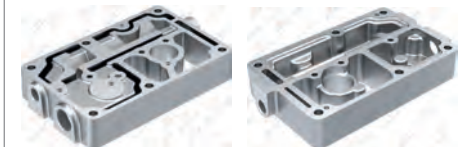

For Truck



OEM No : 14900023910

**01.1541** Valve Plate



**01.1539.10** Cylinder Head



For Bus



**01.1540.10** Cooling Plate



For Bus



**01.1584** Connector



**RK.01.735.00** Piston&Ring (Ø92,00 mm)

- RK.01.735.10 92,25 mm
- RK.01.735.20 92,50 mm
- RK.01.735.30 92,75 mm
- RK.01.735.40 93,00 mm



2,50x2,50x3,00



**01.1572.00** Piston (Ø92,00 mm)

- 01.1572.10 92,25 mm
- 01.1572.20 92,50 mm
- 01.1572.30 92,75 mm
- 01.1572.40 93,00 mm



2,50x2,50x3,00



OEM No : 149000305

**01.1573.00** Ring (Ø92,00 mm)

- 01.1573.10 92,25 mm
- 01.1573.20 92,50 mm
- 01.1573.30 92,75 mm
- 01.1573.40 93,00 mm



2,50x2,50x3,00



**RK.01.737.00** Piston&Ring (Ø60,00 mm)

- RK.01.737.10 60,25 mm
- RK.01.737.20 60,50 mm
- RK.01.737.30 60,75 mm
- RK.01.737.40 61,00 mm



2,00x2,00x3,00



**01.1575.00** Piston (Ø60,00 mm)

- 01.1575.10 60,25 mm
- 01.1575.20 60,50 mm
- 01.1575.30 60,75 mm
- 01.1575.40 61,00 mm



2,00x2,00x3,00



OEM No : 14900025920

**01.1576.00** Ring (Ø60,00 mm)

- 01.1576.10 60,25 mm
- 01.1576.20 60,50 mm
- 01.1576.30 60,75 mm
- 01.1576.40 61,00 mm



2,00x2,00x3,00



**RK.01.736** Cyl.Liner Set (Ø92,00 mm)



**01.1574** Cylinder Liner(Ø92,00 mm)



**01.1699** Crankshaft



M24x3 Left Hand



OEM No : 14900013011

**RK.01.738** Cyl.Liner Set (Ø60,00 mm)



**01.1577** Cylinder Liner(Ø60,00 mm)



**01.1711** Gear



OEM No : 14900000611



## Twin Cylinder Compressor Ø92 / Ø60 - 490 CC - Stroke 60/30 mm

Application - Vehicle  
MERCEDES ACTROS EURO6  
OM471 LA, OM473 LA

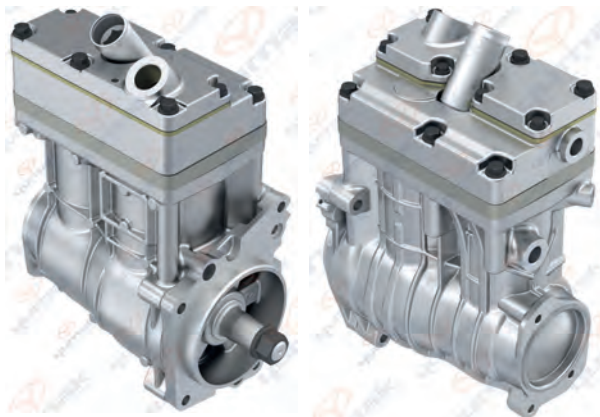

**01.04.199**

**Oem. No.**

4711304215  
4711304015  
4711303215  
4711303415  
0011306415

**Voith No.**

LP490



8 680437 137436



**01.1795**

Crankcase



8 680437 140535

**RK.01.854**

Complete Cylinder Head



8 680437 161486

**RK.01.853**

Valve Plate Kit

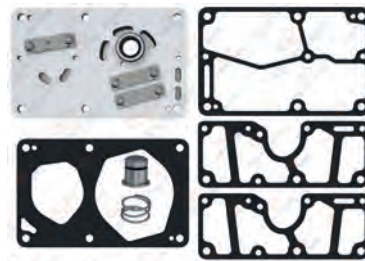

8 680437 161479

**RK.01.855**

Repair Kit

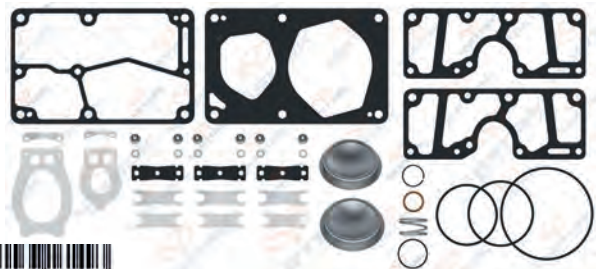

8 680437 161493

**RK.01.855.01**

Repair Kit

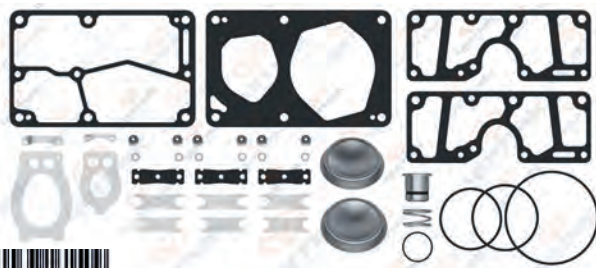

8 680437 161509

**RK.01.855.03**

Repair Kit

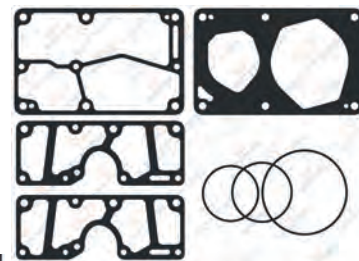

8 680437 163916

# MERCEDES

## AIR COMPRESSOR AND REPAIR KIT

**01.1799** Cylinder Head



**01.1798** Cooling Plate



**01.1800** Valve Plate



**01.1796** Crankshaft



**01.1813** Crankshaft Flange



**01.1171** Gear



OEM No : 4721320305

**RK.01.735.00** Piston&Ring (Ø92,00 mm)

- RK.01.735.10 92,25 mm
- RK.01.735.20 92,50 mm
- RK.01.735.30 92,75 mm
- RK.01.735.40 93,00 mm



2,50x2,50x3,00



**01.1572.00** Piston (Ø92,00 mm)

- 01.1572.10 92,25 mm
- 01.1572.20 92,50 mm
- 01.1572.30 92,75 mm
- 01.1572.40 93,00 mm



2,50x2,50x3,00



OEM No : 149000305

**01.1573.00** Ring (Ø92,00 mm)

- 01.1573.10 92,25 mm
- 01.1573.20 92,50 mm
- 01.1573.30 92,75 mm
- 01.1573.40 93,00 mm



2,50x2,50x3,00



**RK.01.737.00** Piston&Ring (Ø60,00 mm)

- RK.01.737.10 60,25 mm
- RK.01.737.20 60,50 mm
- RK.01.737.30 60,75 mm
- RK.01.737.40 61,00 mm



2,00x2,00x3,00



**01.1575.00** Piston (Ø60,00 mm)

- 01.1575.10 60,25 mm
- 01.1575.20 60,50 mm
- 01.1575.30 60,75 mm
- 01.1575.40 61,00 mm



2,00x2,00x3,00



OEM No : 14900025920

**01.1576.00** Ring (Ø60,00 mm)

- 01.1576.10 60,25 mm
- 01.1576.20 60,50 mm
- 01.1576.30 60,75 mm
- 01.1576.40 61,00 mm



2,00x2,00x3,00



**RK.01.861** Cyl.Liner Set (Ø60,00 mm)



**01.1801** Cylinder Liner(Ø60,00 mm)



**01.1700** Connecting Rod



**RK.01.862** Cyl.Liner Set (Ø92,00 mm)



**01.1802** Cylinder Liner(Ø92,00 mm)



**01.1701** Connecting Rod





## Twin Cylinder Compressor Ø92 / Ø60 - 490 CC - Stroke 60/30 mm

Application - Vehicle

MERCEDES OM470 LA EURO6  
TRAVEGO EURO 6 - TOURISMO RH EURO 6  
TRAVEGO M,L EURO 6 - INTEGRO L EURO 6



**01.04.200**

Oem. No.  
4701302015

Voith No.  
LP490



8 680437 137436



**01.1795**

Crankcase



8 680437 140535

**RK.01.854**

Complete Cylinder Head



8 680437 161486

**RK.01.853**

Valve Plate Kit

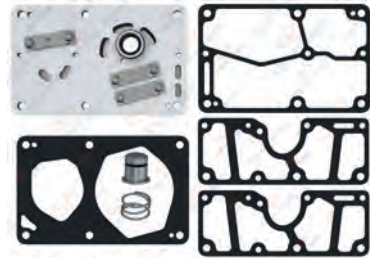

8 680437 161479

**RK.01.855**

Repair Kit

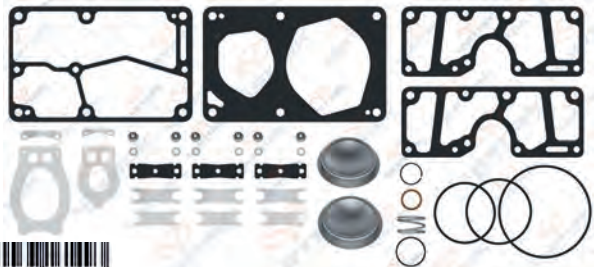

8 680437 161493

**RK.01.855.01**

Repair Kit

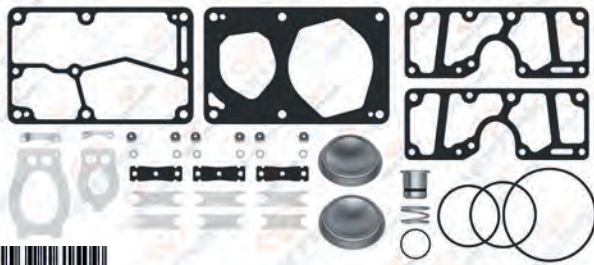

8 680437 161509

**RK.01.855.03**

Repair Kit

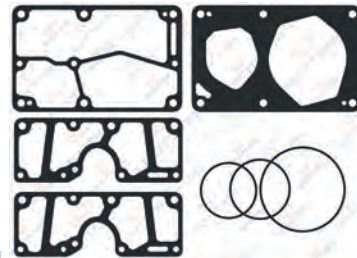

8 680437 163916



# MERCEDES

## AIR COMPRESSOR AND REPAIR KIT

**01.1799** Cylinder Head



**01.1798** Cooling Plate



**01.1800** Valve Plate



**01.1796.10** Crankshaft



**01.1813** Crankshaft Flange



**01.1873** Gear



OEM No : 4701320105

**RK.01.735.00** Piston&Ring (Ø92,00 mm)

- RK.01.735.10 92,25 mm
- RK.01.735.20 92,50 mm
- RK.01.735.30 92,75 mm
- RK.01.735.40 93,00 mm



2,50x2,50x3,00



**01.1572.00** Piston (Ø92,00 mm)

- 01.1572.10 92,25 mm
- 01.1572.20 92,50 mm
- 01.1572.30 92,75 mm
- 01.1572.40 93,00 mm



2,50x2,50x3,00



OEM No : 149000305

**01.1573.00** Ring (Ø92,00 mm)

- 01.1573.10 92,25 mm
- 01.1573.20 92,50 mm
- 01.1573.30 92,75 mm
- 01.1573.40 93,00 mm



2,50x2,50x3,00



**RK.01.737.00** Piston&Ring (Ø60,00 mm)

- RK.01.737.10 60,25 mm
- RK.01.737.20 60,50 mm
- RK.01.737.30 60,75 mm
- RK.01.737.40 61,00 mm



2,00x2,00x3,00



**01.1575.00** Piston (Ø60,00 mm)

- 01.1575.10 60,25 mm
- 01.1575.20 60,50 mm
- 01.1575.30 60,75 mm
- 01.1575.40 61,00 mm



2,00x2,00x3,00



OEM No : 14900025920

**01.1576.00** Ring (Ø60,00 mm)

- 01.1576.10 60,25 mm
- 01.1576.20 60,50 mm
- 01.1576.30 60,75 mm
- 01.1576.40 61,00 mm



2,00x2,00x3,00



**RK.01.861** Cyl.Liner Set (Ø60,00 mm)



**01.1801** Cylinder Liner(Ø60,00 mm)



**01.1700** Connecting Rod



**RK.01.862** Cyl.Liner Set (Ø92,00 mm)



**01.1802** Cylinder Liner(Ø92,00 mm)



**01.1701** Connecting Rod



## Single Cylinder Compressor Ø100 - 393 CC - Stroke 50 mm

Application - Vehicle  
MERCEDES AROCS EURO6  
OM934, OM936

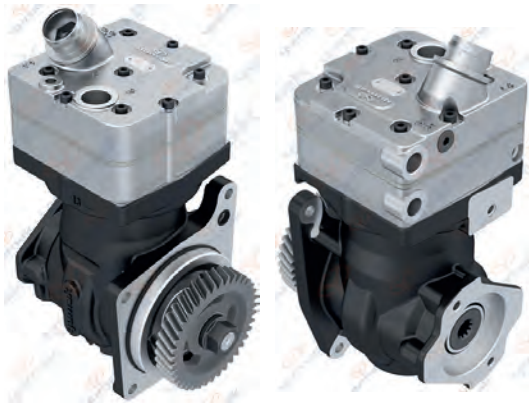

**01.01.017**

Oem. No.  
9361301215  
0011307615

Wabco No.  
9122100000

**01.01.017.10**

Without gear



**01.1880**

Crankcase



**RK.01.863**

Complete Cylinder Head



**RK.01.864.05**

Repair Kit

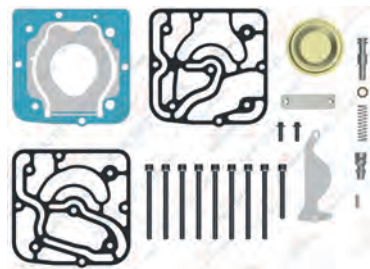

**RK.01.864.02**

Repair Kit

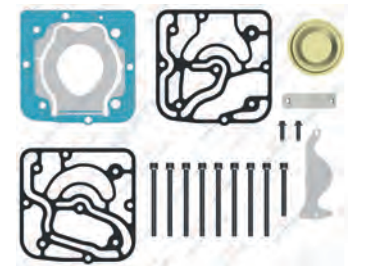

**RK.01.864**

Repair Kit

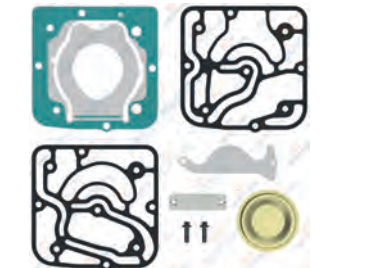

# MERCEDES

## AIR COMPRESSOR AND REPAIR KIT

**01.1874** Cylinder Head



**01.1875** Valve Plate



**01.1881** Crankshaft



**01.1876** Cooling Plate



**01.878** Bushing



**01.1917** Connecting Rod



**RK.01.866.00** Piston&Ring (Ø100,00 mm)

- RK.01.866.10 100,25 mm
- RK.01.866.20 100,50 mm
- RK.01.866.30 100,75 mm
- RK.01.866.40 101,00 mm



**01.1885.00** Piston (Ø100,00 mm)

- 01.1885.10 100,25 mm
- 01.1885.20 100,50 mm
- 01.1885.30 100,75 mm
- 01.1885.40 101,00 mm



**01.1886.00** Ring (Ø100,00 mm)

- 01.1886.10 100,25 mm
- 01.1886.20 100,50 mm
- 01.1886.30 100,75 mm
- 01.1886.40 101,00 mm



**01.1227** Bushing



**01.1872** Gear



OEM No : 9361320305



# Single Cylinder Compressor

Ø94 mm

Application - Vehicle  
MERCEDES OM352



## 01.02.001

Oem. No.

3521300615  
3521300215  
3521300315



## 01.060

Cylinder Liner



OEM No : 3521313002

## 01.007

Connecting Rod



OEM No : 3521300216

## 01.178

Con. Rod Bearing Kit



OEM No : 3521312533

## RK.01.011.00

Piston&Ring (Ø94,00 mm)

- RK.01.011.10 94,25 mm
- RK.01.011.20 94,50 mm
- RK.01.011.30 94,75 mm
- RK.01.011.40 95,00 mm



## 01.113.00

Piston

- 01.113.10 94,25 mm
- 01.113.20 94,50 mm
- 01.113.30 94,75 mm
- 01.113.40 95,00 mm



## 01.140.00

Ring

- 01.140.10 94,25 mm
- 01.140.20 94,50 mm
- 01.140.30 94,75 mm
- 01.140.40 95,00 mm



## RK.01.009

Complete Cylinder Head



OEM No : 84530-3521300319

## RK.01.008

Repair Kit



OEM No : 3521300220-3521300120

## RK.01.008.01

Repair Kit



## RK.01.010

Cylinder Liner Set



OEM No : 3521300108

# MERCEDES

## AIR COMPRESSOR AND REPAIR KIT

**RK.01.317**

Repair Kit

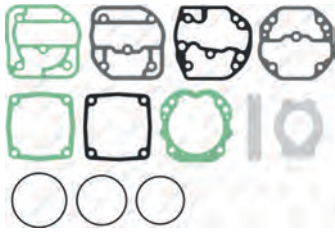

8 680437 063766

**RK.01.317.02**

Repair Kit

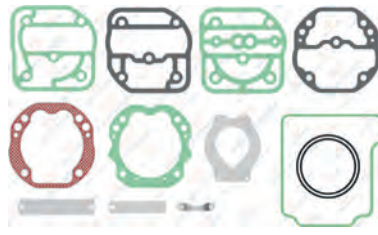

8 680437 073659

**RK.01.317.03**

Repair Kit



8 680437 075332

**RK.01.690**

Repair Kit

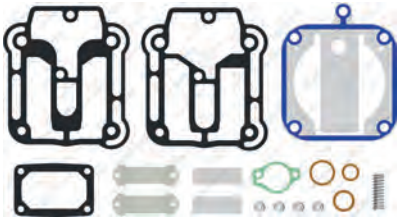

8 680437 078203

**RK.01.491**

Repair Kit

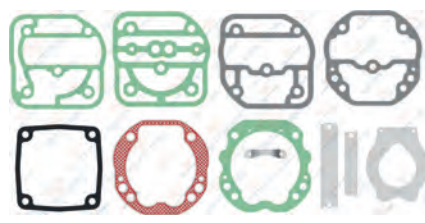

8 680437 065807

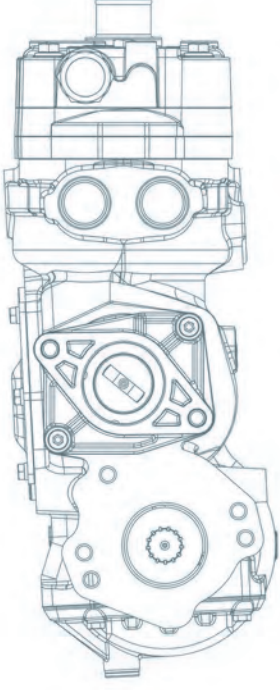

# MAN

**HAVA KOMPRESÖRLERİ  
ve TAMİR TAKIMLARI**

AIR COMPRESSORS AND REPAIR KITS



MAN

**MAN**



## Single Cylinder Compressor Ø92 mm - 360 CC - Stroke 54 mm

**Application - Vehicle**  
 MAN TGA TGS 430  
 NEOPLAN / STARLINER / CITYLINER  
 TOURLINER / SKYLINER / RENDLINER  
 LIONS COACH / LIONS REGIO / LIONS CITY



### 01.04.073

Oem. No.	Knorr No.
51541007121	LP3997
51541007078	K015948
51541007087	



**01.1178** Crankcase

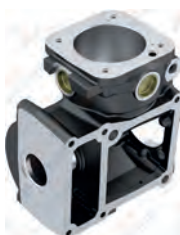

**RK.01.268.03** Repair Kit

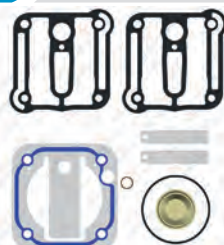

**RK.01.268.06** Repair Kit



**RK.01.518** Complete Cylinder Head

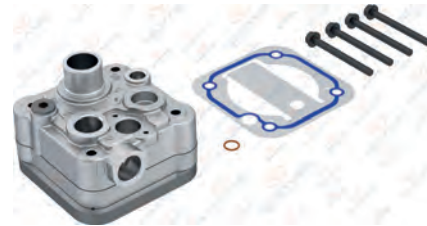

**RK.01.518.20** Complete Cylinder Head



**RK.01.478.02** Valve Plate Kit



**RK.01.478** Valve Plate Kit

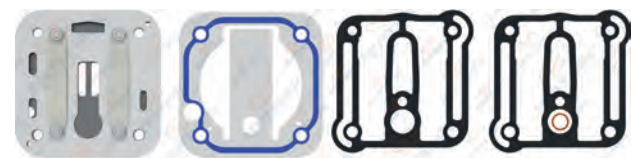

OEM No : 51541246004  
 Knorr No : K015040

**RK.01.268.02** Repair Kit

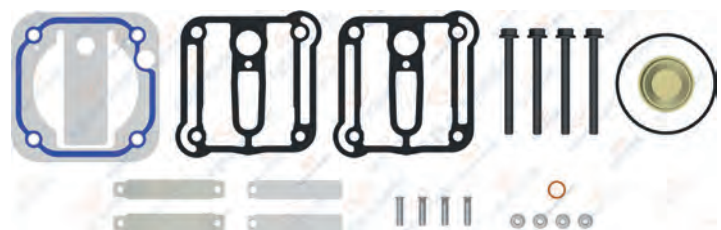

**01.939** Cylinder Head



**OEM No :** 51541146084  
**Knorr No :** K019286

**01.940** Cooling Plate



**Knorr No :** SEB01728004

**01.1022** Crankshaft



**M18X1.5 Left Hand**

**OEM No :** 51541146084  
**Knorr No :** K019286

**01.1036** Valve Plate



**OEM No :** 51541146084  
**Knorr No :** K019286

**01.1148** Crankshaft Flange



**OEM No :** 51541146084  
**Knorr No :** K019286

**01.1101** Connecting Rod



**OEM No :** 51541146084  
**Knorr No :** K019286

**RK.01.318.00** Piston&Ring (Ø92,00 mm)

- RK.01.318.10** 92,25 mm
- RK.01.318.20** 92,50 mm
- RK.01.318.30** 92,75 mm
- RK.01.318.40** 93,00 mm



2,50x2,50x4,00

**Knorr No.:** K006026

**OEM No :** 51541146084  
**Knorr No :** K019286

**01.862.00** Piston (Ø92,00 mm)

- 01.862.10** 92,25 mm
- 01.862.20** 92,50 mm
- 01.862.30** 92,75 mm
- 01.862.40** 93,00 mm



2,50x2,50x4,00

**OEM No :** 51541146084  
**Knorr No :** K019286

**01.942.00** Ring (Ø92,00 mm)

- 01.942.10** 92,25 mm
- 01.942.20** 92,50 mm
- 01.942.30** 92,75 mm
- 01.942.40** 93,00 mm



2,50x2,50x4,00

**OEM No :** 51541146084  
**Knorr No :** K019286

**51.01.007** Safety Valve



**M26X1.5 - 17 Bar**

**OEM No :** 51541228001  
**Knorr No :** DR5125 - K081929K50

**OEM No :** 51541228001  
**Knorr No :** DR5125 - K081929K50

**01.920** Cap



**OEM No :** 51541146084  
**Knorr No :** K019286

**01.1174** Gear

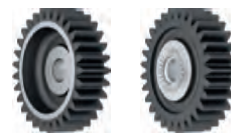

**Notch (Tooth) Pcs : 29**

**OEM No :** 51541146084  
**Knorr No :** K019286

**RK.01.802** Connecting Rod & Piston



**STD.**

**OEM No :** 51541146084  
**Knorr No :** K019286

**01.292** Bushing



**42X38X25**

**OEM No :** 51541146084  
**Knorr No :** K019286

**01.1416** Screw



**M18X1.5 Left Hand**

**OEM No :** 51541146084  
**Knorr No :** K019286



## Single Cylinder Compressor Ø92 mm - 360 CC - Stroke 54 mm

**Application - Vehicle**  
MAN TGA TGS 430 / NEOPLAN /  
STARLINER / CITYLINER / TOURLINER /  
SKYLINER / RENDLINER  
LIONS COACH / LIONS REGIO / LIONS CITY



**01.04.073.10**

**Oem. No.**  
51541007231  
51541007204

**Knorr No.**  
LP3997  
K082069N00



**01.1178** Crankcase



**RK.01.268.04** Repair Kit

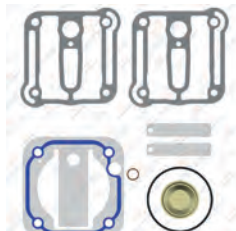

Use for old version cylinder repair kit.  
Yıpranmış kapaklar için.

**RK.01.268.06** Repair Kit



**RK.01.518.10**

Complete Cylinder Head



Knorr No : K114439K50 - K105789K50

**RK.01.478.01**

Valve Plate Kit

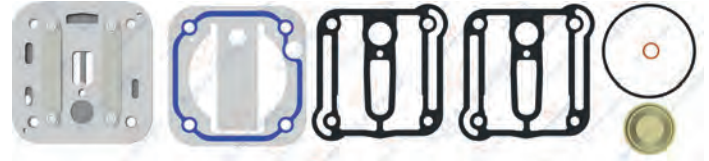

**RK.01.478.10**

Valve Plate Kit

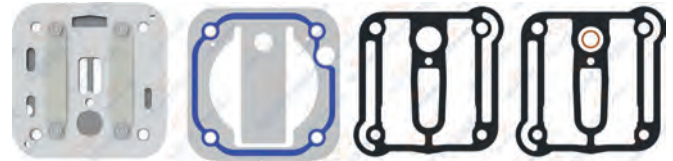

**RK.01.268.02**

Repair Kit

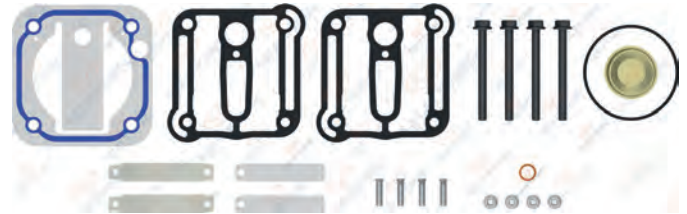

**RK.01.268.03**

Repair Kit

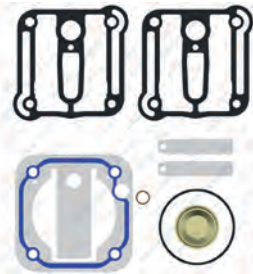

**01.939.10** Cylinder Head



**01.940.10** Cooling Plate



Knorr No : SEB01728004

**01.1022** Crankshaft



M18X1.5 Left Hand



**01.1036.100** Valve Plate



**01.1148** Crankshaft Flange



**01.1101** Connecting Rod



**RK.01.318.00** Piston&Ring (Ø92,00 mm)

- RK.01.318.10 92,25 mm
- RK.01.318.20 92,50 mm
- RK.01.318.30 92,75 mm
- RK.01.318.40 93,00 mm



2,50x2,50x4,00



Knorr No.: K006026

**01.862.00** Piston (Ø92,00 mm)

- 01.862.10 92,25 mm
- 01.862.20 92,50 mm
- 01.862.30 92,75 mm
- 01.862.40 93,00 mm



2,50x2,50x4,00



**01.942.00** Ring (Ø92,00 mm)

- 01.942.10 92,25 mm
- 01.942.20 92,50 mm
- 01.942.30 92,75 mm
- 01.942.40 93,00 mm



2,50x2,50x4,00



**51.01.007** Safety Valve



M26X1.5 - 17 Bar



OEM No : 51541228001  
Knorr No : DR5125 - K081929K50

**01.920** Cap



**01.1174** Gear

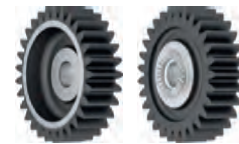

Notch (Tooth) Pcs : 29



**RK.01.802** Connecting Rod & Piston



STD.



**01.292** Bushing



42X38X25



**01.1416** Screw



M18X1.5 Left Hand



## Single Cylinder Compressor Ø92 mm - 360 CC - Stroke 54 mm

### Application - Vehicle

MAN TGA 33.360 NEOPLAN / STARLINER  
CITYLINER / TOURLINER / SKYLINER / RENDLINER  
LIONS COACH / LIONS REGIO / LIONS CITY



**01.04.072**

**Oem. No.**  
51541007095

**Knorr No.**  
LP3980  
K0084489



**01.1172** Crankcase



**RK.01.242.03** Repair Kit

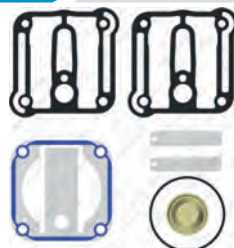

**RK.01.401** Repair Kit



**RK.01.260** Complete Cylinder Head



**RK.01.260.20** Complete Cylinder Head



**RK.01.511.01** Valve Plate Kit

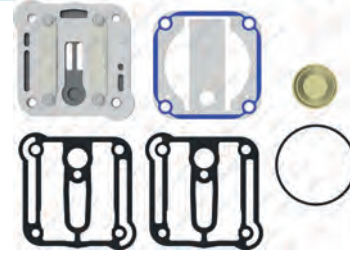

**RK.01.511** Valve Plate Kit



**RK.01.242.02** Repair Kit

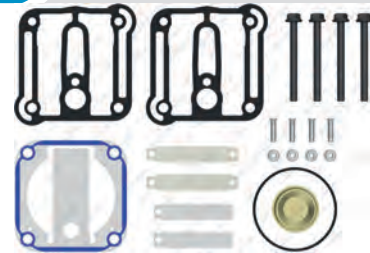



**01.939** Cylinder Head



8 680437 028611 **OEM No** : 51541146084  
**Knorr No** : K019286

**01.940** Cooling Plate



8 680437 028635

**01.1022** Crankshaft



**M18X1.5 Left Hand**

8 680437 014874

**01.186** Valve Plate

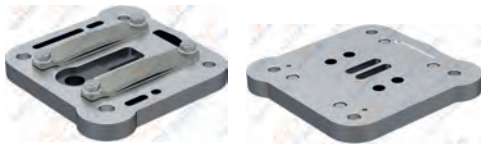

8 680437 019190 **OEM No** : 51541246003

**01.1148** Crankshaft Flange



8 680437 016816

**01.1101** Connecting Rod



8 680437 016069

**RK.01.318.00** Piston&Ring (Ø92,00 mm)

- RK.01.318.10 92,25 mm
- RK.01.318.20 92,50 mm
- RK.01.318.30 92,75 mm
- RK.01.318.40 93,00 mm



2,50x2,50x4,00

8 680437 063773 **Knorr No.:**K006026

**01.862.00** Piston (Ø92,00 mm)

- 01.862.10 92,25 mm
- 01.862.20 92,50 mm
- 01.862.30 92,75 mm
- 01.862.40 93,00 mm



2,50x2,50x4,00

8 680437 027584

**01.942.00** Ring (Ø92,00 mm)

- 01.942.10 92,25 mm
- 01.942.20 92,50 mm
- 01.942.30 92,75 mm
- 01.942.40 93,00 mm



2,50x2,50x4,00

8 680437 028666

**51.01.007** Safety Valve



**M26X1.5 - 17 Bar**

8 680437 072324 **OEM No** : 51541228001  
**Knorr No** : DR5125 - K081929K50

**01.920** Cap



8 680437 028413

**01.1174** Gear



**Notch (Tooth) Pcs : 29**

8 680437 017202

**RK.01.802** Connecting Rod & Piston



**STD.**

8 680437 114550

**01.292** Bushing



42X38X25

8 680437 073871

**01.1416** Screw



**M18X1.5 Left Hand**

8 680437 072560

## Single Cylinder Compressor Ø92 mm - 360 CC - Stroke 54 mm

### Application - Vehicle

MAN TGA 41.430 - 460 - 400  
FORTUNA BUS / D2066 ENGINE  
NEOPLAN / STARLINER / CITYLINER  
TOURLINER / SKYLINER / RENDLINER  
LIONS COACH / LIONS REGIO / LIONS CITY

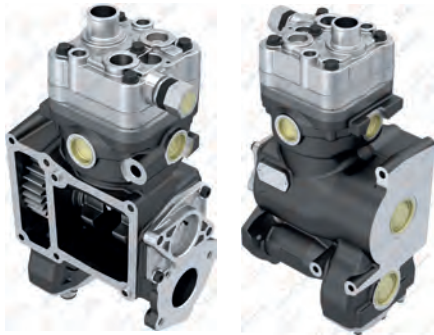

**01.04.118.10**

**Oem. No.**  
51541007232

**Knorr No.**  
LK8901  
K082139N00



**01.1200** Crankcase



**RK.01.268** Repair Kit

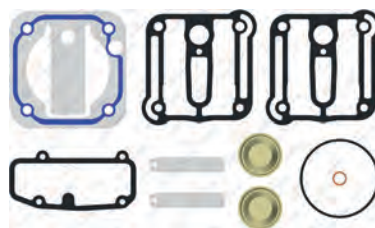

**RK.01.268.06** Repair Kit



**RK.01.518.10**

Complete Cylinder Head



**Knorr No :** K114439K50

**RK.01.478.01**

Valve Plate Kit

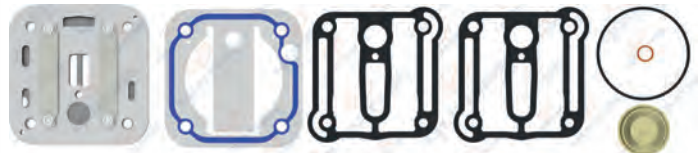

**RK.01.478.10**

Valve Plate Kit

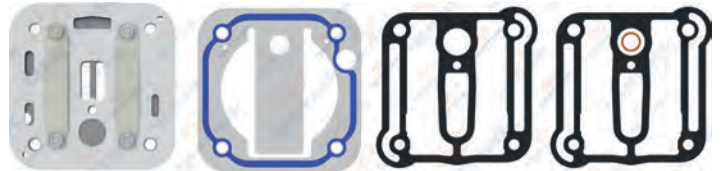

**RK.01.268.01**

Repair Kit

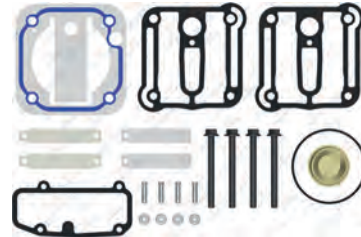

**RK.01.242.09**

Repair Kit

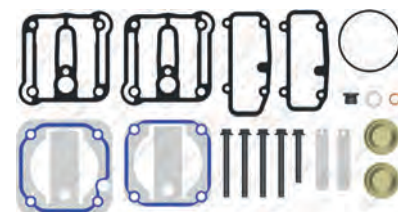

**Knorr No :** K015042

**01.939.10** Cylinder Head



8 680437 101864

**01.940.10** Cooling Plate



8 680437 101840

**01.1022** Crankshaft



M18X1.5 Left Hand



8 680437 014874

**01.1036.100** Valve Plate



8 680437 116837

**01.1148** Crankshaft Flange



8 680437 016816

**01.1101** Connecting Rod



8 680437 016069

**RK.01.318.00** Piston&Ring (Ø92,00 mm)

- RK.01.318.10 92,25 mm
- RK.01.318.20 92,50 mm
- RK.01.318.30 92,75 mm
- RK.01.318.40 93,00 mm



2,50x2,50x4,00

Knorr. No.:K006026



8 680437 063773

**01.862.00** Piston (Ø92,00 mm)

- 01.862.10 92,25 mm
- 01.862.20 92,50 mm
- 01.862.30 92,75 mm
- 01.862.40 93,00 mm



2,50x2,50x4,00



8 680437 027584

**01.942.00** Ring (Ø92,00 mm)

- 01.942.10 92,25 mm
- 01.942.20 92,50 mm
- 01.942.30 92,75 mm
- 01.942.40 93,00 mm



2,50x2,50x4,00



8 680437 028666

**01.1344** Cover



8 680437 072676

**51.01.007** Safety Valve

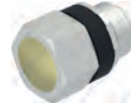

M26X1.5 - 17 Bar

OEM No : 51541228001  
Knorr No : DR5125 - K081929K50



8 680437 072524

**01.1174** Gear

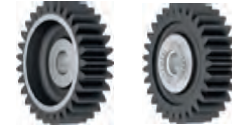

Notch (Tooth) Pcs : 29



8 680437 017202

**01.1177** Drive Shaft



8 680437 017233

**01.292** Bushing



42X38X25



8 680437 073871

**01.1190** Gear



Notch (Tooth) Pcs : 31



8 680437 017400



## Single Cylinder Compressor Ø92 mm - 360 CC - Stroke 54 mm

### Application - Vehicle

MAN TGA 41.430 - 460 - 400  
FORTUNA BUS / D2066 ENGINE  
NEOPLAN / STARLINER / CITYLINER  
TOURLINER / SKYLINER / RENDLINER  
LIONS COACH / LIONS REGIO / LIONS CITY

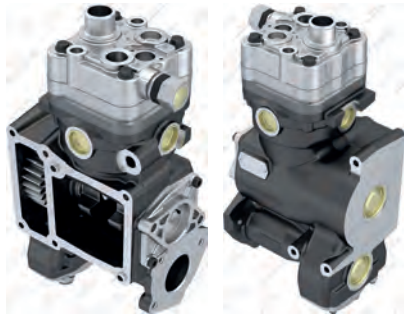

### 01.04.118

Oem. No.	Knorr No.
51541007117	LK8901
51541007205	K015410



8 680437 011880



**01.1200** Crankcase



8 680437 017523

**RK.01.268.03** Repair Kit

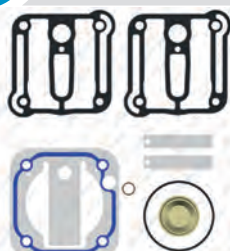

8 680437 073932

**RK.01.518** Complete Cylinder Head



8 680437 066125

**RK.01.518.20** Complete Cylinder Head



8 680437 076650

**RK.01.478.02** Valve Plate Kit

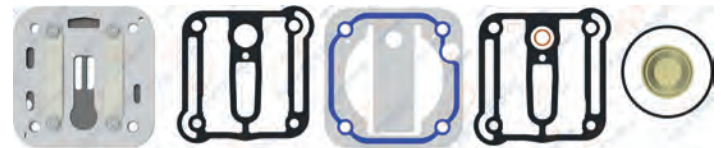

8 680437 112648

**RK.01.478** Valve Plate Kit

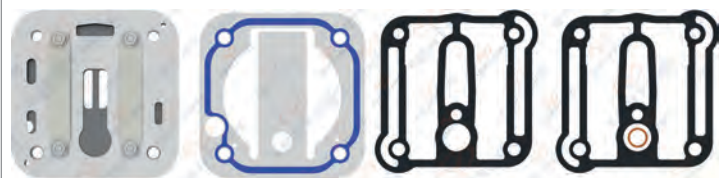

8 680437 065654

OEM No : 51541246004  
Knorr No : K015040

**RK.01.268.02** Repair Kit

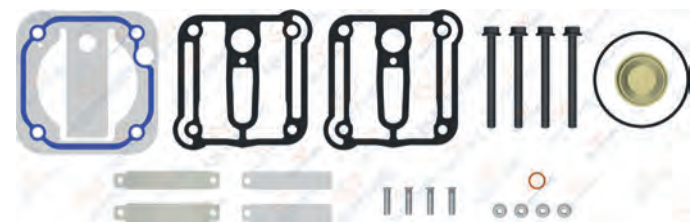

8 680437 063087

**RK.01.268.06** Repair Kit



8 680437 124153

**01.939** Cylinder Head



Barcode: 8 680437 028611  
**OEM No :** 51541146084  
**Knorr No :** K019286

**01.940** Cooling Plate



Barcode: 8 680437 028635  
**Knorr No :** SEB01728004

**01.1022** Crankshaft



**M18X1.5 Left Hand**

Barcode: 8 680437 014874

**01.1036** Valve Plate



Barcode: 8 680437 015055

**01.1148** Crankshaft Flange



Barcode: 8 680437 016816

**01.1101** Connecting Rod



Barcode: 8 680437 016069

**RK.01.318.00** Piston&Ring (Ø92,00 mm)

- RK.01.318.10 92,25 mm
- RK.01.318.20 92,50 mm
- RK.01.318.30 92,75 mm
- RK.01.318.40 93,00 mm



2,50x2,50x4,00  
 Barcode: 8 680437 063773  
**Knorr. No.:**K006026

**01.862.00** Piston (Ø92,00 mm)

- 01.862.10 92,25 mm
- 01.862.20 92,50 mm
- 01.862.30 92,75 mm
- 01.862.40 93,00 mm



2,50x2,50x4,00  
 Barcode: 8 680437 027584

**01.942.00** Ring (Ø92,00 mm)

- 01.942.10 92,25 mm
- 01.942.20 92,50 mm
- 01.942.30 92,75 mm
- 01.942.40 93,00 mm



2,50x2,50x4,00  
 Barcode: 8 680437 028666

**01.1344** Cover



Barcode: 8 680437 072676

**01.1190** Gear



Notch (Tooth) Pcs : 31  
 Barcode: 8 680437 017400

**01.1174** Gear

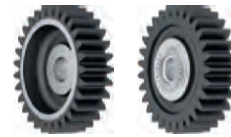

Notch (Tooth) Pcs : 29  
 Barcode: 8 680437 017202

**01.1177** Drive Shaft



Barcode: 8 680437 017233

**01.1416.10** Screw



**M18X1.5 Right Hand**  
 Barcode: 8 680437 077046

**01.1416** Screw



**M18X1.5 Left Hand**  
 Barcode: 8 680437 072560

## Single Cylinder Compressor Ø92 mm - 360 CC - Stroke 54 mm

Application - Vehicle  
MAN TGA 41.430 - 460 - 400

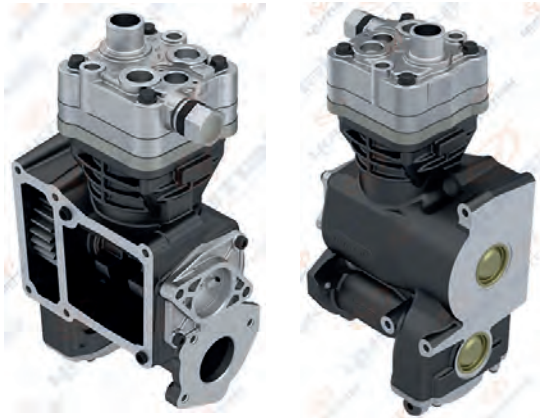

**01.04.117**

Oem. No.  
51541007096

Knorr No.  
LP3986  
K005977



**01.1199**

Crankcase



**RK.01.242.09**

Repair Kit

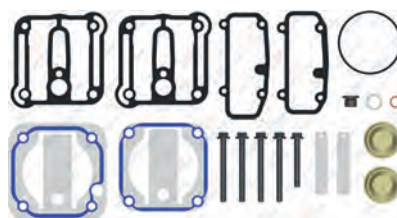

Knorr No : K015042

**RK.01.242**

Repair Kit

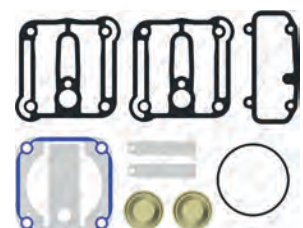

**RK.01.260**

Complete Cylinder Head



**RK.01.260.20**

Complete Cylinder Head



**RK.01.511.01**

Valve Plate Kit



**RK.01.511**

Valve Plate Kit

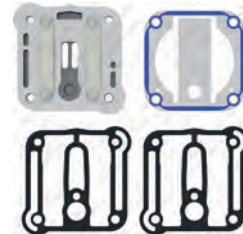

**RK.01.242.01**

Repair Kit

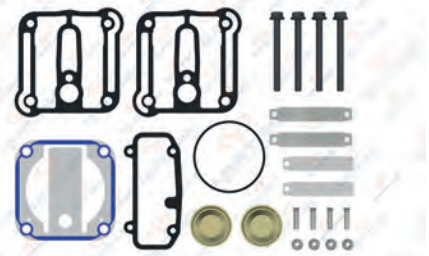



**01.939** Cylinder Head



**OEM No :** 51541146084  
**Knorr No :** K019286

**01.940** Cooling Plate



**Knorr No :** SEB01728004

**01.1022** Crankshaft



**M18X1.5 Left Hand**

**OEM No :** 51541146084  
**Knorr No :** K019286

**01.186** Valve Plate



**OEM No :** 51541246003

**01.1148** Crankshaft Flange



**OEM No :** 51541246003

**01.1101** Connecting Rod



**OEM No :** 51541246003

**RK.01.318.00** Piston&Ring (Ø92,00 mm)

- RK.01.318.10** 92,25 mm
- RK.01.318.20** 92,50 mm
- RK.01.318.30** 92,75 mm
- RK.01.318.40** 93,00 mm



**2,50x2,50x4,00**  
**Knorr. No.:**K006026

**01.862.00** Piston (Ø92,00 mm)

- 01.862.10** 92,25 mm
- 01.862.20** 92,50 mm
- 01.862.30** 92,75 mm
- 01.862.40** 93,00 mm



**2,50x2,50x4,00**

**01.942.00** Ring (Ø92,00 mm)

- 01.942.10** 92,25 mm
- 01.942.20** 92,50 mm
- 01.942.30** 92,75 mm
- 01.942.40** 93,00 mm



**2,50x2,50x4,00**

**01.1177** Drive Shaft



**OEM No :** 51541228001  
**Knorr No :** DR5125 - K081929K50

**01.920** Cap



**OEM No :** 51541228001  
**Knorr No :** DR5125 - K081929K50

**01.1174** Gear



**Notch (Tooth) Pcs : 29**

**51.01.007** Safety Valve



**M26X1.5 - 17 Bar**  
**OEM No :** 51541228001  
**Knorr No :** DR5125 - K081929K50

**01.292** Bushing



**42X38X25**

**01.1190** Gear



**Notch (Tooth) Pcs : 31**

## Twin Cylinder Compressor Ø92 mm - 720 CC - Stroke 54 mm

### Application - Vehicle

MAN TGX - TGA - TGS - TGM  
D2066 ENGINE / TRENDLINER /  
CENTROLINER / CITYLINER / TOURLINER /  
LIONS COACH / LIONS CITY / LIONS REGIO



### 01.04.119

**Oem. No.**  
51541007115  
51541007197

**Knorr No.**  
LK4960  
K089063N00



01.1194

Crankcase



RK.01.494.05

Repair Kit

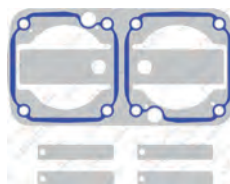

RK.01.603 Complete Cylinder Head



RK.01.603.01

Complete Cylinder Head



RK.01.604

Valve Plate Kit



RK.01.494.03

Repair Kit



Knorr No : K019528

RK.01.494

Repair Kit

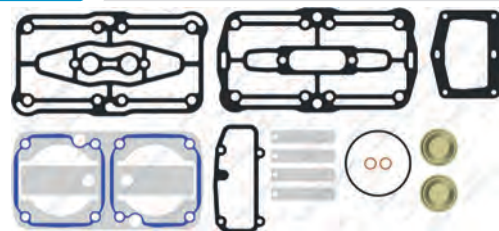

01.1344

Cover



**01.1025** Cylinder Head



Knorr No : SEB01903004



**01.1026** Cooling Plate



**01.1080** Crankshaft



M18X1.5 Left Hand



**01.1057** Valve Plate



OEM No : 51541246005  
Knorr No : K019525



**01.1148** Crankshaft Flange



**01.1056** Connecting Rod



**RK.01.318.00** Piston&Ring (Ø92,00 mm)

- RK.01.318.10 92,25 mm
- RK.01.318.20 92,50 mm
- RK.01.318.30 92,75 mm
- RK.01.318.40 93,00 mm



2,50x2,50x4,00

Knorr. No.:K006026



**01.862.00** Piston (Ø92,00 mm)

- 01.862.10 92,25 mm
- 01.862.20 92,50 mm
- 01.862.30 92,75 mm
- 01.862.40 93,00 mm



2,50x2,50x4,00



**01.942.00** Ring (Ø92,00 mm)

- 01.942.10 92,25 mm
- 01.942.20 92,50 mm
- 01.942.30 92,75 mm
- 01.942.40 93,00 mm



2,50x2,50x4,00



**01.1190** Gear



Notch (Tooth) Pcs : 31



**01.1174** Gear

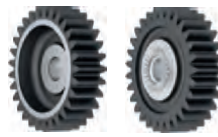

Notch (Tooth) Pcs : 29



**01.1195** Cover



**01.292** Bushing



42X38X25



**01.1416.10** Screw



M18X1.5 Right Hand



**01.1416** Screw



M18X1.5 Left Hand



**01.1192** Drive Shaft





## Twin Cylinder Compressor Ø92 mm - 720 CC - Stroke 54 mm

**Application - Vehicle**  
MAN TGA TGS TGX TGM M2000 /  
NAVISTAR / TRENDLINER / CENTROLINER /  
CITYLINER / TOURLINER / LIONS COACH  
LIONS CITY / LIONS REGIO



**01.04.113**

**Oem. No.**  
51541007114  
51541007024

**Knorr No.**  
LK4928  
K088948N00



**01.1229** Crankcase



**RK.01.602.04** Repair Kit

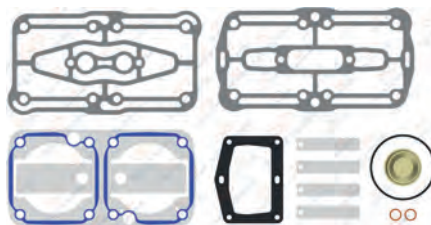

Use for old version cylinder repair kit.  
Yıpranmış kapaklar için.

**RK.01.494.05** Repair Kit

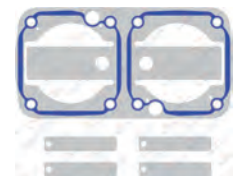

**RK.01.603**

Complete Cylinder Head



**RK.01.603.01**

Complete Cylinder Head



**RK.01.604**

Valve Plate Kit

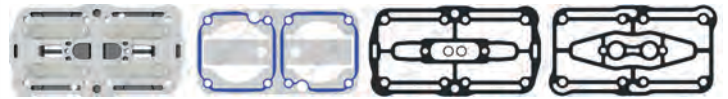

**RK.01.602.01**

Repair Kit

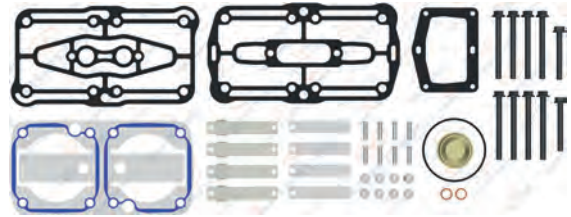

**RK.01.602**

Repair Kit

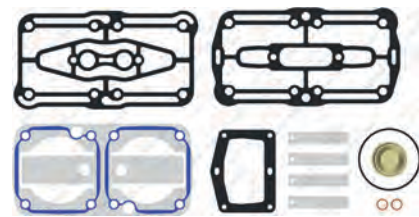

**01.1025** Cylinder Head



Knorr No : SEB01903004  
8 680437 014911

**01.1026** Cooling Plate



8 680437 014928

**01.1080** Crankshaft



M18X1.5 Left Hand

8 680437 015741

**01.1057** Valve Plate



OEM No : 51541246005  
Knorr No : K019525  
8 680437 015369

**01.1148** Crankshaft Flange



8 680437 016816

**01.1056** Connecting Rod



8 680437 015345

**RK.01.318.00** Piston&Ring (Ø92,00 mm)

- RK.01.318.10 92,25 mm
- RK.01.318.20 92,50 mm
- RK.01.318.30 92,75 mm
- RK.01.318.40 93,00 mm



2,50x2,50x4,00  
Knorr. No.:K006026  
8 680437 063773

**01.862.00** Piston (Ø92,00 mm)

- 01.862.10 92,25 mm
- 01.862.20 92,50 mm
- 01.862.30 92,75 mm
- 01.862.40 93,00 mm



2,50x2,50x4,00  
8 680437 027584

**01.942.00** Ring (Ø92,00 mm)

- 01.942.10 92,25 mm
- 01.942.20 92,50 mm
- 01.942.30 92,75 mm
- 01.942.40 93,00 mm



2,50x2,50x4,00  
8 680437 028666

**01.1195** Cover



8 680437 017455

**01.920** Cap



8 680437 028413

**01.1174** Gear

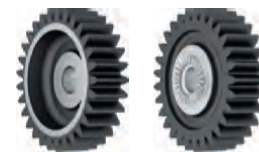

Notch (Tooth) Pcs : 29

8 680437 017202

**01.292** Bushing



42X38X25

8 680437 073871

**01.1416** Screw



M18X1.5 Left Hand

8 680437 072560

## Twin Cylinder Compressor Ø92 mm - 720 CC - Stroke 54 mm

**Application - Vehicle**  
MAN TGA - TGS - TGM - TGX  
D2066 ENGINE

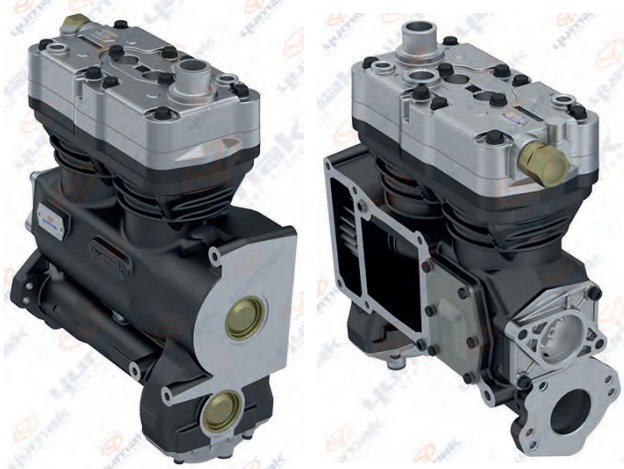

**01.04.120**

**Oem. No.**  
51541007094

**Knorr No.**  
LK4934  
K001671000



**01.1197** Crankcase



**RK.01.494.05** Repair Kit

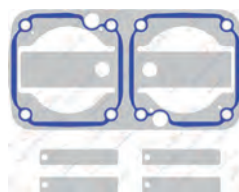

**RK.01.516** Complete Cylinder Head



**RK.01.517** Valve Plate Kit

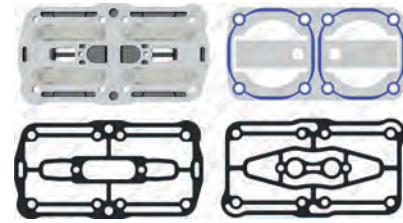

**RK.01.514.01** Repair Kit

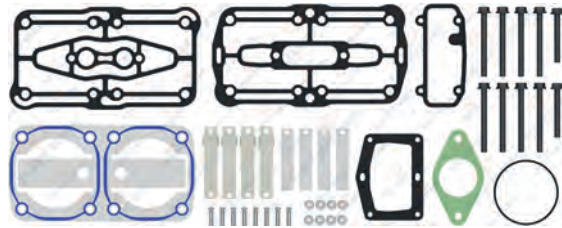

**RK.01.514** Repair Kit

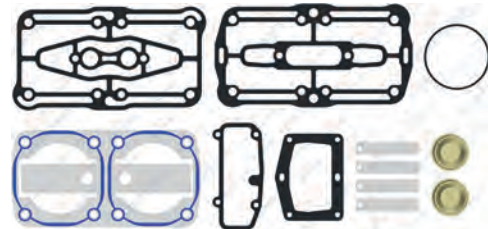

**RK.01.514.04** Repair Kit

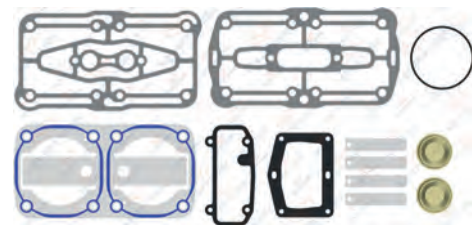

Use for old version cylinder repair kit. Yıpranmış kapaklar için.

**01.1192** Drive Shaft





01.1025

Cylinder Head



Knorr No : SEB01903004

01.1026

Cooling Plate



01.1080

Crankshaft



M18X1.5 Left Hand



01.1027

Valve Plate



Knorr No : SEB01957004

01.1148

Crankshaft Flange



01.1056

Connecting Rod



RK.01.318.00

Piston&Ring (Ø92,00 mm)

RK.01.318.10	92,25 mm
RK.01.318.20	92,50 mm
RK.01.318.30	92,75 mm
RK.01.318.40	93,00 mm



2,50x2,50x4,00



Knorr. No.:K006026

01.862.00

Piston (Ø92,00 mm)

01.862.10	92,25 mm
01.862.20	92,50 mm
01.862.30	92,75 mm
01.862.40	93,00 mm



2,50x2,50x4,00



01.942.00

Ring (Ø92,00 mm)

01.942.10	92,25 mm
01.942.20	92,50 mm
01.942.30	92,75 mm
01.942.40	93,00 mm



2,50x2,50x4,00



01.292

Bushing



42X38X25



01.1190

Gear



Notch (Tooth) Pcs : 31



01.1174

Gear



Notch (Tooth) Pcs : 29



01.1195

Cover



01.1416.10

Screw



M18X1.5 Right Hand



01.1416

Screw



M18X1.5 Left Hand



## Single Cylinder Compressor Ø100 mm - 360 CC - Stroke 46 mm

Application - Vehicle  
MAN FE 26T 6x4  
D2876



### 01.01.003

**Oem. No.**

51541006015  
51541006013  
51541006011  
51541009015



### 01.088

#### Crankcase



OEM No : 51541120012

### RK.01.093

#### Complete Cylinder Head



OEM No : 51541146070 - 51541146073 - 51541146086 - 51541146066  
Wabco No : 4121008062 - 4121008052 - 4121008002

### RK.01.092.01

#### Repair Kit

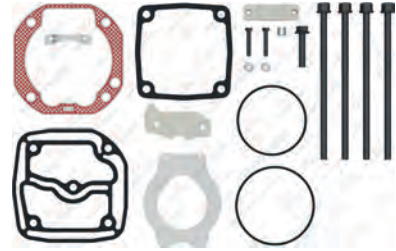

### RK.01.092

#### Repair Kit

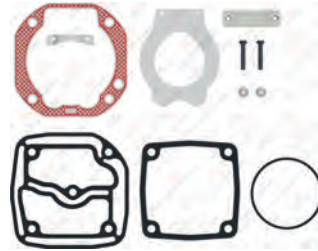

### RK.01.092.04

#### Repair Kit

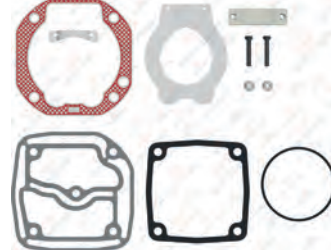

Use for old version cylinder repair kit. Yıpranmış kapaklar için.

### RK.01.298

#### Repair Kit

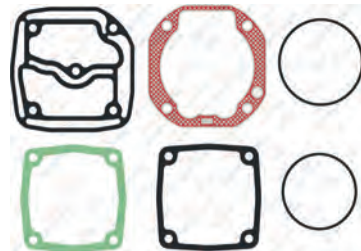

### RK.01.217

#### Repair Kit



### RK.01.092.20

#### Repair Kit

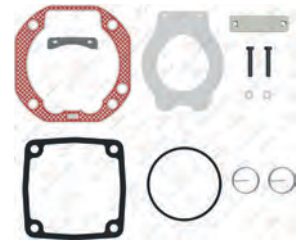

**01.242** Cylinder Head



8 680437 019992

**01.250** Valve Plate



8 680437 020103

**01.094** Crankshaft



M18X1.5 Right Hand



8 680437 014485

OEM No : 51541135017 - 51541135027

**00.460** Roller Bearing



NUP 306



8 680437 004714

**01.020** Crankshaft Flange



8 680437 010081

OEM No : 51541306021

**01.249** Connecting Rod



8 680437 020080

OEM No : 51541066021

**RK.01.006.00** Piston&Ring (Ø100,00 mm)

- RK.01.006.10 100,25 mm
- RK.01.006.20 100,50 mm
- RK.01.006.30 100,75 mm
- RK.01.006.40 101,00 mm



2,50x2,50x4,00



8 680437 058243

**01.107.00** Piston (Ø100,00 mm)

- 01.107.10 100,25 mm
- 01.107.20 100,50 mm
- 01.107.30 100,75 mm
- 01.107.40 101,00 mm



2,50x2,50x4,00



8 680437 015505

**01.133.00** Ring (Ø100,00 mm)

- 01.133.10 100,25 mm
- 01.133.20 100,50 mm
- 01.133.30 100,75 mm
- 01.133.40 101,00 mm



2,50x2,50x4,00



8 680437 018216

**RK.01.090** Cylinder Liner Set



STD.



8 680437 059967

**01.248** Cylinder Liner



8 680437 020066

OEM No : 51541056016 - 51541056021

**01.052** Gear



Notch (Tooth) Pcs : 20



8 680437 013112

OEM No : 51542100038

**01.014** Bushing



34X30X20.5



8 680437 010005

OEM No : 51930201007

**01.074** Cover



8 680437 014140

**01.075** Cover



8 680437 014157



## Twin Cylinder Compressor Ø100 mm - 720 CC - Stroke 46 mm

Application - Vehicle  
MAN G2866 / UH / UM /  
DUH01-05 / DUM01

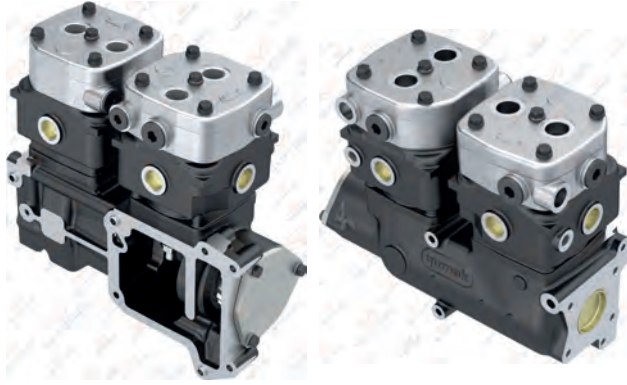

### 01.01.008

**Oem. No.**

51541007003  
51541006005  
51541006023  
51541007178



### 01.336

#### Crankcase



OEM No : 51541126030 -  
51541126037

### RK.01.217

#### Repair Kit



### 01.335

#### Pressure Valve



### RK.01.093

#### Complete Cylinder Head



OEM No : 51541146070 - 51541146073 - 51541146086 - 51541146066  
Wabco No : 4121008062 - 4121008052 - 4121008002

### RK.01.291.01

#### Repair Kit



### RK.01.291

#### Repair Kit

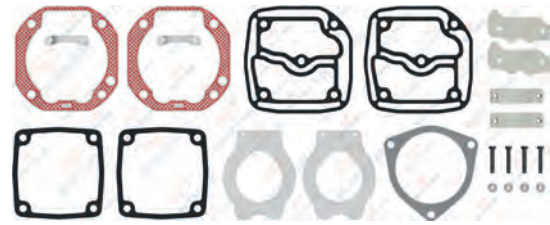

### RK.01.092

#### Repair Kit

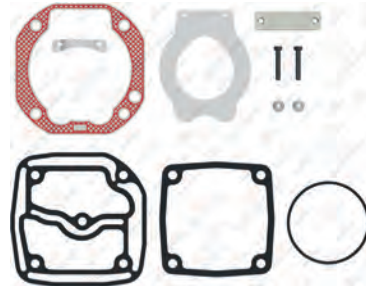

### RK.01.291.04

#### Repair Kit

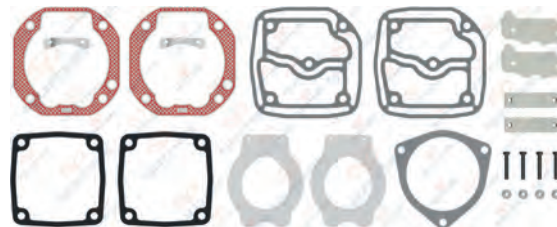

Use for old version cylinder repair kit. Yıpranmış kapaklar için.

**01.242** Cylinder Head



8 680437 019992

**01.250** Valve Plate

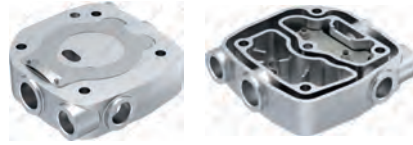

8 680437 020103

**01.567** Crankshaft



8 680437 024118

OEM No : 51541135044

**00.985** Roller Bearing



NUP 2209

OEM No : 51934200016



8 680437 127727

**01.516** Bushing



52X47X21

OEM No : 51930200335



8 680437 023579

**01.249** Connecting Rod



8 680437 020080

OEM No : 51541066021

**RK.01.006.00** Piston&Ring (Ø100,00 mm)

- RK.01.006.10 100,25 mm
- RK.01.006.20 100,50 mm
- RK.01.006.30 100,75 mm
- RK.01.006.40 101,00 mm



2,50x2,50x4,00



8 680437 058243

**01.107.00** Piston (Ø100,00 mm)

- 01.107.10 100,25 mm
- 01.107.20 100,50 mm
- 01.107.30 100,75 mm
- 01.107.40 101,00 mm



2,50x2,50x4,00



8 680437 015505

**01.133.00** Ring (Ø100,00 mm)

- 01.133.10 100,25 mm
- 01.133.20 100,50 mm
- 01.133.30 100,75 mm
- 01.133.40 101,00 mm



2,50x2,50x4,00



8 680437 018216

**RK.01.090** Cylinder Liner Set



STD.



8 680437 059967

**01.248** Cylinder Liner



8 680437 020066

OEM No : 51541056016 - 51541056021

**01.251** Cover



8 680437 020127

**01.702** Gear



Ø85 - Z:25



8 680437 025696

OEM No : 51542100182

**01.573** Drive Shaft



8 680437 024187

OEM No : 51066500005

## Twin Cylinder Compressor Ø100 mm - 720 CC - Stroke 46 mm

Application - Vehicle  
MAN D 0836



**01.01.013**

Oem. No.  
51541007249  
51541007190



**01.1236** Crankcase



**RK.01.217** Repair Kit



**RK.01.093** Complete Cylinder Head



OEM No : 51541146070 - 51541146073 - 51541146086 - 51541146066  
Wabco No : 4121008062 - 4121008052 - 4121008002

**RK.01.291.01** Repair Kit



**RK.01.291** Repair Kit

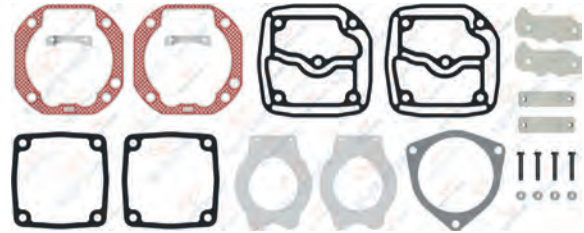

**RK.01.092** Repair Kit

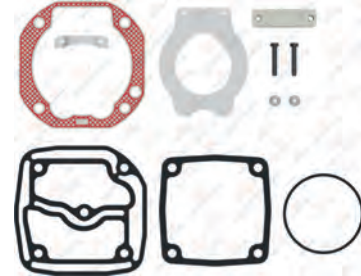

**RK.01.291.04** Repair Kit

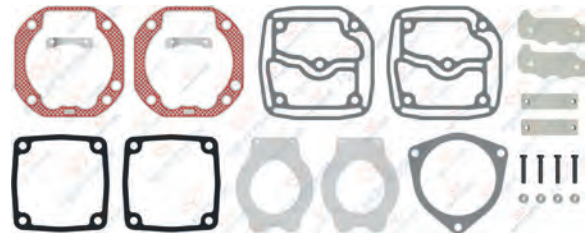

Use for old version cylinder repair kit. Yıpranmış kapaklar için.

**01.335** Pressure Valve





**01.242** Cylinder Head



8 680437 019992

**01.250** Valve Plate



8 680437 020103

**01.1111** Crankshaft



M18X1.5 - Right Hand



8 680437 016212

**01.1238** Gear



8 680437 018063

**01.1268** Cover



8 680437 083214

**01.249** Connecting Rod



8 680437 020080

OEM No : 51541066021

**RK.01.006.00** Piston&Ring (Ø100,00 mm)

- RK.01.006.10 100,25 mm
- RK.01.006.20 100,50 mm
- RK.01.006.30 100,75 mm
- RK.01.006.40 101,00 mm



2,50x2,50x4,00



8 680437 058243

**01.107.00** Piston (Ø100,00 mm)

- 01.107.10 100,25 mm
- 01.107.20 100,50 mm
- 01.107.30 100,75 mm
- 01.107.40 101,00 mm



2,50x2,50x4,00



8 680437 015505

**01.133.00** Ring (Ø100,00 mm)

- 01.133.10 100,25 mm
- 01.133.20 100,50 mm
- 01.133.30 100,75 mm
- 01.133.40 101,00 mm



2,50x2,50x4,00



8 680437 018216

**RK.01.090** Cylinder Liner Set



STD.



8 680437 059967

**01.248** Cylinder Liner



8 680437 020066

OEM No : 51541056016 - 51541056021

**01.516** Bushing



52X47X21



8 680437 023579

OEM No : 51930200335

**00.981** Roller Bearing



NUP 209



8 680437 009443

OEM No : 51934200015

## Twin Cylinder Compressor Ø90 mm - 547 CC - Stroke 46 mm

Application - Vehicle  
MAN TGA - 360



**01.03.042**

Oem. No.

51541006007  
51541006008



**01.336** Crankcase



OEM No : 51541126030 -  
51541126037



**RK.01.290** Repair Kit



OEM No : 51541126030 -  
51541126037



**RK.01.102** Complete Cylinder Head



OEM No : 51541146081  
Wabco No : 4120908032 - 4120908012 - 4120909202



**RK.01.065.01** Repair Kit

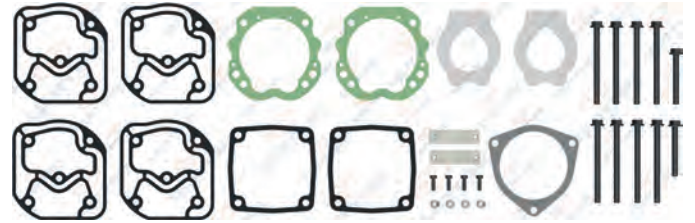

**RK.01.065** Repair Kit

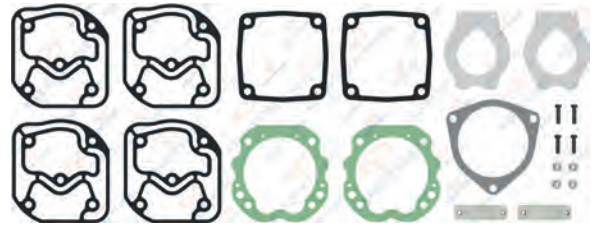

**RK.01.065.04** Repair Kit

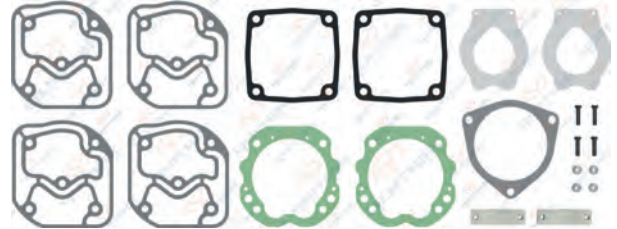

Use for old version cylinder repair kit. Yıpranmış kapaklar için.

**RK.01.160.02** Repair Kit

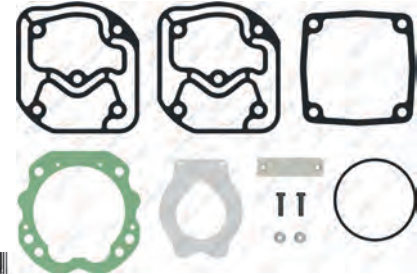

**01.952** Cap



OEM No : 51541126030 -  
51541126037



**01.431** Cylinder Head



8 680437 022497

**01.430** Cooling Plate

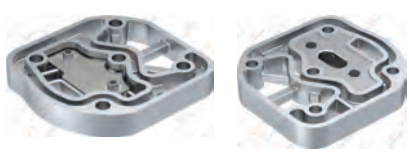

8 680437 022473

**01.432** Valve Plate



8 680437 022510

**01.1111** Crankshaft



M18X1.5 - Right Hand



8 680437 016212

OEM No : 51541135025\* - 51541135014\*

**01.251** Cover



8 680437 020127

**01.006** Connecting Rod



8 680437 009757

OEM No : 51541066013\*

**RK.01.022.00** Piston&Ring (Ø90,00 mm)

- RK.01.022.10 90,25 mm
- RK.01.022.20 90,50 mm
- RK.01.022.30 90,75 mm
- RK.01.022.40 91,00 mm



2,50x2,50x4,00



8 680437 058526

**01.112.00** Piston (Ø90,00 mm)

- 01.112.10 90,25 mm
- 01.112.20 90,50 mm
- 01.112.30 90,75 mm
- 01.112.40 91,00 mm



2,50x2,50x4,00



8 680437 016342

**01.138.00** Ring (Ø90,00 mm)

- 01.138.10 90,25 mm
- 01.138.20 90,50 mm
- 01.138.30 90,75 mm
- 01.138.40 91,00 mm



2,50x2,50x4,00



8 680437 018469

OEM No : 06184800232 - 51025030562

**RK.01.018** Cylinder Liner Set



STD.



8 680437 058489

OEM No : 51541056005 - 51541056007 - 51541056008

**01.059** Cylinder Liner



8 680437 013211

**01.598** Gear



Ø75.5 - Z:23



8 680437 024477

OEM No : 51542100123

**01.241** Connecting Rod Bearing Kit



8 680437 019985

OEM No : 51541216001

**01.516** Bushing



52X47X21



8 680437 023579

OEM No : 51930200335

**01.204** Screw



M18X1.5 - Right Hand



8 680437 019510



## Twin Cylinder Compressor Ø90 mm - 547 CC - Stroke 46 mm

Application - Vehicle  
MAN TGA



### 01.03.032

Oem. No.

51541007028  
51541007130



### 01.336 Crankcase



OEM No : 51541126030 -  
51541126037



### RK.01.290 Repair Kit



OEM No : 51541126030 -  
51541126037



### RK.01.102 Complete Cylinder Head



OEM No : 51541146081  
Wabco No : 4120908032 - 4120908012 - 4120909202

### RK.01.065.01 Repair Kit

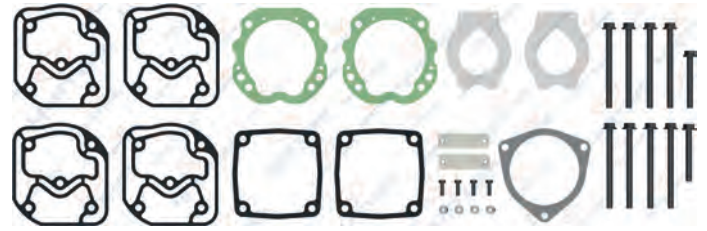

### RK.01.065 Repair Kit

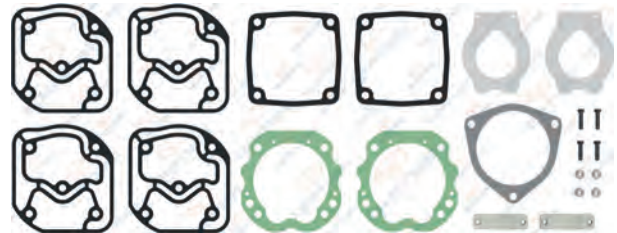

### RK.01.065.04 Repair Kit

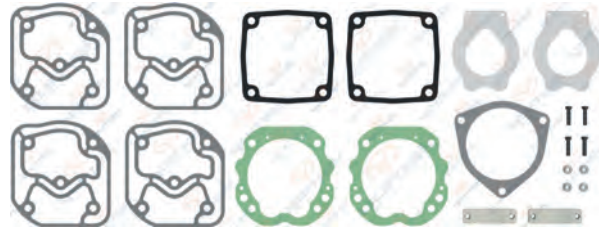

Use for old version cylinder repair kit. Yıpranmış kapaklar için.

### RK.01.160.02 Repair Kit

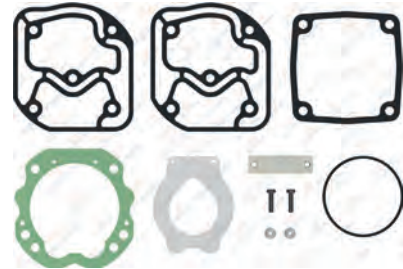

### 01.952 Cap



OEM No : 51541126030 -  
51541126037



**01.431** Cylinder Head



8 680437 022497

**01.430** Cooling Plate



8 680437 022473

**01.432** Valve Plate



8 680437 022510

**01.1111** Crankshaft



M18X1.5 - Right Hand



8 680437 016212

OEM No : 51541135025\* -  
51541135014\*

**01.251** Cover



8 680437 020127

**01.006** Connecting Rod



8 680437 009757

OEM No : 51541066013\*

**RK.01.022.00** Piston&Ring (Ø90,00 mm)

- RK.01.022.10 90,25 mm
- RK.01.022.20 90,50 mm
- RK.01.022.30 90,75 mm
- RK.01.022.40 91,00 mm



2,50x2,50x4,00



8 680437 058526

**01.112.00** Piston (Ø90,00 mm)

- 01.112.10 90,25 mm
- 01.112.20 90,50 mm
- 01.112.30 90,75 mm
- 01.112.40 91,00 mm



2,50x2,50x4,00



8 680437 016342

**01.138.00** Ring (Ø90,00 mm)

- 01.138.10 90,25 mm
- 01.138.20 90,50 mm
- 01.138.30 90,75 mm
- 01.138.40 91,00 mm



2,50x2,50x4,00



8 680437 018469

OEM No : 06184800232 - 51025030562

**RK.01.018** Cylinder Liner Set



STD.



8 680437 058489

OEM No : 51541056005 - 51541056007 -  
51541056008

**01.059** Cylinder Liner



8 680437 013211

**01.203** Gear



Notch (Tooth) Pcs : 25



8 680437 019503

OEM No : 51542100138

**01.241** Connecting Rod Bearing Kit



8 680437 019985

OEM No : 51541216001

**01.516** Bushing



52X47X21



8 680437 023579

OEM No : 51930200335

**00.985** Roller Bearing



NUP 2209



8 680437 127727

OEM No : 51934200016

## Single Cylinder Compressor Ø90 mm - 292 CC - Stroke 46 mm

Application - Vehicle  
MAN D2866 TGA 33.480 33.360



**01.03.034**

Oem. No.

51541007033  
51541007088



**01.1425**

Crankcase



OEM No : 51541120027 -  
51541120031

**RK.01.290**

Repair Kit



**01.075**

Cover



**RK.01.102**

Complete Cylinder Head



OEM No : 51541146081

Wabco No : 4120908032 - 4120908012 - 4120909202

**RK.01.160.01**

Repair Kit



**RK.01.160**

Repair Kit

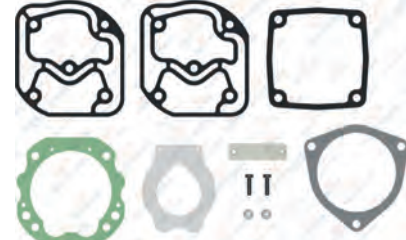

**RK.01.160.02**

Repair Kit

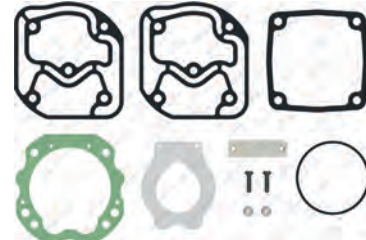

**RK.01.160.03**

Repair Kit

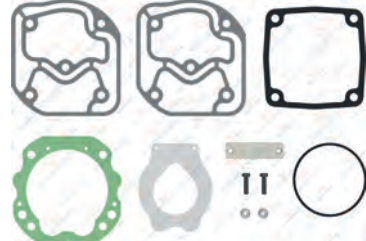

Use for old version cylinder repair kit. Yıpranmış kapaklar için.



**01.431** Cylinder Head



8 680437 022497

**01.430** Cooling Plate



8 680437 022473

**01.432** Valve Plate



8 680437 022510

**01.094** Crankshaft

Oem. Ref. No.



M18X1.5 Right Hand



8 680437 014485

OEM No : 51541135017 - 51541135027

**01.005** Connecting Rod



injection



8 680437 009702

OEM No : 51541066013

**01.006** Connecting Rod



8 680437 009757

**RK.01.022.00** Piston&Ring (Ø90,00 mm)

- RK.01.022.10 90,25 mm
- RK.01.022.20 90,50 mm
- RK.01.022.30 90,75 mm
- RK.01.022.40 91,00 mm



2,50x2,50x4,00



8 680437 058526

**01.112.00** Piston (Ø90,00 mm)

- 01.112.10 90,25 mm
- 01.112.20 90,50 mm
- 01.112.30 90,75 mm
- 01.112.40 91,00 mm



2,50x2,50x4,00



8 680437 016342

**01.138.00** Ring (Ø90,00 mm)

- 01.138.10 90,25 mm
- 01.138.20 90,50 mm
- 01.138.30 90,75 mm
- 01.138.40 91,00 mm



2,50x2,50x4,00



8 680437 018469

OEM No : 06184800232 - 51025030562

**RK.01.018** Cylinder Liner Set



STD.



8 680437 058489

OEM No : 51541056005 - 51541056007 - 51541056008

**01.059** Cylinder Liner



8 680437 013211

**01.020** Crankshaft Flange



8 680437 010081

OEM No : 51541306021

**01.1453** Screw



M18X1.5 Right Hand



8 680437 085256

**01.014** Bushing



34X30X20.5



8 680437 010005

OEM No : 51930201007

**01.1340** Gear



Notch (:Tooth) Pcs : 21



8 680437 072881

OEM No : 51542100152

## Twin Cylinder Compressor Ø90 mm - 547 CC - Stroke 46 mm

Application - Vehicle  
MAN 19.422  
MAN 26.281



### 01.03.035

**Oem. No.**

51540007027  
51540007086  
51540007121  
51540007131



### 01.336 Crankcase



Barcode: 8 680437 021254  
OEM No : 51541126030 - 51541126037

### RK.01.283 Repair Kit

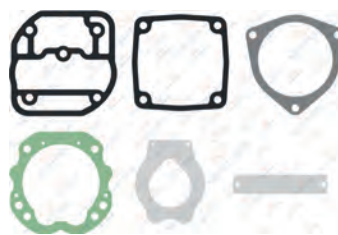

Barcode: 8 680437 063360

### 01.601 Pump Support



Barcode: 8 680437 024507  
OEM No : 51471045004 - 51471045005

### RK.01.019 Complete Cylinder Head



Barcode: 8 680437 058496  
OEM No : 51541146045 - 51541146054  
Wabco No : 4110338062

### RK.01.019.20 Complete Cylinder Head

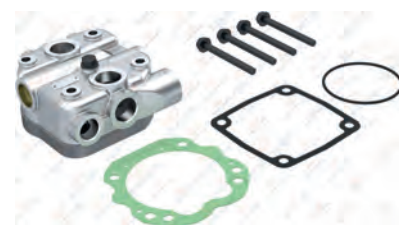

Barcode: 8 680437 075987

### RK.01.013 Valve Plate Kit



Barcode: 8 680437 058410  
OEM No : 81541246013  
Wabco No : 4110335032-4421300120

### RK.01.283.01 Repair Kit

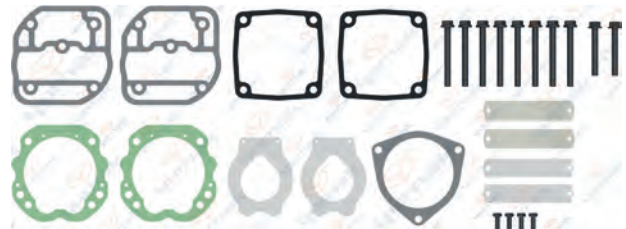

Barcode: 8 680437 063377

### RK.01.283.03 Repair Kit

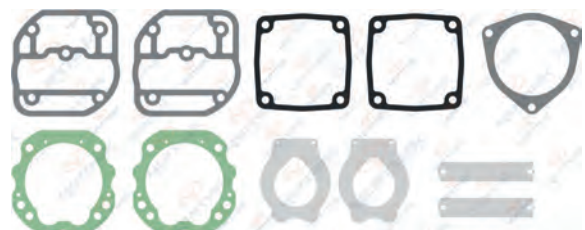

Barcode: 8 680437 063384

**01.070** Cylinder Head



8 680437 014072

**01.122** Valve Plate



8 680437 017783

**01.633** Crankshaft



M18X1.5 - Right Hand



8 680437 024996

**01.246** Gear



Ø84 - Z:25



8 680437 020042

**01.818** Pump Support



8 680437 027027

OEM No : 51541300019

**01.006** Connecting Rod



8 680437 009757

OEM No : 51541066013\*

**RK.01.022.00** Piston&Ring (Ø90,00 mm)

- RK.01.022.10 90,25 mm
- RK.01.022.20 90,50 mm
- RK.01.022.30 90,75 mm
- RK.01.022.40 91,00 mm



2,50x2,50x4,00



8 680437 058526

**01.112.00** Piston (Ø90,00 mm)

- 01.112.10 90,25 mm
- 01.112.20 90,50 mm
- 01.112.30 90,75 mm
- 01.112.40 91,00 mm



2,50x2,50x4,00



8 680437 016342

**01.138.00** Ring (Ø90,00 mm)

- 01.138.10 90,25 mm
- 01.138.20 90,50 mm
- 01.138.30 90,75 mm
- 01.138.40 91,00 mm



2,50x2,50x4,00



8 680437 018469

OEM No : 06184800232 - 51025030562

**RK.01.018** Cylinder Liner Set



STD.



8 680437 058489

OEM No : 51541056005 - 51541056007 - 51541056008

**01.059** Cylinder Liner



8 680437 013211

**01.204** Screw



M18X1.5 - Right Hand



8 680437 019510

**01.241** Connecting Rod Bearing Kit



8 680437 019985

OEM No : 51541216001

**01.516** Bushing



52X47X21



8 680437 023579

OEM No : 51930200335

**00.985** Roller Bearing



NUP 2209



8 680437 127727

OEM No : 51934200016



## Twin Cylinder Compressor Ø90 mm - 547 CC - Stroke 46 mm

Application - Vehicle  
MAN 19.362 / D2866UM



**01.03.036**

Oem. No.  
51540007082



**01.266** Crankcase



OEM No : 51541126026 -  
51541126029

**RK.01.283** Repair Kit

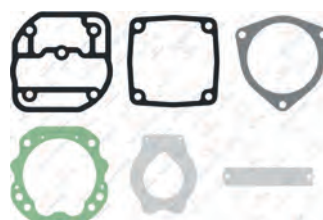

8 680437 063360

**01.952** Cap



8 680437 028772

**RK.01.019** Complete Cylinder Head



OEM No : 51541146045 - 51541146054  
Wabco No : 4110338062

**RK.01.019.20** Complete Cylinder Head

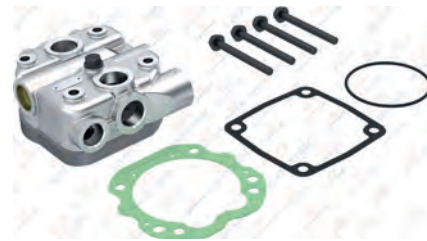

8 680437 073987

**RK.01.013** Valve Plate Kit



OEM No : 81541246013  
Wabco No : 4110335032

**RK.01.283.01** Repair Kit

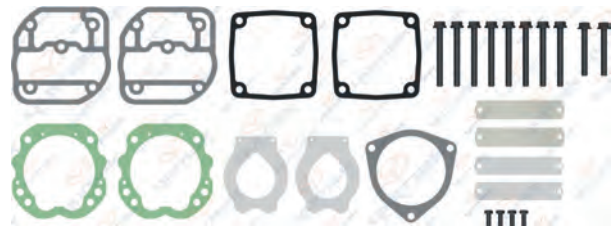

8 680437 063377

**RK.01.283.03** Repair Kit

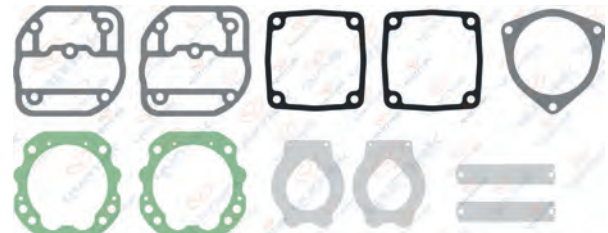

8 680437 063384

**01.070** Cylinder Head



8 680437 014072

**01.122** Valve Plate



8 680437 017783

**01.096** Crankshaft



8 680437 014515

OEM No : 51541135014 - 51541135025 - 51541130038

**01.203** Gear



8 680437 019503

OEM No : 51542100138

**01.005** Connecting Rod



8 680437 009702

injection

OEM No : 51541066013

**01.006** Connecting Rod



8 680437 009757

**RK.01.022.00** Piston&Ring (Ø90,00 mm)

- RK.01.022.10 90,25 mm
- RK.01.022.20 90,50 mm
- RK.01.022.30 90,75 mm
- RK.01.022.40 91,00 mm



2,50x2,50x4,00



8 680437 058526

**01.112.00** Piston (Ø90,00 mm)

- 01.112.10 90,25 mm
- 01.112.20 90,50 mm
- 01.112.30 90,75 mm
- 01.112.40 91,00 mm



2,50x2,50x4,00



8 680437 016342

**01.138.00** Ring (Ø90,00 mm)

- 01.138.10 90,25 mm
- 01.138.20 90,50 mm
- 01.138.30 90,75 mm
- 01.138.40 91,00 mm



2,50x2,50x4,00



8 680437 018469

OEM No : 06184800232 - 51025030562

**RK.01.018** Cylinder Liner Set



STD.



8 680437 058489

OEM No : 51541056005 - 51541056007 - 51541056008

**01.059** Cylinder Liner



8 680437 013211

**01.204** Screw



M18X1.5 - Right Hand



8 680437 019510

**01.241** Connecting Rod Bearing Kit



8 680437 019985

OEM No : 51541216001

**01.516** Bushing



52X47X21



8 680437 023579

OEM No : 51930200335

**00.981** Roller Bearing



NUP 209



8 680437 009443

OEM No : 51934200015

## Twin Cylinder Compressor Ø90 mm - 547 CC - Stroke 46 mm

Application - Vehicle  
MAN LIONS STAR / LIONS COACH  
TOURLINER / D2876 ENGINE  
D2866 ENGINE



**01.03.038**

Oem. No.  
51541006001



**01.336** Crankcase



OEM No : 51541126030 -  
51541126037

**RK.01.283** Repair Kit

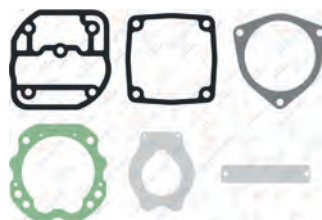

8 680437 063360

**RK.01.183** Repair Kit



8 680437 061878

**RK.01.019** Complete Cylinder Head



OEM No : 51541146045 - 51541146054  
Wabco No : 4110338062

**RK.01.019.20** Complete Cylinder Head



8 680437 075987

**RK.01.013** Valve Plate Kit

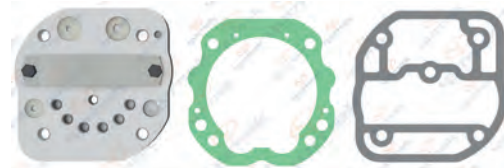

OEM No : 81541246013  
Wabco No : 4110335032

**RK.01.283.01** Repair Kit

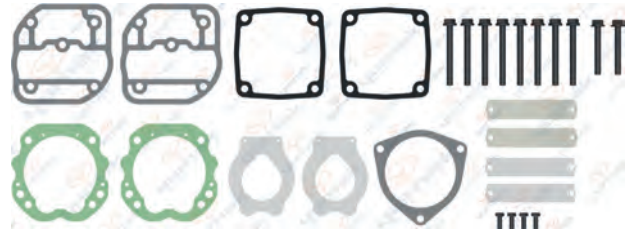

8 680437 063377

**RK.01.283.03** Repair Kit

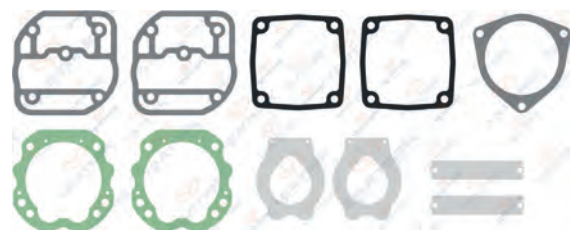

8 680437 063384



**01.070** Cylinder Head



8 680437 014072

**01.122** Valve Plate



8 680437 017783

**01.567** Crankshaft



8 680437 024118

OEM No : 51541135044

**01.568** Gear



Ø84 - Z:25



8 680437 024125

**01.005** Connecting Rod



injection



8 680437 009702

OEM No : 51541066013

**01.006** Connecting Rod



8 680437 009757

**RK.01.022.00** Piston&Ring (Ø90,00 mm)

- RK.01.022.10 90,25 mm
- RK.01.022.20 90,50 mm
- RK.01.022.30 90,75 mm
- RK.01.022.40 91,00 mm



2,50x2,50x4,00



8 680437 058526

**01.112.00** Piston (Ø90,00 mm)

- 01.112.10 90,25 mm
- 01.112.20 90,50 mm
- 01.112.30 90,75 mm
- 01.112.40 91,00 mm



2,50x2,50x4,00



8 680437 016342

**01.138.00** Ring (Ø90,00 mm)

- 01.138.10 90,25 mm
- 01.138.20 90,50 mm
- 01.138.30 90,75 mm
- 01.138.40 91,00 mm



2,50x2,50x4,00



8 680437 018469

OEM No : 06184800232 - 51025030562

**RK.01.018** Cylinder Liner Set



STD.



8 680437 058489

OEM No : 51541056005 - 51541056007 - 51541056008

**01.059** Cylinder Liner



8 680437 013211

**00.985** Roller Bearing



NUP 2209



8 680437 127727

OEM No : 51934200016

**01.251** Cover



8 680437 020127

**01.702** Gear



Ø84 - Z:25



8 680437 025696

OEM No : 51542100182

**01.241** Connecting Rod Bearing Kit



8 680437 019985

OEM No : 51541216001

## Twin Cylinder Compressor Ø90 mm - 547 CC - Stroke 46 mm

Application - Vehicle  
MAN TGA



**01.03.039**

Oem. No.  
51541006009



**01.084** Crankcase

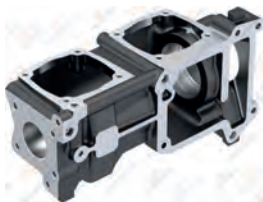

OEM No : 51541126033 -  
51541126020

**RK.01.290** Repair Kit



8 680437 063445

**RK.01.102** Complete Cylinder Head



OEM No : 51541146081  
Wabco No : 4120908032 - 4120908012 - 4120909202

**RK.01.065.01** Repair Kit

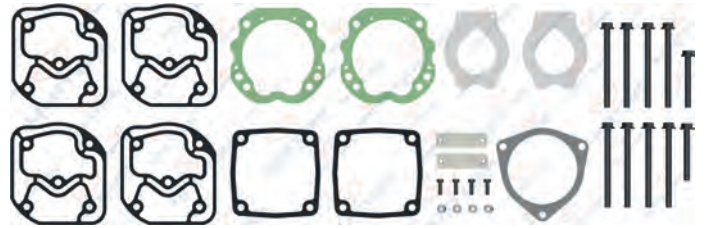

8 680437 059417

**RK.01.065** Repair Kit

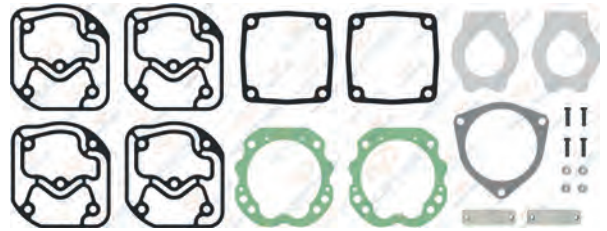

8 680437 059394

**RK.01.065.04** Repair Kit

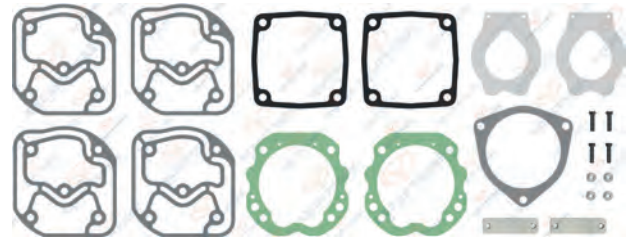

8 680437 059424

Use for old version cylinder Repair kit. Yıpranmış kapaklar için.

**RK.01.160.02** Repair Kit

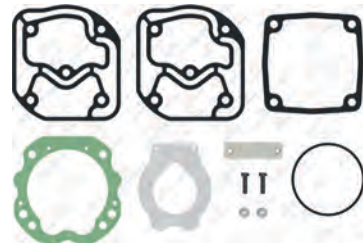

8 680437 119081

**01.952** Cap



8 680437 028772

**01.431** Cylinder Head



8 680437 022497

**01.430** Cooling Plate

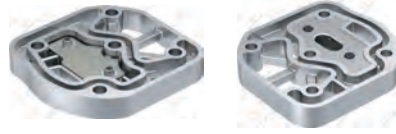

8 680437 022473

**01.432** Valve Plate



8 680437 022510

**01.572** Crankshaft



OEM No : 51541135020

**01.818** Pump Support



OEM No : 51541300019

**01.006** Connecting Rod



OEM No : 51541066013\*

**RK.01.022.00** Piston&Ring (Ø90,00 mm)

- RK.01.022.10 90,25 mm
- RK.01.022.20 90,50 mm
- RK.01.022.30 90,75 mm
- RK.01.022.40 91,00 mm



2,50x2,50x4,00



8 680437 058526

**01.112.00** Piston (Ø90,00 mm)

- 01.112.10 90,25 mm
- 01.112.20 90,50 mm
- 01.112.30 90,75 mm
- 01.112.40 91,00 mm



2,50x2,50x4,00



8 680437 016342

**01.138.00** Ring (Ø90,00 mm)

- 01.138.10 90,25 mm
- 01.138.20 90,50 mm
- 01.138.30 90,75 mm
- 01.138.40 91,00 mm



2,50x2,50x4,00



8 680437 018469

OEM No : 06184800232 - 51025030562

**RK.01.018** Cylinder Liner Set



STD.



8 680437 058489

OEM No : 51541056005 - 51541056007 - 51541056008

**01.059** Cylinder Liner



8 680437 013211

**01.599** Gear



Ø84 - Z:23



8 680437 024484

OEM No : 51542100124

**01.241** Connecting Rod Bearing Kit



8 680437 019985

OEM No : 51541216001

**01.516** Bushing



52X47X21



8 680437 023579

OEM No : 51930200335

**00.981** Roller Bearing

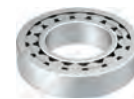

NUP 209



8 680437 009443

OEM No : 51934200015



## Twin Cylinder Compressor Ø90 mm - 547 CC - Stroke 46 mm

Application - Vehicle  
MAN TGA



**01.03.040**

Oem. No.  
51541007010



**01.336** Crankcase



OEM No : 51541126030 -  
51541126037

**RK.01.290** Repair Kit



8 680437 063445

**01.952** Cap



8 680437 028772

**RK.01.102**

Complete Cylinder Head



8 680437 060253

OEM No : 51541146081  
Wabco No : 4120908032 - 4120908012 - 4120909202

**RK.01.065.01**

Repair Kit

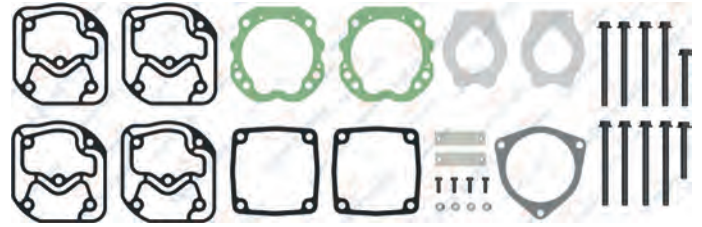

8 680437 059417

**RK.01.065**

Repair Kit

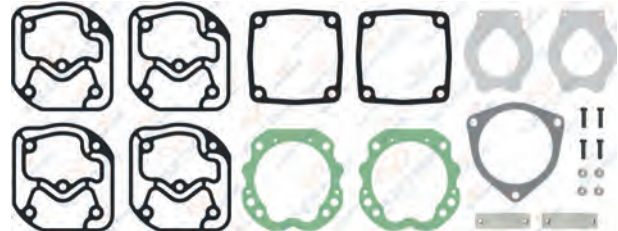

8 680437 059394

**RK.01.065.04**

Repair Kit

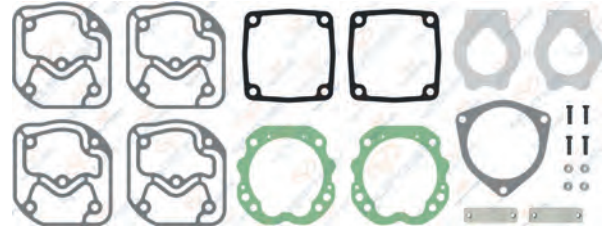

8 680437 059424

Use for old version cylinder Repair kit. Yıpranmış kapaklar için.

**RK.01.160.02**

Repair Kit

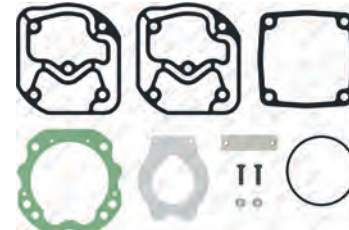

8 680437 119081

**01.431** Cylinder Head



8 680437 022497

**01.430** Cooling Plate



8 680437 022473

**01.432** Valve Plate



8 680437 022510

**01.567** Crankshaft



OEM No : 51541135044

**01.251** Cover



8 680437 020127

**01.006** Connecting Rod



OEM No : 51541066013\*

**RK.01.022.00** Piston&Ring (Ø90,00 mm)

- RK.01.022.10 90,25 mm
- RK.01.022.20 90,50 mm
- RK.01.022.30 90,75 mm
- RK.01.022.40 91,00 mm



2,50x2,50x4,00



8 680437 058526

**01.112.00** Piston (Ø90,00 mm)

- 01.112.10 90,25 mm
- 01.112.20 90,50 mm
- 01.112.30 90,75 mm
- 01.112.40 91,00 mm



2,50x2,50x4,00



8 680437 016342

**01.138.00** Ring (Ø90,00 mm)

- 01.138.10 90,25 mm
- 01.138.20 90,50 mm
- 01.138.30 90,75 mm
- 01.138.40 91,00 mm



2,50x2,50x4,00



8 680437 018469

OEM No : 06184800232 - 51025030562

**RK.01.018** Cylinder Liner Set



STD.



OEM No : 51541056005 - 51541056007 - 51541056008

**01.059** Cylinder Liner



8 680437 013211

**01.924** Gear



Ø75.5 - Z:23



OEM No : 51542100135

**01.241** Connecting Rod Bearing Kit



OEM No : 51541216001

**01.516** Bushing



52X47X21



OEM No : 51930200335

**00.985** Roller Bearing



NUP 2209



OEM No : 51934200016



## Twin Cylinder Compressor Ø90 mm - 547 CC - Stroke 46 mm

Application - Vehicle  
MAN TGA

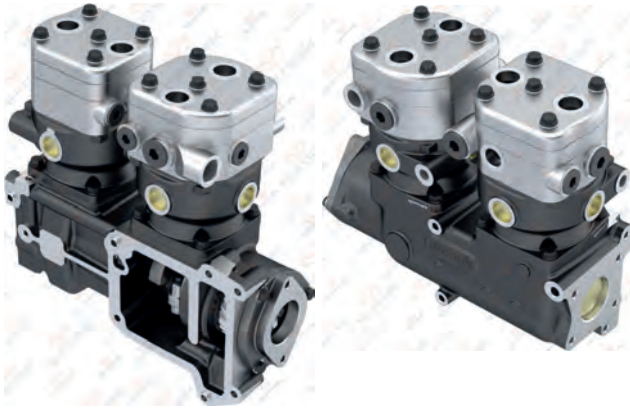

**01.03.041**

Oem. No.  
51541007066



**01.336** Crankcase



OEM No : 51541126030 -  
51541126037

**RK.01.290** Repair Kit



8 680437 063445

**01.952** Cap



8 680437 028772

**RK.01.102** Complete Cylinder Head



OEM No : 51541146081  
Wabco No : 4120908032 - 4120908012 - 4120909202

**RK.01.065.01** Repair Kit

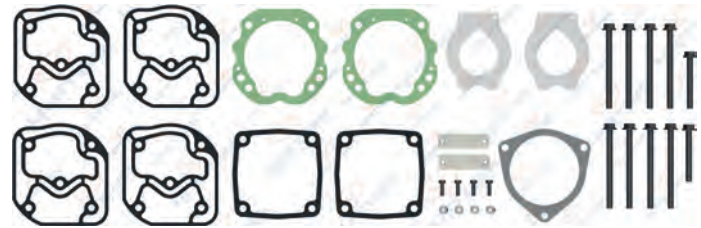

8 680437 059417

**RK.01.065** Repair Kit

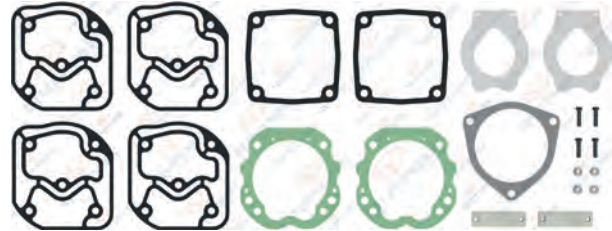

8 680437 059394

**RK.01.065.04** Repair Kit

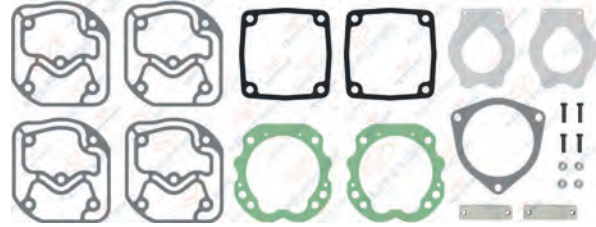

8 680437 059424

Use for old version cylinder Repair kit. Yıpranmış kapaklar için.

**RK.01.160.02** Repair Kit

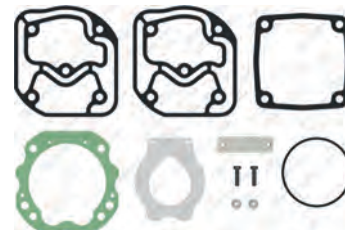

8 680437 119081



**01.431** Cylinder Head



**01.430** Cooling Plate



**01.432** Valve Plate



**01.633** Crankshaft



M18X1.5 - Right Hand



**01.818** Pump Support



OEM No : 51541300019

**01.006** Connecting Rod



OEM No : 51541066013\*

**RK.01.022.00** Piston&Ring (Ø90,00 mm)

- RK.01.022.10 90,25 mm
- RK.01.022.20 90,50 mm
- RK.01.022.30 90,75 mm
- RK.01.022.40 91,00 mm



2,50x2,50x4,00



**01.112.00** Piston (Ø90,00 mm)

- 01.112.10 90,25 mm
- 01.112.20 90,50 mm
- 01.112.30 90,75 mm
- 01.112.40 91,00 mm



2,50x2,50x4,00



**01.138.00** Ring (Ø90,00 mm)

- 01.138.10 90,25 mm
- 01.138.20 90,50 mm
- 01.138.30 90,75 mm
- 01.138.40 91,00 mm



2,50x2,50x4,00



OEM No : 06184800232 - 51025030562

**RK.01.018** Cylinder Liner Set



STD.



OEM No : 51541056005 - 51541056007 - 51541056008

**01.059** Cylinder Liner



**01.246** Gear



Ø84 - Z25



OEM No : 51542100140

**00.985** Roller Bearing



NUP 2209



OEM No : 51934200016

**01.516** Bushing



52X47X21



OEM No : 51930200335

**01.204** Screw



M18X1.5 - Right Hand



## Twin Cylinder Compressor Ø90 mm - 547 CC - Stroke 46 mm

Application - Vehicle  
MAN TGA



**01.03.043**

Oem. No.  
51541006003



**01.336** Crankcase



OEM No : 51541126030 -  
51541126037

**RK.01.290** Repair Kit



OEM No : 51541126030 -  
51541126037

**RK.01.102** Complete Cylinder Head



OEM No : 51541146081  
Wabco No : 4120908032 - 4120908012 - 4120909202

**RK.01.065.01** Repair Kit

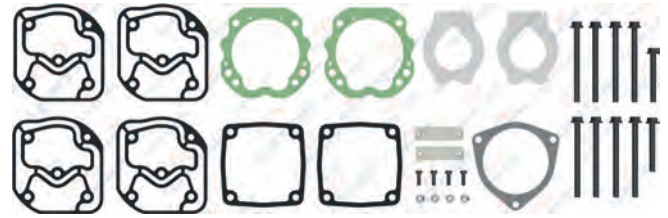

OEM No : 51541146081  
Wabco No : 4120908032 - 4120908012 - 4120909202

**RK.01.065** Repair Kit

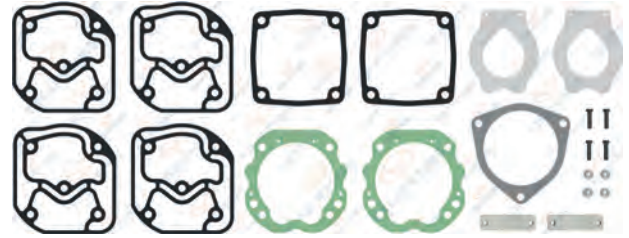

OEM No : 51541146081  
Wabco No : 4120908032 - 4120908012 - 4120909202

**RK.01.065.04** Repair Kit

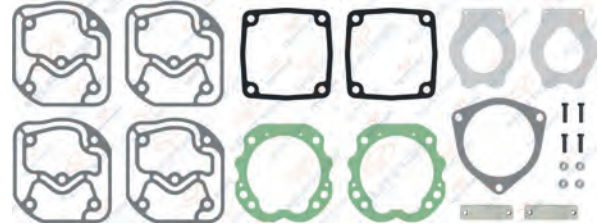

OEM No : 51541146081  
Wabco No : 4120908032 - 4120908012 - 4120909202  
Use for old version cylinder Repair kit. Yıpranmış kapaklar için.

**RK.01.160.02** Repair Kit

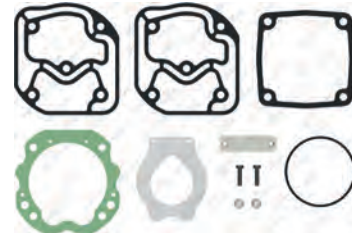

OEM No : 51541146081  
Wabco No : 4120908032 - 4120908012 - 4120909202

**01.601** Pump Support



OEM No : 51471045004 -  
51471045005

**01.431** Cylinder Head



**01.430** Cooling Plate

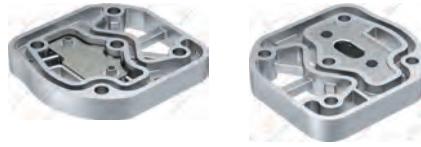

**01.432** Valve Plate

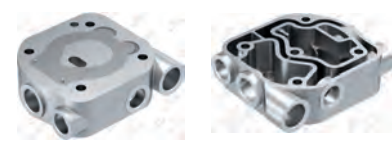

**01.633** Crankshaft



M18X1.5 - Right Hand



**01.818** Pump Support



OEM No : 51541300019



**01.006** Connecting Rod



OEM No : 51541066013\*



**RK.01.022.00** Piston & Ring (Ø90,00 mm)

- RK.01.022.10 90,25 mm
- RK.01.022.20 90,50 mm
- RK.01.022.30 90,75 mm
- RK.01.022.40 91,00 mm



2,50x2,50x4,00



**01.112.00** Piston (Ø90,00 mm)

- 01.112.10 90,25 mm
- 01.112.20 90,50 mm
- 01.112.30 90,75 mm
- 01.112.40 91,00 mm



2,50x2,50x4,00



**01.138.00** Ring (Ø90,00 mm)

- 01.138.10 90,25 mm
- 01.138.20 90,50 mm
- 01.138.30 90,75 mm
- 01.138.40 91,00 mm



2,50x2,50x4,00



OEM No : 06184800232 - 51025030562

**RK.01.018** Cylinder Liner Set



STD.

OEM No : 51541056005 - 51541056007 - 51541056008



**01.059** Cylinder Liner



**01.599** Gear



Ø84 - Z23

OEM No : 51542100124



**00.985** Roller Bearing



NUP 2209

OEM No : 51934200016



**01.516** Bushing



52X47X21

OEM No : 51930200335



**01.204** Screw



M18X1.5 - Right Hand





## Twin Cylinder Compressor Ø90 mm - 547 CC - Stroke 46 mm

Application - Vehicle  
MAN F 2000 NEOPLAN  
MAN 19.422 26.281 19.423



### 01.03.018

**Oem. No.**

51540007079  
51540007135  
51540007130  
51540007113



### 01.084 Crankcase



Barcode: 8 680437 014317  
OEM No : 51541126033 - 51541126020

### RK.01.283 Repair Kit

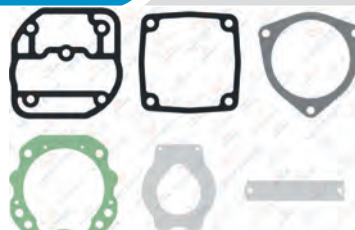

Barcode: 8 680437 063360

### RK.01.019 Complete Cylinder Head



Barcode: 8 680437 058496  
OEM No : 51541146045 - 51541146054  
Wabco No : 4110338062

### RK.01.019.20 Complete Cylinder Head

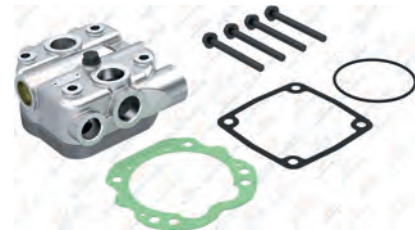

Barcode: 8 680437 075987

### RK.01.013 Valve Plate Kit

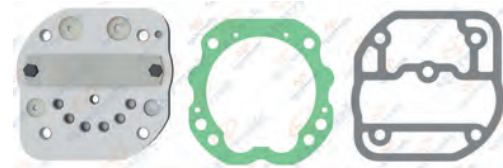

Barcode: 8 680437 058410  
OEM No : 81541246013  
Wabco No : 4110335032

### RK.01.283.01 Repair Kit

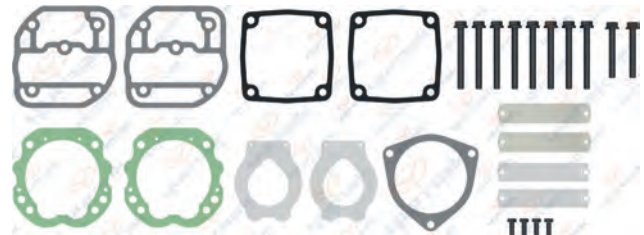

Barcode: 8 680437 063377

### RK.01.283.03 Repair Kit

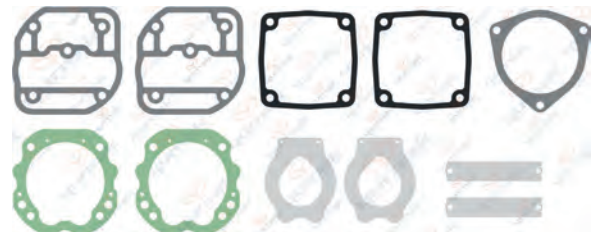

Barcode: 8 680437 063384

### 01.952 Cap



Barcode: 8 680437 028772

**01.070** Cylinder Head



8 680437 014072

**01.122** Valve Plate



8 680437 017783

**01.096** Crankshaft



8 680437 014515

OEM No : 51541135014 - 51541135025 - 51541130038

**01.203** Gear



8 680437 019503

OEM No : 51542100138

**01.005** Connecting Rod



8 680437 009702

OEM No : 51541066013

**01.006** Connecting Rod



8 680437 009757

**RK.01.022.00** Piston&Ring (Ø90,00 mm)

- RK.01.022.10 90,25 mm
- RK.01.022.20 90,50 mm
- RK.01.022.30 90,75 mm
- RK.01.022.40 91,00 mm



2,50x2,50x4,00



8 680437 058526

**01.112.00** Piston (Ø90,00 mm)

- 01.112.10 90,25 mm
- 01.112.20 90,50 mm
- 01.112.30 90,75 mm
- 01.112.40 91,00 mm



2,50x2,50x4,00



8 680437 016342

**01.138.00** Ring (Ø90,00 mm)

- 01.138.10 90,25 mm
- 01.138.20 90,50 mm
- 01.138.30 90,75 mm
- 01.138.40 91,00 mm



2,50x2,50x4,00



8 680437 018469

OEM No : 06184800232 - 51025030562

**RK.01.018** Cylinder Liner Set



STD.



8 680437 058489

OEM No : 51541056005 - 51541056007 - 51541056008

**01.059** Cylinder Liner



8 680437 013211

**01.204** Screw



M18X1.5 - Right Hand



8 680437 019510

**01.241** Connecting Rod Bearing Kit



8 680437 019985

OEM No : 51541216001

**01.516** Bushing



52X47X21



8 680437 023579

OEM No : 51930200335

**00.981** Roller Bearing



NUP 209



8 680437 009443

OEM No : 51934200015

## Single Cylinder Compressor Ø90 mm - 292 CC - Stroke 46 mm

Application - Vehicle  
MAN 19.260 / 19.360 / 19.361 / 1919 / 1922

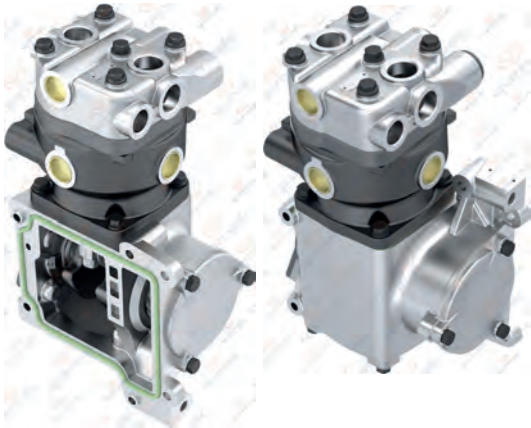

**01.03.004 - 01.03.016**

Oem. No.

51540007074  
51540007059



**01.083**

Crankcase



OEM No : 51541126003 -  
51541126008

**RK.01.056.21**

Repair Kit



**RK.01.183**

Repair Kit



**RK.01.019**

Complete Cylinder Head



OEM No : 51541146045 - 51541146054  
Wabco No : 4110338062

**RK.01.019.20**

Complete Cylinder Head

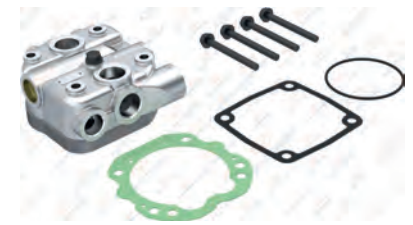

**RK.01.013**

Valve Plate Kit



OEM No : 81541246013  
Wabco No : 4110335032

**RK.01.056.01**

Repair Kit

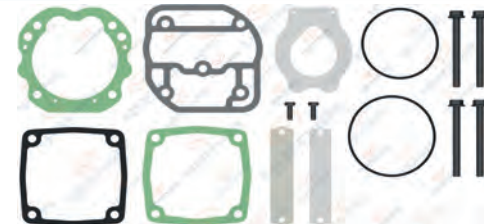

**RK.01.056**

Repair Kit





**01.070** Cylinder Head



8 680437 014072

**01.020** Crankshaft Flange



OEM No : 51541306021

**01.094** Crankshaft



M18X1.5 Right Hand



OEM No : 51541135017 - 51541135027

**01.122** Valve Plate



8 680437 017783

**01.577** Gasket



OEM No : 51961010048

**01.006** Connecting Rod



OEM No : 51541066013\*

**RK.01.022.00** Piston&Ring (Ø90,00 mm)

- RK.01.022.10 90,25 mm
- RK.01.022.20 90,50 mm
- RK.01.022.30 90,75 mm
- RK.01.022.40 91,00 mm



2,50x2,50x4,00



8 680437 058526

**01.112.00** Piston (Ø90,00 mm)

- 01.112.10 90,25 mm
- 01.112.20 90,50 mm
- 01.112.30 90,75 mm
- 01.112.40 91,00 mm



2,50x2,50x4,00



8 680437 016342

**01.138.00** Ring (Ø90,00 mm)

- 01.138.10 90,25 mm
- 01.138.20 90,50 mm
- 01.138.30 90,75 mm
- 01.138.40 91,00 mm



2,50x2,50x4,00



8 680437 018469

OEM No : 06184800232 - 51025030562

**RK.01.018** Cylinder Liner Set



STD.



8 680437 058489

OEM No : 51541056005 - 51541056007 - 51541056008

**01.059** Cylinder Liner



8 680437 013211

**01.052** Gear



Notch (Tooth) Pcs : 20



8 680437 013112

OEM No : 51542100038

**00.460** Roller Bearing



Nup 306



8 680437 004714

**01.074** Cover

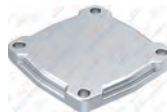

8 680437 014140

**01.075** Cover



8 680437 014157

## Single Cylinder Compressor Ø90 mm - 292 CC - Stroke 46 mm

**Application - Vehicle**  
MAN 19.260 / 19.360 / 19.361 /  
1919 / 1922

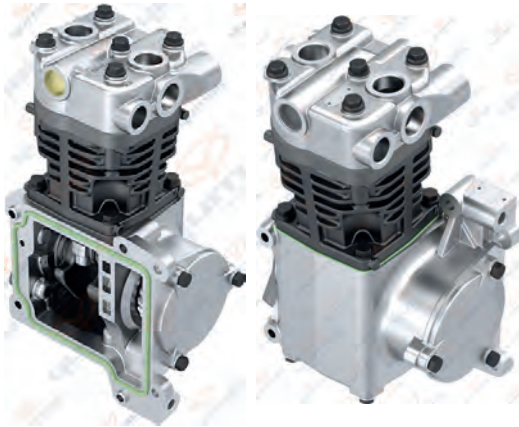

**01.03.009-01.03.011**

**Oem. No.**  
51540007058  
51540007057



**01.083** Crankcase



**OEM No :** 51541126003 -  
51541126008

**RK.01.056.21** Repair Kit



**OEM No :** 51541126003 -  
51541126008

**RK.01.019** Complete Cylinder Head



**OEM No :** 51541146045 - 51541146054  
**Wabco No :** 4110338062

**RK.01.019.20** Complete Cylinder Head

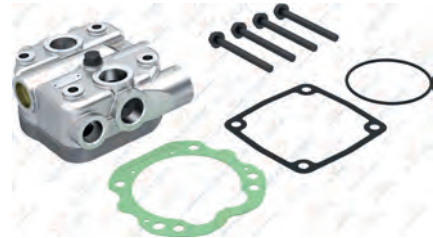

**OEM No :** 51541146045 - 51541146054  
**Wabco No :** 4110338062

**RK.01.013** Valve Plate Kit



**OEM No :** 81541246013  
**Wabco No :** 4110335032

**RK.01.056.01** Repair Kit

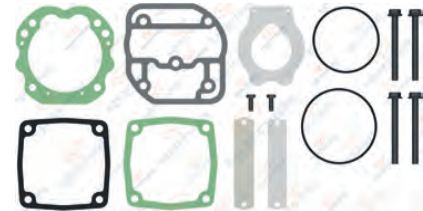

**OEM No :** 51541126003 - 51541126008  
**Wabco No :** 4110335032

**RK.01.056** Repair Kit

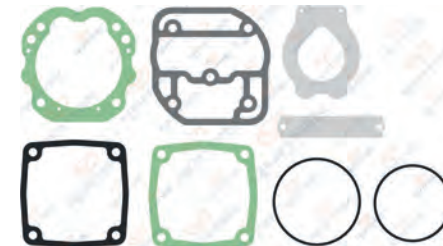

**OEM No :** 51541126003 - 51541126008  
**Wabco No :** 4110335032

**RK.01.183** Repair Kit



**OEM No :** 51541126003 - 51541126008  
**Wabco No :** 4110335032

**01.070** Cylinder Head



8 680437 014072

**01.020** Crankshaft Flange



OEM No : 51541306021

**01.094** Crankshaft



M18X1.5 Right Hand



OEM No : 51541135017 - 51541135027

**01.122** Valve Plate



8 680437 017783

**01.577** Gasket



OEM No : 51961010048

**01.006** Connecting Rod



OEM No : 51541066013\*

**RK.01.022.00** Piston&Ring (Ø90,00 mm)

- RK.01.022.10 90,25 mm
- RK.01.022.20 90,50 mm
- RK.01.022.30 90,75 mm
- RK.01.022.40 91,00 mm



2,50x2,50x4,00



8 680437 058526

**01.112.00** Piston (Ø90,00 mm)

- 01.112.10 90,25 mm
- 01.112.20 90,50 mm
- 01.112.30 90,75 mm
- 01.112.40 91,00 mm



2,50x2,50x4,00



8 680437 016342

**01.138.00** Ring (Ø90,00 mm)

- 01.138.10 90,25 mm
- 01.138.20 90,50 mm
- 01.138.30 90,75 mm
- 01.138.40 91,00 mm



2,50x2,50x4,00



8 680437 018469

OEM No : 06184800232 - 51025030562

**RK.01.014** Cylinder Liner Set



STD.



OEM No : 51541056006

**01.058** Cylinder Liner



8 680437 013198

**01.052** Gear



Notch (Tooth) Pcs : 20



OEM No : 51542100038

**01.241** Connecting Rod Bearing Kit



OEM No : 51541216001

**01.014** Bushing



34X30X20.5



OEM No : 51930201007

**01.028** Screw



M18X1.5 Right Hand



8 680437 010173



## Single Cylinder Compressor Ø90 mm - 292 CC - Stroke 46 mm

Application - Vehicle  
MAN 1919 / 1922

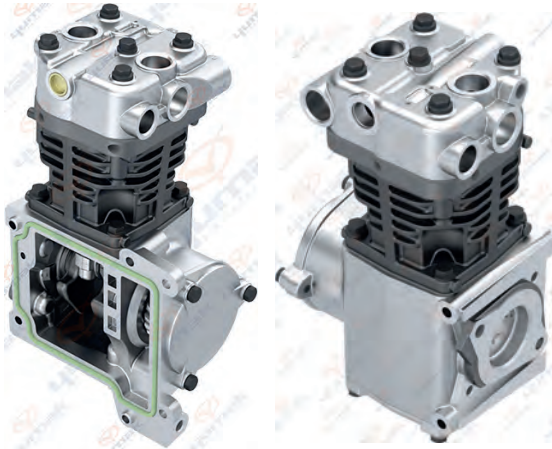

**01.03.025**

Oem. No.  
51540007058



**01.083** Crankcase



OEM No : 51541126003 -  
51541126008



**RK.01.357** Repair Kit



**RK.01.068** Complete Cylinder Head



Knorr No : ZB4275



**RK.01.035** Valve Plate Kit



**RK.01.037.01** Repair Kit

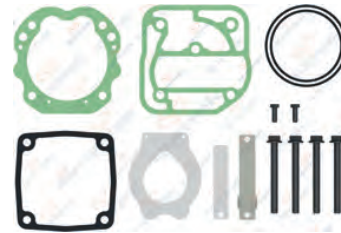

**RK.01.037** Repair Kit

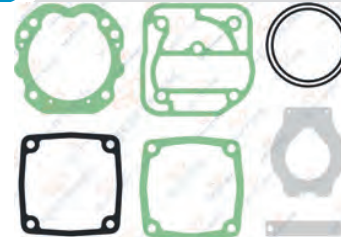

**RK.01.037.02** Repair Kit



**01.577** Gasket



OEM No : 51961010048

**01.076** Cylinder Head



8 680437 014164

**01.139** Valve Plate



8 680437 018537

**01.094** Crankshaft



M18X1.5 Right Hand



OEM No : 51541135017 - 51541135027

**01.687** Crankshaft Flange



8 680437 025528

**01.020** Crankshaft Flange



OEM No : 51541306021

**01.006** Connecting Rod



OEM No : 51541066013\*

**RK.01.022.00** Piston&Ring (Ø90,00 mm)

- RK.01.022.10 90,25 mm
- RK.01.022.20 90,50 mm
- RK.01.022.30 90,75 mm
- RK.01.022.40 91,00 mm



2,50x2,50x4,00



8 680437 058526

**01.112.00** Piston (Ø90,00 mm)

- 01.112.10 90,25 mm
- 01.112.20 90,50 mm
- 01.112.30 90,75 mm
- 01.112.40 91,00 mm



2,50x2,50x4,00



8 680437 016342

**01.138.00** Ring (Ø90,00 mm)

- 01.138.10 90,25 mm
- 01.138.20 90,50 mm
- 01.138.30 90,75 mm
- 01.138.40 91,00 mm



2,50x2,50x4,00



8 680437 018469

OEM No : 06184800232 - 51025030562

**RK.01.014** Cylinder Liner Set



STD.



OEM No : 51541056006  
Wabco No : 4421300008

**01.058** Cylinder Liner



8 680437 013198

**01.052** Gear



Notch (Tooth) Pcs : 20



OEM No : 51542100038

**01.241** Connecting Rod Bearing Kit



OEM No : 51541216001

**00.460** Roller Bearing

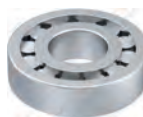

NUP 306



8 680437 004714

**01.028** Screw



M18X1.5 Right Hand



8 680437 010173

# Single Cylinder Compressor Ø90 mm - 292 CC - Stroke 46 mm

Application - Vehicle  
MAN 1919 / 1922

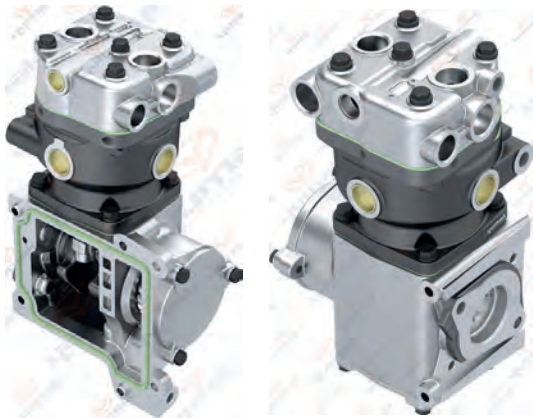

**01.03.029**

Oem. No.  
51540007074



**01.083** Crankcase



Barcode: 8 680437 014294  
OEM No : 51541126003 - 51541126008

**RK.01.357** Repair Kit



Barcode: 8 680437 064305

**RK.01.064** Complete Cylinder Head



Barcode: 8 680437 059387  
Knorr No : ZB4275

**RK.01.040** Valve Plate Kit



Barcode: 8 680437 058946

**RK.01.037.01** Repair Kit

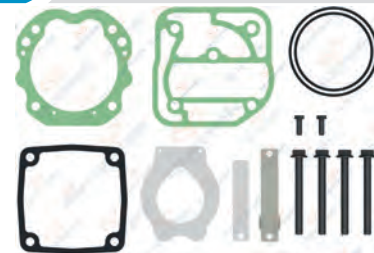

Barcode: 8 680437 058915

**RK.01.037** Repair Kit

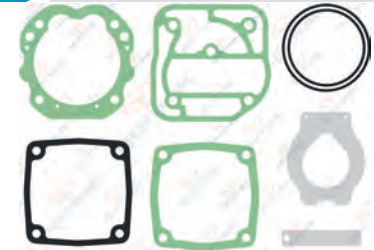

Barcode: 8 680437 058892

**RK.01.037.02** Repair Kit



Barcode: 8 680437 120278

**00.460** Roller Bearing



NUP 306

Barcode: 8 680437 004714



**01.076** Cylinder Head



8 680437 014164

**01.125** Valve Plate



8 680437 018124

**01.094** Crankshaft



M18X1.5 Right Hand



OEM No : 51541135017 - 51541135027

**01.687** Crankshaft Flange



8 680437 025528

**01.020** Crankshaft Flange



OEM No : 51541306021

**01.006** Connecting Rod



OEM No : 51541066013\*

**RK.01.022.00** Piston&Ring (Ø90,00 mm)

- RK.01.022.10 90,25 mm
- RK.01.022.20 90,50 mm
- RK.01.022.30 90,75 mm
- RK.01.022.40 91,00 mm



2,50x2,50x4,00



8 680437 058526

**01.112.00** Piston (Ø90,00 mm)

- 01.112.10 90,25 mm
- 01.112.20 90,50 mm
- 01.112.30 90,75 mm
- 01.112.40 91,00 mm



2,50x2,50x4,00



8 680437 016542

**01.138.00** Ring (Ø90,00 mm)

- 01.138.10 90,25 mm
- 01.138.20 90,50 mm
- 01.138.30 90,75 mm
- 01.138.40 91,00 mm



2,50x2,50x4,00



8 680437 018469

OEM No : 06184800232 - 51025030562

**RK.01.018** Cylinder Liner Set



STD.



OEM No : 51541056005 - 51541056007 - 51541056008

**01.059** Cylinder Liner



8 680437 013211

**01.052** Gear



Notch (Tooth) Pcs : 20



OEM No : 51542100038

**01.241** Connecting Rod Bearing Kit



OEM No : 51541216001

**01.074** Cover



8 680437 014140

**01.075** Cover



8 680437 014157

# Single Cylinder Compressor Ø90 mm - 292 CC - Stroke 46 mm

Application - Vehicle  
MAN



## 01.03.014

Oem. No.

51540007063  
51540007116



8 680437 010326



## 01.087

Crankcase



8 680437 014362

OEM No : 51541125013

## RK.01.056.21

Repair Kit



8 680437 080671

Complete Cylinder Head



8 680437 058496

OEM No : 51541146045 - 51541146054  
Wabco No : 4110338062

## RK.01.019.20

Complete Cylinder Head

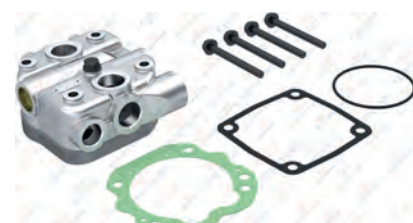

8 680437 075987

## RK.01.013

Valve Plate Kit

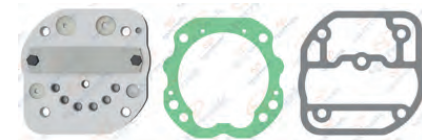

8 680437 058410

OEM No : 81541246013  
Wabco No : 4110335032

## RK.01.056.01

Repair Kit

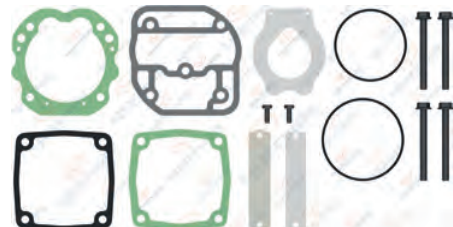

8 680437 059165

## RK.01.056

Repair Kit



8 680437 059141

## RK.01.183

Repair Kit



8 680437 061878

**01.070** Cylinder Head



8 680437 014072

**01.020** Crankshaft Flange



OEM No : 51541306021

**01.093** Crankshaft



OEM No : 4031300114-4031310616-4031311016-51541130023

**01.122** Valve Plate



8 680437 017783

**00.460** Roller Bearing



8 680437 004714

**01.006** Connecting Rod



OEM No : 51541066013\*

**RK.01.022.00** Piston&Ring (Ø90,00 mm)

- RK.01.022.10 90,25 mm
- RK.01.022.20 90,50 mm
- RK.01.022.30 90,75 mm
- RK.01.022.40 91,00 mm



2,50x2,50x4,00



8 680437 058526

**01.112.00** Piston (Ø90,00 mm)

- 01.112.10 90,25 mm
- 01.112.20 90,50 mm
- 01.112.30 90,75 mm
- 01.112.40 91,00 mm



2,50x2,50x4,00



8 680437 016342

**01.138.00** Ring (Ø90,00 mm)

- 01.138.10 90,25 mm
- 01.138.20 90,50 mm
- 01.138.30 90,75 mm
- 01.138.40 91,00 mm



2,50x2,50x4,00



8 680437 018469

OEM No : 06184800232 - 51025030562

**RK.01.018** Cylinder Liner Set



STD.



OEM No : 51541056005 - 51541056007 - 51541056008

**01.059** Cylinder Liner



8 680437 013211

**01.052** Gear



Notch (Tooth) Pcs : 20



OEM No : 51542100038

**01.014** Bushing



34X30X20.5



OEM No : 51930201007

**01.074** Cover



8 680437 014140

**01.075** Cover



8 680437 014157



## Twin Cylinder Compressor Ø90 mm - 547 CC - Stroke 43 mm

Application - Vehicle  
MAN 16.260 / 19.360 / 19.361



01.03.020-01.03.021

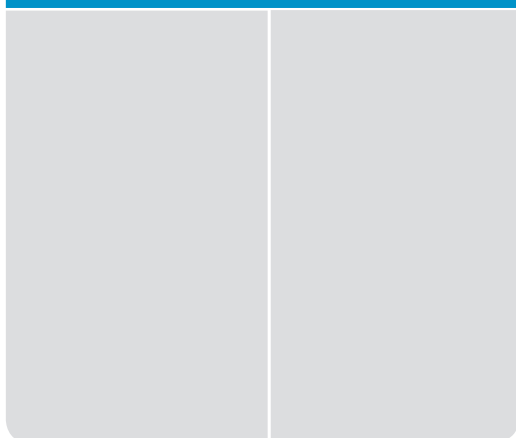

01.101 Gear



OEM No : 4031300030-4421300503  
4031320005-4421300530

01.177 Connecting Rod Bearing Kit



OEM No : 51541216002 - 51541210003

RK.01.015 Complete Cylinder Head



OEM No : 0001302419-0001302519-0001302619  
Knorr No : I60312 - I67880 - ZB4187 - ZB4229

RK.01.016 Valve Plate Kit



Knorr No : I78098

RK.01.313.01 Repair Kit

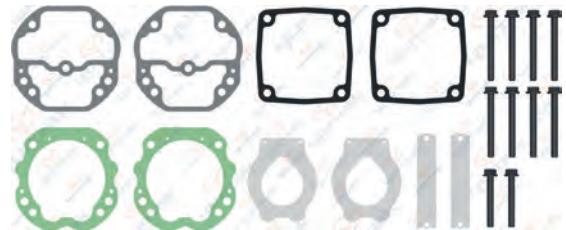

8 680437 063728

RK.01.313 Repair Kit

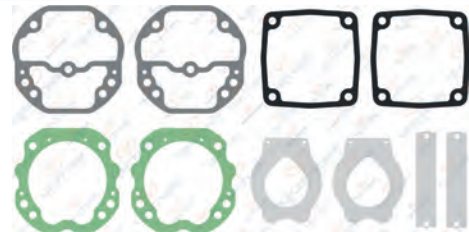

8 680437 063711

RK.01.183 Repair Kit



8 680437 061878

**01.069** Cylinder Head

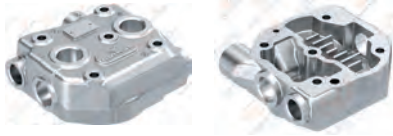

**01.121** Valve Plate



**01.097** Crankshaft



M18X1.5 Right Hand



OEM No : 4031300314 - 4031310816  
- 51541130021 - 51541135032

**01.687** Crankshaft Flange



**01.020** Crankshaft Flange



OEM No : 51541306021

**01.004** Connecting Rod



OEM No : 4031302716 - 51541066015  
- 51541066031

**RK.01.262.00** Piston&Ring (Ø90,00 mm)

- RK.01.262.10 90,25 mm
- RK.01.262.20 90,50 mm
- RK.01.262.30 90,75 mm
- RK.01.262.40 91,00 mm



2,50x2,50x4,00



**01.501.00** Piston (Ø90,00 mm)

- 01.501.10 90,25 mm
- 01.501.20 90,50 mm
- 01.501.30 90,75 mm
- 01.501.40 91,00 mm



2,50x2,50x4,00



**01.138.00** Ring (Ø90,00 mm)

- 01.138.10 90,25 mm
- 01.138.20 90,50 mm
- 01.138.30 90,75 mm
- 01.138.40 91,00 mm



2,50x2,50x4,00



OEM No : 06184800232 - 51025030562

**RK.01.127** Cylinder Liner Set



STD.



**01.059** Cylinder Liner



**01.014** Bushing



34X30X20.5



OEM No : 51930201007

**RK.01.031** Cylinder Liner Set



STD.



**01.058** Cylinder Liner



OEM No : 4031312002 - 51541606006

**01.028** Screw



M18X1.5 Right Hand



## Twin Cylinder Compressor Ø90 mm - 547 CC - Stroke 43 mm

Application - Vehicle  
MAN



**01.03.005-01.03.006**

Oem. No.  
51540007055



**01.087**

Crankcase



OEM No : 51541125013

**01.177**

Connecting Rod Bearing Kit



OEM No : 4421310033 -  
51541216002 - 51541210003

**RK.01.059**

Complete Cylinder Head



OEM No : 4071300719

**RK.01.061**

Valve Plate Kit



OEM No : 4421300220

**RK.01.063**

Repair Kit

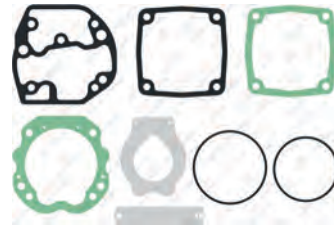

OEM No : 4421300020

**RK.01.063.04**

Repair Kit

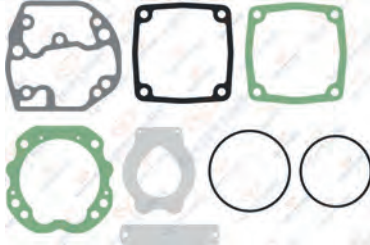

Use for old version cylinder Repair kit. Yıpranmış kapaklar için.

**RK.01.183**

Repair Kit





**01.071** Cylinder Head



8 680437 014096 **OEM No :** 4071300519 - 4071300219

**01.124** Valve Plate



8 680437 018087

**01.097** Crankshaft



**M18X1.5 Right Hand**

8 680437 014539 **OEM No :** 4031300314 - 4031310816 - 51541130021 - 51541135032

**01.687** Crankshaft Flange



8 680437 025528

**01.020** Crankshaft Flange



8 680437 010081 **OEM No :** 51541306021

**01.004** Connecting Rod



8 680437 009696 **OEM No :** 4031302716 - 51541066015 - 51541066031

**RK.01.262.00** Piston&Ring (Ø90,00 mm)

- RK.01.262.10 90,25 mm
- RK.01.262.20 90,50 mm
- RK.01.262.30 90,75 mm
- RK.01.262.40 91,00 mm



2,50x2,50x4,00

8 680437 062929

**01.501.00** Piston (Ø90,00 mm)

- 01.501.10 90,25 mm
- 01.501.20 90,50 mm
- 01.501.30 90,75 mm
- 01.501.40 91,00 mm



2,50x2,50x4,00

8 680437 023371

**01.138.00** Ring (Ø90,00 mm)

- 01.138.10 90,25 mm
- 01.138.20 90,50 mm
- 01.138.30 90,75 mm
- 01.138.40 91,00 mm



2,50x2,50x4,00

8 680437 018469 **OEM No :** 06184800232 - 51025030562

**RK.01.031** Cylinder Liner Set



STD.

8 680437 058762

**01.058** Cylinder Liner



8 680437 013198 **OEM No :** 4031312002 - 51541606006

**01.052** Gear



**Notch (Tooth) Pcs : 20**

8 680437 013112 **OEM No :** 51542100038

**00.460** Roller Bearing



**NUP 306**

8 680437 004714

**01.014** Bushing



**34X30X20.5**

8 680437 010005 **OEM No :** 51930201007

**01.028** Screw



**M18X1.5 Right Hand**

8 680437 010173

## Twin Cylinder Compressor Ø90 mm - 547 CC - Stroke 43 mm

Application - Vehicle  
MAN



### 01.03.007-01.03.008

Oem. No.

51540007064  
51540007075



01.087

Crankcase



OEM No : 51541125013

01.177

Connecting Rod Bearing Kit



OEM No : 4421310033 -  
51541216002 - 51541210003

RK.01.059

Complete Cylinder Head



OEM No : 4071300719

RK.01.061

Valve Plate Kit



OEM No : 4421300220

RK.01.063

Repair Kit



OEM No : 4421300020

RK.01.063.04

Repair Kit

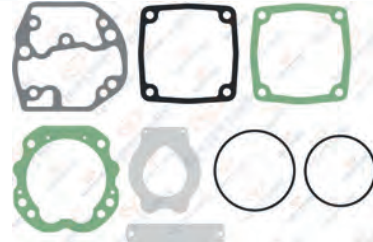

Use for old version cylinder Repair kit. Yıpranmış kapaklar için.

RK.01.183

Repair Kit



**01.071** Cylinder Head



8 680437 014096 **OEM No :** 4071300519 - 4071300219

**01.124** Valve Plate



8 680437 018087

**01.097** Crankshaft



**M18X1.5 Right Hand**

8 680437 014539 **OEM No :** 4031300314 - 4031310816 - 51541130021 - 51541135032

**01.687** Crankshaft Flange



8 680437 025528

**01.020** Crankshaft Flange



8 680437 010081 **OEM No :** 51541306021

**01.004** Connecting Rod



8 680437 009696 **OEM No :** 4031302716 - 51541066015 - 51541066031

**RK.01.262.00** Piston&Ring (Ø90,00 mm)

- RK.01.262.10 90,25 mm
- RK.01.262.20 90,50 mm
- RK.01.262.30 90,75 mm
- RK.01.262.40 91,00 mm



2,50x2,50x4,00

8 680437 062929

**01.501.00** Piston (Ø90,00 mm)

- 01.501.10 90,25 mm
- 01.501.20 90,50 mm
- 01.501.30 90,75 mm
- 01.501.40 91,00 mm



2,50x2,50x4,00

8 680437 023371

**01.138.00** Ring (Ø90,00 mm)

- 01.138.10 90,25 mm
- 01.138.20 90,50 mm
- 01.138.30 90,75 mm
- 01.138.40 91,00 mm



2,50x2,50x4,00

8 680437 018469 **OEM No :** 06184800232 - 51025030562

**RK.01.127** Cylinder Liner Set



STD.

8 680437 060659

**01.059** Cylinder Liner



8 680437 013211

**01.052** Gear



**Notch (Tooth) Pcs : 20**

8 680437 013112 **OEM No :** 51542100038

**00.460** Roller Bearing



**NUP 306**

8 680437 004714

**01.074** Cover



8 680437 014140

**01.075** Cover



8 680437 014157



## Single Cylinder Compressor Ø85 mm - 352 CC - Stroke 62 mm

Application - Vehicle

MAN LE 8T / LE 9T / LE 10T / LE 11T / LE 12T /  
LE 13T / LE 14T / LE 15T / LE 18T / LE 26T  
D0834 ENGINE / D0836 ENGINE



**01.04.033**

Oem. No.  
51541017240

Wabco. No.  
4111510040



**01.1128.10** Crankcase



**RK.01.038** Repair Kit



**RK.01.157** Complete Cylinder Head



OEM No : 51541006043  
Wabco No : 4111519202

**RK.01.158.01** Repair Kit

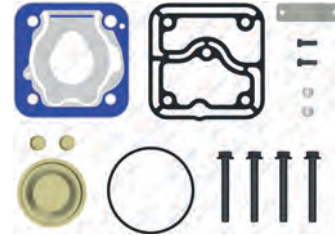

**RK.01.158** Repair Kit

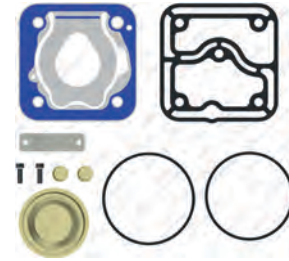

**RK.01.158.04** Repair Kit

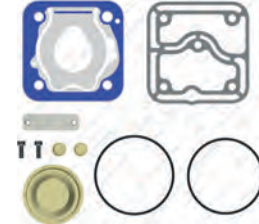

Use for old version cylinder Repair kit. Yıpranmış kapaklar için.

**RK.01.158.02** Repair Kit



**01.376** Cylinder Head



8 680437 021865

**01.845** Valve Plate



8 680437 027416

**01.1150** Crankshaft



**M20X1.5 - Right Hand**



OEM No: 51541130050

**01.1149** Gear



**Ø83 - Z:31**



OEM No: 51542100167 - 51542100118

**01.1151** Crankshaft Flange



8 680437 016878

**01.390** Connecting Rod



OEM No: 51541066023  
Wabco : 9111457382 - 9111457382

**RK.01.104.00** Piston&Ring (Ø85,00 mm)

RK.01.104.10	85,25 mm
RK.01.104.20	85,50 mm
RK.01.104.30	85,75 mm
RK.01.104.40	86,00 mm



**2,00x2,00x4,00**



OEM No: 81541196040

**01.142.00** Piston (Ø85,00 mm)

01.142.10	85,25 mm
01.142.20	85,50 mm
01.142.30	85,75 mm
01.142.40	86,00 mm



**2,00x2,00x4,00**



Wabco : 9115016242 - 9115016252

**01.373.00** Ring (Ø85,00 mm)

01.373.10	85,25 mm
01.373.20	85,50 mm
01.373.30	85,75 mm
01.373.40	86,00 mm



**2,00x2,00x4,00**



Wabco : 9115019202

**01.656** Bushing



**34X30X20**



8 680437 025221

**01.144** Nut



**M20X1.5 - Right Hand**



8 680437 018742

**01.302** Cap



8 680437 020769

## Single Cylinder Compressor Ø85 mm - 352 CC - Stroke 62 mm

Application - Vehicle  
MAN 32.270 EDC 32.270 HX



**01.06.024**

Oem. No.  
51541007005

Wabco No.  
4123520030

**01.06.024.10**

With Gear



**01.1128**

Crankcase



**RK.01.038**

Repair Kit



**RK.01.515**

Complete Cylinder Head



OEM No : 51541146082  
Wabco No : 4123529242

**RK.01.213.01**

Repair Kit

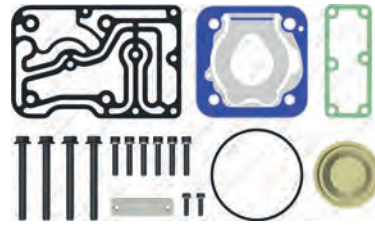

**RK.01.213**

Repair Kit

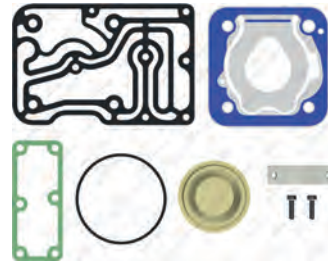

**RK.01.213.04**

Repair Kit

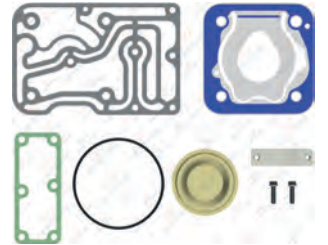

Use for old version cylinder Repair kit. Yıpranmış kapaklar için.

**RK.01.213.03**

Repair Kit

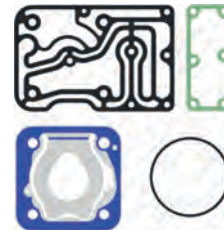

OEM No : 51541006042  
Wabco No : 4123520012



**01.1054** Cylinder Head



8 680437 015314

**01.1052** Valve Plate



8 680437 015284

**01.1150** Crankshaft



M20X1.5 - Right Hand



OEM No: 51541130050

**01.1099** Cover



8 680437 015987

**01.1151** Crankshaft Flange



8 680437 016878

**01.390** Connecting Rod



OEM No: 51541066023

Wabco : 9111457382 - 9111457382

**RK.01.104.00** Piston&Ring (Ø85,00 mm)

- RK.01.104.10 85,25 mm
- RK.01.104.20 85,50 mm
- RK.01.104.30 85,75 mm
- RK.01.104.40 86,00 mm



2,00x2,00x4,00



OEM No: 81541196040

**01.142.00** Piston (Ø85,00 mm)

- 01.142.10 85,25 mm
- 01.142.20 85,50 mm
- 01.142.30 85,75 mm
- 01.142.40 86,00 mm



2,00x2,00x4,00



Wabco : 9115016242 - 9115016252

**01.373.00** Ring (Ø85,00 mm)

- 01.373.10 85,25 mm
- 01.373.20 85,50 mm
- 01.373.30 85,75 mm
- 01.373.40 86,00 mm



2,00x2,00x4,00



Wabco : 9115019202

**01.656** Bushing



34X30X20



8 680437 025221

**01.144** Nut



M20X1.5 - Right Hand



8 680437 018742

**01.1149** Gear



Ø83 - Z:31



OEM No: 51542100167 - 51542100118

**01.302** Cap



8 680437 020769

## Single Cylinder Compressor Ø85 mm - 352 CC - Stroke 62 mm

Application - Vehicle  
MAN  
TGL - TGM NEOPLAN - 12.180



**01.06.060**

Oem. No.	Wabco No.
51541007070	9121160000
51541007071	9121170000



**01.1128** Crankcase



**RK.01.038** Repair Kit



**RK.01.515** Complete Cylinder Head



8 680437 066095  
OEM No : 51541146082  
Wabco No : 4123529242

**RK.01.213.01** Repair Kit

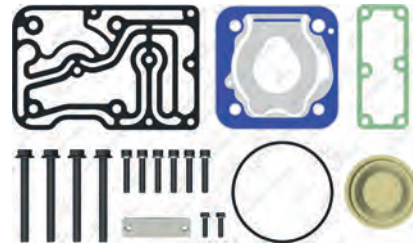

8 680437 062257

**RK.01.213** Repair Kit

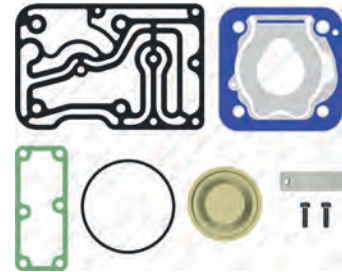

8 680437 062240

**RK.01.213.04** Repair Kit

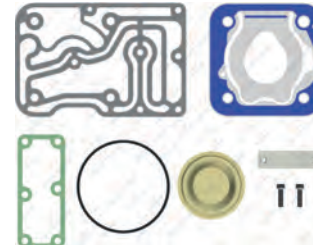

8 680437 062264

Use for old version cylinder Repair kit. Yıpranmış kapaklar için.

**RK.01.213.03** Repair Kit

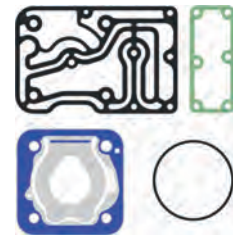

8 680437 119159  
OEM No : 51541006042  
Wabco No : 4123520012

**01.1054** Cylinder Head



8 680437 015314

**01.1052** Valve Plate



8 680437 015284

**01.1125** Crankshaft



M20X1.5 - Right Hand



8 680437 016472

**01.1099** Cover



8 680437 015987

**01.1126** Crankshaft Flange



8 680437 016496

**01.390** Connecting Rod



OEM No: 51541066023  
Wabco : 9111457382 - 9111457382

**RK.01.104.00** Piston&Ring (Ø85,00 mm)

RK.01.104.10	85,25 mm
RK.01.104.20	85,50 mm
RK.01.104.30	85,75 mm
RK.01.104.40	86,00 mm



2,00x2,00x4,00



OEM No: 81541196040

**01.142.00** Piston (Ø85,00 mm)

01.142.10	85,25 mm
01.142.20	85,50 mm
01.142.30	85,75 mm
01.142.40	86,00 mm



2,00x2,00x4,00



Wabco : 9115016242 - 9115016252

**01.373.00** Ring (Ø85,00 mm)

01.373.10	85,25 mm
01.373.20	85,50 mm
01.373.30	85,75 mm
01.373.40	86,00 mm



2,00x2,00x4,00



Wabco : 9115019202

**01.656** Bushing



34X30X20



8 680437 025221

**01.1127** Screw



**01.1152** Gear



Notch (Tooth) Pcs : 27



OEM No: 51542100205

**01.302** Cap



8 680437 020769



## Single Cylinder Compressor Ø85 mm-238 CC-Stroke 42 mm

Application - Vehicle  
MAN  
TGL / TGM / D0834 ENGINE



**01.04.170**

Oem. No.  
51541007171

Wabco No.  
9121160010



**01.1128** Crankcase



**RK.01.038** Repair Kit



**RK.01.157** Complete Cylinder Head



OEM No : 51541006043  
Wabco No : 4111519202

**RK.01.158.01** Repair Kit

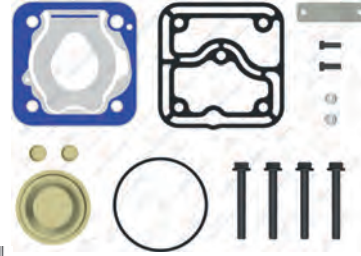

**RK.01.158** Repair Kit

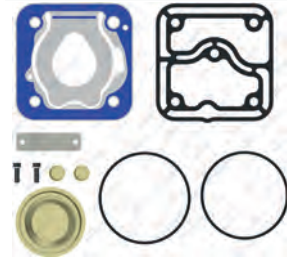

**RK.01.158.04** Repair Kit

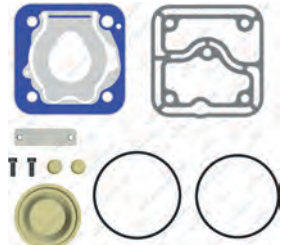

Use for old version cylinder Repair kit. Yıpranmış kapaklar için.

**RK.01.158.02** Repair Kit



**01.376** Cylinder Head



8 680437 021865

**01.845** Valve Plate

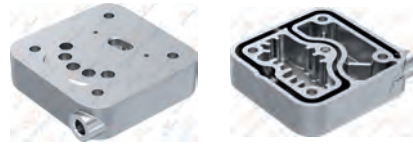

8 680437 027416

**01.1125** Crankshaft



M18x1.5 - Right Hand



8 680437 016472

**01.656** Bushing



34X30X20



8 680437 025221

**01.1126** Crankshaft Flange



8 680437 016496

**01.390** Connecting Rod



8 680437 022015

OEM No: 51541066023

Wabco : 9111457382 - 9111457382

**RK.01.104.00** Piston&Ring (Ø85,00 mm)

- RK.01.104.10 85,25 mm
- RK.01.104.20 85,50 mm
- RK.01.104.30 85,75 mm
- RK.01.104.40 86,00 mm



2,00x2,00x4,00



8 680437 060277

OEM No: 81541196040

**01.142.00** Piston (Ø85,00 mm)

- 01.142.10 85,25 mm
- 01.142.20 85,50 mm
- 01.142.30 85,75 mm
- 01.142.40 86,00 mm



2,00x2,00x4,00



8 680437 018674

Wabco : 9115016242 - 9115016252

**01.373.00** Ring (Ø85,00 mm)

- 01.373.10 85,25 mm
- 01.373.20 85,50 mm
- 01.373.30 85,75 mm
- 01.373.40 86,00 mm



2,00x2,00x4,00



8 680437 075431

Wabco : 9115019202

**RK.01.800** Connecting Rod & Piston



STD.



8 680437 078302

**01.204** Screw



M18x1.5 - Right Hand



8 680437 019510

**01.1152** Gear



Notch (Tooth) Pcs : 27



8 680437 016908

OEM No: 51542100205

**01.302** Cap



8 680437 020769

## Single Cylinder Compressor Ø85 mm-352 CC-Stroke 62 mm

Application - Vehicle  
MAN  
TGL / TGM / D0834 ENGINE



**01.04.099**

Wabco No.  
4111540010



**01.1128**

Crankcase



**RK.01.038**

Repair Kit



**RK.01.515**

Complete Cylinder Head



OEM No : 51541146082  
Wabco No : 4123529242

**RK.01.213.01**

Repair Kit

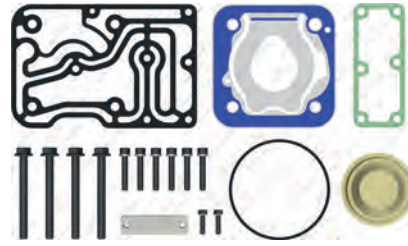

**RK.01.213**

Repair Kit

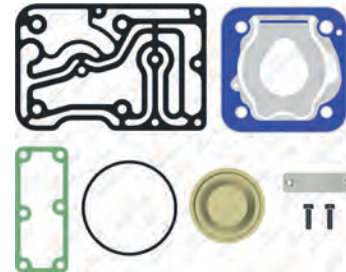

**RK.01.213.04**

Repair Kit

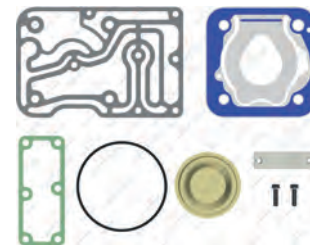

Use for old version cylinder Repair kit. Yıpranmış kapaklar için.

**RK.01.213.03**

Repair Kit

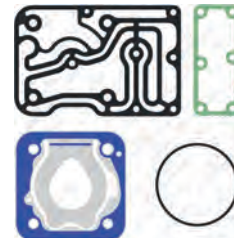

OEM No : 51541006042  
Wabco No : 4123520012



**01.1054** Cylinder Head



8 680437 015314

**01.1052** Valve Plate



8 680437 015284

**01.1125** Crankshaft



M20X1.5 - Right Hand



8 680437 016472

**01.1099** Cover



8 680437 015987

**01.1126** Crankshaft Flange



8 680437 016496

**01.390** Connecting Rod



8 680437 022015

OEM No: 51541066023  
Wabco : 9111457382 - 9111457382

**RK.01.104.00** Piston&Ring (Ø85,00 mm)

- RK.01.104.10 85,25 mm
- RK.01.104.20 85,50 mm
- RK.01.104.30 85,75 mm
- RK.01.104.40 86,00 mm



2,00x2,00x4,00



OEM No: 81541196040

**01.142.00** Piston (Ø85,00 mm)

- 01.142.10 85,25 mm
- 01.142.20 85,50 mm
- 01.142.30 85,75 mm
- 01.142.40 86,00 mm



2,00x2,00x4,00



Wabco : 9115016242 - 9115016252

**01.373.00** Ring (Ø85,00 mm)

- 01.373.10 85,25 mm
- 01.373.20 85,50 mm
- 01.373.30 85,75 mm
- 01.373.40 86,00 mm



2,00x2,00x4,00



Wabco : 9115019202

**01.656** Bushing



34X30X20



8 680437 025221

**01.144** Nut



M20X1.5 - Right Hand



8 680437 018742

**01.1152** Gear



Notch (Tooth) Pcs : 27



8 680437 016908

OEM No: 51542100205

**01.302** Cap



8 680437 020769

## Single Cylinder Compressor Ø88 mm-300 CC-Stroke 50 mm

Application - Vehicle  
MAN 26.230 26.270



### 01.04.022

Oem. No.  
51541017205

Knorr No.  
LK3927-194064  
LK3944  
LK3954



8 680437 010951



### 01.255 Crankcase



8 680437 020196

### RK.01.068.02

Complete Cylinder Head



8 680437 105565

### RK.01.035.02

Valve Plate Kit

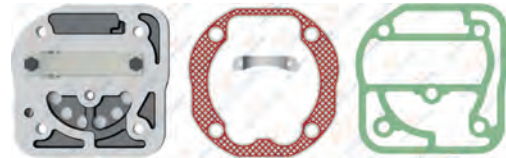

8 680437 112435

Knorr No : I880570061 - II38716F004

### RK.01.149.01

Repair Kit

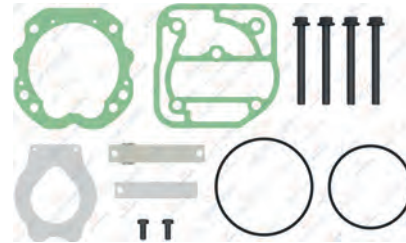

8 680437 061281

### RK.01.149

Repair Kit

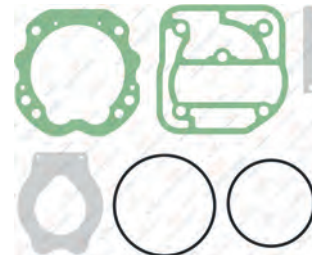

8 680437 061267

### RK.01.149.02

Repair Kit



8 680437 121534

### RK.01.149.06 Repair Kit



8 680437 121510

### RK.01.149.05 Repair Kit

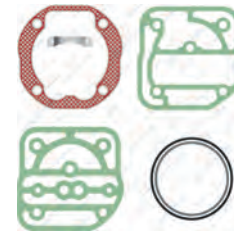

8 680437 121503

**01.076** Cylinder Head



8 680437 014164

**01.139** Valve Plate



Knorr No : II38715F004

**01.254** Crankshaft



M20X1.5 - Right Hand



8 680437 020172

**01.872** Gear



Notch (Tooth) Pcs : 29



OEM No : 51542100070 - 51542100108-51542100089-51542100084

**01.238** Crankshaft Flange



8 680437 019954

**01.008** Connecting Rod



OEM No : 81541060013

**RK.01.034.00** Piston&Ring (Ø88,00 mm)

- RK.01.034.10 88,25 mm
- RK.01.034.20 88,50 mm
- RK.01.034.30 88,75 mm
- RK.01.034.40 89,00 mm



2,50x2,50x4,00



OEM No : A0001302517  
Knorr No : I81169004

**01.110.00** Piston (Ø88,00 mm)

- 01.110.10 88,25 mm
- 01.110.20 88,50 mm
- 01.110.30 88,75 mm
- 01.110.40 89,00 mm



2,50x2,50x4,00



8 680437 015994

**01.136.00** Ring (Ø88,00 mm)

- 01.136.10 88,25 mm
- 01.136.20 88,50 mm
- 01.136.30 88,75 mm
- 01.136.40 89,00 mm



2,50x2,50x4,00



OEM No : 81541036000

**RK.01.032** Cylinder Liner Set



STD.



OEM No : 81541056009  
Knorr No : I789790061

**01.057** Cylinder Liner



OEM No : 81541050024

**01.264** Bushing



34X30X24



8 680437 020301

**RK.01.037.21** Repair Kit

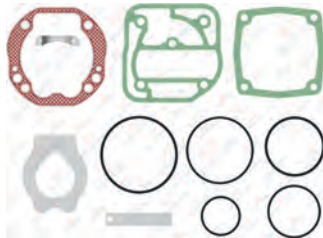

8 680437 120254

**RK.01.357** Repair Kit



8 680437 064305

**01.144** Nut



M20X1.5 - Right Hand



8 680437 018742



## Single Cylinder Compressor Ø88 mm-300 CC-Stroke 50 mm

Application - Vehicle  
MAN 26.230  
L 2000 - M 2000 - Bus - G 90

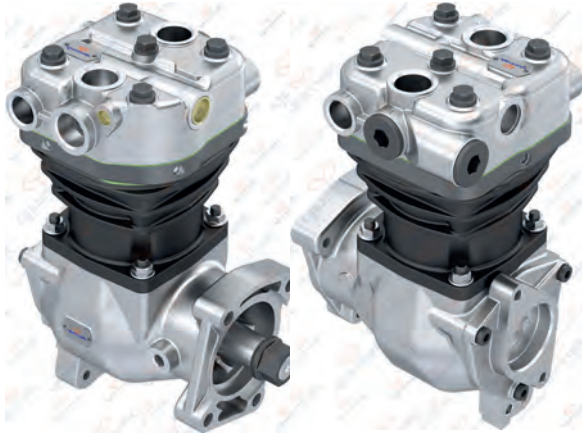

**01.04.090**

Oem. No.	Knorr No.
51541017247	LK3980
51541019247	II36925



**01.255** Crankcase



**RK.01.149.06** Repair Kit



**RK.01.068.02** Complete Cylinder Head



**RK.01.035.02** Valve Plate Kit



Knorr No : I880570061 - II38716F004

**RK.01.149.01** Repair Kit

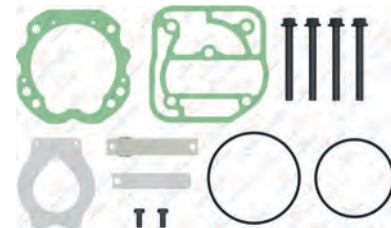

**RK.01.149** Repair Kit

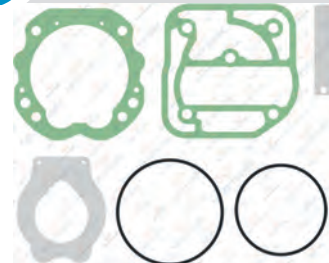

**RK.01.149.02** Repair Kit

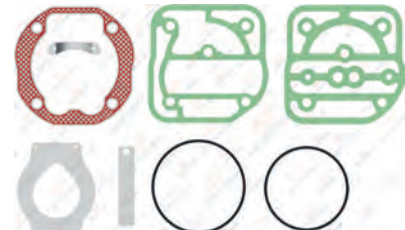

**RK.01.149.05** Repair Kit



**01.076** Cylinder Head



8 680437 014164

**01.139** Valve Plate



Knorr No : II38715F004

**01.992** Crankshaft



M20X1.5 - Right Hand



8 680437 029373

**01.872** Gear



Notch (Tooth) Pcs : 29



OEM No : 51542100070 - 51542100108-51542100089-51542100084

**01.238** Crankshaft Flange



8 680437 019954

**01.008** Connecting Rod



OEM No : 81541060013

**RK.01.034.00** Piston&Ring (Ø88,00 mm)

- RK.01.034.10 88,25 mm
- RK.01.034.20 88,50 mm
- RK.01.034.30 88,75 mm
- RK.01.034.40 89,00 mm



2,50x2,50x4,00



OEM No : A0001302517  
Knorr No : I81169004

**01.110.00** Piston (Ø88,00 mm)

- 01.110.10 88,25 mm
- 01.110.20 88,50 mm
- 01.110.30 88,75 mm
- 01.110.40 89,00 mm



2,50x2,50x4,00



8 680437 015994

**01.136.00** Ring (Ø88,00 mm)

- 01.136.10 88,25 mm
- 01.136.20 88,50 mm
- 01.136.30 88,75 mm
- 01.136.40 89,00 mm



2,50x2,50x4,00



OEM No : 81541036000

**RK.01.032** Cylinder Liner Set



STD.



OEM No : 81541056009  
Knorr No : I789790061

**01.057** Cylinder Liner



OEM No : 81541050024

**01.264** Bushing



34X30X24



8 680437 020301

**RK.01.357** Repair Kit



8 680437 064305

**01.144** Nut



M20X1.5 - Right Hand



8 680437 018742

# Single Cylinder Compressor Ø88 mm-225 CC-Stroke 37 mm

Application - Vehicle  
MAN  
M 2000 - L 2000 - Bus - G 90 - M 90



## 01.04.091

Oem. No.	Knorr No.
51541017204	LK3826-II34069
51541017186	LK3868
51541017171	LK3812-I94063



8 680437 011644



### 01.255 Crankcase



8 680437 020196

### RK.01.068.02

Complete Cylinder Head



8 680437 105565

### RK.01.035.02

Valve Plate Kit



8 680437 112435

Knorr No : I880570061 - II38716F004

### RK.01.149.01

Repair Kit



8 680437 061281

### RK.01.149

Repair Kit

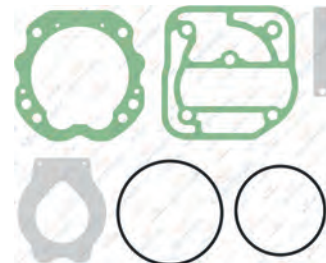

8 680437 061267

### RK.01.149.02

Repair Kit



8 680437 121534

### RK.01.149.06 Repair Kit



8 680437 121510

### RK.01.149.05 Repair Kit



8 680437 121505



**01.076** Cylinder Head



8 680437 014164

**01.1335** Crankshaft



M20X1.5 Right Hand



8 680437 109341

Use for (LK3826 & LK3812)

**01.1334** Crankshaft



8 680437 109396

Use for (LK3868)

**01.139** Valve Plate



8 680437 018537

Knorr No : II38715F004

**01.238** Crankshaft Flange



8 680437 019954

**01.003** Connecting Rod



8 680437 009672

OEM No : 0001311817 - 0001312617

**RK.01.034.00** Piston&Ring (Ø88,00 mm)

- RK.01.034.10 88,25 mm
- RK.01.034.20 88,50 mm
- RK.01.034.30 88,75 mm
- RK.01.034.40 89,00 mm



2,50x2,50x4,00



8 680437 058816

OEM No : A0001302517  
Knorr No : I81169004

**01.110.00** Piston (Ø88,00 mm)

- 01.110.10 88,25 mm
- 01.110.20 88,50 mm
- 01.110.30 88,75 mm
- 01.110.40 89,00 mm



2,50x2,50x4,00



8 680437 015994

**01.136.00** Ring (Ø88,00 mm)

- 01.136.10 88,25 mm
- 01.136.20 88,50 mm
- 01.136.30 88,75 mm
- 01.136.40 89,00 mm



2,50x2,50x4,00



8 680437 018384

OEM No : 8154103600

**RK.01.039** Cylinder Liner Set



std.



8 680437 058939

Knorr No : :I808640061

**01.184** Cylinder Liner



8 680437 019145

**01.264** Bushing



34X30X24



8 680437 020301

**RK.01.357** Repair Kit



8 680437 064305

**01.872** Gear



Notch (Tooth) Pcs : 29



8 680437 027812

OEM No : 51542100070 - 51542100108 -  
51542100089 - 51542100084

## Twin Cylinder Compressor Ø88 mm-600 CC-Stroke 50 mm

Application - Vehicle  
MAN M 2000 - L 2000 - BUS



**01.04.098**

**Oem. No.**

51541019215  
51541017215  
51541007015

**Knorr No.**

LK4931  
II40277F



8 680437 011712



**01.895**

Crankcase



8 680437 028086

**RK.01.277**

Repair Kit

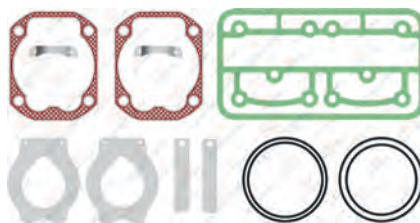

8 680437 063292

**RK.01.277.02**

Repair Kit

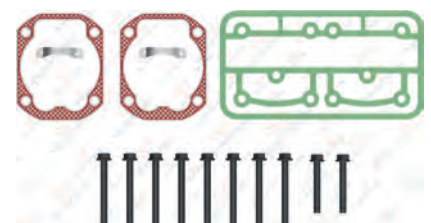

8 680437 110101

OEM No : 81549016014 - 81549016011  
Knorr No : II147790051 - II308970051

**RK.01.455**

Complete Cylinder Head



8 680437 065418

**RK.01.455.10**

Complete Cylinder Head



8 680437 105817

**RK.01.455.11**

Complete Cylinder Head

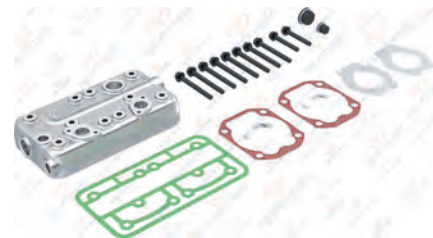

8 680437 100355

Knorr No : K094809K50

**RK.01.457**

Valve Plate Kit



8 680437 065432

Knorr No : K094814K50

**RK.01.277.01**

Repair Kit

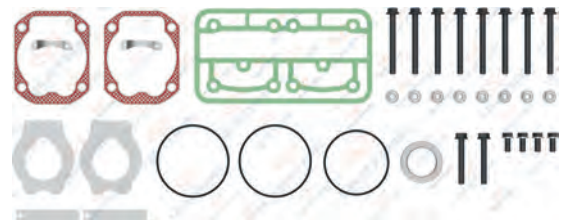

8 680437 063308

Knorr No : K094848K50

**01.893** Cylinder Head



8 680437 028062

**01.894** Valve Plate



8 680437 028079

**01.897** Crankshaft



M16X1.5 Left Hand

8 680437 028123

**01.195** Bushing



34X30X16

8 680437 019411

**01.896** Crankshaft Flange



8 680437 028093

**01.003** Connecting Rod



OEM No : 0001311817 - 0001312617

8 680437 009672

**RK.01.034** Piston&Ring (Ø88,00 mm)

RK.01.034.10	88,25 mm
RK.01.034.20	88,50 mm
RK.01.034.30	88,75 mm
RK.01.034.40	89,00 mm



2,50x2,50x4,00

OEM No : A0001302517  
Knorr No : I81169004

8 680437 058816

**01.110.00** Piston (Ø88,00 mm)

01.110.10	88,25 mm
01.110.20	88,50 mm
01.110.30	88,75 mm
01.110.40	89,00 mm



2,50x2,50x4,00

8 680437 015994

**01.136.00** Ring (Ø88,00 mm)

01.136.10	88,25 mm
01.136.20	88,50 mm
01.136.30	88,75 mm
01.136.40	89,00 mm



2,50x2,50x4,00

OEM No : 81541036000

8 680437 018384

**RK.01.456** Cylinder Liner Set



STD.

OEM No : 51541196003

8 680437 065425

**01.609** Cylinder Liner



8 680437 024590

**01.1279** Gear



Notch (Tooth) Pcs : 30

OEM No : 51542100109

8 680437 072928

**RK.01.191.01** Repair Kit



TTTT

Knorr No : II179740061

8 680437 124184

**01.1261** Screw



M16X1.5 Left Hand

8 680437 085195

**01.1234** Bushing



34X30X18

8 680437 018025



## Twin Cylinder Compressor Ø88 mm-600 CC-Stroke 50 mm

Application - Vehicle  
MAN



**01.04.114**

Oem. No.  
51541007041

Knorr No.  
LK4932  
K000513



**01.1071**

Crankcase



**RK.01.277.05**

Repair Kit

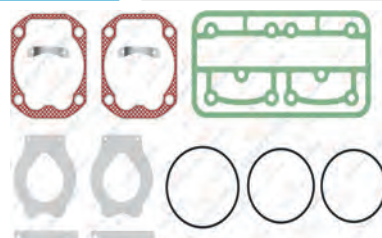

**RK.01.277.02**

Repair Kit

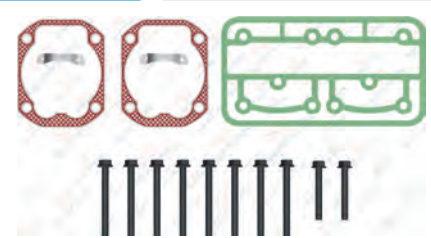

OEM No : 81549016014 - 81549016011  
Knorr No : II147790051 - II308970051

**RK.01.455**

Complete Cylinder Head



**RK.01.455.20**

Complete Cylinder Head

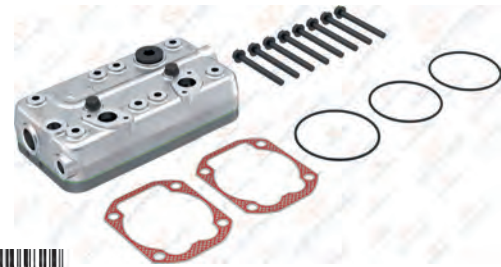

**RK.01.455.11**

Complete Cylinder Head

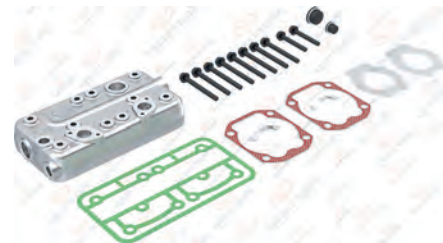

Knorr No : K094809K50

**RK.01.457**

Valve Plate Kit



Knorr No : K094814K50

**RK.01.277.01**

Repair Kit

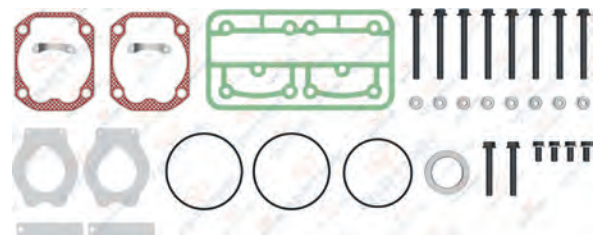

Knorr No : K094848K50

**01.893** Cylinder Head



8 680437 028062

**01.894** Valve Plate



8 680437 028079

**01.1069** Crankshaft



M18X1.5 - Right Hand

8 680437 015499

**01.1146** Bushing



42X38X19

8 680437 016793

**01.1070** Crankshaft Flange



8 680437 015550

**01.003** Connecting Rod



OEM No : 0001311817 - 0001312617

8 680437 009672

**RK.01.034.00** Piston&Ring (Ø88,00 mm)

- RK.01.034.10 88,25 mm
- RK.01.034.20 88,50 mm
- RK.01.034.30 88,75 mm
- RK.01.034.40 89,00 mm



2,50x2,50x4,00

8 680437 058816

OEM No : A0001302517  
Knorr No : I81169004

**01.110.00** Piston (Ø88,00 mm)

- 01.110.10 88,25 mm
- 01.110.20 88,50 mm
- 01.110.30 88,75 mm
- 01.110.40 89,00 mm



2,50x2,50x4,00

8 680437 015994

**01.136.00** Ring (Ø88,00 mm)

- 01.136.10 88,25 mm
- 01.136.20 88,50 mm
- 01.136.30 88,75 mm
- 01.136.40 89,00 mm



2,50x2,50x4,00

8 680437 018384

OEM No : 8154103600

**RK.01.456** Cylinder Liner Set



STD.

8 680437 065425

OEM No : 51541196003

**01.609** Cylinder Liner



8 680437 024590

**01.1185** Gear



Ø83 - Z:31

8 680437 017332

Knorr No : K017284K50

**RK.01.191.01** Repair Kit



8 680437 124184

Knorr No : II179740061

**01.028** Screw



M18X1.5 - Right Hand

8 680437 010173

**01.292** Bushing



42X38X25

8 680437 073871



## Twin Cylinder Compressor Ø88 mm-600 CC-Stroke 50 mm

Application - Vehicle  
MAN TCV BUS - 18.220



**01.04.158**

Oem. No.  
51541007069

Knorr No.  
LK4939  
K095873N00



**01.1071**

Crankcase



**RK.01.277.05**

Repair Kit

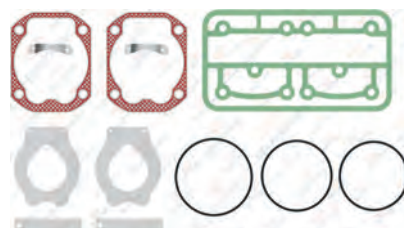

**RK.01.277.02**

Repair Kit

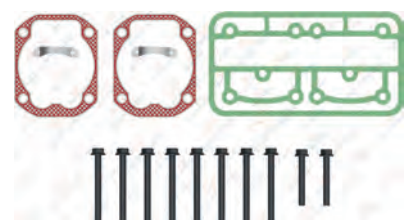

OEM No : 81549016014 - 81549016011  
Knorr No : II147790051 - II308970051

**RK.01.455**

Complete Cylinder Head



**RK.01.455.20**

Complete Cylinder Head

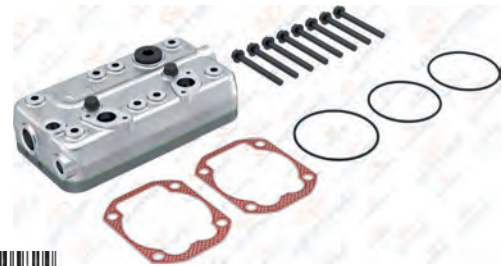

**RK.01.455.11**

Complete Cylinder Head

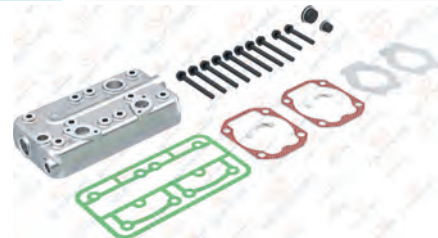

Knorr No : K094809K50

**RK.01.457**

Valve Plate Kit



Knorr No : K094814K50

**RK.01.277.01**

Repair Kit

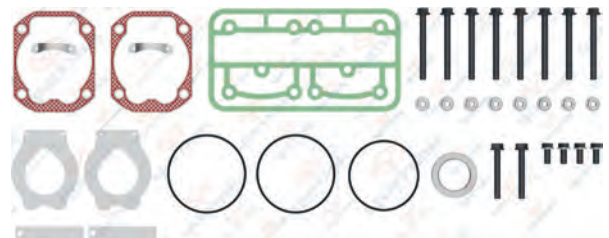

Knorr No : K094848K50



**01.893** Cylinder Head



8 680437 028062

**01.894** Valve Plate



8 680437 028079

**01.1069** Crankshaft



M18X1.5 - Right Hand



8 680437 015499

**01.1146** Bushing



42X38X19



8 680437 016793

**01.1070** Crankshaft Flange

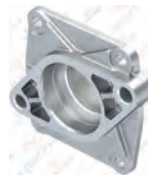

8 680437 015550

**01.003** Connecting Rod



8 680437 009672

OEM No : 0001311817 - 0001312617

**RK.01.034.00** Piston & Ring (Ø88,00 mm)

- RK.01.034.10 88,25 mm
- RK.01.034.20 88,50 mm
- RK.01.034.30 88,75 mm
- RK.01.034.40 89,00 mm



2,50x2,50x4,00



8 680437 058816

OEM No : A0001302517  
Knorr No : I81169004

**01.110.00** Piston (Ø88,00 mm)

- 01.110.10 88,25 mm
- 01.110.20 88,50 mm
- 01.110.30 88,75 mm
- 01.110.40 89,00 mm



2,50x2,50x4,00



8 680437 015994

**01.136.00** Ring (Ø88,00 mm)

- 01.136.10 88,25 mm
- 01.136.20 88,50 mm
- 01.136.30 88,75 mm
- 01.136.40 89,00 mm



2,50x2,50x4,00



8 680437 018384

OEM No : 81541036000

**RK.01.456** Cylinder Liner Set



STD.



8 680437 065425

OEM No : 51541196003

**01.609** Cylinder Liner



8 680437 024590

**01.1152** Gear



Notch (Tooth) Pcs : 27



8 680437 016908

OEM No : 51542100205

**RK.01.191.01** Repair Kit



8 680437 124184

Knorr No : II179740061

**01.028** Screw



M18X1.5 - Right Hand



8 680437 010173

**01.292** Bushing



42X38X25



8 680437 073871

## Single Cylinder Compressor Ø88 mm-225 CC-Stroke 37 mm

Application - Vehicle  
MAN  
OPTARE Alero

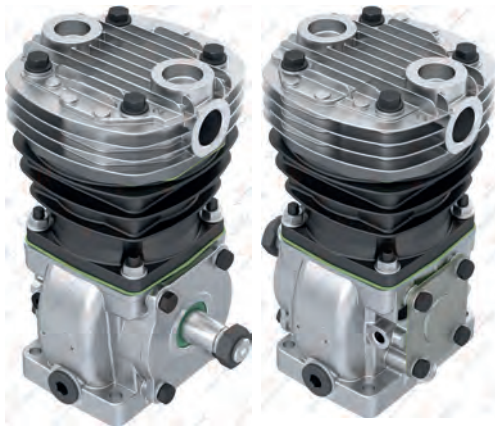

### 01.04.001

Oem. No.  
51541017084

Knorr No.  
LP1806  
I75566



### 01.313

Crankcase

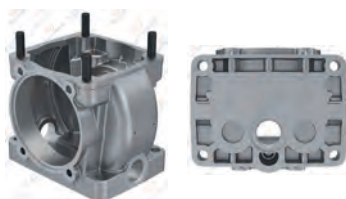

### RK.01.033.02

Repair Kit

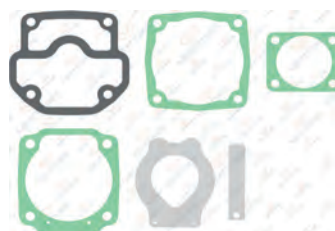

### RK.01.033

Repair Kit

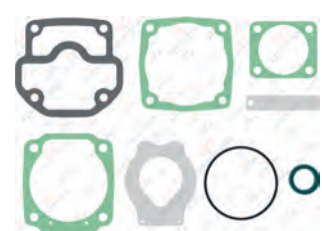

### RK.01.036

Complete Cylinder Head

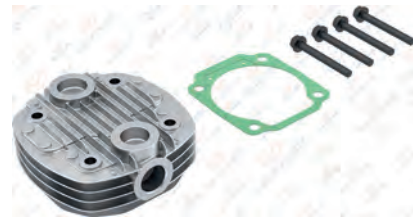

### RK.01.036.01

Complete Cylinder Head



### RK.01.074.01

Valve Plate Kit

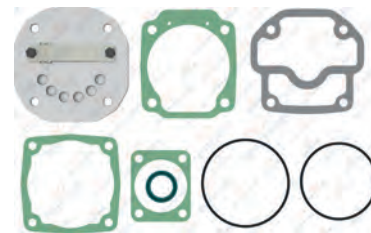

### RK.01.074

Valve Plate Kit

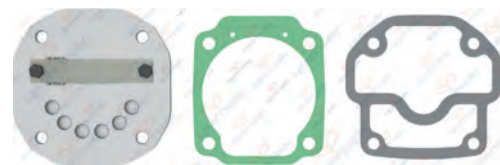

### RK.01.033.01

Repair Kit

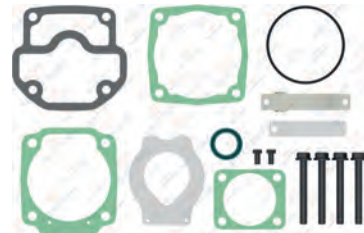

**01.068** Cylinder Head



8 680437 014010

**01.120** Valve Plate



8 680437 017509

**01.188** Crankshaft



M18X1.5 - Right Hand



8 680437 019251

**01.195** Bushing



34X30X16



8 680437 019411

**01.194** Crankshaft Flange



8 680437 019398

**01.003** Connecting Rod



8 680437 009672

OEM No : 0001311817 - 0001312617

**RK.01.034.00** Piston&Ring (Ø88,00 mm)

- RK.01.034.10 88,25 mm
- RK.01.034.20 88,50 mm
- RK.01.034.30 88,75 mm
- RK.01.034.40 89,00 mm



2,50x2,50x4,00



8 680437 058816

OEM No : A0001302517  
Knorr No : I81169004

**01.110.00** Piston (Ø88,00 mm)

- 01.110.10 88,25 mm
- 01.110.20 88,50 mm
- 01.110.30 88,75 mm
- 01.110.40 89,00 mm



2,50x2,50x4,00



8 680437 015994

**01.136.00** Ring (Ø88,00 mm)

- 01.136.10 88,25 mm
- 01.136.20 88,50 mm
- 01.136.30 88,75 mm
- 01.136.40 89,00 mm



2,50x2,50x4,00



8 680437 018384

OEM No : 8154103600

**RK.01.039** Cylinder Liner Set



STD.



8 680437 058939

Knorr No : I808640061

**01.184** Cylinder Liner



8 680437 019145

**01.143** Nut



M18X1.5 - Right Hand



8 680437 018735

**RK.01.033.06** Repair Kit

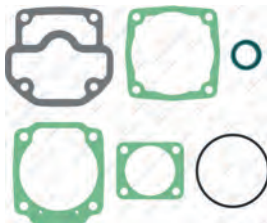

8 680437 078692

**RK.01.357** Repair Kit



8 680437 064305

**01.013** Bushing



34X30X16



8 680437 009993



## Single Cylinder Compressor Ø88 mm-225 CC-Stroke 37 mm

### Application - Vehicle

ПА3 3205-32053-32054 / ПА3 4234 - ПА3 4230  
 КАВ3-4230-01 / ЗМ3-5234.10 / ММ3D245.9  
 ЯМ3-236, 238, 7601,7511  
 ЯМ3-236, 238, 7601,7511  
 ЯМ3-236, 238, 7601,7511

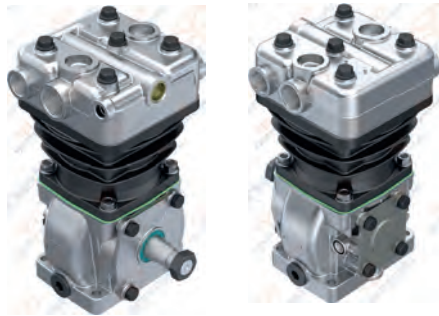

**01.04.080**

**Knorr No.**  
 LK3877  
 K010751  
 K097490N50  
 K010751N50  
 K010751X50



### 01.313 Crankcase

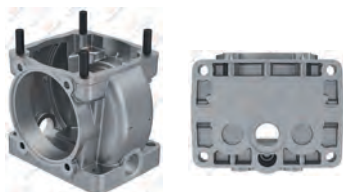

### RK.01.461 Repair Kit



**Knorr No. :** I743300052  
 I771060052

### RK.01.463 Repair Kit

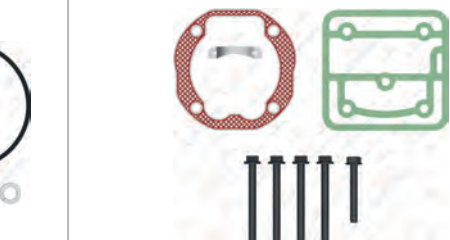

### RK.01.345 Complete Cylinder Head

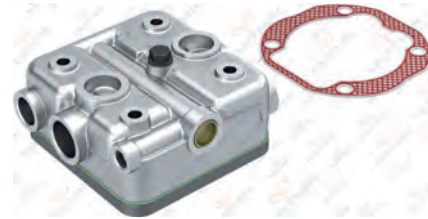

### RK.01.344 Valve Plate Kit



### RK.01.142.01 Repair Kit

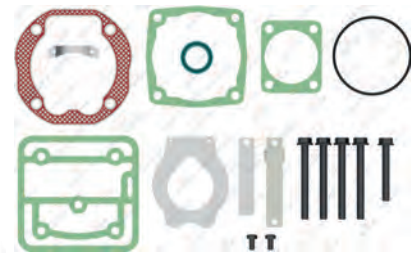

### RK.01.142 Repair Kit

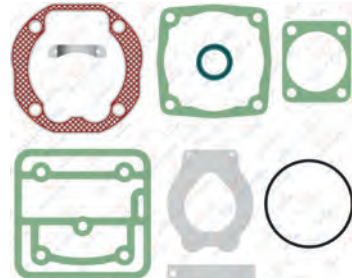

### RK.01.142.02 Repair Kit

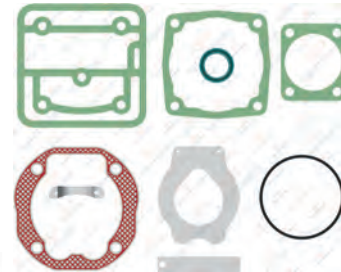

**01.982** Cylinder Head



8 680437 029274

**01.959** Valve Plate



8 680437 028901

**01.764** Crankshaft



M18X1.5 - Right Hand



8 680437 026327

**RK.01.462** Repair Kit



8 680437 065487

Knorr No : K040880

**01.066** Crankshaft Flange



8 680437 015976

**01.003** Connecting Rod



8 680437 009672

OEM No : 0001311817 - 0001312617

**RK.01.034.00** Piston&Ring (Ø88,00 mm)

- RK.01.034.10 88,25 mm
- RK.01.034.20 88,50 mm
- RK.01.034.30 88,75 mm
- RK.01.034.40 89,00 mm



2,50x2,50x4,00



8 680437 058816

OEM No : A0001302517  
Knorr No : I81169004

**01.110.00** Piston (Ø88,00 mm)

- 01.110.10 88,25 mm
- 01.110.20 88,50 mm
- 01.110.30 88,75 mm
- 01.110.40 89,00 mm



2,50x2,50x4,00



8 680437 015994

**01.136.00** Ring (Ø88,00 mm)

- 01.136.10 88,25 mm
- 01.136.20 88,50 mm
- 01.136.30 88,75 mm
- 01.136.40 89,00 mm



2,50x2,50x4,00



8 680437 018384

OEM No : 8154103600

**01.013** Bushing



34X30X16



8 680437 009993

**01.184** Cylinder Liner



8 680437 019145

**00.486** Roller Bearing



NUP 305



8 680437 004974

**01.073** Cover



8 680437 014133

**01.143** Nut



M18X1.5 - Right Hand



8 680437 018735

# Single Cylinder Compressor Ø88 mm-300 CC-Stroke 50 mm

Application - Vehicle  
MAN M 2000



## 01.04.061

Oem. No.	Knorr No.
51541007080	LP3993-K001611
51541017225	LK3960-II40278F



### 01.313 Crankcase

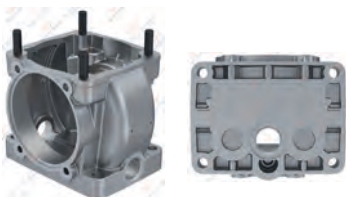

### RK.01.148.02 Repair Kit

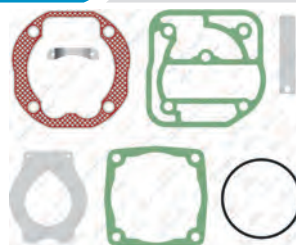

### RK.01.148.03 Repair Kit



### RK.01.068 Complete Cylinder Head



Knorr No : ZB4275

### RK.01.068.01 Complete Cylinder Head

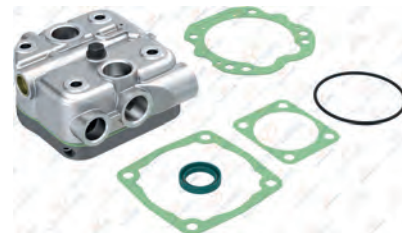

Knorr No : ZB4275\*

### RK.01.035.01 Valve Plate Kit

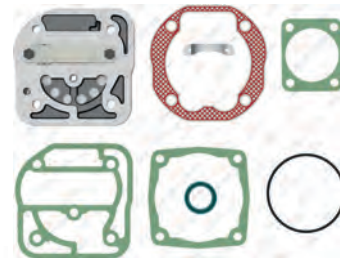

### RK.01.035.02 Valve Plate Kit



Knorr No : I880570061

### RK.01.148 Repair Kit

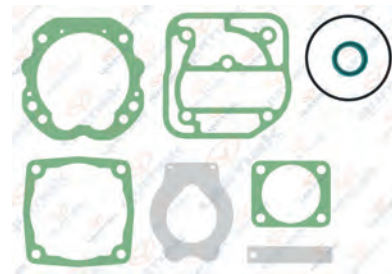



**01.076** Cylinder Head



**01.139** Valve Plate



Knorr No : II38715F004

**01.099** Crankshaft



M18X1.5 - Right Hand



**00.140** Roller Bearing



6305ZC3



**01.066** Crankshaft Flange



**01.008** Connecting Rod



**RK.01.034.00** Piston&Ring (Ø88,00 mm)

- RK.01.034.10 88,25 mm
- RK.01.034.20 88,50 mm
- RK.01.034.30 88,75 mm
- RK.01.034.40 89,00 mm



2,50x2,50x4,00



OEM No : A0001302517  
Knorr No : I81169004

**01.110.00** Piston (Ø88,00 mm)

- 01.110.10 88,25 mm
- 01.110.20 88,50 mm
- 01.110.30 88,75 mm
- 01.110.40 89,00 mm



2,50x2,50x4,00



**01.136.00** Ring (Ø88,00 mm)

- 01.136.10 88,25 mm
- 01.136.20 88,50 mm
- 01.136.30 88,75 mm
- 01.136.40 89,00 mm



2,50x2,50x4,00



OEM No : 81541036000

**RK.01.032** Cylinder Liner Set



STD.



OEM No : 81541056009  
Knorr No : I789790061

**01.057** Cylinder Liner



OEM No : 81541050024

**01.143** Nut



M18X1.5 - Right Hand



**RK.01.148.05** Repair Kit



**01.073** Cover



**01.013** Bushing



34X30X16



# Single Cylinder Compressor Ø75 mm-155 CC-Stroke 35 mm

Application - Vehicle  
MAN



**01.05.050**

Knorr. No.  
LK1506  
180552



**01.314** Crankcase

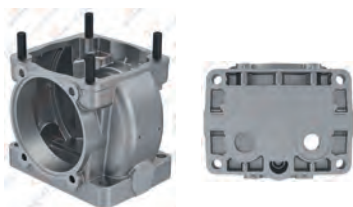

**RK.01.046.01** Repair Kit

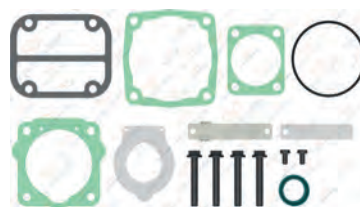

**RK.01.046** Repair Kit

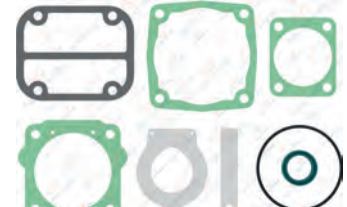

**RK.01.048** Complete Cylinder Head



Knorr No : STW63841

**RK.01.048.20** Complete Cylinder Head



**01.067** Cylinder Head



**RK.01.047.20** Valve Plate Kit

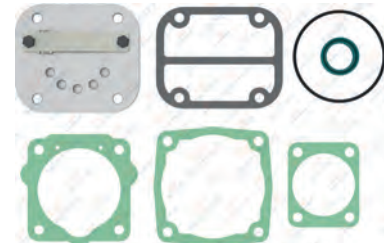

**RK.01.047** Valve Plate Kit



**RK.01.046.02** Repair Kit

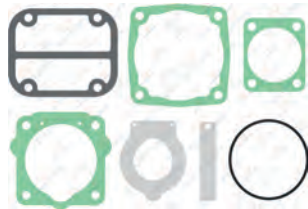

8 680437 072843

**RK.01.046.21** Repair Kit

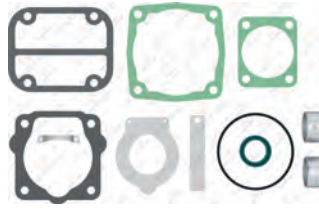

8 680437 120766

**01.206** Crankshaft



M18X1.5 - Right Hand



8 680437 019534

**01.119** Valve Plate



8 680437 017387

Knorr No : II38717F004

**01.194** Crankshaft Flange



8 680437 019398

**01.003** Connecting Rod



8 680437 009672

OEM No : 0001311817 - 0001312617

**RK.01.073.00** Piston&Ring (Ø75,00 mm)

- RK.01.073.10 75,25 mm
- RK.01.073.20 75,50 mm
- RK.01.073.30 75,75 mm
- RK.01.073.40 76,00 mm



2,00x2,00x4,00



8 680437 059547

**01.193.00** Piston (Ø75,00 mm)

- 01.193.10 75,25 mm
- 01.193.20 75,50 mm
- 01.193.30 75,75 mm
- 01.193.40 76,00 mm



2,00x2,00x4,00



8 680437 019336

**01.134.00** Ring (Ø75,00 mm)

- 01.134.10 75,25 mm
- 01.134.20 75,50 mm
- 01.134.30 75,75 mm
- 01.134.40 76,00 mm



2,00x2,00x4,00



8 680437 018278

**RK.01.045** Cylinder Liner Set



STD.



8 680437 059004

**01.056** Cylinder Liner



8 680437 013174

**01.013** Bushing



34X30X16



8 680437 009993

**RK.01.316** Repair Kit



8 680437 063759

**01.143** Nut



M18X1.5 - Right Hand



8 680437 018735

**01.195** Bushing



34X30X16



8 680437 019411



## Single Cylinder Compressor Ø90 mm-293 CC-Stroke 46 mm

Application - Vehicle  
MAN

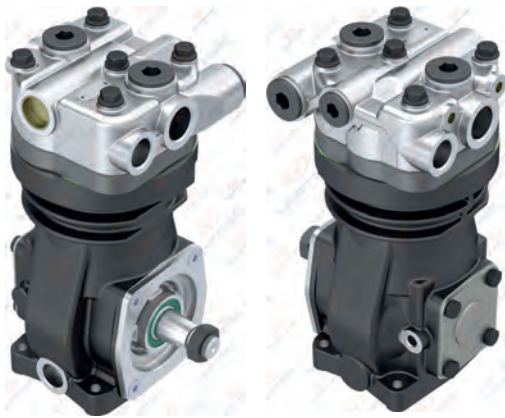

**01.05.109-01.05.112**

Oem. No.  
82541016013

Wabco No.  
4111435610  
4111438610



**01.1250**

Crankcase



**RK.01.183**

Repair Kit



**RK.01.019**

Complete Cylinder Head



OEM No : 51541146045 - 51541146054  
Wabco No : 4110338062

**RK.01.013**

Valve Plate Kit



OEM No : 81541246013  
Wabco No : 4110335032

**RK.01.636.01**

Repair Kit

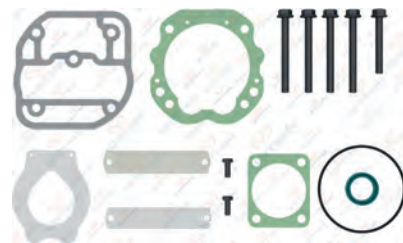

**RK.01.636**

Repair Kit

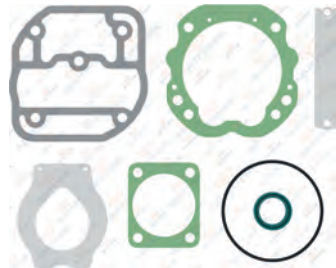

**RK.01.636.02**

Repair Kit

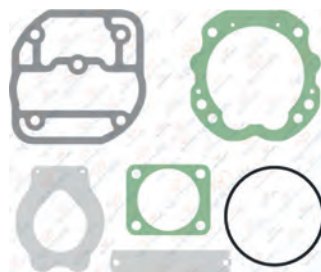

**01.070** Cylinder Head



Barcode: 8 680437 014072  
 OEM No : 81541110026  
 Wabco No : 4110336532

**01.122** Valve Plate



Barcode: 8 680437 017783

**01.1254** Crankshaft



M18X1.5 - Right Hand  
 Barcode: 8 680437 076759

**01.190** Bushing



34X30X20

Barcode: 8 680437 019282

**01.234** Crankshaft Flange



Barcode: 8 680437 019916  
 Wabco No : 4111419232

**01.230.10** Connecting Rod



Barcode: 8 680437 072522

**RK.01.635.00** Piston&Ring (Ø90,00 mm)

- RK.01.635.10 90,25 mm
- RK.01.635.20 90,50 mm
- RK.01.635.30 90,75 mm
- RK.01.635.40 91,00 mm



2,50x2,50x4,00

Barcode: 8 680437 074526

**01.1255.00** Piston (Ø90,00 mm)

- 01.1255.10 90,25 mm
- 01.1255.20 90,50 mm
- 01.1255.30 90,75 mm
- 01.1255.40 91,00 mm



2,50x2,50x4,00

Barcode: 8 680437 077053

**01.138.00** Ring (Ø90,00 mm)

- 01.138.10 90,25 mm
- 01.138.20 90,50 mm
- 01.138.30 90,75 mm
- 01.138.40 91,00 mm



2,50x2,50x4,00

Barcode: 8 680437 018469

OEM No : 06184800232 - 51025030562

**01.437** Bushing



39X35X20

Barcode: 8 680437 022589

**01.241** Connecting Rod Bearing Kit



Barcode: 8 680437 019985  
 OEM No : 51541216001

**01.143** Nut



M18X1.5 - Right Hand  
 Barcode: 8 680437 018735

**01.515** Cover



Barcode: 8 680437 116165

# Single Cylinder Compressor Ø92 mm-360 CC-Stroke 54 mm

Application - Vehicle  
MAN



## 01.04.194

Oem. No.	Knorr No.
51540007144	LS3907
51540007145	K082266N00
51540007146	K118690N04
51540007147	K071325N04
	K035435N04



### 01.1681 Crankcase



### 01.1682 Crankcase



### RK.01.268.03 Repair Kit

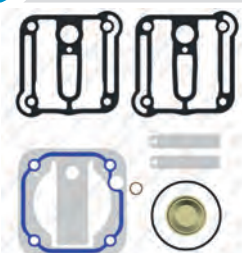

### RK.01.518.10 Complete Cylinder Head



Knorr No : K114439K50

### RK.01.478.03 Valve Plate Kit



Knorr No : K105788K50 - K105788K99

### RK.01.478.01 Valve Plate Kit

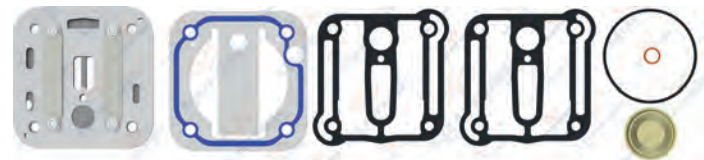

### RK.01.478.10 Valve Plate Kit

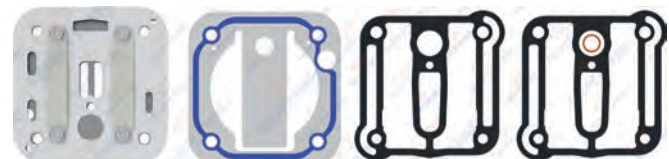

### RK.01.268.02 Repair Kit

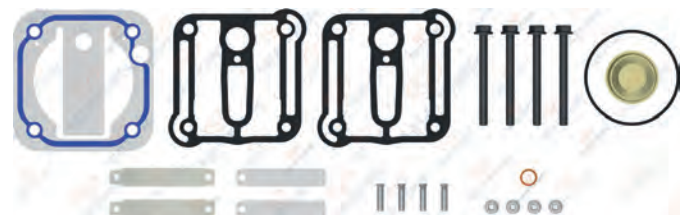



**01.939.10** Cylinder Head

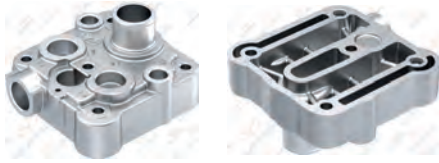

8 680437 101864

**01.940.10** Cooling Plate



8 680437 101840

**01.1778** Crankshaft



8 680437 128465

**01.1036.100** Valve Plate



8 680437 116837

**01.1583** Crankshaft Flange



8 680437 084693

**01.1101** Connecting Rod



8 680437 016069

**RK.01.318.00** Piston&Ring (Ø92,00 mm)

- RK.01.318.10 92,25 mm
- RK.01.318.20 92,50 mm
- RK.01.318.30 92,75 mm
- RK.01.318.40 93,00 mm



2,50x2,50x4,00

Knorr No : K006026



8 680437 063773

**01.862.00** Piston (Ø92,00 mm)

- 01.862.10 92,25 mm
- 01.862.20 92,50 mm
- 01.862.30 92,75 mm
- 01.862.40 93,00 mm



2,50x2,50x4,00



8 680437 027584

**01.942.00** Ring (Ø92,00 mm)

- 01.942.10 92,25 mm
- 01.942.20 92,50 mm
- 01.942.30 92,75 mm
- 01.942.40 93,00 mm



2,50x2,50x4,00



8 680437 028666

**RK.01.268.04** Repair Kit

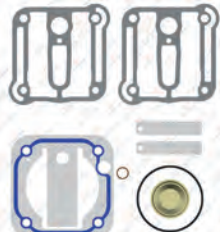

Use for old version cylinder repair kit.  
Yıpranmış kapaklar için.



8 680437 063100

**RK.01.268.06** Repair Kit



8 680437 124153

**51.01.007** Safety Valve



M26X1.5 - 17 Bar



8 680437 072324

OEM No : 51541228001  
Knorr No : DR5125 - K081929K50

**103.04.001** Repair Kit



Knorr No : K034195



8 680437 128472

**RK.01.773** Clutch Housing Kit



Knorr No : K052056K50



8 680437 128489

**RK.01.774** Clutch Kit



Knorr No : K097453



8 680437 128496

**RK.01.775** Clutch Shaft Kit



Knorr No : K108151K50



8 680437 128502

**RK.01.776** Gear Kit



Knorr No : K108148K50



8 680437 128519

**RK.01.581** Valve Plate Kit



**RK.01.265** Repair Kit

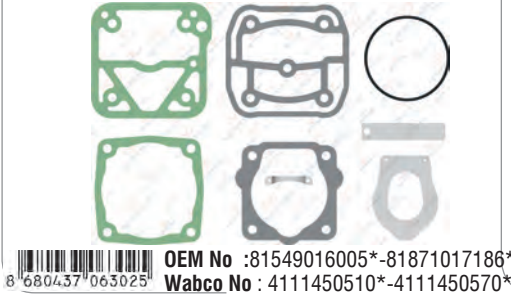

**RK.01.265.01** Repair Kit

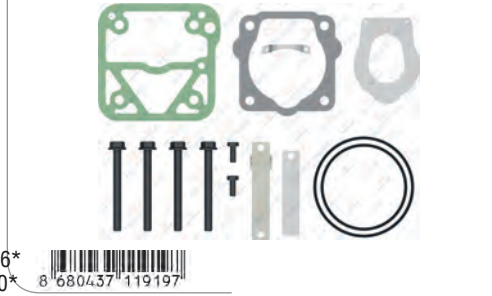

**RK.01.043** Repair Kit

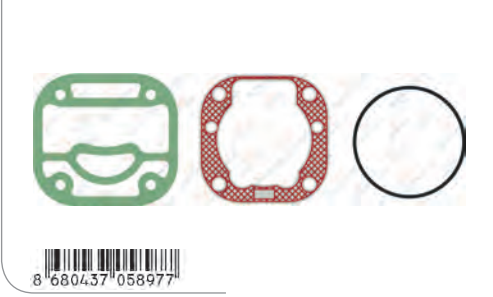

**RK.01.535** Complete Cylinder Head



**RK.01.476** Repair Kit

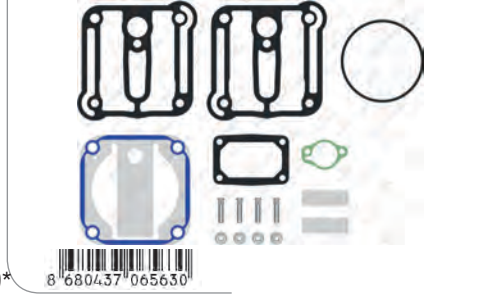

**RK.01.317** Repair Kit

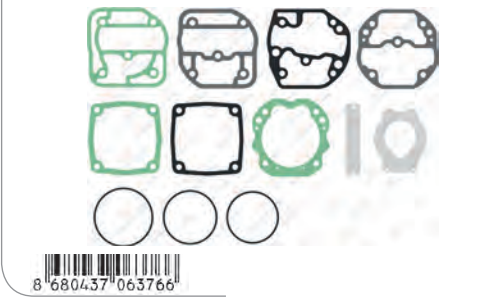

**RK.01.317.02** Repair Kit

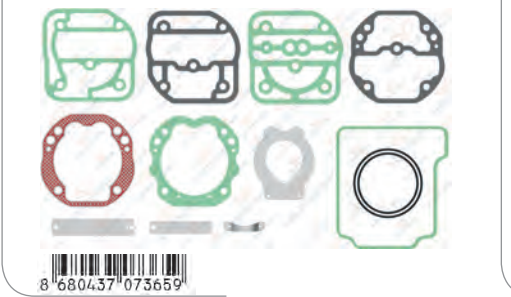

**RK.01.317.03** Repair Kit



**RK.01.491** Repair Kit

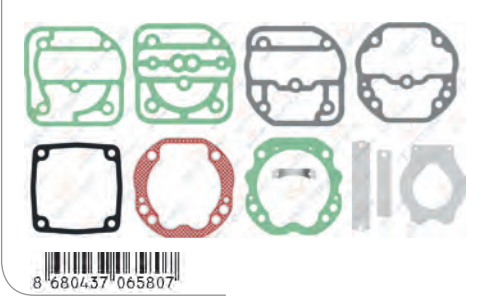

**RK.01.534** Repair Kit

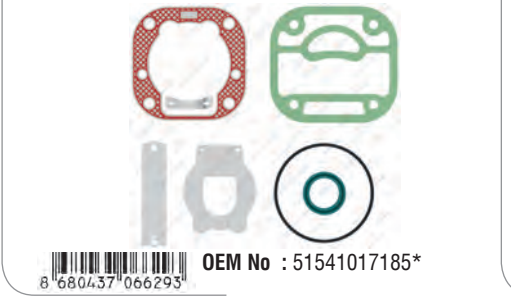

**RK.01.534.01** Repair Kit

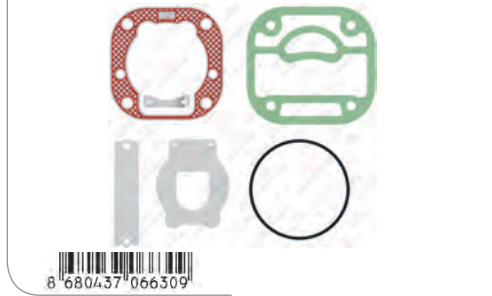

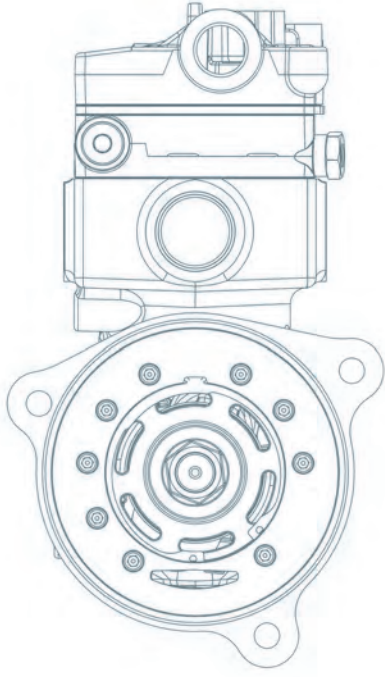

# VOLVO

**HAVA KOMPRESÖRLERİ  
ve TAMİR TAKIMLARI**

AIR COMPRESSORS AND REPAIR KITS

**VOLVO**

VOLVO



## Single Cylinder Compressor Ø85 mm-318 CC-Stroke 56 mm

Application - Vehicle  
VOLVO FM9 / FM12 / FH13 FH16

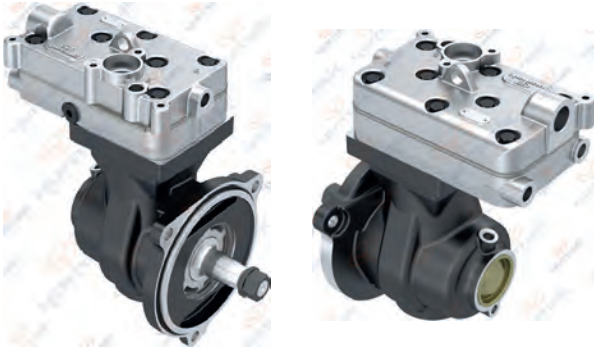

**01.06.065**

Oem. No.  
20451724  
21353433  
20451727

Wabco No.  
9121120010

**01.06.065.10**

With Gear



**01.1285**

Crankcase



**RK.01.235.07**

Repair Kit

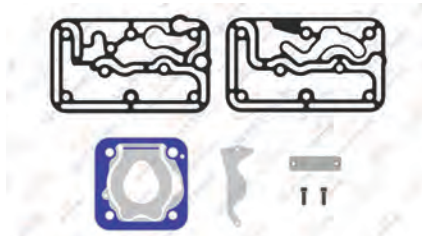

**RK.01.180**

Repair Kit



**RK.01.359**

Complete Cylinder Head



OEM No : 85104248  
Wabco No : 4123529202

**RK.01.235.01**

Repair Kit

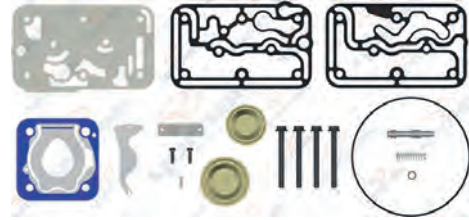

**RK.01.235.02**

Repair Kit

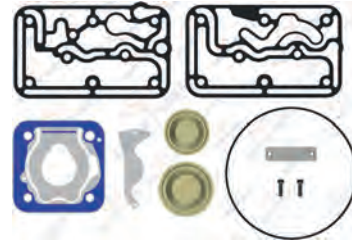

**RK.01.235.03**

Repair Kit

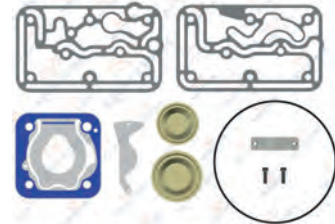

Use for old version cylinder Repair kit. Yıpranmış kapaklar için.

**RK.01.235.06**

Repair Kit

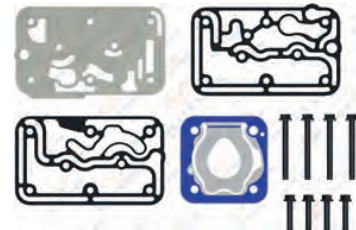

OEM No : 85103938  
Wabco No : 4123520042



**01.583** Cylinder Head



8 680437 024286

**01.281.10** Valve Plate



8 680437 127413

**01.1286** Crankshaft



M20X1.5 Right Hand

8 680437 071761

**01.160** Cooling Plate



8 680437 018902

**01.878** Bushing



Wabco No : 9120003404 - 9120003406

8 680437 027898

**01.272** Connecting Rod



8 680437 020400

**RK.01.104.00** Piston&Ring(Ø85,00 mm)

RK.01.104.10	85,25 mm
RK.01.104.20	85,50 mm
RK.01.104.30	85,75 mm
RK.01.104.40	86,00 mm



2,00x2,00x4,00

8 680437 060277

**01.142.00** Piston (Ø85,00 mm)

01.142.10	85,25 mm
01.142.20	85,50 mm
01.142.30	85,75 mm
01.142.40	86,00 mm



2,00x2,00x4,00

Wabco No : 9115016242 - 9115016252

8 680437 018674

**01.373.00** Ring (Ø85,00 mm)

01.373.10	85,25 mm
01.373.20	85,50 mm
01.373.30	85,75 mm
01.373.40	86,00 mm



2,00x2,00x4,00

OEM No : 3094621

Wabco No : 9115019202

8 680437 075431

**RK.01.803** Connecting Rod & Piston



STD.

Wabco No : 9125189242

8 680437 114567

**RK.01.902** Crankshaft Repair Kit



Wabco No : 9121129212

8 680437 109310

**01.1551** Gear



OEM No : 3161258

8 680437 091172

**RK.01.201** Repair Kit



8 680437 062110

**01.1227** Bushing



54X48X20

8 680437 017936

**01.144** Nut



M20X1.5 Right Hand

OEM No : 1698672

Wabco No : 8103410014

8 680437 018742

## Single Cylinder Compressor Ø85 mm-318 CC-Stroke 56 mm

Application - Vehicle  
VOLVO FM9 / FM12 / FH13 FH16

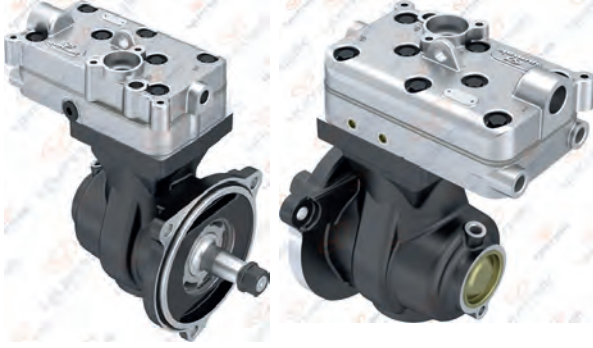

**01.06.082**

Oem. No.	Wabco No.
22040500	9121120020
22169884	
22169886	

**01.06.082.10**

With Gear



**01.1285** Crankcase



**RK.01.717** Repair Kit



**RK.01.715** Complete Cylinder Head

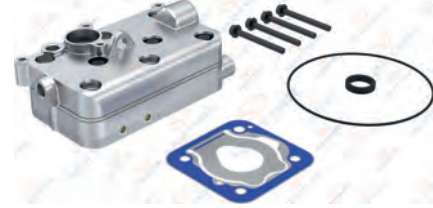

**RK.01.716.05** Repair Kit

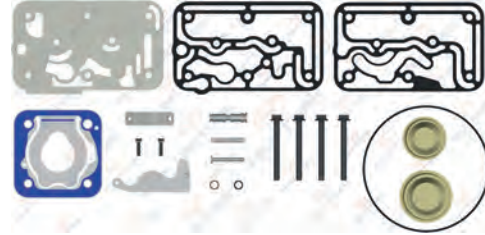

**RK.01.716** Repair Kit

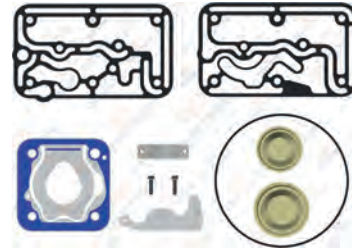

**RK.01.235.06** Repair Kit

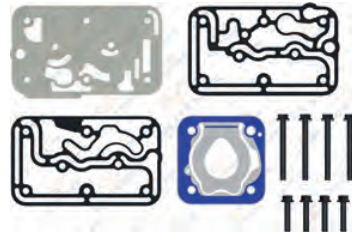

OEM No : 85103938  
Wabco No : 4123520042

**RK.01.716.04** Repair Kit

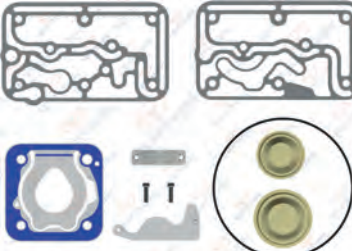

Use for old version cylinder Repair kit. Yıpranmış kapaklar için.

**RK.01.718** Repair Kit



**01.583** Cylinder Head



8 680437 024286

**01.1512** Valve Plate



8 680437 082798

**01.1286** Crankshaft



M20X1.5 Right Hand



8 680437 071761

**01.160** Cooling Plate



8 680437 018902

**01.878** Bushing



8 680437 027898

Wabco No : 9120003404 - 9120003406

**01.272** Connecting Rod



8 680437 020400

**RK.01.104.00** Piston&Ring(Ø85,00 mm)

- RK.01.104.10 85,25 mm
- RK.01.104.20 85,50 mm
- RK.01.104.30 85,75 mm
- RK.01.104.40 86,00 mm



2,00x2,00x4,00



8 680437 060277

**01.142.00** Piston (Ø85,00 mm)

- 01.142.10 85,25 mm
- 01.142.20 85,50 mm
- 01.142.30 85,75 mm
- 01.142.40 86,00 mm



2,00x2,00x4,00



8 680437 018674

Wabco No : 9115016242 - 9115016252

**01.373.00** Ring (Ø85,00 mm)

- 01.373.10 85,25 mm
- 01.373.20 85,50 mm
- 01.373.30 85,75 mm
- 01.373.40 86,00 mm



2,00x2,00x4,00



8 680437 075431

OEM No : 3094621  
Wabco No : 9115019202

**RK.01.180** Repair Kit



8 680437 061830

**01.144** Nut



M20X1.5 Right Hand



8 680437 018742

OEM No : 1698672  
Wabco No : 8103410014

**01.1551** Gear



8 680437 091172

OEM No : 3161258

**RK.01.235.07** Repair Kit

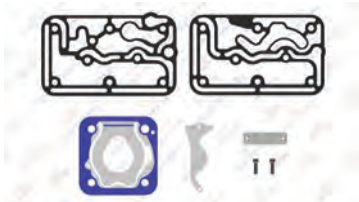

8 680437 122241

**01.302** Cap



8 680437 020769

**01.1232** Cap



8 680437 018001



## Single Cylinder Compressor Ø85 mm-352 CC-Stroke 62 mm

Application - Vehicle  
VOLVO FM9 / FM12 / FH16



**01.06.002**

Oem. No.	Wabco No.
85000118	4123520300
85006118	
85012203	
21353460	
20382348	

**01.06.002.10**

With Gear



**01.341**

Crankcase



**RK.01.103.04**

Repair Kit

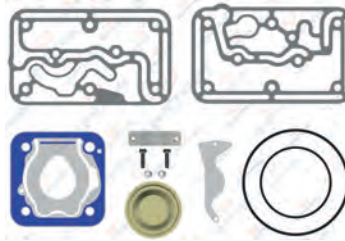

Use for old version cylinder Repair kit.  
Yıpranmış kapaklar için.

**RK.01.103.03**

Repair Kit

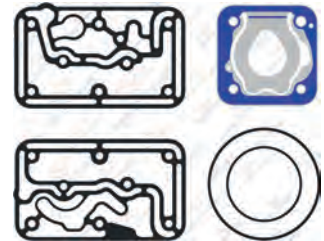

**RK.01.168**

Complete Cylinder Head



OEM No : 85104246  
Wabco No : 4123529212

**RK.01.168.20**

Complete Cylinder Head



**RK.01.103.05**

Repair Kit

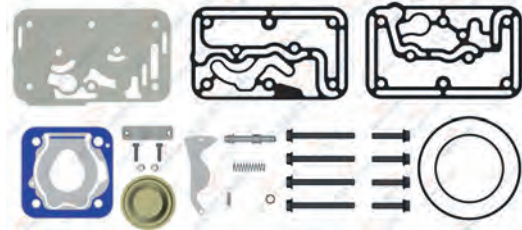

**RK.01.103**

Repair Kit

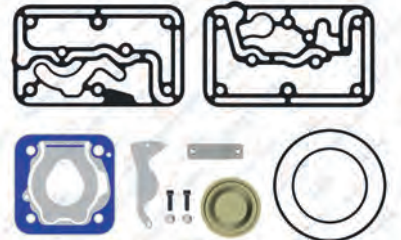

**RK.01.103.02**

Repair Kit

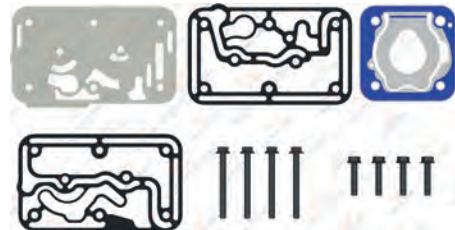

OEM No : 85102273  
Wabco No : 4123520032

**01.679** Cylinder Head



8 680437 025443

**01.281** Valve Plate



8 680437 020493

**01.275** Crankshaft



M20X1.5 Right Hand



8 680437 020431

**01.861** Cooling Plate



8 680437 027577

**01.847** Crankshaft Flange



8 680437 027423

**01.697** Connecting Rod



8 680437 025634

OEM No : 1698678  
Wabco No : 9115057322

**RK.01.104.00** Piston&Ring(Ø85,00 mm)

- RK.01.104.10 85,25 mm
- RK.01.104.20 85,50 mm
- RK.01.104.30 85,75 mm
- RK.01.104.40 86,00 mm



2,00x2,00x4,00



8 680437 060277

**01.142.00** Piston (Ø85,00 mm)

- 01.142.10 85,25 mm
- 01.142.20 85,50 mm
- 01.142.30 85,75 mm
- 01.142.40 86,00 mm



2,00x2,00x4,00



8 680437 018674

Wabco No : 9115016242 - 9115016252

**01.373.00** Ring (Ø85,00 mm)

- 01.373.10 85,25 mm
- 01.373.20 85,50 mm
- 01.373.30 85,75 mm
- 01.373.40 86,00 mm



2,00x2,00x4,00



8 680437 075431

OEM No : 3094621  
Wabco No : 9115019202

**RK.01.804** Connecting Rod & Piston



STD.



8 680437 114666

Wabco No : 4127049422 - 4127049432

**01.279** Bushing



39X35X20



8 680437 020479

**01.280** Gear



8 680437 020486

OEM No : 8170446

**RK.01.201** Repair Kit

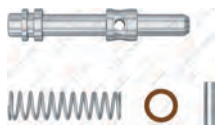

8 680437 062110

**RK.01.180** Repair Kit



8 680437 061830

**01.144** Nut



M20X1.5 Right Hand



8 680437 018742

OEM No : 1698672  
Wabco No : 8103410014



## Single Cylinder Compressor Ø85 mm-352 CC-Stroke 62 mm

Application - Vehicle  
VOLVO FM9

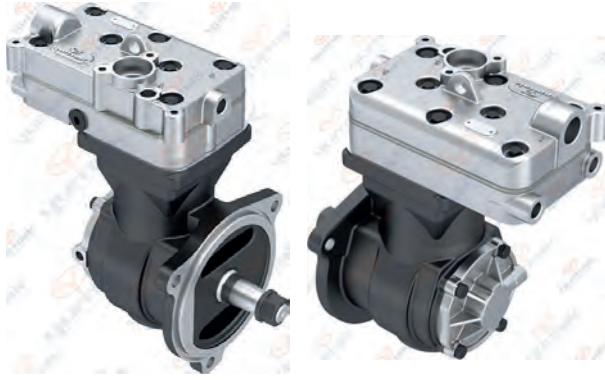

**01.06.003**

Oem. No.	Wabco No.
85000116	4123520290
20478166	4123520040
21353457	
VOE21353457	

**01.06.003.10**

With Gear



**01.891**

Crankcase



**RK.01.235.07**

Repair Kit

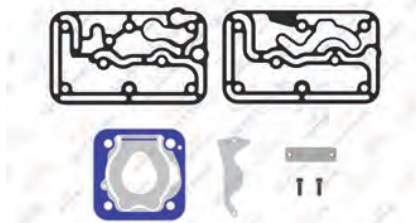

**RK.01.180**

Repair Kit



**RK.01.359.01**

Complete Cylinder Head



OEM No : 85104248\*  
Wabco No : 4123529202\*

**RK.01.235.05**

Repair Kit

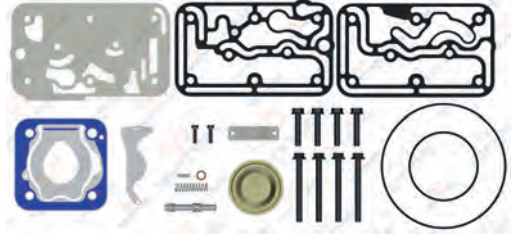

**RK.01.235**

Repair Kit

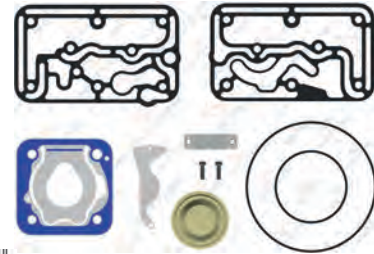

**RK.01.235.04**

Repair Kit

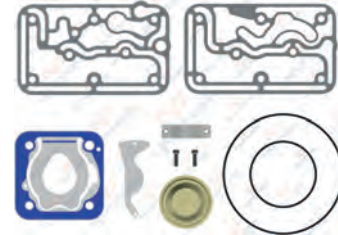

Use for old version cylinder Repair kit. Yıpranmış kapaklar için.

**RK.01.235.06**

Repair Kit

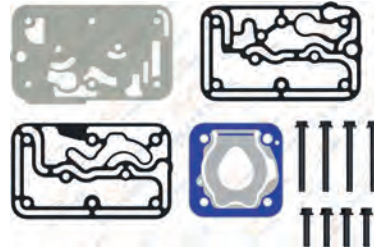

OEM No : 85103938  
Wabco No : 4123520042



**01.583** Cylinder Head



8 680437 024286

**01.281.10** Valve Plate



8 680437 127413

**01.991** Crankshaft



Right Hand



8 680437 029366

**01.160** Cooling Plate



8 680437 018902

**01.847** Crankshaft Flange



8 680437 027423

**01.697** Connecting Rod



8 680437 025634

OEM No : 1698678  
Wabco No : 9115057322

**RK.01.104.00** Piston&Ring (Ø85,00 mm)

- RK.01.104.10 85,25 mm
- RK.01.104.20 85,50 mm
- RK.01.104.30 85,75 mm
- RK.01.104.40 86,00 mm



2,00x2,00x4,00



8 680437 060277

**01.142.00** Piston (Ø85,00 mm)

- 01.142.10 85,25 mm
- 01.142.20 85,50 mm
- 01.142.30 85,75 mm
- 01.142.40 86,00 mm



2,00x2,00x4,00



8 680437 018674

Wabco No : 9115016242 - 9115016252

**01.373.00** Ring (Ø85,00 mm)

- 01.373.10 85,25 mm
- 01.373.20 85,50 mm
- 01.373.30 85,75 mm
- 01.373.40 86,00 mm



2,00x2,00x4,00



8 680437 075431

OEM No : 3094621  
Wabco No : 9115019202

**01.302** Cap



8 680437 020769

**01.279** Bushing



39X35X20



8 680437 020479

**01.1551** Gear



8 680437 091172

OEM No : 3161258

**RK.01.201** Repair Kit



8 680437 062110

**RK.01.804** Connecting Rod & Piston



STD.



8 680437 114666

Wabco No : 4127049422 - 4127049432

**RK.01.904** Crankshaft Repair Kit



8 680437 109235

## Twin Cylinder Compressor Ø85 mm-636 CC-Stroke 56 mm

Application - Vehicle  
VOLVO FH16



### 01.05.073

Oem. No.	Wabco No.
20524352	9125140010
20733968	9125120040
20774360	9125140040
21175029	9125120080
20846000	9125140030
20774294	

### 01.05.073.10

With Gear



### 01.877

Crankcase



### RK.01.352.11

Repair Kit

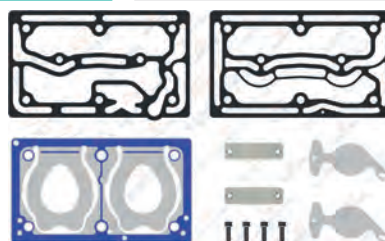

### RK.01.418

Repair Kit

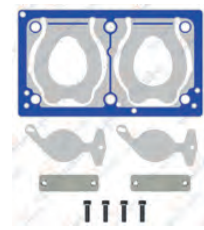

### RK.01.361

Complete Cylinder Head



OEM No : 20889546 - 20774299 - 21418150 - 21707608  
Wabco No : 4127049402 - 9125129262 - 9125129252 - 9125129242

### RK.01.352.05

Repair Kit

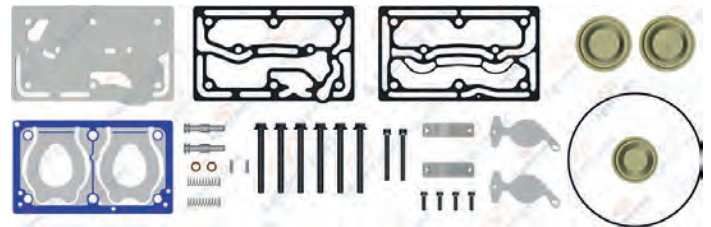

### RK.01.352.10

Repair Kit

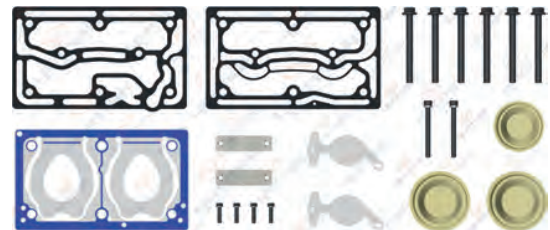

Wabco No : 9125129282

### RK.01.352

Repair Kit

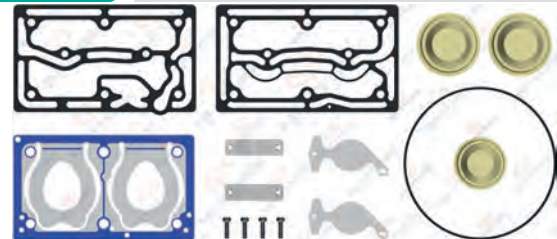

### RK.01.352.19

Repair Kit

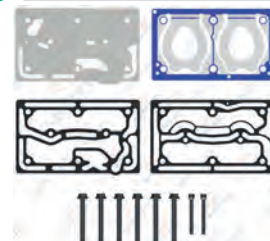

OEM No : 21322318 - 21477052  
Wabco No : 9125129272 - 4127049382

**01.874** Cylinder Head



8 680437 027836

**01.1284** Valve Plate



8 680437 027220

**01.876** Crankshaft



M20X1.5 Right Hand



8 680437 027874

**01.565** Cooling Plate



8 680437 024095

**01.878** Bushing



8 680437 027898

Wabco No : 9120003404 - 9120003406

**01.272** Connecting Rod



8 680437 020400

**RK.01.104.00** Piston&Ring (Ø85,00 mm)

- RK.01.104.10 85,25 mm
- RK.01.104.20 85,50 mm
- RK.01.104.30 85,75 mm
- RK.01.104.40 86,00 mm



2,00x2,00x4,00



8 680437 060277

**01.142.00** Piston (Ø85,00 mm)

- 01.142.10 85,25 mm
- 01.142.20 85,50 mm
- 01.142.30 85,75 mm
- 01.142.40 86,00 mm



2,00x2,00x4,00



8 680437 018674

Wabco No : 9115016242 - 9115016252

**01.373.00** Ring (Ø85,00 mm)

- 01.373.10 85,25 mm
- 01.373.20 85,50 mm
- 01.373.30 85,75 mm
- 01.373.40 86,00 mm



2,00x2,00x4,00



8 680437 075431

OEM No : 3094621  
Wabco No : 9115019202

**RK.01.803** Connecting Rod & Piston



STD.



8 680437 114567

Wabco No : 9125189242

**RK.01.905** Crankshaft Repair Kit



8 680437 109242

Wabco No : 9125129302

**01.1551** Gear



8 680437 091172

OEM No : 3161258

**RK.01.512** Repair Kit



8 680437 066040

**01.1227** Bushing



52X48X20



8 680437 017936

**01.144** Nut



M20X1.5 Right Hand



8 680437 018742

OEM No : 1698672  
Wabco No : 8103410014



## Twin Cylinder Compressor Ø85 mm

Application - Vehicle  
VOLVO FH16

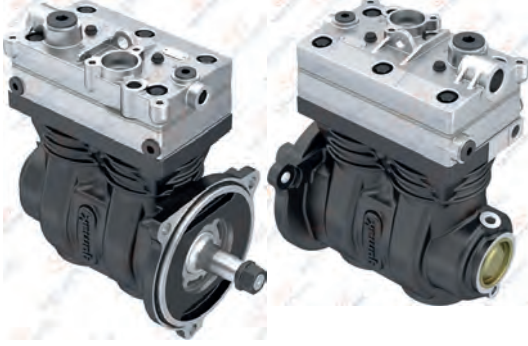

**01.05.074**

Oem. No.  
20569251  
20477943

Wabco No.  
9125120010



**01.877**

Crankcase



**RK.01.352.11**

Repair Kit

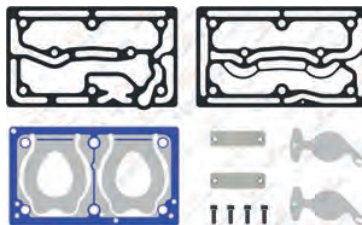

**RK.01.418**

Repair Kit

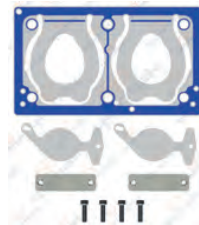

**RK.01.675**

Complete Cylinder Head

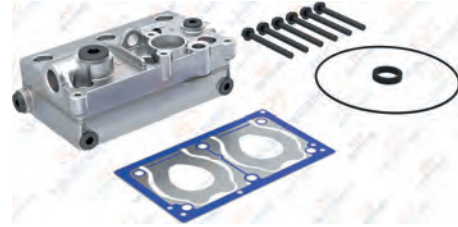

Wabco No : 412704940\*

**RK.01.351.05**

Repair Kit

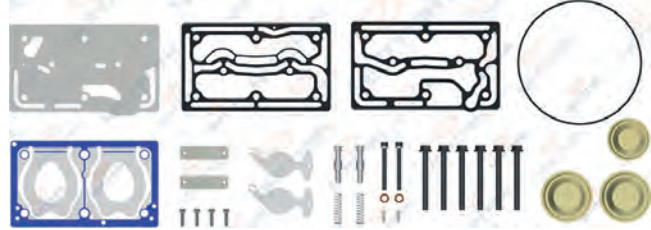

**RK.01.351.01**

Repair Kit

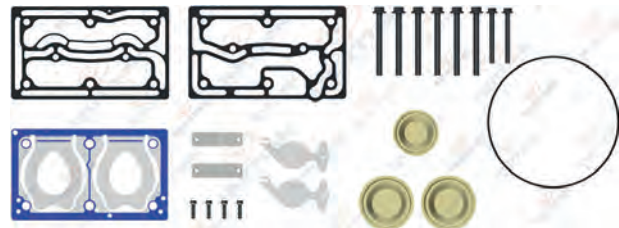

**RK.01.351**

Repair Kit

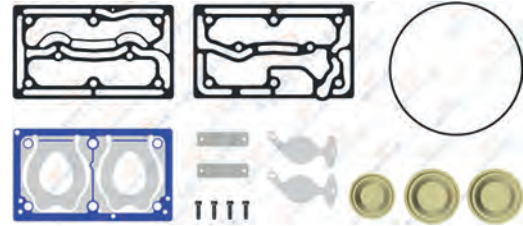

**RK.01.351.04**

Repair Kit

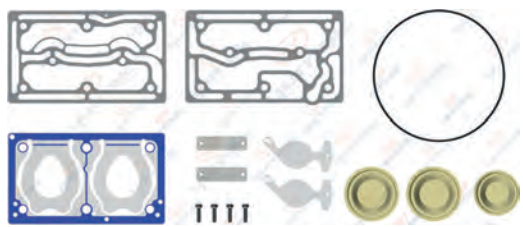

Use for old version cylinder Repair kit. Yıpranmış kapaklar için.

**01.1367** Cylinder Head

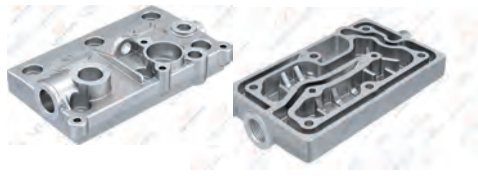

8 680437 076698

**01.1284** Valve Plate



8 680437 072720

**01.876** Crankshaft



M20X1.5 Right Hand

8 680437 027874

**01.565** Cooling Plate



8 680437 024095

**01.878** Bushing



8 680437 027898 Wabco No : 9120003404 - 9120003406

**01.272** Connecting Rod



8 680437 020400

**RK.01.104.00** Piston&Ring (Ø85,00 mm)

- RK.01.104.10 85,25 mm
- RK.01.104.20 85,50 mm
- RK.01.104.30 85,75 mm
- RK.01.104.40 86,00 mm



2,00x2,00x4,00

8 680437 060277

**01.142.00** Piston (Ø85,00 mm)

- 01.142.10 85,25 mm
- 01.142.20 85,50 mm
- 01.142.30 85,75 mm
- 01.142.40 86,00 mm



2,00x2,00x4,00

8 680437 018674 Wabco No : 9115016242 - 9115016252

**01.373.00** Ring (Ø85,00 mm)

- 01.373.10 85,25 mm
- 01.373.20 85,50 mm
- 01.373.30 85,75 mm
- 01.373.40 86,00 mm



2,00x2,00x4,00

8 680437 075431 OEM No : 3094621 Wabco No : 9115019202

**RK.01.803** Connecting Rod & Piston



STD.

8 680437 114567 Wabco No : 9125189242

**RK.01.905** Crankshaft Repair Kit



8 680437 109242 Wabco No : 9125129302

**01.1551** Gear



8 680437 091172 OEM No : 3161258

**RK.01.512** Repair Kit

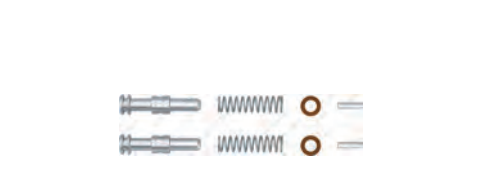

8 680437 066040

**01.302** Cap



8 680437 020769

**01.1232** Cap



8 680437 018001



## Twin Cylinder Compressor Ø85 mm-636 CC-Stroke 56 mm

Application - Vehicle  
VOLVO B12



### 01.05.130

Oem. No.  
20770303  
20824559

Wabco No.  
9125120060  
9125120070

### 01.05.130.10

With Gear



### 01.1299

Crankcase



### RK.01.352.11

Repair Kit

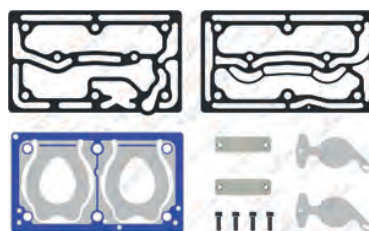

### RK.01.418

Repair Kit



### RK.01.361.01

Complete Cylinder Head

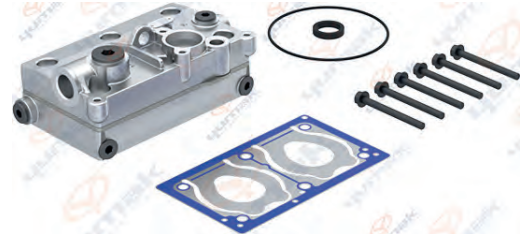

OEM No : 20889546\* - 20774299\* - 21418150\* - 21707608\*  
Wabco No : 4127049402\* - 9125129262\* - 9125129252\* - 9125129242\*

### RK.01.352.07

Repair Kit

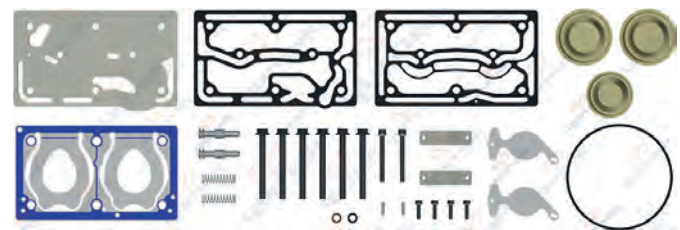

### RK.01.352.10

Repair Kit

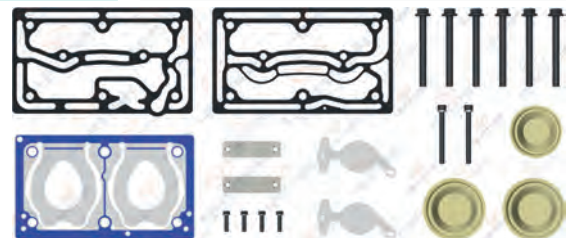

Wabco No : 9125129282

### RK.01.352.01

Repair Kit

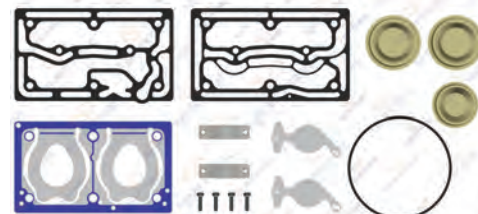

### RK.01.352.19

Repair Kit

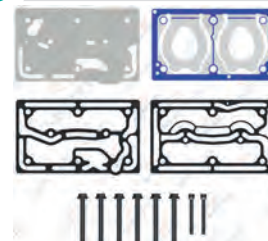

OEM No : 21322318 - 21477052  
Wabco No : 9125129272 - 4127049382



**01.874** Cylinder Head



8 680437 027836

**01.1284** Valve Plate



8 680437 072720

**01.1346** Crankshaft



M20x1.5 Right Hand



8 680437 108504

**01.565** Cooling Plate



8 680437 024095

**01.878** Bushing



8 680437 027898

Wabco No : 9120003404 - 9120003406

**01.272** Connecting Rod



8 680437 020400

**RK.01.104.00** Piston&Ring (Ø85,00 mm)

- RK.01.104.10** 85,25 mm
- RK.01.104.20** 85,50 mm
- RK.01.104.30** 85,75 mm
- RK.01.104.40** 86,00 mm



2,00x2,00x4,00



8 680437 060277

**01.142.00** Piston (Ø85,00 mm)

- 01.142.10** 85,25 mm
- 01.142.20** 85,50 mm
- 01.142.30** 85,75 mm
- 01.142.40** 86,00 mm



2,00x2,00x4,00



8 680437 018674

Wabco No : 9115016242 - 9115016252

**01.373.00** Ring (Ø85,00 mm)

- 01.373.10** 85,25 mm
- 01.373.20** 85,50 mm
- 01.373.30** 85,75 mm
- 01.373.40** 86,00 mm



2,00x2,00x4,00



8 680437 075431

OEM No : 3094621  
Wabco No : 9115019202

**01.1227** Bushing



52X48X20



8 680437 017936

**01.144** Nut



M20x1.5 Right Hand



8 680437 018742

OEM No : 1698672  
Wabco No : 8103410014

**01.1487** Gear



OEM No : 1549425



8 680437 076414

**RK.01.512** Repair Kit



8 680437 066040

**01.302** Cap



8 680437 020769

**01.1232** Cap



8 680437 018001

## Twin Cylinder Compressor Ø85 mm - 636 CC - Stroke 56 mm

Application - Vehicle  
VOLVO FH16



### 01.06.081

Oem. No.	Wabco No.
22016995	9125120290
22062019	9125140090
22062021	9125510060
22062020	9125420070



### 01.877 Crankcase



### RK.01.352.11 Repair Kit

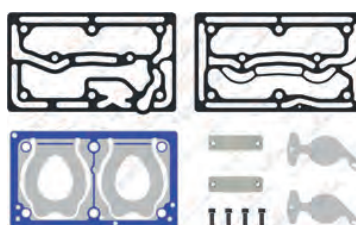

### RK.01.713 Repair Kit



### RK.01.711 Complete Cylinder Head



Wabco No : 9125129352

### RK.01.712.05 Repair Kit

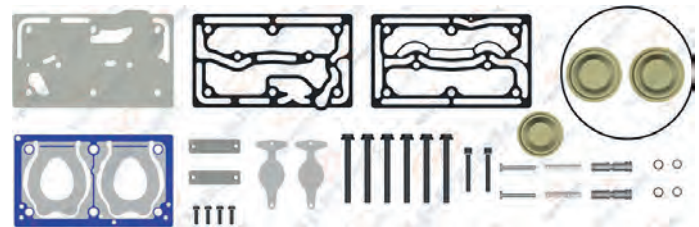

### RK.01.712.01 Repair Kit

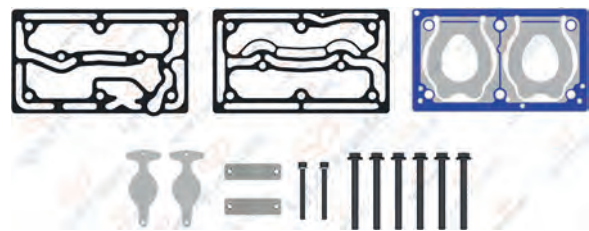

Wabco No : 9125129362

### RK.01.712 Repair Kit

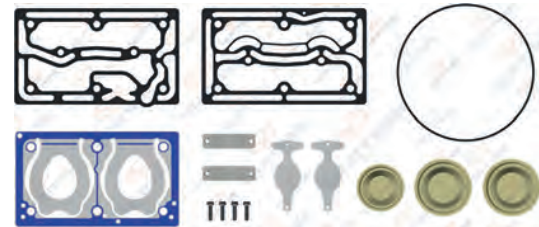

### RK.01.352.19 Repair Kit

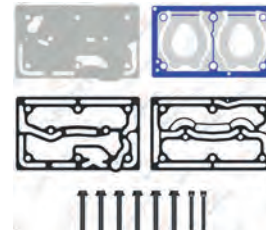

OEM No : 21322318 - 21477052  
Wabco No : 9125129272 - 4127049382

**01.874** Cylinder Head



8 680437 027836

**01.1478** Valve Plate



8 680437 077459

**01.876** Crankshaft



M20x1.5 Right Hand



8 680437 027874

**01.565** Cooling Plate



8 680437 024095

**01.878** Bushing



8 680437 027898

Wabco No : 9120003404 - 9120003406

**01.272** Connecting Rod



8 680437 020400

**RK.01.104.00** Piston&Ring (Ø85,00 mm)

- RK.01.104.10 85,25 mm
- RK.01.104.20 85,50 mm
- RK.01.104.30 85,75 mm
- RK.01.104.40 86,00 mm



2,00x2,00x4,00



8 680437 060277

**01.142.00** Piston (Ø85,00 mm)

- 01.142.10 85,25 mm
- 01.142.20 85,50 mm
- 01.142.30 85,75 mm
- 01.142.40 86,00 mm



2,00x2,00x4,00



8 680437 018674

Wabco No : 9115016242 - 9115016252

**01.373.00** Ring (Ø85,00 mm)

- 01.373.10 85,25 mm
- 01.373.20 85,50 mm
- 01.373.30 85,75 mm
- 01.373.40 86,00 mm



2,00x2,00x4,00



8 680437 075431

OEM No : 3094621  
Wabco No : 9115019202

**RK.01.803** Connecting Rod & Piston



STD.

Wabco No : 9125189242



8 680437 114567

**RK.01.905** Crankshaft Repair Kit



Wabco No : 9125129302



8 680437 109242

**01.1551** Gear



OEM No : 3161258



8 680437 091172

**RK.01.714** Repair Kit



8 680437 077244

**01.1227** Bushing



52X48X20



8 680437 017936

**01.144** Nut



M20x1.5 Right Hand



8 680437 018742

OEM No : 1698672  
Wabco No : 8103410014



## Twin Cylinder Compressor Ø85 mm-704 CC-Stroke 62 mm

Application - Vehicle  
VOLVO FH12 / FH16 / FM12



### 01.06.004

Oem. No.	Wabco No.
20547525	4127040080
20382347	4127040040
20701801	4127040050
20569224	4127040090
	4127040010

### 01.06.004.10

With Gear



### 01.290

Crankcase



### RK.01.122.01

Repair Kit

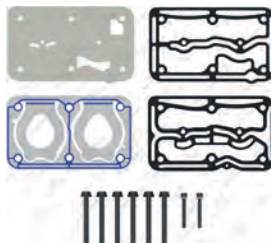

### RK.01.122.02

Repair Kit

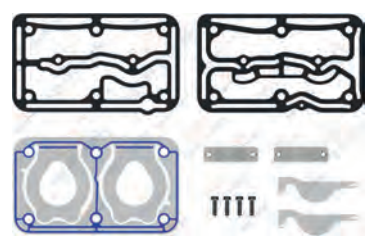

### RK.01.167

Complete Cylinder Head



OEM No : 20701803  
Wabco No : 4127049322

### RK.01.167.20

Complete Cylinder Head



### RK.01.122.05

Repair Kit

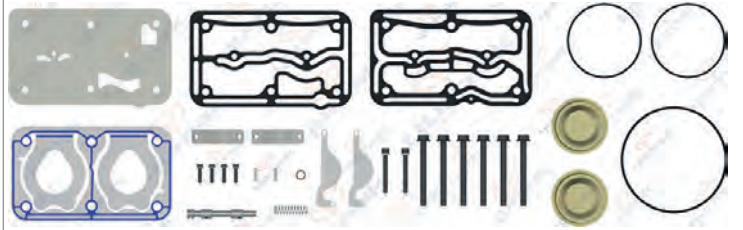

### RK.01.122

Repair Kit

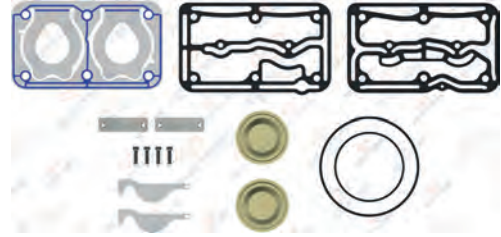

### RK.01.122.04

Repair Kit

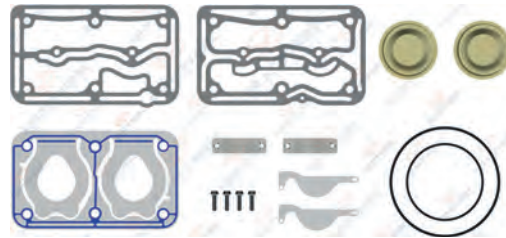

Use for old version cylinder Repair kit. Yıpranmış kapaklar için.

**01.485** Cylinder Head



**01.426.20** Valve Plate



**01.584** Crankshaft



M20X1.5 Right Hand



**01.303** Cooling Plate



**01.284** Crankshaft Flange



**01.697** Connecting Rod



OEM No : 1698678  
Wabco No : 9115057322

**RK.01.104.00** Piston&Ring (Ø85,00 mm)

- RK.01.104.10 85,25 mm
- RK.01.104.20 85,50 mm
- RK.01.104.30 85,75 mm
- RK.01.104.40 86,00 mm



2,00x2,00x4,00



**01.142.00** Piston (Ø85,00 mm)

- 01.142.10 85,25 mm
- 01.142.20 85,50 mm
- 01.142.30 85,75 mm
- 01.142.40 86,00 mm

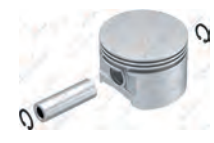

2,00x2,00x4,00



Wabco No : 9115016242 - 9115016252

**01.373.00** Ring (Ø85,00 mm)

- 01.373.10 85,25 mm
- 01.373.20 85,50 mm
- 01.373.30 85,75 mm
- 01.373.40 86,00 mm



2,00x2,00x4,00



OEM No : 3094621  
Wabco No : 9115019202

**RK.01.804** Connecting Rod & Piston



STD.



Wabco No : 4127049422 - 4127049432

**01.115** Bushing



42X38X24.5



**01.280** Gear



OEM No : 8170446

**RK.01.181** Repair Kit

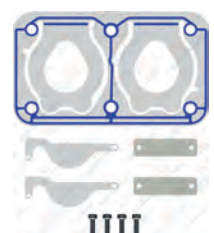

**RK.01.101** Repair Kit



**01.144** Nut



M20X1.5 Right Hand



OEM No : 1698672  
Wabco No : 8103410014



## Twin Cylinder Compressor Ø85 mm-704 CC-Stroke 62 mm

Application - Vehicle  
VOLVO FH12 / FH16 / FM9 / FM12 / NH12

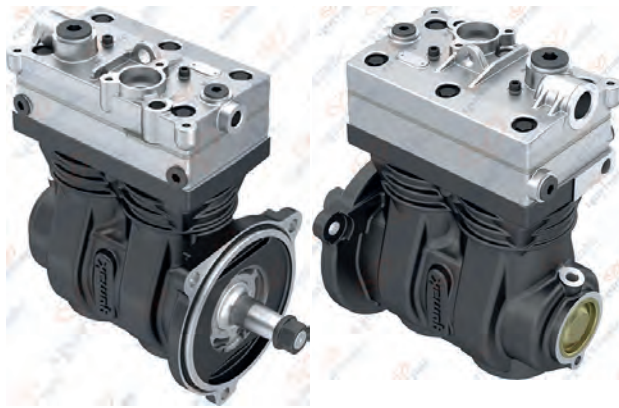

**01.06.059**

Oem. No.	Wabco No.
21379906	4127040180
20845313	
21172036	
20850846	
85003282	
85000615	

**01.06.059.10**

With Gear



**01.1349**

Crankcase



**RK.01.352.11**

Repair Kit

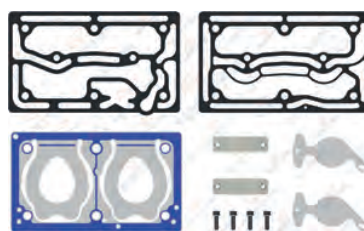

**RK.01.418**

Repair Kit

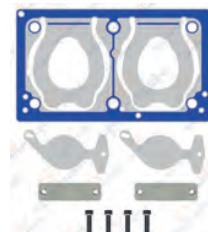

**RK.01.361**

Complete Cylinder Head

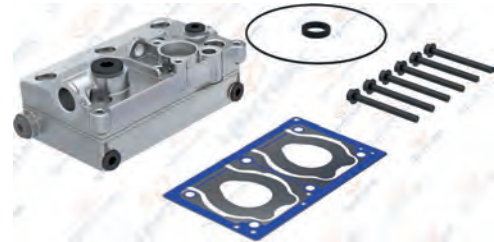

OEM No : 20889546 - 20774299 - 21418150 - 21707608  
Wabco No : 4127049402 - 9125129262 - 9125129252 - 9125129242

**RK.01.352.05**

Repair Kit

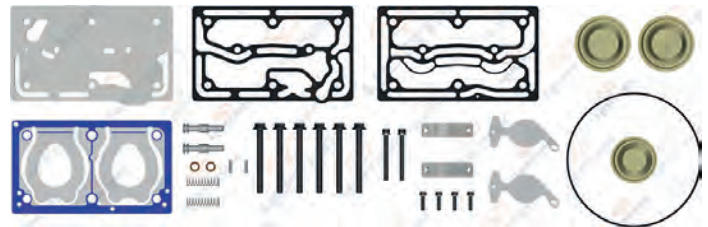

**RK.01.352.10**

Repair Kit

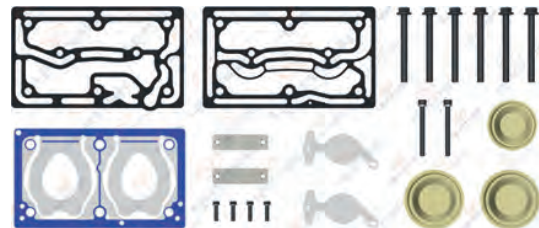

Wabco No : 9125129282

**RK.01.352**

Repair Kit

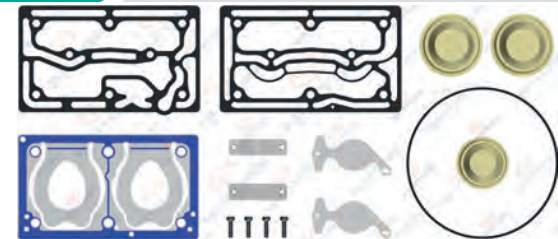

**RK.01.352.19**

Repair Kit

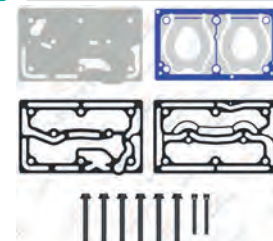

OEM No : 21322318 - 21477052  
Wabco No : 9125129272 - 4127049382



**01.874** Cylinder Head



8 680437 027836

**01.1284** Valve Plate



8 680437 027220

**01.1410** Crankshaft



M20X1.5 Right Hand



8 680437 079521

**01.565** Cooling Plate



8 680437 024095

**01.878** Bushing



8 680437 027898

Wabco No : 9120003404 - 9120003406

**01.390.10** Connecting Rod



**RK.01.104.00** Piston&Ring (Ø85,00 mm)

- RK.01.104.10 85,25 mm
- RK.01.104.20 85,50 mm
- RK.01.104.30 85,75 mm
- RK.01.104.40 86,00 mm



2,00x2,00x4,00



8 680437 060277

**01.142.00** Piston (Ø85,00 mm)

- 01.142.10 85,25 mm
- 01.142.20 85,50 mm
- 01.142.30 85,75 mm
- 01.142.40 86,00 mm



2,00x2,00x4,00



8 680437 018674

Wabco No : 9115016242 - 9115016252

**01.373.00** Ring (Ø85,00 mm)

- 01.373.10 85,25 mm
- 01.373.20 85,50 mm
- 01.373.30 85,75 mm
- 01.373.40 86,00 mm



2,00x2,00x4,00



8 680437 075431

OEM No : 3094621  
Wabco No : 9115019202

**RK.01.800** Connecting Rod & Piston



STD.



8 680437 078302

Wabco No : 9125109272 - 4123529252  
- 4123529292

**RK.01.907** Crankshaft Repair Kit



8 680437 109266

**01.1551** Gear



8 680437 091172

OEM No : 3161258

**RK.01.512** Repair Kit



8 680437 066040

**01.1227** Bushing



52X48X20



8 680437 017936

**01.144** Nut



M20X1.5 Right Hand



8 680437 018742

OEM No : 1698672  
Wabco No : 8103410014

## Twin Cylinder Compressor Ø85 mm-704 CC-Stroke 62 mm

Application - Vehicle  
VOLVO



**01.06.085**

**Oem. No.**  
21379906  
20845313  
21172036  
85003282  
85000615

**Wabco No.**  
4127040270



**01.1349**

Crankcase



**RK.01.352.11**

Repair Kit

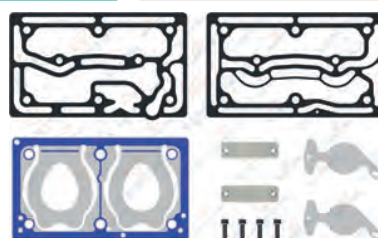

**RK.01.713**

Repair Kit

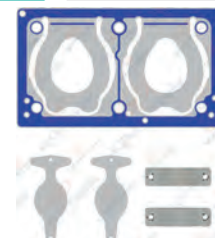

**RK.01.711**

Complete Cylinder Head

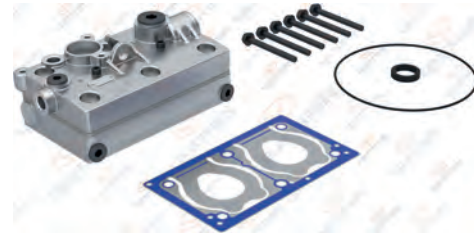

Wabco No : 9125129352

**RK.01.712.05**

Repair Kit

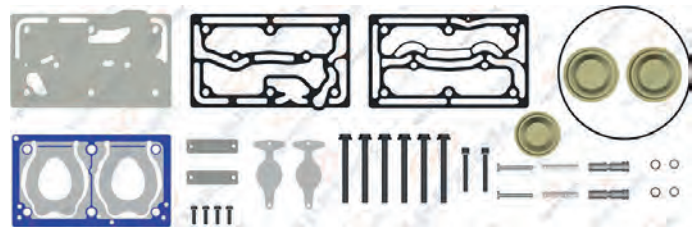

**RK.01.712.01**

Repair Kit

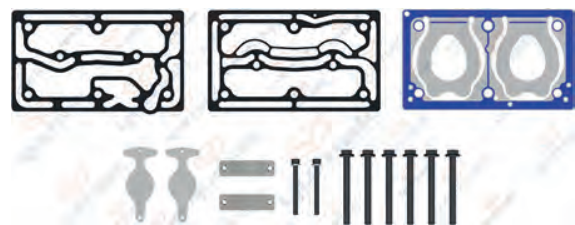

Wabco No : 9125129362

**RK.01.712**

Repair Kit

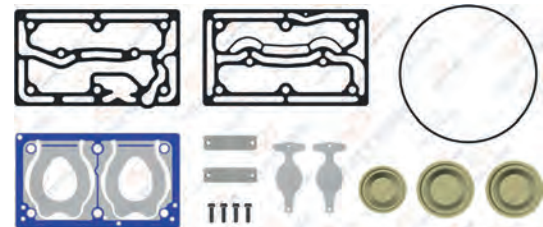

**RK.01.352.19**

Repair Kit

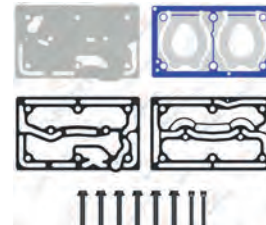

OEM No : 21322318 - 21477052

Wabco No : 9125129272 - 4127049382

**01.874** Cylinder Head



8 680437 027836

**01.1478** Valve Plate



8 680437 077459

**01.1410** Crankshaft



Right Hand



8 680437 079521

**01.565** Cooling Plate



8 680437 024095

**01.878** Bushing



8 680437 027898

Wabco No : 9120003404 - 9120003406

**01.390** Connecting Rod



8 680437 022015

Wabco No: 9111457382

**RK.01.104.00** Piston&Ring (Ø85,00 mm)

- RK.01.104.10 85,25 mm
- RK.01.104.20 85,50 mm
- RK.01.104.30 85,75 mm
- RK.01.104.40 86,00 mm



2,00x2,00x4,00



8 680437 060277

**01.142.00** Piston (Ø85,00 mm)

- 01.142.10 85,25 mm
- 01.142.20 85,50 mm
- 01.142.30 85,75 mm
- 01.142.40 86,00 mm



2,00x2,00x4,00



8 680437 018674

Wabco No : 9115016242 - 9115016252

**01.373.00** Ring (Ø85,00 mm)

- 01.373.10 85,25 mm
- 01.373.20 85,50 mm
- 01.373.30 85,75 mm
- 01.373.40 86,00 mm



2,00x2,00x4,00



8 680437 075431

OEM No : 3094621  
Wabco No : 9115019202

**RK.01.800** Connecting Rod & Piston



STD.



8 680437 078302

Wabco No : 9125109272 - 4123529252  
- 4123529292 - 9120007302

**RK.01.907** Crankshaft Repair Kit



8 680437 109266

**01.1551** Gear



8 680437 091172

OEM No : 3161258

**RK.01.714** Repair Kit



8 680437 077244

**01.302** Cap



8 680437 020769

**01.1232** Cap



8 680437 018001



## Twin Cylinder Compressor Ø85 mm-704 CC-Stroke 62 mm

Application - Vehicle  
VOLVO 440 / FH12 / FH16 / FM9 / FM12 / NH12



**01.06.074**

Oem. No.  
85003351  
21225199

Wabco No.  
4127040190



**01.885.10**

Crankcase



**RK.01.352.19**

Repair Kit

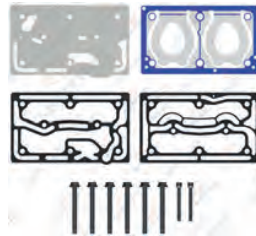

OEM No : 21322318 - 21477052  
Wabco No : 9125129272 - 4127049382

**RK.01.352.11**

Repair Kit

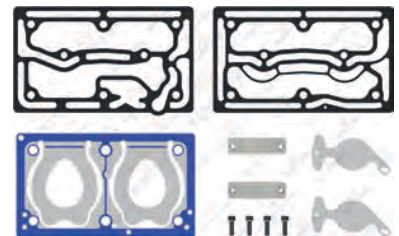

**RK.01.361.02**

Complete Cylinder Head

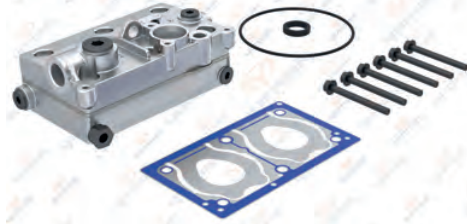

OEM No : 21316442  
Wabco No : 4127049372

**RK.01.352.02**

Repair Kit

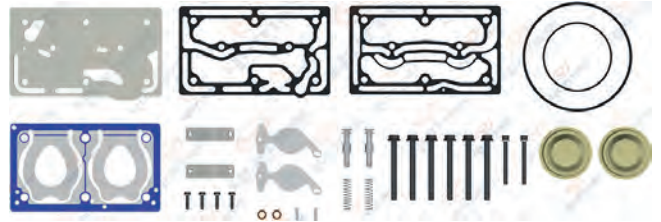

**RK.01.352.12**

Repair Kit

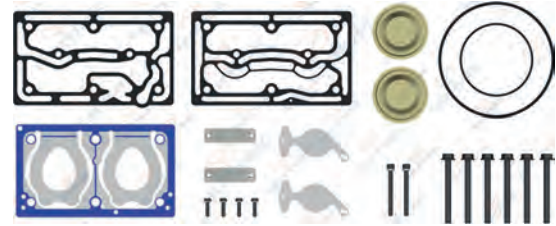

**RK.01.352.13**

Repair Kit

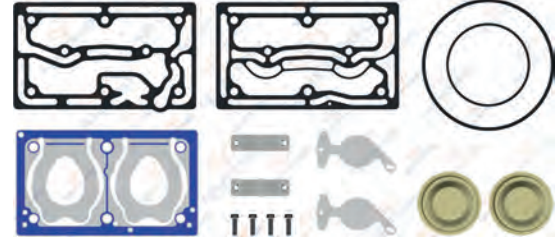

**RK.01.352.14**

Repair Kit

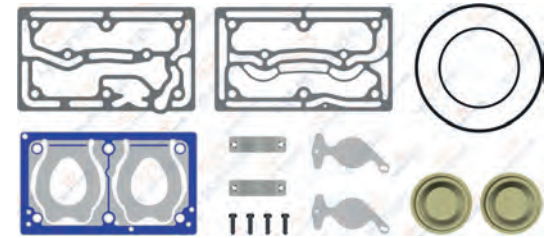

Use for old version cylinder Repair kit. Yıpranmış kapaklar için.

**01.874** Cylinder Head



8 680437 027836

**01.1284.20** Valve Plate



8 680437 101062

**01.886** Crankshaft



Right Hand - Sağ Diş

8 680437 027997

**01.565** Cooling Plate



8 680437 024095

**01.284** Crankshaft Flange



8 680437 020547

**01.697** Connecting Rod



OEM No : 1698678  
Wabco No : 9115057322

8 680437 025634

**RK.01.104.00** Piston&Ring (Ø85,00 mm)

RK.01.104.10	85,25 mm
RK.01.104.20	85,50 mm
RK.01.104.30	85,75 mm
RK.01.104.40	86,00 mm



2,00x2,00x4,00

8 680437 060277

**01.142.00** Piston (Ø85,00 mm)

01.142.10	85,25 mm
01.142.20	85,50 mm
01.142.30	85,75 mm
01.142.40	86,00 mm



2,00x2,00x4,00

Wabco No : 9115016242 - 9115016252

8 680437 018674

**01.373.00** Ring (Ø85,00 mm)

01.373.10	85,25 mm
01.373.20	85,50 mm
01.373.30	85,75 mm
01.373.40	86,00 mm



2,00x2,00x4,00

OEM No : 3094621  
Wabco No : 9115019202

8 680437 075437

**RK.01.804** Connecting Rod & Piston



STD.

Wabco No : 4127049422 - 4127049432

8 680437 114666

**RK.01.908** Crankshaft Repair Kit



Wabco No : 4127049412

8 680437 109273

**01.1549** Gear



OEM No : 20364148

8 680437 076773

**RK.01.418** Repair Kit



8 680437 065029

**RK.01.512** Repair Kit



8 680437 066040

**01.115** Bushing



42X38X24.5

8 680437 077121



## Twin Cylinder Compressor Ø85 mm-704 CC-Stroke 62 mm

Application - Vehicle  
VOLVO 440 / FH12 / FH16 / FM9 / FM12 / NH12

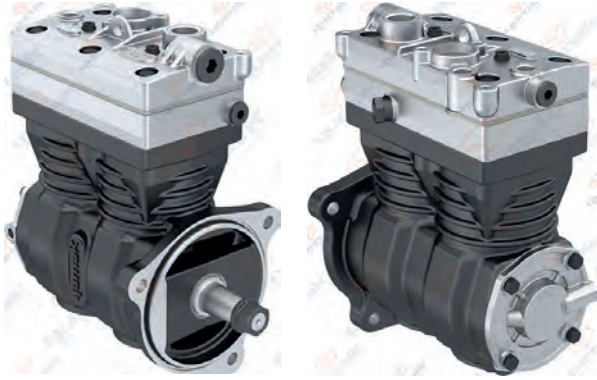

### 01.06.035

Oem. No.	Wabco No.
70330056	4127040070
20775224	4127040130
20574763	4127040160
20866605	
85000491	



### 01.885 Crankcase



### RK.01.176.07 Repair Kit

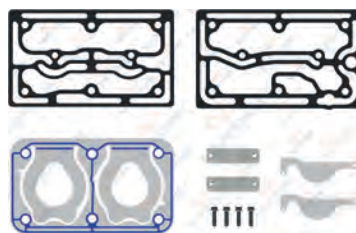

### RK.01.176.03 Repair Kit

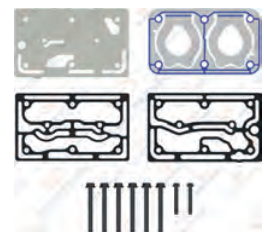

Wabco No : 4127049362

### RK.01.175

### Complete Cylinder Head

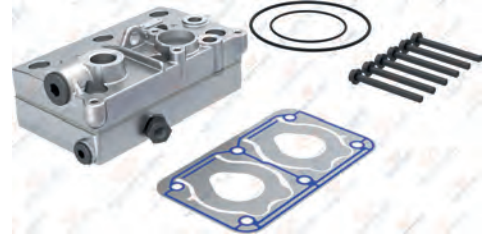

OEM No : 20775236  
Wabco No : 4127049342 - 4127049352

### RK.01.176.05

### Repair Kit

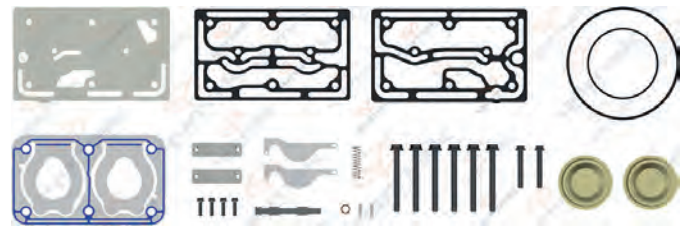

### RK.01.176.01

### Repair Kit

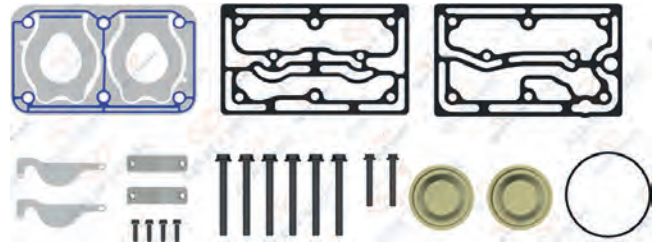

Wabco No : 4127049392

### RK.01.176

### Repair Kit

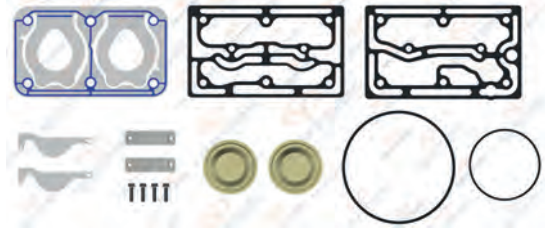

### RK.01.176.04

### Repair Kit

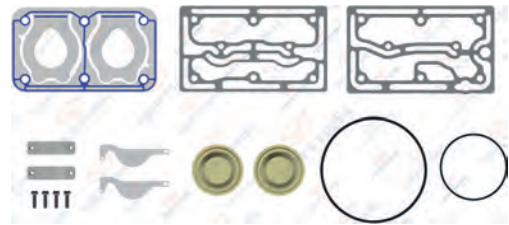

Use for old version cylinder Repair kit. Yıpranmış kapaklar için.



**01.589** Cylinder Head



8 680437 024354

**01.590** Valve Plate



8 680437 024378

**01.886** Crankshaft



M20X1.5 Right Hand  
8 680437 027997

**01.593** Cooling Plate



8 680437 024415

**01.284** Crankshaft Flange



8 680437 020547

**01.697** Connecting Rod



OEM No : 1698678  
Wabco No : 9115057322

**RK.01.104.00** Piston&Ring (Ø85,00 mm)

- RK.01.104.10 85,25 mm
- RK.01.104.20 85,50 mm
- RK.01.104.30 85,75 mm
- RK.01.104.40 86,00 mm



2,00x2,00x4,00

8 680437 060277

**01.142.00** Piston (Ø85,00 mm)

- 01.142.10 85,25 mm
- 01.142.20 85,50 mm
- 01.142.30 85,75 mm
- 01.142.40 86,00 mm



2,00x2,00x4,00

Wabco No : 9115016242 - 9115016252  
8 680437 018674

**01.373.00** Ring (Ø85,00 mm)

- 01.373.10 85,25 mm
- 01.373.20 85,50 mm
- 01.373.30 85,75 mm
- 01.373.40 86,00 mm



2,00x2,00x4,00

OEM No : 3094621  
Wabco No : 9115019202  
8 680437 075431

**RK.01.804** Connecting Rod & Piston



STD.

Wabco No : 4127049422 - 4127049432  
8 680437 114666

**RK.01.908** Crankshaft Repair Kit



Wabco No : 4127049412  
8 680437 109273

**01.1549** Gear



OEM No : 20364148  
8 680437 076773

**RK.01.181** Repair Kit

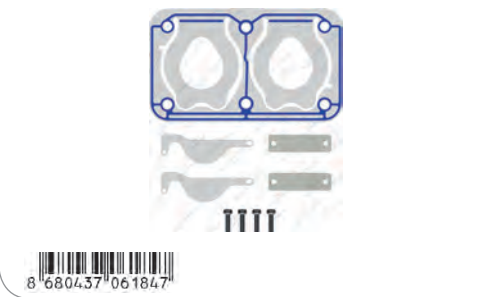

8 680437 061847

**RK.01.101** Repair Kit



8 680437 060246

**01.115** Bushing



42X38X24.5

8 680437 077121

## Twin Cylinder Compressor Ø85 mm-704 CC-Stroke 62 mm

Application - Vehicle  
VOLVO

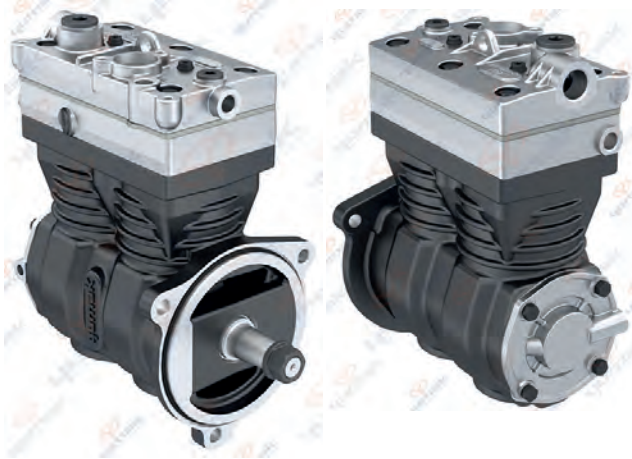

**01.06.075**

Oem. No.  
21388369

Wabco No.  
4127040240



**01.887**

Crankcase



**RK.01.176.07**

Repair Kit

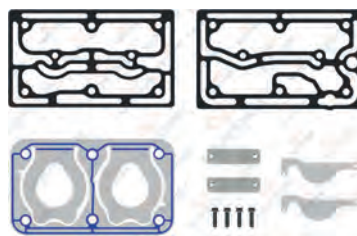

**RK.01.176.03**

Repair Kit

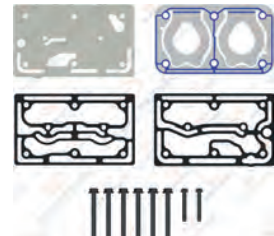

Wabco No : 4127049362

**RK.01.175.01**

Complete Cylinder Head

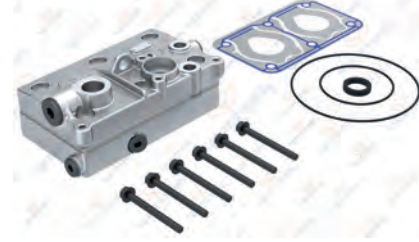

Wabco No : 4127049332

**RK.01.176.10**

Repair Kit

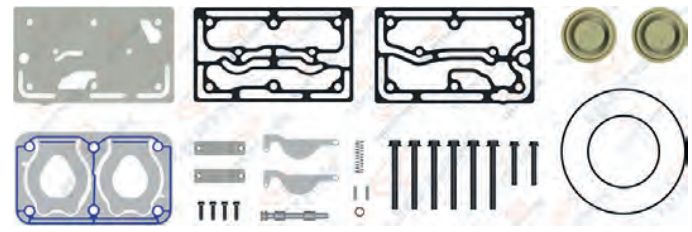

**RK.01.176.01**

Repair Kit

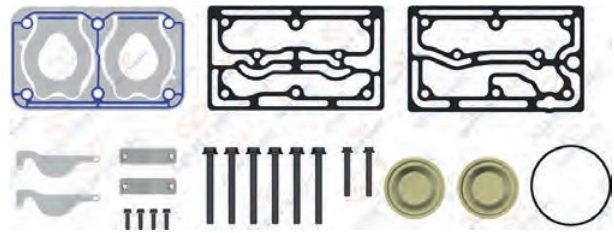

Wabco No : 4127049392

**RK.01.176.11**

Repair Kit

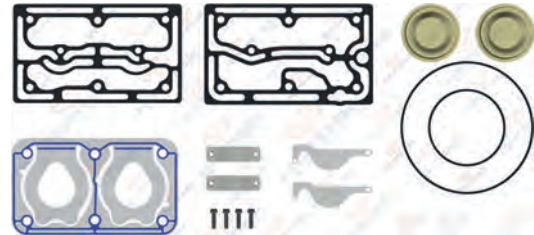

**RK.01.176.12**

Repair Kit

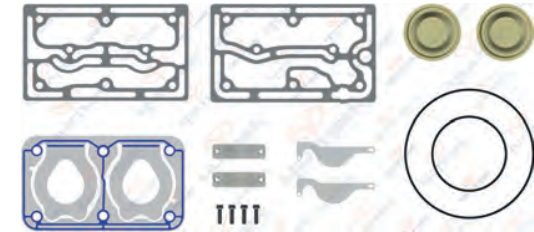

Use for old version cylinder Repair kit. Yıpranmış kapaklar için.

**01.589** Cylinder Head



8 680437 024354

**01.590.10** Valve Plate



8 680437 127758

**01.886** Crankshaft



M20X1.5 Right Hand



8 680437 027997

**01.593** Cooling Plate



8 680437 024415

**01.284** Crankshaft Flange



8 680437 020547

**01.697** Connecting Rod



8 680437 025634

OEM No : 1698678  
Wabco No : 9115057322

**RK.01.104.00** Piston&Ring (Ø85,00 mm)

- RK.01.104.10 85,25 mm
- RK.01.104.20 85,50 mm
- RK.01.104.30 85,75 mm
- RK.01.104.40 86,00 mm



2,00x2,00x4,00



8 680437 060277

**01.142.00** Piston (Ø85,00 mm)

- 01.142.10 85,25 mm
- 01.142.20 85,50 mm
- 01.142.30 85,75 mm
- 01.142.40 86,00 mm



2,00x2,00x4,00



8 680437 018674

Wabco No : 9115016242 - 9115016252

**01.373.00** Ring (Ø85,00 mm)

- 01.373.10 85,25 mm
- 01.373.20 85,50 mm
- 01.373.30 85,75 mm
- 01.373.40 86,00 mm



2,00x2,00x4,00



8 680437 075431

OEM No : 3094621  
Wabco No : 9115019202

**RK.01.804** Connecting Rod & Piston



STD.



8 680437 114666

Wabco No : 4127049422 - 4127049432

**RK.01.908** Crankshaft Repair Kit



8 680437 109273

Wabco No : 4127049412

**01.1551** Gear



8 680437 091172

OEM No : 3161258

**RK.01.181** Repair Kit

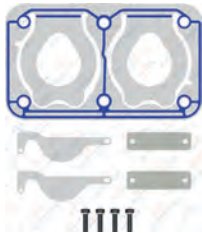

TTTT



8 680437 061847

**01.115** Bushing



42X38X24.5



8 680437 077121

**01.144** Nut



M20X1.5 Right Hand



8 680437 018742

OEM No : 1698672  
Wabco No : 8103410014



## Twin Cylinder Compressor Ø85 mm-704 CC-Stroke 62 mm

Application - Vehicle  
VOLVO FH12 / FH16 / FM9 / FM12 / NH12

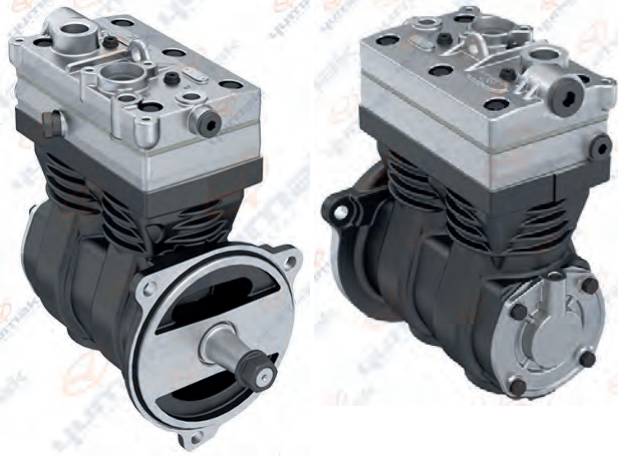

**01.06.037**

Oem. No.	Wabco No.
20765890	4127040150
21379906	4127040120
20845313	
21172036	
85003282	
85000615	



**01.1015** Crankcase



**RK.01.176.07** Repair Kit

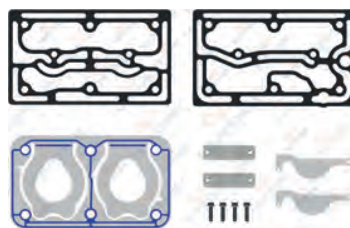

**RK.01.176.03** Repair Kit

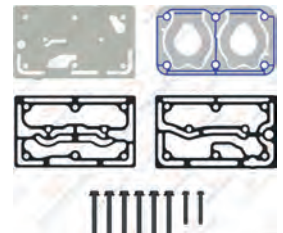

Wabco No : 4127049362

**RK.01.175.02**

Complete Cylinder Head

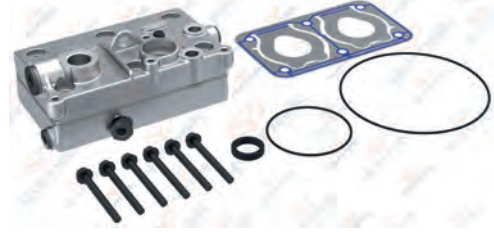

Wabco No : 412704933\*

**RK.01.176.13**

Repair Kit

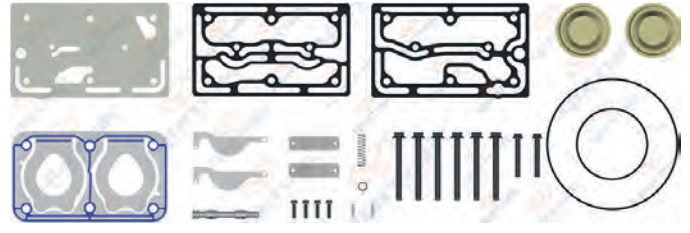

**RK.01.176.01**

Repair Kit

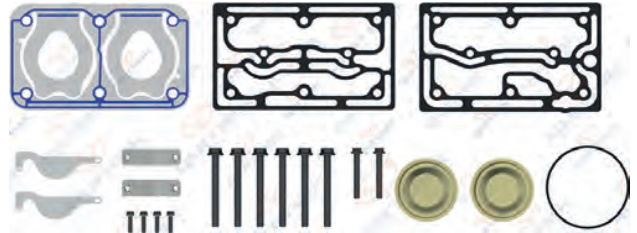

Wabco No : 4127049392

**RK.01.176.14**

Repair Kit

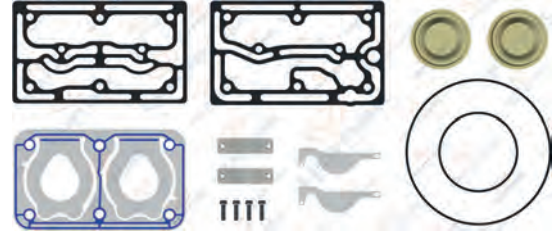

**RK.01.176.15**

Repair Kit

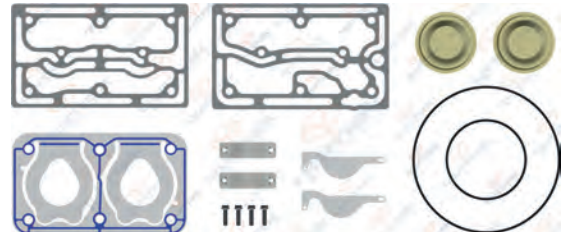

Use for old version cylinder Repair kit. Yıpranmış kapaklar için.

**01.589** Cylinder Head



8 680437 024354

**01.590** Valve Plate



8 680437 024378

**01.886** Crankshaft



M20X1.5 Right Hand



8 680437 027997

**01.593** Cooling Plate



8 680437 024415

**01.284** Crankshaft Flange



8 680437 020547

**01.697** Connecting Rod



8 680437 025634

OEM No : 1698678  
Wabco No : 9115057322

**RK.01.104.00** Piston&Ring (Ø85,00 mm)

- RK.01.104.10 85,25 mm
- RK.01.104.20 85,50 mm
- RK.01.104.30 85,75 mm
- RK.01.104.40 86,00 mm



2,00x2,00x4,00



8 680437 060277

**01.142.00** Piston (Ø85,00 mm)

- 01.142.10 85,25 mm
- 01.142.20 85,50 mm
- 01.142.30 85,75 mm
- 01.142.40 86,00 mm



2,00x2,00x4,00



8 680437 018674

Wabco No : 9115016242 - 9115016252

**01.373.00** Ring (Ø85,00 mm)

- 01.373.10 85,25 mm
- 01.373.20 85,50 mm
- 01.373.30 85,75 mm
- 01.373.40 86,00 mm



2,00x2,00x4,00



8 680437 075431

OEM No : 3094621  
Wabco No : 9115019202

**RK.01.804** Connecting Rod & Piston



STD.



8 680437 114666

Wabco No : 4127049422 - 4127049432

**RK.01.908** Crankshaft Repair Kit



8 680437 109273

Wabco No : 4127049412

**01.1551** Gear



8 680437 091172

OEM No : 3161258

**RK.01.181** Repair Kit

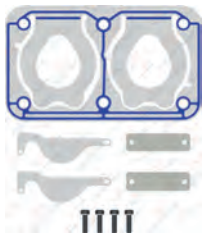

TTTT



8 680437 061847

**01.302** Cap



8 680437 020769

**01.144** Nut



M20X1.5 Right Hand



8 680437 018742

OEM No : 1698672  
Wabco No : 8103410014

**01.115** Bushing



42X38X24.5



8 680437 077121



## Twin Cylinder Compressor Ø85 mm-704 CC-Stroke 62 mm

Application - Vehicle  
VOLVO FH12 / FH16 / FM12 / FM9 / NH12

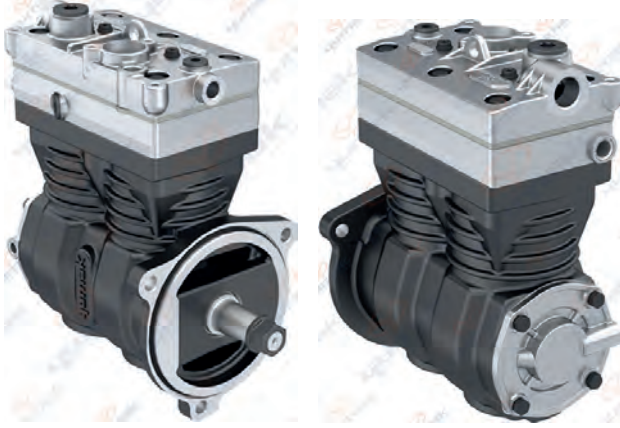

**01.06.036**

**Oem. No.**  
20842990  
20773343  
20569928  
85000614  
85000487

**Wabco No.**  
4127040140



**01.887**

Crankcase



**RK.01.176.07**

Repair Kit

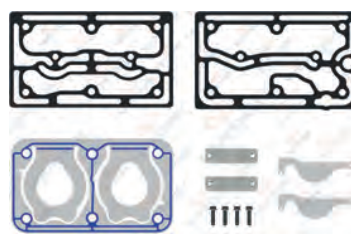

**RK.01.176.03**

Repair Kit

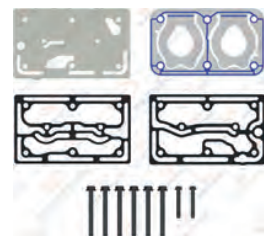

Wabco No : 4127049362

**RK.01.175.01**

Complete Cylinder Head

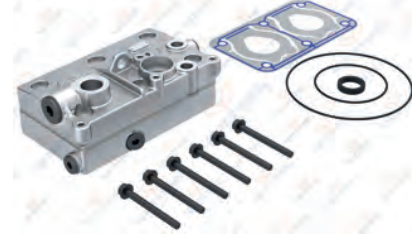

OEM No : 20845004\*  
Wabco No : 4127049332

**RK.01.176.10**

Repair Kit

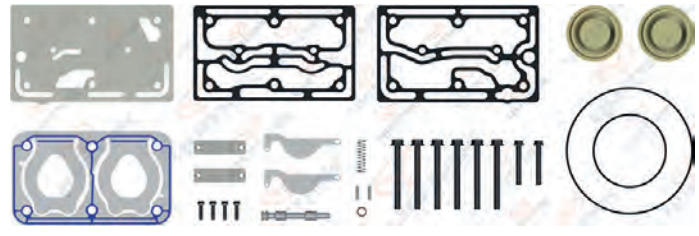

**RK.01.176.01**

Repair Kit

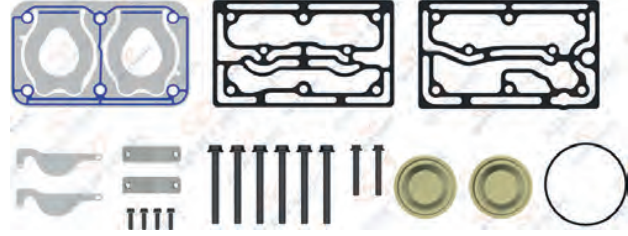

Wabco No : 4127049392

**RK.01.176.11**

Repair Kit

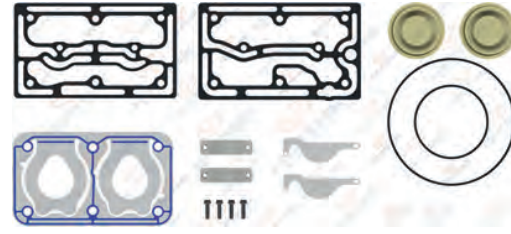

**RK.01.176.12**

Repair Kit

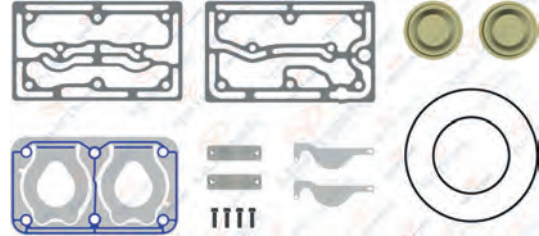

Use for old version cylinder Repair kit. Yıpranmış kapaklar için.



**01.589** Cylinder Head

8 680437 024415

**01.590.10** Valve Plate

8 680437 020547

**01.886** Crankshaft

M20X1.5 Right Hand

8 680437 027997

**01.593** Cooling Plate

8 680437 024415

**01.284** Crankshaft Flange

8 680437 020547

**01.697** Connecting Rod

OEM No : 1698678  
Wabco No : 9115057322

8 680437 025634

**RK.01.104.00** Piston&Ring (Ø85,00 mm)

RK.01.104.10	85,25 mm
RK.01.104.20	85,50 mm
RK.01.104.30	85,75 mm
RK.01.104.40	86,00 mm

2,00x2,00x4,00

8 680437 060277

**01.142.00** Piston (Ø85,00 mm)

01.142.10	85,25 mm
01.142.20	85,50 mm
01.142.30	85,75 mm
01.142.40	86,00 mm

2,00x2,00x4,00

Wabco No : 9115016242 - 9115016252

8 680437 018674

**01.373.00** Ring (Ø85,00 mm)

01.373.10	85,25 mm
01.373.20	85,50 mm
01.373.30	85,75 mm
01.373.40	86,00 mm

2,00x2,00x4,00

OEM No : 3094621  
Wabco No : 9115019202

8 680437 075437

**RK.01.804** Connecting Rod & Piston

STD.

Wabco No : 4127049422 - 4127049432

8 680437 114666

**01.115** Bushing

42X38X24.5

8 680437 077121

**01.1551** Gear

OEM No : 3161258

8 680437 091172

**RK.01.181** Repair Kit

8 680437 061847

**RK.01.101** Repair Kit

8 680437 060246

**01.144** Nut

M20X1.5 Right Hand

OEM No : 1698672  
Wabco No : 8103410014

8 680437 018742

## Twin Cylinder Compressor Ø85 mm-704 CC-Stroke 62 mm

Application - Vehicle  
VOLVO F10 / F12 / F16 / F7 / FL10 / NL12 / FM10



**01.06.008**

Oem. No.	Wabco No.
1626060	9115051500
5003460	
1506365	

**01.06.008.10**

With Gear



**01.694** Crankcase



**RK.01.187** Repair Kit



**RK.01.227** Complete Cylinder Head



OEM No : 3094622  
Wabco No : 9115058042

**RK.01.140.01** Repair Kit

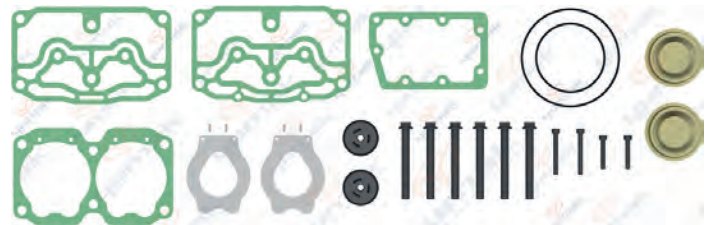

**RK.01.140** Repair Kit

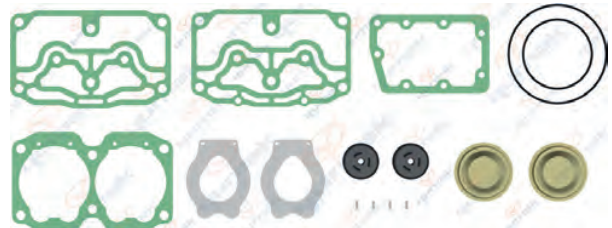

**RK.01.140.02** Repair Kit

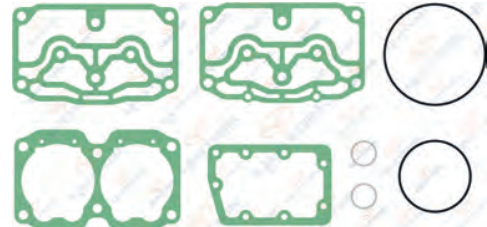

OEM No : 85104629  
Wabco No : 9115050012

**RK.01.140.03** Repair Kit

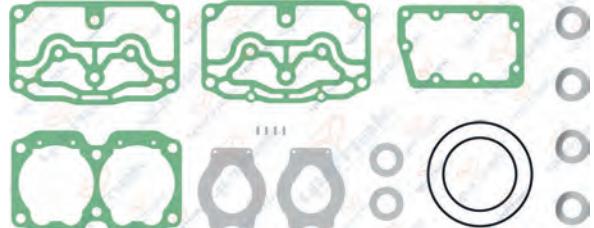

**RK.01.482** Repair Kit



**01.668** Cylinder Head



**01.669** Valve Plate

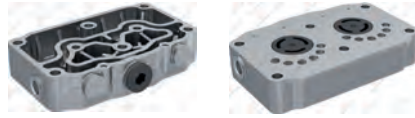

**01.649** Crankshaft



M20X1.5 Right Hand



OEM No : 1698670  
Wabco No : 9115056914

**01.1230** Bushing



42X38X23



**01.695** Crankshaft Flange



OEM No : 3094836  
Wabco No : 9115056644

**01.697** Connecting Rod



OEM No : 1698678  
Wabco No : 9115057322

**RK.01.132.00** Piston&Ring (Ø85,00 mm)

- RK.01.132.10 85,25 mm
- RK.01.132.20 85,50 mm
- RK.01.132.30 85,75 mm
- RK.01.132.40 86,00 mm



2,00x2,00x4,00



**01.933.00** Piston (Ø85,00 mm)

- 01.933.10 85,25 mm
- 01.933.20 85,50 mm
- 01.933.30 85,75 mm
- 01.933.40 86,00 mm



2,00x2,00x4,00



**01.373.00** Ring (Ø85,00 mm)

- 01.373.10 85,25 mm
- 01.373.20 85,50 mm
- 01.373.30 85,75 mm
- 01.373.40 86,00 mm



2,00x2,00x4,00



OEM No : 3094621  
Wabco No : 9115019202

**RK.01.806** Connecting Rod & Piston



STD.



Wabco No : 4127049422\*

**01.780** Cover



**01.1409** Gear



Noth (Tooth) Pcs : 33



OEM No : 478777 - 470775

**01.302** Cap



**00.441** Roller Bearing



6307



OEM No : 1698671  
Wabco No : 8952510202

**01.144** Nut



M20X1.5 Right Hand



OEM No : 1698672  
Wabco No : 8103410014



## Twin Cylinder Compressor Ø85 mm-704 CC-Stroke 62 mm

Application - Vehicle  
VOLVO BUS COACH F10 / F12 / F16 / F7 /  
FL10 / NL12 / FM10



### 01.06.015

Oem. No.  
1518141  
3037344  
8112426

Wabco No.  
9115051510



### 01.615

Crankcase



### RK.01.187

Repair Kit



### RK.01.482

Repair Kit



### RK.01.227

Complete Cylinder Head



OEM No : 3094622  
Wabco No : 9115058042

### RK.01.140.01

Repair Kit

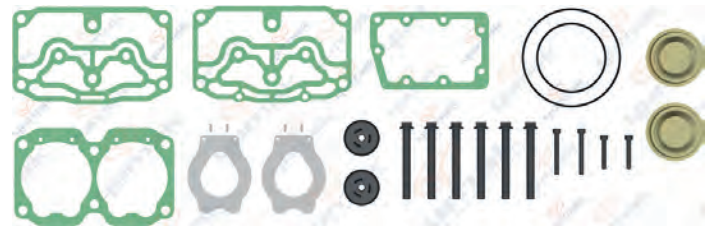

### RK.01.140

Repair Kit

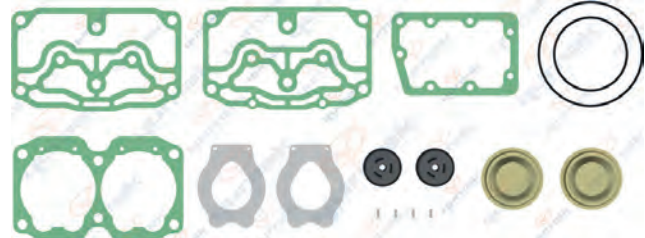

### RK.01.140.02

Repair Kit

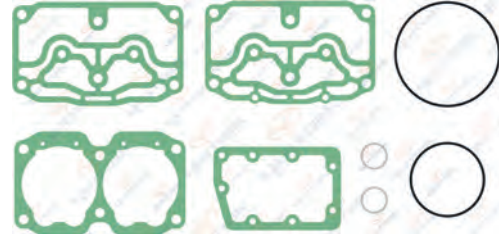

OEM No : 85104629  
Wabco No : 9115050012

### RK.01.140.03

Repair Kit

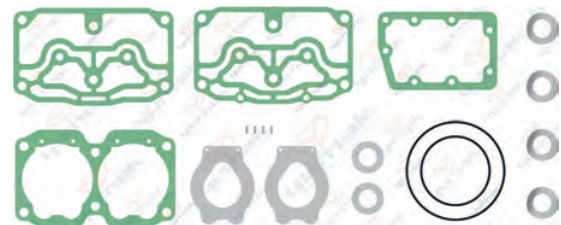

**01.668** Cylinder Head



**01.669** Valve Plate



**01.649** Crankshaft



M20X1.5 Right Hand



OEM No : 1698670  
Wabco No : 9115056914

**01.1230** Bushing



42X38X23



**01.695** Crankshaft Flange



OEM No : 3094836  
Wabco No : 9115056644

**01.697** Connecting Rod



OEM No : 1698678  
Wabco No : 9115057322

**RK.01.132.00** Piston&Ring (Ø85,00 mm)

- RK.01.132.10 85,25 mm
- RK.01.132.20 85,50 mm
- RK.01.132.30 85,75 mm
- RK.01.132.40 86,00 mm



2,00x2,00x4,00



**01.933.00** Piston (Ø85,00 mm)

- 01.933.10 85,25 mm
- 01.933.20 85,50 mm
- 01.933.30 85,75 mm
- 01.933.40 86,00 mm



2,00x2,00x4,00



**01.373.00** Ring (Ø85,00 mm)

- 01.373.10 85,25 mm
- 01.373.20 85,50 mm
- 01.373.30 85,75 mm
- 01.373.40 86,00 mm



2,00x2,00x4,00



OEM No : 3094621  
Wabco No : 9115019202

**RK.01.806** Connecting Rod & Piston



STD.



Wabco No : 4127049422\*

**01.780** Cover



**01.1409** Gear



Noth (Tooth) Pcs : 33



OEM No : 478777 - 470775

**01.302** Cap



**00.441** Roller Bearing



OEM No : 1698671  
Wabco No : 8952510202

**01.144** Nut



M20X1.5 Right Hand



OEM No : 1698672  
Wabco No : 8103410014

## Twin Cylinder Compressor Ø85 mm-636 CC-Stroke 56 mm

Application - Vehicle  
VOLVO FH12 / FH16 / FM9 / FM12 / NH12

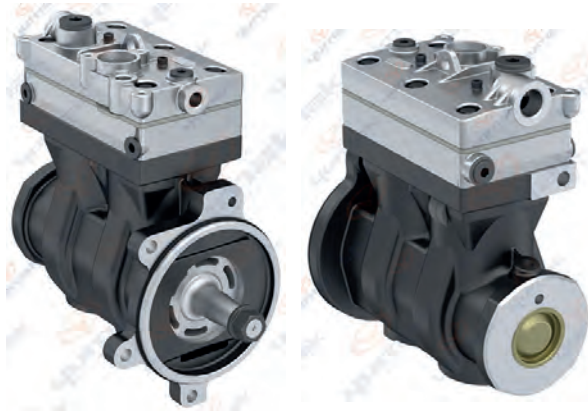

**01.06.071**

Oem. No.  
20774383

Wabco No.  
9125120050  
9125120030



**01.1494**

Crankcase



**RK.01.361.03**

Complete Cylinder Head



OEM No : 20889546\* - 20774299\* - 21418150\* - 21707608\*  
Wabco No : 4127049402\* - 9125129262\* - 9125129252\* - 9125129242\*

**RK.01.352.15**

Repair Kit

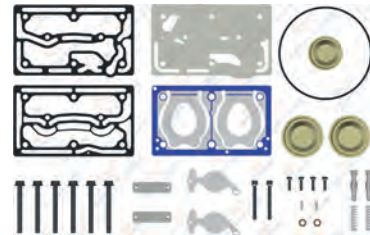

**RK.01.352.10**

Repair Kit

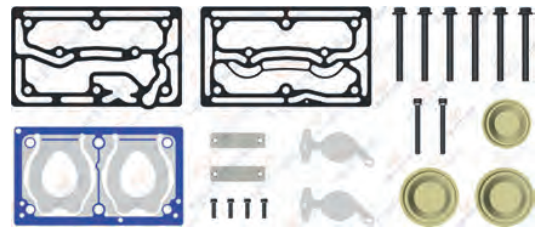

Wabco No : 9125129282

**RK.01.352.17**

Repair Kit

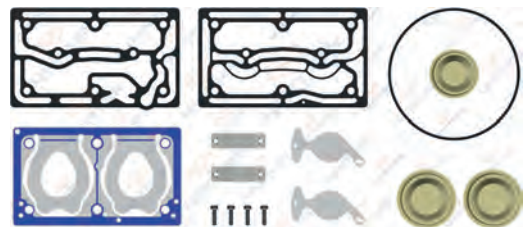

**RK.01.352.19**

Repair Kit

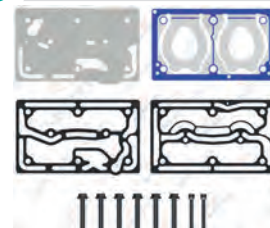

OEM No : 21322318 - 21477052  
Wabco No : 9125129272 - 4127049382

**RK.01.352.11**

Repair Kit

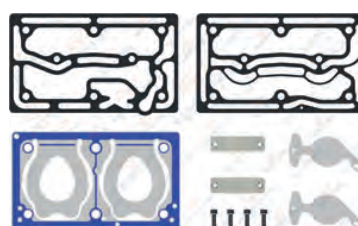

**RK.01.418**

Repair Kit

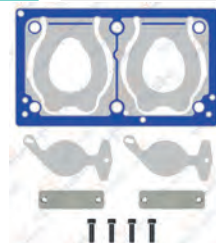



**01.874** Cylinder Head



8 680437 027836

**01.1284** Valve Plate



8 680437 072720

**01.1493** Crankshaft



M20X1.5 Right Hand



8 680437 108931

**01.565** Cooling Plate



8 680437 024095

**01.878** Bushing



8 680437 027898

Wabco No : 9120003404 - 9120003406

**01.272** Connecting Rod



8 680437 020400

**RK.01.104.00** Piston&Ring (Ø85,00 mm)

- RK.01.104.10 85,25 mm
- RK.01.104.20 85,50 mm
- RK.01.104.30 85,75 mm
- RK.01.104.40 86,00 mm



2,00x2,00x4,00



8 680437 060277

**01.142.00** Piston (Ø85,00 mm)

- 01.142.10 85,25 mm
- 01.142.20 85,50 mm
- 01.142.30 85,75 mm
- 01.142.40 86,00 mm



2,00x2,00x4,00



8 680437 018674

Wabco No : 9115016242 - 9115016252

**01.373.00** Ring (Ø85,00 mm)

- 01.373.10 85,25 mm
- 01.373.20 85,50 mm
- 01.373.30 85,75 mm
- 01.373.40 86,00 mm



2,00x2,00x4,00



8 680437 075431

OEM No : 3094621  
Wabco No : 9115019202

**RK.01.803** Connecting Rod & Piston



STD.



8 680437 114567

Wabco No : 9125189242

**01.1227** Bushing



52X48X20



8 680437 017936

**01.144** Nut



M20X1.5 Right Hand



8 680437 018742

OEM No : 1698672  
Wabco No : 8103410014

**RK.01.512** Repair Kit



8 680437 066040

**01.302** Cap



8 680437 020769

**01.1232** Cap



8 680437 018001

## Twin Cylinder Compressor Ø85 mm-636 CC

Application - Vehicle  
VOLVO B9L - B9TL - B9R



**01.05.152**

Oem. No.  
21516476

Wabco No.  
9125120150



**01.1561**

Crankcase



**RK.01.352.11**

Repair Kit

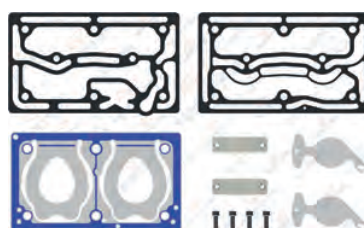

**RK.01.418**

Repair Kit

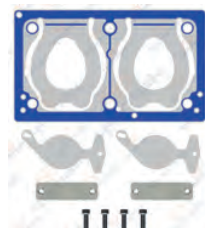

**RK.01.361.02**

Complete Cylinder Head

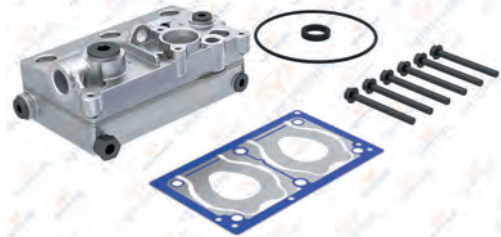

OEM No : 21316442  
Wabco No : 4127049372

**RK.01.361.10**

Complete Cylinder Head

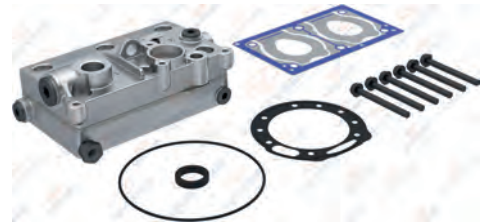

**RK.01.729.05**

Repair Kit

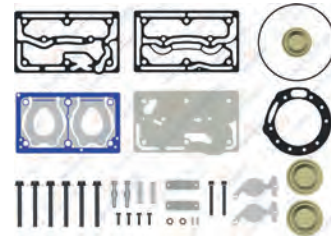

**RK.01.729**

Repair Kit

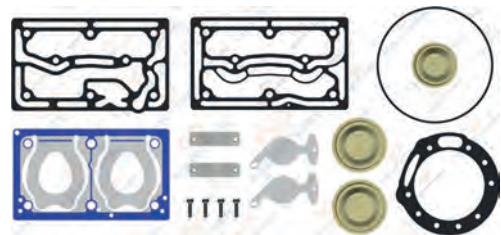

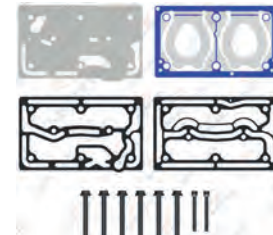

**RK.01.352.19**

Repair Kit



OEM No : 21322318 - 21477052  
Wabco No : 9125129272 - 4127049382

**01.874** Cylinder Head

8 680437 027836

**01.1284.20** Valve Plate



8 680437 101062

**01.876** Crankshaft



M20X1.5 Right Hand



8 680437 027874

**01.565** Cooling Plate



8 680437 024095

**01.878** Bushing



Wabco No : 9120003404 - 9120003406



8 680437 027898

**01.272** Connecting Rod



8 680437 020400

**RK.01.104.00** Piston&Ring (Ø85,00 mm)

RK.01.104.10	85,25 mm
RK.01.104.20	85,50 mm
RK.01.104.30	85,75 mm
RK.01.104.40	86,00 mm



2,00x2,00x4,00



8 680437 060277

**01.142.00** Piston (Ø85,00 mm)

01.142.10	85,25 mm
01.142.20	85,50 mm
01.142.30	85,75 mm
01.142.40	86,00 mm



2,00x2,00x4,00

Wabco No : 9115016242 - 9115016252



8 680437 018674

**01.373.00** Ring (Ø85,00 mm)

01.373.10	85,25 mm
01.373.20	85,50 mm
01.373.30	85,75 mm
01.373.40	86,00 mm



2,00x2,00x4,00

OEM No : 3094621  
Wabco No : 9115019202



8 680437 075431

**RK.01.800** Connecting Rod & Piston



Wabco No : 9125109272 - 4123529252  
- 4123529292



8 680437 078302

**01.1227** Bushing



52X48X20





8 680437 017936

**01.1563** Flange



8 680437 111597

**RK.01.512** Repair Kit

8 680437 066040

**01.302** Cap



8 680437 020769

**01.1232** Cap



8 680437 018001



## Twin Cylinder Compressor Ø92 mm-720 CC-Stroke 54 mm

Application - Vehicle  
VOLVO B7 / 3 SERIES BUS



01.04.144

01.04.143

### 01.04.144 - 01.04.143

**Oem. No.**

7421098922  
7485003045  
21101027  
04905532  
04905533

**Knorr No.**

LK4954-K017528  
LK4944-K017527000



01.1385

Crankcase



RK.01.264.06

Repair Kit

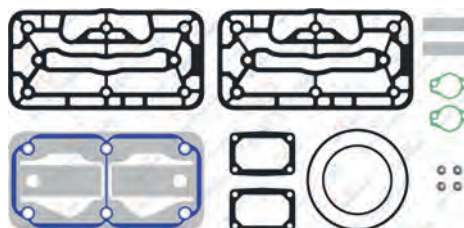

Knorr No : K012086

RK.01.264.02

Repair Kit

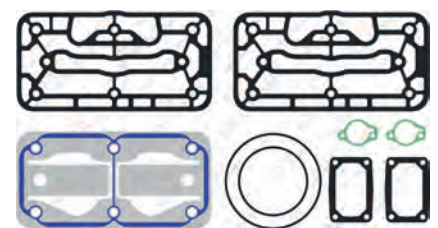

RK.01.670

Complete Cylinder Head



RK.01.670.01

Complete Cylinder Head

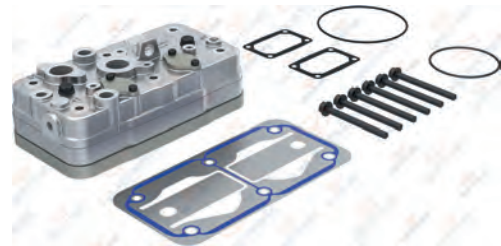

RK.01.568

Valve Plate Kit

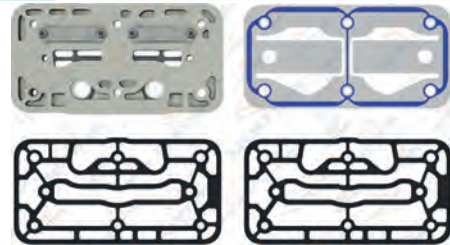

RK.01.264.01

Repair Kit

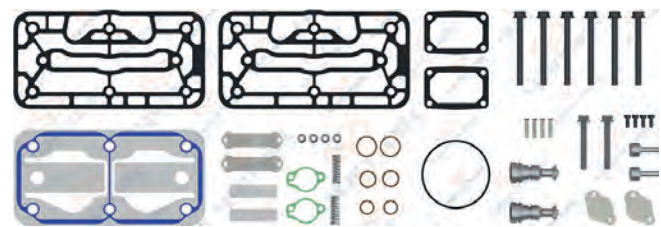

RK.01.264

Repair Kit

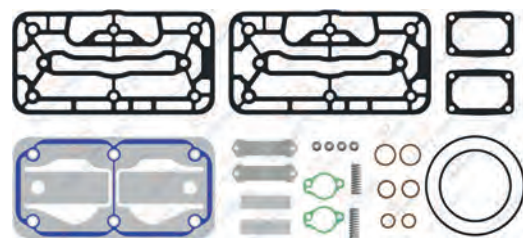

**01.1444** Cylinder Head



8 680437 074298  
**OEM No :** 21136561  
**Knorr No :** K017529

**01.1161** Cooling Plate



8 680437 017059

**01.1337** Crankshaft



**M20X1.5 Right Hand**  
 8 680437 074106

**01.1162** Valve Plate



8 680437 017066  
**OEM No :** 21136726  
**Knorr No :** K012074

**01.1206** Crankshaft Flange



8 680437 017622

**01.1056** Connecting Rod



8 680437 015345

**RK.01.318.00** Piston&Ring (Ø92,00 mm)

- RK.01.318.10 92,25 mm
- RK.01.318.20 92,50 mm
- RK.01.318.30 92,75 mm
- RK.01.318.40 93,00 mm



2,50x2,50x4,00  
 8 680437 063773  
**Knorr No :** K012079

**01.862.00** Piston (Ø92,00 mm)

- 01.862.10 92,25 mm
- 01.862.20 92,50 mm
- 01.862.30 92,75 mm
- 01.862.40 93,00 mm



2,50x2,50x4,00  
 8 680437 027584

**01.942.00** Ring (Ø92,00 mm)

- 01.942.10 92,25 mm
- 01.942.20 92,50 mm
- 01.942.30 92,75 mm
- 01.942.40 93,00 mm



2,50x2,50x4,00  
 8 680437 028666

**01.374** Cover



8 680437 077022

**01.292** Bushing



42x38x25  
 8 680437 073871

**51.01.008** Safety Valve



8 680437 073567

**RK.01.428** Repair Kit

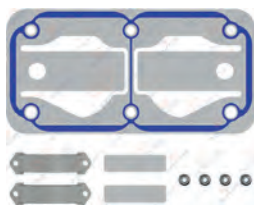

8 680437 065128

**RK.01.558** Repair Kit

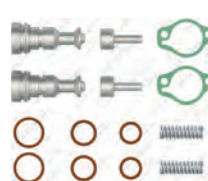

8 680437 066613  
**Knorr No :** K034874K50

**RK.01.813** Connecting Rod & Piston



STD.  
 8 680437 114635



## Twin Cylinder Compressor Ø75 mm-440 CC-Stroke 50 mm

Application - Vehicle  
VOLVO B55 / F12 / FL7 / FL10 / F89 / FH12



### 01.05.010

Oem. No.	Knorr No.
1612335-5001608	KZ433
1570594-1590264	KZ433/1X50
1080437-8112780	KZ433/1RM
1186722-5001711	1186722SP

### 01.05.010.10

With Gear



### 01.061

Crankcase



### RK.01.052

Repair Kit

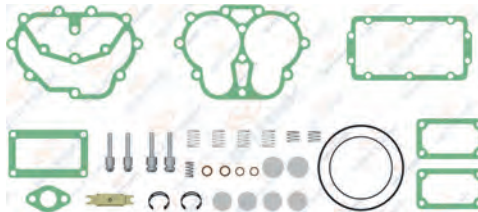

OEM No : 3090471 - 272665 - 270698

### RK.01.077

Repair Kit



### RK.01.050

Complete Cylinder Head



### RK.01.050.20

Complete Cylinder Head



### RK.01.051

Valve Plate Kit

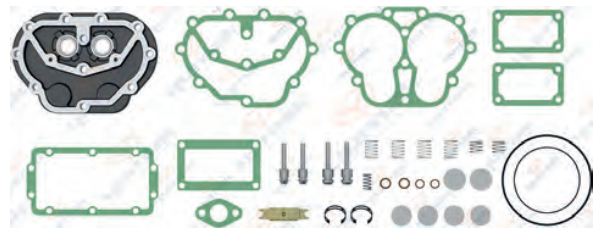

### RK.01.052.01

Repair Kit

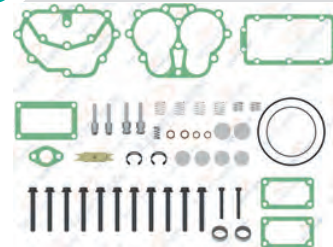

### RK.01.052.02

Repair Kit

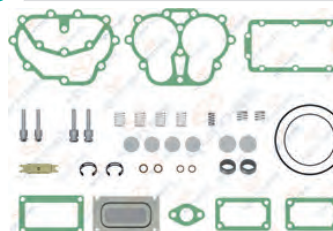



**01.078** Cylinder Head



OEM No : 3090472  
8 680437 014201

**01.126** Valve Plate

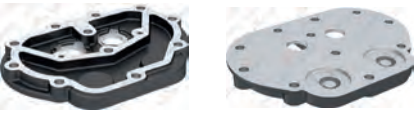

8 680437 018148

**01.021** Crankshaft Flange



OEM No : 3090239  
8 680437 010104

**01.100** Crankshaft



M20X1.5 Left Hand

8 680437 014584

**00.266** Roller Bearing



6207  
8 680437 002857

**01.009** Connecting Rod



OEM No : 3090257  
8 680437 009818

**RK.01.075.00** Piston&Ring (Ø75,00 mm)

- RK.01.075.10 75,25 mm
- RK.01.075.20 75,50 mm
- RK.01.075.30 75,75 mm
- RK.01.075.40 76,00 mm



2.385x2.385x3.947  
8 680437 059615

**01.116.00** Piston (Ø75,00 mm)

- 01.116.10 75,25 mm
- 01.116.20 75,50 mm
- 01.116.30 75,75 mm
- 01.116.40 76,00 mm



2.385x2.385x3.947  
OEM No : 1697706  
8 680437 016984

**01.141.00** Ring (Ø75,00 mm)

- 01.141.10 75,25 mm
- 01.141.20 75,50 mm
- 01.141.30 75,75 mm
- 01.141.40 76,00 mm



2.385x2.385x3.947  
OEM No : 3094155  
8 680437 018612

**01.079** Cover



8 680437 014232

**01.080** Cover

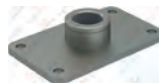

8 680437 014263

**01.1408** Gear



Noth (Tooth) Pcs : 33  
OEM No : 423087  
8 680437 072546

**RK.01.052.24** Repair Kit



8 680437 073666

**RK.01.186** Repair Kit

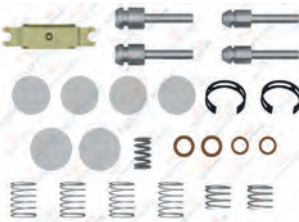

8 680437 061922

**01.579** Nut



M20X1.5 Left Hand  
8 680437 024248

## Twin Cylinder Compressor Ø75 mm-440 CC-Stroke 50 mm

Application - Vehicle  
VOLVO B55 / F12 / FL7 / FL10 / F89 / FH12

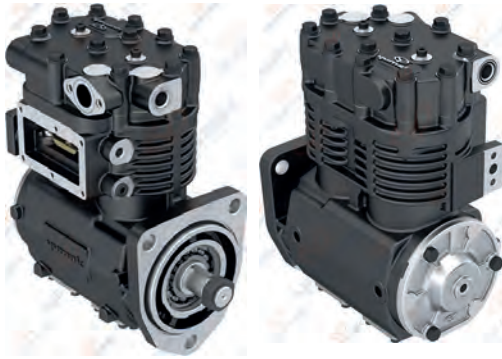

### 01.05.010.01

Oem. No.	Knorr No.
3018546	KZ433/6
8112781	KZ433/6X50
5001711	



01.061

Crankcase



RK.01.052

Repair Kit

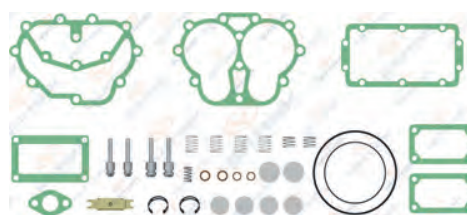

OEM No : 3090471 - 272665 - 270698

RK.01.077

Repair Kit



RK.01.050

Complete Cylinder Head



RK.01.050.20

Complete Cylinder Head

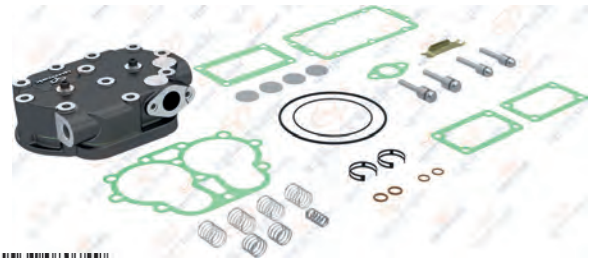

RK.01.051

Valve Plate Kit

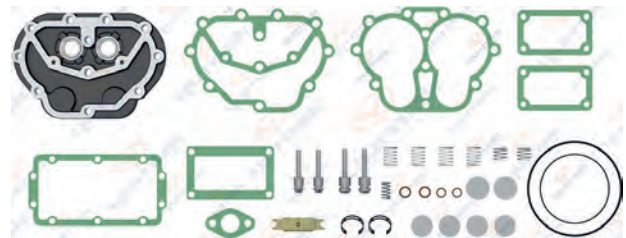

RK.01.052.01

Repair Kit

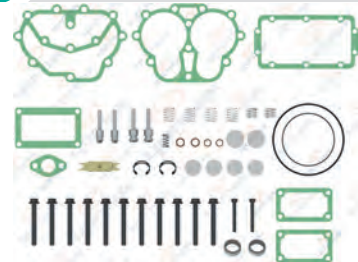

RK.01.052.02

Repair Kit

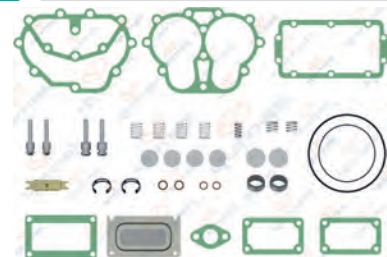

**01.078** Cylinder Head

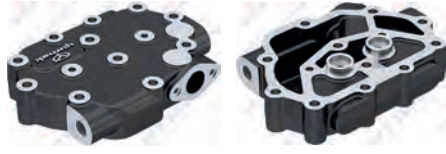

Barcode: 8 680437 014201  
OEM No : 3090472

**01.021** Crankshaft Flange



Barcode: 8 680437 010104  
OEM No : 3090239

**01.100** Crankshaft



M20X1.5 Left Hand

Barcode: 8 680437 014584

**01.126** Valve Plate

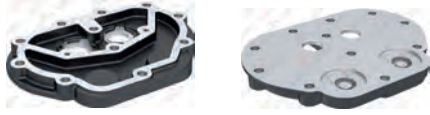

Barcode: 8 680437 018148

**RK.01.805** Connecting Rod & Piston



Barcode: 8 680437 114574

**01.009** Connecting Rod



Barcode: 8 680437 009818  
OEM No : 3090257

**RK.01.075.00** Piston&Ring (Ø75,00 mm)

- RK.01.075.10 75,25 mm
- RK.01.075.20 75,50 mm
- RK.01.075.30 75,75 mm
- RK.01.075.40 76,00 mm



2.385x2.385x3.947  
Barcode: 8 680437 059615

**01.116.00** Piston (Ø75,00 mm)

- 01.116.10 75,25 mm
- 01.116.20 75,50 mm
- 01.116.30 75,75 mm
- 01.116.40 76,00 mm



2.385x2.385x3.947  
Barcode: 8 680437 016984  
OEM No : 1697706

**01.141.00** Ring (Ø75,00 mm)

- 01.141.10 75,25 mm
- 01.141.20 75,50 mm
- 01.141.30 75,75 mm
- 01.141.40 76,00 mm



2.385x2.385x3.947  
Barcode: 8 680437 018612  
OEM No : 3094155

**01.018** Bushing



39X35X25  
Barcode: 8 680437 077220

**00.266** Roller Bearing



6207  
Barcode: 8 680437 002857

**01.1408** Gear



Noth (Tooth) Pcs : 33  
Barcode: 8 680437 072546  
OEM No : 423087

**RK.01.052.24** Repair Kit



Barcode: 8 680437 073666

**RK.01.186** Repair Kit



Barcode: 8 680437 061922

**RK.01.279** Repair Kit



Barcode: 8 680437 063322



## Twin Cylinder Compressor Ø88 mm-600 CC-Stroke 50 mm

Application - Vehicle  
VOLVO FH12-FM16-NH12-B12



### 01.04.017

Oem. No.	Knorr No.
20429339	LP4930
3987602	K000236000
1628593	LP4974
8113264	
85000064	

01.04.017.10

With Gear



01.757 Crankcase



RK.01.083.12 Repair Kit

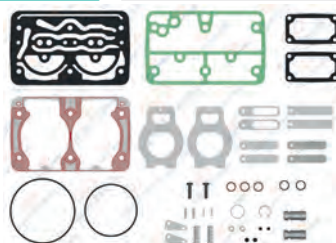

RK.01.083.03 Repair Kit

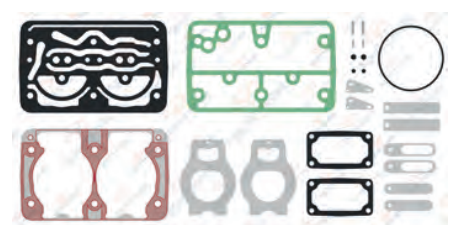

RK.01.470 Complete Cylinder Head



RK.01.470.20 Complete Cylinder Head

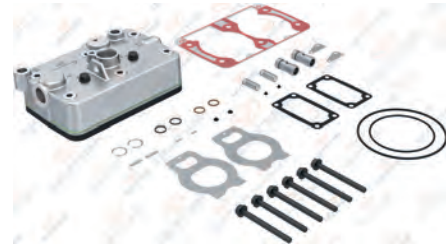

RK.01.082.05 Valve Plate Kit

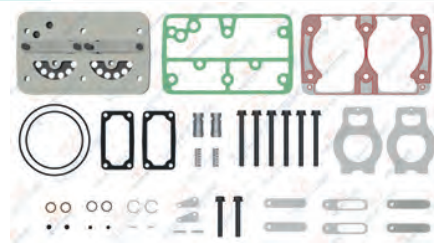

RK.01.082 Valve Plate Kit

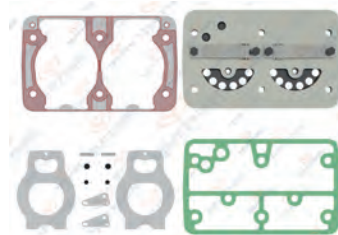

RK.01.083.13 Repair Kit

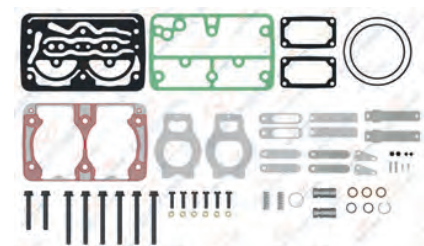

**01.268** Cylinder Head



**01.288** Crankshaft Flange



OEM No : 3097150  
Knorr No : II159920065

**01.647** Crankshaft



M20X1.5 Right Hand



**RK.01.082.02** Valve Plate Kit



OEM No : 3097146  
Knorr No : SEB01033004

**RK.01.807** Connecting Rod & Piston



STD.



**01.226** Connecting Rod



OEM No : 3097151  
Knorr No : SEB00967004

**RK.01.034.00** Piston&Ring (Ø88,00 mm)

- RK.01.034.10 88,25 mm
- RK.01.034.20 88,50 mm
- RK.01.034.30 88,75 mm
- RK.01.034.40 89,00 mm



2,50x2,50x4,00



OEM No : 85101375-3095841-1698848  
Knorr No : I81169004

**01.110.00** Piston (Ø88,00 mm)

- 01.110.10 88,25 mm
- 01.110.20 88,50 mm
- 01.110.30 88,75 mm
- 01.110.40 89,00 mm



2,50x2,50x4,00



**01.136.00** Ring (Ø88,00 mm)

- 01.136.10 88,25 mm
- 01.136.20 88,50 mm
- 01.136.30 88,75 mm
- 01.136.40 89,00 mm



2,50x2,50x4,00



**RK.01.126** Repair Kit



OEM No : 3097147  
Knorr No : II159920063

**01.292** Bushing



42X38X25



**01.1407** Gear



Noth (Tooth) Pcs : 27



OEM No : 1677848

**RK.01.083.21** Repair Kit

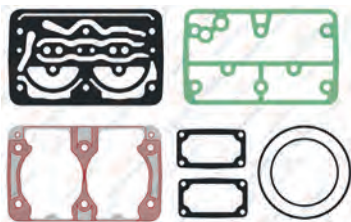

Knorr No : SEB22561

**RK.01.088.20** Repair Kit



OEM No : 3091739  
Knorr No : II326840061

**RK.01.088** Repair Kit





## Twin Cylinder Compressor Ø88 mm-600 cc-Stroke 50 mm

Application - Vehicle  
VOLVO B10M



### 01.04.011

**Oem. No.**  
3037346  
8112543  
81125437

**Knorr No.**  
LP4934  
II30895



### 01.228 Crankcase



### RK.01.083 Repair Kit

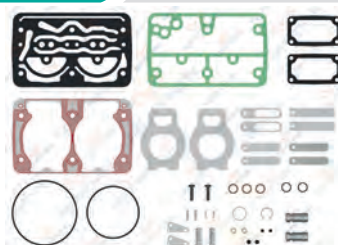

### RK.01.309 Complete Cylinder Head



### RK.01.309.20 Complete Cylinder Head



### RK.01.082.20 Valve Plate Kit

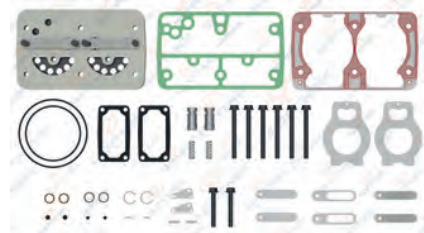

### RK.01.082 Valve Plate Kit

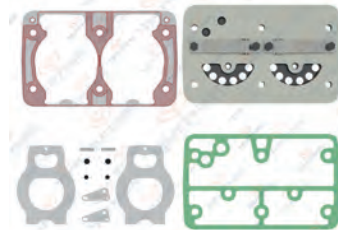

### RK.01.083.01 Repair Kit

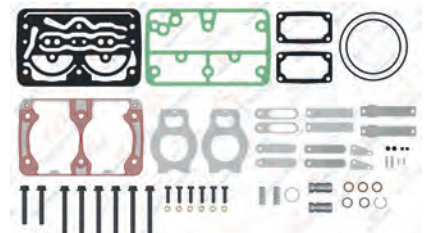

### RK.01.083.03 Repair Kit





**01.225** Cylinder Head



**01.288** Crankshaft Flange



OEM No : 3097150  
Knorr No : II159920065

**01.227** Crankshaft



M20X1.5 Right Hand



**RK.01.082.02** Valve Plate Kit



OEM No : 3097146  
Knorr No : SEB01033004

**01.292** Bushing



42X38X25



**01.226** Connecting Rod



OEM No : 3097151  
Knorr No : SEB00967004

**RK.01.034.00** Piston&Ring (Ø88,00 mm)

- RK.01.034.10 88,25 mm
- RK.01.034.20 88,50 mm
- RK.01.034.30 88,75 mm
- RK.01.034.40 89,00 mm



2,50x2,50x4,00



OEM No : 85101375-3095841-1698848  
Knorr No : I81169004

**01.110.00** Piston (Ø88,00 mm)

- 01.110.10 88,25 mm
- 01.110.20 88,50 mm
- 01.110.30 88,75 mm
- 01.110.40 89,00 mm



2,50x2,50x4,00



**01.136.00** Ring (Ø88,00 mm)

- 01.136.10 88,25 mm
- 01.136.20 88,50 mm
- 01.136.30 88,75 mm
- 01.136.40 89,00 mm



2,50x2,50x4,00



**RK.01.126** Repair Kit



OEM No : 3097147  
Knorr No : II159920063

**01.414** Cover



**01.144** Nut



M20X1.5 Right Hand



OEM No : 1698672

**RK.01.083.20** Repair Kit

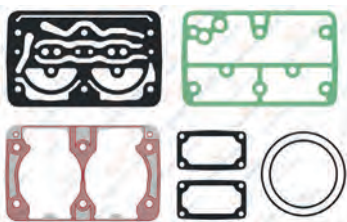

Knorr No : SEB22561\*

**RK.01.088.20** Repair Kit



OEM No : 3091739  
Knorr No : II326840061

**RK.01.088** Repair Kit



## Twin Cylinder Compressor Ø88 mm-600 CC-Stroke 50 mm

**Application - Vehicle**  
VOLVO FH12, FH16 / FM7, FM12 / NH12, FL12 /  
B12, B12B, B12R, B7L



### 01.04.029

Oem. No.	Knorr No.
85000066	LP4985
20429343	K000229000
8113405	
3173001	

### 01.04.029.11

With Gear



01.04.029.10 (01.1407)  
01.04.029.11 (01.280)  
01.04.029.12 (01.1487)



8 680437 011026



### 01.873

Crankcase



8 680437 027829

### RK.01.133.20

Repair Kit



8 680437 079156

### RK.01.133

Repair Kit



8 680437 060857

### RK.01.310

Complete Cylinder Head



8 680437 063674

### RK.01.310.20

Complete Cylinder Head

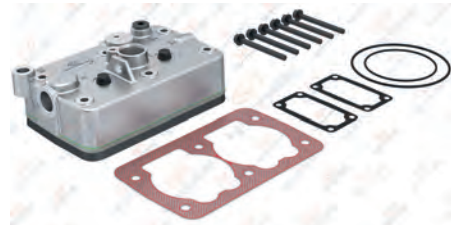

8 680437 073260

### RK.01.197.20

Valve Plate Kit

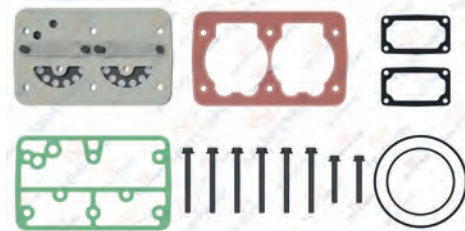

8 680437 112839

### RK.01.197

Valve Plate Kit



8 680437 062073

### RK.01.133.01

Repair Kit

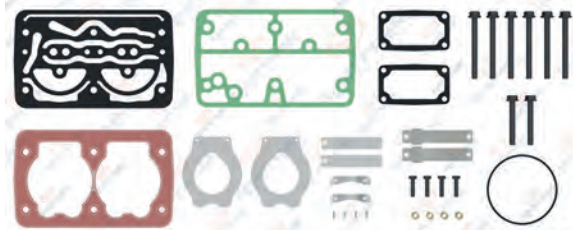

8 680437 060871

**01.816** Cylinder Head



**01.288** Crankshaft Flange



OEM No : 3097150  
Knorr No : II159920065

**01.647** Crankshaft



M20X1.5 Right Hand



**RK.01.197.01** Valve Plate Kit



OEM No : 3095845  
Knorr No : SEB01034004

**RK.01.192** Repair Kit



Knorr No : SEB22557

**01.226** Connecting Rod



OEM No : 3097151  
Knorr No : SEB00967004

**RK.01.034.00** Piston&Ring (Ø88,00 mm)

- RK.01.034.10 88,25 mm
- RK.01.034.20 88,50 mm
- RK.01.034.30 88,75 mm
- RK.01.034.40 89,00 mm



2,50x2,50x4,00



OEM No : 85101375-3095841-1698848  
Knorr No : I81169004

**01.110.00** Piston (Ø88,00 mm)

- 01.110.10 88,25 mm
- 01.110.20 88,50 mm
- 01.110.30 88,75 mm
- 01.110.40 89,00 mm



2,50x2,50x4,00



**01.136.00** Ring (Ø88,00 mm)

- 01.136.10 88,25 mm
- 01.136.20 88,50 mm
- 01.136.30 88,75 mm
- 01.136.40 89,00 mm



2,50x2,50x4,00



**01.1487** Gear



OEM No : 1549425

**01.280** Gear



OEM No : 8170446

**01.1407** Gear



Noth (Tooth) Pcs : 27



OEM No : 1677848

**RK.01.133.23** Repair Kit



**RK.01.807** Connecting Rod & Piston



**01.414** Cover





## Twin Cylinder Compressor Ø88 mm-600 CC-Stroke 50 mm

Application - Vehicle  
VOLVO -B10M-B10L-B10B



### 01.04.037

**Oem. No.**  
8113023  
9521675  
81130239

**Knorr No.**  
LP4967  
II33164000



**01.761**

Crankcase



**RK.01.083**

Repair Kit

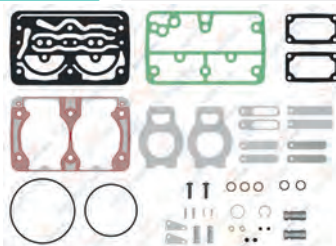

**RK.01.083.03**

Repair Kit

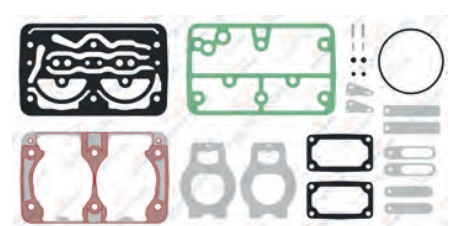

**RK.01.309**

Complete Cylinder Head



**RK.01.309.20**

Complete Cylinder Head



**RK.01.082.20**

Valve Plate Kit

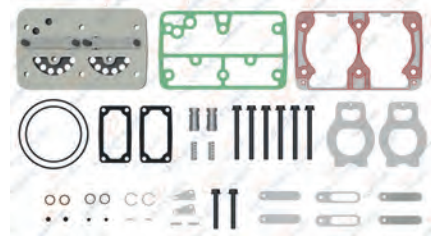

**RK.01.082**

Valve Plate Kit

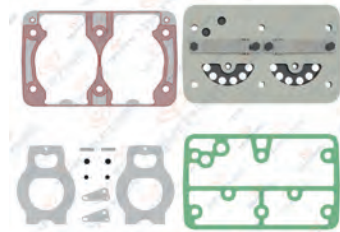

**RK.01.083.01**

Repair Kit

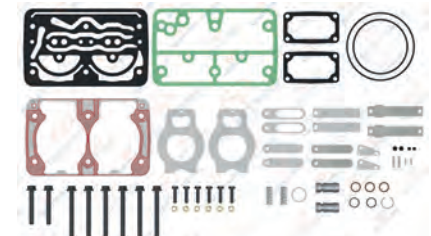

**01.225** Cylinder Head

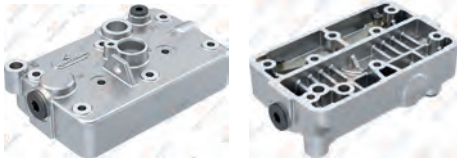

8 680437 019800

**01.288** Crankshaft Flange



8 680437 020615

OEM No : 3097150  
Knorr No : II159920065

**01.227** Crankshaft



M20X1.5 Right Hand



8 680437 019831

**RK.01.082.02** Valve Plate Kit



8 680437 112679

OEM No : 3097146  
Knorr No : SEB01033004

**RK.01.807** Connecting Rod & Piston



STD.



8 680437 114598

**01.226** Connecting Rod



8 680437 019824

OEM No : 3097151  
Knorr No : SEB00967004

**RK.01.034.00** Piston&Ring (Ø88,00 mm)

- RK.01.034.10 88,25 mm
- RK.01.034.20 88,50 mm
- RK.01.034.30 88,75 mm
- RK.01.034.40 89,00 mm



2,50x2,50x4,00



8 680437 058816

OEM No : 85101375-3095841-1698848  
Knorr No : I81169004

**01.110.00** Piston (Ø88,00 mm)

- 01.110.10 88,25 mm
- 01.110.20 88,50 mm
- 01.110.30 88,75 mm
- 01.110.40 89,00 mm



2,50x2,50x4,00



8 680437 015994

**01.136.00** Ring (Ø88,00 mm)

- 01.136.10 88,25 mm
- 01.136.20 88,50 mm
- 01.136.30 88,75 mm
- 01.136.40 89,00 mm



2,50x2,50x4,00



8 680437 018384

**RK.01.126** Repair Kit



8 680437 060642

OEM No : 3097147  
Knorr No : II159920063

**01.414** Cover



8 680437 022312

**01.292** Bushing



42X38X25



8 680437 073871

**RK.01.083.20** Repair Kit

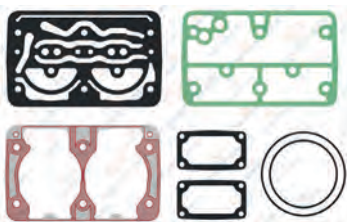

8 680437 076964

Knorr No : SEB22561

**RK.01.088.20** Repair Kit



8 680437 124177

OEM No : 3091739  
Knorr No : II326840061

**RK.01.088** Repair Kit



8 680437 059943



## Twin Cylinder Compressor Ø88 mm-600 CC

**Application - Vehicle**  
VOLVO FH12, FH16 / FM7, FM12 / NH12, FL12  
B12, B12B, B12R, B7L

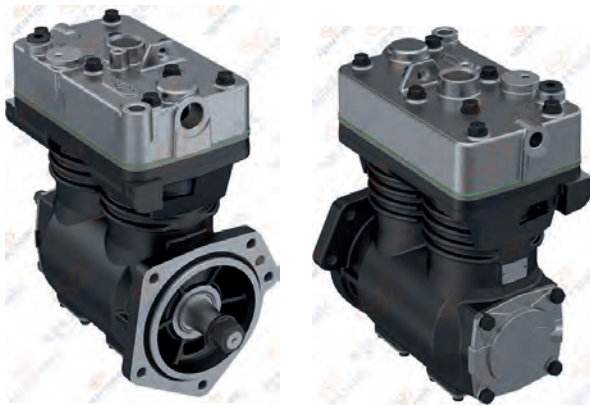

### 01.04.046

**Oem. No.**  
70330098  
85000199

**Knorr No.**  
LP4991  
K002031000  
LP4992  
K002031000



01.873

Crankcase



RK.01.310

Complete Cylinder Head



RK.01.310.20

Complete Cylinder Head

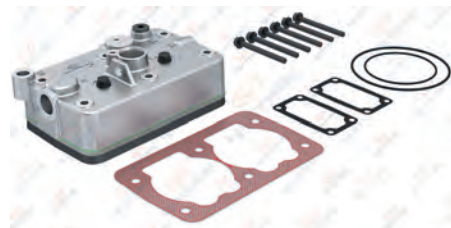

RK.01.197.20

Valve Plate Kit

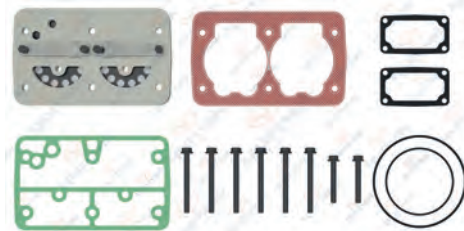

RK.01.197

Valve Plate Kit



RK.01.133.01

Repair Kit

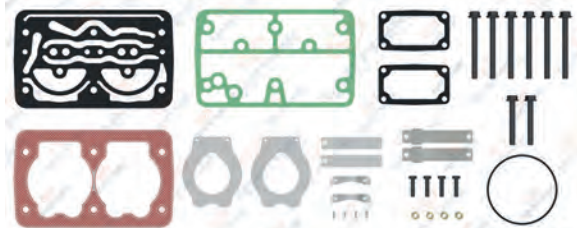

RK.01.133.20

Repair Kit

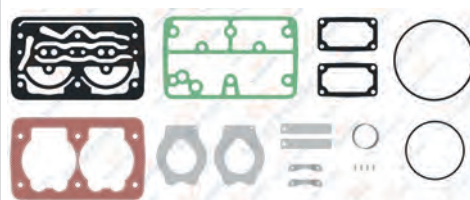

RK.01.133

Repair Kit





**01.816** Cylinder Head

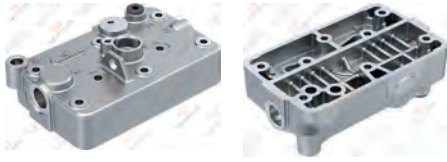

**01.288** Crankshaft Flange



OEM No : 3097150  
Knorr No : II159920065

**01.647** Crankshaft



M20X1.5 Right Hand



**RK.01.197.01** Valve Plate Kit



OEM No : 3095845  
Knorr No : SEB01034004

**RK.01.192** Repair Kit



Knorr No : SEB22557

**01.226** Connecting Rod



OEM No : 3097151  
Knorr No : SEB00967004

**RK.01.034.00** Piston&Ring (Ø88,00 mm)

- RK.01.034.10 88,25 mm
- RK.01.034.20 88,50 mm
- RK.01.034.30 88,75 mm
- RK.01.034.40 89,00 mm



2,50x2,50x4,00



OEM No : 85101375-3095841-1698848  
Knorr No : I81169004

**01.110.00** Piston (Ø88,00 mm)

- 01.110.10 88,25 mm
- 01.110.20 88,50 mm
- 01.110.30 88,75 mm
- 01.110.40 89,00 mm

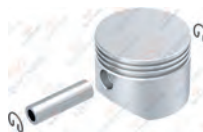

2,50x2,50x4,00



**01.136.00** Ring (Ø88,00 mm)

- 01.136.10 88,25 mm
- 01.136.20 88,50 mm
- 01.136.30 88,75 mm
- 01.136.40 89,00 mm



2,50x2,50x4,00



**01.941** Cover



**01.414** Cover



**01.292** Bushing



42X38X25



**RK.01.133.22** Repair Kit

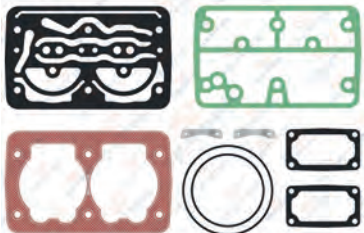

**RK.01.133.23** Repair Kit



**01.1487** Gear



OEM No : 1549425

## Twin Cylinder Compressor Ø88 mm-600 CC-Stroke 50 mm

**Application - Vehicle**  
VOLVO / FL12CH / CITY BUS B10M /  
BUS B10B / B10L / B10BLE / B10LA



### 01.04.055

Oem. No.	Knorr No.
20442353	LP4960
8112851	K000237000
8157550	
85000065	



### 01.757

Crankcase



### RK.01.083.13

Repair Kit

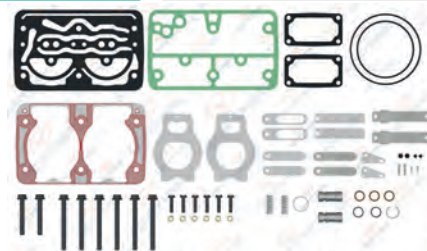

### RK.01.083.07

Repair Kit

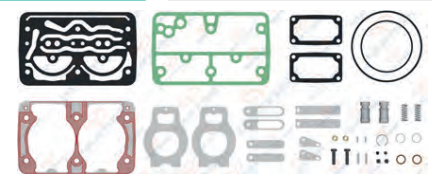

### RK.01.309

Complete Cylinder Head



### RK.01.309.19

Complete Cylinder Head



### RK.01.309.01

Complete Cylinder Head

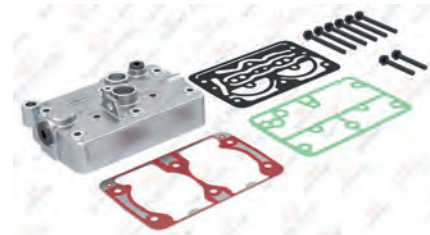

OEM No : 3097144  
Knorr No : SEB01052004 - K070845K50

### RK.01.082.05

Valve Plate Kit

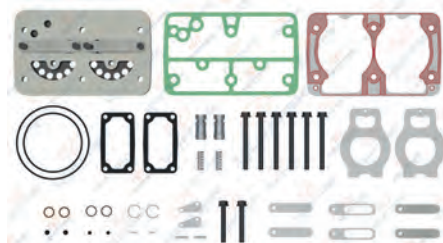

### RK.01.082

Valve Plate Kit

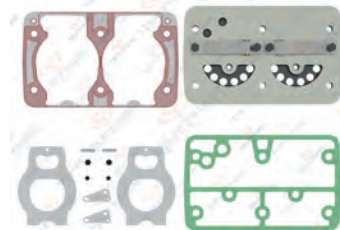

**01.225** Cylinder Head



**01.288** Crankshaft Flange



OEM No : 3097150  
Knorr No : II159920065

**01.647** Crankshaft



M20X1.5 Right Hand



**RK.01.082.02** Valve Plate Kit



OEM No : 3097146  
Knorr No : SEB01033004

**01.292** Bushing



42X38X25



**01.226** Connecting Rod



OEM No : 3097151  
Knorr No : SEB00967004

**RK.01.034.00** Piston&Ring (Ø88,00 mm)

- RK.01.034.10 88,25 mm
- RK.01.034.20 88,50 mm
- RK.01.034.30 88,75 mm
- RK.01.034.40 89,00 mm



2,50x2,50x4,00



OEM No : 85101375-3095841-1698848  
Knorr No : I81169004

**01.110.00** Piston (Ø88,00 mm)

- 01.110.10 88,25 mm
- 01.110.20 88,50 mm
- 01.110.30 88,75 mm
- 01.110.40 89,00 mm



2,50x2,50x4,00



**01.136.00** Ring (Ø88,00 mm)

- 01.136.10 88,25 mm
- 01.136.20 88,50 mm
- 01.136.30 88,75 mm
- 01.136.40 89,00 mm



2,50x2,50x4,00



**RK.01.126** Repair Kit



OEM No : 3097147  
Knorr No : II159920063

**01.414** Cover



**01.144** Nut



M20X1.5 Right Hand



OEM No : 1698672

**RK.01.083.21** Repair Kit

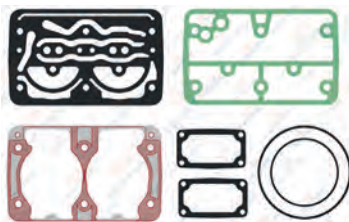

Knorr No : SEB22561

**RK.01.088.20** Repair Kit



OEM No : 3091739  
Knorr No : II326840061

**RK.01.088** Repair Kit



**RK.01.083.03** Repair Kit

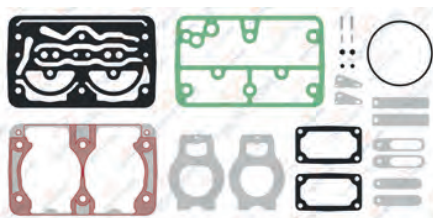



## Twin Cylinder Compressor Ø88 mm-600 CC-Stroke 50 mm

Application - Vehicle  
VOLVO B10M / B10L / B10B / BUS B10L / B10LA



### 01.04.056

Oem. No.	Knorr No.
70305889	LK4918
70303443	K001267000
70330081	LP4986
8113633	K001267000
85000194	LP4993
85000080	K001267000
3193734	



### 01.792

Crankcase



### RK.01.133.24

Repair Kit



### RK.01.133.25

Repair Kit

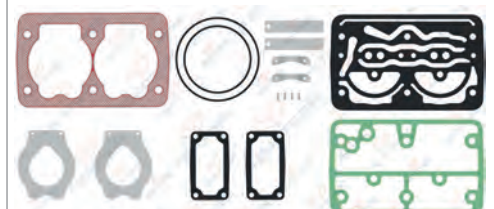

### RK.01.326

Complete Cylinder Head



### RK.01.326.20

Complete Cylinder Head

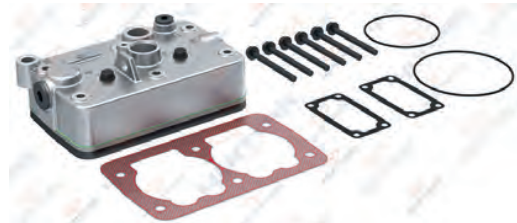

### RK.01.197.21

Valve Plate Kit

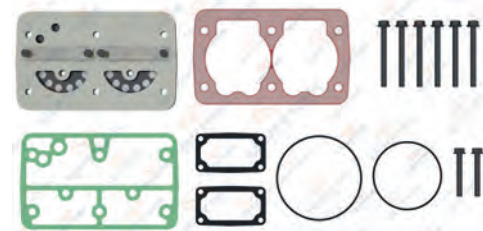

### RK.01.197

Valve Plate Kit



### RK.01.133.01

Repair Kit

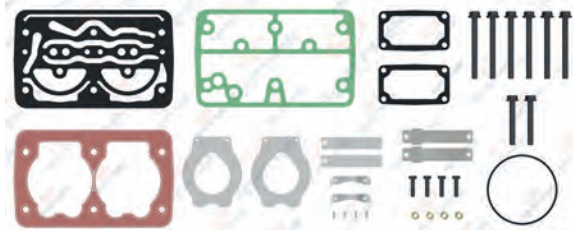

**01.817** Cylinder Head



8 680437 027010

**01.288** Crankshaft Flange



OEM No : 3097150  
Knorr No : II159920065

8 680437 020615

**01.227** Crankshaft



M20X1.5 Right Hand

8 680437 019831

**RK.01.197.01** Valve Plate Kit



OEM No : 3095845  
Knorr No : SEB01034004

8 680437 112877

**RK.01.807** Connecting Rod & Piston



STD.

8 680437 114598

**01.226** Connecting Rod



OEM No : 3097151  
Knorr No : SEB00967004

8 680437 019824

**RK.01.034.00** Piston&Ring (Ø88,00 mm)

RK.01.034.10	88,25 mm
RK.01.034.20	88,50 mm
RK.01.034.30	88,75 mm
RK.01.034.40	89,00 mm



2,50x2,50x4,00

OEM No : 85101375-3095841-1698848  
Knorr No : I81169004

8 680437 058816

**01.110.00** Piston (Ø88,00 mm)

01.110.10	88,25 mm
01.110.20	88,50 mm
01.110.30	88,75 mm
01.110.40	89,00 mm



2,50x2,50x4,00

8 680437 015994

**01.136.00** Ring (Ø88,00 mm)

01.136.10	88,25 mm
01.136.20	88,50 mm
01.136.30	88,75 mm
01.136.40	89,00 mm



2,50x2,50x4,00

8 680437 018384

**01.414** Cover



8 680437 022312

**01.292** Bushing



42X38X25

8 680437 073871

**01.144** Nut



M20X1.5 Right Hand

OEM No : 1698672

8 680437 018742

**RK.01.133.22** Repair Kit



8 680437 076933

**RK.01.133.23** Repair Kit



8 680437 073789

**RK.01.133.24** Repair Kit



8 680437 076934

## Twin Cylinder Compressor Ø88 mm-600 CC-Stroke 50 mm

Application - Vehicle  
VOLVO CITY BUS / BUS B7R /  
B7RLE / B10M / B6LE



### 01.04.060

Oem. No.	Knorr No.
85000197	LK4921
70330094	LP4996
70303446	K001268X00
3194908	
8113634	
70330004	
70305892	



### 01.778 Crankcase



### RK.01.133.20 Repair Kit



### RK.01.133 Repair Kit



### RK.01.326 Complete Cylinder Head



### RK.01.326.20 Complete Cylinder Head

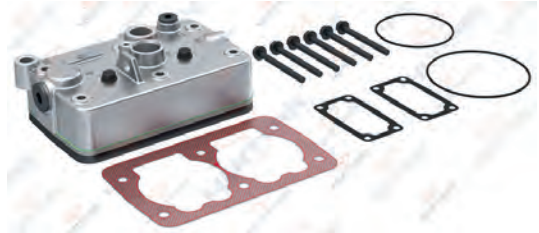

### RK.01.197.21 Valve Plate Kit

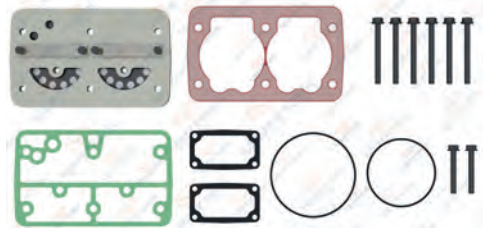

### RK.01.197 Valve Plate Kit



### RK.01.133.01 Repair Kit

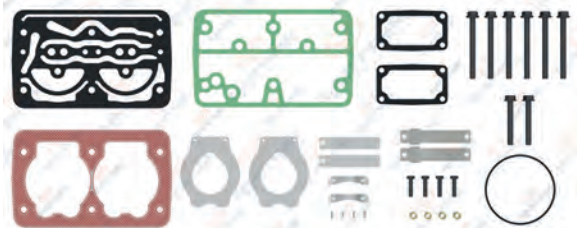



**01.817** Cylinder Head



**01.288** Crankshaft Flange



OEM No : 3097150  
Knorr No : II159920065

**01.227** Crankshaft



M20X1.5 Right Hand



**RK.01.197.01** Valve Plate Kit



OEM No : 3095845  
Knorr No : SEB01034004

**RK.01.807** Connecting Rod & Piston



STD.



**01.226** Connecting Rod



OEM No : 3097151  
Knorr No : SEB00967004

**RK.01.034.00** Piston&Ring (Ø88,00 mm)

- RK.01.034.10 88,25 mm
- RK.01.034.20 88,50 mm
- RK.01.034.30 88,75 mm
- RK.01.034.40 89,00 mm



2,50x2,50x4,00



OEM No : 85101375-3095841-1698848  
Knorr No : I81169004

**01.110.00** Piston (Ø88,00 mm)

- 01.110.10 88,25 mm
- 01.110.20 88,50 mm
- 01.110.30 88,75 mm
- 01.110.40 89,00 mm



2,50x2,50x4,00



**01.136.00** Ring (Ø88,00 mm)

- 01.136.10 88,25 mm
- 01.136.20 88,50 mm
- 01.136.30 88,75 mm
- 01.136.40 89,00 mm



2,50x2,50x4,00



**01.414** Cover



**01.292** Bushing



42X38X25



**01.144** Nut



M20X1.5 Right Hand



OEM No : 1698672

**RK.01.133.22** Repair Kit

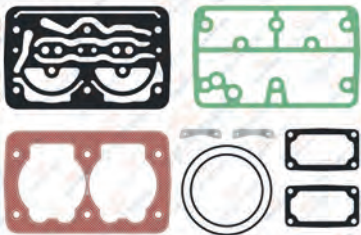

**RK.01.133.23** Repair Kit



**01.1409** Gear



Noth (Tooth) Pcs : 33



OEM No : 478777 - 470775

## Twin Cylinder Compressor Ø88 mm-608 CC-Stroke 50 mm

Application - Vehicle  
VOLVO



**01.04.104**

Knorr No.  
LP4955  
II31730



**01.1578** Crankcase



**RK.01.083.03** Repair Kit

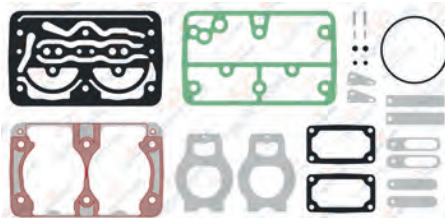

**RK.01.088** Repair Kit



**RK.01.646** Complete Cylinder Head



**RK.01.082.05** Valve Plate Kit

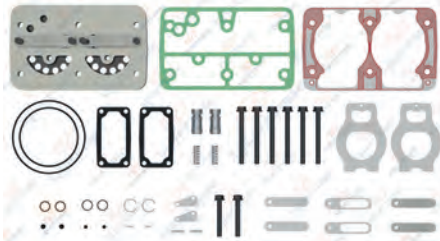

**RK.01.082** Valve Plate Kit

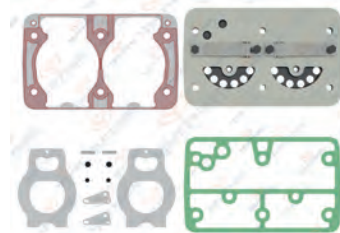

**RK.01.083.13** Repair Kit

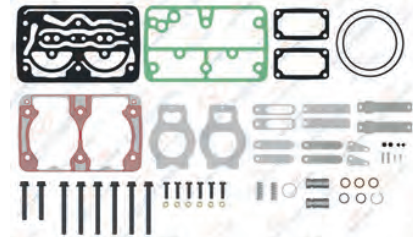

**RK.01.083.07** Repair Kit

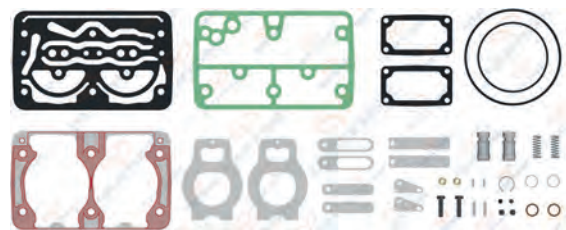

**01.829** Cylinder Head



8 680437 027249

**01.1515** Crankshaft Flange



8 680437 080039

**01.1579** Crankshaft



M20X1.5 Right Hand



8 680437 109624

**RK.01.082.02** Valve Plate Kit



OEM No : 3097146  
Knorr No : SEB01033004

**RK.01.807** Connecting Rod & Piston



STD.



8 680437 114598

**01.226** Connecting Rod



OEM No : 3097151  
Knorr No : SEB00967004

**RK.01.034.00** Piston&Ring (Ø88,00 mm)

- RK.01.034.10 88,25 mm
- RK.01.034.20 88,50 mm
- RK.01.034.30 88,75 mm
- RK.01.034.40 89,00 mm



2,50x2,50x4,00



OEM No : 85101375-3095841-1698848  
Knorr No : I81169004

**01.110.00** Piston (Ø88,00 mm)

- 01.110.10 88,25 mm
- 01.110.20 88,50 mm
- 01.110.30 88,75 mm
- 01.110.40 89,00 mm



2,50x2,50x4,00



8 680437 015994

**01.136.00** Ring (Ø88,00 mm)

- 01.136.10 88,25 mm
- 01.136.20 88,50 mm
- 01.136.30 88,75 mm
- 01.136.40 89,00 mm



2,50x2,50x4,00



8 680437 018384

**01.414** Cover



8 680437 022312

**01.292** Bushing



42X38X25



8 680437 073871

**01.144** Nut



M20X1.5 Right Hand



OEM No : 1698672

**RK.01.126** Repair Kit



OEM No : 3097147  
Knorr No : I1159920063

**RK.01.083.21** Repair Kit

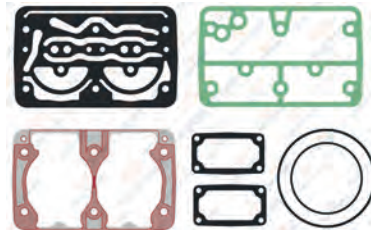

Knorr No : SEB22561

**RK.01.088.20** Repair Kit



OEM No : 3091739  
Knorr No : I1326840061



## Twin Cylinder Compressor Ø88 mm-600 CC-Stroke 50 mm

Application - Vehicle  
VOLVO B10M / B10L / B10B / BUS B10L  
/ B10LA



**01.04.045**

Oem. No.  
70330096

Knorr. No.  
LK4922  
K002030V



**01.792** Crankcase



**RK.01.133.20** Repair Kit



**RK.01.133** Repair Kit

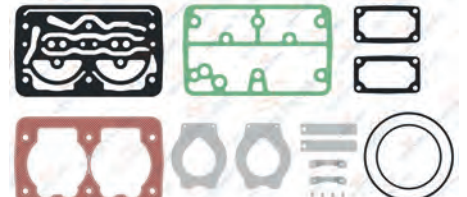

**RK.01.326**

Complete Cylinder Head



**RK.01.326.20**

Complete Cylinder Head

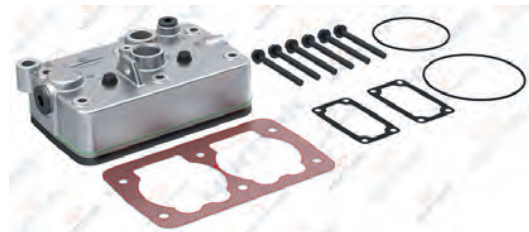

**RK.01.197.21**

Valve Plate Kit

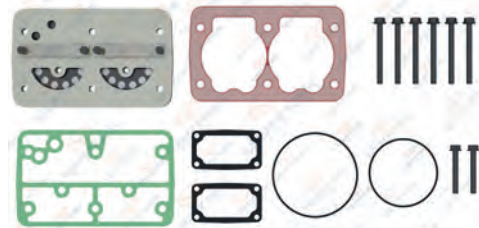

**RK.01.197**

Valve Plate Kit



**RK.01.133.01**

Repair Kit

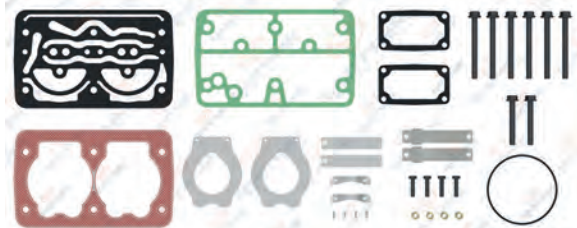

**01.817** Cylinder Head

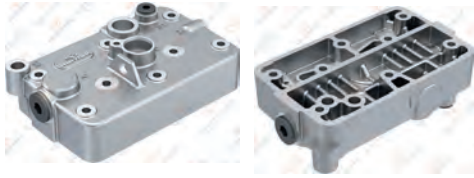

**01.288** Crankshaft Flange



OEM No : 3097150  
Knorr No : II159920065

**01.227** Crankshaft



M20X1.5 Right Hand



**RK.01.197.01** Valve Plate Kit



OEM No : 3095845  
Knorr No : SEB01034004

**RK.01.807** Connecting Rod & Piston



STD.



**01.226** Connecting Rod



OEM No : 3097151  
Knorr No : SEB00967004

**RK.01.034.00** Piston&Ring (Ø88,00 mm)

- RK.01.034.10 88,25 mm
- RK.01.034.20 88,50 mm
- RK.01.034.30 88,75 mm
- RK.01.034.40 89,00 mm



2,50x2,50x4,00



OEM No : 85101375-3095841-1698848  
Knorr No : I81169004

**01.110.00** Piston (Ø88,00 mm)

- 01.110.10 88,25 mm
- 01.110.20 88,50 mm
- 01.110.30 88,75 mm
- 01.110.40 89,00 mm



2,50x2,50x4,00



**01.136.00** Ring (Ø88,00 mm)

- 01.136.10 88,25 mm
- 01.136.20 88,50 mm
- 01.136.30 88,75 mm
- 01.136.40 89,00 mm



2,50x2,50x4,00



**01.414** Cover



**01.292** Bushing



42X38X25



**01.144** Nut



M20X1.5 Right Hand



OEM No : 1698672

**RK.01.133.22** Repair Kit

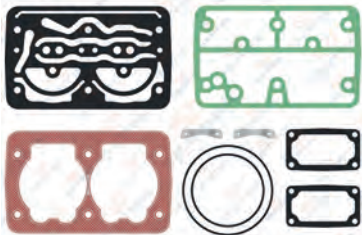

**RK.01.133.23** Repair Kit



## Twin Cylinder Compressor 600 CC

Application - Vehicle  
VOLVO BUS B12M



**01.04.106**

Knorr. No.  
LK4920  
K002032000



**01.873.10**

Crankcase



**RK.01.133.01**

Repair Kit



**RK.01.133.20**

Repair Kit



**RK.01.310**

Complete Cylinder Head

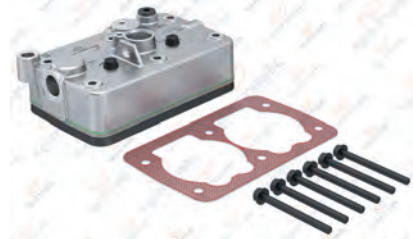

Knorr No : K040594K50

**RK.01.310.20**

Complete Cylinder Head

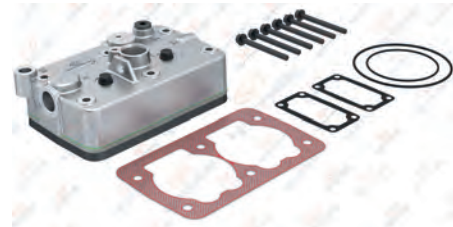

**RK.01.197.03**

Valve Plate Kit

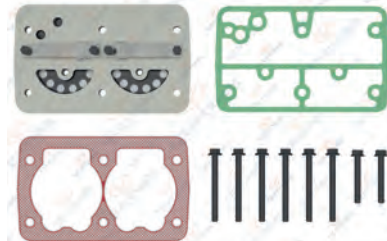

Knorr No : K070844K50

**RK.01.197**

Valve Plate Kit



**RK.01.133.02**

Repair Kit

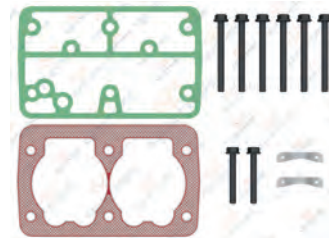

OEM No : 3095840

Knorr No : I1344040051



**RK.01.310.01** Complete Cylinder Head

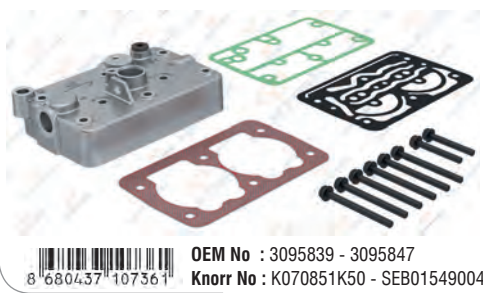

8 680437 107361  
 OEM No : 3095839 - 3095847  
 Knorr No : K070851K50 - SEB01549004

**01.816** Cylinder Head



8 680437 027003

**01.647** Crankshaft



M20X1.5 Right Hand  
 8 680437 025139

**RK.01.197.01** Valve Plate Kit

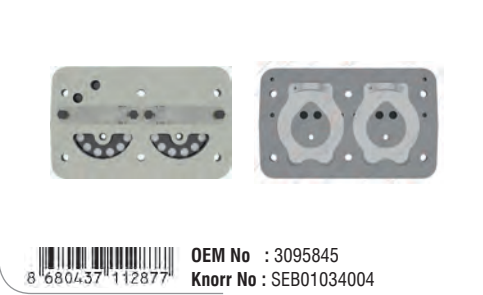

8 680437 112877  
 OEM No : 3095845  
 Knorr No : SEB01034004

**01.288** Crankshaft Flange



8 680437 020615  
 OEM No : 3097150  
 Knorr No : II159920065

**01.226** Connecting Rod



8 680437 019824  
 OEM No : 3097151  
 Knorr No : SEB00967004

**RK.01.034.00** Piston&Ring (Ø88,00 mm)

- RK.01.034.10 88,25 mm
- RK.01.034.20 88,50 mm
- RK.01.034.30 88,75 mm
- RK.01.034.40 89,00 mm



2,50x2,50x4,00  
 8 680437 058816  
 OEM No : 85101375-3095841-1698848  
 Knorr No : I81169004

**01.110.00** Piston (Ø88,00 mm)

- 01.110.10 88,25 mm
- 01.110.20 88,50 mm
- 01.110.30 88,75 mm
- 01.110.40 89,00 mm



2,50x2,50x4,00  
 8 680437 015994

**01.136.00** Ring (Ø88,00 mm)

- 01.136.10 88,25 mm
- 01.136.20 88,50 mm
- 01.136.30 88,75 mm
- 01.136.40 89,00 mm



2,50x2,50x4,00  
 8 680437 018384

**01.414** Cover



8 680437 022312

**01.292** Bushing



42X38X25  
 8 680437 073871

**01.144** Nut



M20X1.5 Right Hand  
 OEM No : 1698672  
 8 680437 018742

**RK.01.133.05** Repair Kit

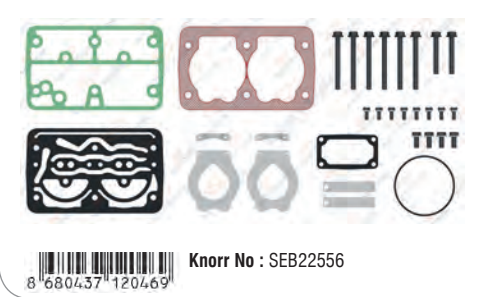

8 680437 120469  
 Knorr No : SEB22556

**RK.01.133.23** Repair Kit



8 680437 073789

**01.1487** Gear



8 680437 076414  
 OEM No : 1549425

**RK.01.133** Repair Kit

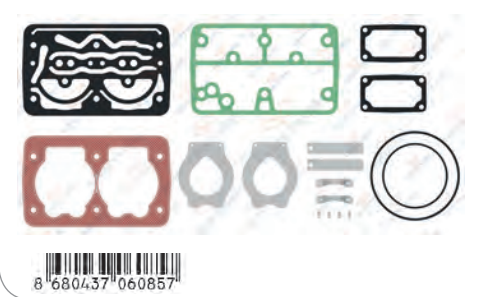

8 680437 060857

## Twin Cylinder Compressor Ø75 mm-440 CC-Stroke 50 mm

Application - Vehicle  
VOLVO FL10 / F12 / FL6 / FL7 / F10



**01.05.013**

Oem. No.  
1599999  
5003217

Knorr. No.  
LP4812  
I86909000

**01.05.013.10**

With Gear



**01.221**

Crankcase



**RK.01.078.20**

Repair Kit

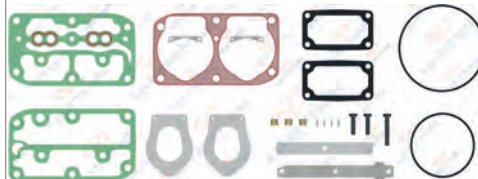

**RK.01.007** Complete Cylinder Head



**RK.01.007.22**

Complete Cylinder Head

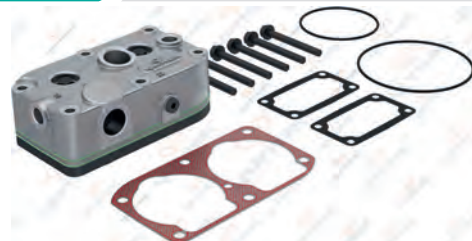

**RK.01.076.03**

Valve Plate Kit

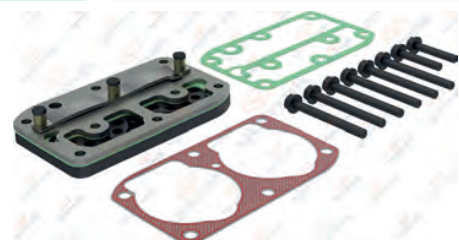

Knorr No : K070838K50

**RK.01.076**

Valve Plate Kit

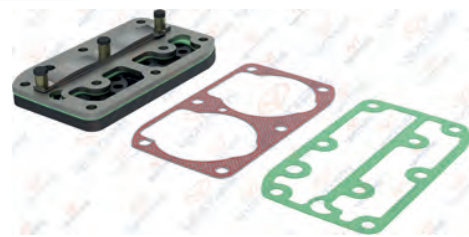

**RK.01.078.01**

Repair Kit

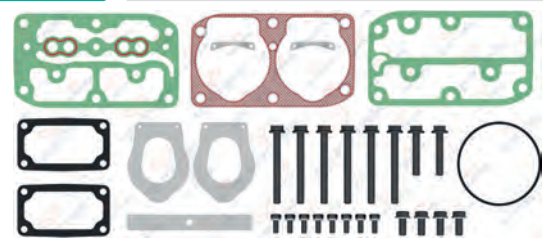

Knorr No : SEB22541

**RK.01.078**

Repair Kit

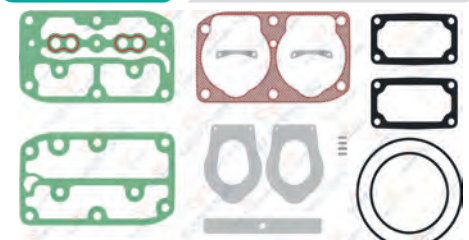



**RK.01.007.01** Complete Cylinder Head



Knorr No : K070840K50 - SEB00421004  
 8 680437 106036

**01.217** Cylinder Head

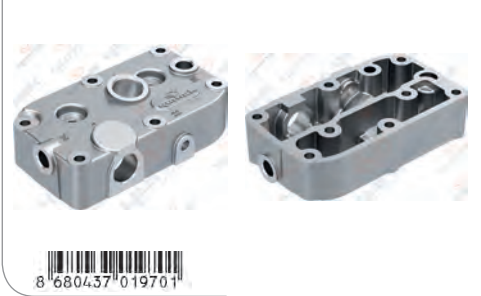

8 680437 019701

**01.219** Crankshaft



M20X1.5 Right Hand  
 OEM No : 1697285  
 Knorr No : EB007622V  
 8 680437 019732

**RK.01.076.02** Valve Plate Kit



OEM No : 1697770  
 Knorr No : I81015004  
 8 680437 112730

**01.220** Crankshaft Flange



OEM No : 3090385 - 1697769  
 Knorr No : SEB00387004  
 8 680437 019756

**01.218** Connecting Rod



OEM No : 1697281 - 1698528 - 3090386  
 Knorr No : SEB00626004 - SEB00957004  
 8 680437 019725

**RK.01.073.00** Piston&Ring (Ø75,00 mm)

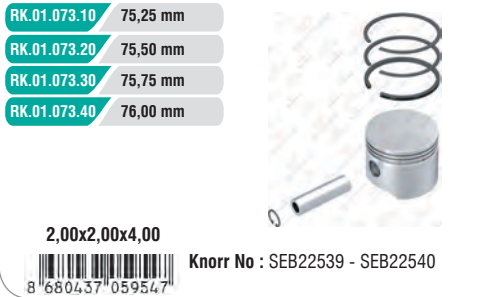

- RK.01.073.10 75,25 mm
- RK.01.073.20 75,50 mm
- RK.01.073.30 75,75 mm
- RK.01.073.40 76,00 mm

2,00x2,00x4,00  
 Knorr No : SEB22539 - SEB22540  
 8 680437 059547

**01.193.00** Piston (Ø75,00 mm)



- 01.193.10 75,25 mm
- 01.193.20 75,50 mm
- 01.193.30 75,75 mm
- 01.193.40 76,00 mm

2,00x2,00x4,00  
 8 680437 019336

**01.134.00** Ring (Ø75,00 mm)

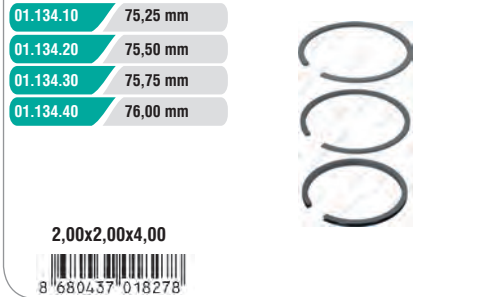

- 01.134.10 75,25 mm
- 01.134.20 75,50 mm
- 01.134.30 75,75 mm
- 01.134.40 76,00 mm

2,00x2,00x4,00  
 8 680437 018278

**01.144** Nut



M20X1.5 Right Hand  
 OEM No : 1698672  
 8 680437 018742

**01.292** Bushing



42X38X25  
 8 680437 073871

**01.1409** Gear



Noth (Tooth) Pcs : 33  
 OEM No : 478777 - 470775  
 8 680437 072539

**RK.01.078.24** Repair Kit

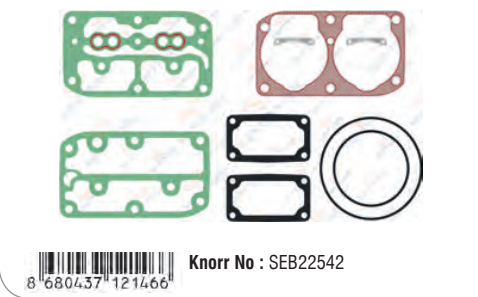

Knorr No : SEB22542  
 8 680437 121466

**RK.01.078.04** Repair Kit

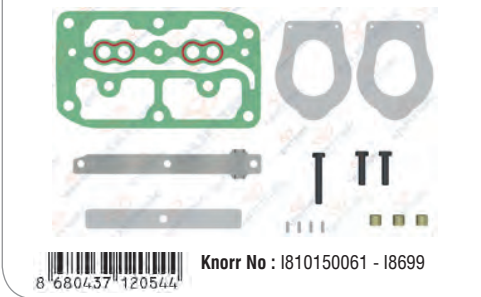

Knorr No : I810150061 - I8699  
 8 680437 120544

**RK.01.057** Repair Kit



8 680437 059172



## Twin Cylinder Compressor Ø75 mm-440 CC-Stroke 50 mm

**Application - Vehicle**  
VOLVO F10 / F12 / F16 / F7 /  
FH12 / FH16 / FL7 / FL10 / FS7 /  
B6 / B7R / B10B / B12 / F16



**01.05.016**

Oem. No.	Knorr No.
1613632	LP4813
5003336	I90499000



**01.221** Crankcase



**RK.01.078.20** Repair Kit

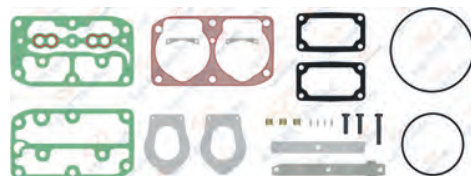

**RK.01.261** Complete Cylinder Head



**RK.01.261.20** Complete Cylinder Head

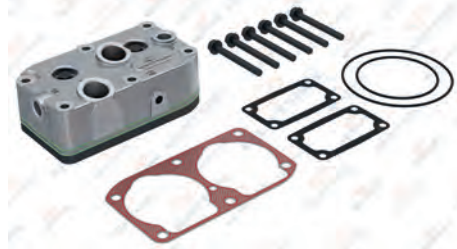

**RK.01.076.03** Valve Plate Kit

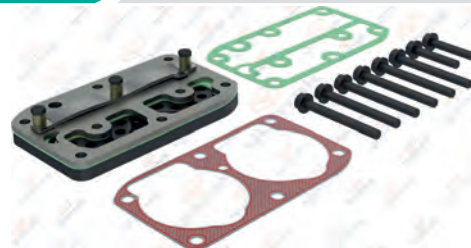

Knorr No : K070838K50

**RK.01.076** Valve Plate Kit

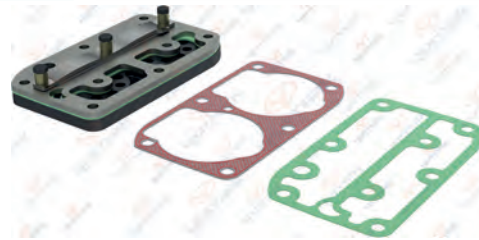

**RK.01.078.01** Repair Kit

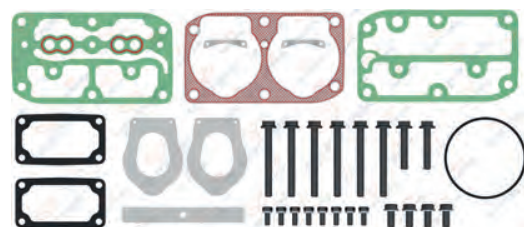

Knorr No : SEB22541

**RK.01.078** Repair Kit

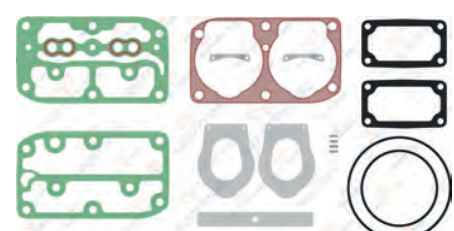

**RK.01.261.01** Complete Cylinder Head



Knorr No : K070841K50  
8 680437 100548

**01.781** Cylinder Head



8 680437 026600

**01.219** Crankshaft



M20X1.5 Right Hand  
OEM No : 1697285  
Knorr No : EB007622V  
8 680437 019732

**RK.01.076.02** Valve Plate Kit



OEM No : 1697770  
Knorr No : I81015004  
8 680437 112730

**01.220** Crankshaft Flange



OEM No : 3090385 - 1697769  
Knorr No : SEB00387004  
8 680437 019756

**01.218** Connecting Rod



OEM No : 1697281 - 1698528 - 3090386  
Knorr No : SEB00626004 - SEB00957004  
8 680437 019725

**RK.01.073.00** Piston&Ring (Ø75,00 mm)

- RK.01.073.10 75,25 mm
- RK.01.073.20 75,50 mm
- RK.01.073.30 75,75 mm
- RK.01.073.40 76,00 mm



2,00x2,00x4,00  
Knorr No:SEB22539 - SEB22540  
8 680437 059547

**01.193.00** Piston (Ø75,00 mm)

- 01.193.10 75,25 mm
- 01.193.20 75,50 mm
- 01.193.30 75,75 mm
- 01.193.40 76,00 mm



2,00x2,00x4,00  
8 680437 019336

**01.134.00** Ring (Ø75,00 mm)

- 01.134.10 75,25 mm
- 01.134.20 75,50 mm
- 01.134.30 75,75 mm
- 01.134.40 76,00 mm



2,00x2,00x4,00  
8 680437 018278

**01.144** Nut



M20X1.5 Right Hand  
OEM No : 1698672  
8 680437 018742

**01.292** Bushing



42X38X25  
8 680437 073871

**01.1409** Gear



Noth (Tooth) Pcs : 33  
OEM No : 478777 - 470775  
8 680437 072539

**RK.01.078.24** Repair Kit

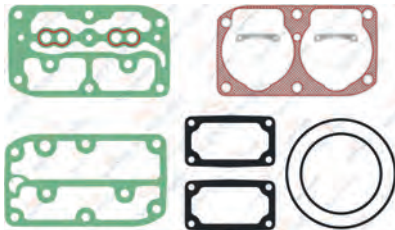

Knorr No : SEB22542  
8 680437 121466

**RK.01.078.04** Repair Kit

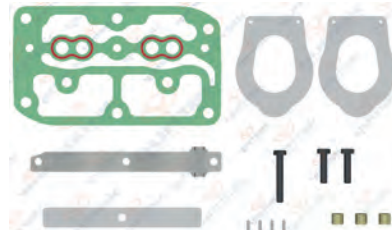

Knorr No : I810150061 - I8699  
8 680437 120544

**RK.01.057** Repair Kit



8 680437 059172



## Twin Cylinder Compressor Ø75 mm-440 CC-Stroke 50 mm

Application - Vehicle  
VOLVO F17 / FL10 / FL12 / F16 / N10



**01.05.014**

Oem. No.	Knorr No.
8150407	LP4825
8112427	II15993000
81124273	

**01.05.014.10**



**01.224** Crankcase



**RK.01.080** Repair Kit

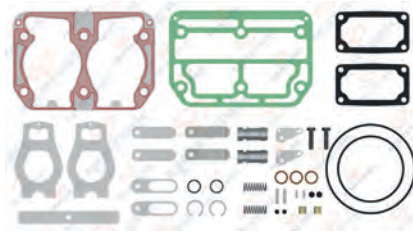

**RK.01.080.03** Repair Kit

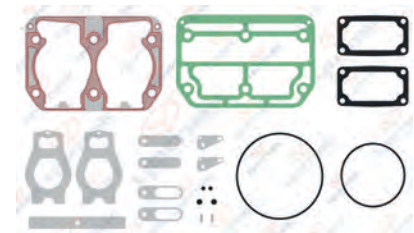

**RK.01.281** Complete Cylinder Head



**RK.01.281.20** Complete Cylinder Head

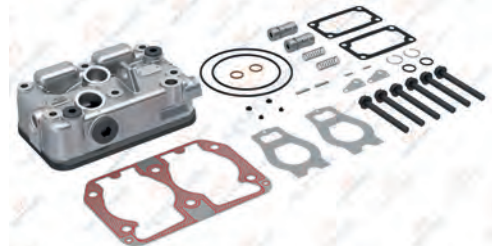

**RK.01.079.01** Valve Plate Kit



Knorr No : K070848K50

**RK.01.079** Valve Plate Kit

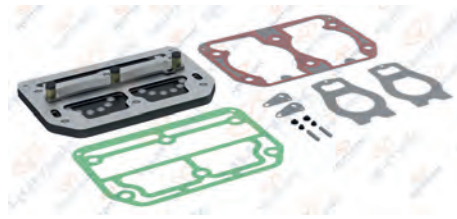

**RK.01.080.01** Repair Kit

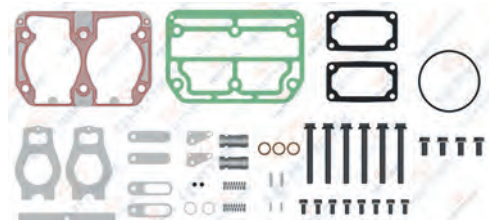

Knorr No : SEB22545



**RK.01.281.01** Complete Cylinder Head

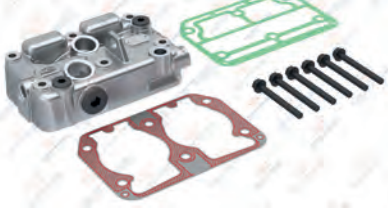

8 680437 082156

**01.222** Cylinder Head



8 680437 019770

**01.219** Crankshaft



M20X1.5 Right Hand



8 680437 019732

OEM No : 1697285  
Knorr No : EB007622V

**RK.01.079.02** Valve Plate



8 680437 112785

**01.220** Crankshaft Flange



8 680437 019756

OEM No : 3090385 - 1697769  
Knorr No : SEB00387004

**01.218** Connecting Rod



8 680437 019725

OEM No : 1697281 - 1698528 - 3090386  
Knorr No : SEB00626004 - SEB00957004

**RK.01.073.00** Piston&Ring (Ø75,00 mm)

- RK.01.073.10 75,25 mm
- RK.01.073.20 75,50 mm
- RK.01.073.30 75,75 mm
- RK.01.073.40 76,00 mm



2,00x2,00x4,00



8 680437 059547

Knorr No:SEB22539 - SEB22540

**01.193.00** Piston (Ø75,00 mm)

- 01.193.10 75,25 mm
- 01.193.20 75,50 mm
- 01.193.30 75,75 mm
- 01.193.40 76,00 mm



2,00x2,00x4,00



8 680437 019336

**01.134.00** Ring (Ø75,00 mm)

- 01.134.10 75,25 mm
- 01.134.20 75,50 mm
- 01.134.30 75,75 mm
- 01.134.40 76,00 mm



2,00x2,00x4,00



8 680437 018278

**01.144** Nut



M20X1.5 Right Hand



8 680437 018742

OEM No : 1698672

**01.292** Bushing



42X38X25



8 680437 073871

**01.1409** Gear



Noth (Tooth) Pcs : 33



8 680437 072539

OEM No : 478777 - 470775

**RK.01.126** Repair Kit



8 680437 060642

OEM No : 3097147  
Knorr No : II159920063

**RK.01.055** Repair Kit



8 680437 059134

**RK.01.055.01** Repair Kit



8 680437 124160

## Twin Cylinder Compressor Ø75 mm-440 CC-Stroke 50 mm

Application - Vehicle  
VOLVO M10



**01.05.028**

Oem. No.  
8129779  
8113270

Knorr. No.  
LP4850  
II35564000



**01.762**

Crankcase



**RK.01.135.22**

Repair Kit

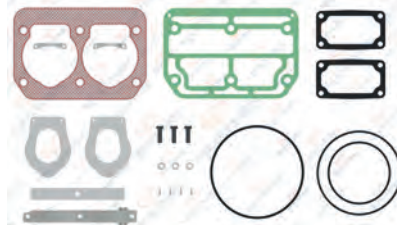

**RK.01.135**

Repair Kit

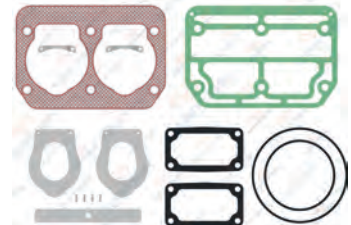

**RK.01.257.10**

Complete Cylinder Head



**RK.01.257.20**

Complete Cylinder Head



**RK.01.258.01**

Valve Plate Kit

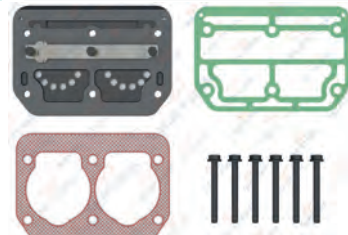

Knorr No : K070842K50

**RK.01.258**

Valve Plate Kit



Knorr No : SEB01000004

**RK.01.135.01**

Repair Kit

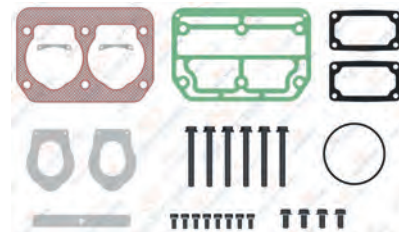

Knorr No : SEB22543

**RK.01.257.01** Complete Cylinder Head

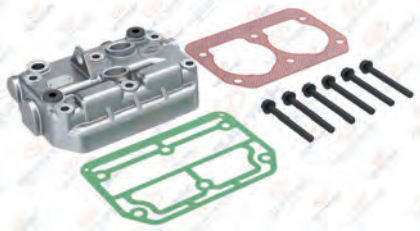

8 680437 102632

**RK.01.258.02** Valve Plate



8 680437 112778

**RK.01.073.00** Piston&Ring (Ø75,00 mm)

- RK.01.073.10** 75,25 mm
- RK.01.073.20** 75,50 mm
- RK.01.073.30** 75,75 mm
- RK.01.073.40** 76,00 mm



2,00x2,00x4,00



Knorr No:SEB22539 - SEB22540

**01.222.10** Cylinder Head

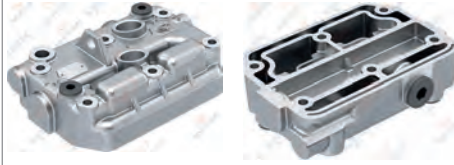

8 680437 127765

**01.220** Crankshaft Flange



8 680437 019756

OEM No : 3090385 - 1697769  
Knorr No : SEB00387004

**01.193.00** Piston (Ø75,00 mm)

- 01.193.10** 75,25 mm
- 01.193.20** 75,50 mm
- 01.193.30** 75,75 mm
- 01.193.40** 76,00 mm



2,00x2,00x4,00



8 680437 019336

**01.219** Crankshaft



M20X1.5 Right Hand



8 680437 019732

OEM No : 1697285  
Knorr No : EB007622V

**01.218** Connecting Rod



8 680437 019725

OEM No : 1697281 - 1698528 - 3090386  
Knorr No : SEB00626004 - SEB00957004

**01.134.00** Ring (Ø75,00 mm)

- 01.134.10** 75,25 mm
- 01.134.20** 75,50 mm
- 01.134.30** 75,75 mm
- 01.134.40** 76,00 mm



2,00x2,00x4,00



8 680437 018278

**01.414** Cover



8 680437 018742

**01.292** Bushing



42X38X25



8 680437 073871

**01.1409** Gear



Noth (Tooth) Pcs : 33



8 680437 072539

OEM No : 478777 - 470775

**RK.01.135.03** Repair Kit



8 680437 120568

Knorr No : II156970051

**RK.01.057** Repair Kit



8 680437 059172

**01.144** Nut



M20X1.5 Right Hand



8 680437 018742

OEM No : 1698672



## Single Cylinder Compressor Ø88 mm-225 CC-Stroke 37 mm

Application - Vehicle  
VOLVO FL6 / FL608 / FL616 /  
FS7 / FH12 / FL12



**01.04.008**

Oem. No.  
6795600

Knorr. No.  
LK3813  
I94314



**01.085**

Crankcase

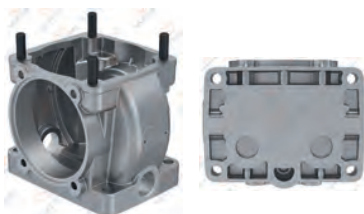

**RK.01.142.05**

Repair Kit

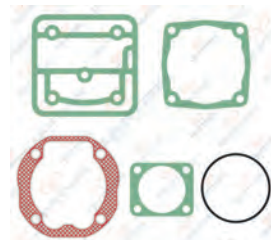

**RK.01.343** Complete Cylinder Head



Knorr No : K021494K50 - I943140051

**RK.01.344.20**

Valve Plate Kit

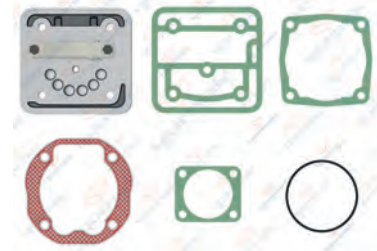

**RK.01.344**

Valve Plate Kit



**RK.01.142.03**

Repair Kit

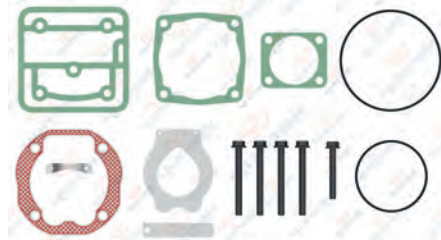

**RK.01.142.02**

Repair Kit

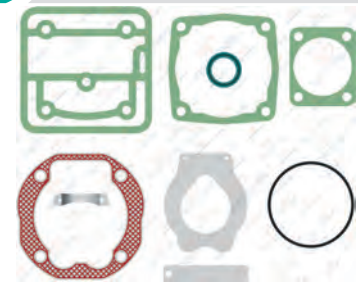

**RK.01.408**

Repair Kit



**01.962** Cylinder Head



8 680437 028956

**01.287** Crankshaft Flange



8 680437 020592

**01.365** Crankshaft



M20X1.5 Right Hand



8 680437 021667

**01.959** Valve Plate



8 680437 028901

**01.073** Cover



8 680437 014133

**01.003** Connecting Rod



8 680437 009672

OEM No : 1698852 - 3099752 - 1699828

**RK.01.034.00** Piston&Ring (Ø88,00 mm)

- RK.01.034.10 88,25 mm
- RK.01.034.20 88,50 mm
- RK.01.034.30 88,75 mm
- RK.01.034.40 89,00 mm



2.50x2,50x4,00



8 680437 058816

OEM No : 85101375-3095841-1698848  
Knorr No : I81169004

**01.110.00** Piston (Ø88,00 mm)

- 01.110.10 88,25 mm
- 01.110.20 88,50 mm
- 01.110.30 88,75 mm
- 01.110.40 89,00 mm



2.50x2,50x4,00



8 680437 015994

**01.136.00** Ring (Ø88,00 mm)

- 01.136.10 88,25 mm
- 01.136.20 88,50 mm
- 01.136.30 88,75 mm
- 01.136.40 89,00 mm



2.50x2,50x4,00



8 680437 018384

**RK.01.039** Cylinder Liner Set



8 680437 058939

**01.184** Cylinder Liner



8 680437 019145

**RK.01.039.01** Cylinder Liner Set

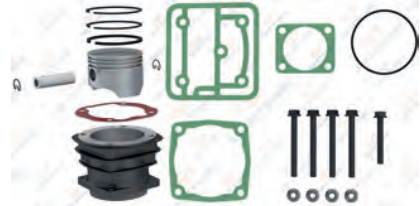

8 680437 093244

Knorr No : K021516K50

**01.195** Bushing



34X30X16



8 680437 019411

**01.013** Bushing



34X30X16



8 680437 009993

**01.144** Nut



M20X1.5 Right Hand



8 680437 018742

OEM No : 1698672

## Single Cylinder Compressor Ø88 mm-225 CC-Stroke 37 mm

Application - Vehicle  
VOLVO F5 / FL608 / FK616 / FS7



**01.04.015**

Oem. No.  
5003219  
6772239

Knorr. No.  
LK3802  
I85028



8 680437 010883



**01.085**

Crankcase

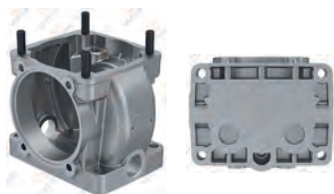

8 680437 014331

**RK.01.408**

Repair Kit



8 680437 064916

**RK.01.068**

Complete Cylinder Head



8 680437 059493

Knorr No : ZB4275 - I88057

**RK.01.035**

Valve Plate Kit



8 680437 058878

**RK.01.148.07**

Repair Kit

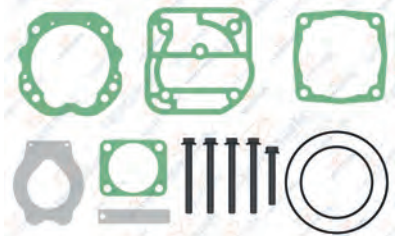

8 680437 120230

**RK.01.148.09**

Repair Kit

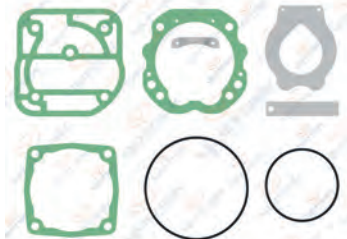

8 680437 120247

**RK.01.148.08**

Repair Kit



8 680437 120216



**01.076** Cylinder Head



8 680437 014164

**01.287** Crankshaft Flange



8 680437 020592

**01.365** Crankshaft



M20X1.5 Right Hand



8 680437 021667

**01.139** Valve Plate



8 680437 018537

**01.073** Cover



8 680437 014133

**01.003** Connecting Rod



8 680437 009672

OEM No : 1698852 - 3099752 - 1699828

**RK.01.034.00** Piston&Ring (Ø88,00 mm)

- RK.01.034.10 88,25 mm
- RK.01.034.20 88,50 mm
- RK.01.034.30 88,75 mm
- RK.01.034.40 89,00 mm



2.50x2,50x4,00



8 680437 058816

OEM No : 85101375-3095841-1698848  
Knorr No : I81169004

**01.110.00** Piston (Ø88,00 mm)

- 01.110.10 88,25 mm
- 01.110.20 88,50 mm
- 01.110.30 88,75 mm
- 01.110.40 89,00 mm



2.50x2,50x4,00



8 680437 015994

**01.136.00** Ring (Ø88,00 mm)

- 01.136.10 88,25 mm
- 01.136.20 88,50 mm
- 01.136.30 88,75 mm
- 01.136.40 89,00 mm



2.50x2,50x4,00



8 680437 018384

**RK.01.039** Cylinder Liner Set



8 680437 058939

**01.184** Cylinder Liner



8 680437 019145

**RK.01.039.01** Cylinder Liner Set

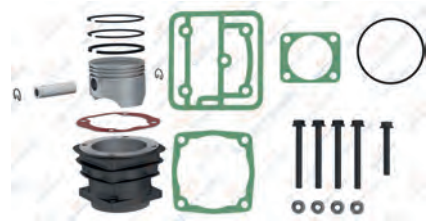

8 680437 093244

Knorr No : K021516K50

**01.195** Bushing



34X30X16



8 680437 019411

**01.013** Bushing



34X30X16



8 680437 009993

**01.144** Nut



M20X1.5 Right Hand



8 680437 018742

OEM No : 1698672

## Single Cylinder Compressor Ø88 mm-300 CC-Stroke 50 mm

Application - Vehicle  
VOLVO FH12 / FH16 / F16



### 01.04.019

Oem. No.	Knorr No.
20429337	LK3930
1628592	II18606000
85000063	LK3982
8113263	K000274000
8112583	
3987601	



8 680437 010920



### 01.309

Crankcase



8 680437 020875

### RK.01.115.03

Repair Kit

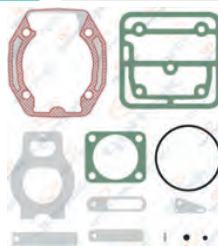

8 680437 080770

Complete Cylinder Head



8 680437 065890

### RK.01.497.20

Complete Cylinder Head



8 680437 105749

### RK.01.113.01

Valve Plate Kit

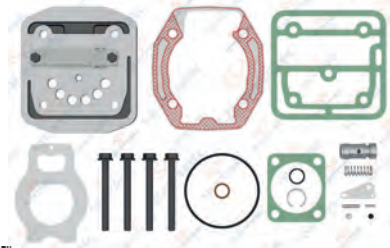

8 680437 081005

### RK.01.115.01

Repair Kit

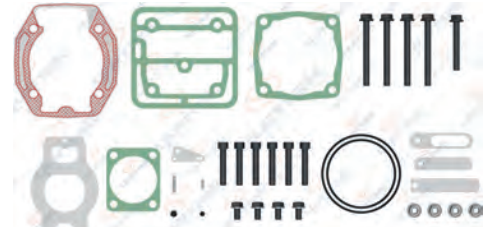

8 680437 060451

Knorr No : K110174K50

### RK.01.115

Repair Kit

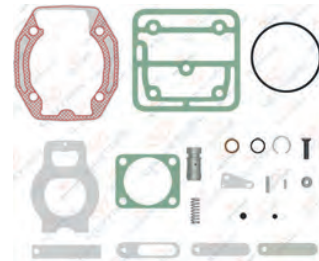

8 680437 060444

### RK.01.029

Repair Kit



8 680437 058700

**01.995** Cylinder Head



8 680437 029405

**01.890** Crankshaft Flange



8 680437 028031

**01.980** Crankshaft



M20X1.5 Right Hand



8 680437 029250

**01.355** Valve Plate



8 680437 021476

Knorr No : II1477004

**01.073** Cover



8 680437 014133

**01.003** Connecting Rod



8 680437 009672

OEM No : 1698852 - 3099752 - 1699828

**RK.01.034.00** Piston&Ring (Ø88,00 mm)

- RK.01.034.10 88,25 mm
- RK.01.034.20 88,50 mm
- RK.01.034.30 88,75 mm
- RK.01.034.40 89,00 mm



2.50x2,50x4,00



8 680437 058816

OEM No : 85101375-3095841-1698848  
Knorr No : I81169004

**01.110.00** Piston (Ø88,00 mm)

- 01.110.10 88,25 mm
- 01.110.20 88,50 mm
- 01.110.30 88,75 mm
- 01.110.40 89,00 mm



2.50x2,50x4,00



8 680437 015994

**01.136.00** Ring (Ø88,00 mm)

- 01.136.10 88,25 mm
- 01.136.20 88,50 mm
- 01.136.30 88,75 mm
- 01.136.40 89,00 mm



2.50x2,50x4,00



8 680437 018384

**RK.01.114** Cylinder Liner Set



8 680437 060437

Knorr No : K000998

**01.305** Cylinder Liner



8 680437 020806

**01.144** Nut



M20X1.5 Right Hand



8 680437 018742

OEM No : 1698672

**01.014** Bushing



34X30X20.5



8 680437 010005

**01.013** Bushing



34X30X16



8 680437 009993



## Single Cylinder Compressor Ø88 mm-300 CC-Stroke 50 mm

Application - Vehicle  
VOLVO FH12 / FH16 / F16



### 01.04.053

Oem. No.	Knorr No.
8113406	LK3986
8122459	K000275000
20429341	
85000067	



### 01.309

Crankcase



### RK.01.408

Repair Kit



### RK.01.497.10

Complete Cylinder Head



Knorr No : K021507K50

### RK.01.749

Valve Plate Kit



### RK.01.750

Repair Kit

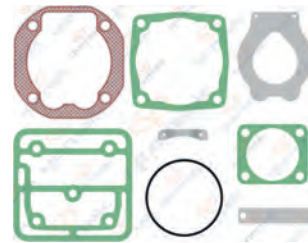

### RK.01.750.01

Repair Kit

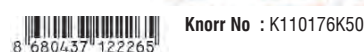
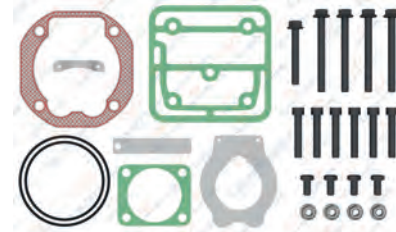

Knorr No : K110176K50

### RK.01.323

Repair Kit

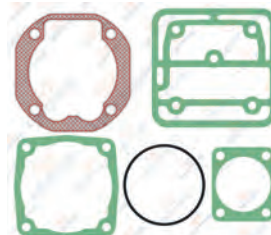

**01.995.10** Cylinder Head



8 680437 101666

**01.890** Crankshaft Flange



8 680437 028031

**01.980** Crankshaft



M20X1.5 Right Hand



8 680437 029250

**01.355.10** Valve Plate



8 680437 113966

**01.073** Cover



8 680437 014133

**01.003** Connecting Rod



8 680437 009672

OEM No : 1698852 - 3099752 - 1699828

**RK.01.034.00** Piston&Ring (Ø88,00 mm)

- RK.01.034.10 88,25 mm
- RK.01.034.20 88,50 mm
- RK.01.034.30 88,75 mm
- RK.01.034.40 89,00 mm



2.50x2,50x4,00



8 680437 058816

OEM No : 85101375-3095841-1698848  
Knorr No : I81169004

**01.110.00** Piston (Ø88,00 mm)

- 01.110.10 88,25 mm
- 01.110.20 88,50 mm
- 01.110.30 88,75 mm
- 01.110.40 89,00 mm



2.50x2,50x4,00



8 680437 015994

**01.136.00** Ring (Ø88,00 mm)

- 01.136.10 88,25 mm
- 01.136.20 88,50 mm
- 01.136.30 88,75 mm
- 01.136.40 89,00 mm



2.50x2,50x4,00



8 680437 018384

**RK.01.032** Cylinder Liner Set



8 680437 058779

Knorr No : I789790061 - 81541056009

**01.057** Cylinder Liner



8 680437 013181

**RK.01.032.01** Cylinder Liner Set



8 680437 093282

Knorr No : K035133K50

**01.014** Bushing



34X30X20.5



8 680437 010005

**01.013** Bushing



34X30X16



8 680437 009993

**01.144** Nut



M20X1.5 Right Hand



8 680437 018742

OEM No : 1698672

# Single Cylinder Compressor Ø88 mm-300 CC-Stroke 50 mm

Application - Vehicle  
VOLVO



**01.04.089**

Knorr No.  
LK3940  
II15995



8 680437 011620



**01.309** Crankcase



8 680437 020875

**RK.01.115.03** Repair Kit

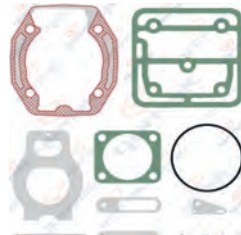

8 680437 080770

**RK.01.497** Complete Cylinder Head



8 680437 065890

**RK.01.497.20** Complete Cylinder Head



8 680437 105749

**RK.01.113.01** Valve Plate Kit

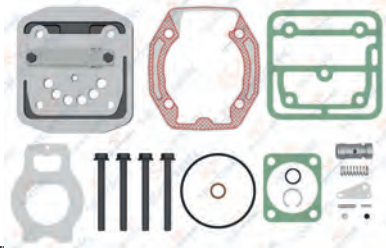

8 680437 081005

**RK.01.115.01** Repair Kit

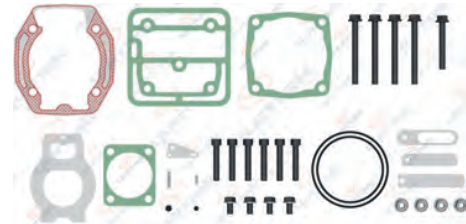

8 680437 060451

Knorr No : K110174K50

**RK.01.115** Repair Kit

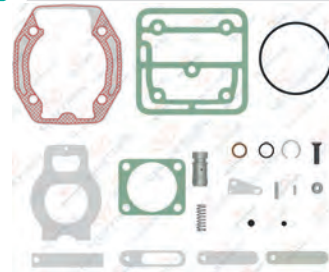

8 680437 060444

**RK.01.029** Repair Kit



8 680437 058700



**01.995** Cylinder Head



8 680437 029405

**01.948** Crankshaft Flange



8 680437 028734

**01.980** Crankshaft



M20X1.5 Right Hand



8 680437 029250

**01.355** Valve Plate



8 680437 021476

Knorr No : II14777004

**01.073** Cover



8 680437 014133

**01.003** Connecting Rod



8 680437 009672

OEM No : 1698852 - 3099752 - 1699828

**RK.01.034.00** Piston&Ring (Ø88,00 mm)

- RK.01.034.10 88,25 mm
- RK.01.034.20 88,50 mm
- RK.01.034.30 88,75 mm
- RK.01.034.40 89,00 mm



2.50x2,50x4,00



8 680437 058816

OEM No : 85101375-3095841-1698848  
Knorr No : I81169004

**01.110.00** Piston (Ø88,00 mm)

- 01.110.10 88,25 mm
- 01.110.20 88,50 mm
- 01.110.30 88,75 mm
- 01.110.40 89,00 mm



2.50x2,50x4,00



8 680437 015994

**01.136.00** Ring (Ø88,00 mm)

- 01.136.10 88,25 mm
- 01.136.20 88,50 mm
- 01.136.30 88,75 mm
- 01.136.40 89,00 mm



2.50x2,50x4,00



8 680437 018384

**RK.01.114** Cylinder Liner Set



8 680437 060437

Knorr No : K000998

**01.305** Cylinder Liner



8 680437 020806

**01.144** Nut



M20X1.5 Right Hand



8 680437 018742

OEM No : 1698672

**01.014** Bushing



34X30X20.5



8 680437 010005

**01.013** Bushing



34X30X16



8 680437 009993

# Single Cylinder Compressor Ø92 mm-360 CC-Stroke 54 mm

Application - Vehicle  
VOLVO

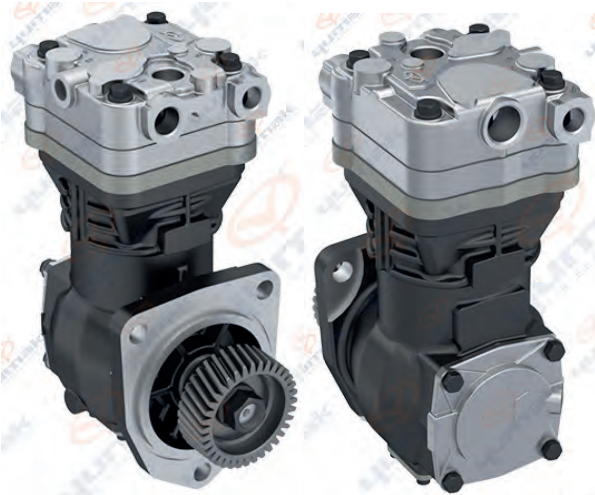

**01.04.129**

Oem. No.  
20568594  
85000345

Knorr No.  
LP3970  
K004641000



**01.1615** Crankcase



**RK.01.395.06** Repair Kit

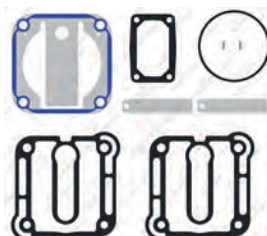

Knorr No : SEB22532

**RK.01.275** Repair Kit

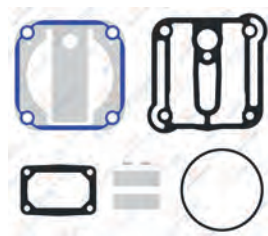

**RK.01.644.20**

Complete Cylinder Head



**RK.01.645.02**

Valve Plate Kit



Knorr No : SEB01968K50

**RK.01.645**

Valve Plate Kit

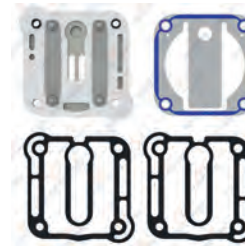

**RK.01.395.01**

Repair Kit

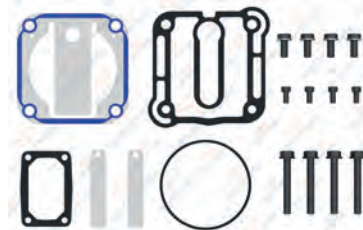

**RK.01.395.03**

Repair Kit

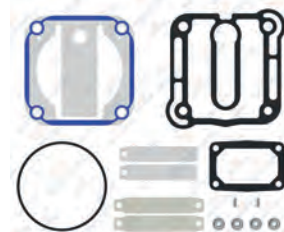

**01.1304.20** Cylinder Head

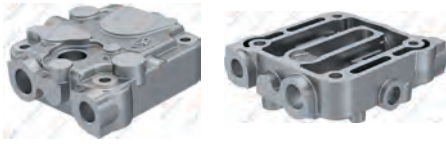

**01.288** Crankshaft Flange



OEM No : 3097150  
Knorr No : II159920065

**01.1614** Crankshaft



M20X1.5 - Right Hand



**01.186** Valve Plate



**01.292** Bushing



42X38X25

**01.218** Connecting Rod



OEM No : 1697281 - 1698528 - 3090386  
Knorr No : SEB00626004 - SEB00957004

**RK.01.318.00** Piston&Ring (Ø92,00 mm)

- RK.01.318.10 92,25 mm
- RK.01.318.20 92,50 mm
- RK.01.318.30 92,75 mm
- RK.01.318.40 93,00 mm



2.50x2,50x4,00



Knorr No : K012079

**01.862.00** Piston (Ø92,00 mm)

- 01.862.10 92,25 mm
- 01.862.20 92,50 mm
- 01.862.30 92,75 mm
- 01.862.40 93,00 mm



2.50x2,50x4,00



**01.942.00** Ring (Ø92,00 mm)

- 01.942.10 92,25 mm
- 01.942.20 92,50 mm
- 01.942.30 92,75 mm
- 01.942.40 93,00 mm



2.50x2,50x4,00



**01.374** Cover



**01.144** Nut



M20X1.5 - Right Hand



OEM No : 1698672

**01.1610** Gear



OEM No : 3169496



## Single Cylinder Compressor Ø88 mm-225 CC-Stroke 37 mm

Application - Vehicle  
VOLVO FM



**01.04.012**

Oem. No.  
3761317401

Knorr No.  
LK3832  
I137219M1



8 680437 010852



**01.085**

Crankcase

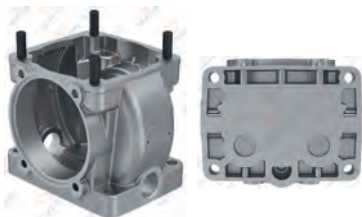

8 680437 014331

**RK.01.068**

Complete Cylinder Head



Knorr No : ZB4275 - I88057

**RK.01.068.01**

Complete Cylinder Head

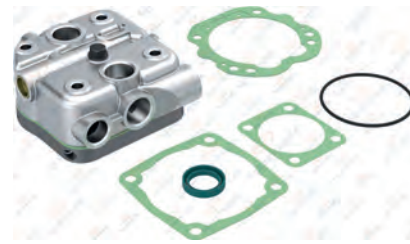

Knorr No : ZB4275\*

**RK.01.035.01**

Valve Plate Kit

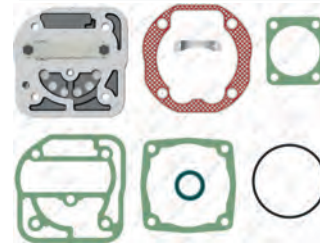

8 680437 112426

**RK.01.035.02**

Valve Plate Kit



8 680437 112433

**RK.01.148**

Repair Kit

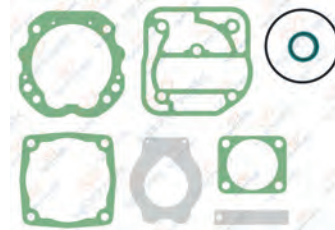

8 680437 061236

**RK.01.148.02**

Repair Kit

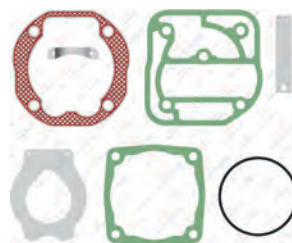

8 680437 006978

**RK.01.148.03**

Repair Kit



8 680437 120193

**01.076** Cylinder Head



8 680437 014164

**01.139** Valve Plate



8 680437 018537

**01.188** Crankshaft



M18X1.5 Right Hand



8 680437 019251

**01.409** Pump Support



8 680437 022268

**01.194** Crankshaft Flange



8 680437 019398

**01.003** Connecting Rod



8 680437 009672

OEM No : 1698852 - 3099752 - 1699828

**RK.01.034.00** Piston&Ring (Ø88,00 mm)

- RK.01.034.10 88,25 mm
- RK.01.034.20 88,50 mm
- RK.01.034.30 88,75 mm
- RK.01.034.40 89,00 mm



2.50x2,50x4,00



8 680437 058816

OEM No : 85101375-3095841-1698848  
Knorr No : I81169004

**01.110.00** Piston (Ø88,00 mm)

- 01.110.10 88,25 mm
- 01.110.20 88,50 mm
- 01.110.30 88,75 mm
- 01.110.40 89,00 mm



2.50x2,50x4,00



8 680437 015994

**01.136.00** Ring (Ø88,00 mm)

- 01.136.10 88,25 mm
- 01.136.20 88,50 mm
- 01.136.30 88,75 mm
- 01.136.40 89,00 mm



2.50x2,50x4,00



8 680437 018384

**RK.01.039** Cylinder Liner Set



8 680437 058939

**01.184** Cylinder Liner



8 680437 019145

**01.143** Nut



M18X1.5 Right Hand



8 680437 018735

**RK.01.148.05** Repair Kit

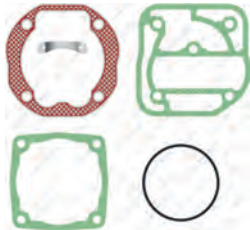

8 680437 120209

**01.195** Bushing



34X30X16



8 680437 019411

**01.013** Bushing



34X30X16



8 680437 009993

# Single Cylinder Compressor Ø75 mm-155 CC-Stroke 35 mm

Application - Vehicle  
VOLVO FM



**01.05.005**

Knorr. No.  
LK1566  
II39151F



**01.314**

Crankcase

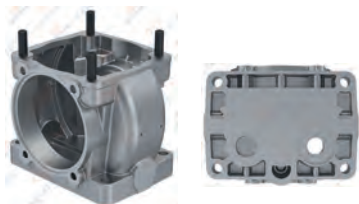

**RK.01.046.01**

Repair Kit

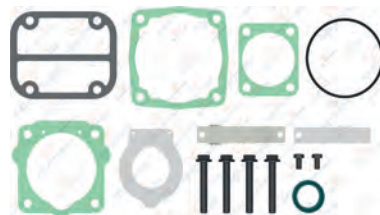

**RK.01.048**

Complete Cylinder Head



Knorr No : STW63841

**RK.01.048.20**

Complete Cylinder Head



**01.067**

Cylinder Head



**RK.01.047.20**

Valve Plate Kit

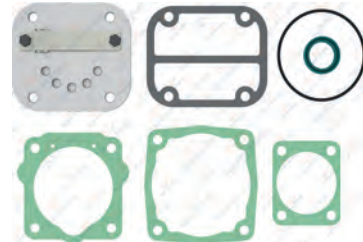

**RK.01.047**

Valve Plate Kit



**RK.01.046**

Repair Kit

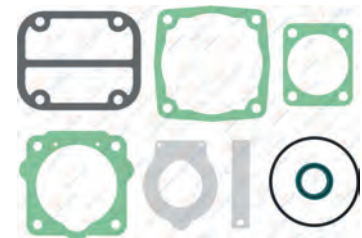



**RK.01.046.02** Repair Kit

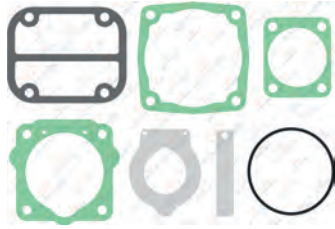

8 680437 072843

**RK.01.046.21** Repair Kit

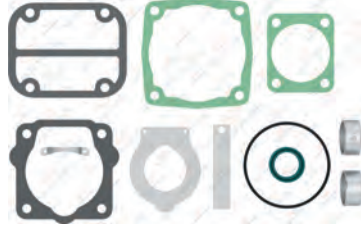

8 680437 120766

**01.206** Crankshaft



M18X1.5 Right Hand



8 680437 019534

**01.119** Valve Plate



8 680437 017387

Knorr No : II38717F004

**01.194** Crankshaft Flange



8 680437 019398

**01.003** Connecting Rod



8 680437 009672

OEM No : 1698852 - 3099752 - 1699828

**RK.01.073.00** Piston&Ring (Ø75,00 mm)

- RK.01.073.10 75,25 mm
- RK.01.073.20 75,50 mm
- RK.01.073.30 75,75 mm
- RK.01.073.40 76,00 mm



2.00x2,00x4,00



8 680437 059547

Knorr No : SEB22539 - SEB22540

**01.193.00** Piston (Ø75,00 mm)

- 01.193.10 75,25 mm
- 01.193.20 75,50 mm
- 01.193.30 75,75 mm
- 01.193.40 76,00 mm



2.00x2,00x4,00



8 680437 019336

**01.134.00** Ring (Ø75,00 mm)

- 01.134.10 75,25 mm
- 01.134.20 75,50 mm
- 01.134.30 75,75 mm
- 01.134.40 76,00 mm



2.00x2,00x4,00



8 680437 018278

**RK.01.045** Cylinder Liner Set



8 680437 059004

Knorr No : ZB4265 - I77246

**01.056** Cylinder Liner



8 680437 013174

**01.409** Pump Support



8 680437 022268

**01.143** Nut



M18X1.5 Right Hand



8 680437 018735

**01.195** Bushing



34X30X16



8 680437 019411

**01.013** Bushing



34X30X16



8 680437 009993

## Single Cylinder Compressor Ø80 mm-225 CC-Stroke 45 mm

Application - Vehicle  
VOLVO FL6



**01.04.110**

**Oem. No.**  
20568592  
85000344

**Knorr No.**  
LK3841  
K004640X00



**01.1315** Crankcase



**RK.01.159.11** Repair Kit

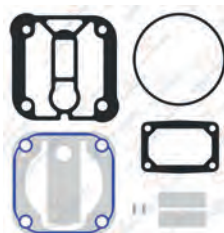

**RK.01.273.10** Complete Cylinder Head



**RK.01.638.01** Valve Plate Kit



Knorr No : SEB01916K50

**RK.01.638** Valve Plate Kit



**RK.01.159.02** Repair Kit

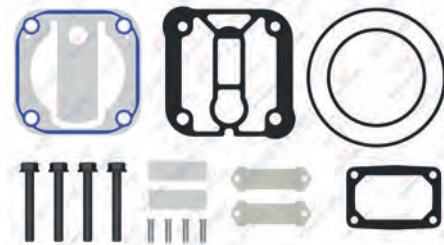

**RK.01.159.24** Repair Kit

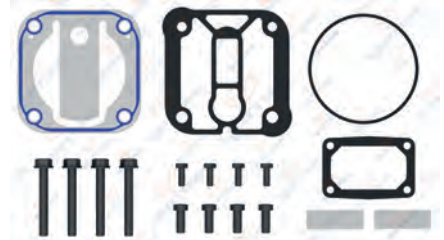

Knorr No : SEB22519K50

**RK.01.159.23** Repair Kit

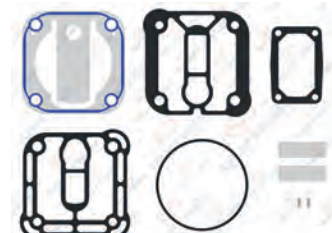

Knorr No : SEB22518\*

**01.1291.10** Cylinder Head



8 680437 078258

**RK.01.273.11** Complete Cylinder Head



Knorr No : K034890K50

**01.1567** Crankshaft



M20X1.5 Right Hand



8 680437 109495

**01.1290** Valve Plate



8 680437 071624

**01.288** Crankshaft Flange



OEM No : 3097150  
Knorr No : II159920065

**01.218** Connecting Rod



OEM No : 1697281 - 1698528 - 3090386  
Knorr No : SEB00626004 - SEB00957004

**RK.01.601.00** Piston&Ring (Ø80,00 mm)

- RK.01.601.10 80,25 mm
- RK.01.601.20 80,50 mm
- RK.01.601.30 80,75 mm
- RK.01.601.40 81,00 mm



2.50x2,50x4,00



Knorr No : SEB22517

**01.1201.00** Piston (Ø80,00 mm)

- 01.1201.10 80,25 mm
- 01.1201.20 80,50 mm
- 01.1201.30 80,75 mm
- 01.1201.40 81,00 mm

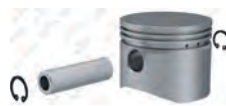

2.50x2,50x4,00



8 680437 017530

**01.1226.00** Ring (Ø80,00 mm)

- 01.1226.10 80,25 mm
- 01.1226.20 80,50 mm
- 01.1226.30 80,75 mm
- 01.1226.40 81,00 mm



2.50x2,50x4,00



8 680437 017882

**01.144** Nut



M20X1.5 Right Hand



OEM No : 1698672

**01.374** Cover



8 680437 077022

**01.1610** Gear



OEM No : 3169496

**RK.01.159.05** Repair Kit

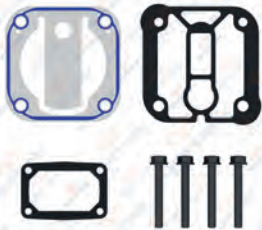

Knorr No : SEB018190051

**01.820** Bushing



42X38X25



8 680437 027058



## Twin Cylinder Compressor Ø85 mm-636 CC-Stroke 56 mm

Application - Vehicle  
VOLVO  
COMPRESSOR WITH OPTIMIZED PISTON  
(CLUTCH VERSION)



**01.06.087**

Oem. No.  
21749961

Wabco No.  
9125120220



8 680437 107217



**01.1770**

Crankcase



8 680437 128557

**RK.01.777**

Repair Kit



8 680437 128731

Wabco No : 9125129322  
9125129402

**RK.01.778**

Repair Kit



8 680437 128748

Wabco No : 9125129332

**RK.01.725**

Complete Cylinder Head



8 680437 076377

Wabco No : 9125149202

**RK.01.744**

Repair Kit

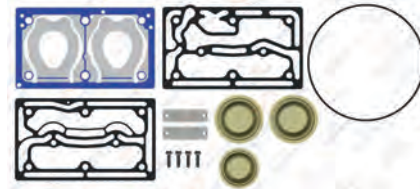

8 680437 122647

**RK.01.744.05**

Repair Kit

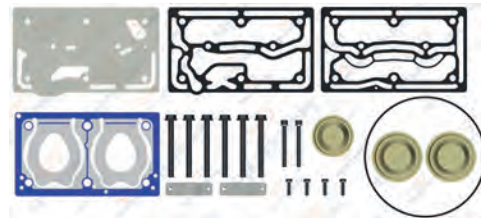

8 680437 122494

**RK.01.744.01**

Repair Kit

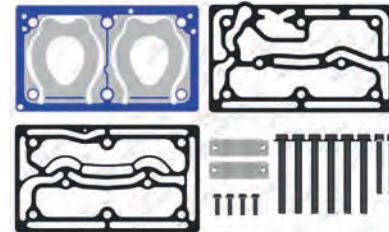

8 680437 122098

Wabco No : 9125129382

**RK.01.419**

Repair Kit

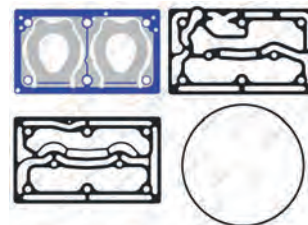

8 680437 065036

### 01.1772 Cylinder Head



8 680437 128533

### 01.1489 Valve Plate



8 680437 078661

### 01.1771 Crankshaft



8 680437 128564

### RK.01.104.00 Piston&Ring

- RK.01.104.10 85,25 mm
- RK.01.104.20 85,50 mm
- RK.01.104.30 85,75 mm
- RK.01.104.40 86,00 mm



2,00X2,00X4,00



8 680437 060277

### 01.142.00 Piston

- 01.142.10 85,25 mm
- 01.142.20 85,50 mm
- 01.142.30 85,75 mm
- 01.142.40 86,00 mm



2,00X2,00X4,00



8 680437 018674

Wabco No : 9115016242 - 9115016252

### 01.373.00 Ring

- 01.373.10 85,25 mm
- 01.373.20 85,50 mm
- 01.373.30 85,75 mm
- 01.373.40 86,00 mm



2,00X2,00X4,00



8 680437 075431

OEM No : 3094621  
Wabco No : 9115019202

### 01.565 Cooling Plate



8 680437 024095

### 01.272 Connecting Rod



8 680437 020400

## Single Cylinder Compressor Ø92 mm-360 CC-Stroke 54 mm

Application - Vehicle  
VOLVO VM 220 - 270 - 330



**01.04.188**

Knorr No.  
LK39..



**01.1774**

Crankcase



**RK.01.395.06**

Repair Kit

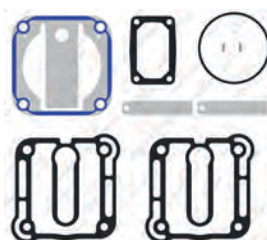

Knorr No : SEB22532

**RK.01.644.10**

Complete Cylinder Head



**RK.01.645.02**

Valve Plate Kit



Knorr No : SEB01968K50

**RK.01.645**

Valve Plate Kit

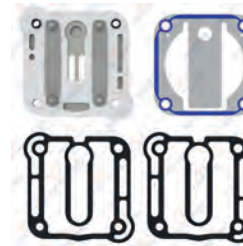

**RK.01.395.01**

Repair Kit

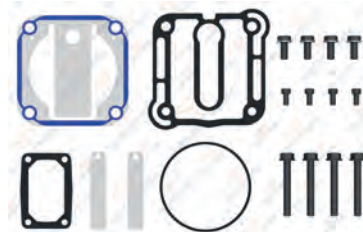

**RK.01.395.03**

Repair Kit

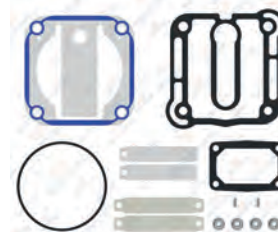

**RK.01.275**

Repair Kit

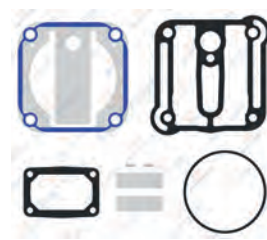



**01.1304.10** Cylinder Head



8 680437 100331

**01.186** Valve Plate



8 680437 019190

**01.1773** Crankshaft



8 680437 128779

**RK.01.318.00** Piston&Ring (Ø92,00 mm)

- RK.01.318.10 92,25 mm
- RK.01.318.20 92,50 mm
- RK.01.318.30 92,75 mm
- RK.01.318.40 93,00 mm



2.50x2,50x4,00



Knorr No : K012079

**01.862.00** Piston (Ø92,00 mm)

- 01.862.10 92,25 mm
- 01.862.20 92,50 mm
- 01.862.30 92,75 mm
- 01.862.40 93,00 mm



2.50x2,50x4,00



8 680437 027584

**01.942.00** Ring (Ø92,00 mm)

- 01.942.10 92,25 mm
- 01.942.20 92,50 mm
- 01.942.30 92,75 mm
- 01.942.40 93,00 mm



2.50x2,50x4,00



8 680437 028666

**01.1392** Crankshaft Flange



8 680437 072225

**01.1101** Connecting Rod



8 680437 016069

**RK.01.023** Repair Kit

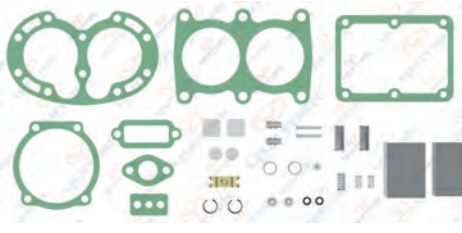

Tuflo 500 : 272813  
8 680437 058588

**RK.01.230** Repair Kit

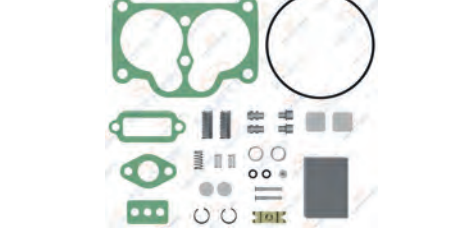

Tuflo 501 : 272878  
8 680437 062458

**RK.01.333** Repair Kit

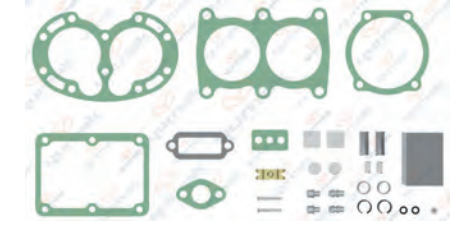

8 680437 063971

**RK.01.525** Repair Kit

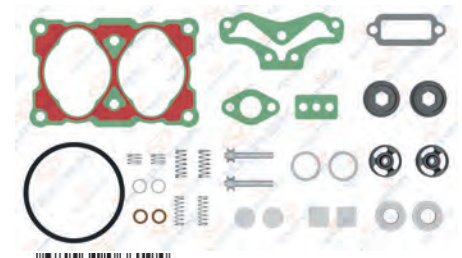

8 680437 066194

**RK.01.525.02** Repair Kit

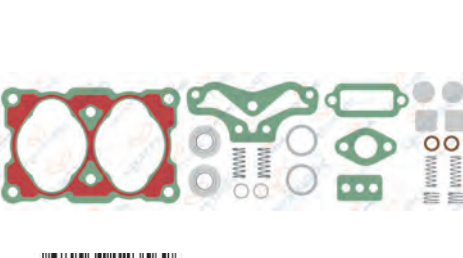

8 680437 123569

**RK.01.311** Repair Kit

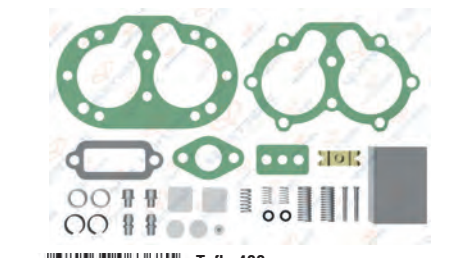

Tuflo 400  
8 680437 063681

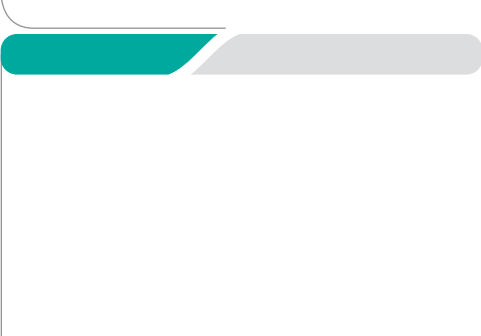
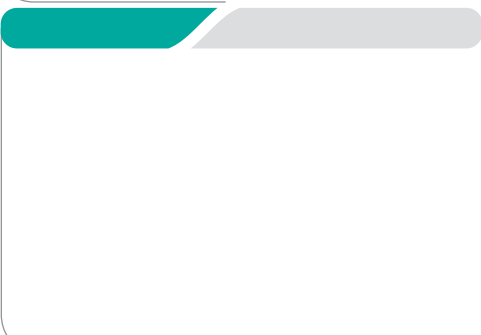
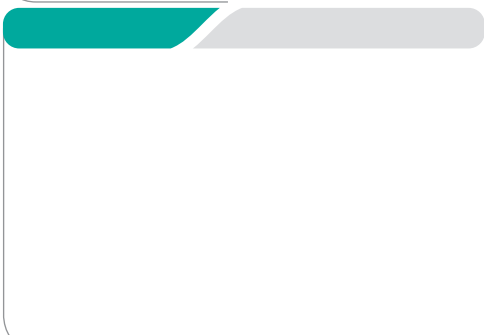

# VOLVO

AIR COMPRESSOR AND REPAIR KIT

VOLVO

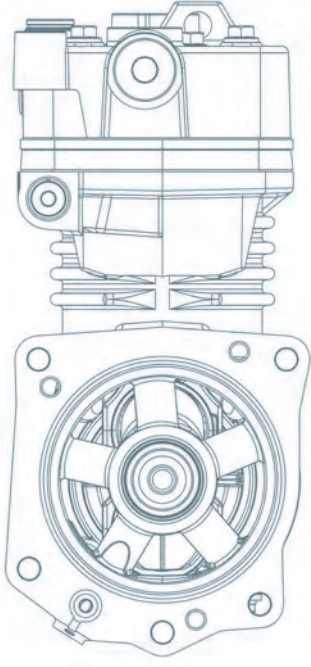

# SCANIA

**HAVA KOMPRESÖRLERİ  
ve TAMİR TAKIMLARI**

AIR COMPRESSORS AND REPAIR KITS

# SCANIA

SCANIA



## Twin Cylinder Compressor Ø86 mm-720 CC-Stroke 62 mm

### Application - Vehicle

SCANIA EURO4 G420 / G440 / R420 / R440 / R460  
R480 / R520 / R570 / R640 / R720 / K410

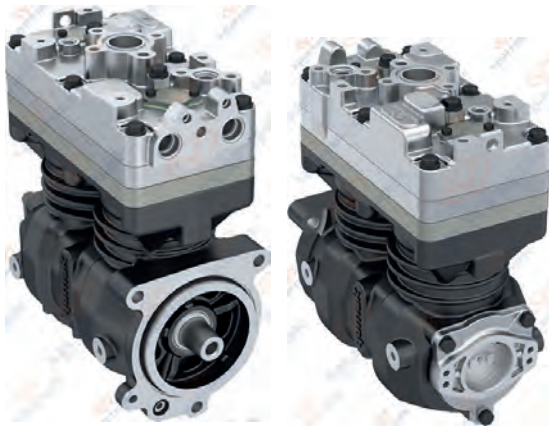

### 01.04.115

Oem. No.  
1880194  
1767161

Knorr No.  
LK4951

### 01.04.115.01

With Gear



### 01.1138

Crankcase



### RK.01.561.20

Repair Kit

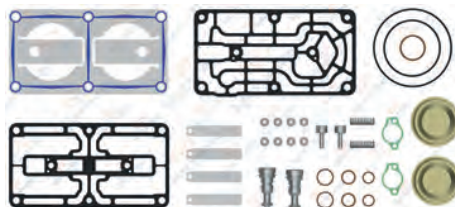

### RK.01.561

Repair Kit

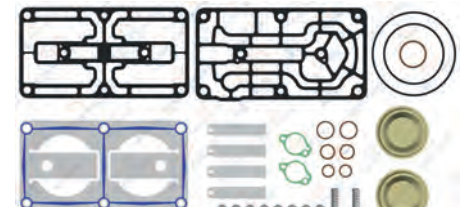

Knorr No : K018809

### RK.01.559

Complete Cylinder Head



### RK.01.559.20

Complete Cylinder Head

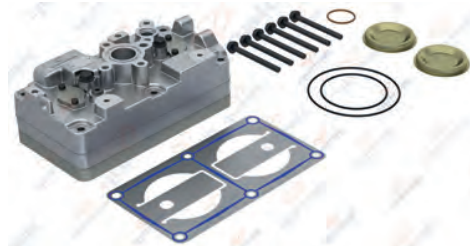

### RK.01.560.20

Valve Plate Kit

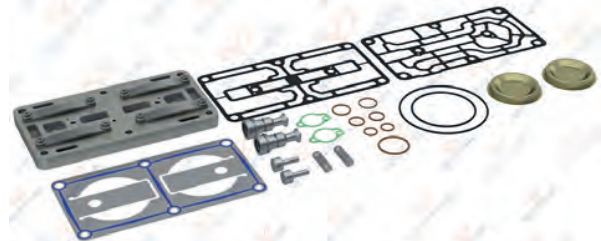

### RK.01.560

Valve Plate Kit

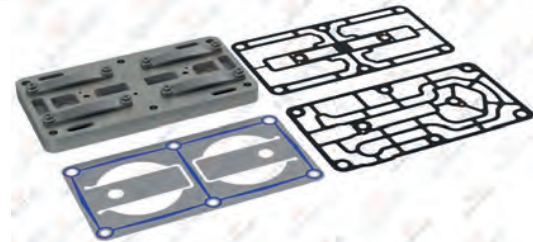

### RK.01.561.01

Repair Kit





**01.1139** Cylinder Head

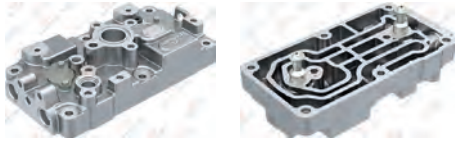

Barcode: 8 680437 016717  
**Knorr No : K018810**

**01.1140** Cooling Plate



Barcode: 8 680437 016731

**01.1141** Crankshaft



Barcode: 8 680437 016748

**01.1144** Valve Plate



Barcode: 8 680437 016779  
**Knorr No : K018806**

**01.1142** Crankshaft Flange



Barcode: 8 680437 016755

**01.1056** Connecting Rod



Barcode: 8 680437 015345

**RK.01.272.00** Piston&Ring (Ø86,00 mm)

- RK.01.272.10 86,25 mm
- RK.01.272.20 86,50 mm
- RK.01.272.30 86,75 mm
- RK.01.272.40 87,00 mm



2.00x2.00x3.00  
 Barcode: 8 680437 063209  
**OEM No : 42549147**  
**Knorr No : SEB22547 - SEB22548**

**01.868.00** Piston (Ø86,00 mm)

- 01.868.10 86,25 mm
- 01.868.20 86,50 mm
- 01.868.30 86,75 mm
- 01.868.40 87,00 mm



2.00x2.00x3.00  
 Barcode: 8 680437 027676

**01.869.00** Ring (Ø86,00 mm)

- 01.869.10 86,25 mm
- 01.869.20 86,50 mm
- 01.869.30 86,75 mm
- 01.869.40 87,00 mm



2.00x2.00x3.00  
 Barcode: 8 680437 027737

**RK.01.809** Connecting Rod & Piston



Barcode: 8 680437 114611

**01.1188** Cap



Barcode: 8 680437 017363

**01.1484** Gear



Barcode: 8 680437 074625  
**Oem No : 1775248 - 1732078**

**RK.01.561.05** Repair Kit

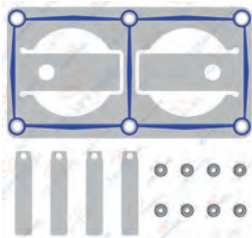

Barcode: 8 680437 124139

**RK.01.562** Repair Kit

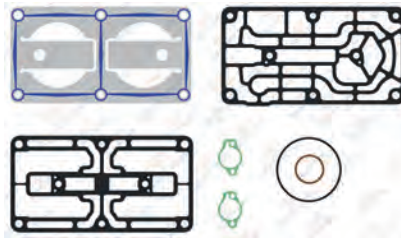

Barcode: 8 680437 078401

**RK.01.558** Repair Kit

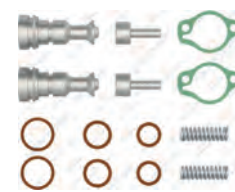

Barcode: 8 680437 066613  
**Knorr No : K034874K50**

## Twin Cylinder Compressor Ø86 mm-720 CC-Stroke 62 mm

### Application - Vehicle

SCANIA EURO4 G420 / G440 / R420 / R440 / R460  
R480 / R520 / R570 / R640 / R720 / K410

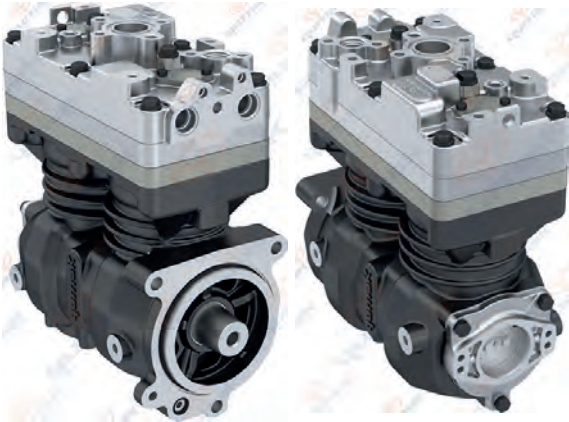

**01.04.115.10**

Oem. No.  
2024412  
2024413

Knorr No.  
LK4951

**01.04.115.11**

With Gear



**01.1138**

Crankcase



**RK.01.561.20**

Repair Kit

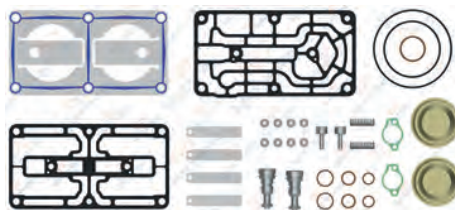

**RK.01.561**

Repair Kit

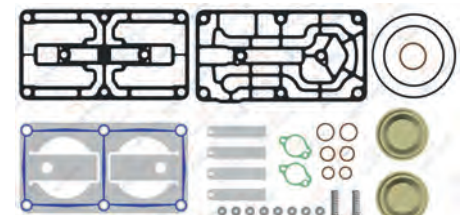

Knorr No : K018809

**RK.01.559**

Complete Cylinder Head



**RK.01.559.20**

Complete Cylinder Head

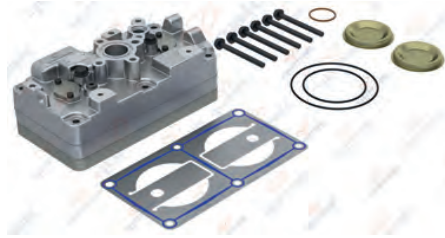

**RK.01.560.20**

Valve Plate Kit

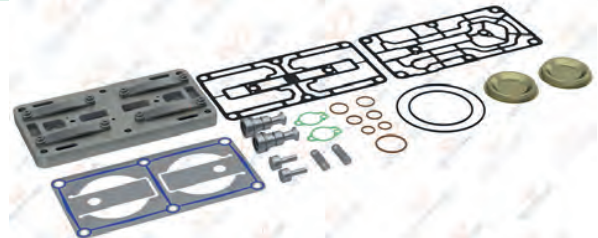

**RK.01.560**

Valve Plate Kit

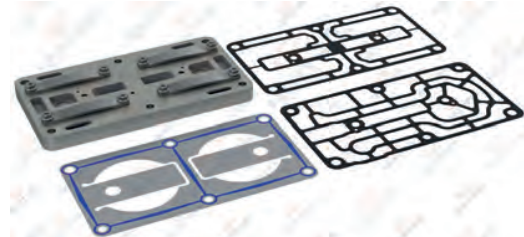

**RK.01.561.01**

Repair Kit

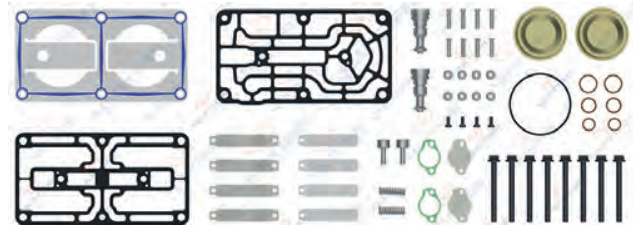



**01.1139** Cylinder Head



Knorr No : K018810  
8 680437 016717

**01.1140** Cooling Plate



8 680437 016731

**01.1141.10** Crankshaft



8 680437 078364

**01.1144** Valve Plate



Knorr No : K018806  
8 680437 016779

**01.1142** Crankshaft Flange



8 680437 016755

**01.1056** Connecting Rod



8 680437 015345

**RK.01.272.00** Piston&Ring (Ø86,00 mm)

- RK.01.272.10 86,25 mm
- RK.01.272.20 86,50 mm
- RK.01.272.30 86,75 mm
- RK.01.272.40 87,00 mm



2.00x2.00x3.00  
OEM No : 42549147  
Knorr No : SEB22547 - SEB22548  
8 680437 063209

**01.868.00** Piston (Ø86,00 mm)

- 01.868.10 86,25 mm
- 01.868.20 86,50 mm
- 01.868.30 86,75 mm
- 01.868.40 87,00 mm



2.00x2.00x3.00  
8 680437 027676

**01.869.00** Ring (Ø86,00 mm)

- 01.869.10 86,25 mm
- 01.869.20 86,50 mm
- 01.869.30 86,75 mm
- 01.869.40 87,00 mm



2.00x2.00x3.00  
8 680437 027737

**RK.01.809** Connecting Rod & Piston



8 680437 114611

**01.820** Bushing



8 680437 027058

**01.1484.10** Gear



OEM No : 2022257  
8 680437 078869

**RK.01.561.05** Repair Kit

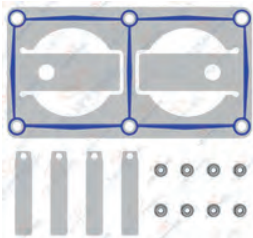

8 680437 124139

**RK.01.562** Repair Kit

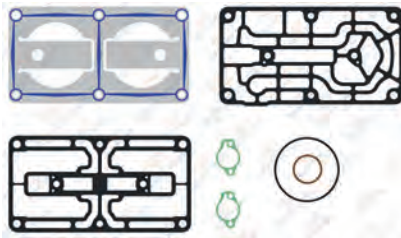

8 680437 078401

**RK.01.558** Repair Kit

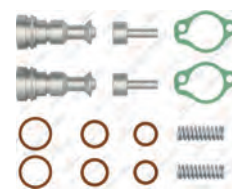

Knorr No : K034874K50  
8 680437 066613



## Twin Cylinder Compressor Ø86 mm-720 CC

Application - Vehicle  
SCANIA P,G,R,T TRUCK F,K,N BUS

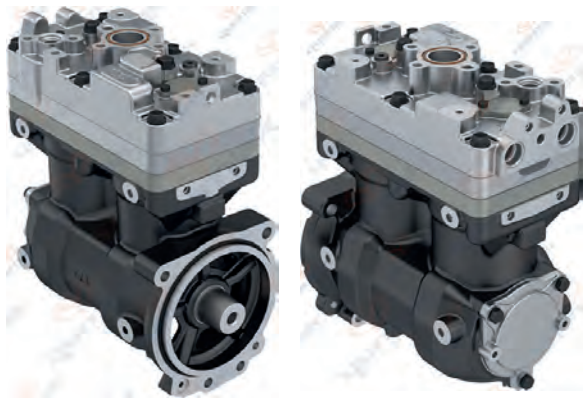

### 01.04.166

Oem. No.	Knorr No.
2024410	LK4949-K009580000
1882222	LK4961-K018625000



01.1585

Crankcase



RK.01.559

Complete Cylinder Head



RK.01.559.20

Complete Cylinder Head

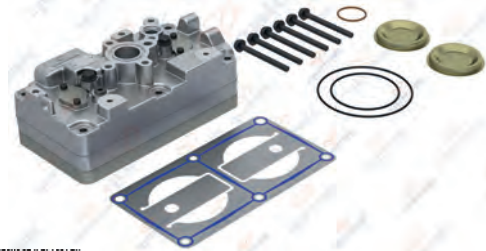

RK.01.560.20

Valve Plate Kit

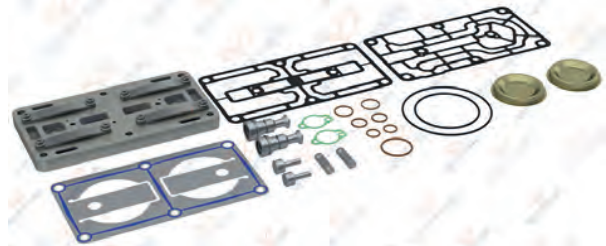

RK.01.560

Valve Plate Kit

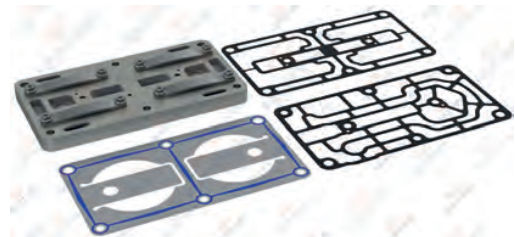

RK.01.561.01

Repair Kit

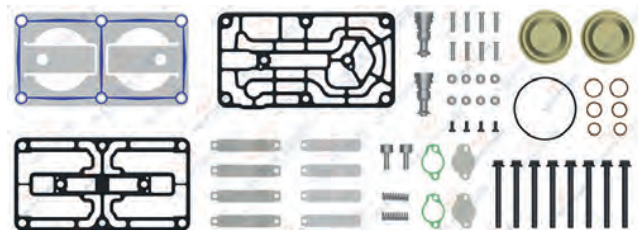

RK.01.561.20

Repair Kit

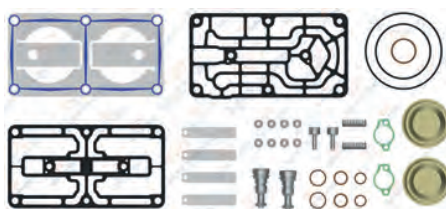

RK.01.561

Repair Kit

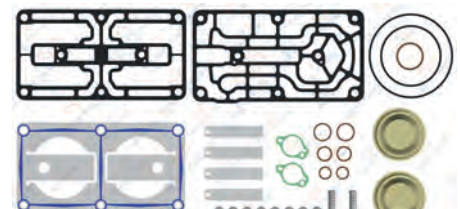

Knorr No : K018809

**01.1139** Cylinder Head



Knorr No : K018810  
8 680437 016717

**01.1140** Cooling Plate



8 680437 016731

**01.1141.30** Crankshaft



8 680437 109440

**01.1144** Valve Plate



Knorr No : K018806  
8 680437 016779

**01.1583** Crankshaft Flange



8 680437 084693

**01.1056** Connecting Rod



8 680437 015345

**RK.01.272.00** Piston&Ring (Ø86,00 mm)

- RK.01.272.10 86,25 mm
- RK.01.272.20 86,50 mm
- RK.01.272.30 86,75 mm
- RK.01.272.40 87,00 mm



2.00x2.00x3.00

OEM No : 42549147  
Knorr No : SEB22547 - SEB22548  
8 680437 063209

**01.868.00** Piston (Ø86,00 mm)

- 01.868.10 86,25 mm
- 01.868.20 86,50 mm
- 01.868.30 86,75 mm
- 01.868.40 87,00 mm



2.00x2.00x3.00

8 680437 027676

**01.869.00** Ring (Ø86,00 mm)

- 01.869.10 86,25 mm
- 01.869.20 86,50 mm
- 01.869.30 86,75 mm
- 01.869.40 87,00 mm



2.00x2.00x3.00

8 680437 027737

**RK.01.809** Connecting Rod & Piston



8 680437 114611

**01.820** Bushing



8 680437 027058

**01.1188** Cap



8 680437 017363

**RK.01.561.05** Repair Kit

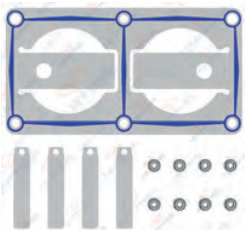

8 680437 124139

**RK.01.558** Repair Kit

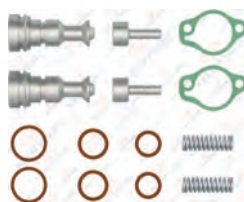

Knorr No: K034874K50  
8 680437 066613



## Twin Cylinder Compressor Ø86 mm-720 CC

Application - Vehicle  
SCANIA P,G,R,T TRUCK F,K,N BUS

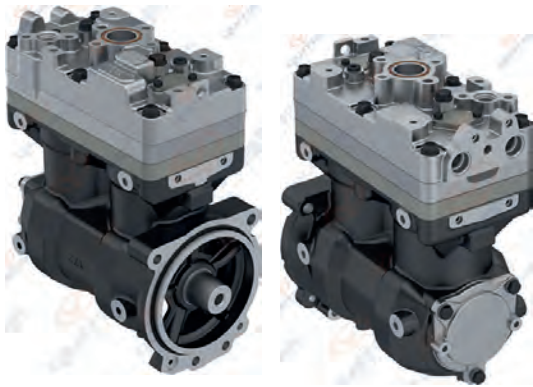

**01.04.166.10**

Oem. No.	Knorr No.
2024410	LK4949-K009580000
1901243	LK4961 - K18625000
1882222	
190247	



**01.1585** Crankcase



**RK.01.561.20** Repair Kit

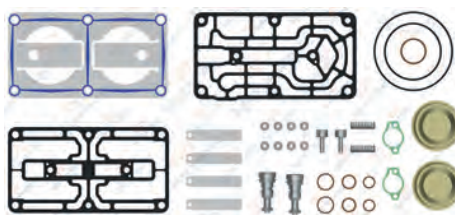

**RK.01.561** Repair Kit

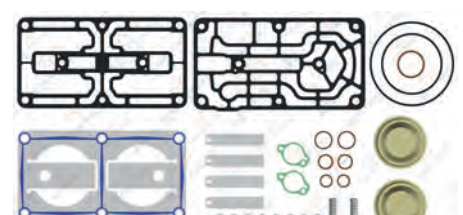

Knorr No : K018809

**RK.01.559**

Complete Cylinder Head



**RK.01.559.20**

Complete Cylinder Head

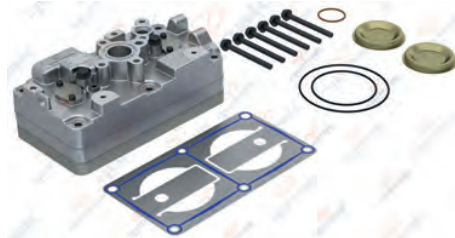

**RK.01.560.20**

Valve Plate Kit

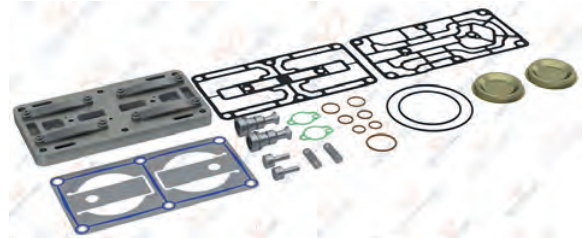

**RK.01.560**

Valve Plate Kit

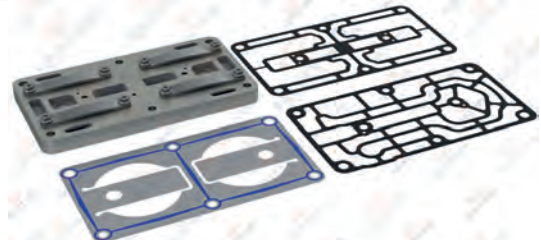

**RK.01.561.01**

Repair Kit

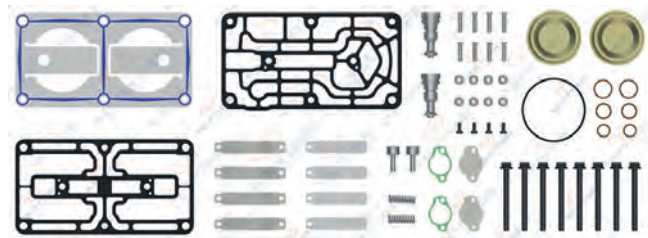



### 01.1139 Cylinder Head



Knorr No: K018810  
8 680437 016717

### 01.1140 Cooling Plate



8 680437 016731

### 01.1141.20 Crankshaft



8 680437 109471

### 01.1144 Valve Plate



Knorr No : K018806  
8 680437 016779

### 01.1583 Crankshaft Flange



8 680437 084693

### 01.1056 Connecting Rod



8 680437 015345

### RK.01.272.00 Piston&Ring (Ø86,00 mm)

RK.01.272.10	86,25 mm
RK.01.272.20	86,50 mm
RK.01.272.30	86,75 mm
RK.01.272.40	87,00 mm



2.00x2.00x3.00

OEM No: 42549147  
Knorr No: SEB22547 - SEB22548  
8 680437 063209

### 01.868.00 Piston (Ø86,00 mm)

01.868.10	86,25 mm
01.868.20	86,50 mm
01.868.30	86,75 mm
01.868.40	87,00 mm



2.00x2.00x3.00

8 680437 027676

### 01.869.00 Ring (Ø86,00 mm)

01.869.10	86,25 mm
01.869.20	86,50 mm
01.869.30	86,75 mm
01.869.40	87,00 mm



2.00x2.00x3.00

8 680437 027737

### RK.01.809 Connecting Rod & Piston



8 680437 114611

### 01.820 Bushing



8 680437 027058

### 01.1188 Cap



8 680437 017363

### RK.01.561.05 Repair Kit

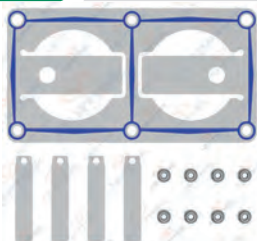

8 680437 124139

### RK.01.558 Repair Kit

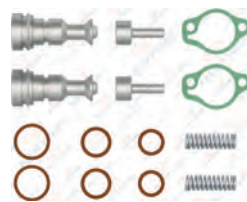

Knorr No: K034874K50  
8 680437 066613

## Twin Cylinder Compressor Ø86 mm-720 CC

Application - Vehicle  
SCANIA

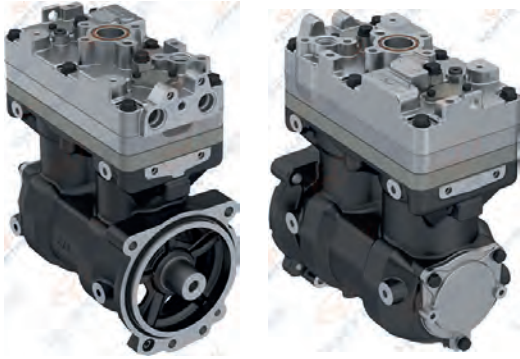

**01.04.187**

Oem. No.  
1918307

Knorr No.  
LK4970-K038653N00



8 680437 080480



**01.1585**

Crankcase



8 680437 102724

**RK.01.561.20**

Repair Kit

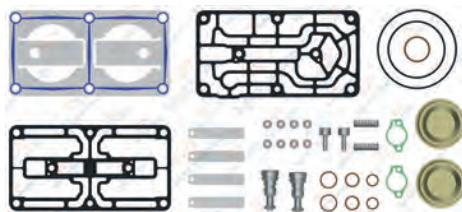

8 680437 077725

**RK.01.559** Complete Cylinder Head



8 680437 066620

**RK.01.559.20**

Complete Cylinder Head

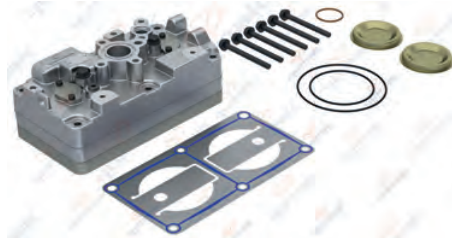

8 680437 105725

**RK.01.560.20**

Valve Plate Kit

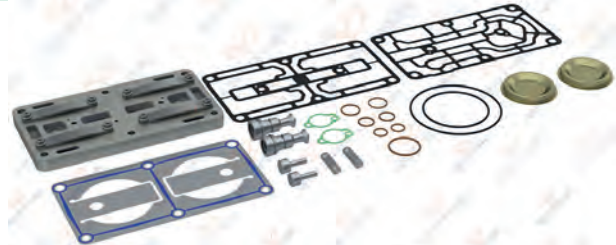

8 680437 112280

**RK.01.560**

Valve Plate Kit

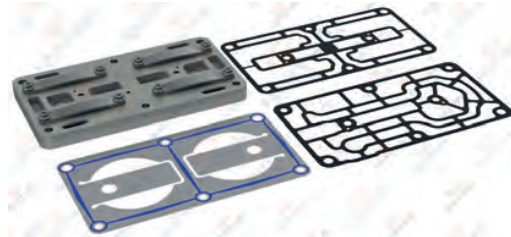

8 680437 066637

**RK.01.561.01**

Repair Kit



8 680437 066651

**RK.01.561**

Repair Kit

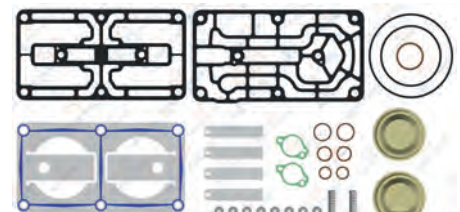

8 680437 066644

Knorr No : K018809

**01.1139** Cylinder Head

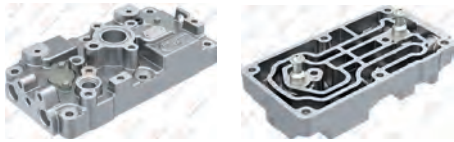

Knorr No: K018810  
8 680437 016717

**01.1140** Cooling Plate



8 680437 016731

**01.1141.20** Crankshaft



8 680437 109471

**01.1144** Valve Plate



Knorr No : K018806  
8 680437 016779

**01.1583** Crankshaft Flange



8 680437 084693

**01.1056** Connecting Rod



8 680437 015345

**RK.01.272.00** Piston&Ring (Ø86,00 mm)

- RK.01.272.10 86,25 mm
- RK.01.272.20 86,50 mm
- RK.01.272.30 86,75 mm
- RK.01.272.40 87,00 mm



2.00x2.00x3.00  
OEM No: 42549147  
Knorr No: SEB22547 - SEB22548  
8 680437 063209

**01.868.00** Piston (Ø86,00 mm)

- 01.868.10 86,25 mm
- 01.868.20 86,50 mm
- 01.868.30 86,75 mm
- 01.868.40 87,00 mm



2.00x2.00x3.00  
8 680437 027676

**01.869.00** Ring (Ø86,00 mm)

- 01.869.10 86,25 mm
- 01.869.20 86,50 mm
- 01.869.30 86,75 mm
- 01.869.40 87,00 mm



2.00x2.00x3.00  
8 680437 027737

**RK.01.809** Connecting Rod & Piston



8 680437 114611

**01.820** Bushing



42X38X25  
8 680437 027058

**01.1188** Cap



8 680437 017363

**RK.01.561.05** Repair Kit

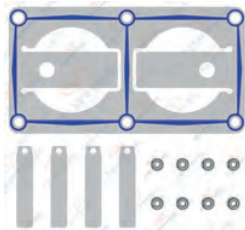

8 680437 124139

**RK.01.558** Repair Kit

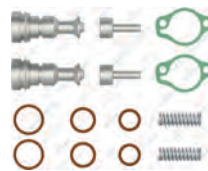

Knorr No: K034874K50  
8 680437 066613



## Twin Cylinder Compressor Ø92 mm-720 CC-Stroke 62 mm

Application - Vehicle  
SCANIA 4 SERIES BUS

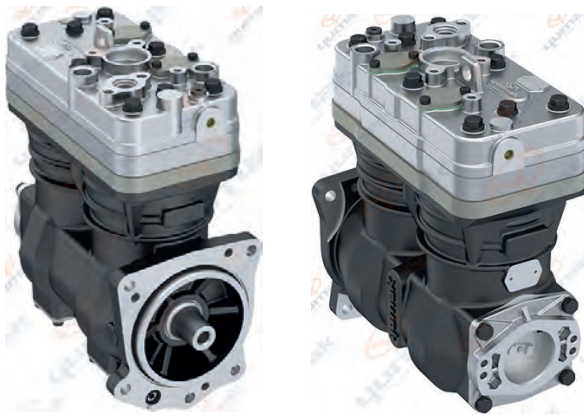

### 01.04.116

Oem. No.  
2032484  
1745712

Knorr No.  
LK4930-K055985N00



8 680437 011866



01.1159

Crankcase



8 680437 016977

RK.01.264

Repair Kit

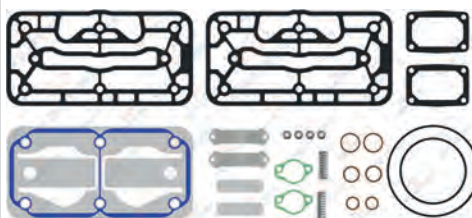

8 680437 062998

RK.01.567 Complete Cylinder Head



8 680437 066729

RK.01.567.20

Complete Cylinder Head

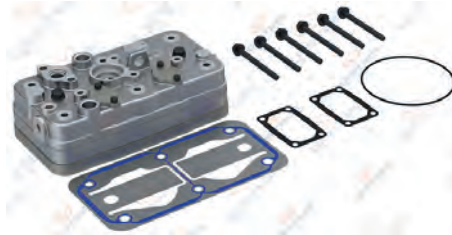

8 680437 105701

RK.01.568.21

Valve Plate Kit

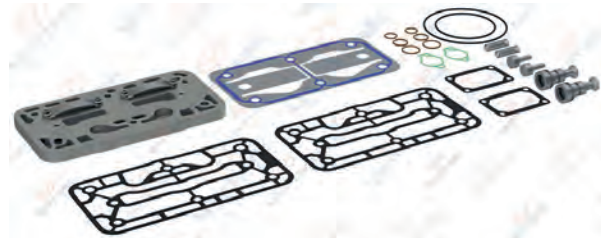

8 680437 112501

RK.01.568

Valve Plate Kit

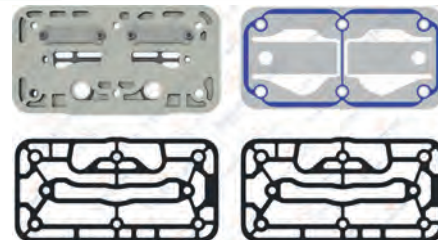

8 680437 066736

RK.01.264.01

Repair Kit

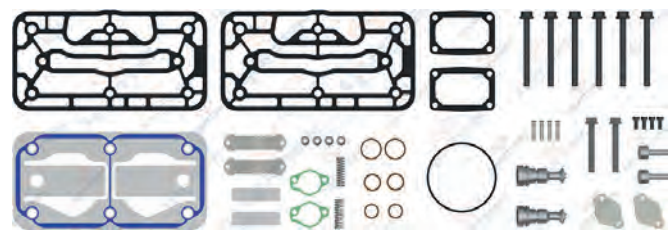

8 680437 063001

RK.01.264.21

Repair Kit

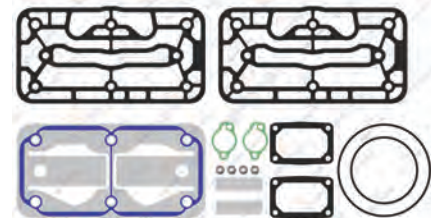

8 680437 120490

01.1163

Cylinder Head



8 680437 017073

01.1161

Cooling Plate



8 680437 017059

01.1164

Crankshaft



8 680437 017080

01.1162

Valve Plate



8 680437 017066

Knorr No: K012074

01.1160

Crankshaft Flange



8 680437 017042

01.1056

Connecting Rod



8 680437 015345

RK.01.318.00

Piston&Ring (Ø92,00 mm)

RK.01.318.10	92,25 mm
RK.01.318.20	92,50 mm
RK.01.318.30	92,75 mm
RK.01.318.40	93,00 mm



2.50x2,50x4,00



8 680437 063773

Knorr No: K006026 - K012079

01.862.00

Piston (Ø92,00 mm)

01.862.10	92,25 mm
01.862.20	92,50 mm
01.862.30	92,75 mm
01.862.40	93,00 mm



2.50x2,50x4,00



8 680437 027584

01.942.00

Ring (Ø92,00 mm)

01.942.10	92,25 mm
01.942.20	92,50 mm
01.942.30	92,75 mm
01.942.40	93,00 mm



2.50x2,50x4,00



8 680437 028666

RK.01.558

Repair Kit

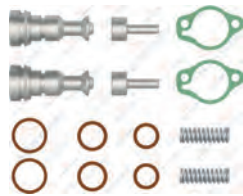

8 680437 066613

Knorr No: K034874K50

RK.01.813

Connecting Rod & Piston



8 680437 114635

01.292

Bushing



42X38X25



8 680437 073871

RK.01.264.03

Repair Kit

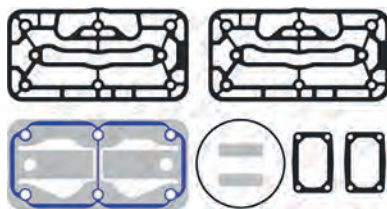

8 680437 120483

Knorr No: K012081

RK.01.264.05

Repair Kit

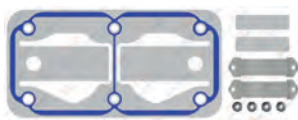

8 680437 124146

RK.01.264.20

Repair Kit

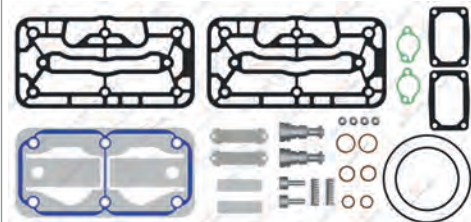

8 680437 080794



## Twin Cylinder Compressor Ø88 mm-600 CC-Stroke 50 mm

Application - Vehicle  
SCANIA 124 / 340 SERIE 4  
Santrifüj / Centrifugal



**01.04.074**

Oem. No.	Knorr No.
1796663	LK4941-K016615000
1514064	LP4965-K016615ES
1470304	
1380457	
571287	
1512834	
1784109	
1770607	

**01.04.074.10**

With Gear



**01.758**

Crankcase



**RK.01.083**

Repair Kit

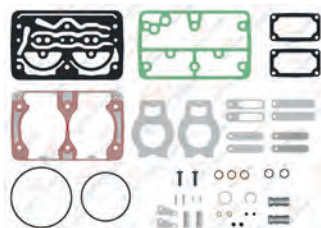

Knorr No : SEB22596

**RK.01.083.03**

Repair Kit

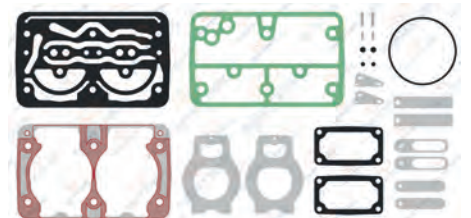

**RK.01.276**

Complete Cylinder Head

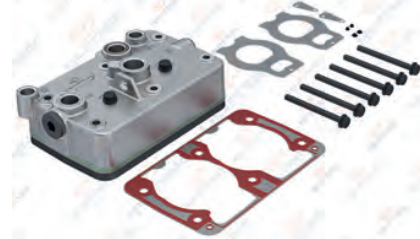

**RK.01.276.20**

Complete Cylinder Head

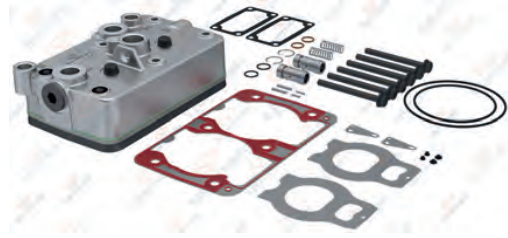

**RK.01.082.20**

Valve Plate Kit

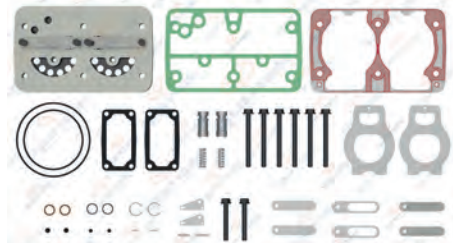

**RK.01.082**

Valve Plate Kit

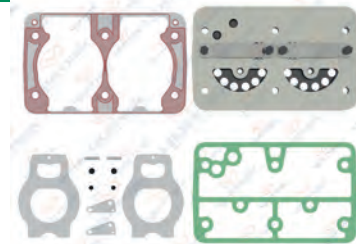

**RK.01.083.01**

Repair Kit

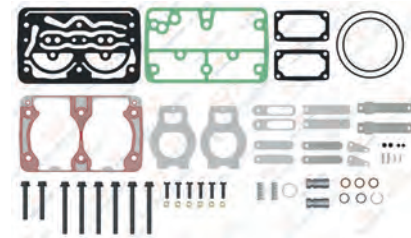



**01.363** Cylinder Head



8 680437 021629 **OEM No** : 1424766  
**Knorr No** : SEB01444004

**01.812** Crankshaft Flange



8 680437 026969 **OEM No** : 1932013  
**Knorr No** : K036087K50

**01.813** Crankshaft



8 680437 026976

**RK.01.082.02** Valve Plate Kit



8 680437 112679 **OEM No** : 1376272  
**Knorr No** : SEB01033004

**01.292** Bushing



42X38X25  
8 680437 073871

**01.226** Connecting Rod



8 680437 019824 **Knorr No** : SEB00967004

**RK.01.034.00** Piston&Ring (Ø88,00 mm)

RK.01.034.10	88,25 mm
RK.01.034.20	88,50 mm
RK.01.034.30	88,75 mm
RK.01.034.40	89,00 mm



2.50x2,50x4,00  
8 680437 058616 **Knorr No** : I81169004 - SEB22555

**01.110.00** Piston (Ø88,00 mm)

01.110.10	88,25 mm
01.110.20	88,50 mm
01.110.30	88,75 mm
01.110.40	89,00 mm



2.50x2,50x4,00  
8 680437 015994

**01.136.00** Ring (Ø88,00 mm)

01.136.10	88,25 mm
01.136.20	88,50 mm
01.136.30	88,75 mm
01.136.40	89,00 mm



2.50x2,50x4,00  
8 680437 018384 **OEM No** : 1409318  
**Knorr No** : II39526F0061

**RK.01.083.20** Repair Kit



8 680437 076964 **Knorr No** : SEB22561\*

**RK.01.126** Repair Kit

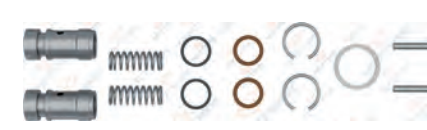

8 680437 060642 **OEM No** : 1376279  
**Knorr No** : II159920063

**01.1484** Gear



8 680437 074625 **OEM No** : 1775248 - 1732078

**RK.01.088** Repair Kit



8 680437 059943 **OEM No** : 3097145

**RK.01.088.20** Repair Kit



8 680437 124177 **OEM No** : 1376280  
**Knorr No** : II326840061

## Twin Cylinder Compressor Ø88 mm-600 CC-Stroke 50 mm

Application - Vehicle  
SCANIA 124 / 340 SERIE 4  
Santrifüj / Centrifugal



**01.04.074.01**

**Oem. No.**

1796663  
1514064  
1470304  
1380457  
571287  
1512834  
1784109  
1770607

**Knorr No.**

LK4941-K016615000  
LP4965-K016615ES



**01.758**

Crankcase



**RK.01.083**

Repair Kit

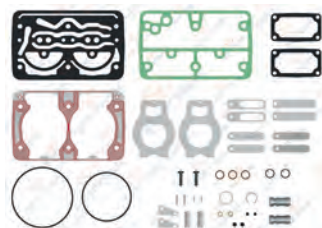

Knorr No : SEB22596

**RK.01.083.03**

Repair Kit

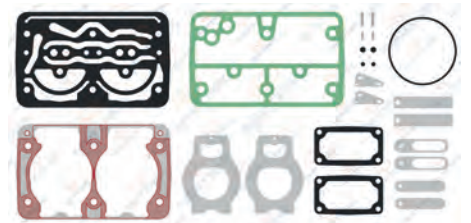

**RK.01.276**

Complete Cylinder Head



**RK.01.276.20**

Complete Cylinder Head

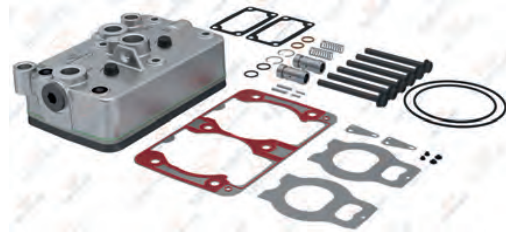

**RK.01.082.20**

Valve Plate Kit

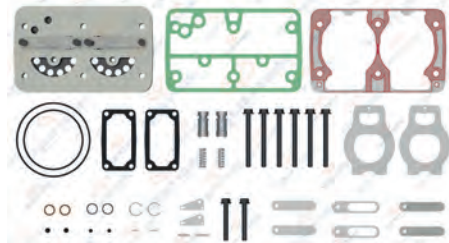

**RK.01.082**

Valve Plate Kit

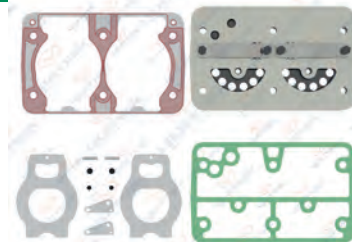

**RK.01.083.01**

Repair Kit

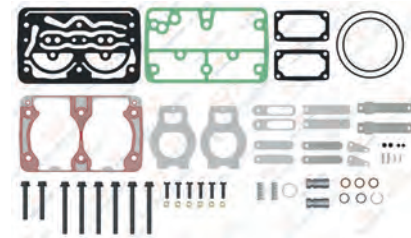

01.363

Cylinder Head



8 680437 021629 **OEM No** : 1424766  
**Knorr No** : SEB01444004

01.812

Crankshaft Flange



8 680437 026969 **OEM No** : 1932013  
**Knorr No** : K036087K50

01.813

Crankshaft



8 680437 026976

RK.01.082.02

Valve Plate Kit



8 680437 112679 **OEM No** : 1376272  
**Knorr No** : SEB01033004

01.292

Bushing



42X38X25  
8 680437 073871

01.226

Connecting Rod



8 680437 019824 **Knorr No** : SEB00967004

RK.01.034.00

Piston&Ring (Ø88,00 mm)

- RK.01.034.10 88,25 mm
- RK.01.034.20 88,50 mm
- RK.01.034.30 88,75 mm
- RK.01.034.40 89,00 mm



2.50x2,50x4,00  
8 680437 058616 **Knorr No** : I81169004 - SEB22555

01.110.00

Piston (Ø88,00 mm)

- 01.110.10 88,25 mm
- 01.110.20 88,50 mm
- 01.110.30 88,75 mm
- 01.110.40 89,00 mm



2.50x2,50x4,00  
8 680437 015994

01.136.00

Ring (Ø88,00 mm)

- 01.136.10 88,25 mm
- 01.136.20 88,50 mm
- 01.136.30 88,75 mm
- 01.136.40 89,00 mm



2.50x2,50x4,00  
8 680437 018384 **OEM No** : 1409318  
**Knorr No** : II39526F0061

RK.01.083.20

Repair Kit

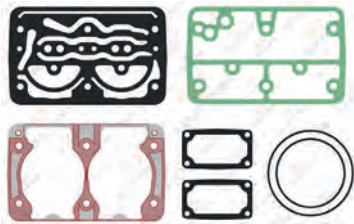

8 680437 076964 **Knorr No** : SEB22561\*

RK.01.126

Repair Kit



8 680437 060642 **OEM No** : 1376279  
**Knorr No** : II159920063

01.1916

Connecting Rod



8 680437 164265

RK.01.088

Repair Kit



8 680437 059943 **OEM No** : 3097145

RK.01.088.20

Repair Kit



8 680437 124177 **OEM No** : 1376280  
**Knorr No** : II326840061



## Twin Cylinder Compressor Ø88 mm-608 CC-Stroke 50 mm

### Application - Vehicle

SCANIA 124/4 - 550 / 40.365 / C210  
D9, D11, D12, D12A, D13, DC9, DC9A, DC11,  
DC12, DC13, DSC1205, DSC12, SG9, K94



### 01.04.021

#### Oem. No.

1380455  
1470303  
1514063  
571286

#### Knorr No.

LP4964-K002046X00



8 680437 010944



### 01.311

#### Crankcase



8 680437 020899

### RK.01.083

#### Repair Kit

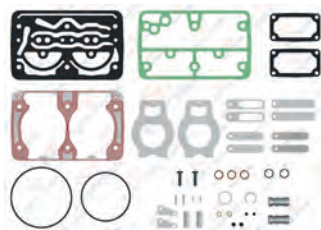

8 680437 059820

Knorr No : SEB22596

### RK.01.083.03

#### Repair Kit

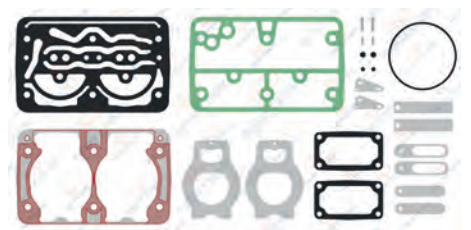

8 680437 059851

### RK.01.276

#### Complete Cylinder Head

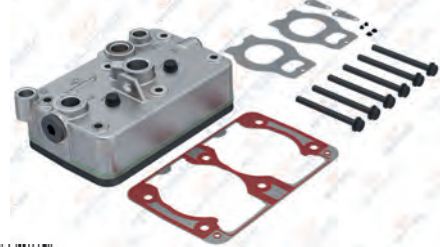

8 680437 063285

### RK.01.276.20

#### Complete Cylinder Head

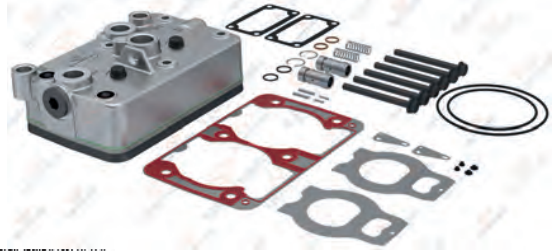

8 680437 072768

### RK.01.082.20

#### Valve Plate Kit

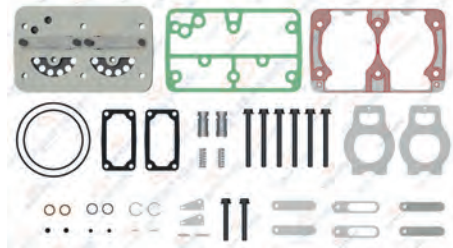

8 680437 073574

### RK.01.082

#### Valve Plate Kit

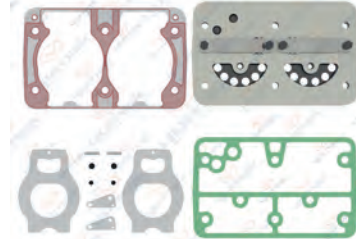

8 680437 059813

### RK.01.083.01

#### Repair Kit

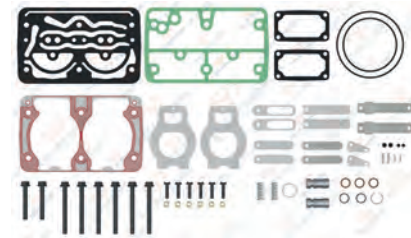

8 680437 059844

**01.363** Cylinder Head



8 680437 021629 **OEM No** : 1424766  
**Knorr No** : SEB01444004

**01.288** Crankshaft Flange



8 680437 020615 **OEM No** : 1376275  
**Knorr No** : SEB013090065

**01.282** Crankshaft



8 680437 020509

**RK.01.082.02** Valve Plate Kit



8 680437 112679 **OEM No** : 1376272  
**Knorr No** : SEB01033004

**01.414** Cover



8 680437 022312

**01.226** Connecting Rod



8 680437 019824 **Knorr No** : SEB00967004

**RK.01.034.00** Piston&Ring (Ø88,00 mm)

- RK.01.034.10** 88,25 mm
- RK.01.034.20** 88,50 mm
- RK.01.034.30** 88,75 mm
- RK.01.034.40** 89,00 mm



2.50x2,50x4,00 **Knorr No** : I81169004 - SEB22555  
8 680437 058616

**01.110.00** Piston (Ø88,00 mm)

- 01.110.10** 88,25 mm
- 01.110.20** 88,50 mm
- 01.110.30** 88,75 mm
- 01.110.40** 89,00 mm



2.50x2,50x4,00  
8 680437 015994

**01.136.00** Ring (Ø88,00 mm)

- 01.136.10** 88,25 mm
- 01.136.20** 88,50 mm
- 01.136.30** 88,75 mm
- 01.136.40** 89,00 mm



2.50x2,50x4,00 **OEM No** : 1409318  
**Knorr No** : I139526F0061  
8 680437 018384

**RK.01.083.20** Repair Kit

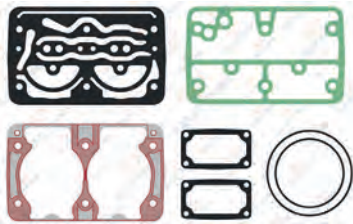

8 680437 076964 **Knorr No** : SEB22561\*

**RK.01.126** Repair Kit



8 680437 060642 **OEM No** : 1376279  
**Knorr No** : I1159920063

**01.1484** Gear



8 680437 074625 **OEM No** : 1775248 - 1732078

**RK.01.088** Repair Kit



8 680437 059943 **OEM No** : 3097145

**RK.01.088.20** Repair Kit



8 680437 124177 **OEM No** : 1376280  
**Knorr No** : I1326840061



## Twin Cylinder Compressor Ø88 mm-600 CC-Stroke 50 mm

Application - Vehicle  
SCANIA



**01.04.054**

Oem. No.  
1379066

Knorr No.  
LP4966-II32689



**01.993**

Crankcase



**RK.01.083**

Repair Kit

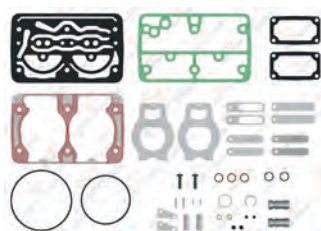

Knorr No : SEB22596

**RK.01.083.03**

Repair Kit



**RK.01.276**

Complete Cylinder Head

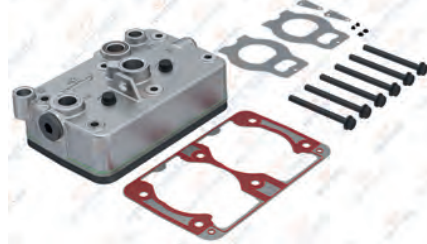

**RK.01.276.20**

Complete Cylinder Head

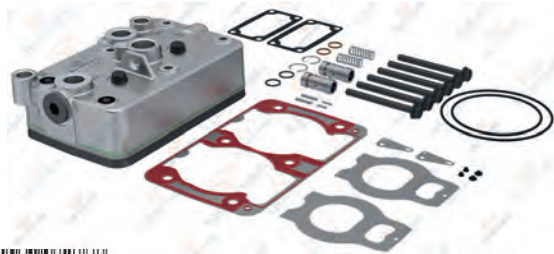

**RK.01.082.20**

Valve Plate Kit

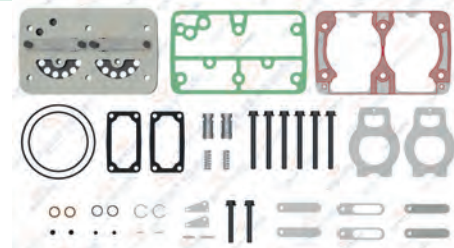

**RK.01.082**

Valve Plate Kit

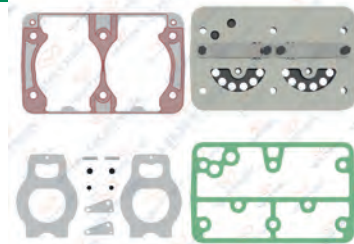

**RK.01.083.01**

Repair Kit

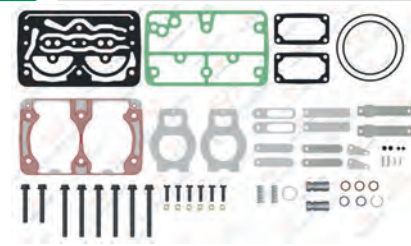



01.363

Cylinder Head



OEM No : 1424766  
Knorr No : SEB01444004

01.812

Crankshaft Flange



OEM No : 1932013  
Knorr No : K036087K50

01.813

Crankshaft



RK.01.082.02

Valve Plate Kit



OEM No : 1376272  
Knorr No : SEB01033004

RK.01.807

Connecting Rod & Piston



01.226

Connecting Rod



Knorr No : SEB00967004

RK.01.034.00

Piston&Ring (Ø88,00 mm)

- RK.01.034.10 88,25 mm
- RK.01.034.20 88,50 mm
- RK.01.034.30 88,75 mm
- RK.01.034.40 89,00 mm



2.50x2,50x4,00



Knorr No : I81169004 - SEB22555

01.110.00

Piston (Ø88,00 mm)

- 01.110.10 88,25 mm
- 01.110.20 88,50 mm
- 01.110.30 88,75 mm
- 01.110.40 89,00 mm



2.50x2,50x4,00



01.136.00

Ring (Ø88,00 mm)

- 01.136.10 88,25 mm
- 01.136.20 88,50 mm
- 01.136.30 88,75 mm
- 01.136.40 89,00 mm



2.50x2,50x4,00



OEM No : 1409318  
Knorr No : I139526F0061

RK.01.126

Repair Kit



OEM No : 1376279  
Knorr No : I1159920063

01.414

Cover



01.292

Bushing



42X38X25



RK.01.083.20

Repair Kit

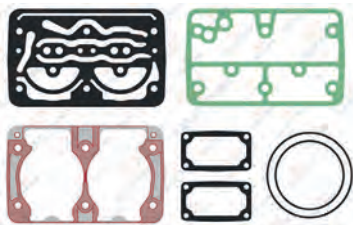

Knorr No : SEB22561\*

RK.01.088

Repair Kit



OEM No : 3097145

RK.01.088.20

Repair Kit



OEM No : 1376280  
Knorr No : I1326840061

## Twin Cylinder Compressor 608 CC

Application - Vehicle  
SCANIA



**01.04.176**

Oem. No.  
1375862

Knorr No.  
LP4962-II31955



**01.311**

Crankcase



**RK.01.083**

Repair Kit

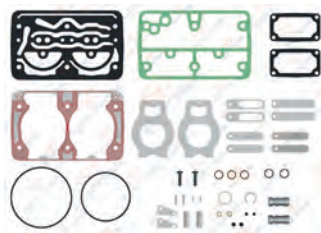

Knorr No : SEB22596

**RK.01.083.03**

Repair Kit

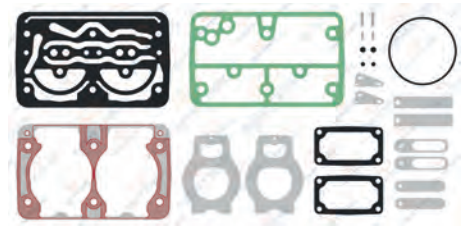

**RK.01.276**

Complete Cylinder Head



**RK.01.276.20**

Complete Cylinder Head

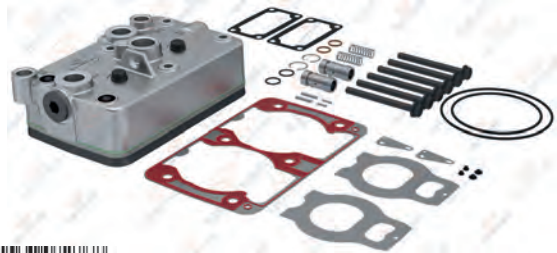

**RK.01.082.20**

Valve Plate Kit

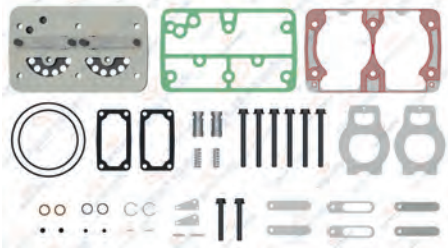

**RK.01.082**

Valve Plate Kit

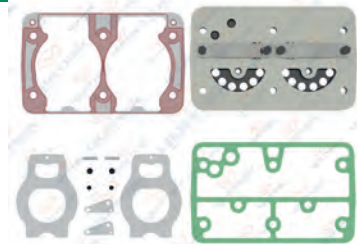

**RK.01.083.01**

Repair Kit

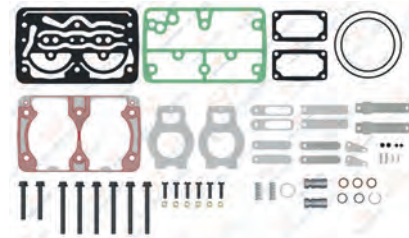

**01.363** Cylinder Head



8 680437 021629 **OEM No** : 1424766  
**Knorr No** : SEB01444004

**01.288** Crankshaft Flange



8 680437 020615 **OEM No** : 1376275  
**Knorr No** : SEB013090065

**01.282** Crankshaft



8 680437 020509

**RK.01.082.02** Valve Plate Kit



8 680437 112679 **OEM No** : 1376272  
**Knorr No** : SEB01033004

**RK.01.807** Connecting Rod & Piston



8 680437 114598

**01.226** Connecting Rod



8 680437 019824 **Knorr No** : SEB00967004

**RK.01.034.00** Piston&Ring (Ø88,00 mm)

RK.01.034.10	88,25 mm
RK.01.034.20	88,50 mm
RK.01.034.30	88,75 mm
RK.01.034.40	89,00 mm



2.50x2,50x4,00 **Knorr No** : I81169004 - SEB22555  
8 680437 058616

**01.110.00** Piston (Ø88,00 mm)

01.110.10	88,25 mm
01.110.20	88,50 mm
01.110.30	88,75 mm
01.110.40	89,00 mm



2.50x2,50x4,00  
8 680437 015994

**01.136.00** Ring (Ø88,00 mm)

01.136.10	88,25 mm
01.136.20	88,50 mm
01.136.30	88,75 mm
01.136.40	89,00 mm

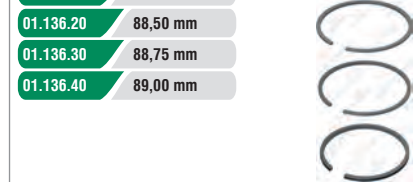

2.50x2,50x4,00 **OEM No** : 1409318  
**Knorr No** : I139526F0061  
8 680437 018384

**RK.01.126** Repair Kit



8 680437 060642 **OEM No** : 1376279  
**Knorr No** : I1159920063

**01.414** Cover



8 680437 022312

**01.292** Bushing



42X38X25  
8 680437 073871

**RK.01.083.20** Repair Kit



8 680437 076964 **Knorr No** : SEB22561\*

**RK.01.088** Repair Kit



8 680437 059943 **OEM No** : 3097145

**RK.01.088.20** Repair Kit



8 680437 124177 **OEM No** : 1376280  
**Knorr No** : I1326840061



## Twin Cylinder Compressor 608 CC

Application - Vehicle  
SCANIA



**01.04.111**

Knorr No.  
LP4936-II16243



**01.1578** Crankcase



**RK.01.083.03** Repair Kit

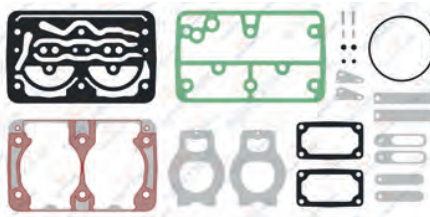

**RK.01.083.20** Repair Kit

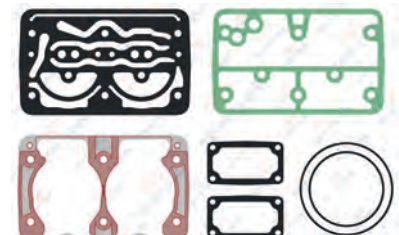

Knorr No : SEB22561\*

**RK.01.746**

Complete Cylinder Head

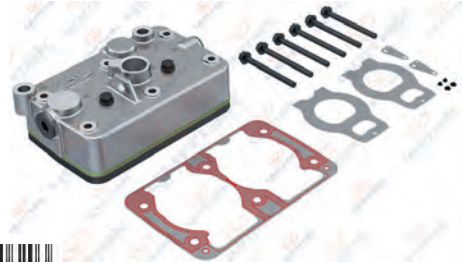

**RK.01.082.20**

Valve Plate Kit

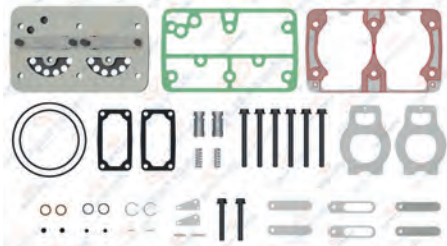

**RK.01.082**

Valve Plate Kit

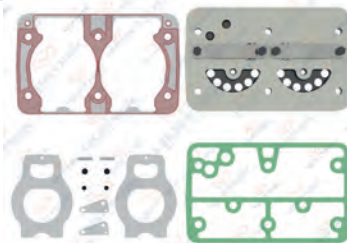

**RK.01.083.01**

Repair Kit

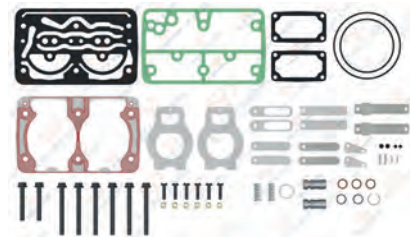

**RK.01.083**

Repair Kit

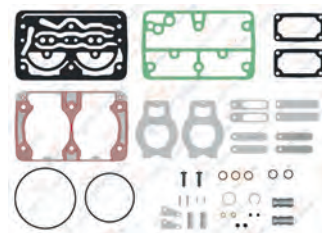

Knorr No : SEB22596

**01.1624** Cylinder Head



8 680437 102151

**RK.01.082.02** Valve Plate Kit



OEM No : 1376272  
Knorr No : SEB01033004

**01.1579** Crankshaft



M20X1.5 Right Hand



8 680437 109624

**RK.01.807** Connecting Rod & Piston



8 680437 114598

**01.288** Crankshaft Flange



8 680437 020615

**01.226** Connecting Rod



Knorr No: SEB00967004

**RK.01.034.00** Piston&Ring (Ø88,00 mm)

- RK.01.034.10 88,25 mm
- RK.01.034.20 88,50 mm
- RK.01.034.30 88,75 mm
- RK.01.034.40 89,00 mm



2.50x2,50x4,00



Knorr No: I81169004 - SEB22555

**01.110.00** Piston (Ø88,00 mm)

- 01.110.10 88,25 mm
- 01.110.20 88,50 mm
- 01.110.30 88,75 mm
- 01.110.40 89,00 mm



2.50x2,50x4,00



8 680437 015994

**01.136.00** Ring (Ø88,00 mm)

- 01.136.10 88,25 mm
- 01.136.20 88,50 mm
- 01.136.30 88,75 mm
- 01.136.40 89,00 mm



2.50x2,50x4,00



OEM No : 1409318  
Knorr No: I139526F0061

**01.414** Cover



8 680437 022312

**01.292** Bushing



42X38X25



8 680437 073871

**01.144** Nut



M20X1.5 Right Hand



OEM No : 464642

**RK.01.126** Repair Kit



8 680437 060642

OEM No : 1376279  
Knorr No: I1159920063

**RK.01.088** Repair Kit



8 680437 059943

OEM No : 3097145

**RK.01.088.20** Repair Kit



8 680437 124177

OEM No : 1376280  
Knorr No: I1326840061

## Twin Cylinder Compressor Ø88 mm-600 CC-Stroke 50 mm

Application - Vehicle  
SCANIA 124/4

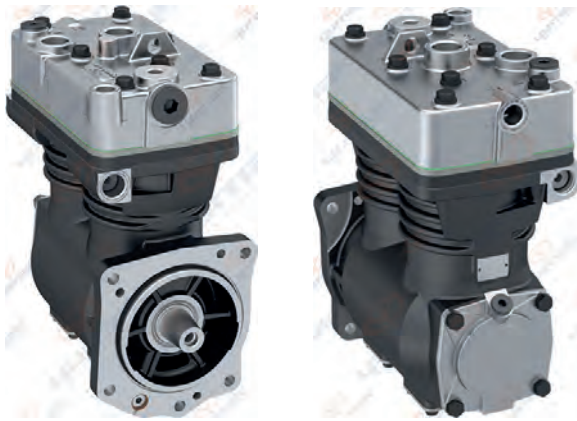

**01.04.038**

Knorr No.  
LP4963-II32686



**01.311**

Crankcase



**RK.01.083.03**

Repair Kit

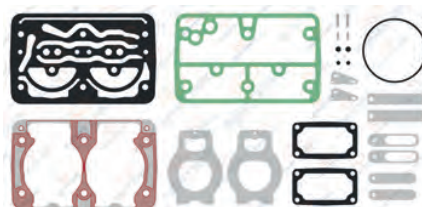

**RK.01.083.06**

Repair Kit

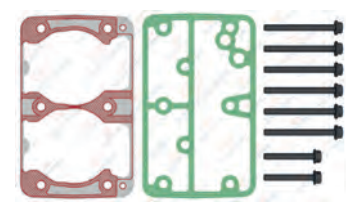

OEM No : 3097143  
Knorr No : II159920051

**RK.01.325**

Complete Cylinder Head



**RK.01.325.20**

Complete Cylinder Head



**RK.01.082**

Valve Plate Kit

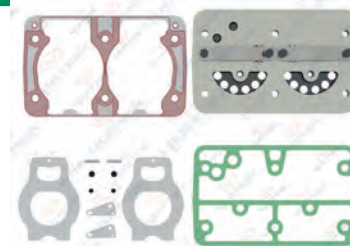

**RK.01.083.01**

Repair Kit

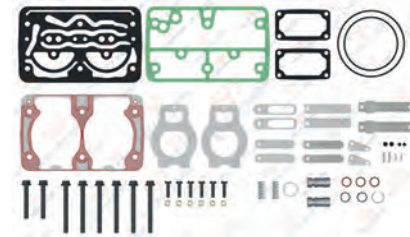

**RK.01.083**

Repair Kit



Knorr No : SEB22596



**01.815** Cylinder Head



8 680437 026990 **OEM No :** 1376274  
**Knorr No:** SEB01106004

**RK.01.082.02** Valve Plate



8 680437 112679 **OEM No :** 1376272  
**Knorr No :** SEB01033004

**01.282** Crankshaft



8 680437 020509

**RK.01.325.01** Complete Cylinder Head

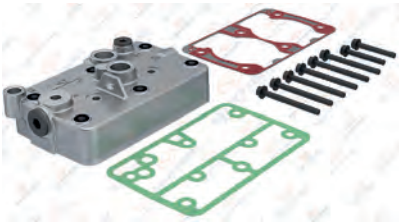

8 680437 127789 **Knorr No:** K034585K50

**01.288** Crankshaft Flange

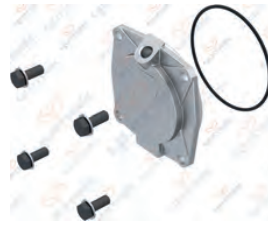

8 680437 020615 **OEM No :** 1376275  
**Knorr No:** SEB013090065

**01.226** Connecting Rod



8 680437 019824 **Knorr No:** SEB00967004

**RK.01.034.00** Piston&Ring (Ø88,00 mm)

- RK.01.034.10** 88,25 mm
- RK.01.034.20** 88,50 mm
- RK.01.034.30** 88,75 mm
- RK.01.034.40** 89,00 mm



2.50x2,50x4,00 **Knorr No:** I81169004 - SEB22555  
8 680437 058616

**01.110.00** Piston (Ø88,00 mm)

- 01.110.10** 88,25 mm
- 01.110.20** 88,50 mm
- 01.110.30** 88,75 mm
- 01.110.40** 89,00 mm



2.50x2,50x4,00  
8 680437 015994

**01.136.00** Ring (Ø88,00 mm)

- 01.136.10** 88,25 mm
- 01.136.20** 88,50 mm
- 01.136.30** 88,75 mm
- 01.136.40** 89,00 mm



2.50x2,50x4,00 **OEM No :** 1409318  
**Knorr No:** I139526F0061  
8 680437 018384

**RK.01.088** Repair Kit



8 680437 059943 **OEM No :** 3097145

**01.414** Cover



8 680437 022312

**01.292** Bushing



42x38x25  
8 680437 073871

**RK.01.126** Repair Kit



8 680437 060642 **OEM No:** 1376279  
**Knorr No:** I1159920063

## Twin Cylinder Compressor Ø88 mm-600 CC-Stroke 50 mm

Application - Vehicle  
SCANIA 144 / 440 / 365

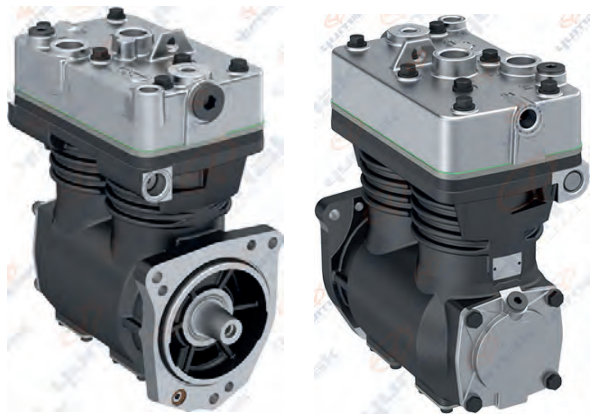

**01.04.039**

**Oem. No.**

1349094  
571188  
1513115  
1531073

**Knorr No.**

LP4957  
K002975000  
II17395X00



**01.763**

Crankcase



**RK.01.083.03**

Repair Kit

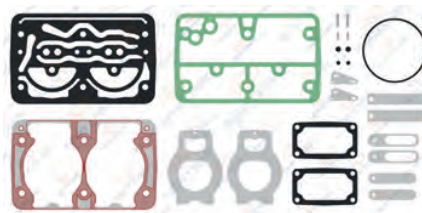

**RK.01.083.06**

Repair Kit

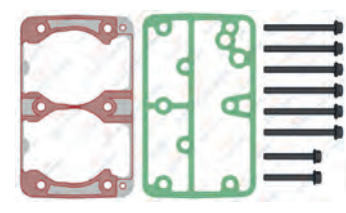

OEM No : 3097143  
Knorr No : II159920051

**RK.01.325**

Complete Cylinder Head



**RK.01.325.20**

Complete Cylinder Head



**RK.01.082**

Valve Plate Kit

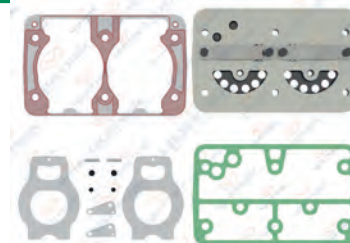

**RK.01.083.01**

Repair Kit

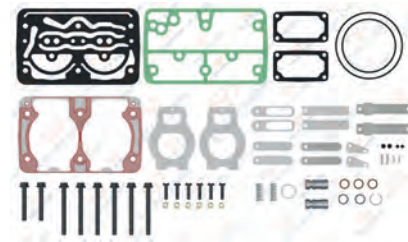

**RK.01.083**

Repair Kit

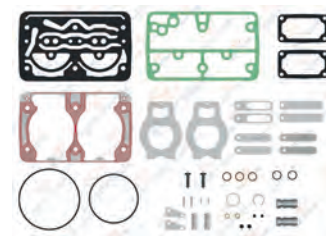

Knorr No : SEB22596

**01.815** Cylinder Head



8 680437 026990 **OEM No :** 1376274  
**Knorr No:** SEB01106004

**RK.01.082.02** Valve Plate



8 680437 112679 **OEM No :** 1376272  
**Knorr No :** SEB01033004

**01.282** Crankshaft



8 680437 020509

**RK.01.325.01** Complete Cylinder Head

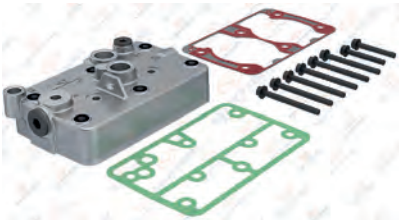

8 680437 127789 **Knorr No:** K034585K50

**01.288** Crankshaft Flange



8 680437 020615 **OEM No :** 1376275  
**Knorr No:** SEB013090065

**01.226** Connecting Rod



8 680437 019824 **Knorr No:** SEB00967004

**RK.01.034.00** Piston&Ring (Ø88,00 mm)

- RK.01.034.10** 88,25 mm
- RK.01.034.20** 88,50 mm
- RK.01.034.30** 88,75 mm
- RK.01.034.40** 89,00 mm



2.50x2,50x4,00 **Knorr No:** I81169004 - SEB22555  
8 680437 058616

**01.110.00** Piston (Ø88,00 mm)

- 01.110.10** 88,25 mm
- 01.110.20** 88,50 mm
- 01.110.30** 88,75 mm
- 01.110.40** 89,00 mm



2.50x2,50x4,00  
8 680437 015994

**01.136.00** Ring (Ø88,00 mm)

- 01.136.10** 88,25 mm
- 01.136.20** 88,50 mm
- 01.136.30** 88,75 mm
- 01.136.40** 89,00 mm



2.50x2,50x4,00 **OEM No :** 1409318  
**Knorr No:** I139526F0061  
8 680437 018384

**01.414** Cover



8 680437 022312

**01.292** Bushing



42X38X25  
8 680437 073871

**RK.01.126** Repair Kit



8 680437 060642 **OEM No:** 1376279  
**Knorr No:** I1159920063



## Twin Cylinder Compressor Ø75 mm-440 CC-Stroke 50 mm

Application - Vehicle  
SCANIA 82 / 92 / 93 / 141 / 112 / 113

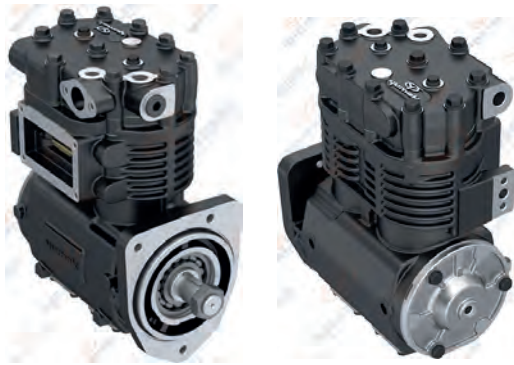

### 01.05.011

Oem. No.	Knorr No.
1189107	KZ996/2-KZ996/2X50
301525	
1314107	
1348920	
571044	



### 01.062 Crankcase



### RK.01.186 Repair Kit

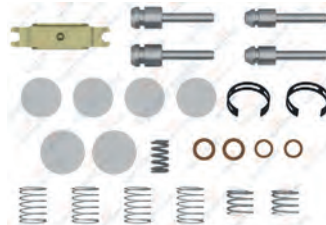

### RK.01.492 Complete Cylinder Head



### RK.01.239 Valve Plate Kit

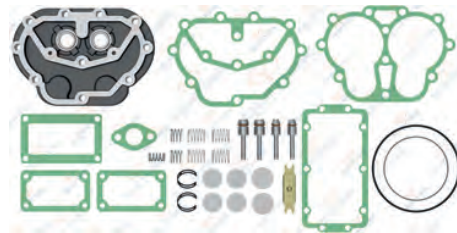

### RK.01.052.01 Repair Kit

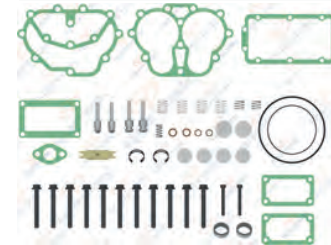

### RK.01.052 Repair Kit

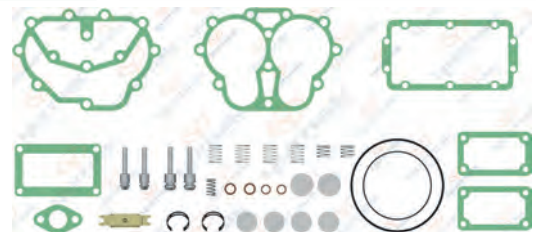

OEM No : 1327886

### RK.01.052.02 Repair Kit

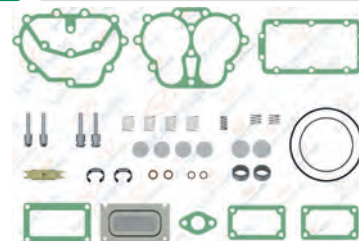

### RK.01.077 Repair Kit



### 01.743 Cylinder Head



8 680437 026105

### 01.021 Crankshaft Flange



OEM No : 1322816

### 01.100 Crankshaft



M22X1.5 Right Hand



OEM No: 232056

### 01.127 Valve Plate



OEM No : 1322813

### RK.01.805 Connecting Rod & Piston



8 680437 114574

### 01.009 Connecting Rod



OEM No : 1194119 - 1518356  
1322814

### RK.01.075.00 Piston&Ring (Ø75,00 mm)

- RK.01.075.10 75,25 mm
- RK.01.075.20 75,50 mm
- RK.01.075.30 75,75 mm
- RK.01.075.40 76,00 mm



2.385x2.385x3.947



OEM No : 1103236  
Knorr No : 1189082SP

### 01.116.00 Piston (Ø75,00 mm)

- 01.116.10 75,25 mm
- 01.116.20 75,50 mm
- 01.116.30 75,75 mm
- 01.116.40 76,00 mm



2.385x2.385x3.947



OEM No: 1354863 - 1367344  
1367345

### 01.141.00 Ring (Ø75,00 mm)

- 01.141.10 75,25 mm
- 01.141.20 75,50 mm
- 01.141.30 75,75 mm
- 01.141.40 76,00 mm



2.385x2.385x3.947



OEM No: 1354862 - 1367375  
1367376

### 01.579 Nut



M22X1.5 Right Hand



OEM No: 39949

### 00.266 Roller Bearing



6207



OEM No: 14091

### 01.079 Cover



8 680437 014232

### 01.017X2 Bushing



8 680437 080091

### 01.018 Bushing



39X35X25



8 680437 077220

## Twin Cylinder Compressor Ø75 mm-440 CC-Stroke 50 mm

**Application - Vehicle**  
SCANIA 112 / 113 / 141 / KZ 642.2 /  
R112 / R113 / P113 / R141 / R143

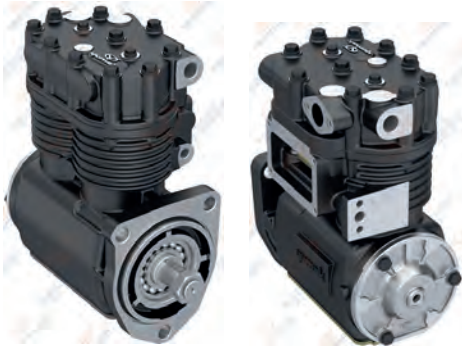

### 01.05.015

Oem. No.	Knorr No.
1348919	KZ642/2-KZ642/2X50
571185	
571043	
300162	



### 01.259 Crankcase



### RK.01.052 Repair Kit

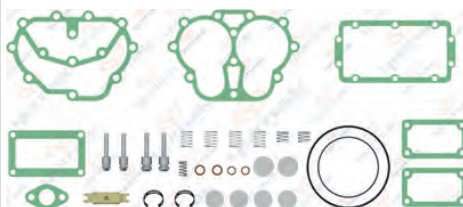

### RK.01.077 Repair Kit



### RK.01.238 Complete Cylinder Head



### RK.01.238.20 Complete Cylinder Head

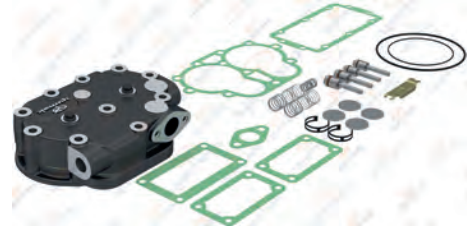

### RK.01.239 Valve Plate Kit

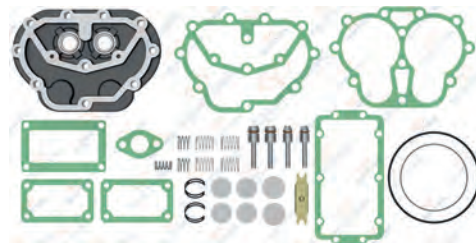

### RK.01.052.01 Repair Kit

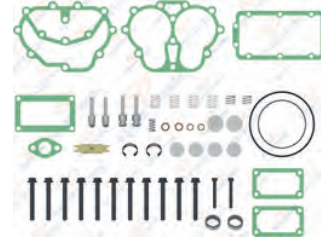

### RK.01.052.02 Repair Kit

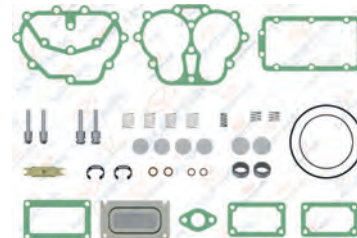



01.081

Cylinder Head



OEM No : 280676  
Knorr No: KZ6451SP

01.021

Crankshaft Flange



OEM No: 1322816

01.100

Crankshaft



M22X1.5 Right Hand



OEM No: 232056

01.127

Valve Plate



OEM No: 1322813

RK.01.805

Connecting Rod & Piston



01.009

Connecting Rod



OEM No: 1194119 - 1518356  
1322814

RK.01.075.00

Piston&Ring (Ø75,00 mm)

- RK.01.075.10 75,25 mm
- RK.01.075.20 75,50 mm
- RK.01.075.30 75,75 mm
- RK.01.075.40 76,00 mm



2.385x2.385x3.947



OEM No: 1103236  
Knorr No: 1189082SP

01.116.00

Piston (Ø75,00 mm)

- 01.116.10 75,25 mm
- 01.116.20 75,50 mm
- 01.116.30 75,75 mm
- 01.116.40 76,00 mm



2.385x2.385x3.947



OEM No: 1354863 - 1367344  
1367345

01.141.00

Ring (Ø75,00 mm)

- 01.141.10 75,25 mm
- 01.141.20 75,50 mm
- 01.141.30 75,75 mm
- 01.141.40 76,00 mm



2.385x2.385x3.947



OEM No: 1354862 - 1367375  
1367376

01.579

Nut



M22X1.5 Right Hand



OEM No: 39949

00.266

Roller Bearing



6207



OEM No: 14091

01.285

Cover



RK.01.186

Repair Kit



01.017X2

Bushing



01.018

Bushing



39X35X25



## Twin Cylinder Compressor Ø75 mm-440 CC

Application - Vehicle  
SCANIA

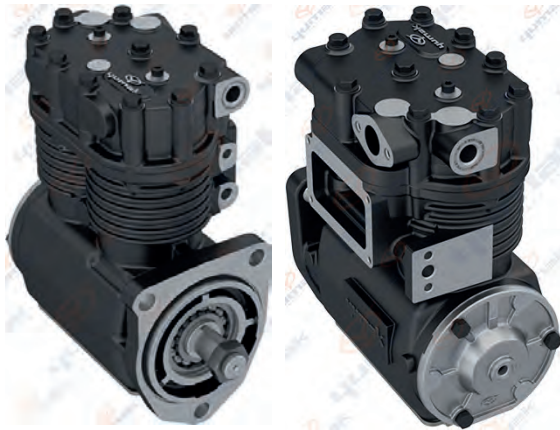

**01.05.049**

Oem. No.  
1327231  
232615

Knorr No.  
KZ396/3-KZ396/3X50



**01.1310**

Crankcase



**RK.01.052**

Repair Kit

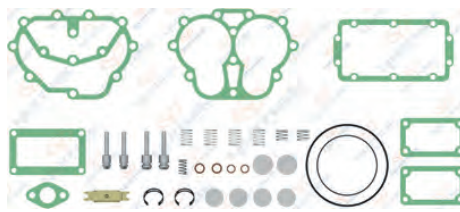

OEM No: 1327886

**RK.01.077**

Repair Kit



**RK.01.050.10**

Complete Cylinder Head



**RK.01.050.11**

Complete Cylinder Head



**RK.01.239**

Valve Plate Kit

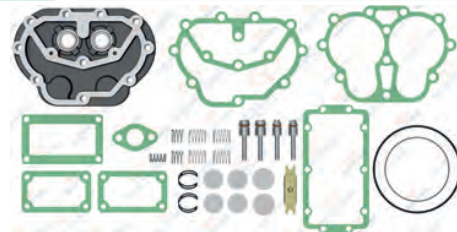

**RK.01.052.01**

Repair Kit



**RK.01.052.02**

Repair Kit

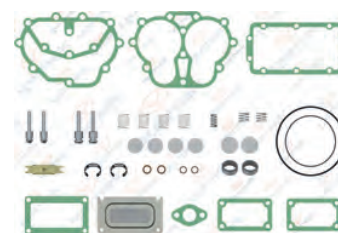

**01.078.10** Cylinder Head



8 680437 101415

**01.021** Crankshaft Flange



OEM No: 1322816

**01.100** Crankshaft



M22X1.5 Right Hand



OEM No: 232056

**01.127** Valve Plate



OEM No: 1322813

**RK.01.805** Connecting Rod & Piston



**01.009** Connecting Rod



OEM No: 1194119 - 1518356  
1322814

**RK.01.075.00** Piston&Ring (Ø75,00 mm)

- RK.01.075.10 75,25 mm
- RK.01.075.20 75,50 mm
- RK.01.075.30 75,75 mm
- RK.01.075.40 76,00 mm



2.385x2.385x3.947



OEM No: 1103236  
Knorr No: 1189082SP

**01.116.00** Piston (Ø75,00 mm)

- 01.116.10 75,25 mm
- 01.116.20 75,50 mm
- 01.116.30 75,75 mm
- 01.116.40 76,00 mm



2.385x2.385x3.947



OEM No: 1354863 - 1367344  
1367345

**01.141.00** Ring (Ø75,00 mm)

- 01.141.10 75,25 mm
- 01.141.20 75,50 mm
- 01.141.30 75,75 mm
- 01.141.40 76,00 mm



2.385x2.385x3.947



OEM No: 1354862 - 1367375  
1367376

**01.579** Nut



M22X1.5 Right Hand



OEM No: 39949

**00.266** Roller Bearing



6207



OEM No: 14091

**01.285** Cover



**RK.01.186** Repair Kit

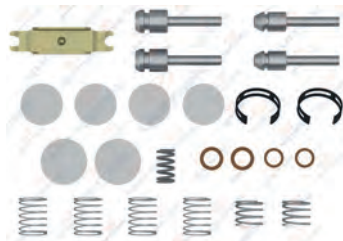

**01.017X2** Bushing



**01.018** Bushing



39X35X25





## Twin Cylinder Compressor Ø75 mm-440 CC-Stroke 50 mm

**Application - Vehicle**  
SCANIA 112 / 113 / 141 / KZ 642.2 /  
R112 / R113 / P113 / R141 / R143



**01.05.038**

Oem. No.	Knorr No.
1300366	KZ1228/1-KZ1228/1X50
571181	
1186720	
394441	



**01.027** Crankcase



**RK.01.052** Repair Kit

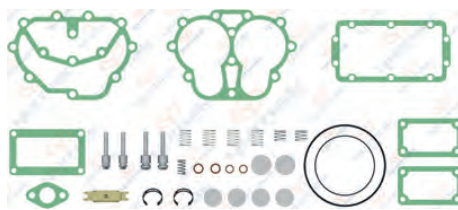

OEM No: 1327886

**RK.01.077** Repair Kit



**RK.01.238**

Complete Cylinder Head



**RK.01.238.20**

Complete Cylinder Head

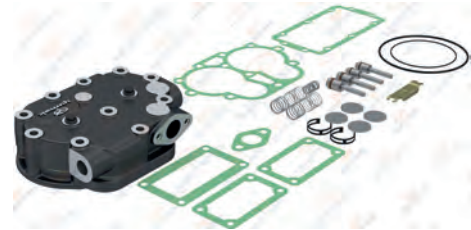

**RK.01.239**

Valve Plate Kit

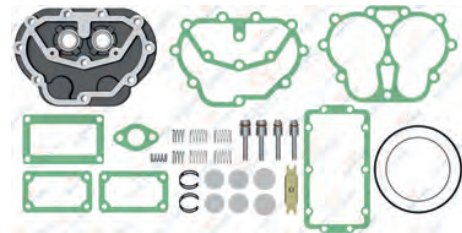

**RK.01.052.01**

Repair Kit

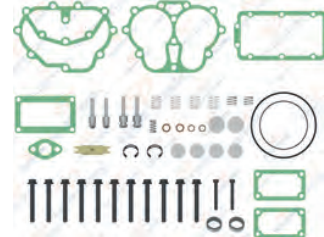

**RK.01.052.02**

Repair Kit

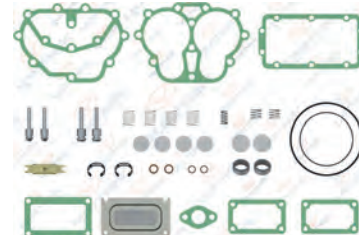

01.081

Cylinder Head



OEM No : 280676  
Knorr No: KZ6451SP

01.021

Crankshaft Flange



OEM No: 1322816

01.100

Crankshaft



M22X1.5 Right Hand



OEM No: 232056

01.127

Valve Plate

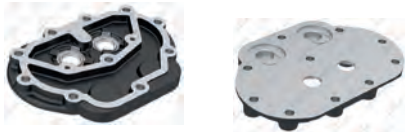

OEM No: 1322813

RK.01.805

Connecting Rod & Piston



01.009

Connecting Rod



OEM No: 1194119 - 1518356  
1322814

RK.01.075.00

Piston&Ring (Ø75,00 mm)

- RK.01.075.10 75,25 mm
- RK.01.075.20 75,50 mm
- RK.01.075.30 75,75 mm
- RK.01.075.40 76,00 mm



2.385x2.385x3.947



OEM No: 1103236  
Knorr No: 1189082SP

01.116.00

Piston (Ø75,00 mm)

- 01.116.10 75,25 mm
- 01.116.20 75,50 mm
- 01.116.30 75,75 mm
- 01.116.40 76,00 mm



2.385x2.385x3.947



OEM No: 1354863 - 1367344  
1367345

01.141.00

Ring (Ø75,00 mm)

- 01.141.10 75,25 mm
- 01.141.20 75,50 mm
- 01.141.30 75,75 mm
- 01.141.40 76,00 mm



2.385x2.385x3.947



OEM No: 1354862 - 1367375  
1367376

01.579

Nut



M22X1.5 Right Hand



OEM No: 39949

00.266

Roller Bearing



6207



OEM No: 14091

01.285

Cover



RK.01.186

Repair Kit



01.017X2

Bushing



01.018

Bushing



39X35X25



## Twin Cylinder Compressor Ø75 mm-440 CC-Stroke 50 mm

Application - Vehicle  
SCANIA SERIES G93 / P93 / R93  
R143 / 113 / 143 / 93 BUS



**01.05.017**

Oem. No.	Knorr No.
571183	LP4814-I97492000
1571183	
1303226	
303226	



**RK.01.493**

Complete Cylinder Head



**RK.01.493.20**

Complete Cylinder Head



**RK.01.076.20**

Valve Plate Kit



OEM No: 1409317

**RK.01.076**

Valve Plate Kit

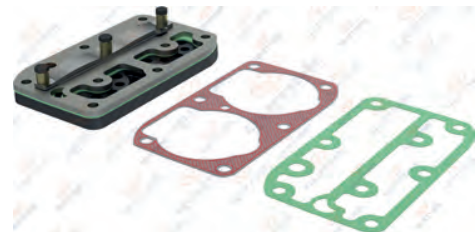

**RK.01.078.01**

Repair Kit

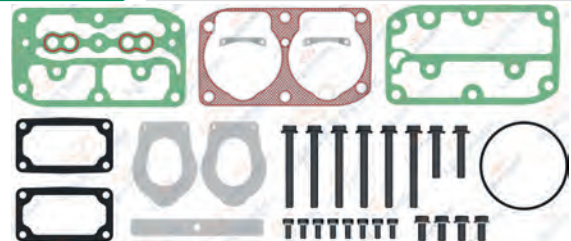

Knorr No : SEB22541

**01.221**

Crankcase



**RK.01.078**

Repair Kit

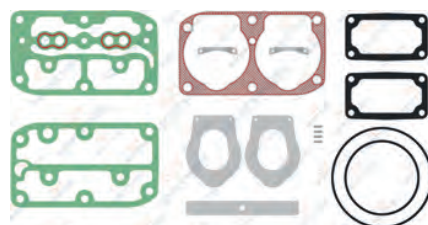

**RK.01.078.20**

Repair Kit

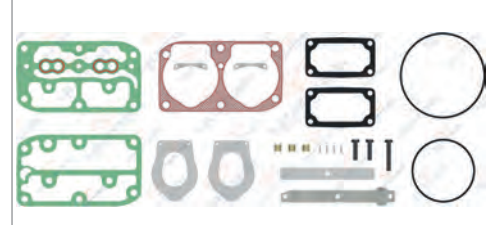



**01.709** Cylinder Head



8 680437 025764  
**OEM No** : 1315299  
**Knorr No** : SEB22587

**01.220** Crankshaft Flange



8 680437 019756  
**OEM No** : 1315292  
**Knorr No** : SEB00387004

**01.219** Crankshaft



**M20X1.5 Right Hand**  
 8 680437 019732  
**OEM No** : 1315290  
**Knorr No** : EB007622V

**RK.01.076.02** Valve Plate Kit



8 680437 112730  
**OEM No** : 1697770  
**Knorr No** : I81015004

**RK.01.808** Connecting Rod & Piston



8 680437 114604

**01.218** Connecting Rod



8 680437 019725  
**OEM No** : 1315278  
**Knorr No** : SEB00626004 - SEB00957004

**RK.01.073.00** Piston&Ring (Ø75,00 mm)

- RK.01.073.10 75,25 mm
- RK.01.073.20 75,50 mm
- RK.01.073.30 75,75 mm
- RK.01.073.40 76,00 mm



2,00x2,00x4,00  
 8 680437 059547  
**OEM No** : 1315279 - 1315280  
**Knorr No** : SEB22539 - SEB22540

**01.193.00** Piston (Ø75,00 mm)

- 01.193.10 75,25 mm
- 01.193.20 75,50 mm
- 01.193.30 75,75 mm
- 01.193.40 76,00 mm



2,00x2,00x4,00  
 8 680437 019336

**01.134.00** Ring (Ø75,00 mm)

- 01.134.10 75,25 mm
- 01.134.20 75,50 mm
- 01.134.30 75,75 mm
- 01.134.40 76,00 mm



2,00x2,00x4,00  
 8 680437 018278  
**OEM No** : 1391384-1391385  
**Knorr No** : I801770061

**01.144** Nut



**M20X1.5 Right Hand**  
 8 680437 018742  
**Knorr No** : 1315273

**01.292** Bushing



**42X38X25**  
 8 680437 073871  
**OEM No** : 1315274

**01.414** Cover



8 680437 022312

**RK.01.078.24** Repair Kit

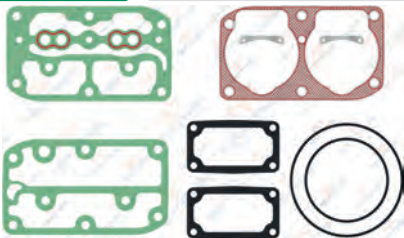

8 680437 121466  
**Knorr No** : SEB22542

**RK.01.057** Repair Kit



8 680437 059172

## Twin Cylinder Compressor Ø75 mm-440 CC-Stroke 50 mm

Application - Vehicle  
SCANIA 93 / 4 SERIES R113 / P113



**01.05.018**

Oem. No.  
571184  
1303227

Knorr No.  
LP4815-I97493000



**01.221**

Crankcase



**RK.01.078**

Repair Kit

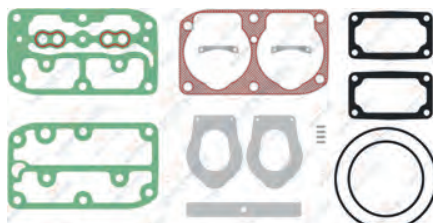

**RK.01.493** Complete Cylinder Head



**RK.01.493.20**

Complete Cylinder Head



**RK.01.076.20**

Valve Plate Kit



OEM No: 1409317

**RK.01.076**

Valve Plate Kit

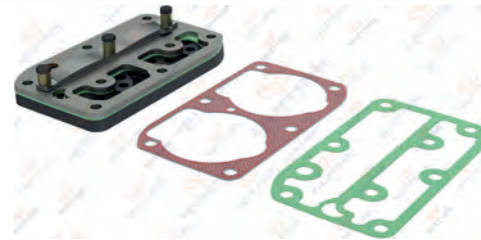

**RK.01.078.01**

Repair Kit

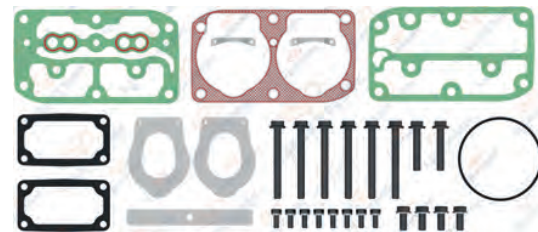

Knorr No : SEB22541

**RK.01.078.20**

Repair Kit

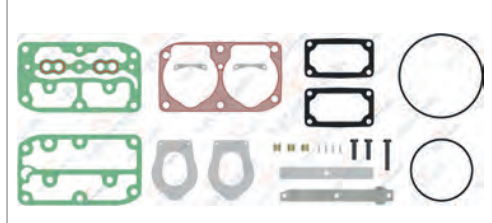

01.709

Cylinder Head



OEM No : 1315299  
Knorr No : SEB22587

01.220

Crankshaft Flange



OEM No : 1315292  
Knorr No : SEB00387004

01.219

Crankshaft



M20X1.5 Right Hand



OEM No : 1315290  
Knorr No : EB007622V

RK.01.076.02

Valve Plate Kit



OEM No : 1697770  
Knorr No : I81015004

RK.01.808

Connecting Rod & Piston



01.218

Connecting Rod



OEM No : 1315278  
Knorr No : SEB00626004 - SEB00957004

RK.01.073.00

Piston&Ring (Ø75,00 mm)

- RK.01.073.10 75,25 mm
- RK.01.073.20 75,50 mm
- RK.01.073.30 75,75 mm
- RK.01.073.40 76,00 mm



2,00x2,00x4,00



OEM No : 1315279 - 1315280  
Knorr No : SEB22539 - SEB22540

01.193.00

Piston (Ø75,00 mm)

- 01.193.10 75,25 mm
- 01.193.20 75,50 mm
- 01.193.30 75,75 mm
- 01.193.40 76,00 mm



2,00x2,00x4,00



01.134.00

Ring (Ø75,00 mm)

- 01.134.10 75,25 mm
- 01.134.20 75,50 mm
- 01.134.30 75,75 mm
- 01.134.40 76,00 mm



2,00x2,00x4,00



OEM No : 1391384-1391385  
Knorr No : I801770061

01.144

Nut



M20X1.5 Right Hand



Knorr No : 1315273

01.292

Bushing



42X38X25



OEM No: 1315274

01.414

Cover



RK.01.078.24

Repair Kit

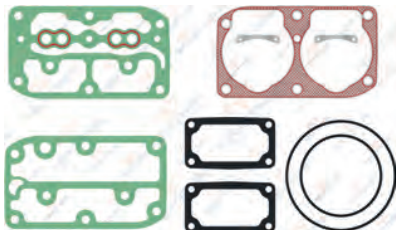

Knorr No : SEB22542

RK.01.057

Repair Kit





## Twin Cylinder Compressor Ø75 mm-440 CC-Stroke 50 mm

Application - Vehicle  
SCANIA 124 / SERIE 4 / 143



**01.05.048**

Knorr No.  
LP4844-II32842000



8 680437 012566



**01.754** Crankcase



8 680437 026228

**RK.01.078.20** Repair Kit

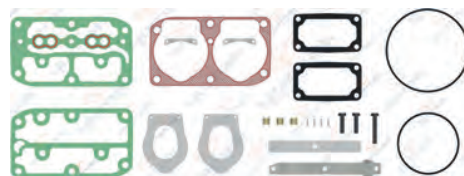

8 680437 120551

**RK.01.493** Complete Cylinder Head



8 680437 065821

**RK.01.076.03** Valve Plate Kit

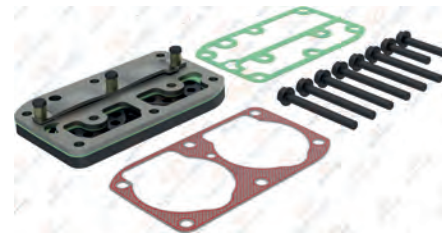

8 680437 112716

Knorr No : K070838K50

**RK.01.076** Valve Plate Kit

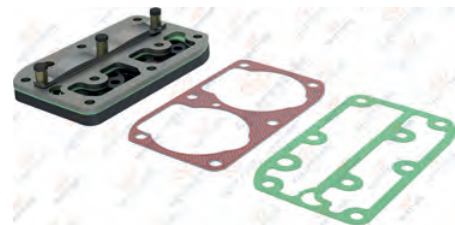

8 680437 059677

**RK.01.078.01** Repair Kit

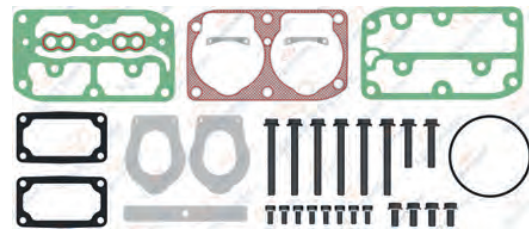

8 680437 059714

Knorr No: SEB22541

**RK.01.078** Repair Kit

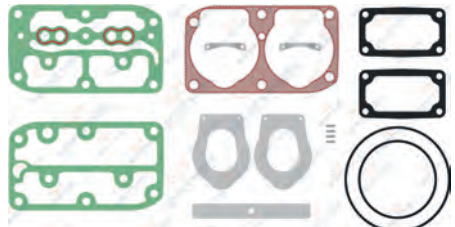

8 680437 059691

Repair Kit

**RK.01.078.24** Repair Kit

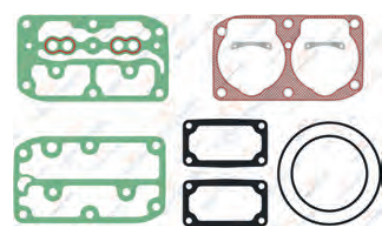

8 680437 121466

Knorr No: SEB22542

01.709

Cylinder Head



OEM No : 1315299  
Knorr No : SEB22587

01.220

Crankshaft Flange



OEM No : 1315292  
Knorr No : SEB00387004

01.219

Crankshaft



M20X1.5 Right Hand



OEM No : 1315290  
Knorr No : EB007622V

RK.01.076.02

Valve Plate Kit



OEM No : 1697770  
Knorr No : I81015004

01.292

Bushing



42X38X25



OEM No : 1315274

01.218

Connecting Rod



OEM No : 1315278  
Knorr No : SEB00626004 - SEB00957004

RK.01.073.00

Piston&Ring (Ø75,00 mm)

- RK.01.073.10 75,25 mm
- RK.01.073.20 75,50 mm
- RK.01.073.30 75,75 mm
- RK.01.073.40 76,00 mm



2,00x2,00x4,00



OEM No : 1315279 - 1315280  
Knorr No : SEB22539 - SEB22540

01.193.00

Piston (Ø75,00 mm)

- 01.193.10 75,25 mm
- 01.193.20 75,50 mm
- 01.193.30 75,75 mm
- 01.193.40 76,00 mm



2,00x2,00x4,00



01.134.00

Ring (Ø75,00 mm)

- 01.134.10 75,25 mm
- 01.134.20 75,50 mm
- 01.134.30 75,75 mm
- 01.134.40 76,00 mm



2,00x2,00x4,00



OEM No : 1391384  
Knorr No : I801770061

RK.01.057

Repair Kit



01.414

Cover



01.144

Nut



M20X1.5 Right Hand



Knorr No : 1315273

RK.01.078.04

Repair Kit

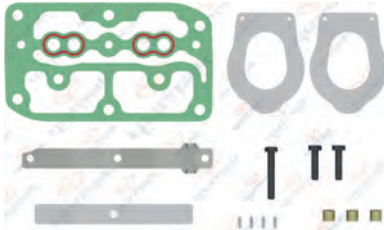

Knorr No : I810150061 - I8699

## Single Cylinder Compressor Ø88 mm-300 CC-Stroke 50 mm

Application - Vehicle  
SCANIA 4 SERIES TRUCK



**01.04.071**

Knorr No.  
LK3972-II34848



**01.085** Crankcase



**RK.01.461** Repair Kit

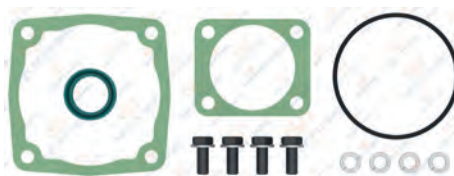

**RK.01.463** Repair Kit



**RK.01.343** Complete Cylinder Head



**RK.01.344** Valve Plate Kit



**RK.01.142.01** Repair Kit

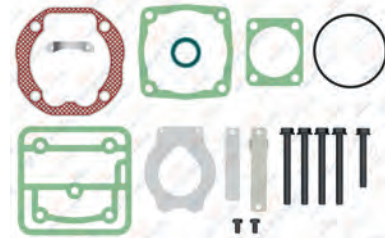

**RK.01.142** Repair Kit

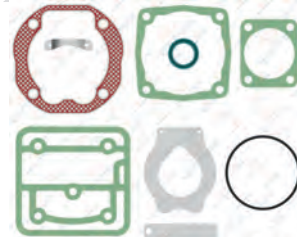

**RK.01.142.02** Repair Kit

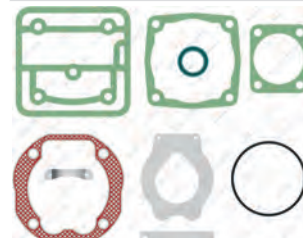



**01.962** Cylinder Head



8 680437 028956

**01.959** Valve Plate



8 680437 028901

**01.201** Crankshaft



M18X1.5 Right Hand



8 680437 019480

**01.073** Cover



8 680437 014133

**01.194** Crankshaft Flange



8 680437 019398

**01.008** Connecting Rod



8 680437 009795

OEM No: 81541060013 - I60599

**RK.01.034.00** Piston&Ring (Ø88,00 mm)

- RK.01.034.10 88,25 mm
- RK.01.034.20 88,50 mm
- RK.01.034.30 88,75 mm
- RK.01.034.40 89,00 mm



2.50x2,50x4,00



8 680437 058616

Knorr No: I81169004 - SEB22555

**01.110.00** Piston (Ø88,00 mm)

- 01.110.10 88,25 mm
- 01.110.20 88,50 mm
- 01.110.30 88,75 mm
- 01.110.40 89,00 mm



2.50x2,50x4,00



8 680437 015994

**01.136.00** Ring (Ø88,00 mm)

- 01.136.10 88,25 mm
- 01.136.20 88,50 mm
- 01.136.30 88,75 mm
- 01.136.40 89,00 mm



2.50x2,50x4,00



8 680437 018384

OEM No : 1409318

Knorr No: I139526F0061

**RK.01.032** Cylinder Liner Set



8 680437 058779

OEM No : 81541056009  
Knorr No: I789790061

**01.057** Cylinder Liner



8 680437 013181

**01.143** Nut



M18X1.5 Right Hand



8 680437 018735

**01.013** Bushing



30x34x16



8 680437 009993

**01.195** Bushing



30x34x16



8 680437 019411

## Twin Cylinder Compressor Ø92 mm-720 CC

Application - Vehicle  
SCANIA 4 SERIES BUS  
EURO 5 MOTOR

Oem. No.	Knorr No.
1767157	LK4948



### RK.01.272.00 Piston&Ring (Ø86,00 mm)

RK.01.272.10	86,25 mm
RK.01.272.20	86,50 mm
RK.01.272.30	86,75 mm
RK.01.272.40	87,00 mm



2.00x2.00x3,00



OEM No : 42549147  
Knorr No: SEB22547 - SEB22548

### 01.868.00 Piston (Ø86,00 mm)

01.868.10	86,25 mm
01.868.20	86,50 mm
01.868.30	86,75 mm
01.868.40	87,00 mm



2.00x2.00x3,00



### 01.869.00 Ring (Ø86,00 mm)

01.869.10	86,25 mm
01.869.20	86,50 mm
01.869.30	86,75 mm
01.869.40	87,00 mm



2.00x2.00x3,00



### RK.01.573.01

Repair Kit

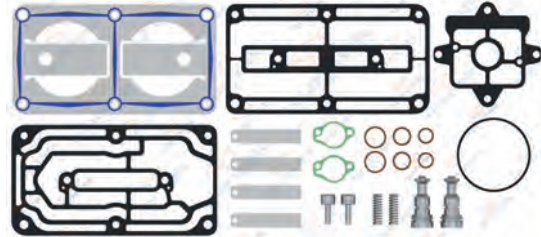

### RK.01.573

Repair Kit

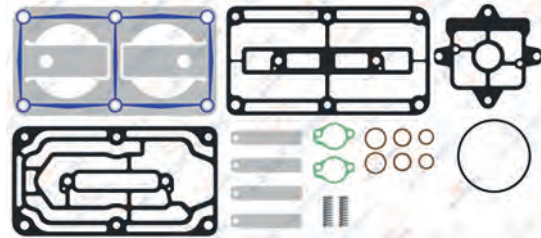

### RK.01.573.02

Repair Kit

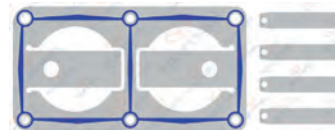

### RK.01.573.03

Repair Kit

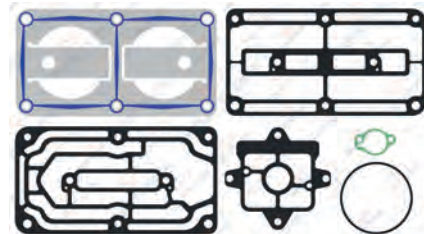

### RK.01.558

Repair Kit

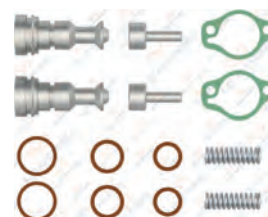

Knorr No: K034874K50

**RK.01.527**

Repair Kit

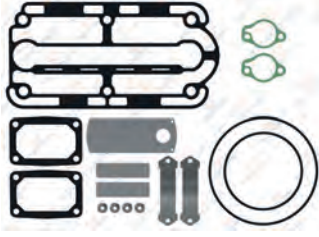

OEM No: 1722015

8 680437 066224



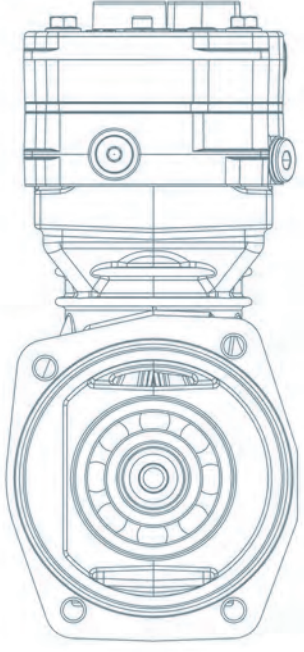

# DAF

**HAVA KOMPRESÖRLERİ  
ve TAMİR TAKIMLARI**

AIR COMPRESSORS AND REPAIR KITS

**DAF**

DAF



## Twin Cylinder Compressor Ø75 mm-442 CC-Stroke 50 mm

### Application - Vehicle

DAF / XF95 / 1260VS / TBR2175 / 95XF / 1160AVM  
F95 / CF85II / CF85C / F75 / 1260PP / 85CF / 75CF / KD



**01.05.069**

#### Oem. Ref. No.

1628444  
1604420  
1736785  
1451651

#### Wabco No.

9115045060

**01.05.069.10**

With Gear



**01.333**

Crankcase



**RK.01.161.04**

Repair Kit

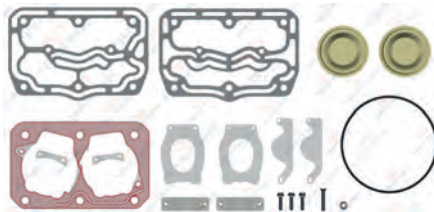

Use for old version cylinder repair kit.  
Yıpranmış kapaklar için.

**RK.01.107**

Repair Kit



**RK.01.171**

Complete Cylinder Head



OEM No : 1743267

Wabco No: 9115049222

**RK.01.161.05**

Repair Kit

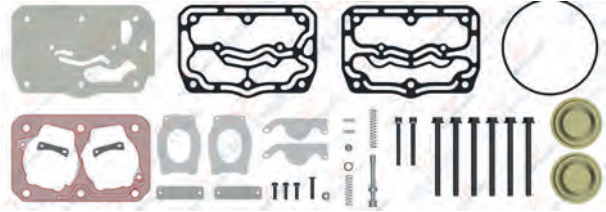

**RK.01.161.02**

Repair Kit



Wabco No: 9115049252

**RK.01.161**

Repair Kit

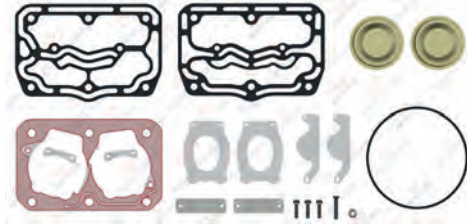

**RK.01.161.06**

Repair Kit

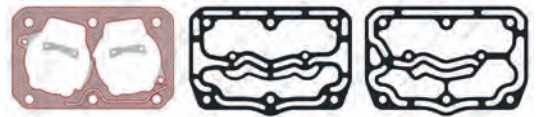

OEM No : 1743718 - 1743719 - 1331138



**01.439** Valve Plate



**01.438** Cylinder Head



**01.322** Crankshaft



OEM No : 1349208

**01.696** Cooling Plate



**RK.01.811** Connecting Rod & Piston



Wabco No: 9115049322

**01.326** Connecting Rod



OEM No: 1331136

**RK.01.118.00** Piston&Ring (Ø75,00 mm)

- RK.01.118.10 75,25 mm
- RK.01.118.20 75,50 mm
- RK.01.118.30 75,75 mm
- RK.01.118.40 76,00 mm



2,00x2,00x4,00



OEM No:0513860-1242704-5000816053  
Wabco No: 4111416232

**01.911.00** Piston (Ø75,00 mm)

- 01.911.10 75,25 mm
- 01.911.20 75,50 mm
- 01.911.30 75,75 mm
- 01.911.40 76,00 mm



2,00x2,00x4,00



**01.134.00** Ring (Ø75,00 mm)

- 01.134.10 75,25 mm
- 01.134.20 75,50 mm
- 01.134.30 75,75 mm
- 01.134.40 76,00 mm



2,00x2,00x4,00



OEM No : 1391384-1391385  
Knorr No : 1801770061

**00.441** Roller Bearing



6307



Oem No : 0697888  
Wabco No : 8952510202 - 8107071284

**01.012** Bushing



39X35X16



Oem No : 1315390  
Wabco No : 4115223404

**01.1587** Gear



OEM No : 1205112



**RK.01.220** Repair Kit



**01.302** Cap



**01.335** Pressure valve



## Twin Cylinder Compressor Ø75 mm-442 CC-Stroke 50 mm

### Application - Vehicle

DAF / XF95 / 1260VS / TBR2175 / 95XF /  
1160AVM / F95 / CF85II / CF85C / F75 / 1260PP /  
85CF / 75CF / KD / VDL BUS



**01.05.068**

Oem. Ref. No.  
1604420

Wabco No.  
9115045040



**01.333**

Crankcase



**RK.01.161.04**

Repair Kit

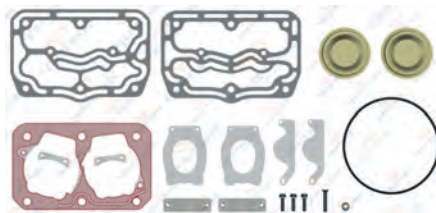

Use for old version cylinder repair kit.  
Yıpranmış kapaklar için.

**RK.01.107**

Repair Kit



**RK.01.293**

Complete Cylinder Head



OEM No : 1737654  
Wabco No : 9115049202 - 9115049212

**RK.01.161.05**

Repair Kit

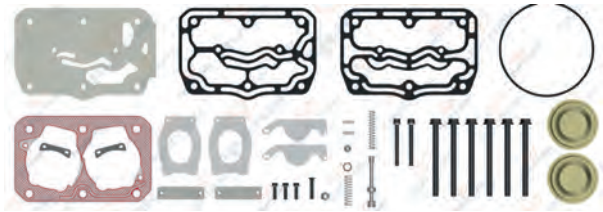

**RK.01.161.02**

Repair Kit



Wabco No: 9115049252

**RK.01.161**

Repair Kit

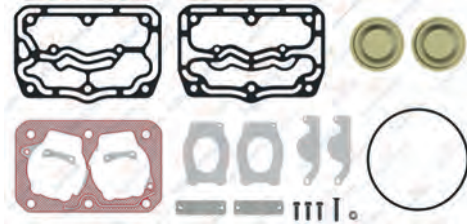

**RK.01.161.06**

Repair Kit



OEM No : 1743718 - 1743719 - 1331138

**01.439** Valve Plate

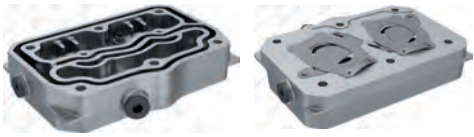

**01.487** Cylinder Head



**01.322** Crankshaft



OEM No : 1349208  
Wabco No : 9115046964

**01.696** Cooling Plate



**RK.01.811** Connecting Rod & Piston



Wabco No: 9115049322

**01.326** Connecting Rod



OEM No: 1331136

**RK.01.118.00** Piston&Ring (Ø75,00 mm)

- RK.01.118.10 75,25 mm
- RK.01.118.20 75,50 mm
- RK.01.118.30 75,75 mm
- RK.01.118.40 76,00 mm



2,00x2,00x4,00



OEM No:0513860-1242704-5000816053  
Wabco No: 4111416232

**01.911.00** Piston (Ø75,00 mm)

- 01.911.10 75,25 mm
- 01.911.20 75,50 mm
- 01.911.30 75,75 mm
- 01.911.40 76,00 mm



2,00x2,00x4,00



**01.134.00** Ring (Ø75,00 mm)

- 01.134.10 75,25 mm
- 01.134.20 75,50 mm
- 01.134.30 75,75 mm
- 01.134.40 76,00 mm



2,00x2,00x4,00



OEM No : 1391384-1391385  
Knorr No: 1801770061

**00.441** Roller Bearing



6307



Oem No: 0697888  
Wabco No: 8952510202 - 8107071284

**01.012** Bushing



39X35X16



Oem No : 1315390  
Wabco No: 4115223404

**01.1587** Gear



OEM No : 1205112



**RK.01.220** Repair Kit



**01.302** Cap



**01.335** Pressure valve





## Twin Cylinder Compressor Ø75 mm-442 cc-Stroke 50 mm

Application - Vehicle

DAF 95XF / CF75, CF85 / CKD / F75, F95 / YT95



**01.05.020**

Oem. Ref. No.

1310523  
1310523R

Wabco No.

9115045010  
9115045000  
9115045030



**01.333**

Crankcase



**RK.01.107**

Repair Kit



**RK.01.220**

Repair Kit



**RK.01.117**

Complete Cylinder Head



OEM No : 1331137 - 1335748 - 1458906

Wabco No : 9115048012 - 9115048032

**RK.01.123.01**

Repair Kit

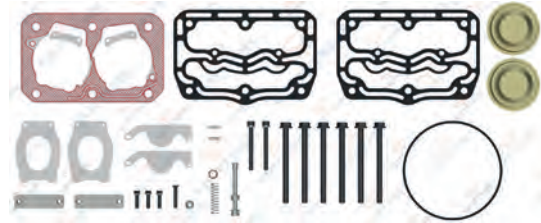

**RK.01.123**

Repair Kit



**RK.01.123.04**

Repair Kit

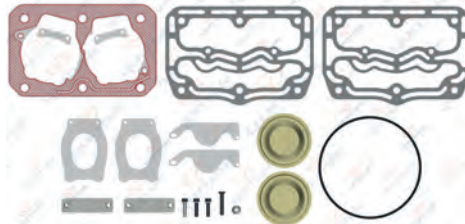

Use for old version cylinder repair kit. Yıpranmış kapaklar için.

**RK.01.123.20**

Repair Kit

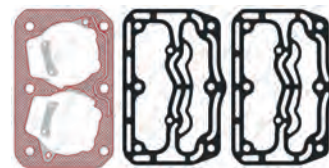

**01.323** Cylinder Head

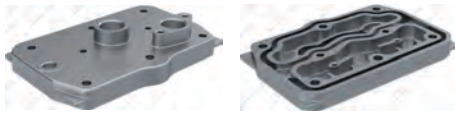

**01.325** Valve Plate



**01.322** Crankshaft



OEM No: 1349208  
Wabco No: 9115046964

**01.324** Cooling Plate



**RK.01.811** Connecting Rod & Piston



Wabco No: 9115049322

**01.326** Connecting Rod



OEM No: 1331136

**RK.01.118.00** Piston&Ring (Ø75,00 mm)

- RK.01.118.10 75,25 mm
- RK.01.118.20 75,50 mm
- RK.01.118.30 75,75 mm
- RK.01.118.40 76,00 mm



2,00x2,00x4,00



OEM No:0513860-1242704-5000816053  
Wabco No: 4111416232

**01.911.00** Piston (Ø75,00 mm)

- 01.911.10 75,25 mm
- 01.911.20 75,50 mm
- 01.911.30 75,75 mm
- 01.911.40 76,00 mm



2,00x2,00x4,00



**01.134.00** Ring (Ø75,00 mm)

- 01.134.10 75,25 mm
- 01.134.20 75,50 mm
- 01.134.30 75,75 mm
- 01.134.40 76,00 mm



2,00x2,00x4,00



OEM No : 1391384-1391385  
Knorr No: I801770061

**00.441** Roller Bearing



6307



Oem No : 0697888  
Wabco No: 8952510202 - 8107071284

**01.012** Bushing



39X35X16



Oem No : 1315390  
Wabco No: 4115223404

**01.1587** Gear



OEM No : 1205112



**01.302** Cap



**01.335** Pressure valve





## Twin Cylinder Compressor Ø85 mm-352/119 cc-Stroke 61 mm/21 mm

**Application - Vehicle**  
DAF XF105 - CF85 TEMSA SAFIR  
PACCAR ENGINE



**01.05.097**

Oem. Ref. No.	Wabco No.
1696197	9125180040
1687079	
1681561	
1674920	

**01.05.097.10**

Without Gear



**01.1153** Crankcase



**RK.01.533.06** Repair Kit

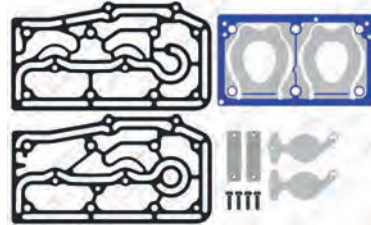

**RK.01.533.07** Repair Kit

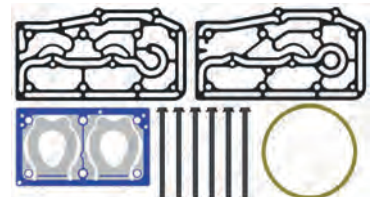

**RK.01.566**

Complete Cylinder Head



OEM No : 1679247  
Wabco No : 9125189202

**RK.01.533.05**

Repair Kit

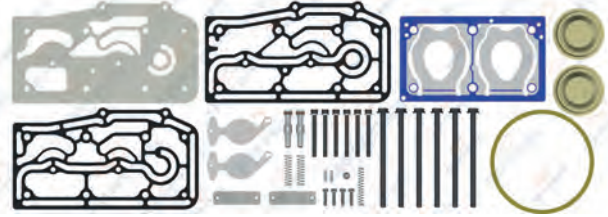

**RK.01.533.03**

Repair Kit

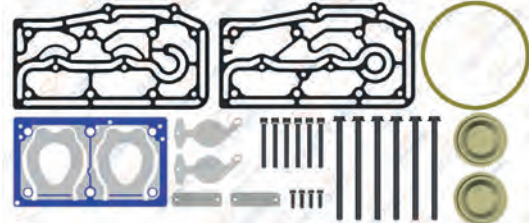

**RK.01.533**

Repair Kit

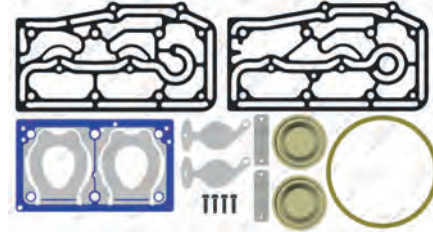

**RK.01.533.04**

Repair Kit

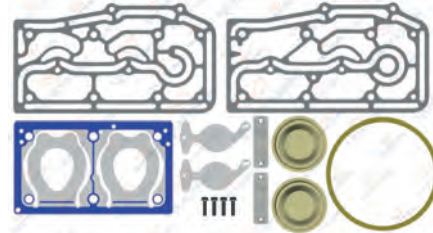

Use for old version cylinder repair kit. Yıpranmış kapaklar için.



**01.1156** Cylinder Head



8 680437 016946

**01.1155** Valve Plate



8 680437 016939

**01.1158** Crankshaft



8 680437 016960

**01.1157** Cooling Plate



8 680437 016953

**01.390** Connecting Rod



Wabco No : 9111457382

8 680437 022015

**01.1133** Connecting Rod



8 680437 016649

**RK.01.104.00** Piston&Ring (Ø85,00 mm)

- RK.01.104.10 85,25 mm
- RK.01.104.20 85,50 mm
- RK.01.104.30 85,75 mm
- RK.01.104.40 86,00 mm



2,00x2,00x4,00

OEM No : 1283781



8 680437 060277

**01.142.00** Piston (Ø85,00 mm)

- 01.142.10 85,25 mm
- 01.142.20 85,50 mm
- 01.142.30 85,75 mm
- 01.142.40 86,00 mm



2,00x2,00x4,00

Wabco No : 9115016242 - 9115016252



8 680437 018674

**01.373.00** Ring (Ø85,00 mm)

- 01.373.10 85,25 mm
- 01.373.20 85,50 mm
- 01.373.30 85,75 mm
- 01.373.40 86,00 mm



2,00x2,00x4,00

Wabco No : 9115019202



8 680437 075431

**01.1154** Adapter



8 680437 016922

Wabco No: 9119020134

**00.999** Roller Bearing



6308



8 680437 009627

**01.1428** Gear



8 680437 072517

OEM No: 1641625

**RK.01.512.01** Repair Kit

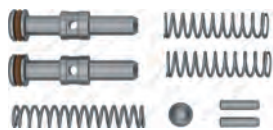

8 680437 110538

**RK.01.569** Repair Kit

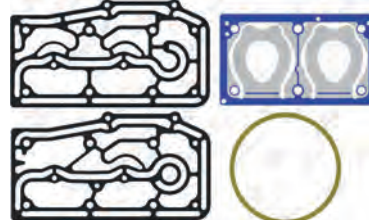

8 680437 066743

**RK.01.418** Repair Kit

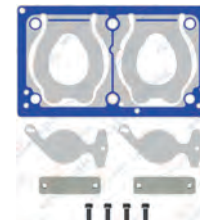

8 680437 065029

## Twin Cylinder Compressor Ø85 mm-352 CC/119 CC-Stroke 61 mm/21 mm

Application - Vehicle  
DAF CF75



**01.05.143**

Oem. Ref. No.  
1696200  
1805490

Wabco No.  
9125181030  
9125181040



**01.1394**

Crankcase



**RK.01.680.03**

Repair Kit

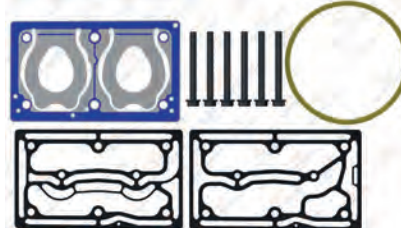

**RK.01.418**

Repair Kit

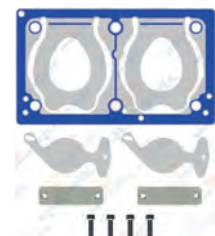

**RK.01.671**

Complete Cylinder Head



Wabco No: 9125189222

**RK.01.680.01**

Repair Kit

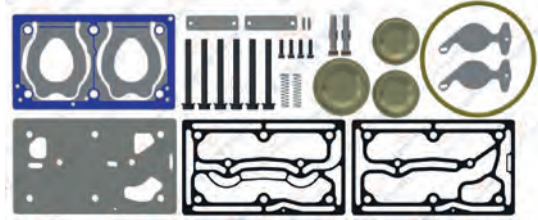

**RK.01.680**

Repair Kit

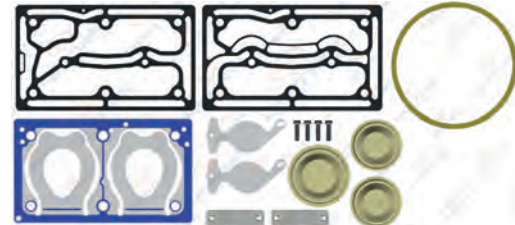

**RK.01.680.04**

Repair Kit

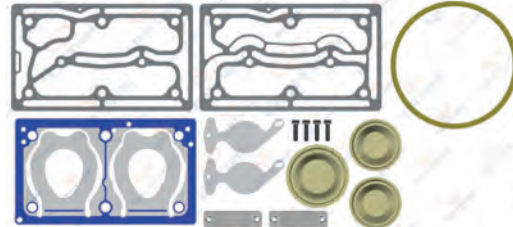

Use for old version cylinder repair kit. Yıpranmış kapaklar için.

**RK.01.680.02**

Repair Kit

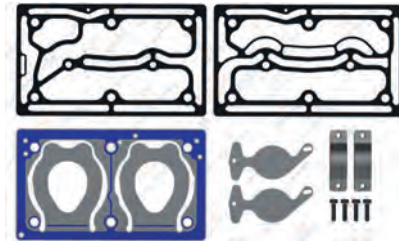

**01.1356** Cylinder Head



8 680437 100638

**01.875** Valve Plate



8 680437 027850

**01.1395** Crankshaft



8 680437 108641

**01.884** Cooling Plate



8 680437 027973

**01.390** Connecting Rod



Wabco No: 9111457382  
8 680437 022015

**01.1133** Connecting Rod



8 680437 016649

**RK.01.104.00** Piston&Ring (Ø85,00 mm)

RK.01.104.10	85,25 mm
RK.01.104.20	85,50 mm
RK.01.104.30	85,75 mm
RK.01.104.40	86,00 mm



2,00x2,00x4,00  
OEM No : 1283781  
8 680437 060277

**01.142.00** Piston (Ø85,00 mm)

01.142.10	85,25 mm
01.142.20	85,50 mm
01.142.30	85,75 mm
01.142.40	86,00 mm



2,00x2,00x4,00  
Wabco No : 9115016242 - 9115016252  
8 680437 018674

**01.373.00** Ring (Ø85,00 mm)

01.373.10	85,25 mm
01.373.20	85,50 mm
01.373.30	85,75 mm
01.373.40	86,00 mm



2,00x2,00x4,00  
Wabco No: 9115019202  
8 680437 075431

**01.1154** Adapter



Wabco No: 9119020134  
8 680437 016922

**00.999** Roller Bearing



6308  
8 680437 009627

**01.1428** Gear



Oem. Ref. No: 1641625  
8 680437 072317

**RK.01.512.01** Repair Kit

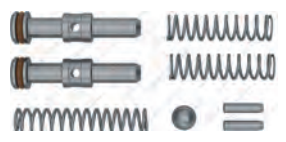

8 680437 110538

**01.1227** Bushing



52X48X20  
8 680437 017936

**01.144** Nut



M20X1.5 Right Hand  
Wabco No: 8103410014  
8 680437 018742



## Twin Cylinder Compressor Ø85 mm-476 CC-Stroke 42 mm

Application - Vehicle  
DAF CF75  
EURO4



**01.05.144**

Oem. Ref. No.

1689065  
1736790  
1795776  
1813541

Wabco No.

9125182000  
9125182020  
9125182040  
9125182060



**01.1401**

Crankcase



**RK.01.671.10**

Complete Cylinder Head



**RK.01.680.05**

Repair Kit

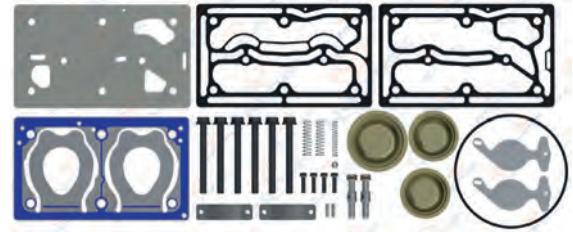

**RK.01.680.06**

Repair Kit

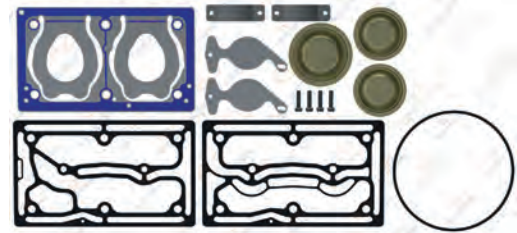

**RK.01.680.07**

Repair Kit

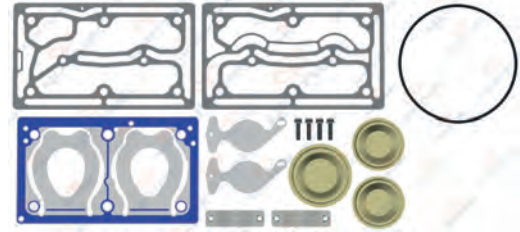

Use for old version cylinder repair kit. Yıpranmış kapaklar için.

**RK.01.680.02**

Repair Kit

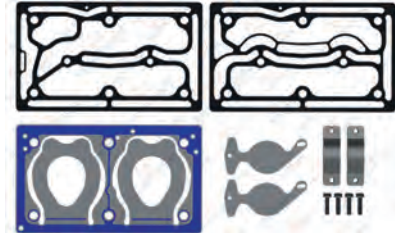

**RK.01.680.08**

Repair Kit

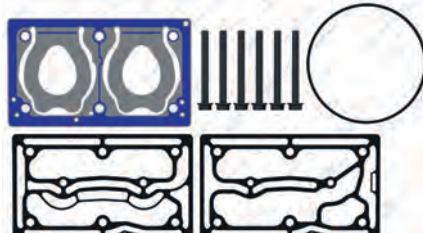

**RK.01.418**

Repair Kit

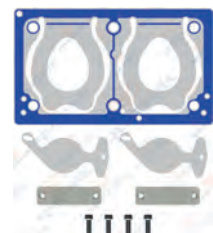

**01.1356** Cylinder Head



8 680437 100638

**01.875** Valve Plate



8 680437 027850

**01.1402** Crankshaft



8 680437 078326

**01.884** Cooling Plate



8 680437 027973

**01.878** Bushing



8 680437 027898

**01.390** Connecting Rod



8 680437 022015

Wabco No: 9111457382

**RK.01.104.00** Piston&Ring (Ø85,00 mm)

- RK.01.104.10 85,25 mm
- RK.01.104.20 85,50 mm
- RK.01.104.30 85,75 mm
- RK.01.104.40 86,00 mm



2,00x2,00x4,00



8 680437 060277

OEM No : 1283781

**01.142.00** Piston (Ø85,00 mm)

- 01.142.10 85,25 mm
- 01.142.20 85,50 mm
- 01.142.30 85,75 mm
- 01.142.40 86,00 mm



2,00x2,00x4,00



8 680437 018674

Wabco No : 9115016242 - 9115016252

**01.373.00** Ring (Ø85,00 mm)

- 01.373.10 85,25 mm
- 01.373.20 85,50 mm
- 01.373.30 85,75 mm
- 01.373.40 86,00 mm



2,00x2,00x4,00



8 680437 075431

Wabco No: 9115019202

**RK.01.512.01** Repair Kit

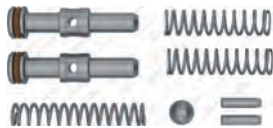

8 680437 110538

**01.302** Cap



8 680437 020769

## Twin Cylinder Compressor Ø85 mm-636 CC-Stroke 56 mm

Application - Vehicle  
DAF CF75  
EURO4



### 01.05.102

Oem. Ref. No.	Wabco No.
1689070	9125182010
1736795	9125182030
1795775	9125182050
1813542	9125182070



**01.1401** Crankcase



**RK.01.680.08** Repair Kit

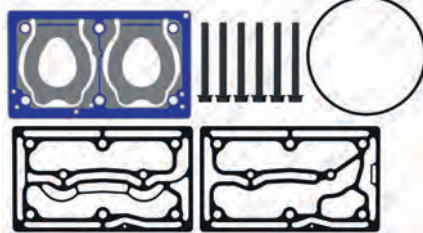

**RK.01.418** Repair Kit

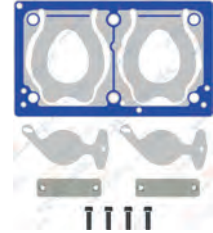

**RK.01.671.10**

Complete Cylinder Head



**RK.01.680.05**

Repair Kit

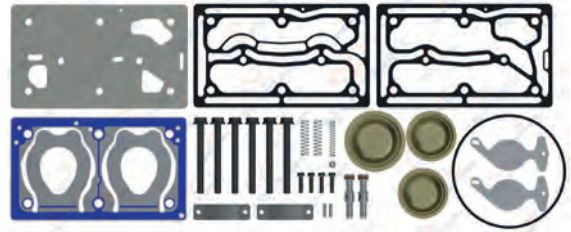

**RK.01.680.06**

Repair Kit

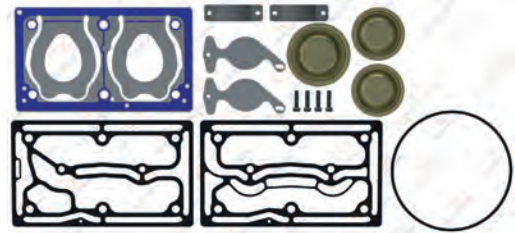

**RK.01.680.07**

Repair Kit

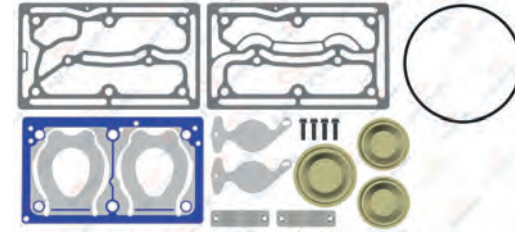

Use for old version cylinder repair kit. Yıpranmış kapaklar için.

**RK.01.680.02**

Repair Kit

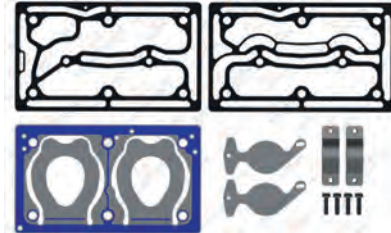



**01.1356** Cylinder Head

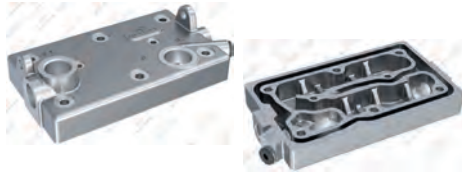

8 680437 100638

**01.875** Valve Plate



8 680437 027850

**01.1928** Crankshaft



8 680437 164302

**01.884** Cooling Plate



8 680437 027973

**01.878** Bushing



8 680437 027898

**01.272** Connecting Rod



8 680437 020400

Wabco No: 9111457382

**RK.01.104.00** Piston&Ring (Ø85,00 mm)

- RK.01.104.10 85,25 mm
- RK.01.104.20 85,50 mm
- RK.01.104.30 85,75 mm
- RK.01.104.40 86,00 mm



2,00x2,00x4,00



8 680437 060277

OEM No : 1283781

**01.142.00** Piston (Ø85,00 mm)

- 01.142.10 85,25 mm
- 01.142.20 85,50 mm
- 01.142.30 85,75 mm
- 01.142.40 86,00 mm



2,00x2,00x4,00



8 680437 018674

Wabco No : 9115016242 - 9115016252

**01.373.00** Ring (Ø85,00 mm)

- 01.373.10 85,25 mm
- 01.373.20 85,50 mm
- 01.373.30 85,75 mm
- 01.373.40 86,00 mm



2,00x2,00x4,00



8 680437 075431

Wabco No: 9115019202

**RK.01.512.01** Repair Kit



8 680437 110538

**01.302** Cap



8 680437 020769

## Twin Cylinder Compressor Ø75 mm-440 CC-Stroke 50 mm

Application - Vehicle  
DAF 95 ATI  
EF95 380 / 95XF400 / 95XF / 430CV



**01.05.032**

Oem. Ref. No.  
1243571  
1243571R

Wabco No.  
9115040560



**01.759** Crankcase



**RK.01.179** Repair Kit



**RK.01.252** Complete Cylinder Head



OEM No : 1253530  
Wabco No : 9115038052

**RK.01.125.01** Repair Kit

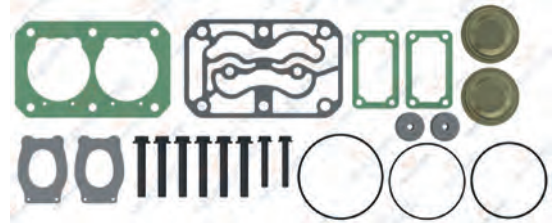

**RK.01.125** Repair Kit

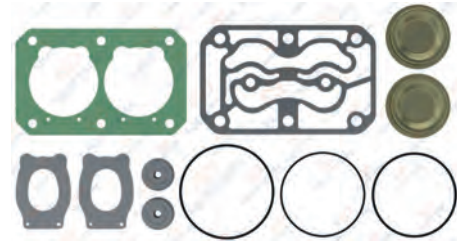

**RK.01.125.02** Repair Kit

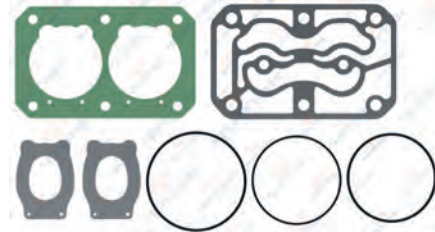

**RK.01.228** Repair Kit

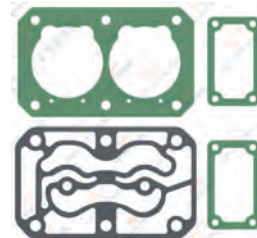

**RK.01.475** Repair Kit



**01.1781** Cylinder Head



**01.1780** Valve Plate



**01.605** Crankshaft



**01.279** Bushing



39X35X20



**01.755** Crankshaft Flange



**01.750** Connecting Rod



OEM No : 1304884  
Knorr No : 4111447352 - 4111447312

**RK.01.118.00** Piston&Ring (Ø75,00 mm)

- RK.01.118.10 75,25 mm
- RK.01.118.20 75,50 mm
- RK.01.118.30 75,75 mm
- RK.01.118.40 76,00 mm



2,00x2,00x4,00



OEM No : 0513860 - 1242704  
Wabco No: 4111416232

**01.911.00** Piston (Ø75,00 mm)

- 01.911.10 75,25 mm
- 01.911.20 75,50 mm
- 01.911.30 75,75 mm
- 01.911.40 76,00 mm



2,00x2,00x4,00



**01.134.00** Ring (Ø75,00 mm)

- 01.134.10 75,25 mm
- 01.134.20 75,50 mm
- 01.134.30 75,75 mm
- 01.134.40 76,00 mm



2,00x2,00x4,00



OEM No : 1391384-1391385  
Knorr No : I801770061

**01.292** Bushing



42X38X25





## Twin Cylinder Compressor Ø75 mm-440 CC-Stroke 50 mm

Application - Vehicle  
DAF 95 ATI  
95XF400 / 95XF / 430CV / F95400

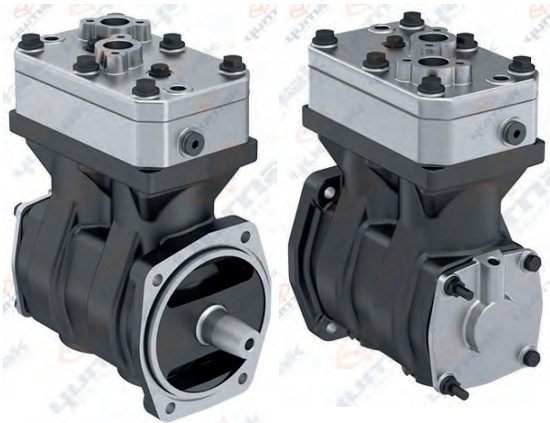

**01.05.034**

Oem. Ref. No.	Wabco No.
1298052	9115040590
1373425	9115040600



**01.849** Crankcase



**RK.01.179** Repair Kit



**RK.01.252** Complete Cylinder Head



OEM No : 1253530  
Wabco No : 9115038052

**RK.01.125.01** Repair Kit

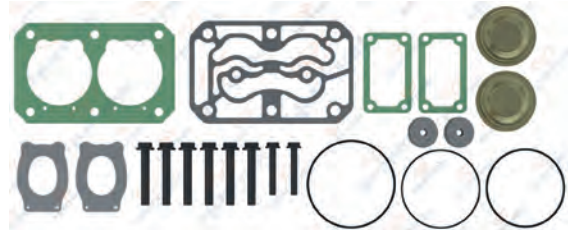

**RK.01.125** Repair Kit

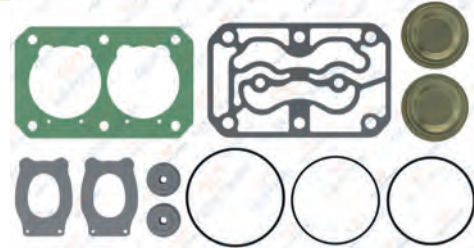

**RK.01.125.02** Repair Kit

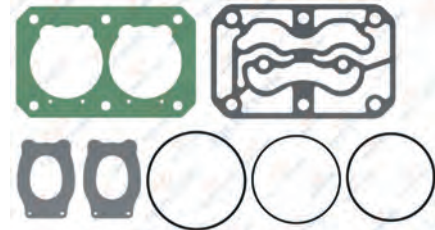

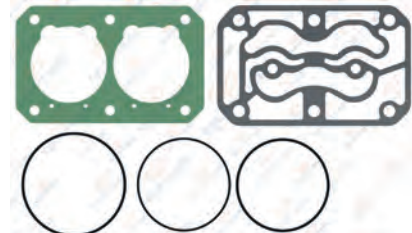

**RK.01.125.03** Repair Kit



**RK.01.475** Repair Kit



**01.1781** Cylinder Head

8 680437 128762

**01.1780** Valve Plate



8 680437 128755

**01.605** Crankshaft



8 680437 024552

**01.279** Bushing



**39X35X20**



8 680437 020479

**01.1787** Crankshaft Flange



8 680437 128793

**01.750** Connecting Rod



OEM No : 1304884  
Knorr No : 4111447352 - 4111447312

**RK.01.118.00** Piston&Ring (Ø75,00 mm)

RK.01.118.10	75,25 mm
RK.01.118.20	75,50 mm
RK.01.118.30	75,75 mm
RK.01.118.40	76,00 mm



**2,00x2,00x4,00**



OEM No : 0513860 - 1242704  
Wabco No: 4111416232

**01.911.00** Piston (Ø75,00 mm)

01.911.10	75,25 mm
01.911.20	75,50 mm
01.911.30	75,75 mm
01.911.40	76,00 mm



**2,00x2,00x4,00**



8 680437 028277

**01.134.00** Ring (Ø75,00 mm)

01.134.10	75,25 mm
01.134.20	75,50 mm
01.134.30	75,75 mm
01.134.40	76,00 mm



**2,00x2,00x4,00**



OEM No : 1391384-1391385  
Knorr No : 1801770061

**01.437** Bushing



**39X35X20**



Wabco No: 9115043404

Empty component slot.

Empty component slot.

Empty component slot.

Empty component slot.

Empty component slot.

Empty component slot.

Empty component slot.

Empty component slot.

## Twin Cylinder Compressor Ø75 mm-440 CC-Stroke 50 mm

Application - Vehicle  
DAF 95 ATI 3300  
95XF / 310CV / 350CV / F95 330



**01.05.041**

Oem. Ref. No.  
762788  
528737  
537990

Wabco No.  
9115040520



**01.759**

Crankcase



**RK.01.178**

Repair Kit



**RK.01.267**

Complete Cylinder Head



**RK.01.328**

Valve Plate Kit



**RK.01.153.01**

Repair Kit

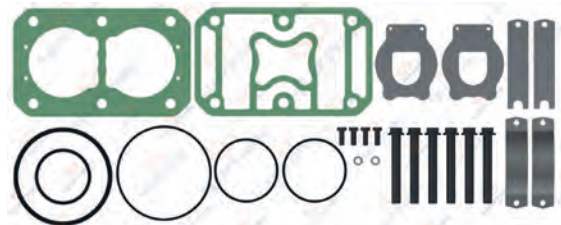

**RK.01.153**

Repair Kit

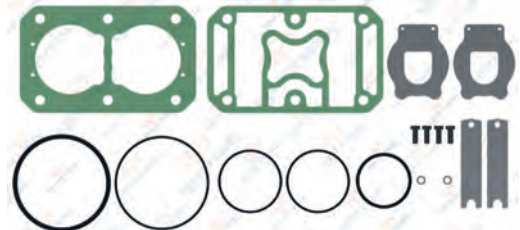

**RK.01.274**

Repair Kit

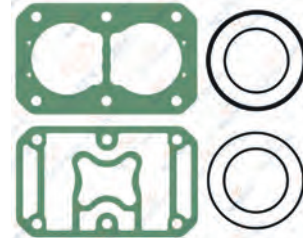



**01.776** Cylinder Head



Wabco No: 9115046502  
8 680437 026556

**01.777** Valve Plate



8 680437 026563

**01.605** Crankshaft



8 680437 024552

**01.437** Bushing



39X35X20  
Wabco No: 9115043404  
8 680437 022589

**01.755** Crankshaft Flange



8 680437 026235

**01.750** Connecting Rod



OEM No : 1304884  
Knorr No: 4111447352 - 4111447312  
8 680437 026181

**RK.01.118.00** Piston&Ring (Ø75,00 mm)

- RK.01.118.10 75,25 mm
- RK.01.118.20 75,50 mm
- RK.01.118.30 75,75 mm
- RK.01.118.40 76,00 mm



2,00x2,00x4,00  
OEM No : 0513860 - 1242704  
Wabco No: 4111416232  
8 680437 060482

**01.911.00** Piston (Ø75,00 mm)

- 01.911.10 75,25 mm
- 01.911.20 75,50 mm
- 01.911.30 75,75 mm
- 01.911.40 76,00 mm



2,00x2,00x4,00  
8 680437 028277

**01.134.00** Ring (Ø75,00 mm)

- 01.134.10 75,25 mm
- 01.134.20 75,50 mm
- 01.134.30 75,75 mm
- 01.134.40 76,00 mm



2,00x2,00x4,00  
OEM No : 1391384-1391385  
Knorr No: I801770061  
8 680437 018278

## Twin Cylinder Compressor Ø85 mm-510 CC-Stroke 45 mm

**Application - Vehicle**  
DAF F2300 / F2800 / 3300 / 3600  
NEOPLAN / NATO



**01.06.009**

**Oem. Ref. No.**  
285596 - 285597  
644263 - 644264  
667440 - 667441

**Wabco No.**  
9115010150  
9115010160



**01.748**

**Crankcase**



**RK.01.286**

**Complete Cylinder Head**



**Oem No : 692002**  
**Wabco No: 9115018012**

**RK.01.134.01**

**Repair Kit**

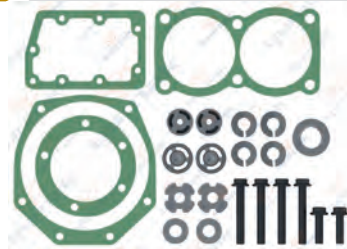

**RK.01.134**

**Repair Kit**

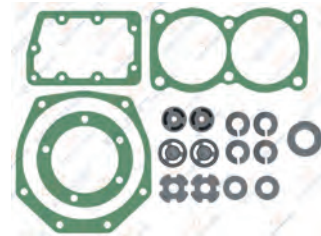

**RK.01.134.03**

**Repair Kit**

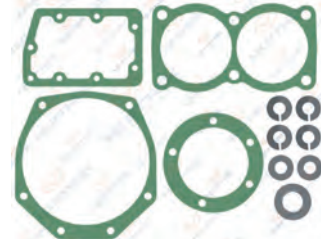

**RK.01.188**

**Repair Kit**



**01.698** Cylinder Head



**00.441** Roller Bearing



6307



Oem No: 0697888  
Wabco No: 8952510202 - 8107071284

**01.648** Crankshaft



**01.144** Nut



M20X1.5 Right Hand



**01.756** Crankshaft Flange



**01.956** Connecting Rod



Wabco No : 9115017332

**RK.01.132.00** Piston&Ring (Ø85,00 mm)

- RK.01.132.10 85,25 mm
- RK.01.132.20 85,50 mm
- RK.01.132.30 85,75 mm
- RK.01.132.40 86,00 mm



2,00x2,00x4,00



**01.933.00** Piston (Ø85,00 mm)

- 01.933.10 85,25 mm
- 01.933.20 85,50 mm
- 01.933.30 85,75 mm
- 01.933.40 86,00 mm



2,00x2,00x4,00



**01.373.00** Ring (Ø85,00 mm)

- 01.373.10 85,25 mm
- 01.373.20 85,50 mm
- 01.373.30 85,75 mm
- 01.373.40 86,00 mm



2,00x2,00x4,00



**01.780** Cover





## Twin Cylinder Compressor Ø85 mm-510 CC-Stroke 45 mm

Application - Vehicle  
DAF 3300 ATI / 3600 ATI / 2800 ATI

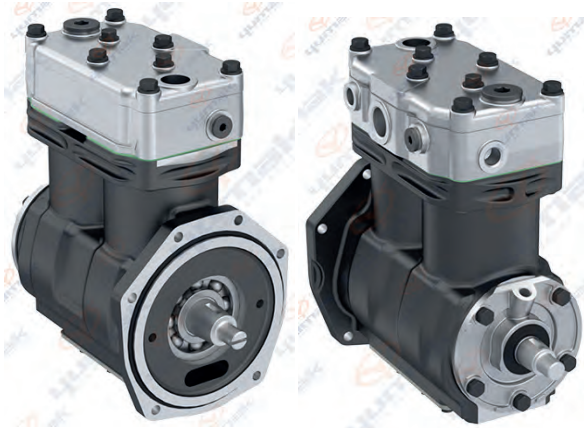

**01.06.012**

Oem. Ref. No.	Wabco No.
555097	9115010600
555098	9115010610



**01.748** Crankcase



**RK.01.475** Repair Kit



**RK.01.233** Complete Cylinder Head



**RK.01.141.01** Repair Kit



**RK.01.141** Repair Kit



**RK.01.141.03** Repair Kit

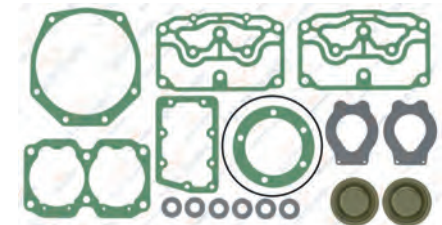

**RK.01.221** Repair Kit



**01.780** Cover



8 680437 026594

**00.441** Roller Bearing



6307



8 680437 004547

Oem No: 0697888

Wabco No: 8952510202 - 8107071284

**01.648** Crankshaft



M16X1.5 Right Hand



8 680437 025146

**RK.01.132.00** Piston&Ring (Ø85,00 mm)

- RK.01.132.10 85,25 mm
- RK.01.132.20 85,50 mm
- RK.01.132.30 85,75 mm
- RK.01.132.40 86,00 mm



2,00x2,00x4,00



8 680437 060802

**01.933.00** Piston (Ø85,00 mm)

- 01.933.10 85,25 mm
- 01.933.20 85,50 mm
- 01.933.30 85,75 mm
- 01.933.40 86,00 mm



2,00x2,00x4,00



8 680437 028512

**01.373.00** Ring (Ø85,00 mm)

- 01.373.10 85,25 mm
- 01.373.20 85,50 mm
- 01.373.30 85,75 mm
- 01.373.40 86,00 mm



2,00x2,00x4,00



8 680437 075431

**01.756** Crankshaft Flange



8 680437 026242

**01.956** Connecting Rod



8 680437 028864

Wabco No : 9115017332

## Twin Cylinder Compressor Ø75 mm-440 CC -Stroke 50 mm

Application - Vehicle  
DAF ATI / F75 / F85 / F95 / CF75 / CF85



**01.05.019**

Oem. Ref. No.	Knorr No.
1366290	LP4823
1321470	SEB01782000
1241874	



**01.760** Crankcase



**RK.01.135.03** Repair Kit



**RK.01.257** Complete Cylinder Head



**RK.01.258.01** Valve Plate Kit

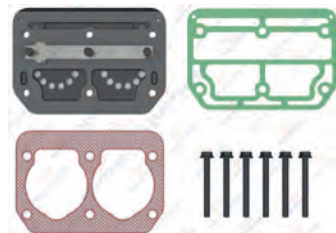

**RK.01.258** Valve Plate Kit



**RK.01.135.01** Repair Kit

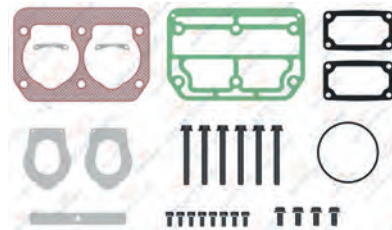

**RK.01.135** Repair Kit

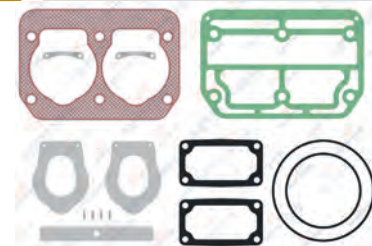

**RK.01.135.22** Repair Kit

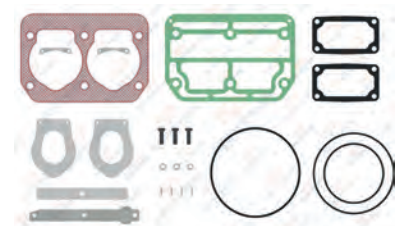



**01.785** Cylinder Head



8 680437 073857 **Oem. No** : 1283815  
**Knorr No** : SEB01093004

**RK.01.258.02** Valve Plate



8 680437 112778

**01.826** Crankshaft



8 680437 027164 **Oem. Ref. No** : 1283810

**01.292** Bushing



42X38X25

8 680437 073871

**01.220** Crankshaft Flange



8 680437 019756 **Oem. No** : 1287864  
**Knorr No** : SEB00387004

**01.218** Connecting Rod



8 680437 019725 **Oem. No** : 1283811  
**Knorr No** : SEB00626004 SEB00957004

**RK.01.073.00** Piston&Ring (Ø75,00 mm)

- RK.01.073.10 75,25 mm
- RK.01.073.20 75,50 mm
- RK.01.073.30 75,75 mm
- RK.01.073.40 76,00 mm



2,00x2,00x4,00

8 680437 059547 **OEM No** : 1315279-1315280-1433932  
**Knorr No** : SEB22539 - SEB22540

**01.193.00** Piston (Ø75,00 mm)

- 01.193.10 75,25 mm
- 01.193.20 75,50 mm
- 01.193.30 75,75 mm
- 01.193.40 76,00 mm



2,00x2,00x4,00

8 680437 019336

**01.134.00** Ring (Ø75,00 mm)

- 01.134.10 75,25 mm
- 01.134.20 75,50 mm
- 01.134.30 75,75 mm
- 01.134.40 76,00 mm



2,00x2,00x4,00

8 680437 018278 **OEM No** : 1391384-1391385  
**Knorr No** : I801770061

**RK.01.057** Repair Kit



8 680437 059172

**01.414** Cover



8 680437 022312

**01.144** Nut



M20X1.5 Right Hand

8 680437 018742 **Oem. No** : 1698672

# Single Cylinder Compressor Ø90 mm-293 CC-Stroke 46 mm

Application - Vehicle  
DAF



## 01.05.110

Oem. Ref. No.	Wabco No.
1505916	4111438830
1373720	4111436820
500318126	4111438810
0364486	4111438820
0269929	



01.1250

Crankcase



RK.01.183

Repair Kit



RK.01.019

Complete Cylinder Head



RK.01.013

Valve Plate Kit



Wabco No : 4110335052

RK.01.636.01

Repair Kit

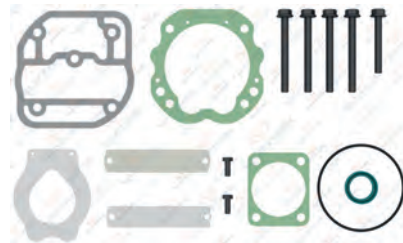

RK.01.636

Repair Kit

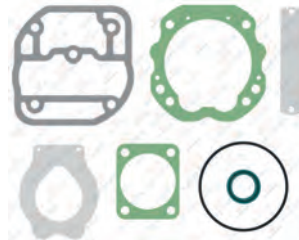

RK.01.636.02

Repair Kit

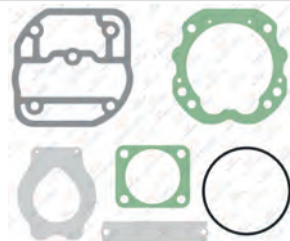

**01.070** Cylinder Head



8 680437 014072

**01.122** Valve Plate



8 680437 017783

**01.1254** Crankshaft



M18X1.5 Right Hand



Wabco No : 4111436904

**01.190** Bushing



34X30X20



8 680437 019282

**01.437** Bushing



39X35X20



8 680437 022589

**01.230.10** Connecting Rod



8 680437 072522

**RK.01.635.00** Piston&Ring (Ø90,00 mm)

- RK.01.635.10 90,25 mm
- RK.01.635.20 90,50 mm
- RK.01.635.30 90,75 mm
- RK.01.635.40 91,00 mm



2.50x2,50x4,00



Wabco No: 4111426232

**01.1255.00** Piston (Ø90,00 mm)

- 01.1255.10 90,25 mm
- 01.1255.20 90,50 mm
- 01.1255.30 90,75 mm
- 01.1255.40 91,00 mm



2.50x2,50x4,00



8 680437 077053

**01.138.00** Ring (Ø90,00 mm)

- 01.138.10 90,25 mm
- 01.138.20 90,50 mm
- 01.138.30 90,75 mm
- 01.138.40 91,00 mm



2.50x2,50x4,00



8 680437 018469

**01.073** Cover



8 680437 014133

**01.241** Connecting Rod Bearing Kit



8 680437 019985

**01.143** Nut



M18X1.5 Right Hand



8 680437 018735



## Single Cylinder Compressor Ø80 mm-225 CC-Stroke 44,50 mm

Application - Vehicle  
DAF LF45 LF55



**01.04.133**

Oem. Ref. No.  
1403939

Knorr No.  
LK3839  
LK3875-K008457000



**01.1314** Crankcase



**RK.01.159.08** Repair Kit

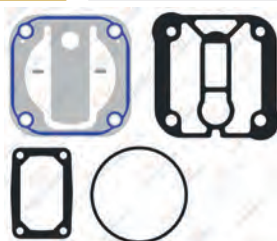

Knorr No: SEB018190052

**RK.01.159.16** Repair Kit



**RK.01.683.01**

Complete Cylinder Head



**RK.01.638**

Valve Plate Kit



**RK.01.638.01**

Valve Plate Kit



Knorr No: SEB01916K50

**RK.01.159.03**

Repair Kit

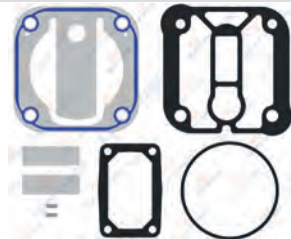

**RK.01.159.15**

Repair Kit

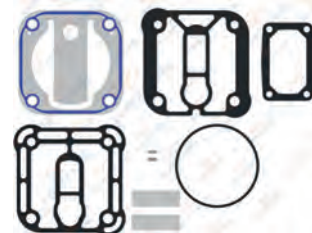

Knorr No: SEB22518

**01.1301** Cylinder Head

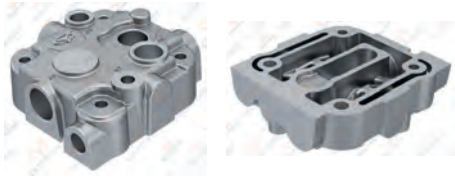

8 680437 127796  
**OEM No :** 1439981  
**Knorr No :** SEB01629004

**01.1392** Crankshaft Flange

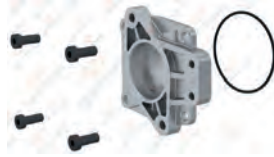

8 680437 072225

**01.1339** Crankshaft



**M18X1.5 - Right Hand**  
 8 680437 072430

**01.1290** Valve Plate



8 680437 071624  
**OEM No :** 1689834  
**Knorr No :** SEB01916004

**01.292** Bushing



42X38X25

8 680437 073871

**01.1101** Connecting Rod



8 680437 016069

**RK.01.601.00** Piston&Ring (Ø80,00 mm)

- RK.01.601.10 80,25 mm
- RK.01.601.20 80,50 mm
- RK.01.601.30 80,75 mm
- RK.01.601.40 81,00 mm



2.50x2,50x4,00  
 8 680437 067054  
**Knorr No :** SEB22517

**01.1201.00** Piston (Ø80,00 mm)

- 01.1201.10 80,25 mm
- 01.1201.20 80,50 mm
- 01.1201.30 80,75 mm
- 01.1201.40 81,00 mm



2.50x2,50x4,00  
 8 680437 017530

**01.1226.00** Ring (Ø80,00 mm)

- 01.1226.10 80,25 mm
- 01.1226.20 80,50 mm
- 01.1226.30 80,75 mm
- 01.1226.40 81,00 mm



2.50x2,50x4,00  
 8 680437 017882

**01.374** Cover



8 680437 077022

**01.870** Nut



**M18X1.5 - Right Hand**  
 8 680437 027799

# Single Cylinder Compressor Ø90 mm-229 CC-Stroke 36 mm

Application - Vehicle  
DAF



**01.05.119**

Wabco No.  
4111425660



**01.1249**

Crankcase



**RK.01.183**

Repair Kit



**RK.01.019**

Complete Cylinder Head



**RK.01.013**

Valve Plate Kit



Wabco No: 4110335052

**RK.01.636.01**

Repair Kit

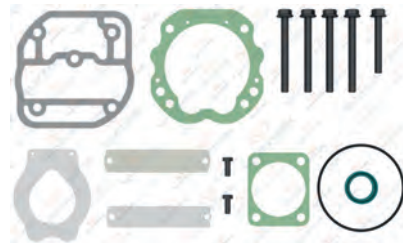

**RK.01.636**

Repair Kit

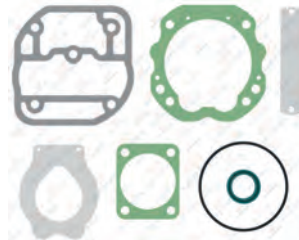

**RK.01.636.02**

Repair Kit

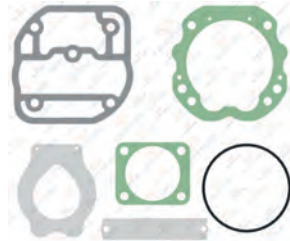



**01.070** Cylinder Head



Wabco No: 4110336572

8 680437 014072

**01.190** Bushing



34X30X20

8 680437 019282

**01.1254** Crankshaft



M18X1.5 Right Hand

Wabco No: 4111436904

8 680437 076759

**01.122** Valve Plate



8 680437 017783

**01.437** Bushing



39X35X20

8 680437 022589

**01.230.10** Connecting Rod



8 680437 072522

**RK.01.635.00** Piston&Ring (Ø90,00 mm)

RK.01.635.10	90,25 mm
RK.01.635.20	90,50 mm
RK.01.635.30	90,75 mm
RK.01.635.40	91,00 mm



2.50x2,50x4,00

Wabco No: 4111426232

8 680437 074526

**01.1255.00** Piston (Ø90,00 mm)

01.1255.10	90,25 mm
01.1255.20	90,50 mm
01.1255.30	90,75 mm
01.1255.40	91,00 mm



2.50x2,50x4,00

8 680437 077053

**01.138.00** Ring (Ø90,00 mm)

01.138.10	90,25 mm
01.138.20	90,50 mm
01.138.30	90,75 mm
01.138.40	91,00 mm



2.50x2,50x4,00

8 680437 018469

**01.073** Cover



8 680437 014133

**01.241** Connecting Rod Bearing Kit



8 680437 019985

**01.143** Nut



M18X1.5 Right Hand

8 680437 018735

## Twin Cylinder Compressor Ø85 mm-704 CC-Stroke 62 mm

Application - Vehicle  
DAF



**01.06.008**

Oem. Ref. No.	Wabco No.
1626060	9115051500
5003460	
1506365	

**01.06.008.10**

With Gear



**01.694**

Crankcase



**RK.01.187**

Repair Kit



**RK.01.227** Complete Cylinder Head

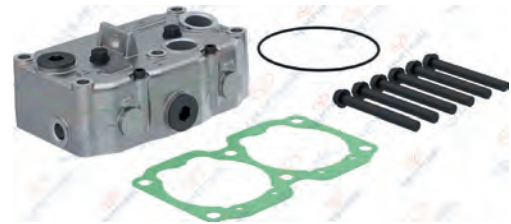

Wabco No: 9115058042

**RK.01.140.01**

Repair Kit

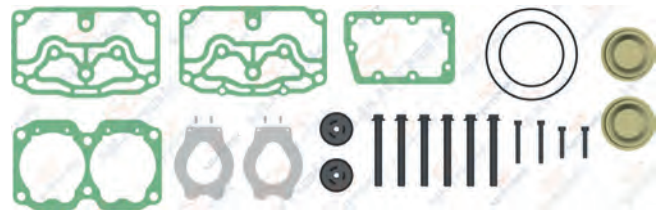

**RK.01.140**

Repair Kit

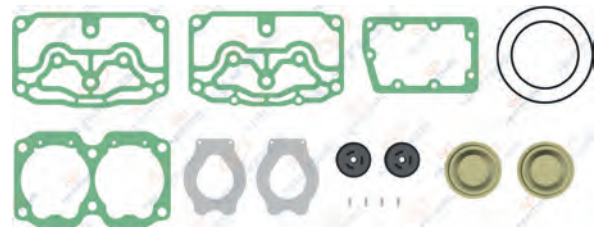

**RK.01.140.02**

Repair Kit

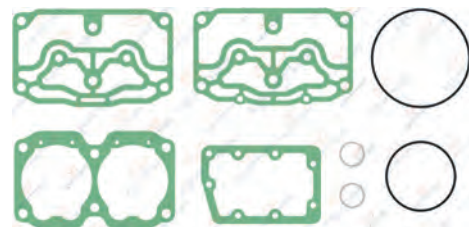

Wabco No: 9115050012

**RK.01.140.03**

Repair Kit

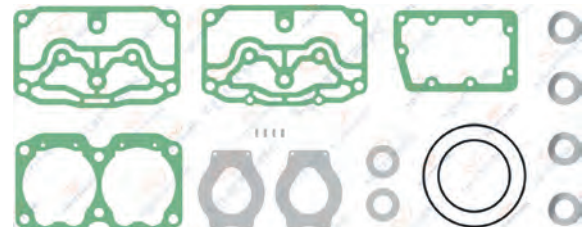

**RK.01.482**

Repair Kit



**01.668** Cylinder Head



8 680437 025337

**01.669** Valve Plate



8 680437 025344

Wabco No: 9115056572

**01.649** Crankshaft



M20X1.5 Right Hand



8 680437 025153

**00.441** Roller Bearing



6307



8 680437 004547

Oem No : 0697888

Wabco No: 8952510202 - 8107071284

**01.695** Crankshaft Flange



8 680437 025603

Wabco No: 9115056644

**01.697** Connecting Rod



8 680437 025634

**RK.01.132.00** Piston&Ring (Ø85,00 mm)

- RK.01.132.10 85,25 mm
- RK.01.132.20 85,50 mm
- RK.01.132.30 85,75 mm
- RK.01.132.40 86,00 mm



2,00x2,00x4,00



8 680437 060802

**01.933.00** Piston (Ø85,00 mm)

- 01.933.10 85,25 mm
- 01.933.20 85,50 mm
- 01.933.30 85,75 mm
- 01.933.40 86,00 mm



2,00x2,00x4,00



8 680437 028512

**01.373.00** Ring (Ø85,00 mm)

- 01.373.10 85,25 mm
- 01.373.20 85,50 mm
- 01.373.30 85,75 mm
- 01.373.40 86,00 mm



2,00x2,00x4,00



8 680437 075431

**RK.01.806** Connecting Rod & Piston



8 680437 114581

Wabco No: 4127049422\*

**01.780** Cover



8 680437 026594

**01.1409** Gear



8 680437 072539

Oem No: 478777 - 470775

**01.1230** Bushing



42X38X23



8 680437 017981

**01.144** Nut



M20X1.5 Right Hand



8 680437 018742



## Twin Cylinder Compressor Ø85 mm-704 CC-Stroke 62 mm

Application - Vehicle  
DAF



### 01.06.015

Oem. Ref. No.

1518141  
3037344  
8112426

Wabco No.

9115051510



01.615

Crankcase



RK.01.187

Repair Kit



RK.01.227 Complete Cylinder Head



Wabco No: 9115058042

RK.01.140.01

Repair Kit

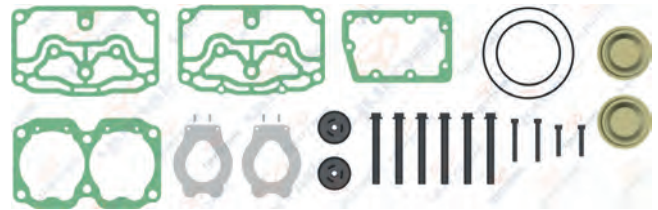

RK.01.140

Repair Kit

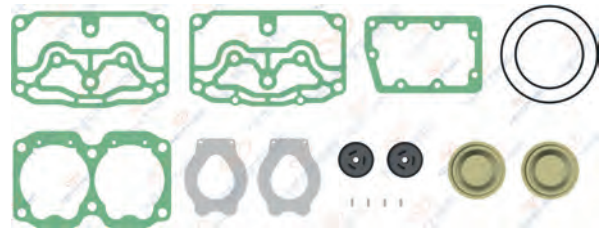

RK.01.140.02

Repair Kit

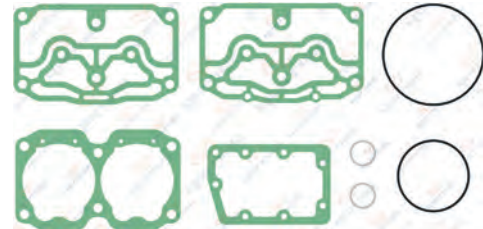

Wabco No: 9115050012

RK.01.140.03

Repair Kit

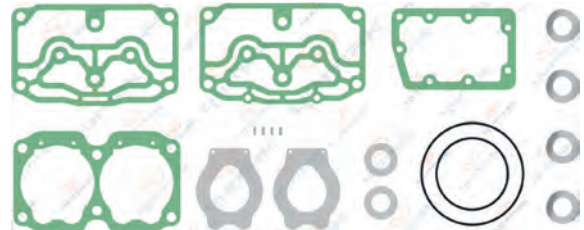

RK.01.482

Repair Kit



**01.668** Cylinder Head



8 680437 025337

**01.669** Valve Plate



Wabco No: 9115056572

**01.649** Crankshaft



M20X1.5 Right Hand



8 680437 025153

**01.1230** Bushing



42X38X23



8 680437 017981

**01.695** Crankshaft Flange



Wabco No: 9115056644

**01.697** Connecting Rod



8 680437 025634

**RK.01.132.00** Piston&Ring (Ø85,00 mm)

- RK.01.132.10 85,25 mm
- RK.01.132.20 85,50 mm
- RK.01.132.30 85,75 mm
- RK.01.132.40 86,00 mm



2,00x2,00x4,00



8 680437 060802

**01.933.00** Piston (Ø85,00 mm)

- 01.933.10 85,25 mm
- 01.933.20 85,50 mm
- 01.933.30 85,75 mm
- 01.933.40 86,00 mm



2,00x2,00x4,00



8 680437 028512

**01.373.00** Ring (Ø85,00 mm)

- 01.373.10 85,25 mm
- 01.373.20 85,50 mm
- 01.373.30 85,75 mm
- 01.373.40 86,00 mm



2,00x2,00x4,00



8 680437 075431

**RK.01.806** Connecting Rod & Piston



Wabco No: 4127049422\*



8 680437 114581

**01.780** Cover



8 680437 026594

**01.1409** Gear



Oem No: 478777 - 470775



8 680437 072539

**00.441** Roller Bearing



6307



8 680437 004547

Oem No : 0697888

Wabco No: 8952510202 - 8107071284

**01.144** Nut



M20X1.5 Right Hand



8 680437 018742

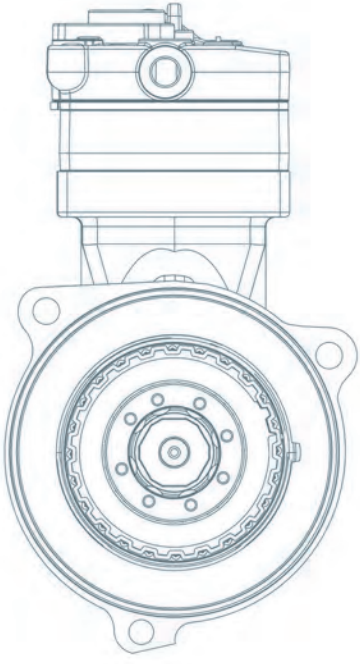

# RENAULT

**HAVA KOMPRESÖRLERİ  
ve TAMİR TAKIMLARI**

AIR COMPRESSORS AND REPAIR KITS



# RENAULT

RENAULT



## Single Cylinder Compressor Ø85 mm-318 CC-Stroke 56 mm

Application - Vehicle  
RENAULT VI

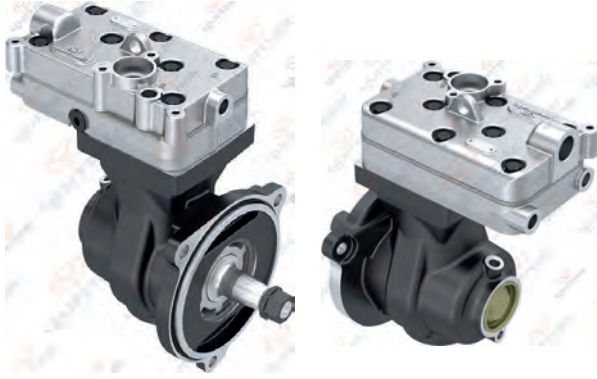

### 01.06.065

**Oem. No.**  
20451724  
21353433  
20451727

**Wabco No.**  
9121120000  
9121120010



### 01.1285 Crankcase



### RK.01.235.07 Repair Kit

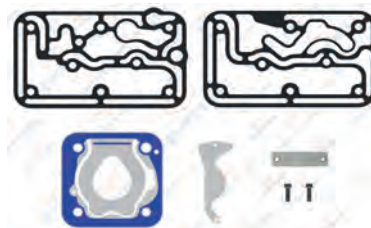

### RK.01.359 Complete Cylinder Head



Wabco No : 4123529202

### RK.01.235.01 Repair Kit

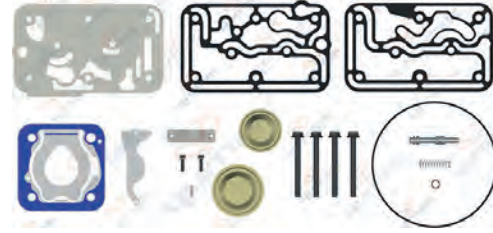

### RK.01.235.02 Repair Kit

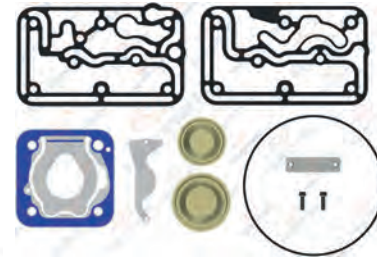

### RK.01.235.03 Repair Kit

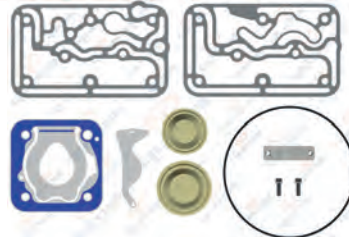

Use for old version cylinder repair kit. Yıpranmış kapaklar için.

### RK.01.235.06 Repair Kit

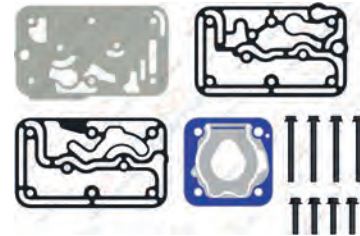

OEM No: 85103938  
Wabco No: 4123520042

### RK.01.180 Repair Kit



**01.583** Cylinder Head



8 680437 024286

**01.281.10** Valve Plate



8 680437 127413

**01.1286** Crankshaft



M20X1.5 Right Hand

8 680437 071761

**01.160** Cooling Plate



8 680437 018902

**01.878** Bushing



Wabco No : 9120003404

8 680437 027898

**01.272** Connecting Rod



Wabco No: 9111457372

8 680437 020400

**RK.01.104.00** Piston&Ring (Ø85,00 mm)

RK.01.104.10	85,25 mm
RK.01.104.20	85,50 mm
RK.01.104.30	85,75 mm
RK.01.104.40	86,00 mm



2,00x2,00x4,00

OEM No: 1283781

8 680437 060277

**01.142.00** Piston (Ø85,00 mm)

01.142.10	85,25 mm
01.142.20	85,50 mm
01.142.30	85,75 mm
01.142.40	86,00 mm



2,00x2,00x4,00

Wabco No: 9115016242 - 9115016252

8 680437 018674

**01.373.00** Ring (Ø85,00 mm)

01.373.10	85,25 mm
01.373.20	85,50 mm
01.373.30	85,75 mm
01.373.40	86,00 mm



2,00x2,00x4,00

Wabco No: 9115019202

8 680437 075431

**01.1227** Bushing



52X48X20

8 680437 017936

**01.144** Nut



M20X1.5 Right Hand

Oem. No : 1698672

Wabco No : 8103410014

8 680437 018742

**01.1551** Gear



149,5 - Z:42

Oem No: 7403161258

8 680437 091172

**RK.01.201** Repair Kit



8 680437 062110

**RK.01.803** Connecting Rod & Piston



Wabco No: 9125189242

8 680437 114567

**RK.01.902** Crankshaft Repair Kit



Wabco No: 9121129212

8 680437 109310



## Single Cylinder Compressor Ø85 mm-318 CC-Stroke 56 mm

Application - Vehicle  
RENAULT VI / UD



**01.06.082**

Oem. No.	Wabco No.
22040500	9121120020
22169884	9121510010
22169886	9121420020

**01.06.082.10**

With Gear



**01.1285** Crankcase



**RK.01.717** Repair Kit



**RK.01.715** Complete Cylinder Head



**RK.01.716.05** Repair Kit

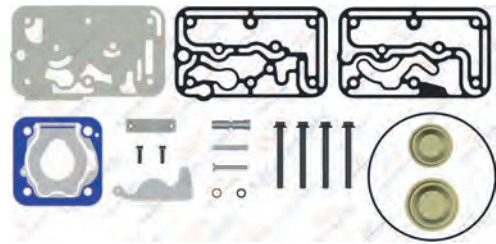

**RK.01.716** Repair Kit

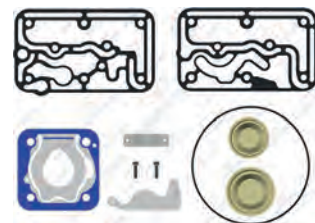

**RK.01.235.06** Repair Kit

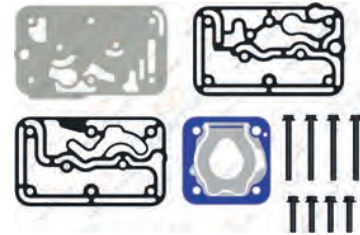

OEM No: 85103938  
Wabco No: 4123520042

**RK.01.716.04** Repair Kit

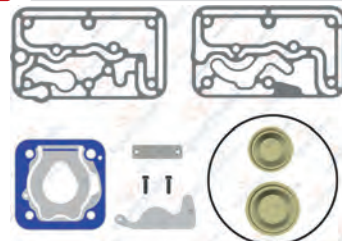

Use for old version cylinder repair kit. Yıpranmış kapaklar için.

**RK.01.718** Repair Kit



**01.583** Cylinder Head



8 680437 024286

**01.1512** Valve Plate



8 680437 082798

**01.1286** Crankshaft



M20X1.5 Right Hand



8 680437 071761

**01.160** Cooling Plate



8 680437 018902

**01.878** Bushing



8 680437 027898

Wabco No: 9120003404

**01.272** Connecting Rod



8 680437 020400

Wabco No: 9111457372

**RK.01.104.00** Piston&Ring (Ø85,00 mm)

- RK.01.104.10 85,25 mm
- RK.01.104.20 85,50 mm
- RK.01.104.30 85,75 mm
- RK.01.104.40 86,00 mm



2,00x2,00x4,00



8 680437 060277

OEM No: 1283781

**01.142.00** Piston (Ø85,00 mm)

- 01.142.10 85,25 mm
- 01.142.20 85,50 mm
- 01.142.30 85,75 mm
- 01.142.40 86,00 mm



2,00x2,00x4,00



8 680437 018674

Wabco No: 9115016242 - 9115016252

**01.373.00** Ring (Ø85,00 mm)

- 01.373.10 85,25 mm
- 01.373.20 85,50 mm
- 01.373.30 85,75 mm
- 01.373.40 86,00 mm



2,00x2,00x4,00



8 680437 075431

Wabco No: 9115019202

**RK.01.180** Repair Kit



8 680437 061830

**01.144** Nut



M20X1.5 Right Hand



8 680437 018742

Oem. No: 1698672  
Wabco No: 8103410014

**01.1551** Gear



149,5 - Z:42



8 680437 091172

Oem. No: 7403161258

**RK.01.235.07** Repair Kit

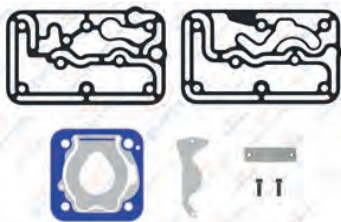

8 680437 122241

**01.302** Cap



8 680437 020769

**01.1232** Cap



8 680437 018001

## Single Cylinder Compressor Ø85 mm-352 CC-Stroke 62 mm

Application - Vehicle  
RENAULT



**01.06.002**

Oem. No.	Wabco No.
85000118	4123520050
85006118	4123520300
85012203	
21353460	
20382348	

**01.06.002.10**

With Gear



**01.341**

Crankcase



**RK.01.103.04**

Repair Kit

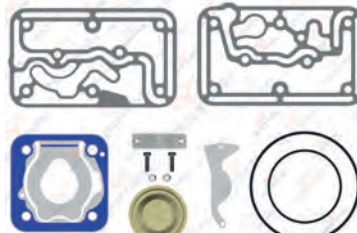

Use for old version cylinder repair kit.  
Yıpranmış kapaklar için.

**RK.01.180**

Repair Kit



**RK.01.168**

Complete Cylinder Head



Wabco No : 4123529212

**RK.01.168.20**

Complete Cylinder Head



**RK.01.103.05**

Repair Kit

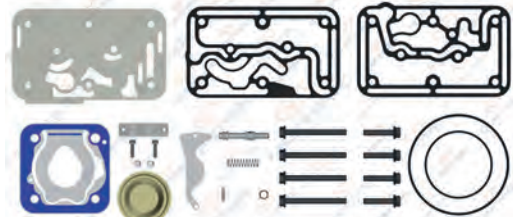

**RK.01.103**

Repair Kit

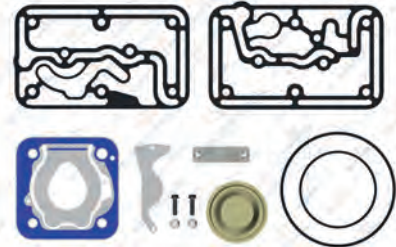

**RK.01.103.02**

Repair Kit

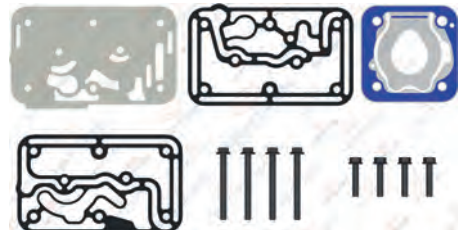

Wabco No: 4123520032



# RENAULT

## AIR COMPRESSOR AND REPAIR KIT

**01.679** Cylinder Head



8 680437 025443

**01.281** Valve Plate



8 680437 020493

**01.275** Crankshaft



M20X1.5 Right Hand



8 680437 020431

**01.861** Cooling Plate



8 680437 027577

**01.847** Crankshaft Flange



8 680437 027423

**01.697** Connecting Rod



8 680437 025634

Wabco No: 9115057322

**RK.01.104.00** Piston&Ring (Ø85,00 mm)

- RK.01.104.10 85,25 mm
- RK.01.104.20 85,50 mm
- RK.01.104.30 85,75 mm
- RK.01.104.40 86,00 mm



2,00x2,00x4,00



8 680437 060277

OEM No : 1283781

**01.142.00** Piston (Ø85,00 mm)

- 01.142.10 85,25 mm
- 01.142.20 85,50 mm
- 01.142.30 85,75 mm
- 01.142.40 86,00 mm

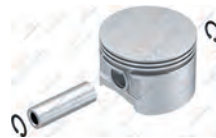

2,00x2,00x4,00



8 680437 018674

Wabco No: 9115016242 - 9115016252

**01.373.00** Ring (Ø85,00 mm)

- 01.373.10 85,25 mm
- 01.373.20 85,50 mm
- 01.373.30 85,75 mm
- 01.373.40 86,00 mm



2,00x2,00x4,00



8 680437 075431

Wabco No: 9115019202

**RK.01.804** Connecting Rod & Piston



8 680437 114666

Wabco No: 4127049422 - 4127049432

**01.279** Bushing



39X35X20



8 680437 020479

**01.280** Gear



8 680437 020486

Oem. No: 8170446

**RK.01.201** Repair Kit



8 680437 062110

**01.302** Cap



8 680437 020769

**01.144** Nut



M20X1.5 Right Hand



8 680437 018742

Oem. No: 8103410014

## Single Cylinder Compressor Ø85 mm-352 CC-Stroke 62 mm

Application - Vehicle  
RENAULT VI



**01.06.003**

Oem. No.	Wabco No.
85000116	4123520040
20478166	4123520290
21353457	

**01.06.003.10**

With Gear



**01.891**

Crankcase



**RK.01.235.07**

Repair Kit

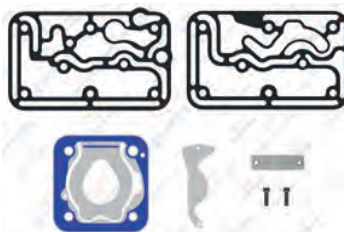

**RK.01.180**

Repair Kit



**RK.01.359.01**

Complete Cylinder Head



Wabco No : 4123529202\*

**RK.01.235.05**

Repair Kit

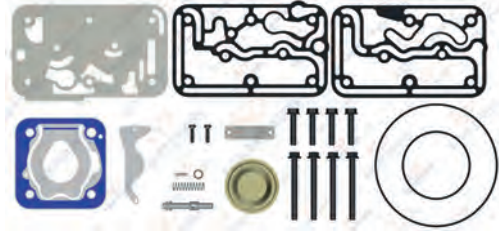

**RK.01.235**

Repair Kit

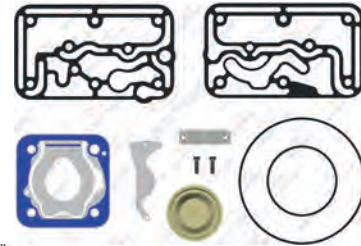

**RK.01.235.04**

Repair Kit

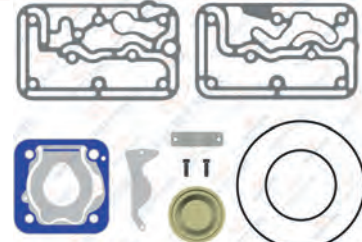

Use for old version cylinder repair kit. Yıpranmış kapaklar için.

**RK.01.235.06**

Repair Kit



OEM No: 85103938  
Wabco No: 4123520042

**01.583** Cylinder Head



8 680437 024286

**01.281.10** Valve Plate



8 680437 127413

**01.991** Crankshaft



M20X1.5 Right Hand

8 680437 029366

**01.160** Cooling Plate



8 680437 018902

**01.847** Crankshaft Flange



8 680437 027423

**01.697** Connecting Rod



Wabco No: 9115057322

8 680437 025634

**RK.01.104.00** Piston&Ring (Ø85,00 mm)

RK.01.104.10	85,25 mm
RK.01.104.20	85,50 mm
RK.01.104.30	85,75 mm
RK.01.104.40	86,00 mm



2,00x2,00x4,00

OEM No: 1283781

8 680437 060277

**01.142.00** Piston (Ø85,00 mm)

01.142.10	85,25 mm
01.142.20	85,50 mm
01.142.30	85,75 mm
01.142.40	86,00 mm



2,00x2,00x4,00

Wabco No: 9115016242 - 9115016252

8 680437 018674

**01.373.00** Ring (Ø85,00 mm)

01.373.10	85,25 mm
01.373.20	85,50 mm
01.373.30	85,75 mm
01.373.40	86,00 mm



2,00x2,00x4,00

Wabco No: 9115019202

8 680437 075431

**01.302** Cap



8 680437 020769

**01.279** Bushing



39X35X20

8 680437 020479

**01.1551** Gear



149,5 - Z:42

Oem. No: 7403161258

8 680437 091172

**RK.01.201** Repair Kit



8 680437 062110

**RK.01.804** Connecting Rod & Piston



Wabco No: 4127049422 - 4127049432

8 680437 114666

**RK.01.904** Crankshaft Repair Kit



8 680437 109235



## Twin Cylinder Compressor Ø92 mm-720 CC-Stroke 54 mm

Application - Vehicle  
RENAULT



01.04.144

01.04.143

### 01.04.144 - 01.04.143

**Oem. No.**

7421098922  
7485003045  
21101027  
04905532  
04905533

**Knorr No.**

LK4944-K017527000  
LK4954-K017528



**01.1385**

**Crankcase**



**RK.01.264.06**

**Repair Kit**

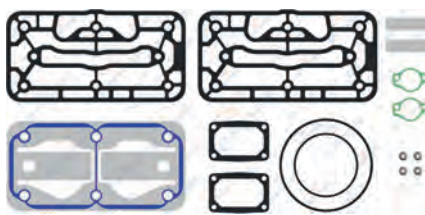

Knorr No: K012086

**RK.01.264.02**

**Repair Kit**

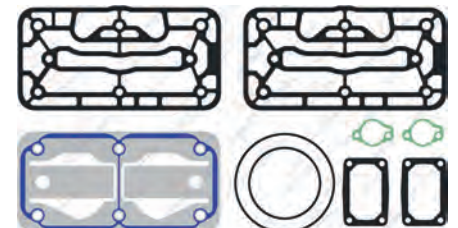

**RK.01.670**

**Complete Cylinder Head**



**RK.01.670.01**

**Complete Cylinder Head**



**RK.01.568**

**Valve Plate Kit**

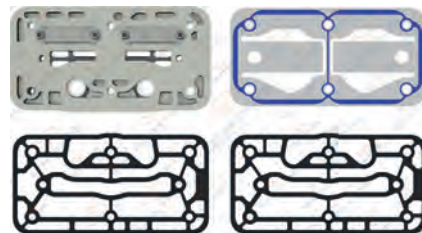

**RK.01.264.01**

**Repair Kit**

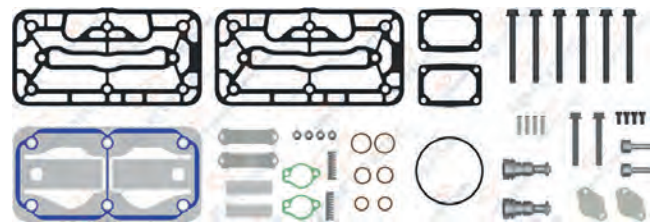

**RK.01.264**

**Repair Kit**

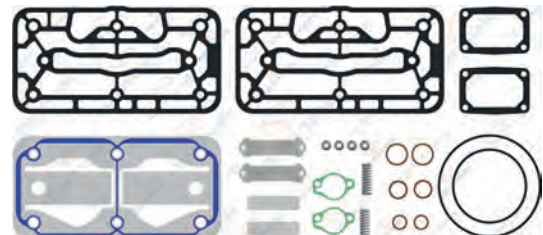

# RENAULT

## AIR COMPRESSOR AND REPAIR KIT

01.1444

Cylinder Head



Knorr No: K017529

01.1161

Cooling Plate



01.1337

Crankshaft



M20X1.5 Right Hand



01.1162

Valve Plate



Knorr No: K012074

01.1206

Crankshaft Flange



01.1056

Connecting Rod



RK.01.318.00

Piston&Ring (Ø92,00 mm)

- RK.01.318.10 92,25 mm
- RK.01.318.20 92,50 mm
- RK.01.318.30 92,75 mm
- RK.01.318.40 93,00 mm



2.50x2,50x4,00



Knorr No: K012079

01.862.00

Piston (Ø92,00 mm)

- 01.862.10 92,25 mm
- 01.862.20 92,50 mm
- 01.862.30 92,75 mm
- 01.862.40 93,00 mm



2.50x2,50x4,00



01.942.00

Ring (Ø92,00 mm)

- 01.942.10 92,25 mm
- 01.942.20 92,50 mm
- 01.942.30 92,75 mm
- 01.942.40 93,00 mm



2.50x2,50x4,00



01.374

Cover



01.292

Bushing



42X38X25



51.01.008

Safety Valve



RK.01.428

Repair Kit

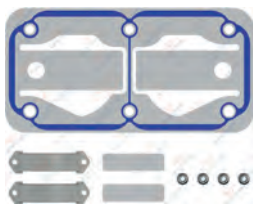

RK.01.558

Repair Kit

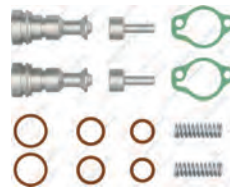

Knorr No: K034874K50

RK.01.813

Connecting Rod & Piston





## Twin Cylinder Compressor Ø85 mm-636 CC-Stroke 56 mm

Application - Vehicle  
RENAULT 430 / 440

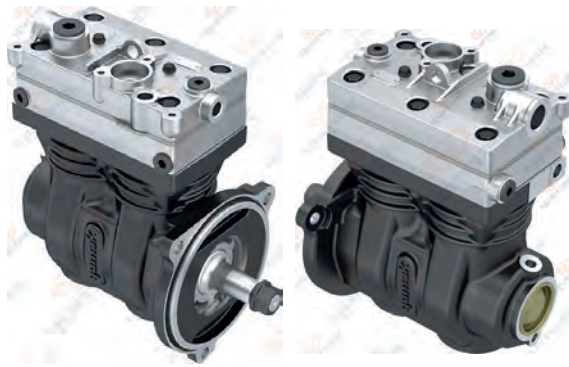

### 01.05.073

Oem. No.	Wabco No.
20524352	9125140010
20733968	9125120040
20774360	9125140040
21175029	9125120080
20846000	9125140030
20774294	

### 01.05.073.10

With Gear



### 01.877

Crankcase



### RK.01.352.11

Repair Kit

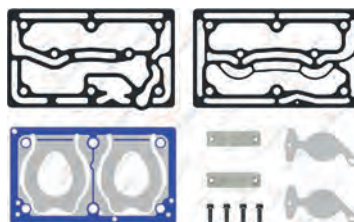

### RK.01.418

Repair Kit

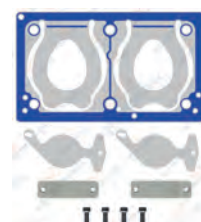

### RK.01.361

Complete Cylinder Head

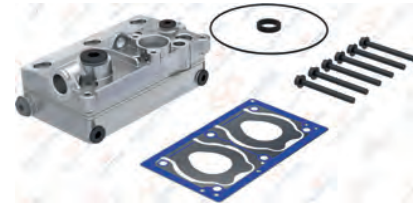

OEM No: 7421418150

Wabco No: 4127049402 - 9125129242 - 9125129252 - 9125129262



### RK.01.352.05

Repair Kit

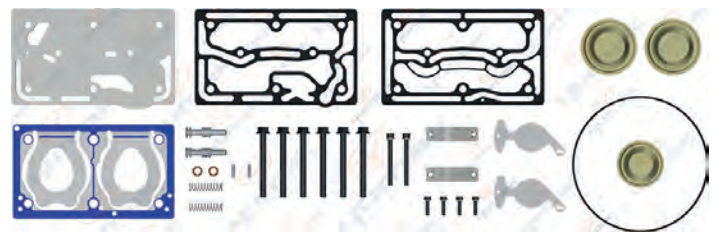

### RK.01.352.10

Repair Kit

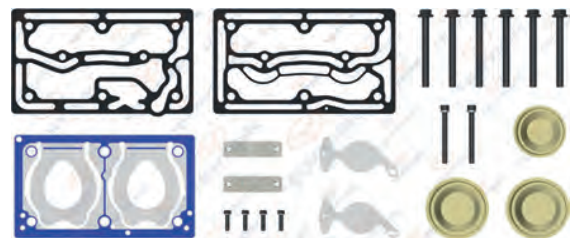

Wabco No : 9125129282

### RK.01.352

Repair Kit

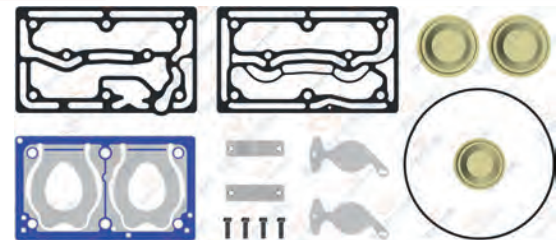

### RK.01.352.19

Repair Kit

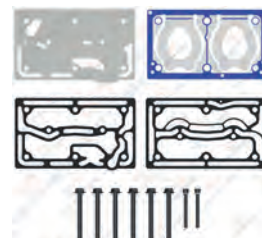

Wabco No : 9125129272 - 4127049382



**01.874** Cylinder Head



8 680437 027836

**01.1284** Valve Plate



8 680437 027220

**01.876** Crankshaft



M20X1.5 Right Hand  
8 680437 027874

**01.565** Cooling Plate



8 680437 024095

**01.878** Bushing



Wabco No: 9120003404  
8 680437 027898

**01.272** Connecting Rod



Wabco No: 9111457372  
8 680437 020400

**RK.01.104.00** Piston&Ring (Ø85,00 mm)

RK.01.104.10	85,25 mm
RK.01.104.20	85,50 mm
RK.01.104.30	85,75 mm
RK.01.104.40	86,00 mm



2,00x2,00x4,00  
OEM No: 1283781  
8 680437 060277

**01.142.00** Piston (Ø85,00 mm)

01.142.10	85,25 mm
01.142.20	85,50 mm
01.142.30	85,75 mm
01.142.40	86,00 mm



2,00x2,00x4,00  
Wabco No: 9115016242 - 9115016252  
8 680437 018674

**01.373.00** Ring (Ø85,00 mm)

01.373.10	85,25 mm
01.373.20	85,50 mm
01.373.30	85,75 mm
01.373.40	86,00 mm



2,00x2,00x4,00  
Wabco No: 9115019202  
8 680437 075431

**01.144** Nut



M20X1.5 Right Hand  
Oem. No: 8103410014  
8 680437 018742

**01.1227** Bushing



52X48X20  
8 680437 017936

**01.1551** Gear



149,5 - Z:42  
Oem. No: 7403161258  
8 680437 091172

**RK.01.512** Repair Kit



8 680437 066040

**RK.01.803** Connecting Rod & Piston



Wabco No: 9125189242  
8 680437 114567

**RK.01.905** Crankshaft Repair Kit



Wabco No: 9125129302  
8 680437 109242

## Twin Cylinder Compressor Ø78 mm-500 CC-Stroke 52 mm

### Application - Vehicle

RENAULT RVI / MAGNUM RVI / MAJOR / C270 / G280  
R312 PREMIUM G340 / R322 / AE / KERAX  
MAGNUM RVI C270 / 380 / 400 / 420 / 440 / 430 / 460 SISU

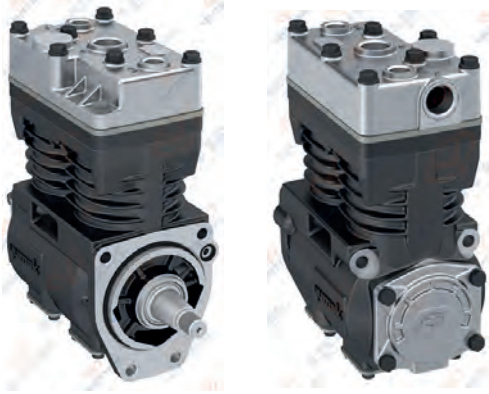

**01.05.029**

Oem. No.	Knorr No.
5010295545	LP4845-SEB01455000
5001836982	LP4827-SEB01452
5010323738	LP4828-SEB01463
5010295545	LP4833-SEB01485AT
7485003210	LP4843-SEB01430

**01.05.029.10**

With Gear



**01.773** Crankcase



**RK.01.195** Repair Kit

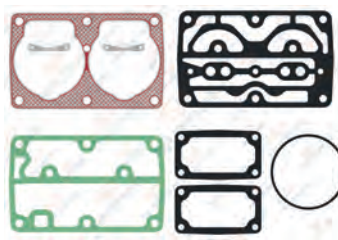

Knorr No: SEB22554

**RK.01.156.04** Repair Kit

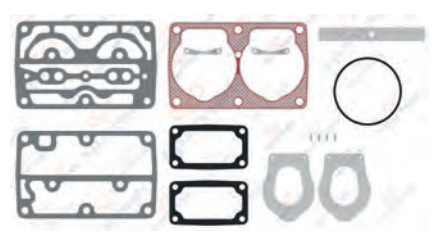

Use for old version cylinder repair kit.  
Yıpranmış kapaklar için.

**RK.01.251**

Complete Cylinder Head



**RK.01.189.01**

Valve Plate Kit

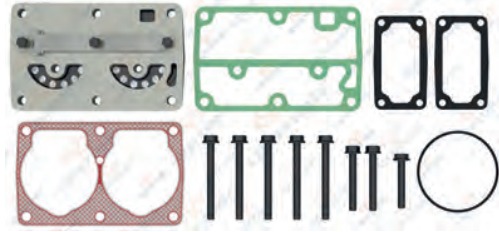

**RK.01.189**

Valve Plate Kit



OEM No : 5001836883  
Knorr No: SEB01511004

**RK.01.156.01**

Repair Kit

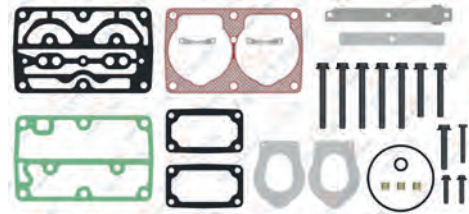

**RK.01.156**

Repair Kit



OEM No : 5001867708 - 5001867709  
Knorr No: SEB22553

**01.746** Cylinder Head



8 680437 026136  
**OEM No:** 5001867712  
**Knorr No:** SEB22583

**01.774** Crankshaft Flange



8 680437 026532  
**OEM No:** 5001830851  
**Knorr No:** EB01490R

**01.772** Crankshaft



**M18X1.5 - Right Hand**  
 8 680437 026518  
**OEM No:** 5001834292  
**Knorr No:** EB014931R

**RK.01.189.02** Valve Plate Kit



8 680437 112527

**01.292** Bushing



**42X38X25**  
 8 680437 073871  
**OEM No:** 5001830853

**01.745** Connecting Rod



8 680437 026129  
**OEM No:** 5001830854  
**Knorr No:** SEB00859R

**RK.01.271.00** Piston&Ring (Ø78,00 mm)

- RK.01.271.10** 78,25 mm
- RK.01.271.20** 78,50 mm
- RK.01.271.30** 78,75 mm
- RK.01.271.40** 79,00 mm



**2.50x2,50x4,00**  
 8 680437 063148  
**OEM No:** 5001830855 - 5001831273  
**Knorr No:** SEB22551 - SEB22552

**01.767.00** Piston (Ø78,00 mm)

- 01.767.10** 78,25 mm
- 01.767.20** 78,50 mm
- 01.767.30** 78,75 mm
- 01.767.40** 79,00 mm

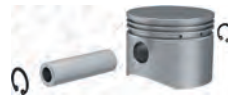

**2.50x2,50x4,00**  
 8 680437 026358

**01.768.00** Ring (Ø78,00 mm)

- 01.768.10** 78,25 mm
- 01.768.20** 78,50 mm
- 01.768.30** 78,75 mm
- 01.768.40** 79,00 mm



**2.50x2,50x4,00**  
 8 680437 026419

**01.752** Nut



**M18X1.5 - Right Hand**  
 8 680437 026204

**01.414** Cover



8 680437 022312

**01.1426** Gear



8 680437 071747  
**OEM No:** 5000686842

**RK.01.057** Repair Kit



8 680437 059172

**RK.01.814** Connecting Rod & Piston



8 680437 114642



## Twin Cylinder Compressor Ø78 mm-500 CC-Stroke 52 mm

Application - Vehicle  
RENAULT PREMIUM  
PUNCHER

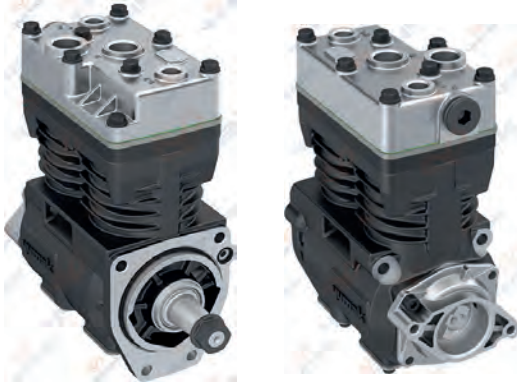

**01.05.061**

Oem. No.  
5010553129  
5010450646  
74850033207

Knorr No.  
LP4855-SEB01747



**01.773**

Crankcase



**RK.01.195**

Repair Kit



Knorr No: SEB22554

**RK.01.284** Complete Cylinder Head



**RK.01.189.01**

Valve Plate Kit

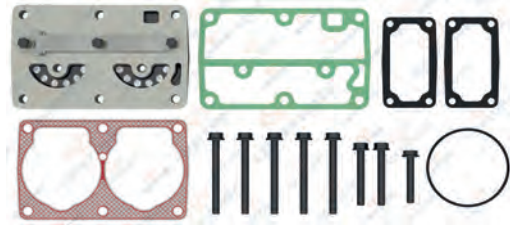

**RK.01.189**

Valve Plate Kit



OEM No: 5001836883  
Knorr No: SEB01511004

**RK.01.156.01**

Repair Kit

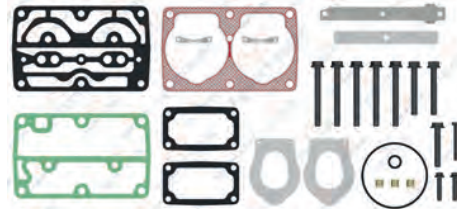

**RK.01.156**

Repair Kit

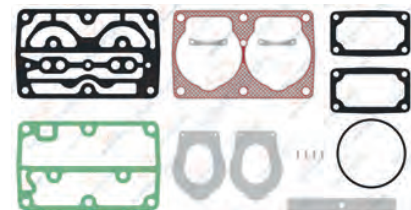

OEM No: 5001867708 - 5001867709  
Knorr No: SEB22553

**RK.01.156.04**

Repair Kit

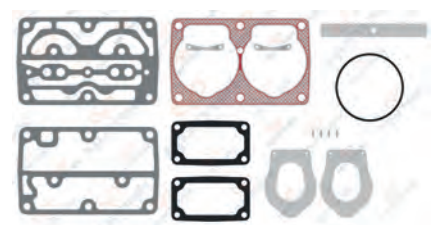

Use for old version cylinder repair kit.  
Yıpranmış kapaklar için.

# RENAULT

## AIR COMPRESSOR AND REPAIR KIT

### 01.746.10 Cylinder Head



Knorr No: SEB22584

### 01.1447 Crankshaft Flange



### 01.1465 Crankshaft



M18X1.5 - Right Hand



### RK.01.189.02 Valve Plate Kit



### 01.292 Bushing



42X38X25



OEM No: 5001830853

### 01.745 Connecting Rod



OEM No: 5001830854  
Knorr No: SEB00859R

### RK.01.271.00 Piston&Ring (Ø78,00 mm)

- RK.01.271.10 78,25 mm
- RK.01.271.20 78,50 mm
- RK.01.271.30 78,75 mm
- RK.01.271.40 79,00 mm



2.50x2,50x4,00



OEM No: 5001830855 - 5001831273  
Knorr No: SEB22551 SEB22552

### 01.767.00 Piston (Ø78,00 mm)

- 01.767.10 78,25 mm
- 01.767.20 78,50 mm
- 01.767.30 78,75 mm
- 01.767.40 79,00 mm

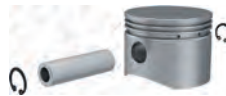

2.50x2,50x4,00



### 01.768.00 Ring (Ø78,00 mm)

- 01.768.10 78,25 mm
- 01.768.20 78,50 mm
- 01.768.30 78,75 mm
- 01.768.40 79,00 mm



2.50x2,50x4,00



### RK.01.814 Connecting Rod & Piston



### 01.414 Cover



### 01.752 Nut



M18X1.5 - Right Hand



### RK.01.057 Repair Kit



## Twin Cylinder Compressor Ø78 mm-500 CC-Stroke 52 mm

**Application - Vehicle**  
PREMIUM 420 MAGNUM 390/430/470, E-TECH  
400/440/480 KERAX, SISU

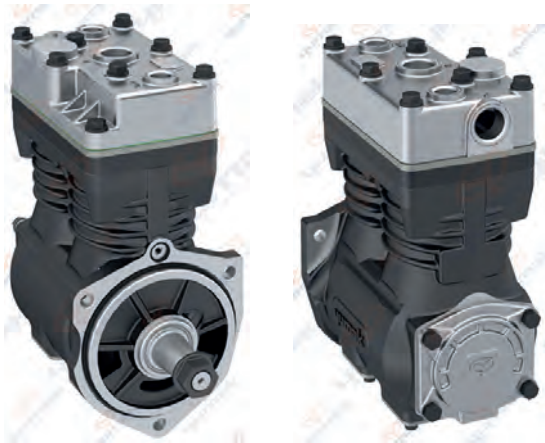

**01.05.060**

Oem. No.	Knorr No.
7485003211 5010339859	LP4851-SEB01545000

**01.05.060.10**

With Gear



**01.1311** Crankcase



**RK.01.195** Repair Kit

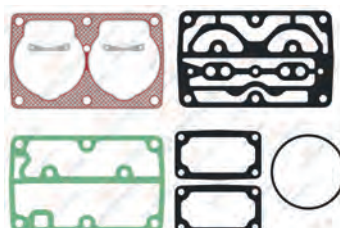

**RK.01.057** Repair Kit



**RK.01.251** Complete Cylinder Head



**RK.01.189.01** Valve Plate Kit

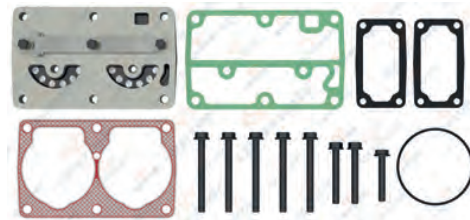

**RK.01.189** Valve Plate Kit



**RK.01.156.01** Repair Kit

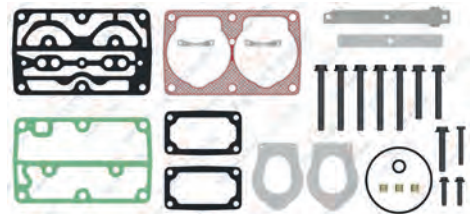

**RK.01.156** Repair Kit

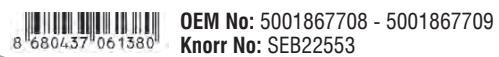



# RENAULT

## AIR COMPRESSOR AND REPAIR KIT

### 01.746 Cylinder Head



8 680437 026136 **OEM No:** 5001867712  
**Knorr No:** SEB22583

### RK.01.189.02 Valve Plate Kit



8 680437 112327

### 01.772 Crankshaft



M18X1.5 - Right Hand  
8 680437 026518 **OEM No:** 5001834292  
**Knorr No:** EB014931R

### 01.292 Bushing



42X38X25  
8 680437 073871 **OEM No:** 5001830853

### 01.774 Crankshaft Flange



8 680437 026532 **OEM No:** 5001830851  
**Knorr No:** EB01490R

### 01.745 Connecting Rod



8 680437 026129 **OEM No:** 5001830854  
**Knorr No:** SEB00859R

### RK.01.271.00 Piston&Ring (Ø78,00 mm)

- RK.01.271.10 78,25 mm
- RK.01.271.20 78,50 mm
- RK.01.271.30 78,75 mm
- RK.01.271.40 79,00 mm



2.50x2,50x4,00  
8 680437 063148 **OEM No:** 5001830855 - 5001831273  
**Knorr No:** SEB22551 SEB22552

### 01.767.00 Piston (Ø78,00 mm)

- 01.767.10 78,25 mm
- 01.767.20 78,50 mm
- 01.767.30 78,75 mm
- 01.767.40 79,00 mm



2.50x2,50x4,00  
8 680437 026358

### 01.768.00 Ring (Ø78,00 mm)

- 01.768.10 78,25 mm
- 01.768.20 78,50 mm
- 01.768.30 78,75 mm
- 01.768.40 79,00 mm



2.50x2,50x4,00  
8 680437 026419

### RK.01.814 Connecting Rod & Piston



8 680437 114642

### 01.414 Cover



8 680437 022312

### 01.913 Gear



8 680437 028345 **OEM No:** 5010240933

### 01.752 Nut



M18X1.5 - Right Hand  
8 680437 026204

## Twin Cylinder Compressor Ø75 mm-442 CC-Stroke 50 mm

**Application - Vehicle**  
RENAULT 420 / PREMIUM TRACTEUR KE-  
RAX PREMIUM PR 4X2 MAGNUM E-TECH  
400 / 440 / 480



**01.05.072**

**Oem. No.**  
5600621115  
5010550086  
1522159

**Wabco No.**  
4124420000

**01.05.072.10**

Without Gear



**01.441**

Crankcase



**RK.01.161.04**

Repair Kit

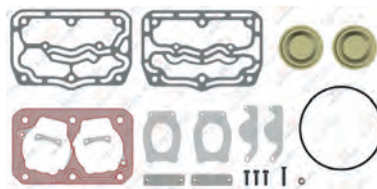

Use for old version cylinder repair kit.  
Yıpranmış kapaklar için.

**RK.01.107**

Repair Kit



**RK.01.171**

Complete Cylinder Head



OEM No : 5001859253  
Wabco No : 4124420002

**RK.01.161.05**

Repair Kit

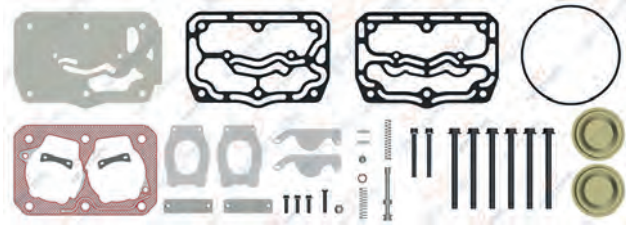

**RK.01.161.02**

Repair Kit

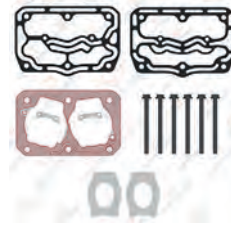

Wabco No: 9115049252

**RK.01.161**

Repair Kit

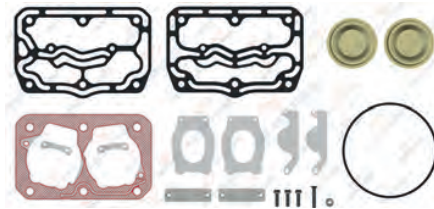

**RK.01.161.06**

Repair Kit



# RENAULT

## AIR COMPRESSOR AND REPAIR KIT

**01.438** Cylinder Head



8 680437 022596

**01.439** Valve Plate



8 680437 022619

**01.442** Crankshaft



M20X1.5 Right Hand



8 680437 022640

**01.696** Cooling Plate



8 680437 025627

**01.443** Bushing



8 680437 022657

**01.326** Connecting Rod



8 680437 021131

**RK.01.118.00** Piston&Ring (Ø75,00 mm)

- RK.01.118.10 75,25 mm
- RK.01.118.20 75,50 mm
- RK.01.118.30 75,75 mm
- RK.01.118.40 76,00 mm



2,00x2,00x4,00



OEM No:0513860-1242704-5000816053  
Wabco No: 4111416232

**01.911.00** Piston (Ø75,00 mm)

- 01.911.10 75,25 mm
- 01.911.20 75,50 mm
- 01.911.30 75,75 mm
- 01.911.40 76,00 mm



2,00x2,00x4,00



8 680437 028277

**01.134.00** Ring (Ø75,00 mm)

- 01.134.10 75,25 mm
- 01.134.20 75,50 mm
- 01.134.30 75,75 mm
- 01.134.40 76,00 mm



2,00x2,00x4,00



OEM No : 1391384-1391385  
Knorr No : I801770061

**RK.01.811** Connecting Rod & Piston



8 680437 114628

Wabco No: 9115049322

**01.1123** Bushing



59X55X18



8 680437 016458

Wabco No: 9111552004

**01.913** Gear



8 680437 028345

OEM No: 5010240933

**RK.01.220** Repair Kit



8 680437 062532

**01.144** Nut



M20X1.5 Right Hand



8 680437 018742

Wabco No: 8103410014

**01.302** Cap



8 680437 020769



## Twin Cylinder Compressor Ø75 mm-442 CC-Stroke 50 mm

### Application - Vehicle

RENAULT PREMIUM / TRACTEUR KERAX / PREMIUM  
PR 4x2 MAGNUM E-TECH 400 / 440 / 480



**01.05.040**

Oem. No.  
5010437567

Wabco No.  
4124420010



**01.1243** Crankcase



**RK.01.161.04** Repair Kit

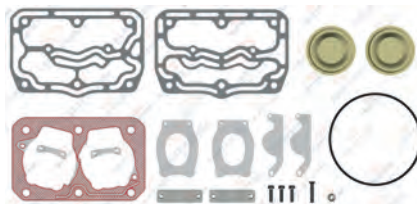

Use for old version cylinder repair kit.  
Yıpranmış kapaklar için.

**RK.01.107** Repair Kit



**RK.01.171**

Complete Cylinder Head



OEM No : 5001859253  
Wabco No : 4124420002

**RK.01.161.05**

Repair Kit

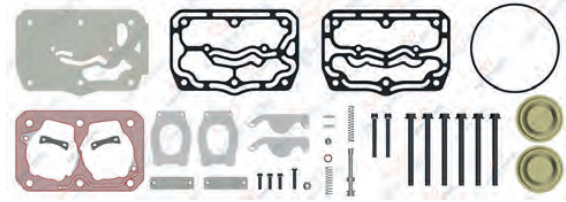

**RK.01.161.02**

Repair Kit



Wabco No: 9115049252

**RK.01.161**

Repair Kit

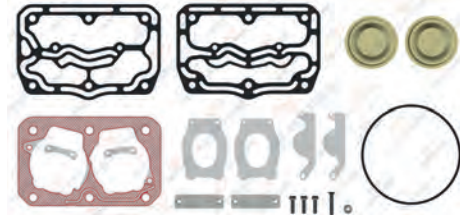

**RK.01.161.06**

Repair Kit



**01.438** Cylinder Head



8 680437 022596

**01.439** Valve Plate



8 680437 022619

**01.1244** Crankshaft



8 680437 080558

**01.696** Cooling Plate



8 680437 025627

**RK.01.811** Connecting Rod & Piston



8 680437 114628

Wabco No: 9115049322

**01.326** Connecting Rod



8 680437 021131

**RK.01.118.00** Piston&Ring (Ø75,00 mm)

- RK.01.118.10 75,25 mm
- RK.01.118.20 75,50 mm
- RK.01.118.30 75,75 mm
- RK.01.118.40 76,00 mm



2,00x2,00x4,00



8 680437 060482

OEM No:0513860-1242704-5000816053  
Wabco No: 4111416232

**01.911.00** Piston (Ø75,00 mm)

- 01.911.10 75,25 mm
- 01.911.20 75,50 mm
- 01.911.30 75,75 mm
- 01.911.40 76,00 mm



2,00x2,00x4,00



8 680437 028277

**01.134.00** Ring (Ø75,00 mm)

- 01.134.10 75,25 mm
- 01.134.20 75,50 mm
- 01.134.30 75,75 mm
- 01.134.40 76,00 mm



2,00x2,00x4,00



8 680437 018278

OEM No : 1391384-1391385  
Knorr No: I801770061

**RK.01.220** Repair Kit



8 680437 062332

**01.1123** Bushing



59X55X18



8 680437 016458

Wabco No: 9111552004

**01.1245** Bushing



8 680437 073352

**01.335** Pressure valve



8 680437 021230

**01.302** Cap



8 680437 020769

## Twin Cylinder Compressor Ø85 mm-704 CC-Stroke 62 mm

Application - Vehicle  
RENAULT MAGNUM DXI

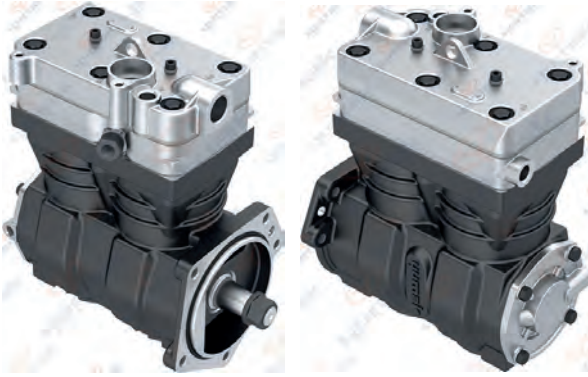

**01.06.004**

Oem. No.	Wabco No.
7420701801	4127040080
7420569224	4127040040
5021209007	4127040050
	4127040090
	4127040010

**01.06.004.10**

With Gear



**01.290**

Crankcase



**RK.01.122.01**

Repair Kit

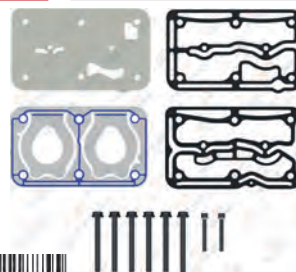

**RK.01.122.02**

Repair Kit

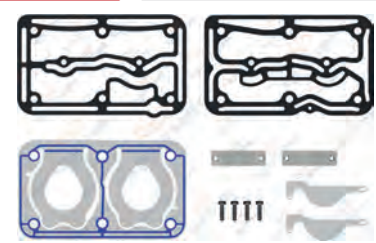

**RK.01.167**

Complete Cylinder Head



OEM No : 7420701803  
Wabco No : 4127049322

**RK.01.167.20**

Complete Cylinder Head



**RK.01.122.05**

Repair Kit

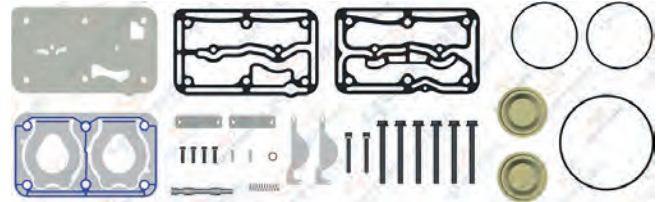

**RK.01.122**

Repair Kit

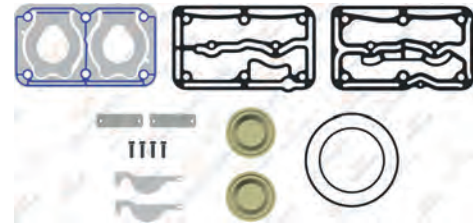

**RK.01.122.04**

Repair Kit

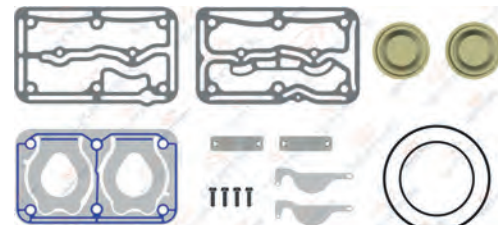

Use for old version cylinder repair kit. Yıpranmış kapaklar için.



**01.485** Cylinder Head



8 680437 023180

**01.426.20** Valve Plate



8 680437 101130

**01.584** Crankshaft



M20X1.5 Right Hand



8 680437 024293

**01.303** Cooling Plate



8 680437 071570

**01.284** Crankshaft Flange



8 680437 020547

**01.697** Connecting Rod



8 680437 025634

Wabco No: 9115057322

**RK.01.104.00** Piston&Ring (Ø85,00 mm)

- RK.01.104.10 85,25 mm
- RK.01.104.20 85,50 mm
- RK.01.104.30 85,75 mm
- RK.01.104.40 86,00 mm



2,00x2,00x4,00



8 680437 060277

OEM No: 1283781

**01.142.00** Piston (Ø85,00 mm)

- 01.142.10 85,25 mm
- 01.142.20 85,50 mm
- 01.142.30 85,75 mm
- 01.142.40 86,00 mm



2,00x2,00x4,00



8 680437 018674

Wabco No: 9115016242 - 9115016252

**01.373.00** Ring (Ø85,00 mm)

- 01.373.10 85,25 mm
- 01.373.20 85,50 mm
- 01.373.30 85,75 mm
- 01.373.40 86,00 mm



2,00x2,00x4,00



8 680437 075431

Wabco No: 9115019202

**RK.01.804** Connecting Rod & Piston



8 680437 114666

Wabco No: 4127049422 - 4127049432

**RK.01.906** Crankshaft Repair Kit



8 680437 109259

**01.280** Gear



8 680437 020486

OEM No : 7408170446

**RK.01.181** Repair Kit

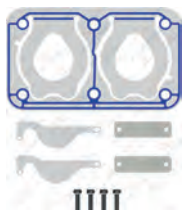

8 680437 061847

**01.115** Bushing



42X38X24.5



8 680437 077121

**01.144** Nut



M20X1.5 Right Hand



8 680437 018742

Wabco No : 8103410014

## Twin Cylinder Compressor Ø85 mm-704 CC-Stroke 62 mm

Application - Vehicle  
RENAULT 480



### 01.06.059

Oem. No.	Wabco No.
21379906	4127040180
20845313	4127040230
21172036	
85003282	
85000615	

### 01.06.059.10

With Gear



### 01.1349 Crankcase



### RK.01.352.11 Repair Kit

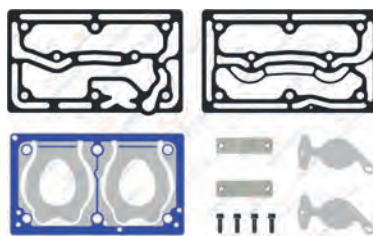

### RK.01.418 Repair Kit

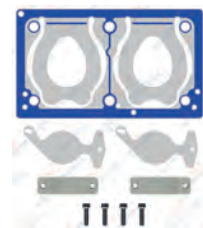

### RK.01.361 Complete Cylinder Head

Complete Cylinder Head

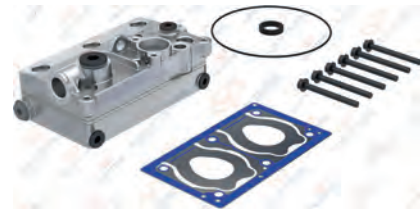

OEM No: 7421418150

Wabco No: 4127049402 - 9125129242 - 9125129252 - 9125129262



### RK.01.352.05 Repair Kit

Repair Kit

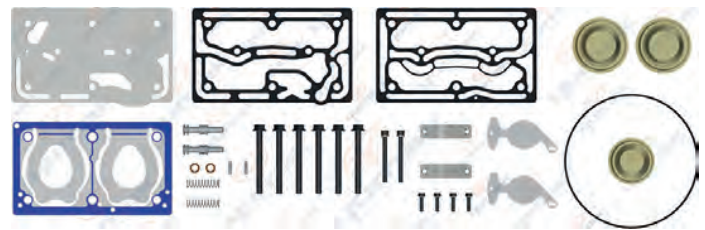

### RK.01.352.10 Repair Kit

Repair Kit

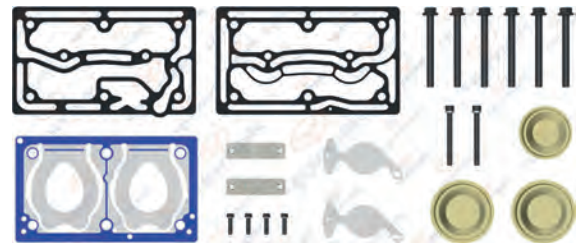

### RK.01.352 Repair Kit

Repair Kit

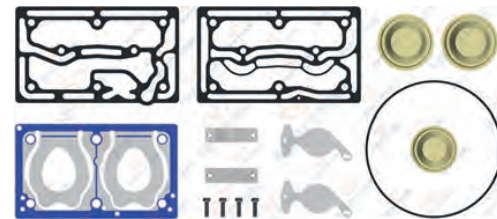

### RK.01.352.19 Repair Kit

Repair Kit

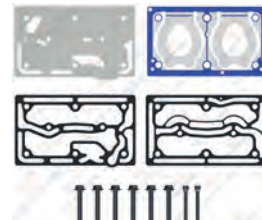

Wabco No : 9125129272 - 4127049382

**01.874** Cylinder Head



8 680437 027836

**01.1284** Valve Plate



8 680437 027220

**01.1410** Crankshaft



M20X1.5 Right Hand  
8 680437 079521

**01.565** Cooling Plate



8 680437 024095

**01.878** Bushing



Wabco No: 9120003404  
8 680437 027898

**01.390.10** Connecting Rod



8 680437 128595

**RK.01.104.00** Piston&Ring (Ø85,00 mm)

RK.01.104.10	85,25 mm
RK.01.104.20	85,50 mm
RK.01.104.30	85,75 mm
RK.01.104.40	86,00 mm



2,00x2,00x4,00  
OEM No: 1283781  
8 680437 060277

**01.142.00** Piston (Ø85,00 mm)

01.142.10	85,25 mm
01.142.20	85,50 mm
01.142.30	85,75 mm
01.142.40	86,00 mm



2,00x2,00x4,00  
Wabco No: 9115016242 - 9115016252  
8 680437 018674

**01.373.00** Ring (Ø85,00 mm)

01.373.10	85,25 mm
01.373.20	85,50 mm
01.373.30	85,75 mm
01.373.40	86,00 mm



2,00x2,00x4,00  
Wabco No: 9115019202  
8 680437 075431

**RK.01.803** Connecting Rod & Piston



Wabco No: 9125189242  
8 680437 114567

**RK.01.907** Crankshaft Repair Kit



8 680437 109266

**01.1551** Gear



149,5 - Z:42  
Oem No: 7403161258  
8 680437 091172

**RK.01.512** Repair Kit



8 680437 066040

**01.302** Cap



8 680437 020769

**01.1232** Cap



8 680437 018001



## Twin Cylinder Compressor Ø85 mm-704 CC-Stroke 62 mm

Application - Vehicle  
RENAULT

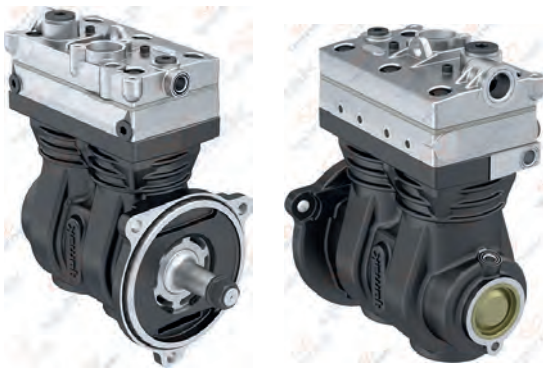

**01.06.085**

**Oem. No.**  
21379906  
20845313  
21172036  
85003282  
85000615

**Wabco No.**  
4127040270



**01.1349**

Crankcase



**RK.01.352.11**

Repair Kit

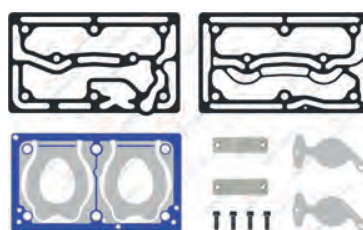

**RK.01.713**

Repair Kit



**RK.01.711**

Complete Cylinder Head



Wabco No : 9125129352

**RK.01.712.05**

Repair Kit

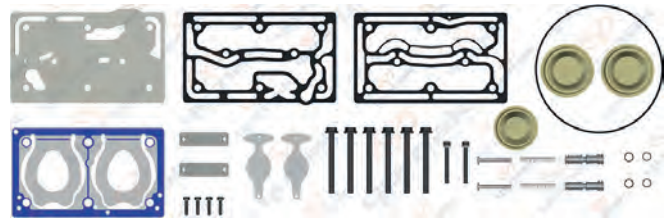

**RK.01.712.01**

Repair Kit

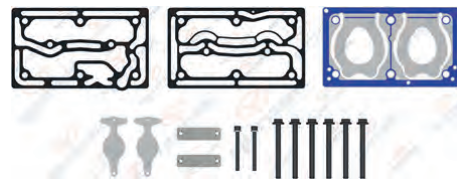

Wabco No: 9125129362

**RK.01.712**

Repair Kit

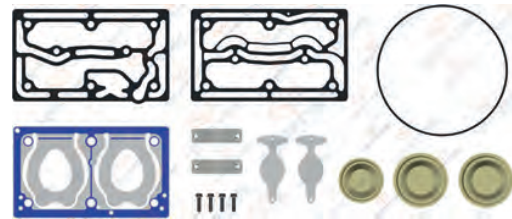

**RK.01.352.19**

Repair Kit

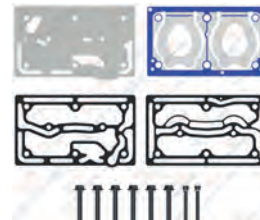

Wabco No : 9125129272 - 4127049382

**01.874** Cylinder Head



8 680437 027836

**01.1478** Valve Plate



8 680437 077459

**01.1410** Crankshaft



M20X1.5 Right Hand



8 680437 079521

**01.565** Cooling Plate



8 680437 024095

**01.878** Bushing



8 680437 027898

Wabco No: 9120003404

**01.272** Connecting Rod



8 680437 020400

Wabco No: 9111457372

**RK.01.104.00** Piston&Ring (Ø85,00 mm)

- RK.01.104.10 85,25 mm
- RK.01.104.20 85,50 mm
- RK.01.104.30 85,75 mm
- RK.01.104.40 86,00 mm



2,00x2,00x4,00



8 680437 060277

OEM No: 1283781

**01.142.00** Piston (Ø85,00 mm)

- 01.142.10 85,25 mm
- 01.142.20 85,50 mm
- 01.142.30 85,75 mm
- 01.142.40 86,00 mm



2,00x2,00x4,00



8 680437 018674

Wabco No: 9115016242 - 9115016252

**01.373.00** Ring (Ø85,00 mm)

- 01.373.10 85,25 mm
- 01.373.20 85,50 mm
- 01.373.30 85,75 mm
- 01.373.40 86,00 mm



2,00x2,00x4,00



8 680437 075431

Wabco No: 9115019202

**RK.01.803** Connecting Rod & Piston



8 680437 114567

Wabco No: 9125189242

**RK.01.907** Crankshaft Repair Kit



8 680437 109266

**01.1551** Gear



149,5 - Z:42



8 680437 091172

Oem No: 7403161258

**RK.01.714** Repair Kit



8 680437 077244

**01.1227** Bushing



52X48X20



8 680437 017936

**01.144** Nut



M20X1.5 Right Hand



8 680437 018742

Wabco No: 8103410014

## Twin Cylinder Compressor Ø85 mm-636 CC-Stroke 56 mm

Application - Vehicle  
RENAULT 430 / 440

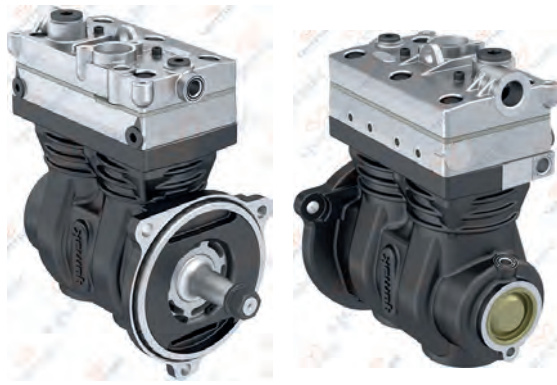

### 01.06.081

Oem. No.	Wabco No.
22016995	9125140090
22062019	
22062021	
22062020	



### 01.877 Crankcase



### RK.01.352.11 Repair Kit

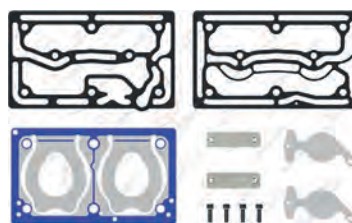

### RK.01.713 Repair Kit



### RK.01.711 Complete Cylinder Head



### RK.01.712.05 Repair Kit

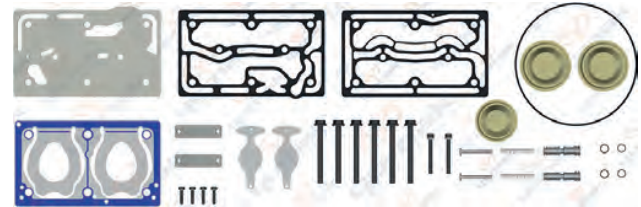

### RK.01.712.01 Repair Kit

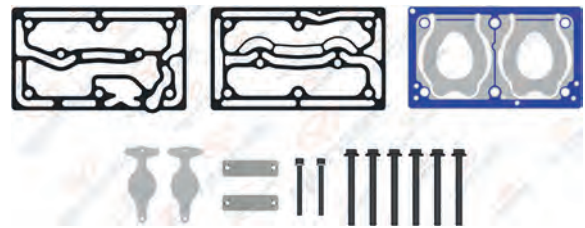

### RK.01.712 Repair Kit

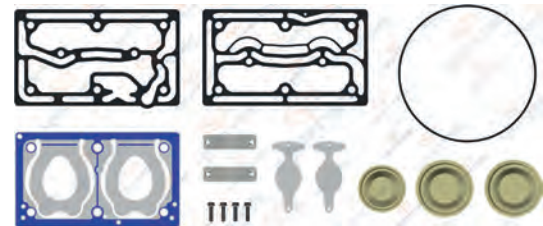

### RK.01.352.19 Repair Kit

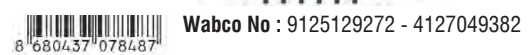
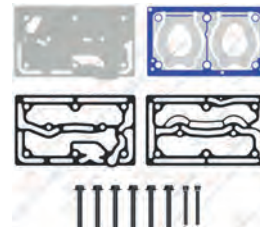



**01.874** Cylinder Head



8 680437 027836

**01.1478** Valve Plate



8 680437 077459

**01.876** Crankshaft



M20X1.5 Right Hand



8 680437 027874

**01.565** Cooling Plate



8 680437 024095

**01.878** Bushing



8 680437 027898

Wabco No: 9120003404

**01.272** Connecting Rod



8 680437 020400

Wabco No: 9111457372

**RK.01.104.00** Piston&Ring (Ø85,00 mm)

- RK.01.104.10** 85,25 mm
- RK.01.104.20** 85,50 mm
- RK.01.104.30** 85,75 mm
- RK.01.104.40** 86,00 mm



2,00x2,00x4,00



8 680437 060277

OEM No: 1283781

**01.142.00** Piston (Ø85,00 mm)

- 01.142.10** 85,25 mm
- 01.142.20** 85,50 mm
- 01.142.30** 85,75 mm
- 01.142.40** 86,00 mm



2,00x2,00x4,00



8 680437 018674

Wabco No: 9115016242 - 9115016252

**01.373.00** Ring (Ø85,00 mm)

- 01.373.10** 85,25 mm
- 01.373.20** 85,50 mm
- 01.373.30** 85,75 mm
- 01.373.40** 86,00 mm



2,00x2,00x4,00



8 680437 075431

Wabco No: 9115019202

**RK.01.803** Connecting Rod & Piston



8 680437 114567

Wabco No: 9125189242

**RK.01.905** Crankshaft Repair Kit



8 680437 109242

Wabco No: 9125129302

**01.1551** Gear



149,5 - Z:42



8 680437 091172

Oem No: 7403161258

**RK.01.714** Repair Kit



8 680437 077244

**01.1227** Bushing



52X48X20



8 680437 017936

**01.144** Nut



M20X1.5 Right Hand



8 680437 018742

Wabco No: 8103410014

## Twin Cylinder Compressor Ø65 mm-330 CC

**Application - Vehicle**  
RENAULT G220 / 260 / 270 / 290  
R310 / 330 / 340 / 365



**01.05.030**

Oem. No.	Knorr No.
5000694446	LP4943-SEB01158000
5000670603	



**01.1358** Crankcase



**RK.01.674** Complete Cylinder Head



**RK.01.681** Valve Plate Kit



OEM No : 5000802134

**RK.01.263** Repair Kit

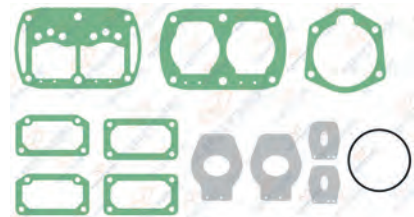

OEM No : 5001867703  
Knorr No : SEB22535

**RK.01.263.20** Repair Kit

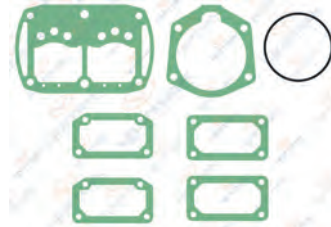

Knorr No : SEB22536

**RK.01.219** Repair Kit



**01.1361** Cylinder Head



Barcode: 8 680437 077763  
**OEM No** : 5001867699  
**Knorr No** : SEB22591

**01.1362** Valve Plate



Barcode: 8 680437 075929

**01.1359** Crankshaft



**M20X1.5 Right Hand**  
 Barcode: 8 680437 078296  
**OEM No**: 5001830846

**01.1332** Bushing



**42X38X22**  
 Barcode: 8 680437 009924

**01.1360** Crankshaft Flange



Barcode: 8 680437 079705  
**OEM No** : 5000814152  
**Knorr No** : SEB00351

**01.673** Connecting Rod



Barcode: 8 680437 025382

**RK.01.672.00** Piston&Ring (Ø65,00 mm)

<b>RK.01.672.10</b>	65,25 mm
<b>RK.01.672.20</b>	65,50 mm
<b>RK.01.672.30</b>	65,75 mm
<b>RK.01.672.40</b>	66,00 mm



**2,00x2,00x4,00**  
 Barcode: 8 680437 074250  
**OEM No** : 5001823288 - 76618601 - 76618501

**01.1365.00** Piston (Ø65,00 mm)

<b>01.1365.10</b>	65,25 mm
<b>01.1365.20</b>	65,50 mm
<b>01.1365.30</b>	65,75 mm
<b>01.1365.40</b>	66,00 mm



**2,00x2,00x4,00**  
 Barcode: 8 680437 114514

**01.1364.00** Ring (Ø65,00 mm)

<b>01.1364.10</b>	65,25 mm
<b>01.1364.20</b>	65,50 mm
<b>01.1364.30</b>	65,75 mm
<b>01.1364.40</b>	66,00 mm



**2,00x2,00x4,00**  
 Barcode: 8 680437 078175

**01.1366** Cover



Barcode: 8 680437 079767

**01.144** Nut



**M20X1.5 Right Hand**  
 Barcode: 8 680437 018742  
**OEM No**: 464642

Blank space for part information.

Blank space for part information.

Blank space for part information.

Blank space for part information.

Blank space for part information.

Blank space for part information.



## Single Cylinder Compressor Ø100 mm-720 CC-Stroke 46 mm

Application - Vehicle  
RENAULT MAJOR - 310



**01.01.005**

Oem. No.  
5000793615



**RK.01.098.00** Piston&Ring

- RK.01.098.10 100,2
- RK.01.098.20 100,5
- RK.01.098.30 100,7
- RK.01.098.40 101,0

2,5X2,5X4



**01.455.00** Piston

- 01.455.10 100,25 mm
- 01.455.20 100,50 mm
- 01.455.30 100,75 mm
- 01.455.40 101,00 mm

2,5X2,5X4



**01.133.00** Ring

- 01.133.10 100,25 mm
- 01.133.20 100,50 mm
- 01.133.30 100,75 mm
- 01.133.40 101,00 mm

2,5X2,5X4



**01.173** Connecting Rod



OEM No : 0000154836

**RK.01.072**

Complete Cylinder Head



Wabco No : 0000155152

**RK.01.071**

Repair Kit



OEM No : 0000323853

**RK.01.070**

Cylinder Liner Set



**01.215**

Cylinder Liner



OEM No : 0000151585

### Single Cylinder Compressor Ø100 mm-720 CC-Stroke 46 mm

Application - Vehicle  
RENAULT MAGNUM 385 ATI / 420 ATI



**01.01.006**

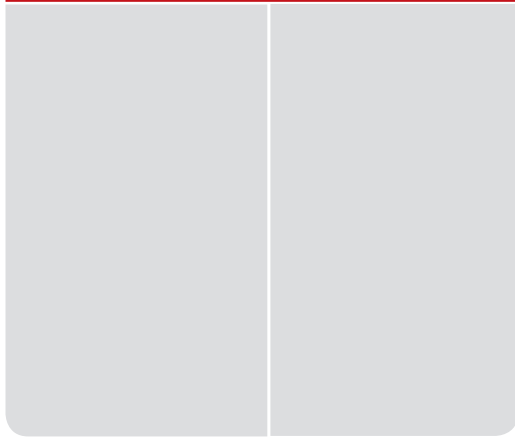

#### RK.01.098.00 Piston&Ring (Ø100,00 mm)

- RK.01.098.10 100,25 mm
- RK.01.098.20 100,50 mm
- RK.01.098.30 100,75 mm
- RK.01.098.40 101,00 mm



2,5X2,5X4



#### 01.455.00 Piston (Ø100,00 mm)

- 01.455.10 100,25 mm
- 01.455.20 100,50 mm
- 01.455.30 100,75 mm
- 01.455.40 101,00 mm



2,5X2,5X4



#### 01.133.00 Ring (Ø100,00 mm)

- 01.133.10 100,25 mm
- 01.133.20 100,50 mm
- 01.133.30 100,75 mm
- 01.133.40 101,00 mm



2,5X2,5X4



#### RK.01.095

Complete Cylinder Head



OEM No: 5000678923

#### RK.01.116

Repair Kit



#### RK.01.240

Cylinder Liner Set



#### 01.245

Cylinder Liner



OEM No: 5000666563 - 5000693172

## Single Cylinder Compressor Ø75 mm-155 CC-Stroke 35 mm

Application - Vehicle  
RENAULT J SERİ JP11 /  
JP13BC / JP14BOM



### 01.05.003

Oem. No.	Knorr No.
5000249136	LP1527-I81618
5000047358	LP1537-I81619
5000047359	



### 01.314 Crankcase

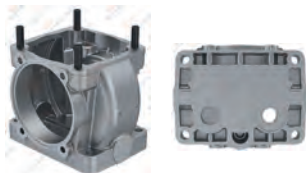

### RK.01.046.01 Repair Kit

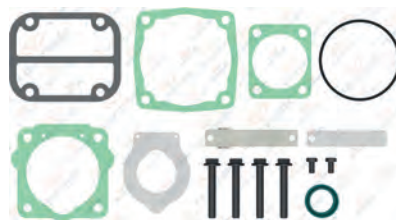

### RK.01.048 Complete Cylinder Head



Knorr No : STW63841

### RK.01.048.20 Complete Cylinder Head



### 01.067 Cylinder Head



### RK.01.047.20 Valve Plate Kit

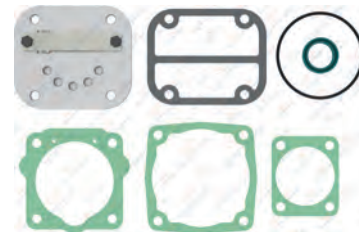

### RK.01.047 Valve Plate Kit



OEM No : 0001304920  
Knorr No : II3871F004

### RK.01.046 Repair Kit

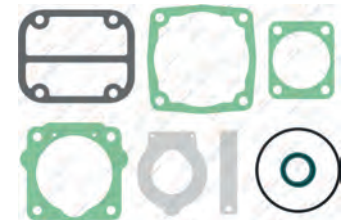



**RK.01.046.02** Repair Kit

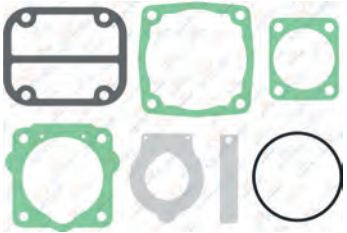

8 680437 072843

**RK.01.046.21** Repair Kit

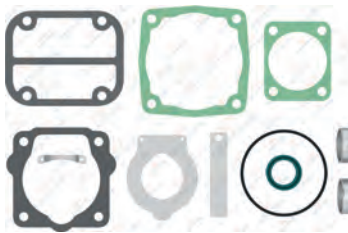

8 680437 120766

**01.089** Crankshaft



M18X1.5 - Right Hand

8 680437 014386

**01.119** Valve Plate



Knorr No : II38717F004

8 680437 017387

**01.066** Crankshaft Flange



8 680437 013976

**01.003** Connecting Rod



8 680437 009672

**RK.01.073.00** Piston&Ring (Ø75,00 mm)

RK.01.073.10	75,25 mm
RK.01.073.20	75,50 mm
RK.01.073.30	75,75 mm
RK.01.073.40	76,00 mm



2,00x2,00x4,00

OEM No : 1315279-1315280-1433932  
Knorr No: SEB22539-SEB22540

8 680437 059547

**01.193.00** Piston (Ø75,00 mm)

01.193.10	75,25 mm
01.193.20	75,50 mm
01.193.30	75,75 mm
01.193.40	76,00 mm



2,00x2,00x4,00

8 680437 019336

**01.134.00** Ring (Ø75,00 mm)

01.134.10	75,25 mm
01.134.20	75,50 mm
01.134.30	75,75 mm
01.134.40	76,00 mm



2,00x2,00x4,00

8 680437 018278

**RK.01.045** Cylinder Liner Set



Knorr No : ZB4265 - I77246

8 680437 059004

**01.056** Cylinder Liner



8 680437 013174

**01.013** Bushing



34X30X16

OEM No : 0001313150 - B44935

8 680437 009993

**00.140** Roller Bearing



6305

8 680437 001577

**01.143** Nut



M18X1.5 - Right Hand

8 680437 018735

**01.174** Pump Support



8 680437 019046

## Single Cylinder Compressor Ø75 mm-155 CC-Stroke 35 mm

Application - Vehicle  
RENAULT KERAX / MIDLUM /  
MAGNUM / PREMIUM / JE



**01.05.005**

Knorr No.  
LK1566-II39151F



**01.314**

Crankcase

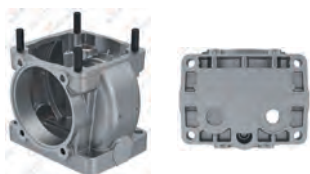

**RK.01.046.01**

Repair Kit



**RK.01.048** Complete Cylinder Head



Knorr No : STW63841

**RK.01.048.20**

Complete Cylinder Head



**01.067**

Cylinder Head



**RK.01.047.20**

Valve Plate Kit

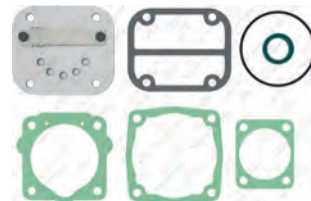

**RK.01.047**

Valve Plate Kit



OEM No : 0001304920  
Knorr No : II3871F/004

**RK.01.046**

Repair Kit



**RK.01.046.02** Repair Kit

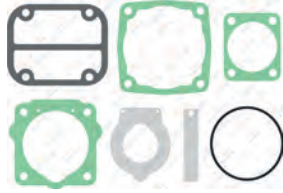

8 680437 072843

**RK.01.046.21** Repair Kit

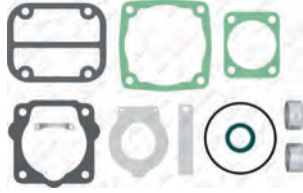

8 680437 120766

**01.206** Crankshaft



M18X1.5 - Right Hand



8 680437 019534

**01.119** Valve Plate



8 680437 017387

Knorr No : II38717F004

**01.066** Crankshaft Flange

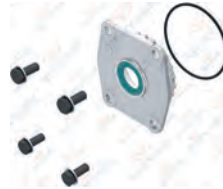

8 680437 013976

**01.003** Connecting Rod



8 680437 009672

**RK.01.073.00** Piston&Ring (Ø75,00 mm)

- RK.01.073.10 75,25 mm
- RK.01.073.20 75,50 mm
- RK.01.073.30 75,75 mm
- RK.01.073.40 76,00 mm



2,00x2,00x4,00



8 680437 059547

OEM No : 1315279-1315280-1433932  
Knorr No: SEB22539-SEB22540

**01.193.00** Piston (Ø75,00 mm)

- 01.193.10 75,25 mm
- 01.193.20 75,50 mm
- 01.193.30 75,75 mm
- 01.193.40 76,00 mm



2,00x2,00x4,00



8 680437 019336

**01.134.00** Ring (Ø75,00 mm)

- 01.134.10 75,25 mm
- 01.134.20 75,50 mm
- 01.134.30 75,75 mm
- 01.134.40 76,00 mm



2,00x2,00x4,00



8 680437 018278

OEM No : 1391384-1391385  
Knorr No: I801770061

**RK.01.045** Cylinder Liner Set



8 680437 059004

Knorr No : ZB4265 - I77246

**01.056** Cylinder Liner



8 680437 013174

**01.013** Bushing



34X30X16



8 680437 009993

OEM No : 0001313150 - B44935

**01.195** Bushing



34X30X16



8 680437 019411

**01.143** Nut



M18X1.5 - Right Hand



8 680437 018735

**01.409** Pump Support



8 680437 022268



## Single Cylinder Compressor Ø75 mm-155 CC-Stroke 35 mm

Application - Vehicle  
RENAULT S130 / S150 / S170



**01.05.006**

Oem. No.	Knorr No.
5000549857	LP1567-I97363X50
5000684232	



**01.313** Crankcase



**RK.01.046.01** Repair Kit



**RK.01.048** Complete Cylinder Head



Knorr No : STW63841

**RK.01.048.20** Complete Cylinder Head



**01.067** Cylinder Head



**RK.01.047.20** Valve Plate Kit

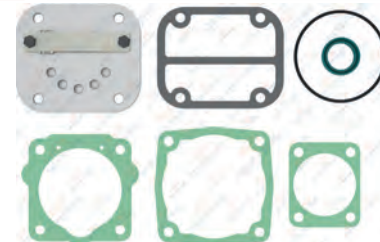

**RK.01.047** Valve Plate Kit



OEM No : 0001304920  
Knorr No : I13871F/004

**RK.01.046** Repair Kit

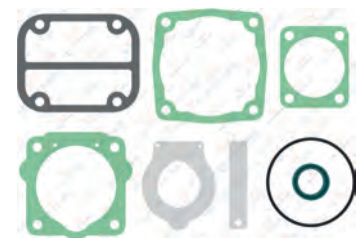

**RK.01.046.02** Repair Kit

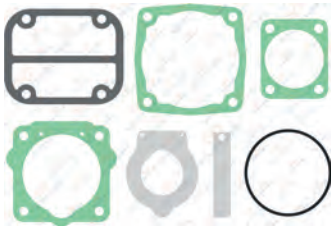

8 680437 072843

**RK.01.046.21** Repair Kit

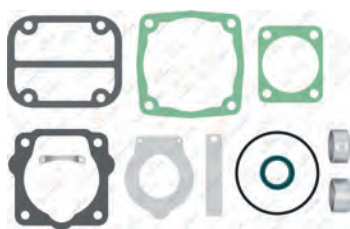

8 680437 120766

**01.089** Crankshaft



M18X1.5 - Right Hand



8 680437 014386

**01.119** Valve Plate



8 680437 017387

Knorr No : II38717F004

**01.066** Crankshaft Flange

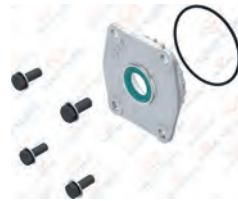

8 680437 013976

**01.003** Connecting Rod



8 680437 009672

**RK.01.073.00** Piston&Ring (Ø75,00 mm)

- RK.01.073.10 75,25 mm
- RK.01.073.20 75,50 mm
- RK.01.073.30 75,75 mm
- RK.01.073.40 76,00 mm



2,00x2,00x4,00



8 680437 059547

OEM No : 1315279-1315280-1433932  
Knorr No: SEB22539-SEB22540

**01.193.00** Piston (Ø75,00 mm)

- 01.193.10 75,25 mm
- 01.193.20 75,50 mm
- 01.193.30 75,75 mm
- 01.193.40 76,00 mm



2,00x2,00x4,00



8 680437 019336

**01.134.00** Ring (Ø75,00 mm)

- 01.134.10 75,25 mm
- 01.134.20 75,50 mm
- 01.134.30 75,75 mm
- 01.134.40 76,00 mm



2,00x2,00x4,00



8 680437 018278

OEM No : 1391384-1391385  
Knorr No: I801770061

**RK.01.045** Cylinder Liner Set



8 680437 059004

Knorr No : ZB4265 - I77246

**01.056** Cylinder Liner



8 680437 013174

**01.013** Bushing



34X30X16



8 680437 009993

OEM No : 0001313150 - B44935

**00.140** Roller Bearing



6305



8 680437 001577

**01.143** Nut



M18X1.5 - Right Hand



8 680437 018735

**01.174** Pump Support



8 680437 019046

## Single Cylinder Compressor 150 CC

Application - Vehicle  
RENAULT PREMIUM / KERAX  
MAGNUM / MIDLUM



**01.05.137**

Oem. No.	Knorr No.
5010450535	LK1567-SEB01686000
5001856588	
5000691935	



**01.1607** Crankcase



**RK.01.046.02** Repair Kit

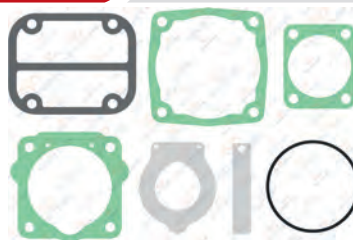

**RK.01.048** Complete Cylinder Head



Knorr No : STW63841

**RK.01.048.02** Complete Cylinder Head



**01.067** Cylinder Head



**RK.01.047.01** Valve Plate Kit

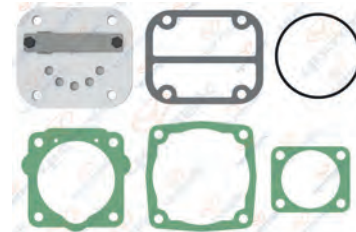

**RK.01.047** Valve Plate Kit



OEM No : 0001304920  
Knorr No : II3871F/004

**RK.01.046.21** Repair Kit

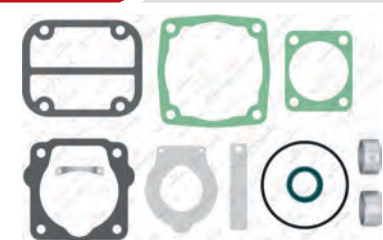



**01.119** Valve Plate



Knorr No : II38717F004

8 680437 017387

**01.1605** Crankshaft Flange



8 680437 084648

**01.1606** Crankshaft



M18X1.5 - Right Hand

8 680437 109488

**01.143** Nut



M18X1.5 - Right Hand

8 680437 018735

**01.013** Bushing



34X30X16

OEM No : 0001313150 - B44935

8 680437 009993

**01.003** Connecting Rod



8 680437 009672

**RK.01.073.00** Piston&Ring (Ø75,00 mm)

RK.01.073.10	75,25 mm
RK.01.073.20	75,50 mm
RK.01.073.30	75,75 mm
RK.01.073.40	76,00 mm



2,00x2,00x4,00

OEM No : 1315279-1315280-1433932  
Knorr No: SEB22539-SEB22540

8 680437 059547

**01.193.00** Piston (Ø75,00 mm)

01.193.10	75,25 mm
01.193.20	75,50 mm
01.193.30	75,75 mm
01.193.40	76,00 mm



2,00x2,00x4,00

8 680437 019336

**01.134.00** Ring (Ø75,00 mm)

01.134.10	75,25 mm
01.134.20	75,50 mm
01.134.30	75,75 mm
01.134.40	76,00 mm



2,00x2,00x4,00

OEM No : 1391384-1391385  
Knorr No: I801770061

8 680437 018278

## Single Cylinder Compressor Ø78 mm-248 CC

**Application - Vehicle**  
RENAULT MIDLUM / PREMIUM PR 4x2  
PUNCHER / C 230/280/300/340  
G 200/210/230

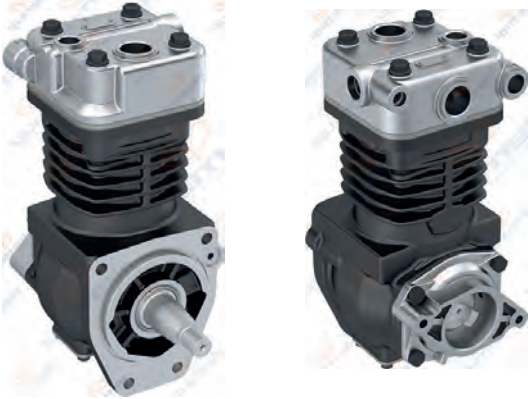

**01.05.150**

Oem. No.	Knorr No.
5000691934	LP3861-SEB01152000
5001857409	



**01.1608** Crankcase



**RK.01.243.22** Repair Kit

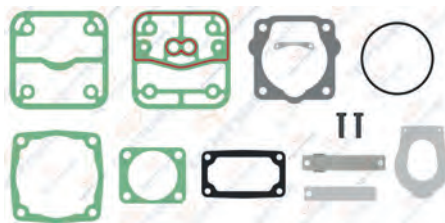

OEM No : 5001867692  
Knorr No : SEB22522

**RK.01.245** Repair Kit



**RK.01.654**

Complete Cylinder Head



**RK.01.743**

Valve Plate Kit



OEM No : 5001845704  
Knorr No : I81028004

**RK.01.243.01**

Repair Kit

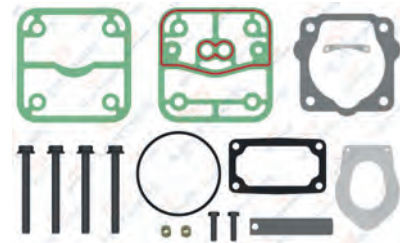

**RK.01.243**

Repair Kit

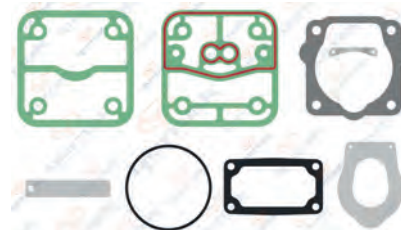

**RK.01.243.21**

Repair Kit

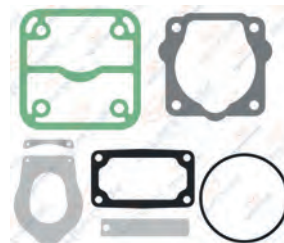

**01.1611** Cylinder Head



OEM No : 5003101738  
Knorr No : I74405004



**01.1612** Valve Plate



**01.1609** Crankshaft



M18X1.5 - Right Hand



**01.1230** Bushing



42X38X23



**01.1610** Gear



**01.218** Connecting Rod



**RK.01.271.00** Piston&Ring (Ø78,00 mm)

- RK.01.271.10 78,25 mm
- RK.01.271.20 78,50 mm
- RK.01.271.30 78,75 mm
- RK.01.271.40 79,00 mm



2.50x2,50x4,00



OEM No: 5001830855 - 5001831273  
Knorr No: SEB22551 - SEB22552

**01.767.00** Piston (Ø78,00 mm)

- 01.767.10 78,25 mm
- 01.767.20 78,50 mm
- 01.767.30 78,75 mm
- 01.767.40 79,00 mm

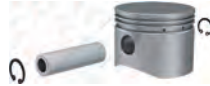

2.50x2,50x4,00



**01.768.00** Ring (Ø78,00 mm)

- 01.768.10 78,25 mm
- 01.768.20 78,50 mm
- 01.768.30 78,75 mm
- 01.768.40 79,00 mm



2.50x2,50x4,00



**01.752** Nut



M18X1.5 - Right Hand





## Single Cylinder Compressor Ø65 mm-76 CC-Stroke 23 mm

Application - Vehicle  
RENAULT VI / JN / JP / JR / JX

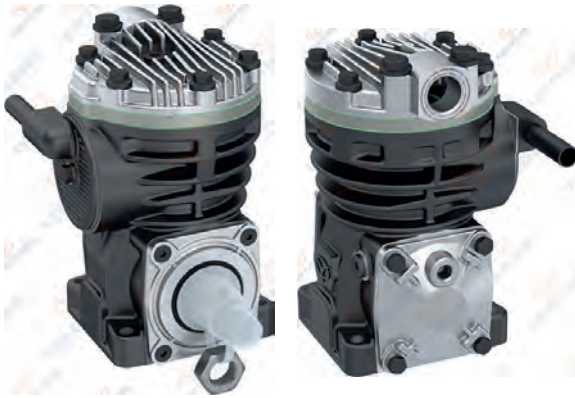

**01.09.001**

Oem. No.  
5000048155

Wabco No.  
9110047250  
9110048960



**01.624**

Crankcase



**01.625**

Cover



Wabco No : 9110226522

**RK.01.664**

Complete Cylinder Head



**RK.01.477**

Valve Plate Kit



**RK.01.203**

Repair Kit

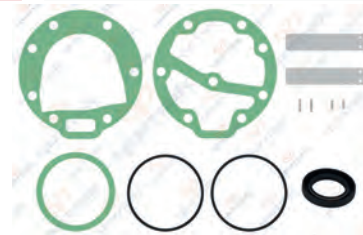

**RK.01.214**

Repair Kit

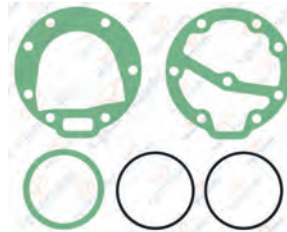

**RK.01.215**

Repair Kit



**01.616** Cylinder Head



Wabco No: 9110046514  
8 680437 024798

**01.628** Crankshaft Flange



Wabco No: 9119016612  
8 680437 024941

**01.629** Crankshaft



M18X1.5 - Right Hand  
Wabco No: 9110046934  
8 680437 024958

**01.617** Cooling Plate



8 680437 024804

**01.626** Crankshaft Flange



Wabco No: 9119016622  
8 680437 024910

**01.620** Connecting Rod



8 680437 024835

**RK.01.231.00** Piston&Ring (Ø65,00 mm)

- RK.01.231.10 65,25 mm
- RK.01.231.20 65,50 mm
- RK.01.231.30 65,75 mm
- RK.01.231.40 66,00 mm



2,50x2,50x4,00x4,00  
8 680437 062462

**01.608.00** Piston (Ø65,00 mm)

- 01.608.10 65,25 mm
- 01.608.20 65,50 mm
- 01.608.30 65,75 mm
- 01.608.40 66,00 mm



2,50x2,50x4,00x4,00  
8 680437 024811

**01.611.00** Ring (Ø65,00 mm)

- 01.611.10 65,25 mm
- 01.611.20 65,50 mm
- 01.611.30 65,75 mm
- 01.611.40 66,00 mm



2,50x2,50x4,00x4,00  
8 680437 024620

**00.138** Roller Bearing



6206

8 680437 001553

**01.1929** Bushing



34X30X18

8 680437 135029

## Twin Cylinder Compressor Ø85 mm-704 CC-Stroke 62 mm

Application - Vehicle  
RENAULT 480

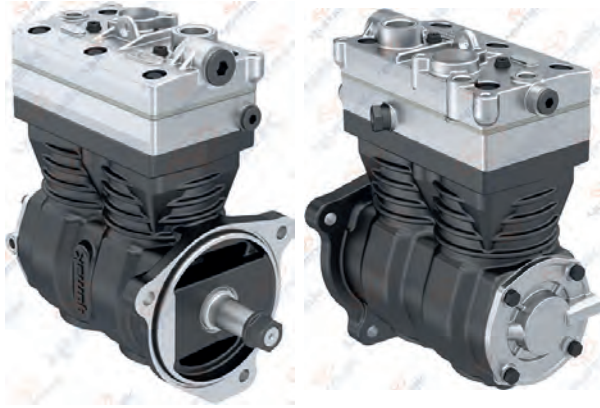

### 01.06.035

**Oem. No.**  
70330056  
20775224  
20574763  
20866605  
85000491

**Wabco No.**  
4127040070  
4127040130  
4127040160



### 01.885

Crankcase



### RK.01.176.07

Repair Kit

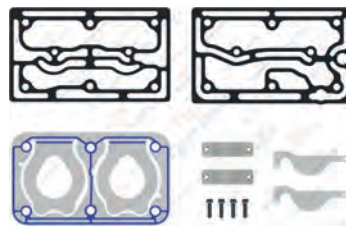

### RK.01.176.03

Repair Kit

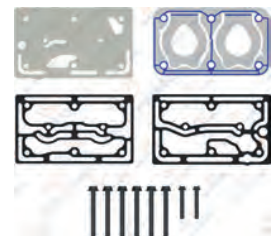

Wabco No : 4127049362

### RK.01.175

Complete Cylinder Head

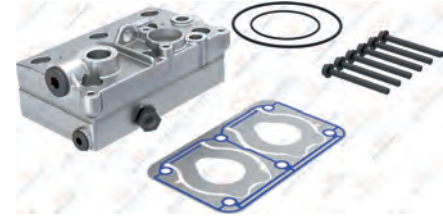

Wabco No : 4127049342 - 4127049352

### RK.01.176.05

Repair Kit

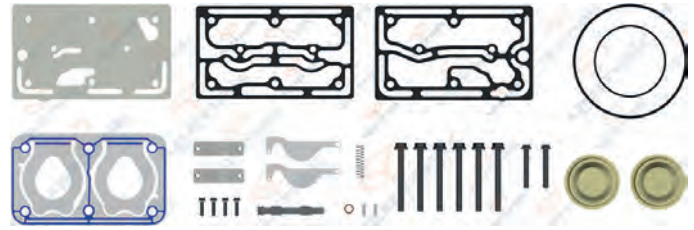

### RK.01.176.01

Repair Kit

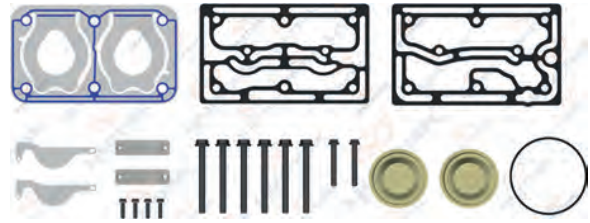

Wabco No : 4127049392

### RK.01.176

Repair Kit

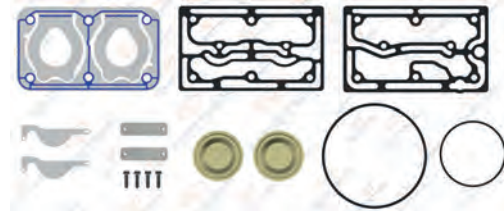

### RK.01.176.04

Repair Kit

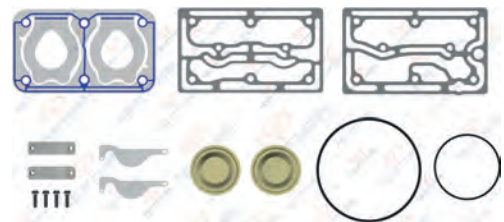

Use for old version cylinder repair kit. Yıpranmış kapaklar için.



# RENAULT

## AIR COMPRESSOR AND REPAIR KIT

**01.589** Cylinder Head



8 680437 024354

**01.590** Valve Plate



8 680437 024378

**01.886** Crankshaft



M20X1.5 Right Hand  
Wabco No: 4127046914  
8 680437 027997

**01.593** Cooling Plate



8 680437 024415

**01.284** Crankshaft Flange



8 680437 020547

**01.697** Connecting Rod



OEM No: 1698678  
Wabco No: 9115057322  
8 680437 025634

**RK.01.104.00** Piston&Ring (Ø85,00 mm)

RK.01.104.10	85,25 mm
RK.01.104.20	85,50 mm
RK.01.104.30	85,75 mm
RK.01.104.40	86,00 mm



2,00x2,00x4,00  
OEM No: 1283781  
8 680437 060277

**01.142.00** Piston (Ø85,00 mm)

01.142.10	85,25 mm
01.142.20	85,50 mm
01.142.30	85,75 mm
01.142.40	86,00 mm



2,00x2,00x4,00  
Wabco No: 9115016242 - 9115016252  
8 680437 018674

**01.373.00** Ring (Ø85,00 mm)

01.373.10	85,25 mm
01.373.20	85,50 mm
01.373.30	85,75 mm
01.373.40	86,00 mm



2,00x2,00x4,00  
Wabco No: 9115019202  
8 680437 075431

**RK.01.804** Connecting Rod & Piston



Wabco No: 4127049422 - 4127049432  
8 680437 114666

**RK.01.908** Crankshaft Repair Kit



Wabco No: 4127049412  
8 680437 109273

**01.1551** Gear



149,5 - Z:42  
Oem No: 7403161258  
8 680437 091172

**RK.01.181** Repair Kit



8 680437 061847

**01.115** Bushing



42X38X24.5  
8 680437 077121

**01.144** Nut



M20X1.5 Right Hand  
Wabco No: 8103410014  
8 680437 018742

## Twin Cylinder Compressor Ø85 mm-704 CC-Stroke 62 mm

Application - Vehicle  
RENAULT

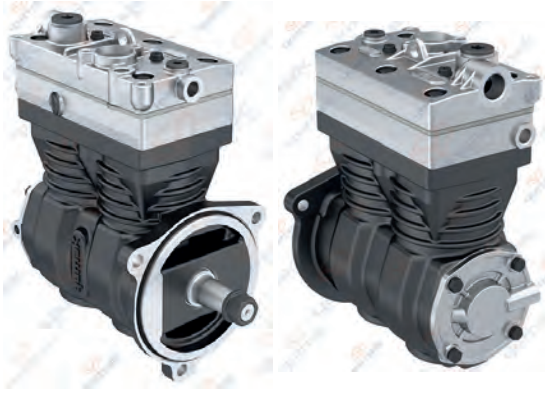

**01.06.075**

Oem. No.  
21388369

Wabco No.  
4127040240



**01.887**

Crankcase



**RK.01.176.07**

Repair Kit

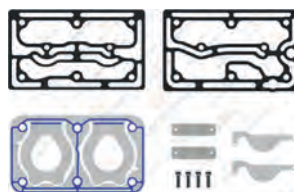

**RK.01.176.03**

Repair Kit

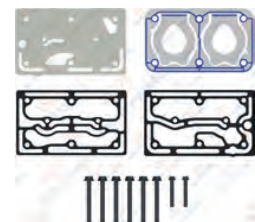

Wabco No : 4127049362

**RK.01.175.01**

Complete Cylinder Head

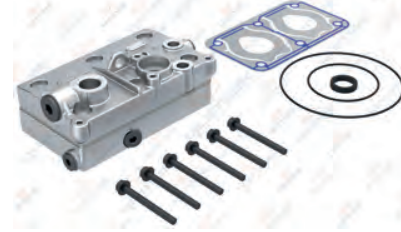

Wabco No : 4127049332

**RK.01.176.10**

Repair Kit

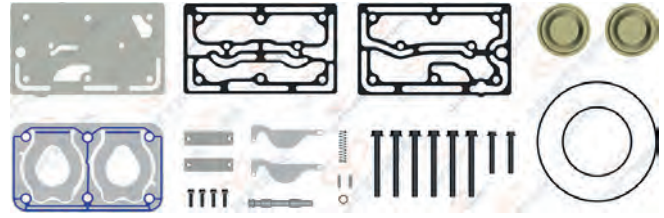

**RK.01.176.01**

Repair Kit

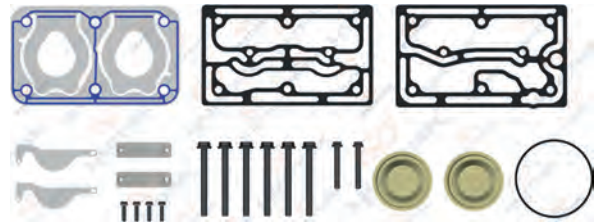

Wabco No : 4127049392

**RK.01.176.11**

Repair Kit

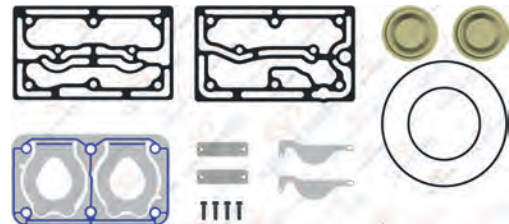

**RK.01.176.12**

Repair Kit

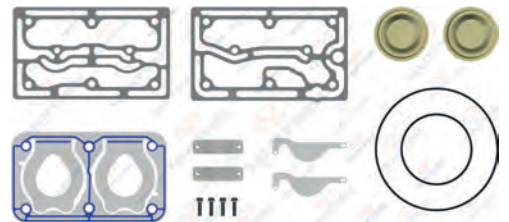

Use for old version cylinder repair kit. Yıpranmış kapaklar için.

# RENAULT

## AIR COMPRESSOR AND REPAIR KIT

**01.589** Cylinder Head



8 680437 024354

**01.590.10** Valve Plate



8 680437 127758

**01.886** Crankshaft



M20X1.5 - Right Hand



8 680437 027997

Wabco No: 4127046914

**01.593** Cooling Plate



8 680437 024415

**01.284** Crankshaft Flange



8 680437 020547

**01.697** Connecting Rod



8 680437 025634

OEM No: 1698678

Wabco No: 9115057322

**RK.01.104.00** Piston&Ring (Ø85,00 mm)

- RK.01.104.10 85,25 mm
- RK.01.104.20 85,50 mm
- RK.01.104.30 85,75 mm
- RK.01.104.40 86,00 mm



2,00x2,00x4,00



8 680437 060277

OEM No: 1283781

**01.142.00** Piston (Ø85,00 mm)

- 01.142.10 85,25 mm
- 01.142.20 85,50 mm
- 01.142.30 85,75 mm
- 01.142.40 86,00 mm



2,00x2,00x4,00



8 680437 018674

Wabco No: 9115016242 - 9115016252

**01.373.00** Ring (Ø85,00 mm)

- 01.373.10 85,25 mm
- 01.373.20 85,50 mm
- 01.373.30 85,75 mm
- 01.373.40 86,00 mm



2,00x2,00x4,00



8 680437 075431

Wabco No: 9115019202

**RK.01.804** Connecting Rod & Piston



8 680437 114666

Wabco No: 4127049422 - 4127049432

**RK.01.908** Crankshaft Repair Kit



8 680437 109273

Wabco No: 4127049412

**01.1551** Gear



149,5 - Z:42



8 680437 091172

Oem No: 7403161258

**RK.01.181** Repair Kit

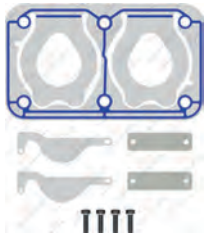

8 680437 061847

**RK.01.101** Repair Kit



8 680437 060246

**01.302** Cap



8 680437 020769

**01.115** Bushing



42X38X24.5



8 680437 077121



## Twin Cylinder Compressor Ø85 mm-704 CC-Stroke 62 mm

Application - Vehicle  
RENAULT 480

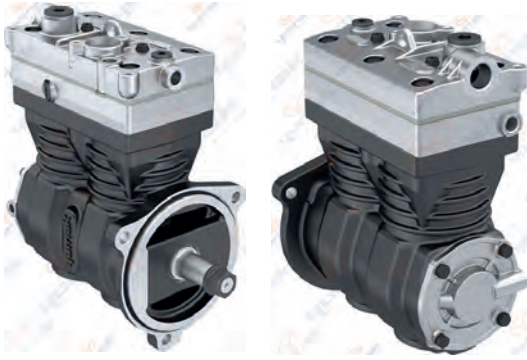

**01.06.036**

**Oem. No.**  
20842990  
20773343  
20569928  
85000614  
85000487

**Wabco No.**  
4127040140



**01.887**

Crankcase



**RK.01.176.07**

Repair Kit

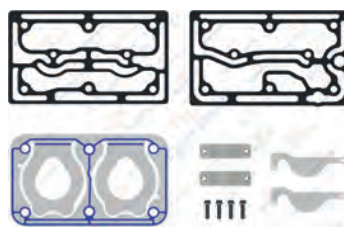

**RK.01.176.03**

Gasket

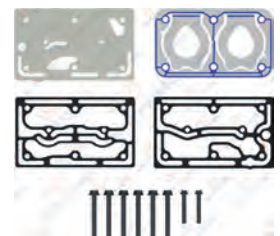

Wabco No : 4127049362

**RK.01.175.01**

Complete Cylinder Head

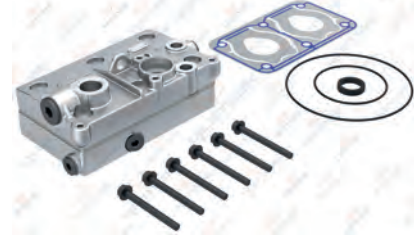

**RK.01.176.13**

Repair Kit

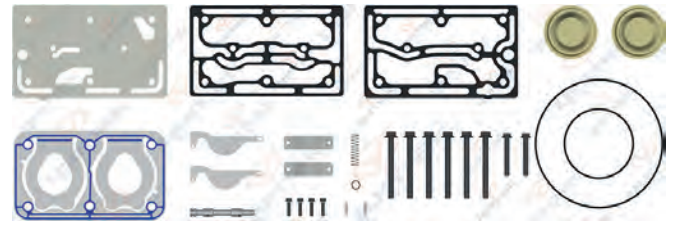

**RK.01.176.01**

Repair Kit

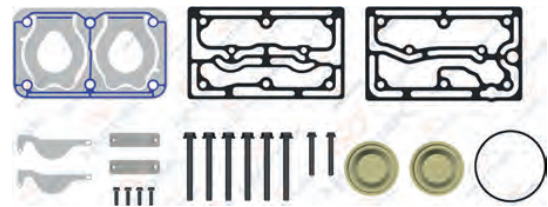

Wabco No : 4127049392

**RK.01.176.14**

Repair Kit

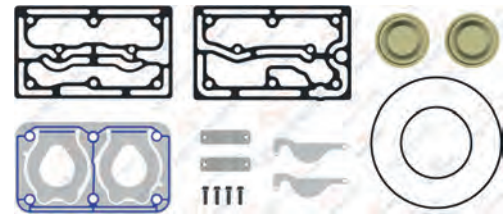

**RK.01.176.15**

Repair Kit

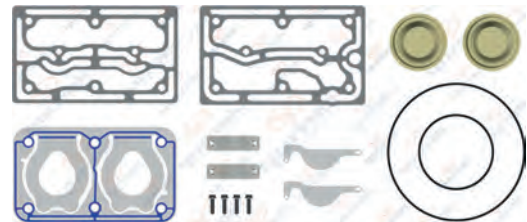

Use for old version cylinder repair kit. Yıpranmış kapaklar için.

# RENAULT

## AIR COMPRESSOR AND REPAIR KIT

### 01.589 Cylinder Head



8 680437 024354

### 01.590.10 Valve Plate



8 680437 127758

### 01.886 Crankshaft



M20X1.5 - Right Hand



8 680437 027997

Wabco No: 4127046914

### 01.593 Cooling Plate



8 680437 024415

### 01.284 Crankshaft Flange



8 680437 020547

### 01.697 Connecting Rod



8 680437 025634

OEM No: 1698678

Wabco No: 9115057322

### RK.01.104.00 Piston&Ring (Ø85,00 mm)

- RK.01.104.10 85,25 mm
- RK.01.104.20 85,50 mm
- RK.01.104.30 85,75 mm
- RK.01.104.40 86,00 mm



2,00x2,00x4,00



8 680437 060277

OEM No: 1283781

### 01.142.00 Piston (Ø85,00 mm)

- 01.142.10 85,25 mm
- 01.142.20 85,50 mm
- 01.142.30 85,75 mm
- 01.142.40 86,00 mm



2,00x2,00x4,00



8 680437 018674

Wabco No: 9115016242 - 9115016252

### 01.373.00 Ring (Ø85,00 mm)

- 01.373.10 85,25 mm
- 01.373.20 85,50 mm
- 01.373.30 85,75 mm
- 01.373.40 86,00 mm



2,00x2,00x4,00



8 680437 075431

Wabco No: 9115019202

### RK.01.804 Connecting Rod & Piston



8 680437 114666

Wabco No: 4127049422 - 4127049432

### RK.01.908 Crankshaft Repair Kit



8 680437 109273

Wabco No: 4127049412

### 01.1551 Gear



149,5 - Z:42



8 680437 091172

Oem No: 7403161258

### RK.01.181 Repair Kit

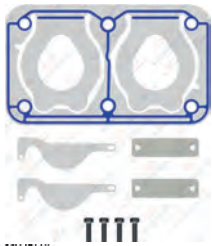

8 680437 061847

### 01.115 Bushing



42X38X24.5



8 680437 077121

### 01.144 Nut



M20X1.5 Right Hand



8 680437 018742

OEM No : 1698672

Wabco No : 8103410014

## Single Cylinder Compressor Ø80 mm-225 CC-Stroke 45 mm

Application - Vehicle  
RENAULT MIDLUM DXI 5 ENGINE  
MIDLUM DXI 7 ENGINE



**01.04.179**

Oem. No.  
7421098915

Knorr No.  
LK3869 K016932



**01.1672** Crankcase



**RK.01.159.07** Repair Kit

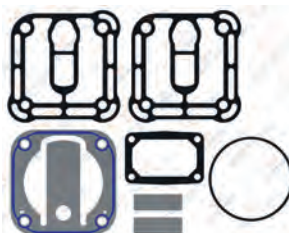

Knorr No : K012252

**RK.01.159.13** Repair Kit

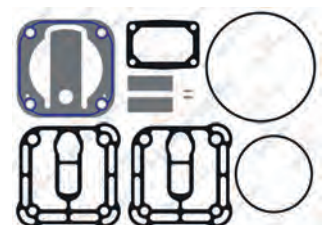

**RK.01.755**

Complete Cylinder Head



**RK.01.755.01**

Cylinder Head



Knorr No : K149867K50

**RK.01.756.01**

Valve Plate Kit



Knorr No : K149864K50

**RK.01.756**

Valve Plate Kit



**RK.01.159.33**

Repair Kit

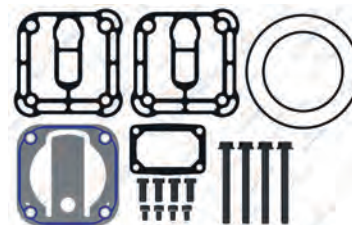

Knorr No : K149866K50



**01.1674** Cylinder Head



Knorr No: K012234  
8 680437 127871

**01.1675** Cooling Plate



8 680437 127888

**01.1673** Crankshaft



M20X1.5 - Right Hand  
8 680437 127864

**01.1676** Valve Plate



Knorr No: SEB01938004  
8 680437 127895

**01.1206** Crankshaft Flange



8 680437 017622

**01.587** Connecting Rod



8 680437 024323

**RK.01.601.00** Piston&Ring (Ø80,00 mm)

- RK.01.601.10 80,25 mm
- RK.01.601.20 80,50 mm
- RK.01.601.30 80,75 mm
- RK.01.601.40 81,00 mm



2.50x2,50x4,00  
Knorr No: SEB22517  
8 680437 067054

**01.1201.00** Piston (Ø80,00 mm)

- 01.1201.10 80,25 mm
- 01.1201.20 80,50 mm
- 01.1201.30 80,75 mm
- 01.1201.40 81,00 mm

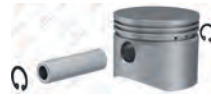

2.50x2,50x4,00  
8 680437 017530

**01.1226.00** Ring (Ø80,00 mm)

- 01.1226.10 80,25 mm
- 01.1226.20 80,50 mm
- 01.1226.30 80,75 mm
- 01.1226.40 81,00 mm



2.50x2,50x4,00  
8 680437 017882

**RK.01.601.05** Piston&Ring Full Kit



Knorr No: K149865K50  
8 680437 127901

**01.374** Cover



8 680437 077022

**01.144** Nut



M20X1.5 - Right Hand  
8 680437 018742

**51.01.008** Safety Valve



8 680437 073567

**01.1230** Bushing



42X38X23  
8 680437 017981

## Twin Cylinder Compressor Ø85 mm-636 CC-Stroke 56 mm

Application - Vehicle  
RENAULT  
COMPRESSOR WITH OPTIMIZED PISTON  
(CLUTCH VERSION)



**01.06.088**

Oem. No.  
22169888  
22885124

Wabco No.  
9125140100  
9125140130



8 680437 106944



**01.1770**

Crankcase



8 680437 128557

**RK.01.777**

Repair Kit



8 680437 128731

Wabco No : 9125129322 -  
9125129402

**RK.01.778**

Repair Kit



8 680437 128748

Wabco No : 9125129332

**RK.01.745**

Complete Cylinder Head



8 680437 105305

Wabco No : 9125129372

**RK.01.744**

Repair Kit

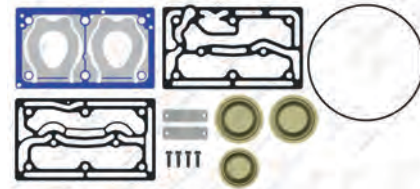

8 680437 122647

**RK.01.744.05**

Repair Kit

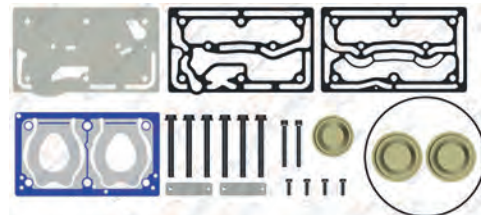

8 680437 122494

**RK.01.744.01**

Repair Kit

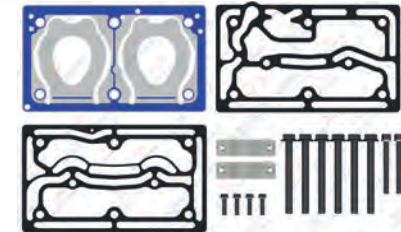

8 680437 122098

Wabco No : 9125129382

**RK.01.419**

Repair Kit

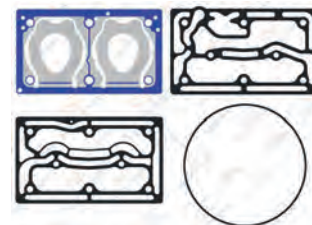

8 680437 065036

# RENAULT

## AIR COMPRESSOR AND REPAIR KIT

### 01.1772 Cylinder Head



8 680437 128533

### 01.1712 Valve Plate

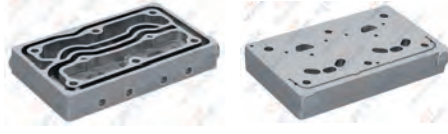

8 680437 127772

### 01.1771 Crankshaft



8 680437 128564

### RK.01.104 Piston&Ring

- RK.01.104.10 85,25 mm
- RK.01.104.20 85,50 mm
- RK.01.104.30 85,75 mm
- RK.01.104.40 86,00 mm



2,00X2,00X4,00



8 680437 060277

OEM No: 1283781

### 01.142 Piston

- 01.142.10 85,25 mm
- 01.142.20 85,50 mm
- 01.142.30 85,75 mm
- 01.142.40 86,00 mm



2,00X2,00X4,00



8 680437 018674

Wabco No: 9115016242 - 9115016252

### 01.373 Ring

- 01.373.10 85,25 mm
- 01.373.20 85,50 mm
- 01.373.30 85,75 mm
- 01.373.40 86,00 mm



2,00X2,00X4,00



8 680437 075431

Wabco No: 9115019202

### 01.565 Cooling Plate



8 680437 024095

### 01.272 Connecting Rod



8 680437 020400

Wabco No : 9111457372



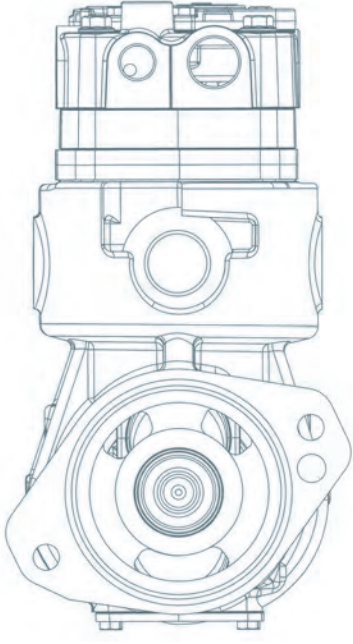

# IVECO DEUTZ

**HAVA KOMPRESÖRLERİ  
ve TAMİR TAKIMLARI**

AIR COMPRESSORS AND REPAIR KITS

# IVECO DEUTZ

IVECO-DEUTZ



## Twin Cylinder Compressor Ø86 mm-464 CC-Stroke 40 mm

**Application - Vehicle**  
IVECO STRALIS 260S48  
440S42 / 440S43 / 440S45 / 440S50  
IRISBUS (EURORIDER)



### 01.05.022

Oem. Ref. No.	Knorr No.
99471918	LP4857-K022249N00
41211121	
1194194	
504308843	
41211339	
41211121	



8 680437 012320



### 01.1400 Crankcase



8 680437 073109

### RK.01.500 Complete Cylinder Head



8 680437 065920

### RK.01.501.01 Valve Plate Kit



8 680437 112815

### RK.01.501 Valve Plate Kit



8 680437 065937

### RK.01.136.01 Repair Kit

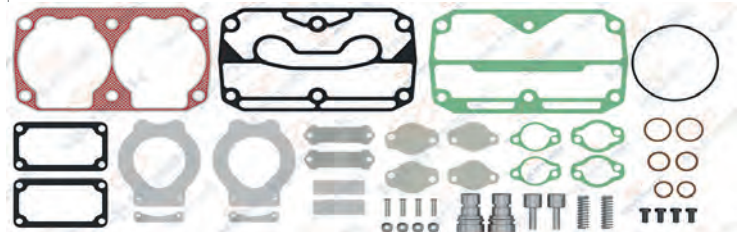

8 680437 060970

Knorr No: SEB22549

### RK.01.136 Repair Kit

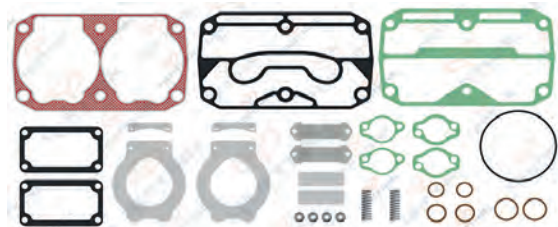

8 680437 060956

### RK.01.136.10 Repair Kit

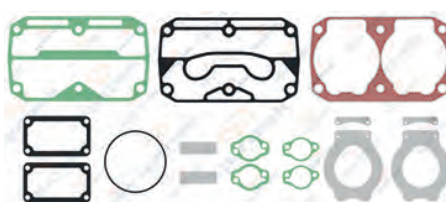

8 680437 120667

### RK.01.136.11 Repair Kit

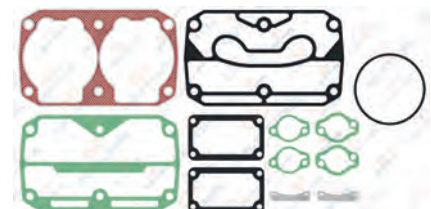

8 680437 120674



# IVECO - DEUTZ

## AIR COMPRESSOR AND REPAIR KIT

**01.1019** Cylinder Head



8 680437 014812

**01.1028** Valve Plate



8 680437 014942

**01.1020** Crankshaft



M18X1.5 - Right Hand



8 680437 014843

**RK.01.381** Repair Kit



8 680437 064640

**01.1018** Crankshaft Flange



8 680437 014805

**01.1016** Connecting Rod



8 680437 014775

**RK.01.272.00** Piston&Ring (Ø86,00 mm)

- RK.01.272.10 86,25 mm
- RK.01.272.20 86,50 mm
- RK.01.272.30 86,75 mm
- RK.01.272.40 87,00 mm



2.00x2,00x3,00



8 680437 063209

OEM No: 42549147  
Knorr No: SEB22547 - SEB22548

**01.868.00** Piston (Ø86,00 mm)

- 01.868.10 86,25 mm
- 01.868.20 86,50 mm
- 01.868.30 86,75 mm
- 01.868.40 87,00 mm



2.00x2,00x3,00



8 680437 027676

**01.869.00** Ring (Ø86,00 mm)

- 01.869.10 86,25 mm
- 01.869.20 86,50 mm
- 01.869.30 86,75 mm
- 01.869.40 87,00 mm



2.00x2,00x3,00



8 680437 027737

**01.752** Nut



M18X1.5 - Right Hand



8 680437 026204

**01.026** Bushing



44X40X26



8 680437 071679

**01.208** Bushing



44X40X20



8 680437 019602

**RK.01.184** Repair Kit



8 680437 061885

## Twin Cylinder Compressor Ø86 mm-464 CC-Stroke 40 mm

Application - Vehicle  
IVECO  
STRALIS / IRISBUS (EURORIDER)



**01.05.022.10**

Oem. Ref. No.	Knorr. No.
99471918	LP4857-K022249N00
41211121	
1194194	



**01.1400** Crankcase



**RK.01.679** Repair Kit



**RK.01.136.03** Repair Kit



**RK.01.742** Complete Cylinder Head

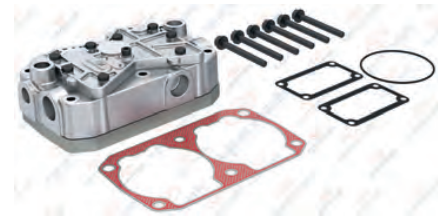

**RK.01.676.11** Valve Plate Kit

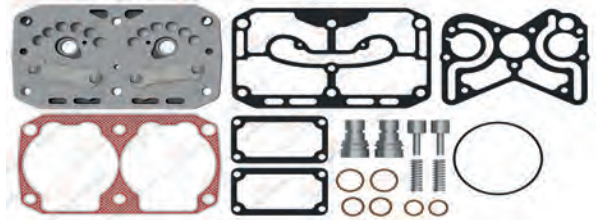

**RK.01.676.10** Valve Plate Kit



**RK.01.676.12** Valve Plate Kit

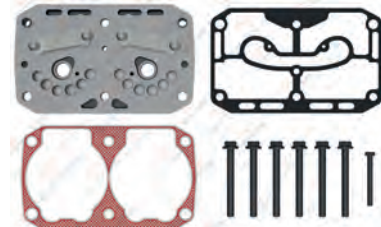

**RK.01.136.02** Repair Kit

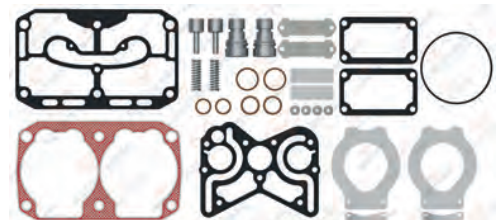

# IVECO - DEUTZ

## AIR COMPRESSOR AND REPAIR KIT

**RK.01.742.10** Complete Cylinder Head



8 680437 082842 **Oem No :** 42562098  
**Knorr No:** K041489K50 - K057166K50

**01.1492** Valve Plate



8 680437 079927

**01.1020** Crankshaft



M18X1.5 - Right Hand

8 680437 014843

**01.752** Nut



M18X1.5 - Right Hand

8 680437 026204

**01.1018** Crankshaft Flange



8 680437 014805

**01.1016** Connecting Rod



8 680437 014775

**RK.01.272.00** Piston&Ring (Ø86,00 mm)

- RK.01.272.10 86,25 mm
- RK.01.272.20 86,50 mm
- RK.01.272.30 86,75 mm
- RK.01.272.40 87,00 mm



2.00x2,00x3,00

8 680437 063209 **OEM No:** 42549147  
**Knorr No:** SEB22547 - SEB22548

**01.868.00** Piston (Ø86,00 mm)

- 01.868.10 86,25 mm
- 01.868.20 86,50 mm
- 01.868.30 86,75 mm
- 01.868.40 87,00 mm



2.00x2,00x3,00

8 680437 027676

**01.869.00** Ring (Ø86,00 mm)

- 01.869.10 86,25 mm
- 01.869.20 86,50 mm
- 01.869.30 86,75 mm
- 01.869.40 87,00 mm



2.00x2,00x3,00

8 680437 027737

**RK.01.184** Repair Kit



8 680437 061885

**01.026** Bushing



44X40X26

8 680437 071679

**01.208** Bushing



44X40X20

8 680437 019602

**RK.01.136.13** Repair Kit

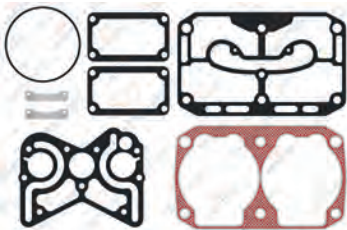

8 680437 120599

**RK.01.381.01** Repair Kit



8 680437 118213

**Knorr No:** K114137K50



## Twin Cylinder Compressor Ø86 mm-628 CC-Stroke 54 mm

Application - Vehicle  
IVECO  
STRALIS 260S36 / 260S43 / 260S45  
440S42 / 440S43 / 440S45



**01.04.096**

Oem. Ref. No.	Knorr No.
41211122	LK4936-K022263N00
41211340	
504293730	
99471919	



**01.1400** Crankcase



**RK.01.136.10** Repair Kit

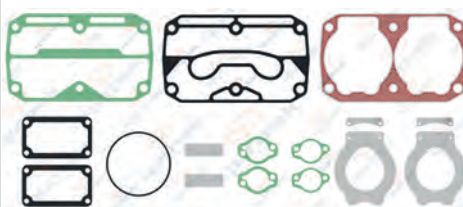

**RK.01.499** Complete Cylinder Head

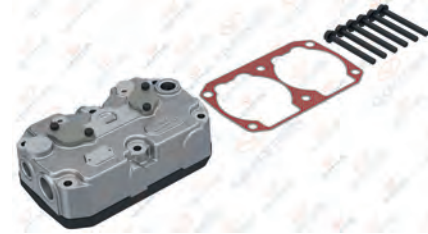

**RK.01.339.20** Valve Plate Kit

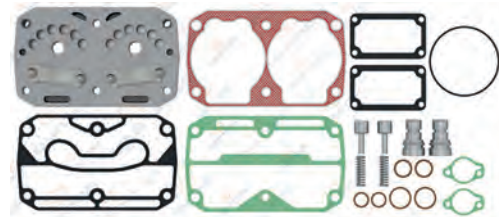

**RK.01.339** Valve Plate Kit

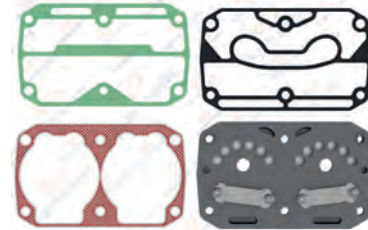

**RK.01.136.01** Repair Kit

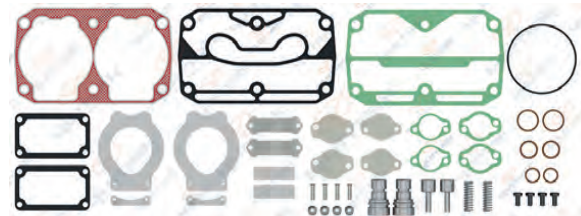

Knorr No: SEB22549

**RK.01.136** Repair Kit

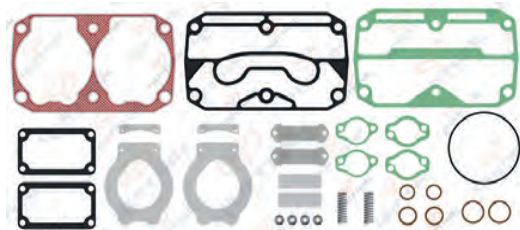

**RK.01.136.11** Repair Kit

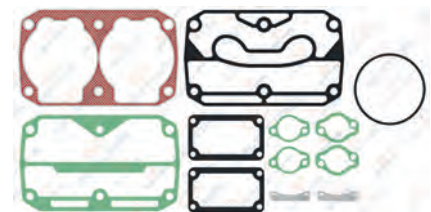

# IVECO - DEUTZ

## AIR COMPRESSOR AND REPAIR KIT

### 01.1029 Cylinder Head

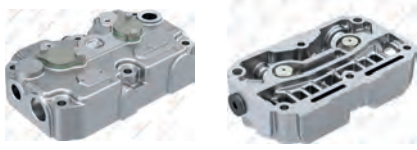

8 680437 014959  
 Oem No : 42549152  
 Knorr No: SEB01851004

### 01.964 Valve Plate



8 680437 028987

### 01.1030 Crankshaft



M18X1.5 - Right Hand

8 680437 014980

### RK.01.381 Pump Support



8 680437 064640

### 01.1018 Crankshaft Flange



8 680437 014805

### 01.587 Connecting Rod



8 680437 024323

### RK.01.272.00 Piston&Ring (Ø86,00 mm)

- RK.01.272.10 86,25 mm
- RK.01.272.20 86,50 mm
- RK.01.272.30 86,75 mm
- RK.01.272.40 87,00 mm



2.00x2,00x3,00

8 680437 063209  
 OEM No: 42549147  
 Knorr No: SEB22547 - SEB22548

### 01.868.00 Piston (Ø86,00 mm)

- 01.868.10 86,25 mm
- 01.868.20 86,50 mm
- 01.868.30 86,75 mm
- 01.868.40 87,00 mm



2.00x2,00x3,00

8 680437 027676

### 01.869.00 Ring (Ø86,00 mm)

- 01.869.10 86,25 mm
- 01.869.20 86,50 mm
- 01.869.30 86,75 mm
- 01.869.40 87,00 mm



2.00x2,00x3,00

8 680437 027737

### 01.752 Nut



M18X1.5 - Right Hand

8 680437 026204

### 01.026 Bushing



44X40X26

8 680437 071679

### 01.208 Bushing



44X40X20

8 680437 019602

### RK.01.381.01 Repair Kit



8 680437 118213  
 Knorr No: K114137K50

### RK.01.184 Repair Kit



8 680437 061885



## Twin Cylinder Compressor Ø86 mm-628 CC-Stroke 54 mm

Application - Vehicle  
IVECO STRALIS / AS 440 / HI-WAY  
(STRALIS)

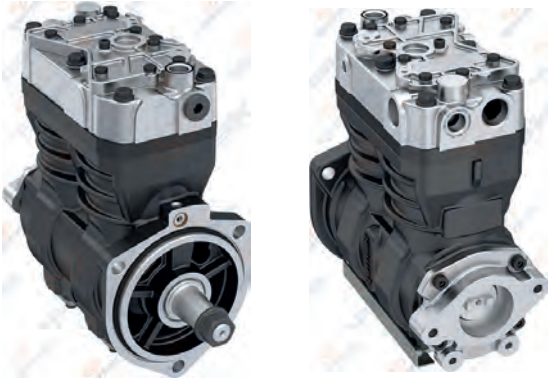

**01.04.096.10**

Oem. Ref. No.  
504293730  
5801216167

Knorr. No.  
LK4936-K022263N00  
LK4969-K031813N00



**01.1400** Crankcase



**RK.01.679** Repair Kit

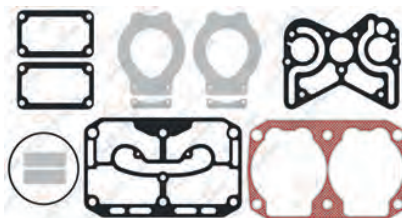

Knorr No: K083735K50

**RK.01.136.13** Repair Kit

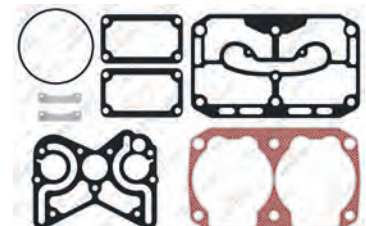

**RK.01.742**

Complete Cylinder Head

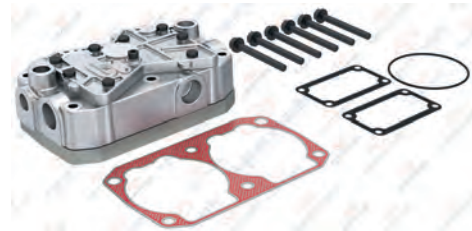

**RK.01.676.11**

Valve Plate Kit

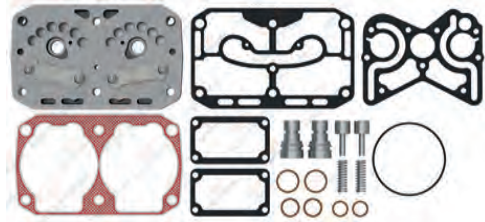

**RK.01.676.10**

Valve Plate Kit



Oem No: 42562099  
Knorr No: K041488K50

**RK.01.136.02**

Repair Kit

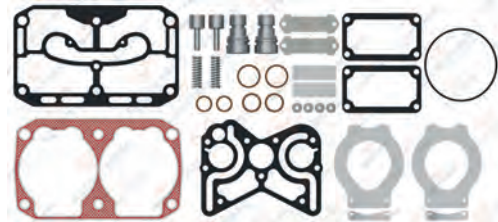

**RK.01.136.03**

Repair Kit

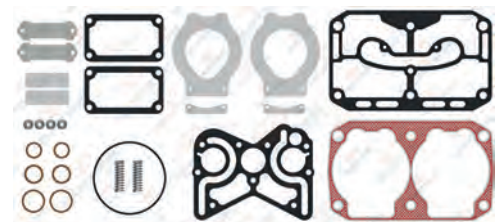



# IVECO - DEUTZ

## AIR COMPRESSOR AND REPAIR KIT

### RK.01.742.10 Complete Cylinder Head



8 680437 082842 **Oem No :** 42562098  
**Knorr No:** K041489K50 - K057166K50

### 01.1492 Valve Plate



8 680437 079927

### 01.1030 Crankshaft



M18X1.5 - Right Hand

8 680437 014980

### RK.01.676.12 Repair Kit

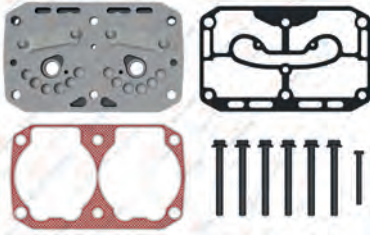

8 680437 009894 **Knorr No:** K112297K50

### 01.1018 Crankshaft Flange



8 680437 014805

### 01.587 Connecting Rod



8 680437 024323

### RK.01.272.00 Piston&Ring (Ø86,00 mm)

- RK.01.272.10 86,25 mm
- RK.01.272.20 86,50 mm
- RK.01.272.30 86,75 mm
- RK.01.272.40 87,00 mm



2.00x2,00x3,00

8 680437 063209 **OEM No:** 42549147  
**Knorr No:** SEB22547 - SEB22548

### 01.868.00 Piston (Ø86,00 mm)

- 01.868.10 86,25 mm
- 01.868.20 86,50 mm
- 01.868.30 86,75 mm
- 01.868.40 87,00 mm



2.00x2,00x3,00

8 680437 027676

### 01.869.00 Ring (Ø86,00 mm)

- 01.869.10 86,25 mm
- 01.869.20 86,50 mm
- 01.869.30 86,75 mm
- 01.869.40 87,00 mm



2.00x2,00x3,00

8 680437 027737

### 01.752 Nut



M18X1.5 - Right Hand

8 680437 026204

### 01.026 Bushing



44X40X26

8 680437 071679

### 01.208 Bushing



44X40X20

8 680437 019602

### RK.01.381.01 Repair Kit



8 680437 118213 **Knorr No:** K114137K50

### RK.01.184 Repair Kit



8 680437 061885

## Twin Cylinder Compressor Ø86 mm-628 CC-Stroke 54 mm

Application - Vehicle  
IVECO / IRIS BUS CURSER ENGINE



**01.04.141**

Oem. Ref. No.  
504033988  
504079460

Knorr No.  
LK4952-K022264N00



8 680437 074 199



**01.1400**

Crankcase



8 680437 075 109

**RK.01.677**

Complete Cylinder Head



8 680437 073 000

**RK.01.676**

Valve Plate Kit



8 680437 07 1754

**RK.01.676.01**

Valve Plate Kit



8 680437 112211

**RK.01.679.01**

Repair Kit



8 680437 073345

**RK.01.679.05**

Repair Kit

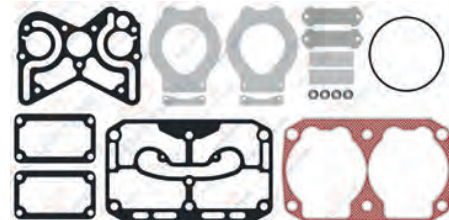

8 680437 122418

**RK.01.679**

Repair Kit

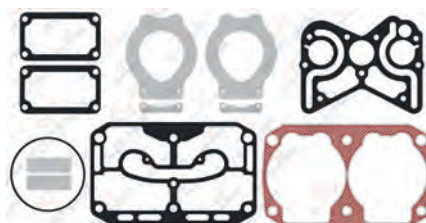

8 680437 07 1662

Knorr No: K083735K50

**RK.01.679.06**

Repair Kit

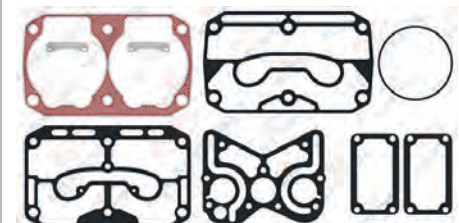

8 680437 079194

OEM No: 42549151  
Knorr No: SEB22550

# IVECO - DEUTZ

## AIR COMPRESSOR AND REPAIR KIT

**01.1619** Cylinder Head



Knorr No: K083733K50

8 680437 101758

**01.1463** Cylinder Head



8 680437 079934

**01.1376** Crankshaft



M18X1.5 - Left Hand

8 680437 073772

**01.1372** Valve Plate



OEM No : 42549156  
Knorr No: K044410K50

8 680437 074144

**01.1018** Crankshaft Flange



8 680437 014805

**01.587** Connecting Rod



8 680437 024323

**RK.01.272.00** Piston&Ring (Ø86,00 mm)

RK.01.272.10	86,25 mm
RK.01.272.20	86,50 mm
RK.01.272.30	86,75 mm
RK.01.272.40	87,00 mm



2.00x2,00x3,00

OEM No: 42549147  
Knorr No: SEB22547 - SEB22548

8 680437 063209

**01.868.00** Piston (Ø86,00 mm)

01.868.10	86,25 mm
01.868.20	86,50 mm
01.868.30	86,75 mm
01.868.40	87,00 mm



2.00x2,00x3,00

8 680437 027676

**01.869.00** Ring (Ø86,00 mm)

01.869.10	86,25 mm
01.869.20	86,50 mm
01.869.30	86,75 mm
01.869.40	87,00 mm



2.00x2,00x3,00

8 680437 027737

**01.870** Nut



M18X1.5 - Left Hand

8 680437 027799

**01.026** Bushing



44X40X26

8 680437 071679

**01.208** Bushing



44X40X20

8 680437 019602

**01.079** Cover



8 680437 014232

**01.079** Cover

**01.079** Cover

**01.079** Cover

**01.079** Cover

**01.079** Cover

IVECO  
DEUTZ



## Twin Cylinder Compressor Ø86 mm-628 CC-Stroke 54 mm

Application - Vehicle  
IVECO / IRIS BUS CURSER ENGINE



**01.04.141.10**

Oem. Ref. No.  
504079460  
504353252

Knorr No.  
LK4952-K022264N00



8 680437 080336



**01.1400** Crankcase



8 680437 075109

**RK.01.499.10** Complete Cylinder Head



8 680437 105848

**RK.01.339.10** Valve Plate Kit

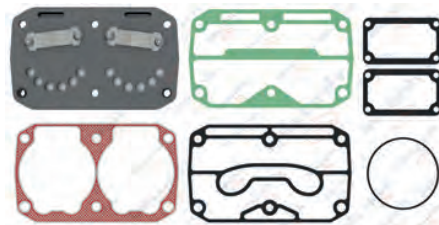

8 680437 112570

**RK.01.339.30** Valve Plate Kit

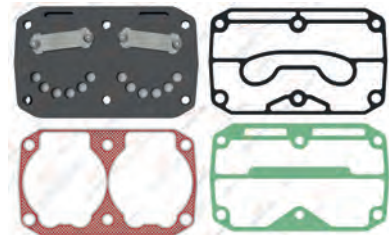

8 680437 112587

**RK.01.136.09** Repair Kit

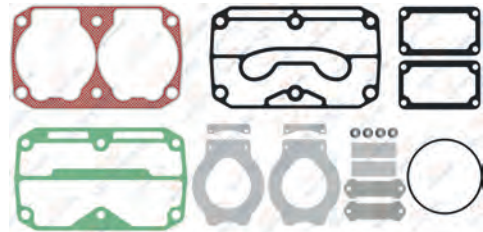

8 680437 076575

**RK.01.136.20** Valve Plate Kit

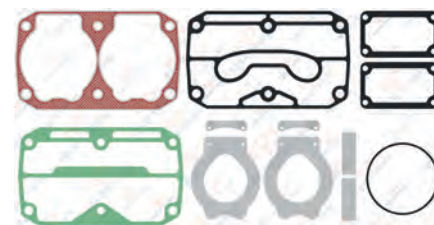

8 680437 074731

OEM No: 42546938

**RK.01.136.05** Repair Kit

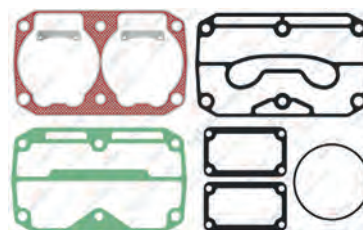

8 680437 079453

**RK.01.136.08** Repair Kit



8 680437 078630

# IVECO - DEUTZ

## AIR COMPRESSOR AND REPAIR KIT

**01.1312** Cylinder Head



8 680437 101734

**01.1566** Valve Plate



8 680437 114109

**01.1376** Crankshaft



M18X1.5 - Left Hand



8 680437 073772

**01.079** Cover



8 680437 014232

**01.1018** Crankshaft Flange



8 680437 014805

**01.587** Connecting Rod



8 680437 024323

**RK.01.272.00** Piston&Ring (Ø86,00 mm)

- RK.01.272.10 86,25 mm
- RK.01.272.20 86,50 mm
- RK.01.272.30 86,75 mm
- RK.01.272.40 87,00 mm



2.00x2,00x3,00



8 680437 063209

OEM No : 42549147  
Knorr No: SEB22547 - SEB22548

**01.868.00** Piston (Ø86,00 mm)

- 01.868.10 86,25 mm
- 01.868.20 86,50 mm
- 01.868.30 86,75 mm
- 01.868.40 87,00 mm



2.00x2,00x3,00



8 680437 027676

**01.869.00** Ring (Ø86,00 mm)

- 01.869.10 86,25 mm
- 01.869.20 86,50 mm
- 01.869.30 86,75 mm
- 01.869.40 87,00 mm



2.00x2,00x3,00



8 680437 027737

**01.870** Nut



M18X1.5 - Left Hand



8 680437 027799

**01.026** Bushing



44X40X26



8 680437 071679

**01.208** Bushing



44X40X20



8 680437 019602

**RK.01.184** Repair Kit



8 680437 061885

## Twin Cylinder Compressor Ø86 mm-628 CC-Stroke 54 mm

Application - Vehicle  
IVECO SPR1 / IRIS BUS



**01.04.142**

Oem. Ref. No.  
504293718  
504080658

Knorr No.  
LK4937-K031852N00



8 680437 074069



**01.1369** Crankcase



8 680437 073826

**RK.01.677.20**

Complete Cylinder Head

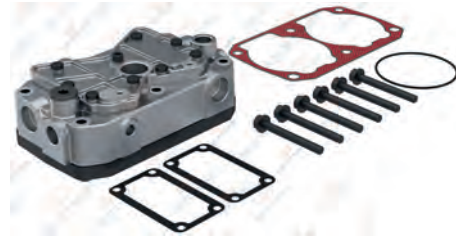

8 680437 105046

**RK.01.676**

Valve Plate Kit



8 680437 071754

**RK.01.676.01**

Valve Plate Kit



8 680437 112211

**RK.01.679.01**

Repair Kit



8 680437 073345

**RK.01.679.05**

Repair Kit

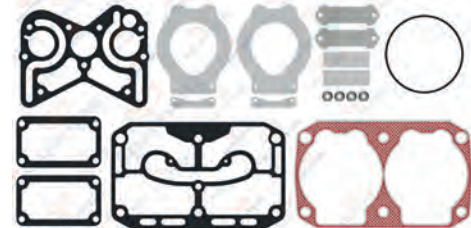

8 680437 122418

**RK.01.679**

Repair Kit

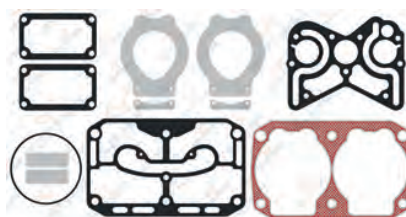

8 680437 071662

Knorr No: K083735K50

**RK.01.679.06**

Repair Kit

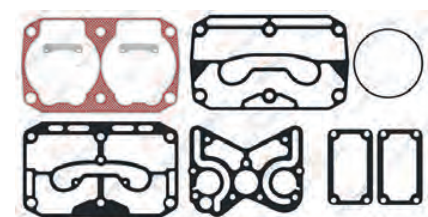

8 680437 079194

OEM No: 42549151  
Knorr No: SEB22550



# IVECO - DEUTZ

## AIR COMPRESSOR AND REPAIR KIT

01.1374

Cylinder Head



8 680437 076803

01.1373

Cylinder Head



8 680437 077831

01.1370

Crankshaft



M18X1.5 - Left Hand



8 680437 072164

01.1372

Valve Plate



8 680437 074144

OEM No : 42549156  
Knorr No: K044410K50

RK.01.677.21

Complete Cylinder Head



8 680437 079378

Knorr No: K047839K50

01.587

Connecting Rod



8 680437 024323

RK.01.272.00

Piston&Ring (Ø86,00 mm)

- RK.01.272.10 86,25 mm
- RK.01.272.20 86,50 mm
- RK.01.272.30 86,75 mm
- RK.01.272.40 87,00 mm



2.00x2,00x3,00



8 680437 063209

OEM No : 42549147  
Knorr No: SEB22547 - SEB22548

01.868.00

Piston (Ø86,00 mm)

- 01.868.10 86,25 mm
- 01.868.20 86,50 mm
- 01.868.30 86,75 mm
- 01.868.40 87,00 mm



2.00x2,00x3,00



8 680437 027676

01.869.00

Ring (Ø86,00 mm)

- 01.869.10 86,25 mm
- 01.869.20 86,50 mm
- 01.869.30 86,75 mm
- 01.869.40 87,00 mm



2.00x2,00x3,00



8 680437 027737

01.1371

Crankshaft Flange



8 680437 072195

01.026

Bushing



44X40X26



8 680437 071679

01.079

Cover



8 680437 014232

RK.01.184

Repair Kit



8 680437 061885

01.870

Nut



M18X1.5 - Left Hand



8 680437 027799

IVECO  
DEUTZ

## Twin Cylinder Compressor Ø86 mm-628 CC-Stroke 54 mm

Application - Vehicle  
IVECO / IRIS BUS



**01.04.142.10**

Oem. Ref. No.  
504293718  
504080658

Knorr No.  
LK4937-K031852N00



**01.1369**

Crankcase



**RK.01.136.05**

Repair Kit

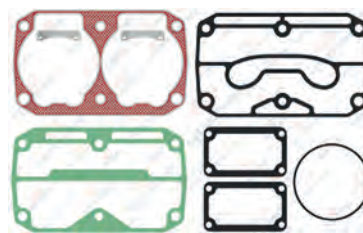

**RK.01.184**

Repair Kit



**RK.01.662**

Complete Cylinder Head



**RK.01.339.10**

Valve Plate Kit



**RK.01.339.30**

Valve Plate Kit

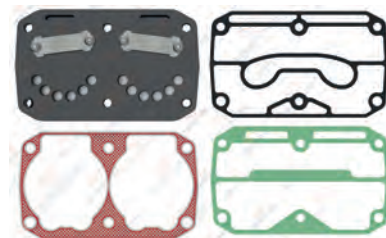

**RK.01.136.09**

Repair Kit

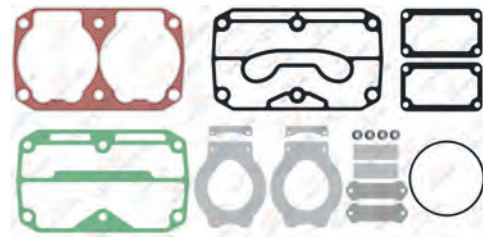

**RK.01.136.20**

Repair Kit

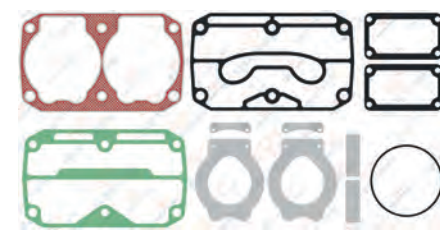

OEM No: 42546938

# IVECO - DEUTZ

## AIR COMPRESSOR AND REPAIR KIT

### 01.1620 Cylinder Head



OEM No : 42546398 Knorr : SEB22576  
SEB22577-SEB22578-SEB22588

### 01.1566 Valve Plate



### 01.1370 Crankshaft



M18X1.5 - Left Hand



### 01.026 Bushing



44X40X26



### 01.1371 Crankshaft Flange



### 01.587 Connecting Rod



### RK.01.272.00 Piston&Ring (Ø86,00 mm)

- RK.01.272.10 86,25 mm
- RK.01.272.20 86,50 mm
- RK.01.272.30 86,75 mm
- RK.01.272.40 87,00 mm



2.00x2,00x3,00



OEM No : 42549147  
Knorr No: SEB22547 - SEB22548

### 01.868.00 Piston (Ø86,00 mm)

- 01.868.10 86,25 mm
- 01.868.20 86,50 mm
- 01.868.30 86,75 mm
- 01.868.40 87,00 mm



2.00x2,00x3,00



### 01.869.00 Ring (Ø86,00 mm)

- 01.869.10 86,25 mm
- 01.869.20 86,50 mm
- 01.869.30 86,75 mm
- 01.869.40 87,00 mm



2.00x2,00x3,00



### RK.01.136.08 Repair Kit



### 01.870 Nut



M18X1.5 - Left Hand



### 01.079 Cover





## Twin Cylinder Compressor Ø86 mm- CC-Stroke mm

Application - Vehicle  
IVECO



**01.04.191**

Knorr No.  
LK4984-K068756N00



8 680437 127918



**01.1702** Crankcase



8 680437 127994

**RK.01.772.05** Repair Kit



8 680437 127970

Knorr No: K090939K50

**RK.01.772.06** Repair Kit



8 680437 127987

Knorr No: K091081K50

**RK.01.770**

Complete Cylinder Head



8 680437 127925

**RK.01.770.01**

Complete Cylinder Head



8 680437 127932

Knorr No: K090971K50

**RK.01.771**

Valve Plate Kit



8 680437 127949

Knorr No: K090953K50

**RK.01.772.01**

Repair Kit

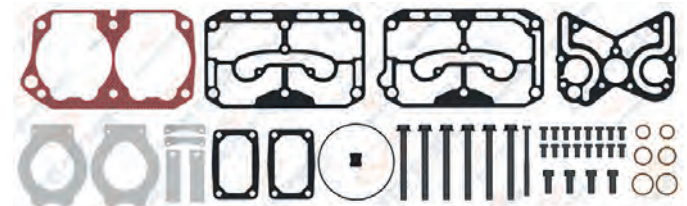

8 680437 127963

Knorr No: K090975K50

**RK.01.772**

Repair Kit

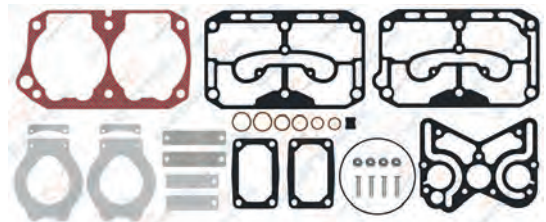

8 680437 127956

# IVECO - DEUTZ

## AIR COMPRESSOR AND REPAIR KIT

**01.1621** Cylinder Head



8 680437 128038

**01.1505** Cylinder Head



8 680437 104544

**01.1703** Crankshaft



8 680437 128007

**01.1704** Valve Plate



8 680437 128014

**01.1705** Cooling Plate



8 680437 128021

Knorr No: K068429

**01.226** Connecting Rod



8 680437 019824

Knorr No: SEB00967004

**RK.01.272.00** Piston&Ring (Ø86,00 mm)

- RK.01.272.10 86,25 mm
- RK.01.272.20 86,50 mm
- RK.01.272.30 86,75 mm
- RK.01.272.40 87,00 mm



2.00x2,00x3,00



8 680437 063209

OEM No : 42549147

Knorr No: SEB22547 - SEB22548

**01.868.00** Piston (Ø86,00 mm)

- 01.868.10 86,25 mm
- 01.868.20 86,50 mm
- 01.868.30 86,75 mm
- 01.868.40 87,00 mm



2.00x2,00x3,00



8 680437 027676

**01.869.00** Ring (Ø86,00 mm)

- 01.869.10 86,25 mm
- 01.869.20 86,50 mm
- 01.869.30 86,75 mm
- 01.869.40 87,00 mm



2.00x2,00x3,00



8 680437 027737

**01.1717** Crankshaft Flange



8 680437 128045

## Twin Cylinder Compressor Ø82 mm-600 CC-Stroke 56 mm

Application - Vehicle  
IVECO EUROSTAR 400 - 440  
EUROTECH 180 - 190



**01.04.052**

Oem. Ref. No.  
500310903

Knorr No.  
ACX83D-K007254



**01.672**

Crankcase



**RK.01.185.23**

Repair Kit

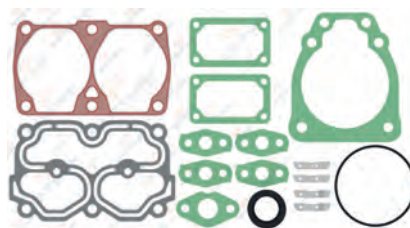

**RK.01.185.07**

Repair Kit

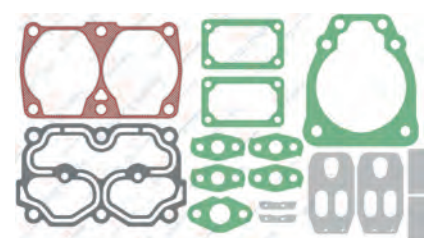

**RK.01.223**

Complete Cylinder Head



Knorr No: K029208K50

**RK.01.223.01**

Complete Cylinder Head



OEM No: 93161842 - 93162116 - 93161411 - 76628601  
Knorr No: K029207K50

**RK.01.185.01**

Repair Kit

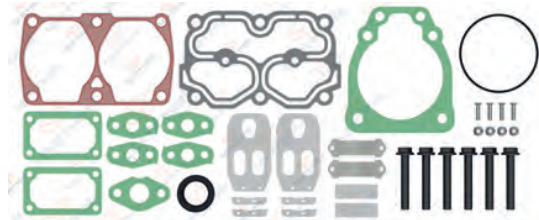

**RK.01.185.05**

Repair Kit

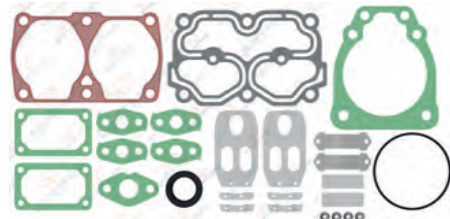

**RK.01.185**

Repair Kit

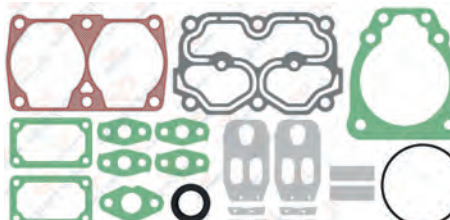



# IVECO - DEUTZ

## AIR COMPRESSOR AND REPAIR KIT

### 01.670 Cylinder Head



8 680437 025351

### 01.671 Valve Plate



8 680437 025368

### 01.675 Crankshaft



M18X1.5 - Right Hand



OEM No: 93190964

### 01.1332 Bushing



42X38X22



8 680437 009924

### 01.674 Crankshaft Flange



OEM No: 93159347

### 01.673 Connecting Rod



8 680437 025382

### RK.01.253.00 Piston&Ring (Ø82,00 mm)

- RK.01.253.10 82,25 mm
- RK.01.253.20 82,50 mm
- RK.01.253.30 82,75 mm
- RK.01.253.40 83,00 mm



2.50x2,50x4,00



8 680437 062785

### 01.827.00 Piston (Ø82,00 mm)

- 01.827.10 82,25 mm
- 01.827.20 82,50 mm
- 01.827.30 82,75 mm
- 01.827.40 83,00 mm



2.50x2,50x4,00



OEM No: 93161412

### 01.362.00 Ring (Ø82,00 mm)

- 01.362.10 82,25 mm
- 01.362.20 82,50 mm
- 01.362.30 82,75 mm
- 01.362.40 83,00 mm



2.50x2,50x4,00



OEM No: 93161415

### RK.01.207 Repair Kit



8 680437 062172

### 01.752 Nut



M18X1.5 - Right Hand



8 680437 026204

### 01.1458 Gear



8 680437 072379

### RK.01.185.03 Repair Kit

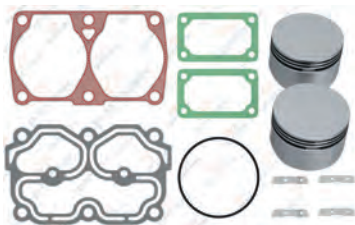

8 680437 119340

Knorr No: K028911K50

### RK.01.185.02 Repair Kit

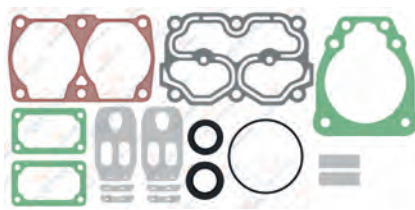

8 680437 073215

## Twin Cylinder Compressor Ø82 mm-591 CC-Stroke 56 mm

Application - Vehicle  
IVECO SPR1 Heavy  
IRISBUS Eurorider- IRISBUS Bus



**01.04.079**

Oem. Ref. No.  
500329613

Knorr No.  
ACX83DX-K007304



**01.672** Valve Plate



**RK.01.185.23** Repair Kit

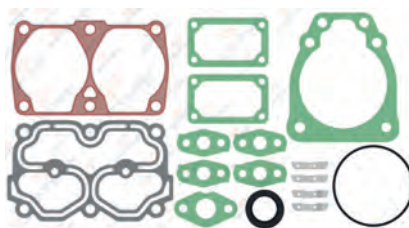

**RK.01.207** Repair Kit



**RK.01.223** Complete Cylinder Head



Knorr No: K029208K50

**RK.01.185.01** Repair Kit

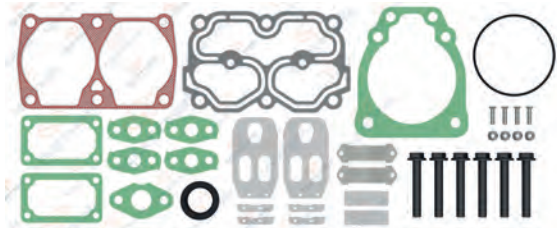

**RK.01.185.05** Repair Kit

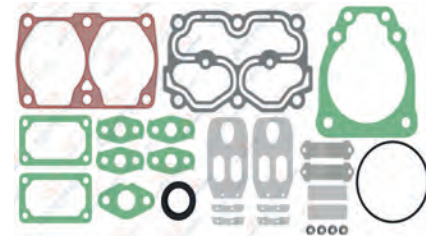

**RK.01.185** Repair Kit

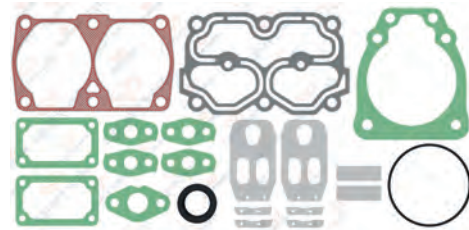

**RK.01.185.07** Repair Kit

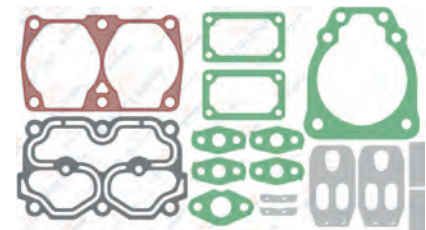

# IVECO - DEUTZ

## AIR COMPRESSOR AND REPAIR KIT

**01.670** Cylinder Head



8 680437 025351

**01.671** Valve Plate



8 680437 025368

**01.1347** Crankshaft



M18X1.5 - Right Hand



8 680437 108559

**01.1332** Bushing



42X38X22



8 680437 009924

**01.1348** Crankshaft Flange



8 680437 084587

**01.673** Connecting Rod



8 680437 025382

**RK.01.253.00** Piston&Ring (Ø82,00 mm)

- RK.01.253.10 82,25 mm
- RK.01.253.20 82,50 mm
- RK.01.253.30 82,75 mm
- RK.01.253.40 83,00 mm



2.50x2,50x4,00



8 680437 062785

**01.827.00** Piston (Ø82,00 mm)

- 01.827.10 82,25 mm
- 01.827.20 82,50 mm
- 01.827.30 82,75 mm
- 01.827.40 83,00 mm

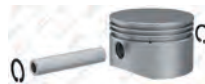

2.50x2,50x4,00



8 680437 027171

OEM No: 93161412

**01.362.00** Ring (Ø82,00 mm)

- 01.362.10 82,25 mm
- 01.362.20 82,50 mm
- 01.362.30 82,75 mm
- 01.362.40 83,00 mm



2.50x2,50x4,00



8 680437 021575

OEM No: 93161415

**01.1323** Cover



**01.1325** Cover



**01.1458** Gear



8 680437 072379

**RK.01.185.03** Repair Kit

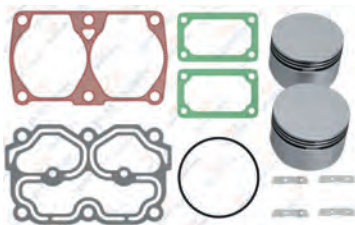

8 680437 119340

Knorr No: K028911K50

**01.752** Nut



M18X1.5 - Right Hand



8 680437 026204



## Twin Cylinder Compressor Ø85 mm-704 CC-Stroke 62 mm

### Application - Vehicle

IVECO EuroCargo 150 E 27 R 4 x 2 van/estate  
EuroTrakker MP 340 E 42 H 8 x 4/4 Tipper  
EuroTrakker MP 410 E 42 W 8 x 8 /4 platform/chassis  
PEGASO 5522.22.300 / 6522.22.400 /  
5522.22.465



### 01.05.046

Oem. Ref. No.	Wabco No.
4860565	9115060500
500310906	9115060540
5003329471	



### RK.01.118.00 Piston&Ring

RK.01.118.10	75,25 mm
RK.01.118.20	75,50 mm
RK.01.118.30	75,75 mm
RK.01.118.40	76,00 mm



2.00x2.00x4.00



OEM No:0513860-1242704-5000816053  
Wabco No: 4111416232

### 01.911.00 Piston

01.911.10	75,25 mm
01.911.20	75,50 mm
01.911.30	75,75 mm
01.911.40	76,00 mm



2.00x2.00x4.00



### 01.134.00 Ring

01.134.10	75,25 mm
01.134.20	75,50 mm
01.134.30	75,75 mm
01.134.40	76,00 mm



2.00x2.00x4.00



### RK.01.338

### Complete Cylinder Head



Wabco No: 9115038032

### RK.01.194.01

### Repair Kit



### RK.01.194

### Repair Kit

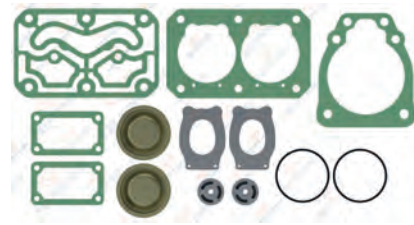

### RK.01.194.02

### Repair Kit

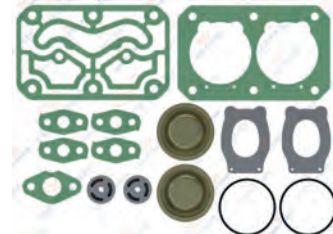

### RK.01.194.03

### Repair Kit

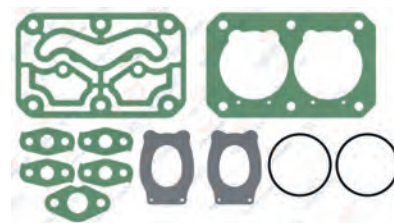

# IVECO - DEUTZ

AIR COMPRESSOR AND REPAIR KIT

## Twin Cylinder Compressor Ø88 mm-600 CC-Stroke 50 mm

Application - Vehicle  
IVECO

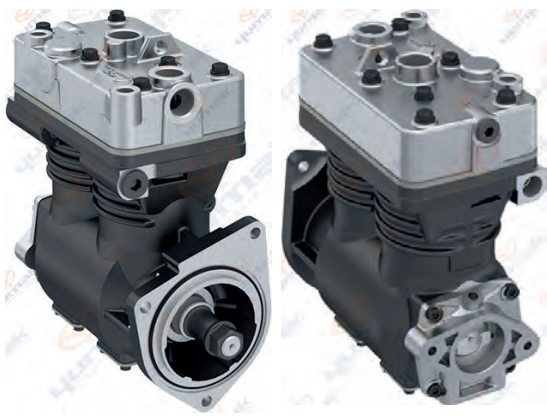

**01.04.105**

Oem. Ref. No.  
1180445  
971025

Knorr No.  
LP4961-II30900



8 680437 011750



**01.1513**

Crankcase



8 680437 102663

**RK.01.083**

Repair Kit

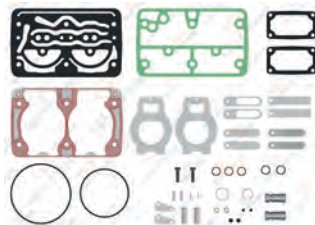

Knorr No: SEB22596

**RK.01.083.03**

Repair Kit



8 680437 059851

**RK.01.719**

Complete Cylinder Head



8 680437 104865

**RK.01.719.20**

Complete Cylinder Head

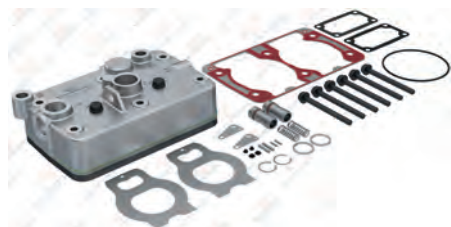

8 680437 104872

**RK.01.082.20**

Valve Plate Kit

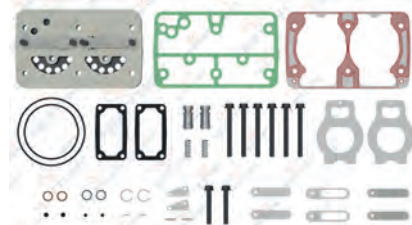

8 680437 075574

**RK.01.082**

Valve Plate Kit

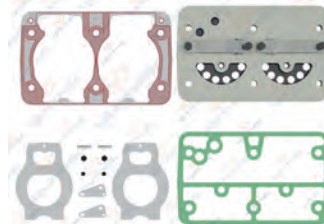

8 680437 059813

**RK.01.083.01**

Repair Kit

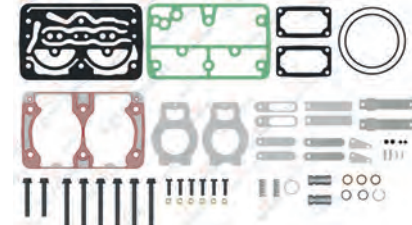

8 680437 059844



# IVECO - DEUTZ

## AIR COMPRESSOR AND REPAIR KIT

**01.1516** Cylinder Head

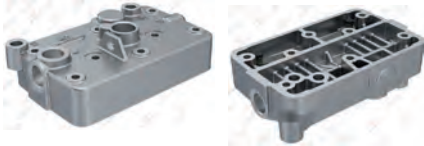

8 680437 079422

**01.1515** Crankshaft Flange



8 680437 080039

**01.1514** Crankshaft



M20X1.5 - Right Hand



8 680437 077787

**RK.01.082.02** Valve Plate Kit



Knorr No: SEB01033004

**RK.01.807** Connecting Rod & Piston

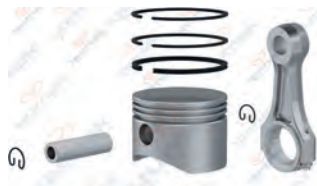

8 680437 114598

**01.226** Connecting Rod



Knorr No: SEB00967004

**RK.01.034.00** Piston&Ring (Ø88,00 mm)

- RK.01.034.10 88,25 mm
- RK.01.034.20 88,50 mm
- RK.01.034.30 88,75 mm
- RK.01.034.40 89,00 mm



2.50x2,50x4,00



Knorr No: I81169004 - SEB22555

**01.110.00** Piston (Ø88,00 mm)

- 01.110.10 88,25 mm
- 01.110.20 88,50 mm
- 01.110.30 88,75 mm
- 01.110.40 89,00 mm



2.50x2,50x4,00



8 680437 015994

**01.136.00** Ring (Ø88,00 mm)

- 01.136.10 88,25 mm
- 01.136.20 88,50 mm
- 01.136.30 88,75 mm
- 01.136.40 89,00 mm



2.50x2,50x4,00



OEM No : 1409318  
Knorr No: I139526F0061

**01.414** Cover



8 680437 022312

**01.292** Bushing



42X38X25



8 680437 073871

**01.144** Nut



M20X1.5 - Right Hand



8 680437 018742

**RK.01.088.20** Repair Kit



OEM No : 1376280  
Knorr No: I1326840061

**RK.01.083.20** Repair Kit

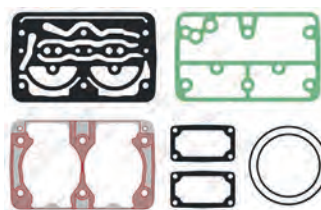

Knorr No: SEB22561\*

**RK.01.126** Repair Kit



8 680437 060642

**RK.01.088** Repair Kit



OEM No: 3091718 - 3097145

## Twin Cylinder Compressor Ø80 mm-400 CC-Stroke 40 mm

Application - Vehicle  
IVECO 170 / 190 / 220 / 240 NC / NT 300 / 370  
RANGE 170 / 190 / 220 / 240



**01.04.081**

Oem. Ref. No.  
99440236

Knorr No.  
ACX75-K007579



**01.972** Crankcase



**RK.01.212** Repair Kit

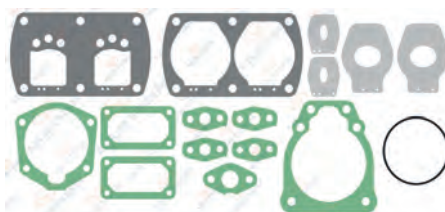

**RK.01.212.02** Repair Kit

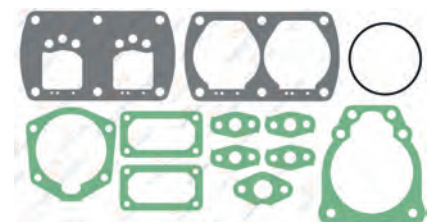

**RK.01.356** Complete Cylinder Head



Knorr No: K029171K50

**RK.01.356.20** Complete Cylinder Head

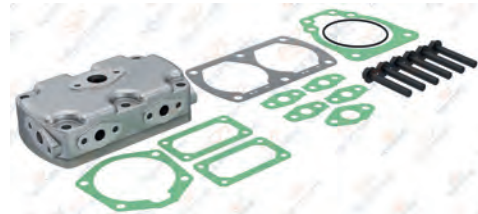

**RK.01.355.20** Valve Plate Kit

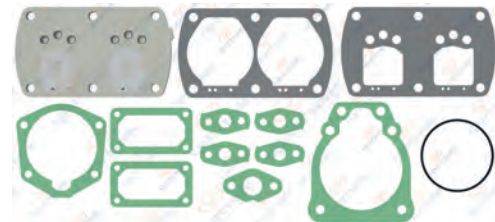

**RK.01.355** Valve Plate Kit



**RK.01.212.01** Repair Kit

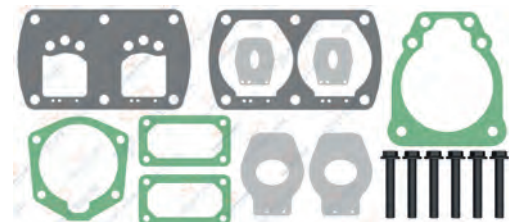

# IVECO - DEUTZ

## AIR COMPRESSOR AND REPAIR KIT

**01.966** Cylinder Head



8 680437 029052

**01.969** Valve Plate



8 680437 029090

**01.974** Crankshaft



M20X1.5 - Right Hand



8 680437 029144

**01.011** Bushing



42X38X20.5



8 680437 009979

**01.971** Crankshaft Flange



8 680437 029113

**01.673** Connecting Rod



8 680437 025382

**RK.01.364.00** Piston&Ring (Ø80,00 mm)

- RK.01.364.10 80,25 mm
- RK.01.364.20 80,50 mm
- RK.01.364.30 80,75 mm
- RK.01.364.40 81,00 mm



2.00x2.00x4.00



8 680437 064374

**01.965.00** Piston (Ø80,00 mm)

- 01.965.10 80,25 mm
- 01.965.20 80,50 mm
- 01.965.30 80,75 mm
- 01.965.40 81,00 mm



2.00x2.00x4.00



8 680437 028994

**01.954.00** Ring (Ø80,00 mm)

- 01.954.10 80,25 mm
- 01.954.20 80,50 mm
- 01.954.30 80,75 mm
- 01.954.40 81,00 mm



2.00x2.00x4.00



8 680437 028796

**01.144** Nut



M20X1.5 - Right Hand



8 680437 018742

**01.414** Cover



8 680437 022312

**01.1459** Gear



8 680437 074649

**RK.01.219** Repair Kit



8 680437 062325



## Single Cylinder Compressor Ø80 mm-250 CC-Stroke 50 mm

**Application - Vehicle**  
IVECO 160.26 / 180.26 / 190.30  
/ 260.30 / 180 / 170  
190 NC / NT 300 RANGE 26



**01.04.082**

**Oem. Ref. No.**  
4802597  
99440235

**Knorr No.**  
ACX67-K007564



**01.973** Crankcase



**RK.01.354.20** Repair Kit

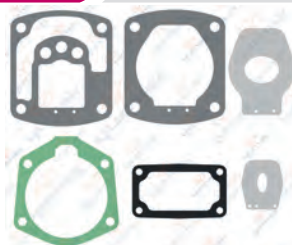

**RK.01.363** Complete Cylinder Head



**Knorr No:** K029189K50

**RK.01.353.20** Valve Plate Kit



**RK.01.353** Valve Plate Kit



**RK.01.354.01** Repair Kit

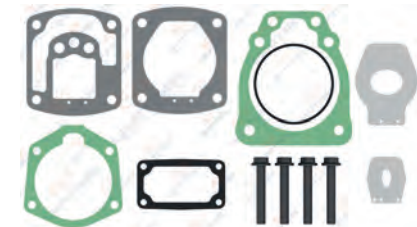

**RK.01.354** Repair Kit

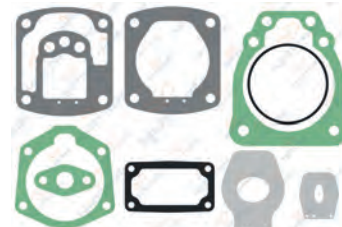

**RK.01.354.22** Repair Kit



# IVECO - DEUTZ

## AIR COMPRESSOR AND REPAIR KIT

**01.967** Cylinder Head

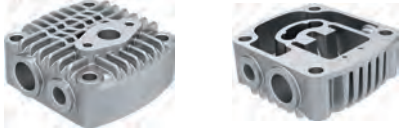

8 680437 029076

**01.970** Cooling Plate



8 680437 029106

**01.975** Crankshaft



M20X1.5 - Right Hand



8 680437 029151

**01.994** Bushing



36X32X22



8 680437 029397

**01.979** Crankshaft Flange



8 680437 029243

**01.673** Connecting Rod



8 680437 025382

**RK.01.365.00** Piston&Ring (Ø80,00 mm)

- RK.01.365.10 80,25 mm
- RK.01.365.20 80,50 mm
- RK.01.365.30 80,75 mm
- RK.01.365.40 81,00 mm



2,00x2,00x4,00



8 680437 064435

**01.978.00** Piston (Ø80,00 mm)

- 01.978.10 80,25 mm
- 01.978.20 80,50 mm
- 01.978.30 80,75 mm
- 01.978.40 81,00 mm



2,00x2,00x4,00



8 680437 029182

**01.954.00** Ring (Ø80,00 mm)

- 01.954.10 80,25 mm
- 01.954.20 80,50 mm
- 01.954.30 80,75 mm
- 01.954.40 81,00 mm



2,00x2,00x4,00



8 680437 028796

**RK.01.426** Repair Kit



8 680437 065104

**01.414** Cover



8 680437 022312

**01.144** Nut



M20X1.5 - Right Hand



8 680437 018742

## Single Cylinder Compressor Ø80 mm-250 CC-Stroke 50 mm

Application - Vehicle  
IVECO EURO CARGO 100 E - 120 E - 170 E - 180 E  
- 440 E - 60 E

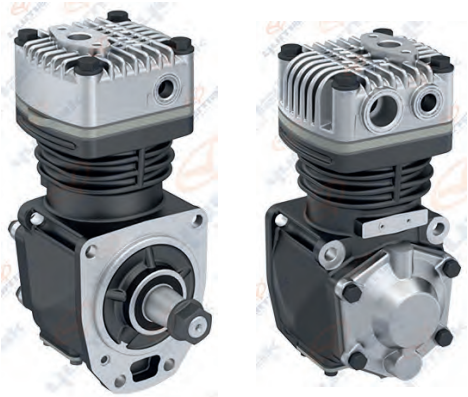

**01.04.139**

Oem. Ref. No.  
500310901  
98465001

Knorr No.  
ACX69D-K007388



**01.973.10** Crankcase



**RK.01.354.22** Repair Kit



**RK.01.363** Complete Cylinder Head



Knorr No: K029189K50

**RK.01.353**

Valve Plate Kit



**RK.01.354.01**

Repair Kit

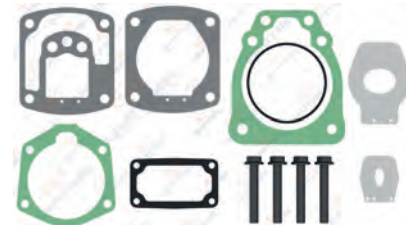

**RK.01.354**

Repair Kit

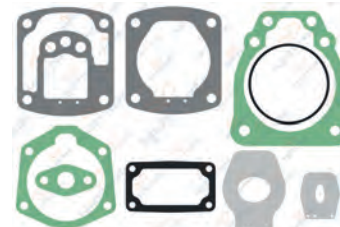

**RK.01.354.20**

Repair Kit

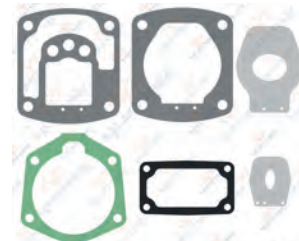

**RK.01.426**

Repair Kit





# IVECO - DEUTZ

## AIR COMPRESSOR AND REPAIR KIT

**01.967** Cylinder Head

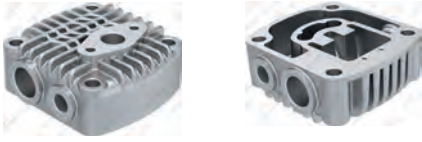

**01.970** Cooling Plate



**01.975.10** Crankshaft



M20X1.5 - Right Hand



**01.994.10** Bushing



36X32X15.75



**01.979** Crankshaft Flange



**01.673** Connecting Rod



**RK.01.365.00** Piston&Ring (Ø80,00 mm)

- RK.01.365.10 80,25 mm
- RK.01.365.20 80,50 mm
- RK.01.365.30 80,75 mm
- RK.01.365.40 81,00 mm



2,00x2,00x4,00



**01.978.00** Piston (Ø80,00 mm)

- 01.978.10 80,25 mm
- 01.978.20 80,50 mm
- 01.978.30 80,75 mm
- 01.978.40 81,00 mm



2,00x2,00x4,00



**01.954.00** Ring (Ø80,00 mm)

- 01.954.10 80,25 mm
- 01.954.20 80,50 mm
- 01.954.30 80,75 mm
- 01.954.40 81,00 mm



2,00x2,00x4,00



**01.144** Nut



M20X1.5 - Right Hand



**01.414** Cover



## Single Cylinder Compressor Ø85 mm-352 CC-Stroke 62 mm

### Application - Vehicle

IVECO STRALIS AS 440S40 4 x 2 TRACTOR  
AS 440S43 4 x 2 TRACTOR  
AS 440S40 6 x 2/4 TRACTOR  
AS 440S43 6 x 2/4 TRACTOR

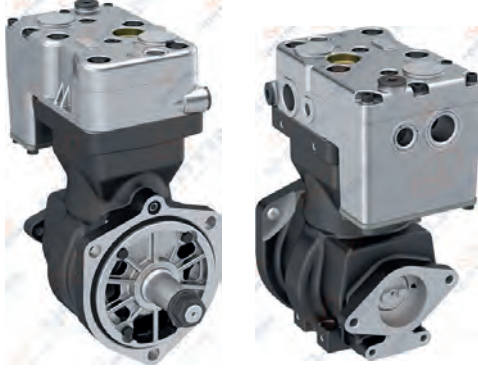

**01.06.025**

#### Oem. Ref. No.

504308489  
41211219  
41211220

#### Wabco No.

4123520200  
4123520080



**01.1455**

Crankcase



**RK.01.130.10**

Repair Kit



**RK.01.507** Complete Cylinder Head



**RK.01.360.01**

Repair Kit

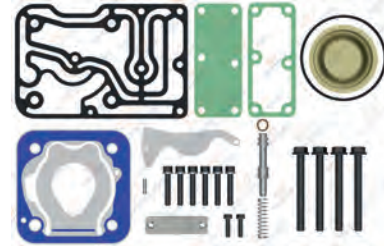

**RK.01.360**

Repair Kit

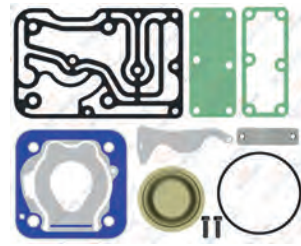

**RK.01.360.04**

Repair Kit

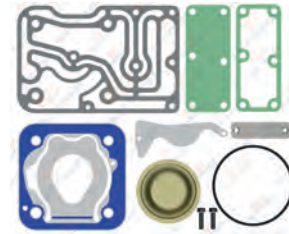

Use for old version cylinder repair kit. Yıpranmış kapaklar için.

**RK.01.360.02**

Repair Kit

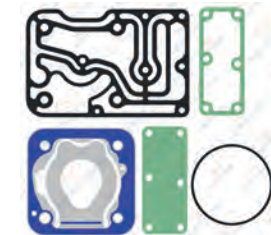

**RK.01.201**

Repair Kit



# IVECO - DEUTZ

## AIR COMPRESSOR AND REPAIR KIT

### 01.1469 Cylinder Head



8 680437 079446

### 01.1053 Valve Plate



8 680437 015307

### 01.1457 Crankshaft Flange



8 680437 079507

### 01.1456 Crankshaft



For 4123520200  
M18X1.5 Left Hand



8 680437 079569

### 01.1456.05 Crankshaft



For 4123520080  
M18X1.5 Right Hand



8 680437 128199

### 01.390 Connecting Rod



8 680437 022015

### RK.01.104.00 Piston&Ring (Ø85,00 mm)

- RK.01.104.10 85,25 mm
- RK.01.104.20 85,50 mm
- RK.01.104.30 85,75 mm
- RK.01.104.40 86,00 mm



2,00x2,00x4,00



8 680437 060277

OEM No: 1283781

### 01.142.00 Piston (Ø85,00 mm)

- 01.142.10 85,25 mm
- 01.142.20 85,50 mm
- 01.142.30 85,75 mm
- 01.142.40 86,00 mm



2,00x2,00x4,00



8 680437 018674

Wabco No: 9115016242 - 9115016252

### 01.373.00 Ring (Ø85,00 mm)

- 01.373.10 85,25 mm
- 01.373.20 85,50 mm
- 01.373.30 85,75 mm
- 01.373.40 86,00 mm



2,00x2,00x4,00



8 680437 075431

Wabco No: 9115019202

### RK.01.800 Connecting Rod & Piston



8 680437 078302

Wabco No: 9125109272 - 4123529252  
4123529292

### 01.302 Cap



8 680437 020769

### 01.012 Bushing



39X35X16



8 680437 009986

Oem No : 1315390  
Wabco No: 4115223404

### 01.870 Nut



M18X1.5 - Left Hand



8 680437 027799

### 01.752 Nut



M18X1.5 - Right Hand



8 680437 026204

### 01.1099 Cover



8 680437 015987

IVECO  
DEUTZ



## Single Cylinder Compressor Ø80 mm-225 CC

Application - Vehicle  
IVECO  
SPR1 Medium - Heavy - Light  
IRISBUS Bus



**01.04.034**

Oem. Ref. No.  
504016815  
5040080656

Knorr No.  
LK3840-K002141X00



**01.1314**

Crankcase



**RK.01.159.28**

Repair Kit

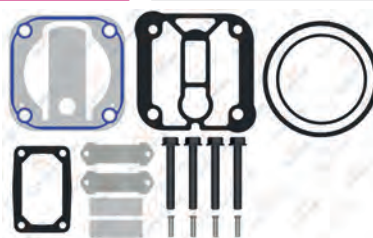

**RK.01.159.17**

Repair Kit

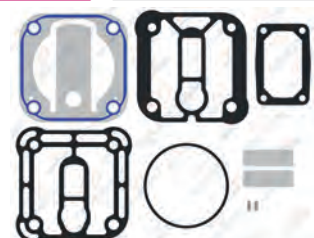

Knorr No: SEB22518\*\*

**RK.01.683**

Complete Cylinder Head



**RK.01.683.01**

Complete Cylinder Head



**RK.01.638.02**

Valve Plate Kit



**RK.01.638**

Valve Plate Kit



**RK.01.159.03**

Repair Kit

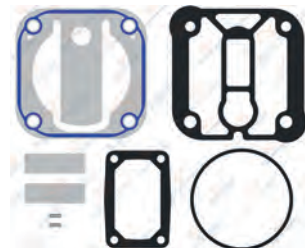

# IVECO - DEUTZ

## AIR COMPRESSOR AND REPAIR KIT

### 01.1300 Cylinder Head



8 680437 101581

### 01.1301 Cylinder Head

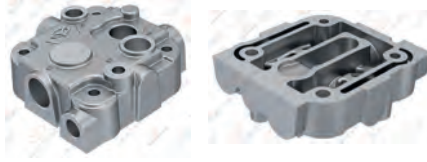

8 680437 127796

### 01.1339 Crankshaft



M18X1.5 - Left Hand



8 680437 072430

### 01.1290 Valve Plate



8 680437 071624

### 01.1392 Crankshaft Flange



8 680437 072225

### 01.1101 Connecting Rod



8 680437 016069

### RK.01.601.00 Piston&Ring (Ø80,00 mm)

- RK.01.601.10 80,25 mm
- RK.01.601.20 80,50 mm
- RK.01.601.30 80,75 mm
- RK.01.601.40 81,00 mm



2.50x2,50x4,00

Knorr No: SEB22517



8 680437 067054

### 01.1201.00 Piston (Ø80,00 mm)

- 01.1201.10 80,25 mm
- 01.1201.20 80,50 mm
- 01.1201.30 80,75 mm
- 01.1201.40 81,00 mm



2.50x2,50x4,00



8 680437 017530

### 01.1226.00 Ring (Ø80,00 mm)

- 01.1226.10 80,25 mm
- 01.1226.20 80,50 mm
- 01.1226.30 80,75 mm
- 01.1226.40 81,00 mm



2.50x2,50x4,00



8 680437 017882

### 01.374 Cover



8 680437 077022

### 01.820 Bushing



42X38X25



8 680437 027058

### 01.870 Nut



M18X1.5 - Left Hand



8 680437 027799

### RK.01.159.04 Repair Kit

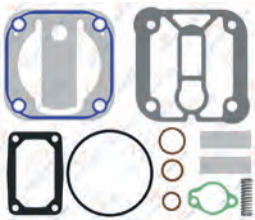

8 680437 061489

Use for old version cylinder repair kit.  
Yıpranmış kapaklar için.

### RK.01.159.05 Repair Kit

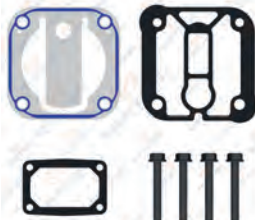

8 680437 120377

Knorr No: SEB018190051

### RK.01.208 Repair Kit



8 680437 062189

## Single Cylinder Compressor Ø88 mm-300 CC-Stroke 50 mm

Application - Vehicle  
IVECO  
DEUTZ 1012-11013



**01.04.027**

Oem. Ref. No.	Knorr No.
1180656	LK3965-II33163-K021890



**01.306** Crankcase



**RK.01.115** Repair Kit

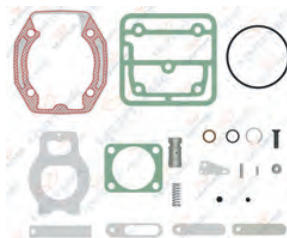

**RK.01.112** Complete Cylinder Head



**RK.01.112.20** Complete Cylinder Head



**RK.01.113.01** Valve Plate Kit

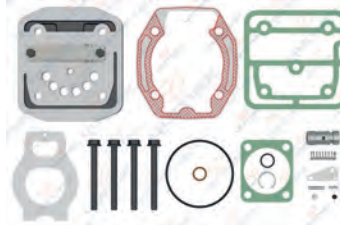

**RK.01.113** Valve Plate Kit



**RK.01.115.01** Valve Plate Kit

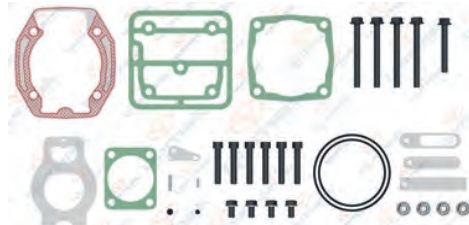

Knorr No: K110174K50

**RK.01.115.03** Repair Kit

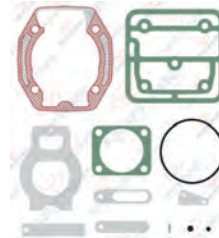



# IVECO - DEUTZ

## AIR COMPRESSOR AND REPAIR KIT

**01.304** Cylinder Head



8 680437 020783

**01.355** Valve Plate



Knorr No : II14777004

**01.307** Crankshaft



M20X1.5 - Right Hand



8 680437 020844

**01.881** Pump Support



8 680437 027942

**01.308** Crankshaft Flange



8 680437 020851

**01.008** Connecting Rod



8 680437 009795

**RK.01.034.00** Piston&Ring (Ø88,00 mm)

- RK.01.034.10 88,25 mm
- RK.01.034.20 88,50 mm
- RK.01.034.30 88,75 mm
- RK.01.034.40 89,00 mm



2.50x2,50x4,00



Knorr No: I81169004 - SEB22555

**01.110.00** Piston (Ø88,00 mm)

- 01.110.10 88,25 mm
- 01.110.20 88,50 mm
- 01.110.30 88,75 mm
- 01.110.40 89,00 mm



2.50x2,50x4,00



8 680437 015994

**01.136.00** Ring (Ø88,00 mm)

- 01.136.10 88,25 mm
- 01.136.20 88,50 mm
- 01.136.30 88,75 mm
- 01.136.40 89,00 mm



2.50x2,50x4,00



OEM No : 1409318

Knorr No: II39526F0061

**RK.01.114** Cylinder Liner Set



8 680437 060437

Knorr No: K000998

**01.305** Cylinder Liner



8 680437 020806

**01.013** Bushing



34X30X16



8 680437 009993

**RK.01.029** Repair Kit



8 680437 058700

**01.195** Bushing



34X30X16



8 680437 019411

## Single Cylinder Compressor Ø88 mm-300 CC-Stroke 50 mm

Application - Vehicle  
IVECO  
DEUTZ



**01.04.182**

Oem. Ref. No.

Knorr No.

LK39.. / K000275R



**01.306**

Crankcase



**RK.01.408**

Repair Kit



**RK.01.112.10**

Complete Cylinder Head



**RK.01.749**

Valve Plate Kit



**RK.01.750**

Repair Kit

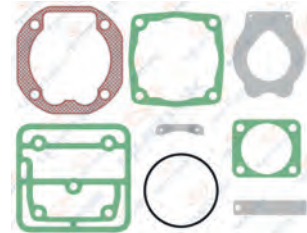

**RK.01.750.01**

Repair Kit

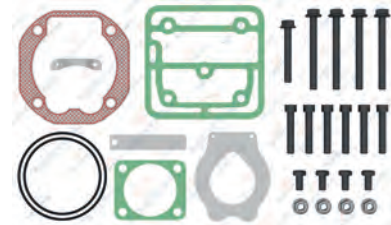

Knorr No: K110176K50

**RK.01.323**

Repair Kit

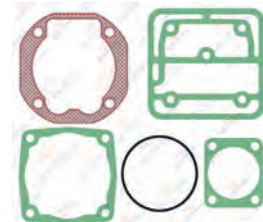

# IVECO - DEUTZ

## AIR COMPRESSOR AND REPAIR KIT

**01.304.10** Cylinder Head

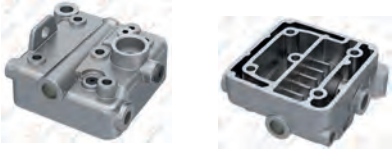

8 680437 128559

**01.355.10** Valve Plate



8 680437 115966

**01.307** Crankshaft



M20X1.5 - Right Hand



8 680437 020844

**01.881** Pump Support



8 680437 027942

**01.308** Crankshaft Flange



8 680437 020851

**01.008** Connecting Rod



8 680437 009795

**RK.01.034.00** Piston&Ring (Ø88,00 mm)

- RK.01.034.10 88,25 mm
- RK.01.034.20 88,50 mm
- RK.01.034.30 88,75 mm
- RK.01.034.40 89,00 mm



2.50x2,50x4,00



Knorr No: I81169004 - SEB22555

**01.110.00** Piston (Ø88,00 mm)

- 01.110.10 88,25 mm
- 01.110.20 88,50 mm
- 01.110.30 88,75 mm
- 01.110.40 89,00 mm



2.50x2,50x4,00



8 680437 015994

**01.136.00** Ring (Ø88,00 mm)

- 01.136.10 88,25 mm
- 01.136.20 88,50 mm
- 01.136.30 88,75 mm
- 01.136.40 89,00 mm



2.50x2,50x4,00



OEM No : 1409318  
Knorr No: I139526F0061

**RK.01.032** Cylinder Liner Set



8 680437 058779

**01.057** Cylinder Liner



8 680437 015181

OEM No : 01173720S1

**RK.01.032.01** Cylinder Liner Set



8 680437 093282

**01.195** Bushing



34X30X16



8 680437 019411

IVECO  
DEUTZ



## Single Cylinder Compressor Ø88 mm-300 CC-Stroke 50 mm

Application - Vehicle  
IVECO  
DEUTZ 1013



**01.04.028**

Oem. Ref. No.  
1180581

Knorr No.  
LK3966-II32223



**01.306**

Crankcase



**RK.01.115**

Repair Kit

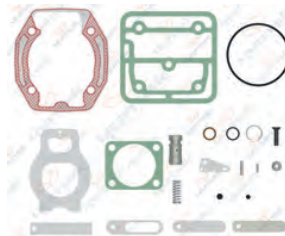

**RK.01.112** Complete Cylinder Head



**RK.01.112.20**

Complete Cylinder Head



**RK.01.113.01**

Valve Plate Kit

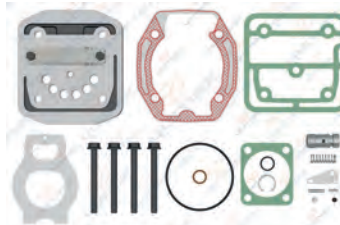

**RK.01.113**

Valve Plate Kit



**RK.01.115.01**

Repair Kit

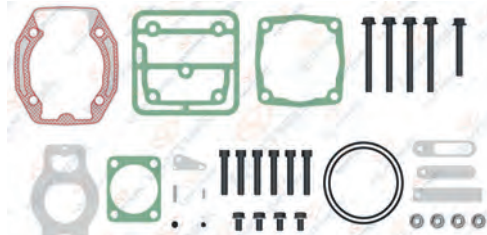

Knorr No: K110174K50

**RK.01.115.03**

Repair Kit

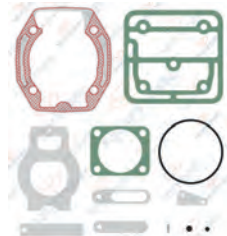

# IVECO - DEUTZ

## AIR COMPRESSOR AND REPAIR KIT

01.304

Cylinder Head



8 680437 020783

01.355

Valve Plate



8 680437 021476

Knorr No: II14777004

01.307

Crankshaft



M20X1.5 - Right Hand



8 680437 020844

01.073

Cover



8 680437 014133

01.308

Crankshaft Flange



8 680437 020851

01.008

Connecting Rod



8 680437 009795

RK.01.034.00

Piston&Ring (Ø88,00 mm)

- RK.01.034.10 88,25 mm
- RK.01.034.20 88,50 mm
- RK.01.034.30 88,75 mm
- RK.01.034.40 89,00 mm



2.50x2,50x4,00



8 680437 058816

Knorr No: I81169004 - SEB22555

01.110.00

Piston (Ø88,00 mm)

- 01.110.10 88,25 mm
- 01.110.20 88,50 mm
- 01.110.30 88,75 mm
- 01.110.40 89,00 mm



2.50x2,50x4,00



8 680437 015994

01.136.00

Ring (Ø88,00 mm)

- 01.136.10 88,25 mm
- 01.136.20 88,50 mm
- 01.136.30 88,75 mm
- 01.136.40 89,00 mm



2.50x2,50x4,00



8 680437 018384

OEM No : 1409318

Knorr No: II39526F0061

RK.01.114

Cylinder Liner Set



8 680437 060437

Knorr No: K000998

01.305

Cylinder Liner



8 680437 020806

01.013

Bushing



34X30X16



8 680437 009993

RK.01.029

Repair Kit



8 680437 058700

01.195

Bushing



34X30X16



8 680437 019411

IVECO  
DEUTZ

## Single Cylinder Compressor Ø88 mm-300 CC-Stroke 50 mm

Application - Vehicle  
IVECO  
DEUTZ Engine BF6LS13R



### 01.04.025

Oem. Ref. No.	Knorr No.
01177290	LK3908-189875
01174519	LK3902-189873
1173793	



### 01.085 Crankcase



### RK.01.148.02 Repair Kit

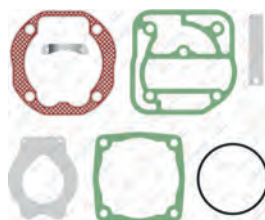

### RK.01.068 Complete Cylinder Head



### RK.01.068.01 Complete Cylinder Head

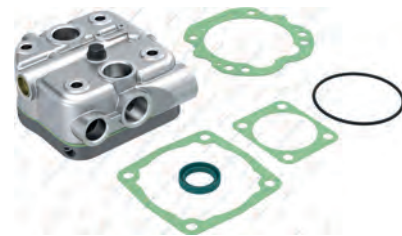

### RK.01.035.01 Valve Plate Kit

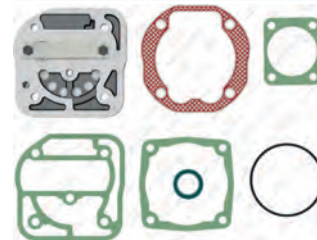

### RK.01.035.02 Valve Plate Kit



### RK.01.148.06 Repair Kit

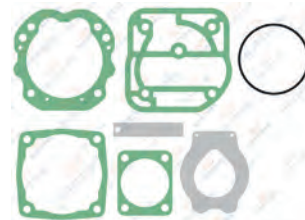

### RK.01.148.03 Repair Kit





# IVECO - DEUTZ

## AIR COMPRESSOR AND REPAIR KIT

### 01.076 Cylinder Head



8 680437 014164

### 01.139 Valve Plate



8 680437 018537

### 01.358 Crankshaft



M20X1.5 - Right Hand



8 680437 021520

### 01.195 Bushing



34X30X16



8 680437 019411

### 01.340 Crankshaft Flange



8 680437 021308

### 01.008 Connecting Rod



8 680437 009795

### RK.01.034.00 Piston&Ring (Ø88,00 mm)

- RK.01.034.10 88,25 mm
- RK.01.034.20 88,50 mm
- RK.01.034.30 88,75 mm
- RK.01.034.40 89,00 mm



2.50x2,50x4,00



8 680437 058816

Knorr No: I81169004 - SEB22555

### 01.110.00 Piston (Ø88,00 mm)

- 01.110.10 88,25 mm
- 01.110.20 88,50 mm
- 01.110.30 88,75 mm
- 01.110.40 89,00 mm



2.50x2,50x4,00



8 680437 015994

### 01.136.00 Ring (Ø88,00 mm)

- 01.136.10 88,25 mm
- 01.136.20 88,50 mm
- 01.136.30 88,75 mm
- 01.136.40 89,00 mm



2.50x2,50x4,00



8 680437 018384

OEM No : 1409318  
Knorr No: I139526F0061

### RK.01.032 Cylinder Liner Set



8 680437 058779

### 01.057 Cylinder Liner



8 680437 013181

OEM No : 01173720S1

### 01.144 Nut



M20X1.5 - Right Hand



8 680437 018742

### RK.01.148.05 Repair Kit

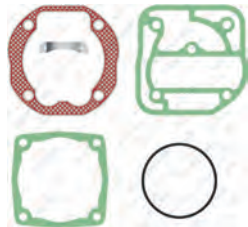

8 680437 120209

### 01.013 Bushing



34X30X16



8 680437 009993

## Single Cylinder Compressor Ø92 mm-360 CC

### Application - Vehicle

EUROCARGO 75E-120E-100E-150E-130E  
EUROCARGO (TECTOR) 120E-100E-150E-  
130E-260E-180E-75E  
TECTOR 120-160 / 65-100



**01.04.145**

Oem. Ref. No.  
504016818

Knorr No.  
LK3994-SEB01842000



**01.1633** Valve Plate



**RK.01.395.04** Repair Kit

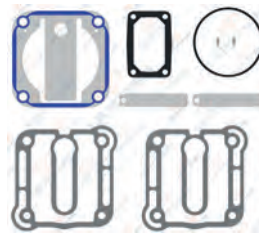

Use for old version cylinder repair kit.  
Yıpranmış kapaklar için.

**RK.01.395.02** Repair Kit

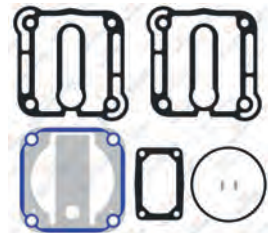

**RK.01.644**

Complete Cylinder Head



**RK.01.645.01**

Valve Plate Kit



**RK.01.645**

Valve Plate Kit



**RK.01.395.05**

Repair Kit

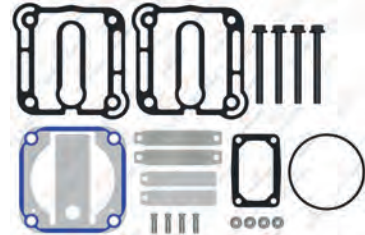

**RK.01.395.06**

Repair Kit



# IVECO - DEUTZ

## AIR COMPRESSOR AND REPAIR KIT

### 01.1304 Cylinder Head



Oem. No: 42548631  
Knorr No: SEB01943004

### 01.940 Cooling Plate



Knorr No: SEB01728004

### 01.1207 Crankshaft



M18X1.5 - Left Hand

8 680437 017639

### 01.186 Valve Plate



8 680437 019190

### 01.1392 Crankshaft Flange



Knorr No: SEB018190061

### 01.1101 Connecting Rod



8 680437 016069

### RK.01.318.00 Piston&Ring (Ø92,00 mm)

- RK.01.318.10 92,25 mm
- RK.01.318.20 92,50 mm
- RK.01.318.30 92,75 mm
- RK.01.318.40 93,00 mm



2.50x2,50x4,00

Knorr No: K012079 - K006026

### 01.862.00 Piston (Ø92,00 mm)

- 01.862.10 92,25 mm
- 01.862.20 92,50 mm
- 01.862.30 92,75 mm
- 01.862.40 93,00 mm



2.50x2,50x4,00

8 680437 027584

### 01.942.00 Ring (Ø92,00 mm)

- 01.942.10 92,25 mm
- 01.942.20 92,50 mm
- 01.942.30 92,75 mm
- 01.942.40 93,00 mm



2.50x2,50x4,00

8 680437 028666

### 01.374 Cover



8 680437 077022

### 01.292 Bushing



42X38X25

8 680437 075871

### 01.870 Nut



M18X1.5 - Left Hand

8 680437 027799



## Single Cylinder Compressor Ø88 mm-300 CC-Stroke 50 mm

Application - Vehicle  
IVECO 330 SERIES



**01.04.023**

Oem. Ref. No.

01174474  
01173720  
11001360

Knorr. No.

LK3904-I78976



8 680437 010968



**01.338**

Crankcase

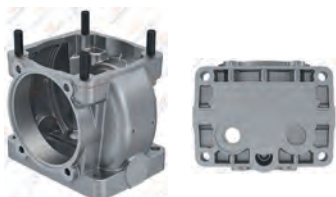

8 680437 021278

**RK.01.148.02**

Repair Kit

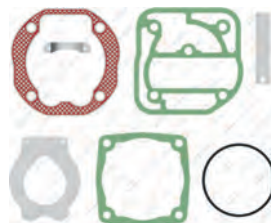

8 680437 006978

**RK.01.068** Complete Cylinder Head



8 680437 059493

Knorr No: ZB4275

**RK.01.068.01**

Complete Cylinder Head

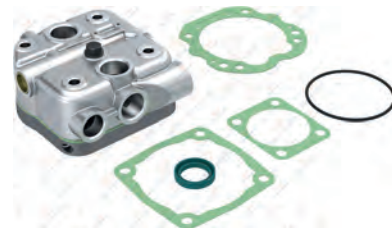

8 680437 105558

Knorr No: ZB4275\*

**RK.01.035.01**

Valve Plate Kit

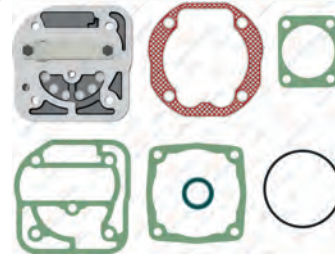

8 680437 112426

**RK.01.035.02**

Valve Plate Kit



8 680437 112433

Knorr No: I880570061

**RK.01.148**

Repair Kit

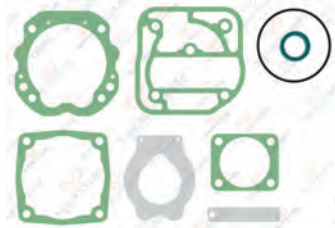

8 680437 061236

**RK.01.148.03**

Repair Kit



8 680437 120193

# IVECO - DEUTZ

## AIR COMPRESSOR AND REPAIR KIT

**01.076** Cylinder Head



8 680437 014164

**01.139** Valve Plate



Knorr No: II38715F004  
8 680437 018537

**01.099** Crankshaft



M18X1.5 - Right Hand  
8 680437 014560

**01.013** Bushing



34X30X16  
8 680437 009993

**01.066** Crankshaft Flange



8 680437 013976

**01.008** Connecting Rod



8 680437 009795

**RK.01.034.00** Piston&Ring (Ø88,00 mm)

RK.01.034.10	88,25 mm
RK.01.034.20	88,50 mm
RK.01.034.30	88,75 mm
RK.01.034.40	89,00 mm



2.50x2,50x4,00  
Knorr No: I81169004 - SEB22555  
8 680437 058816

**01.110.00** Piston (Ø88,00 mm)

01.110.10	88,25 mm
01.110.20	88,50 mm
01.110.30	88,75 mm
01.110.40	89,00 mm



2.50x2,50x4,00  
8 680437 015994

**01.136.00** Ring (Ø88,00 mm)

01.136.10	88,25 mm
01.136.20	88,50 mm
01.136.30	88,75 mm
01.136.40	89,00 mm



2.50x2,50x4,00  
OEM No : 1409318  
Knorr No: II39526F0061  
8 680437 018384

**RK.01.032** Cylinder Liner Set



Knorr No: I789790061  
8 680437 058779

**01.057** Cylinder Liner



OEM No : 01173720S1  
8 680437 013181

**01.143** Nut



M18X1.5 - Right Hand  
8 680437 018735

**RK.01.148.05** Repair Kit



8 680437 120209

**01.073** Cover



8 680437 014133

**00.140** Roller Bearing



6305  
8 680437 001577

## Single Cylinder Compressor Ø88 mm-300 CC-Stroke 50 mm

Application - Vehicle  
IVECO F8L 413F



### 01.04.005

Oem. Ref. No.  
1174473  
1173859

Knorr No.  
LK1900-I81156



### 01.313

Crankcase

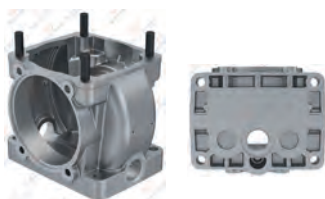

### RK.01.033.02

Repair Kit

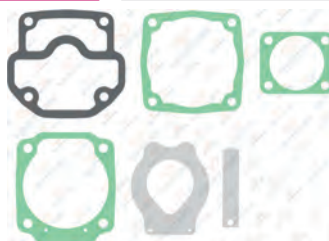

### RK.01.033

Repair Kit

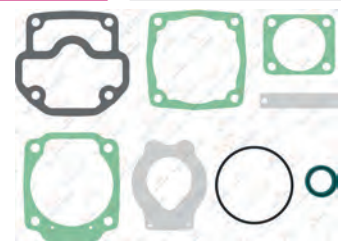

### RK.01.146

Complete Cylinder Head



### RK.01.146.01

Complete Cylinder Head



### RK.01.074.01

Valve Plate Kit

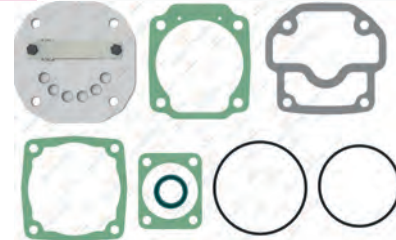

### RK.01.074

Valve Plate Kit



### RK.01.033.06

Repair Kit

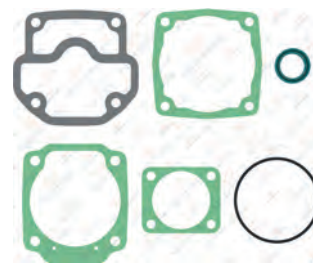



# IVECO - DEUTZ

## AIR COMPRESSOR AND REPAIR KIT

**01.379** Cylinder Head



8 680437 021902

**01.120** Valve Plate



8 680437 017509

**01.201** Crankshaft



M18X1.5 - Right Hand



8 680437 019480

**01.195** Bushing



34X30X16



8 680437 019411

**01.194** Crankshaft Flange



8 680437 019398

**01.008** Connecting Rod



8 680437 009795

**RK.01.034.00** Piston&Ring (Ø88,00 mm)

- RK.01.034.10 88,25 mm
- RK.01.034.20 88,50 mm
- RK.01.034.30 88,75 mm
- RK.01.034.40 89,00 mm



2.50x2,50x4,00



8 680437 058816

Knorr No: I81169004 - SEB22555

**01.110.00** Piston (Ø88,00 mm)

- 01.110.10 88,25 mm
- 01.110.20 88,50 mm
- 01.110.30 88,75 mm
- 01.110.40 89,00 mm



2.50x2,50x4,00



8 680437 015994

**01.136.00** Ring (Ø88,00 mm)

- 01.136.10 88,25 mm
- 01.136.20 88,50 mm
- 01.136.30 88,75 mm
- 01.136.40 89,00 mm



2.50x2,50x4,00



8 680437 018384

OEM No : 1409318  
Knorr No: I139526F0061

**RK.01.032** Cylinder Liner Set



8 680437 058779

Knorr No: I789790061

**01.057** Cylinder Liner



8 680437 013181

OEM No : 01173720S1

**01.143** Roller Bearing



M18X1.5 - Right Hand



8 680437 018735

**RK.01.033.03** Repair Kit



8 680437 075899

**RK.01.357** Repair Kit



8 680437 064305

**01.013** Bushing



34X30X16



8 680437 009993

## Single Cylinder Compressor Ø88 mm-300 CC-Stroke 50 mm

Application - Vehicle  
IVECO FL 413F

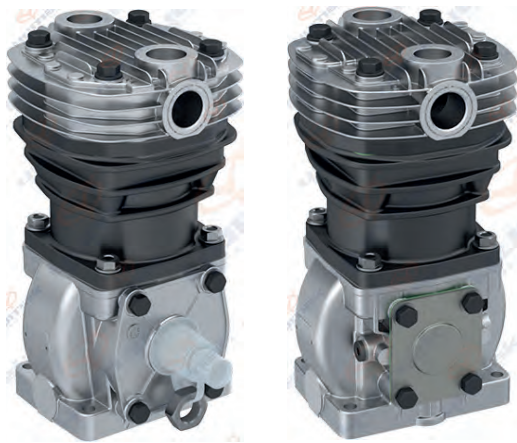

### 01.04.006

**Oem. Ref. No.**

1174472  
1173860  
1261657

**Knorr. No.**

LK1901-I81089



8 680437 010791



### 01.338 Crankcase

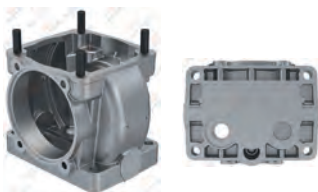

8 680437 021278

### RK.01.033.02 Repair Kit

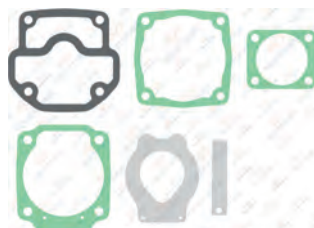

8 680437 058809

### RK.01.036 Complete Cylinder Head



8 680437 058885

### RK.01.036.01 Complete Cylinder Head



8 680437 106319

### RK.01.074.01 Valve Plate Kit

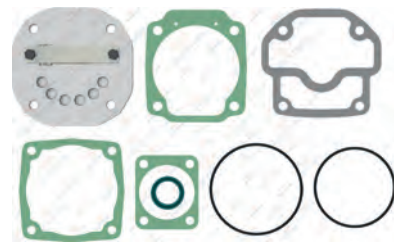

8 680437 078685

### RK.01.074 Valve Plate Kit



8 680437 059608

### RK.01.033.01 Repair Kit

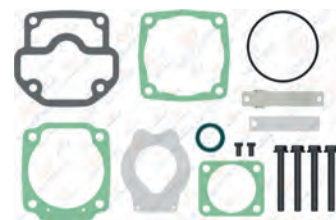

8 680437 058793

### RK.01.033 Repair Kit

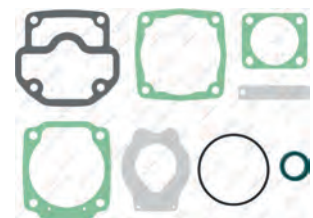

8 680437 058786

# IVECO - DEUTZ

## AIR COMPRESSOR AND REPAIR KIT

**01.068** Cylinder Head



8 680437 014010

**01.120** Valve Plate



8 680437 017509

**01.201** Crankshaft



M18X1.5 - Right Hand



8 680437 019480

**01.195** Bushing



34X30X16



8 680437 019411

**01.194** Crankshaft Flange



8 680437 019398

**01.008** Connecting Rod



8 680437 009795

**RK.01.034.00** Piston&Ring (Ø88,00 mm)

- RK.01.034.10 88,25 mm
- RK.01.034.20 88,50 mm
- RK.01.034.30 88,75 mm
- RK.01.034.40 89,00 mm



2.50x2,50x4,00



8 680437 058816

Knorr No: I81169004 - SEB22555

**01.110.00** Piston (Ø88,00 mm)

- 01.110.10 88,25 mm
- 01.110.20 88,50 mm
- 01.110.30 88,75 mm
- 01.110.40 89,00 mm



2.50x2,50x4,00



8 680437 015994

**01.136.00** Ring (Ø88,00 mm)

- 01.136.10 88,25 mm
- 01.136.20 88,50 mm
- 01.136.30 88,75 mm
- 01.136.40 89,00 mm



2.50x2,50x4,00



8 680437 018384

OEM No : 1409318  
Knorr No: I139526F0061

**RK.01.032** Cylinder Liner Set



8 680437 058779

Knorr No: I789790061

**01.057** Cylinder Liner



8 680437 013181

OEM No : 01173720S1

**01.073** Cover



8 680437 014133

**RK.01.033.06** Repair Kit

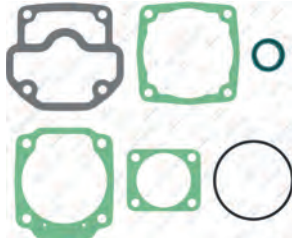

8 680437 078692

**RK.01.357** Repair Kit



8 680437 064305

**01.013** Bushing



34X30X16



8 680437 009993



# Single Cylinder Compressor Ø88 mm-300 CC-Stroke 50 mm

Application - Vehicle  
IVECO FL 413F



**01.04.007**

Oem. Ref. No.  
1173852

Knorr No.  
LP1959-I80214



8 680437 010807



**01.338**

Crankcase

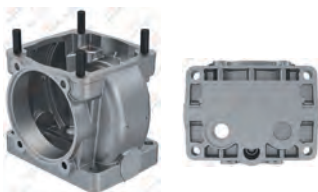

8 680437 021278

**RK.01.033.02**

Repair Kit

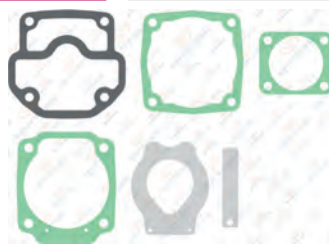

8 680437 058809

**RK.01.036** Complete Cylinder Head



8 680437 058885

**RK.01.036.01**

Complete Cylinder Head



8 680437 106319

**RK.01.074.01**

Valve Plate Kit

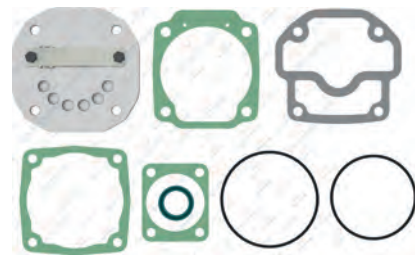

8 680437 078685

**RK.01.074**

Valve Plate Kit

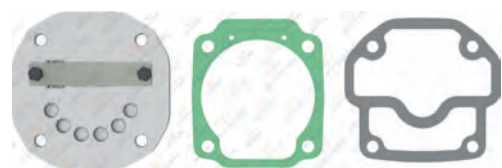

8 680437 059608

**RK.01.033.01**

Repair Kit

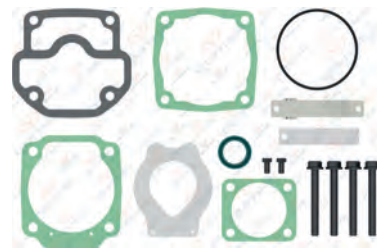

8 680437 058793

**RK.01.033**

Repair Kit

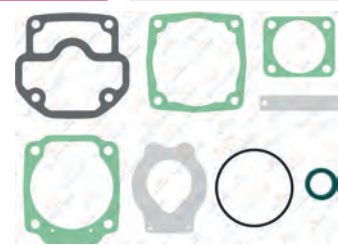

8 680437 058786

# IVECO - DEUTZ

## AIR COMPRESSOR AND REPAIR KIT

**01.068** Cylinder Head



8 680437 014010

**01.120** Valve Plate



8 680437 017509

**01.099** Crankshaft



M18X1.5 - Right Hand



8 680437 014560

**01.013** Bushing



34X30X16



8 680437 009993

**01.066** Crankshaft Flange



8 680437 015976

**01.008** Connecting Rod



8 680437 009795

**RK.01.034.00** Piston&Ring (Ø88,00 mm)

- RK.01.034.10 88,25 mm
- RK.01.034.20 88,50 mm
- RK.01.034.30 88,75 mm
- RK.01.034.40 89,00 mm



2.50x2,50x4,00



8 680437 058816

Knorr No: I81169004 - SEB22555

**01.110.00** Piston (Ø88,00 mm)

- 01.110.10 88,25 mm
- 01.110.20 88,50 mm
- 01.110.30 88,75 mm
- 01.110.40 89,00 mm



2.50x2,50x4,00



8 680437 015994

**01.136.00** Ring (Ø88,00 mm)

- 01.136.10 88,25 mm
- 01.136.20 88,50 mm
- 01.136.30 88,75 mm
- 01.136.40 89,00 mm



2.50x2,50x4,00



8 680437 018384

OEM No : 1409318  
Knorr No: I139526F0061

**RK.01.032** Cylinder Liner Set



8 680437 058779

Knorr No: I789790061

**01.057** Cylinder Liner



8 680437 015181

OEM No : 01173720S1

**01.073** Cover



8 680437 014133

**RK.01.033.06** Repair Kit

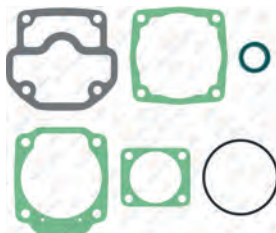

8 680437 078692

**RK.01.357** Repair Kit



8 680437 064305

**00.140** Roller Bearing



6305



8 680437 001577

## Single Cylinder Compressor Ø75 mm-155 CC-Stroke 35 mm

Application - Vehicle  
IVECO



### 01.05.001

Oem. Ref. No.	Knorr No.
1173877	LK1500 - I77107
01261659	LK1503 - I78519
1261100	LK1504 - I78520
008009674	
1173863	
1173876	
1173875	
42522661	
42522660	



### 01.313 Crankcase

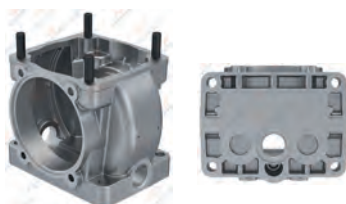

### RK.01.046.21 Repair Kit

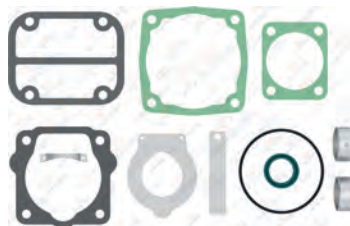

### RK.01.048 Complete Cylinder Head



Knorr No: STW63841

### RK.01.048.20 Complete Cylinder Head

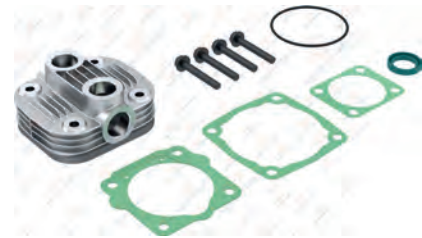

### RK.01.047.20 Valve Plate Kit

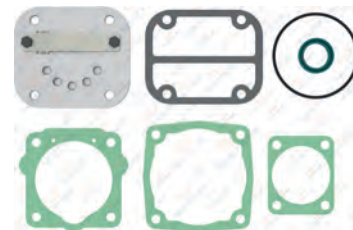

### RK.01.047 Valve Plate Kit



Knorr No: II3871F004

### RK.01.046.01 Repair Kit

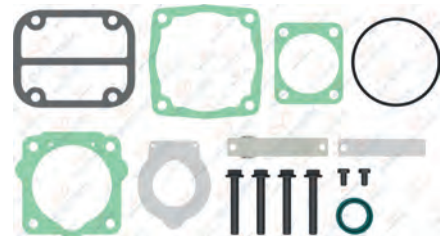

### RK.01.046 Repair Kit

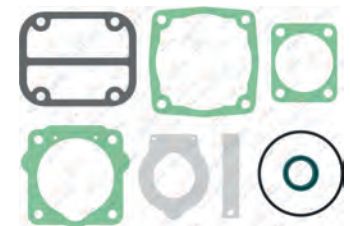



# IVECO - DEUTZ

## AIR COMPRESSOR AND REPAIR KIT

### 01.067 Cylinder Head

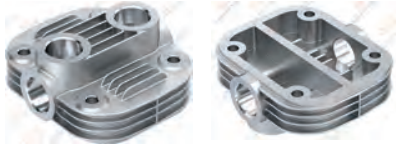

8 680437 013990

### 01.119 Valve Plate



Knorr No: II38717F004

8 680437 017387

### 01.089 Crankshaft



M18X1.5 - Right Hand



8 680437 014386

### 01.013 Bushing



34X30X16



8 680437 009993

### 01.066 Crankshaft Flange



8 680437 013976

### 01.003 Connecting Rod



8 680437 009672

### RK.01.073.00 Piston&Ring (Ø75,00 mm)

- RK.01.073.10 75,25 mm
- RK.01.073.20 75,50 mm
- RK.01.073.30 75,75 mm
- RK.01.073.40 76,00 mm



2,00X2,00X4,00



8 680437 059547

OEM No :1315279-1315280-1433932  
Knorr No: SEB22539-SEB22540

### 01.193.00 Piston (Ø75,00 mm)

- 01.193.10 75,25 mm
- 01.193.20 75,50 mm
- 01.193.30 75,75 mm
- 01.193.40 76,00 mm



2,00X2,00X4,00



8 680437 019336

### 01.134.00 Ring (Ø75,00 mm)

- 01.134.10 75,25 mm
- 01.134.20 75,50 mm
- 01.134.30 75,75 mm
- 01.134.40 76,00 mm



2,00X2,00X4,00



8 680437 018278

### RK.01.045 Cylinder Liner Set



8 680437 059004

Knorr No: I77246

### 01.056 Cylinder Liner



8 680437 013174

### 01.073 Cover



8 680437 014133

### RK.01.046.02 Repair Kit

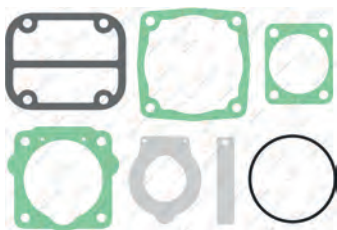

8 680437 072843

### 01.143 Nut



M18X1.5 - Right Hand



8 680437 018735

### 00.140 Roller Bearing



6305



8 680437 001577

## Single Cylinder Compressor Ø75 mm-155 CC-Stroke 35 mm

Application - Vehicle  
IVECO / DEUTZ



**01.05.009**

Oem. Ref. No.	Knorr No.
1261731	LK1300 - I77106
1173872	LK1314 - I87544
1173867	LK1303 - I78516
1173870	
1261822	
1173868	



**01.313** Crankcase



**RK.01.046.21** Repair Kit

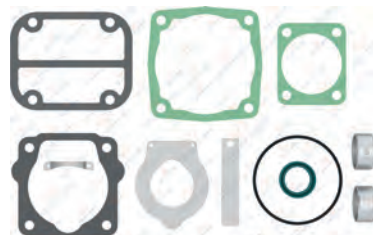

**RK.01.046** Repair Kit

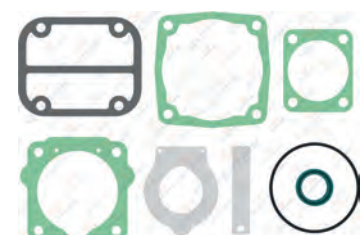

**RK.01.048** Complete Cylinder Head



Knorr No: STW63841

**RK.01.048.20** Complete Cylinder Head

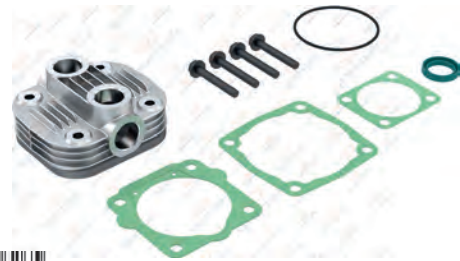

**RK.01.047.20** Valve Plate Kit

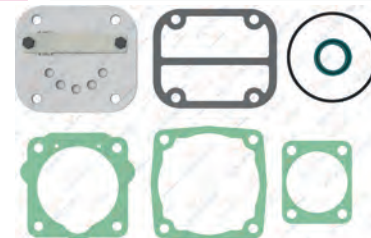

**RK.01.047** Valve Plate Kit

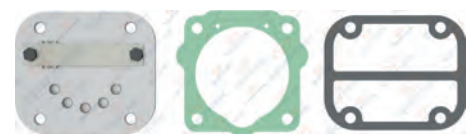

Knorr No: II3871F004

**RK.01.046.01** Repair Kit

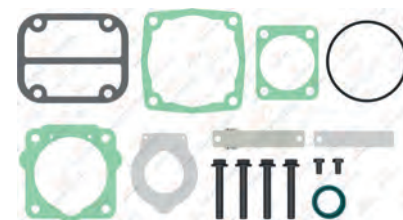

# IVECO - DEUTZ

## AIR COMPRESSOR AND REPAIR KIT

### 01.067 Cylinder Head



8 680437 013990

### 01.119 Valve Plate



Knorr No: II38717F004

8 680437 017387

### 01.098 Crankshaft



M18X1.5 - Right Hand



8 680437 014553

### 01.195 Bushing



34X30X16



8 680437 019411

### 01.194 Crankshaft Flange



8 680437 019398

### 01.003 Connecting Rod



8 680437 009672

### RK.01.081.00 Piston&Ring (Ø75,00 mm)

- RK.01.081.10 75,25 mm
- RK.01.081.20 75,50 mm
- RK.01.081.30 75,75 mm
- RK.01.081.40 76,00 mm



2,00x2,00x4,00



8 680437 059769

### 01.613.00 Piston (Ø75,00 mm)

- 01.613.10 75,25 mm
- 01.613.20 75,50 mm
- 01.613.30 75,75 mm
- 01.613.40 76,00 mm



2,00x2,00x4,00



8 680437 024682

### 01.134.00 Ring (Ø75,00 mm)

- 01.134.10 75,25 mm
- 01.134.20 75,50 mm
- 01.134.30 75,75 mm
- 01.134.40 76,00 mm



2,00x2,00x4,00



8 680437 018278

### RK.01.147 Cylinder Liner Set



8 680437 061229

### 01.056 Cylinder Liner



8 680437 013174

### 01.073 Cover



8 680437 014133

### RK.01.046.02 Repair Kit

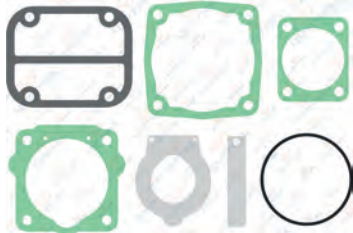

8 680437 072843

### 01.143 Nut



M18X1.5 - Right Hand



8 680437 018735

### 01.013 Bushing



34X30X16



8 680437 009993



## Single Cylinder Compressor Ø75 mm-155 CC-Stroke 35 mm

Application - Vehicle



**01.05.078**

**Knorr No.**

LK1517 - I84947  
LK1520 - I84950  
LK1521 - I84951  
LK1522 - I84952



**01.313**

Crankcase

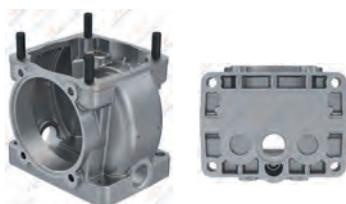

**RK.01.046.21**

Repair Kit

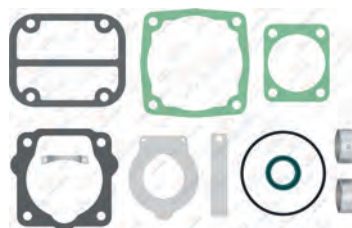

**RK.01.048** Complete Cylinder Head



**Knorr No:** STW63841

**RK.01.048.20**

Complete Cylinder Head

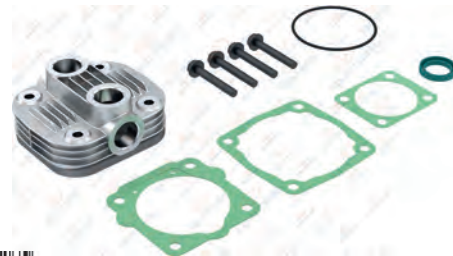

**RK.01.047.20**

Valve Plate Kit

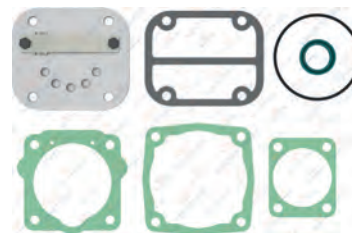

**RK.01.047**

Valve Plate Kit



**Knorr No:** II3871F004

**RK.01.046.01**

Repair Kit

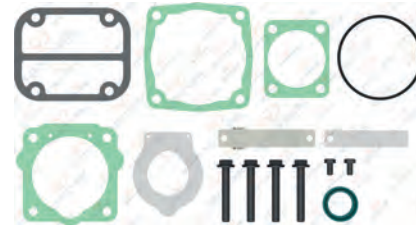

**RK.01.046**

Repair Kit

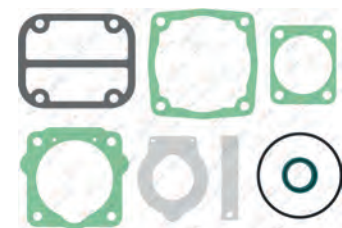

# IVECO - DEUTZ

## AIR COMPRESSOR AND REPAIR KIT

01.067

Cylinder Head



8 680437 013990

01.119

Valve Plate



8 680437 017387

Knorr No: II38717F004

01.089

Crankshaft



M18X1.5 - Right Hand



8 680437 014386

01.409

Pump Support



8 680437 022268

01.066

Crankshaft Flange

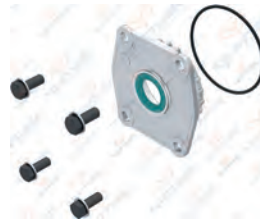

8 680437 013976

01.003

Connecting Rod



8 680437 009672

RK.01.073.00

Piston&Ring (Ø75,00 mm)

- RK.01.073.10 75,25 mm
- RK.01.073.20 75,50 mm
- RK.01.073.30 75,75 mm
- RK.01.073.40 76,00 mm



2,00x2,00x4,00



8 680437 059547

OEM No :1315279-1315280-1433932  
Knorr No: SEB22539-SEB22540

01.193.00

Piston (Ø75,00 mm)

- 01.193.10 75,25 mm
- 01.193.20 75,50 mm
- 01.193.30 75,75 mm
- 01.193.40 76,00 mm



2,00x2,00x4,00



8 680437 019336

01.134.00

Ring (Ø75,00 mm)

- 01.134.10 75,25 mm
- 01.134.20 75,50 mm
- 01.134.30 75,75 mm
- 01.134.40 76,00 mm



2,00x2,00x4,00



8 680437 018278

RK.01.045

Cylinder Liner Set



8 680437 059004

Knorr No: I77246

01.056

Cylinder Liner



8 680437 013174

01.013

Bushing



34X30X16



8 680437 009993

RK.01.046.02

Repair Kit

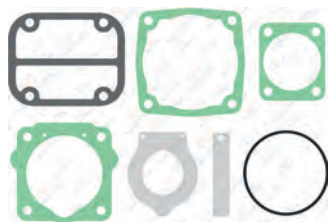

8 680437 072843

01.143

Nut



M18X1.5 - Right Hand



8 680437 018735

00.140

Roller Bearing



6305



8 680437 001577

IVECO  
DEUTZ

## Single Cylinder Compressor Ø88 mm-300 CC-Stroke 50 mm

Application - Vehicle



### 01.05.084

**Oem. Ref. No.**  
1178041  
1179099

**Wabco No.**  
LK1523 - I84953  
LK1534 - I92972  
LK1543 - I97495  
LK1545 - I98498  
LK1560 - II17393



**01.313** Crankcase

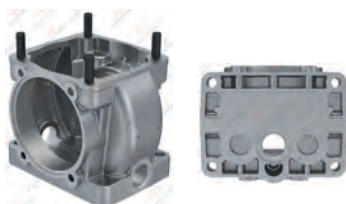

**RK.01.046.21** Repair Kit

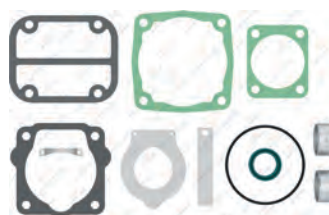

**RK.01.048** Complete Cylinder Head



Knorr No: STW63841

**RK.01.048.20** Complete Cylinder Head



**RK.01.047.20** Valve Plate Kit

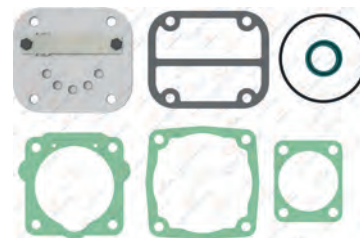

**RK.01.047** Valve Plate Kit



Knorr No: II3871F004

**RK.01.046.01** Repair Kit

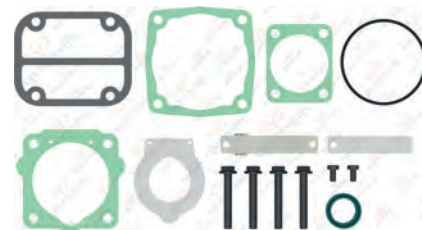

**RK.01.046** Repair Kit

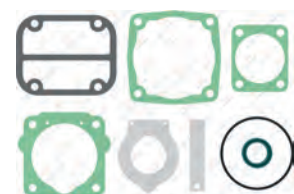



# IVECO - DEUTZ

## AIR COMPRESSOR AND REPAIR KIT

**01.067** Cylinder Head



8 680437 013990

**01.119** Valve Plate



Knorr No: II38717F004  
8 680437 017387

**01.089** Crankshaft



M18X1.5 - Right Hand  
8 680437 014386

**01.013** Bushing



34X30X16  
8 680437 009993

**01.066** Crankshaft Flange



8 680437 013976

**01.003** Connecting Rod



8 680437 009672

**RK.01.073.00** Piston&Ring (Ø75,00 mm)

RK.01.073.10	75,25 mm
RK.01.073.20	75,50 mm
RK.01.073.30	75,75 mm
RK.01.073.40	76,00 mm



2,00x2,00x4,00  
OEM No :1315279-1315280-1433932  
Knorr No: SEB22539-SEB22540  
8 680437 059547

**01.193.00** Piston (Ø75,00 mm)

01.193.10	75,25 mm
01.193.20	75,50 mm
01.193.30	75,75 mm
01.193.40	76,00 mm



2,00x2,00x4,00  
8 680437 019336

**01.134.00** Ring (Ø75,00 mm)

01.134.10	75,25 mm
01.134.20	75,50 mm
01.134.30	75,75 mm
01.134.40	76,00 mm



2,00x2,00x4,00  
8 680437 018278

**RK.01.045** Cylinder Liner Set



Knorr No: I77246  
8 680437 059004

**01.056** Cylinder Liner



8 680437 013174

**01.073** Cover



8 680437 014133

**RK.01.046.02** Repair Kit

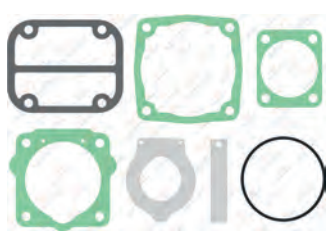

8 680437 072843

**01.143** Nut



M18X1.5 - Right Hand  
8 680437 018735

**00.140** Roller Bearing



6305  
8 680437 001577

# Single Cylinder Compressor Ø75 mm-155 CC-Stroke 35 mm

Application - Vehicle



**01.05.085**

Oem. Ref. No.  
11753309

Knorr No.  
LK1524-I85395



8 680437 012917



**01.314** Crankcase

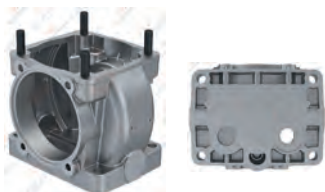

8 680437 020936

**RK.01.046.21** Repair Kit

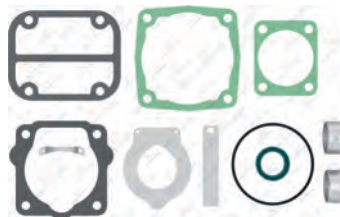

8 680437 120766

**RK.01.048** Complete Cylinder Head



8 680437 059042

Knorr No: STW63841

**RK.01.048.20** Complete Cylinder Head

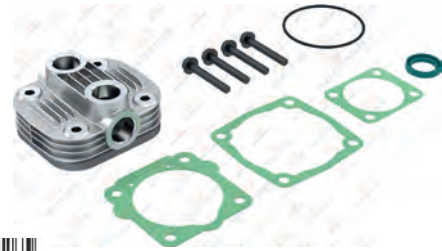

8 680437 106265

**RK.01.047.20** Valve Plate Kit

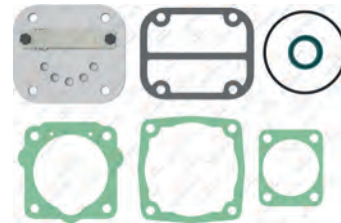

8 680437 112884

**RK.01.047** Valve Plate Kit



8 680437 078739

Knorr No: II3871F004

**RK.01.046.01** Repair Kit

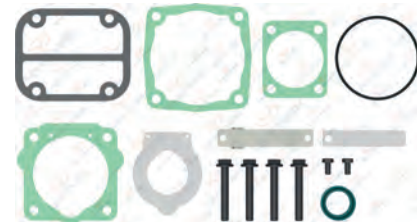

8 680437 059028

**RK.01.046** Repair Kit

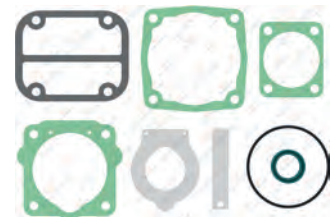

8 680437 078647

# IVECO - DEUTZ

## AIR COMPRESSOR AND REPAIR KIT

**01.067** Cylinder Head



8 680437 013990

**01.119** Valve Plate



Knorr No: II38717F004  
8 680437 017387

**01.089** Crankshaft



M18X1.5 - Right Hand  
8 680437 014386

**01.013** Bushing



34X30X16  
8 680437 009993

**01.066** Crankshaft Flange



8 680437 013976

**01.003** Connecting Rod



8 680437 009672

**RK.01.073.00** Piston&Ring (Ø75,00 mm)

RK.01.073.10	75,25 mm
RK.01.073.20	75,50 mm
RK.01.073.30	75,75 mm
RK.01.073.40	76,00 mm



2,00x2,00x4,00  
OEM No :1315279-1315280-1433932  
Knorr No: SEB22539-SEB22540  
8 680437 059547

**01.193.00** Piston (Ø75,00 mm)

01.193.10	75,25 mm
01.193.20	75,50 mm
01.193.30	75,75 mm
01.193.40	76,00 mm



2,00x2,00x4,00  
8 680437 019336

**01.134.00** Ring (Ø75,00 mm)

01.134.10	75,25 mm
01.134.20	75,50 mm
01.134.30	75,75 mm
01.134.40	76,00 mm



2,00x2,00x4,00  
8 680437 018278

**RK.01.045** Cylinder Liner Set



Knorr No: I77246  
8 680437 059004

**01.056** Cylinder Liner



8 680437 013174

**01.073** Cover



8 680437 014133

**RK.01.046.02** Repair Kit

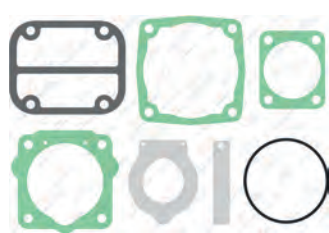

8 680437 072843

**01.143** Nut



M18X1.5 - Right Hand  
8 680437 018735

**00.140** Roller Bearing



6305  
8 680437 001577



# Single Cylinder Compressor Ø75 mm-155 CC-Stroke 35 mm

Application - Vehicle



**01.05.089**

**Knorr No.**  
LK1553-II17251  
LK1559-II17257



8 680437 012955



**01.085** Crankcase

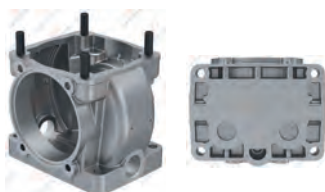

8 680437 014331

**RK.01.046.21** Repair Kit

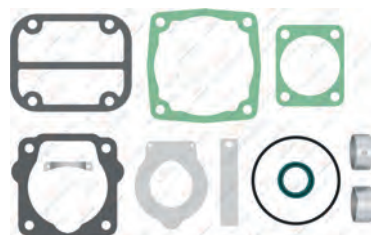

8 680437 120766

**RK.01.048** Complete Cylinder Head



8 680437 059042

**Knorr No:** STW63841

**RK.01.048.20** Complete Cylinder Head

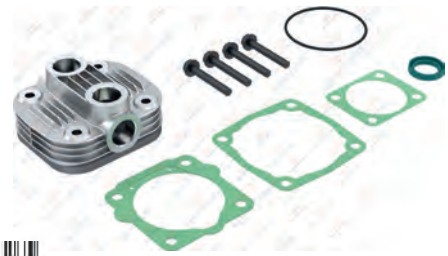

8 680437 106265

**RK.01.047.20** Valve Plate Kit

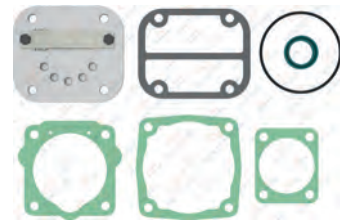

8 680437 112884

**RK.01.047** Valve Plate Kit



8 680437 078739

**Knorr No:** II3871F004

**RK.01.046.01** Repair Kit

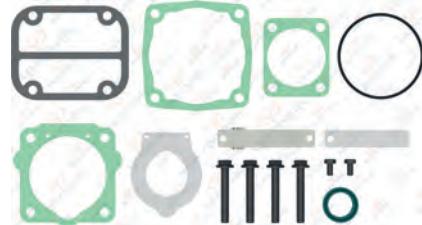

8 680437 059028

**Repair Kit**

**RK.01.046** Repair Kit

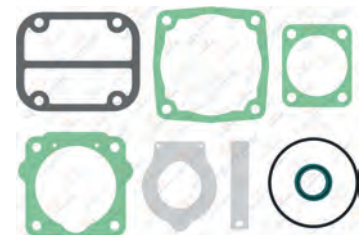

8 680437 078647

# IVECO - DEUTZ

## AIR COMPRESSOR AND REPAIR KIT

### 01.067 Cylinder Head



8 680437 013990

### 01.119 Valve Plate



Knorr No: II38717F004

8 680437 017387

### 01.089 Crankshaft



M18X1.5 - Right Hand



8 680437 014386

### 01.013 Bushing



34X30X16



8 680437 009993

### 01.066 Crankshaft Flange



8 680437 013976

### 01.003 Connecting Rod



8 680437 009672

### RK.01.073.00 Piston&Ring (Ø75,00 mm)

- RK.01.073.10 75,25 mm
- RK.01.073.20 75,50 mm
- RK.01.073.30 75,75 mm
- RK.01.073.40 76,00 mm



2,00x2,00x4,00



8 680437 059547

OEM No :1315279-1315280-1433932  
Knorr No: SEB22539-SEB22540

### 01.193.00 Piston (Ø75,00 mm)

- 01.193.10 75,25 mm
- 01.193.20 75,50 mm
- 01.193.30 75,75 mm
- 01.193.40 76,00 mm



2,00x2,00x4,00



8 680437 019336

### 01.134.00 Ring (Ø75,00 mm)

- 01.134.10 75,25 mm
- 01.134.20 75,50 mm
- 01.134.30 75,75 mm
- 01.134.40 76,00 mm



2,00x2,00x4,00



8 680437 018278

### RK.01.045 Cylinder Liner Set



8 680437 059004

Knorr No: I77246

### 01.056 Cylinder Liner



8 680437 013174

### 01.073 Cover



8 680437 014133

### RK.01.046.02 Repair Kit

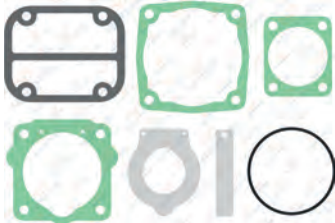

8 680437 072843

### RK.01.316 Repair Kit



8 680437 063759

### 00.140 Roller Bearing



6305



8 680437 001577

## Single Cylinder Compressor Ø90 mm-293 CC-Stroke 46 mm

Application - Vehicle  
IVECO / DEUTZ



**01.05.104**

Oem. Ref. No.

01173858  
42522655  
1173859  
502928808

Wabco.No.

4111436020  
4111438440  
4111438450



**01.1250**

Crankcase



**RK.01.224.02**

Repair Kit

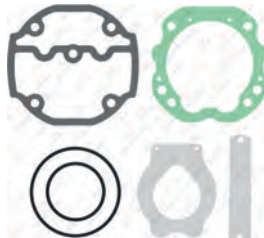

**RK.01.634**

Complete Cylinder Head



**RK.01.634.10**

Complete Cylinder Head



**RK.01.440**

Valve Plate Kit



Wabco No: 4111429242

**RK.01.224.01**

Repair Kit

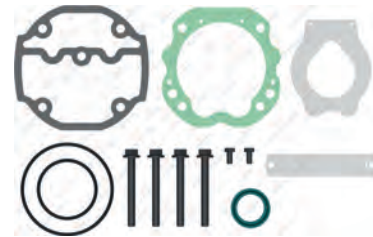

**RK.01.224**

Repair Kit

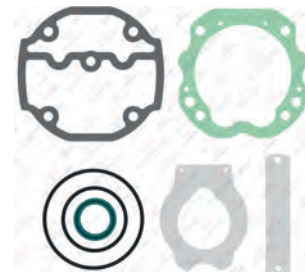



# IVECO - DEUTZ

## AIR COMPRESSOR AND REPAIR KIT

01.1256

Cylinder Head



8 680437 100201

01.1256.10

Cylinder Head



8 680437 100188

01.1253

Crankshaft



M18X1.5 - Right Hand



8 680437 108856

01.689

Valve Plate



8 680437 025542

01.234

Crankshaft Flange



8 680437 019916

01.1252

Connecting Rod



8 680437 073024

RK.01.635.00

Piston&Ring (Ø90,00 mm)

- RK.01.635.10 90,25 mm
- RK.01.635.20 90,50 mm
- RK.01.635.30 90,75 mm
- RK.01.635.40 91,00 mm



2.50x2,50x4,00



8 680437 074526

01.1255.00

Piston (Ø90,00 mm)

- 01.1255.10 90,25 mm
- 01.1255.20 90,50 mm
- 01.1255.30 90,75 mm
- 01.1255.40 91,00 mm



2.50x2,50x4,00



8 680437 077053

01.138.00

Ring (Ø90,00 mm)

- 01.138.10 90,25 mm
- 01.138.20 90,50 mm
- 01.138.30 90,75 mm
- 01.138.40 91,00 mm



2.50x2,50x4,00



8 680437 018469

01.073

Cover



8 680437 014133

01.437

Bushing



39X35X20



8 680437 022589

01.143

Nut



M18X1.5 - Right Hand



8 680437 018735

# Single Cylinder Compressor Ø90 mm-293 CC-Stroke 46 mm

Application - Vehicle  
IVECO / DEUTZ



## 01.05.105

Oem. Ref. No.	Wabco No.
01173860	4111438050
01173852	
01261657	



## 01.1250.10 Crankcase



## RK.01.224.02 Repair Kit



## RK.01.634

Complete Cylinder Head



## RK.01.634.10

Complete Cylinder Head



## RK.01.440

Valve Plate Kit



Wabco No: 4111429242

## RK.01.224.01

Repair Kit

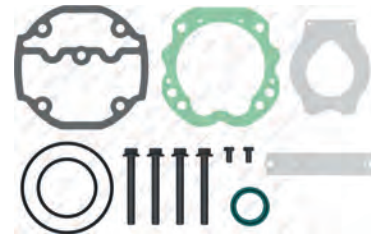

## RK.01.224

Repair Kit



# IVECO - DEUTZ

## AIR COMPRESSOR AND REPAIR KIT

01.1256

Cylinder Head



8 680437 100201

01.1256.10

Cylinder Head



8 680437 100188

01.1253

Crankshaft



M18X1.5 - Right Hand



8 680437 108856

01.689

Valve Plate



8 680437 025542

01.234

Crankshaft Flange



8 680437 019916

01.1252

Connecting Rod



8 680437 073024

RK.01.635.00

Piston&Ring (Ø90,00 mm)

- RK.01.635.10 90,25 mm
- RK.01.635.20 90,50 mm
- RK.01.635.30 90,75 mm
- RK.01.635.40 91,00 mm



2.50x2,50x4,00



8 680437 074526

01.1255.00

Piston (Ø90,00 mm)

- 01.1255.10 90,25 mm
- 01.1255.20 90,50 mm
- 01.1255.30 90,75 mm
- 01.1255.40 91,00 mm



2.50x2,50x4,00



8 680437 077053

01.138.00

Ring (Ø90,00 mm)

- 01.138.10 90,25 mm
- 01.138.20 90,50 mm
- 01.138.30 90,75 mm
- 01.138.40 91,00 mm



2.50x2,50x4,00



8 680437 018469

01.656

Bushing



34X30X20



8 680437 025221

01.437

Bushing



39X35X20



8 680437 022589

01.143

Nut



M18X1.5 - Right Hand



8 680437 018735



# Single Cylinder Compressor Ø90 mm-293 CC-Stroke 46 mm

Application - Vehicle  
IVECO



## 01.05.110

Oem. Ref. No.	Wabco No.
1505916	4111438830
1173720	4111436820
5003318126	4111438810
0364486	4111438820
0269929	



## 01.1250 Crankcase



## RK.01.183 Repair Kit



## RK.01.019 Complete Cylinder Head



## RK.01.013 Valve Plate Kit



## RK.01.636.01 Repair Kit

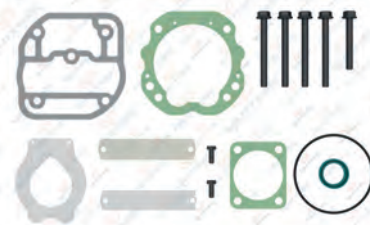

## RK.01.636 Repair Kit

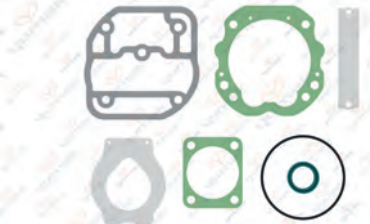

## RK.01.636.02 Repair Kit

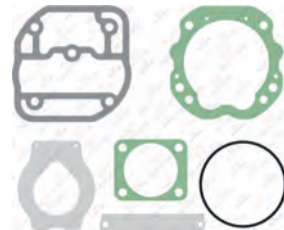

# IVECO - DEUTZ

## AIR COMPRESSOR AND REPAIR KIT

**01.070** Cylinder Head



8 680437 014072

**01.122** Valve Plate



8 680437 017783

**01.1253** Crankshaft



M18X1.5 - Right Hand



8 680437 108856

**01.234** Crankshaft Flange



8 680437 019916

**01.241** Connecting Rod Bearing Kit



8 680437 019985

**01.1252** Connecting Rod



8 680437 073024

**RK.01.635.00** Piston&Ring (Ø90,00 mm)

- RK.01.635.10 90,25 mm
- RK.01.635.20 90,50 mm
- RK.01.635.30 90,75 mm
- RK.01.635.40 91,00 mm



2.50x2,50x4,00



8 680437 074526

**01.1255.00** Piston (Ø90,00 mm)

- 01.1255.10 90,25 mm
- 01.1255.20 90,50 mm
- 01.1255.30 90,75 mm
- 01.1255.40 91,00 mm



2.50x2,50x4,00



8 680437 077053

**01.138.00** Ring (Ø90,00 mm)

- 01.138.10 90,25 mm
- 01.138.20 90,50 mm
- 01.138.30 90,75 mm
- 01.138.40 91,00 mm



2.50x2,50x4,00



8 680437 018469

**01.073** Cover



8 680437 014133

**01.656** Bushing



34X30X20



8 680437 025221

**01.437** Bushing



39X35X20



8 680437 022589

**01.143** Nut



M18X1.5 - Right Hand



8 680437 018735

## Single Cylinder Compressor Ø90 mm-229 CC-Stroke 36 mm

Application - Vehicle  
IVECO



**01.05.114**

Oem. Ref. No.  
01173350

Wabco No.  
4111428050



8 680437 106746



**01.1250.10**

Crankcase



8 680437 102793

**RK.01.634**

Complete Cylinder Head



8 680437 077282

**RK.01.634.10**

Complete Cylinder Head



8 680437 106326

**RK.01.440**

Valve Plate Kit



8 680437 065241

Wabco No: 4111429242

**RK.01.224.01**

Repair Kit

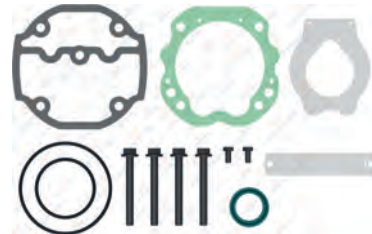

8 680437 062387

**RK.01.224**

Repair Kit



8 680437 062370

**RK.01.224.02**

Repair Kit

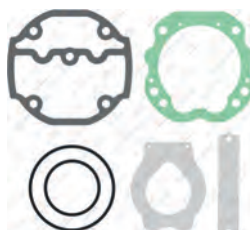

8 680437 073307



# IVECO - DEUTZ

## AIR COMPRESSOR AND REPAIR KIT

**01.1256**

Cylinder Head



8 680437 100201

**01.1256.10**

Cylinder Head



8 680437 100188

**01.1254**

Crankshaft



M18X1.5 - Right Hand



8 680437 076759

**01.689**

Valve Plate



8 680437 025542

**01.234**

Crankshaft Flange



8 680437 019916

**01.230**

Connecting Rod



8 680437 072935

**RK.01.635.00**

Piston&Ring (Ø90,00 mm)

- RK.01.635.10 90,25 mm
- RK.01.635.20 90,50 mm
- RK.01.635.30 90,75 mm
- RK.01.635.40 91,00 mm



2.50x2,50x4,00



8 680437 074526

**01.1255.00**

Piston (Ø90,00 mm)

- 01.1255.10 90,25 mm
- 01.1255.20 90,50 mm
- 01.1255.30 90,75 mm
- 01.1255.40 91,00 mm



2.50x2,50x4,00



8 680437 077053

**01.138.00**

Ring (Ø90,00 mm)

- 01.138.10 90,25 mm
- 01.138.20 90,50 mm
- 01.138.30 90,75 mm
- 01.138.40 91,00 mm



2.50x2,50x4,00



8 680437 018469

**01.073**

Cover



8 680437 014133

**01.437**

Bushing



39X35X20



8 680437 022589

**01.143**

Nut



M18X1.5 - Right Hand



8 680437 018735

# Single Cylinder Compressor Ø90 mm-229 CC-Stroke 36 mm

Application - Vehicle  
IVECO



**01.05.120**

Oem. Ref. No.  
0041318601  
01173854

Wabco No.  
4111426820  
4111428800



**01.1250**

Crankcase



**RK.01.183**

Repair Kit



**RK.01.019**

Complete Cylinder Head



**RK.01.013**

Valve Plate Kit



**RK.01.636.01**

Repair Kit

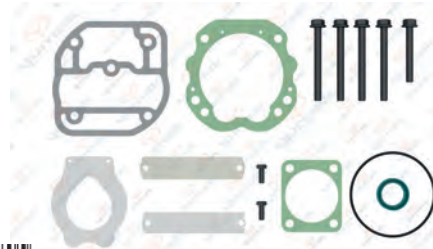

**RK.01.636**

Repair Kit

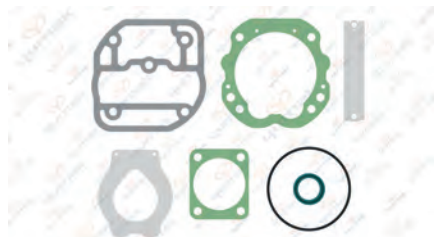

**RK.01.636.02**

Repair Kit

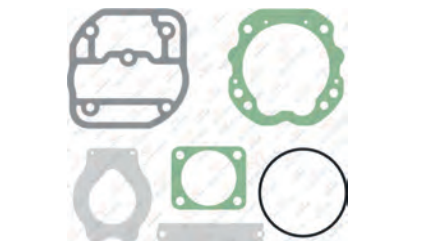

# IVECO - DEUTZ

## AIR COMPRESSOR AND REPAIR KIT

**01.070** Cylinder Head



8 680437 014072

**01.122** Valve Plate



8 680437 017783

**01.1254** Crankshaft



M18X1.5 - Right Hand



8 680437 076759

**01.234** Crankshaft Flange



8 680437 019916

**01.241** Connecting Rod Bearing Kit



8 680437 019985

**01.230.10** Connecting Rod



8 680437 072522

**RK.01.635.00** Piston&Ring (Ø90,00 mm)

- RK.01.635.10 90,25 mm
- RK.01.635.20 90,50 mm
- RK.01.635.30 90,75 mm
- RK.01.635.40 91,00 mm



2.50x2,50x4,00



8 680437 074526

**01.1255.00** Piston (Ø90,00 mm)

- 01.1255.10 90,25 mm
- 01.1255.20 90,50 mm
- 01.1255.30 90,75 mm
- 01.1255.40 91,00 mm



2.50x2,50x4,00



8 680437 077053

**01.138.00** Ring (Ø90,00 mm)

- 01.138.10 90,25 mm
- 01.138.20 90,50 mm
- 01.138.30 90,75 mm
- 01.138.40 91,00 mm



2.50x2,50x4,00



8 680437 018469

**01.073** Cover



8 680437 014133

**01.1679** Cover



8 680437 009894

**01.143** Nut



M18X1.5 - Right Hand



8 680437 018735

**01.656** Bushing



34X30X20



8 680437 025221

**01.437** Bushing



39X35X20



8 680437 022589



# Single Cylinder Compressor Ø88 mm-300 CC-Stroke 50 mm

Application - Vehicle



**01.04.107**

Oem. Ref. No.  
4220867

Knorr No.  
LK3947  
K040432N00



**01.309**

Crankcase



**RK.01.115.03**

Repair Kit

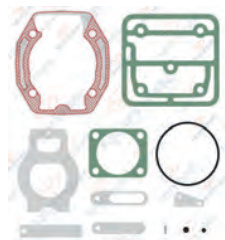

**RK.01.497** Complete Cylinder Head



**RK.01.497.20**

Complete Cylinder Head



**RK.01.113.01**

Valve Plate Kit

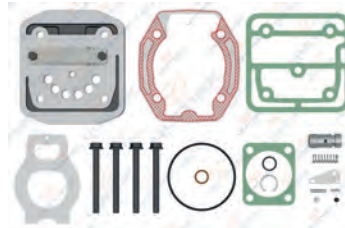

**RK.01.113**

Valve Plate Kit



**RK.01.115**

Repair Kit

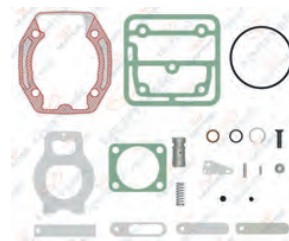

**RK.01.029**

Repair Kit



# IVECO - DEUTZ

## AIR COMPRESSOR AND REPAIR KIT

**01.995** Cylinder Head



8 680437 029403

**01.355** Valve Plate



8 680437 021476

Knorr No: II14777004

**01.1308** Crankshaft



M20X1.5 - Right Hand



8 680437 075912

**01.1287** Pump Support



8 680437 113287

**01.1259** Crankshaft Flange



8 680437 078234

**01.003** Connecting Rod



8 680437 009672

**RK.01.034.00** Piston&Ring (Ø88,00 mm)

- RK.01.034.10 88,25 mm
- RK.01.034.20 88,50 mm
- RK.01.034.30 88,75 mm
- RK.01.034.40 89,00 mm



2.50x2,50x4,00



8 680437 058816

Knorr No: I81169004 - SEB22555

**01.110.00** Piston (Ø88,00 mm)

- 01.110.10 88,25 mm
- 01.110.20 88,50 mm
- 01.110.30 88,75 mm
- 01.110.40 89,00 mm



2.50x2,50x4,00



8 680437 015994

**01.136.00** Ring (Ø88,00 mm)

- 01.136.10 88,25 mm
- 01.136.20 88,50 mm
- 01.136.30 88,75 mm
- 01.136.40 89,00 mm



2.50x2,50x4,00



8 680437 018384

OEM No : 1409318  
Knorr No: II39526F0061

**RK.01.114** Cylinder Liner Set



8 680437 060437

Knorr No: K000998

**01.305** Cylinder Liner



8 680437 020806

**01.144** Nut



M20X1.5 - Right Hand



8 680437 018742

**RK.01.322** Repair Kit



8 680437 063865

**RK.01.322.01** Repair Kit



8 680437 124047

**RK.01.322.02** Repair Kit



8 680437 124054

# Single Cylinder Compressor Ø88 mm-300 CC-Stroke 50 mm

Application - Vehicle



**01.04.108**

Oem. Ref. No.  
4222619

Knorr No.  
LK3959-K000741



8 680437 011781



**01.309**

Crankcase



8 680437 020875

**RK.01.115.03**

Repair Kit

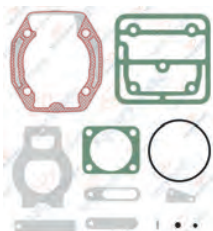

8 680437 080770

**RK.01.497** Complete Cylinder Head



8 680437 065890

**RK.01.497.20**

Complete Cylinder Head



8 680437 105749

**RK.01.113.01**

Valve Plate Kit

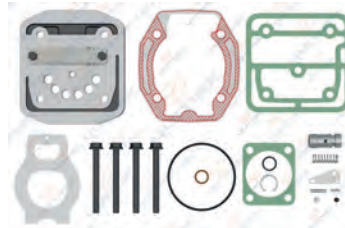

8 680437 081005

**RK.01.113**

Valve Plate Kit



8 680437 060420

**RK.01.115**

Repair Kit

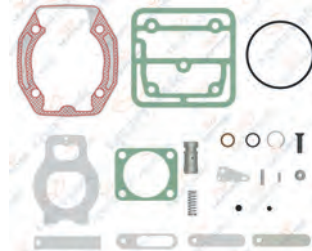

8 680437 060444

**RK.01.029**

Repair Kit



8 680437 058700



# IVECO - DEUTZ

## AIR COMPRESSOR AND REPAIR KIT

**01.995** Cylinder Head



8 680437 029403

**01.355** Valve Plate



Knorr No: II14777004  
8 680437 021476

**01.1308** Crankshaft



M20X1.5 - Right Hand  
8 680437 075912

**01.1287** Pump Support



8 680437 113287

**01.1259** Crankshaft Flange



8 680437 078234

**01.003** Connecting Rod



8 680437 009672

**RK.01.034.00** Piston&Ring (Ø88,00 mm)

RK.01.034.10	88,25 mm
RK.01.034.20	88,50 mm
RK.01.034.30	88,75 mm
RK.01.034.40	89,00 mm



2.50x2,50x4,00  
Knorr No: I81169004 - SEB22555  
8 680437 058816

**01.110.00** Piston (Ø88,00 mm)

01.110.10	88,25 mm
01.110.20	88,50 mm
01.110.30	88,75 mm
01.110.40	89,00 mm



2.50x2,50x4,00  
8 680437 015994

**01.136.00** Ring (Ø88,00 mm)

01.136.10	88,25 mm
01.136.20	88,50 mm
01.136.30	88,75 mm
01.136.40	89,00 mm



2.50x2,50x4,00  
OEM No : 1409318  
Knorr No: II39526F0061  
8 680437 018384

**RK.01.114** Cylinder Liner Set



Knorr No: K000998  
8 680437 060437

**01.305** Cylinder Liner



8 680437 020806

**01.144** Nut



M20X1.5 - Right Hand  
8 680437 018742

**RK.01.322** Repair Kit



8 680437 063865

**01.212** Bushing



34X30X16  
8 680437 019640

**01.013** Bushing



34X30X16  
8 680437 009993

IVECO  
DEUTZ

## Twin Cylinder Compressor Ø92 mm-720 CC-Stroke 54 mm

Application - Vehicle  
DEUTZ



01.04.144



01.04.143

### 01.04.144 - 01.04.143

**Oem. Ref. No.**

7421098922  
7485003045  
21101027  
04905532  
04905533

**Knorr No.**

LK4944-K017527000  
LK4954-K017528



**01.1385**

**Crankcase**



**RK.01.264.06**

**Repair Kit**

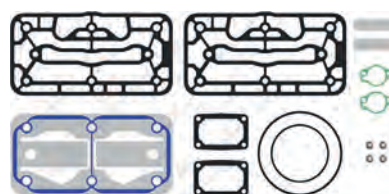

**RK.01.428**

**Repair Kit**

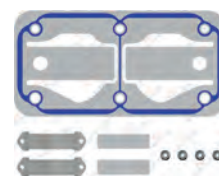

**RK.01.670**

**Complete Cylinder Head**



**RK.01.670.01**

**Complete Cylinder Head**



**RK.01.568**

**Valve Plate Kit**

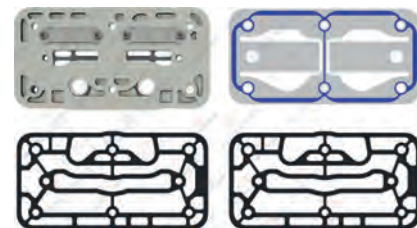

**RK.01.264.01**

**Repair Kit**

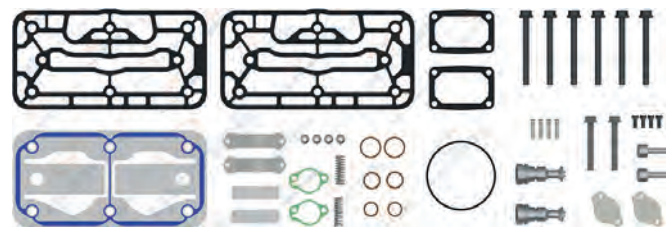

**RK.01.264**

**Repair Kit**

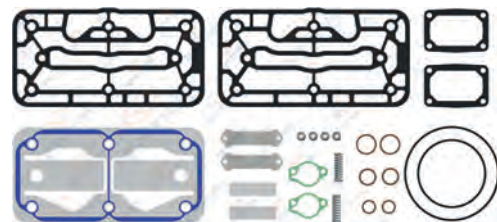

# IVECO - DEUTZ

## AIR COMPRESSOR AND REPAIR KIT

01.1444

Cylinder Head



8 680437 074298

01.1161

Cooling Plate



8 680437 017059

01.1337

Crankshaft



M20X1.5 - Right Hand



8 680437 074106

01.1162

Valve Plate



8 680437 017066

01.1206

Crankshaft Flange



8 680437 017622

01.1056

Connecting Rod



8 680437 015345

RK.01.318.00

Piston&Ring (Ø92,00 mm)

- RK.01.318.10 92,25 mm
- RK.01.318.20 92,50 mm
- RK.01.318.30 92,75 mm
- RK.01.318.40 93,00 mm



2.50x2,50x4,00



8 680437 063773

Knorr No: K012079 - K006026

01.862.00

Piston (Ø92,00 mm)

- 01.862.10 92,25 mm
- 01.862.20 92,50 mm
- 01.862.30 92,75 mm
- 01.862.40 93,00 mm



2.50x2,50x4,00



8 680437 027584

01.942.00

Ring (Ø92,00 mm)

- 01.942.10 92,25 mm
- 01.942.20 92,50 mm
- 01.942.30 92,75 mm
- 01.942.40 93,00 mm



2.50x2,50x4,00



8 680437 028666

01.374

Cover



8 680437 077022

01.292

Bushing



42X38X25



8 680437 073871

51.01.008

Safety Valve



8 680437 073567

RK.01.558

Repair Kit

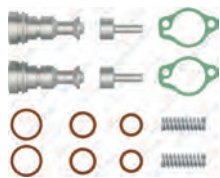

8 680437 066613

Knorr No: K034874K50

RK.01.802

Connecting Rod & Piston



8 680437 114550



# Single Cylinder Compressor Ø80 mm-225 CC-Stroke 45 mm

Application - Vehicle  
DEUTZ

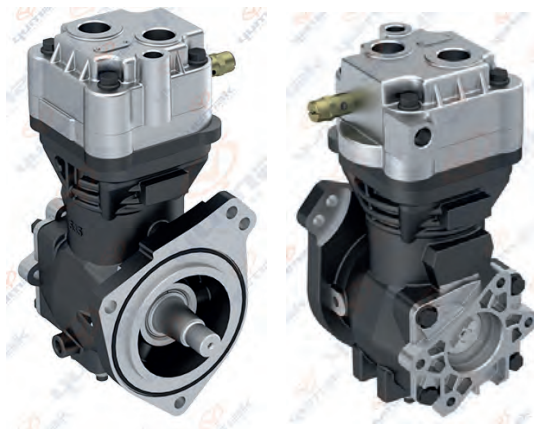

**01.04.179**

Oem. Ref. No.  
04905010

Knorr No.  
LK3869  
K016932



**01.1672** Crankcase



**RK.01.159.07** Repair Kit

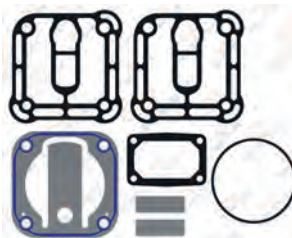

Knorr No: K012252

**RK.01.159.13** Repair Kit

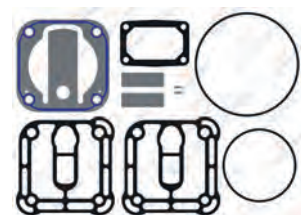

**RK.01.755**

Complete Cylinder Head



**RK.01.755.01**

Cylinder Head



Knorr No: K149867K50

**RK.01.756.01**

Valve Plate Kit



Knorr No: K149864K50

**RK.01.756**

Valve Plate Kit



**RK.01.159.33**

Repair Kit

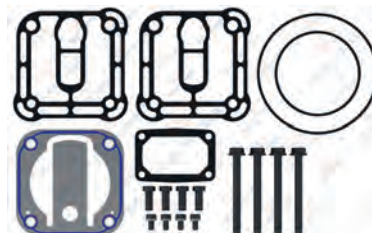

Knorr No: K149866K50

# IVECO - DEUTZ

## AIR COMPRESSOR AND REPAIR KIT

### 01.1674 Cylinder Head



Knorr No: K012234  
8 680437 127871

### 01.1675 Cooling Plate



8 680437 127888

### 01.1673 Crankshaft



M20X1.5 - Right Hand  
8 680437 127864

### 01.1676 Valve Plate



Knorr No: SEB01938004  
8 680437 127895

### 01.1206 Crankshaft Flange



8 680437 017622

### 01.587 Connecting Rod



8 680437 024323

### RK.01.601.00 Piston&Ring (Ø80,00 mm)

- RK.01.601.10 80,25 mm
- RK.01.601.20 80,50 mm
- RK.01.601.30 80,75 mm
- RK.01.601.40 81,00 mm



2.50x2,50x4,00  
Knorr No: SEB22517  
8 680437 067054

### 01.1201.00 Piston (Ø80,00 mm)

- 01.1201.10 80,25 mm
- 01.1201.20 80,50 mm
- 01.1201.30 80,75 mm
- 01.1201.40 81,00 mm

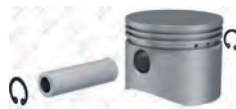

2.50x2,50x4,00  
8 680437 017530

### 01.1226.00 Ring (Ø80,00 mm)

- 01.1226.10 80,25 mm
- 01.1226.20 80,50 mm
- 01.1226.30 80,75 mm
- 01.1226.40 81,00 mm



2.50x2,50x4,00  
8 680437 017882

### RK.01.601.05 Piston&Ring Full Kit

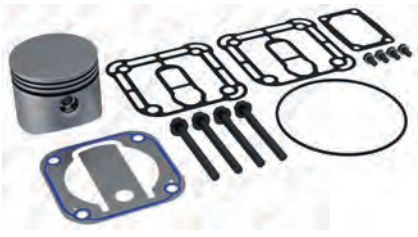

Knorr No: K149865K50  
8 680437 127901

### 01.374 Cover



8 680437 077022

### 01.144 Nut



M20X1.5 - Right Hand  
8 680437 018742

### 51.01.008 Safety Valve



8 680437 073567

### 01.1230 Bushing



8 680437 017981

## Single Cylinder Compressor Ø80 mm-225 CC-Stroke 45 mm

Application - Vehicle  
DEUTZ  
OTOKAR SULTAN 125



**01.04.184**

Oem. Ref. No.  
04298359

Knorr No.  
LK3866  
K018385



**01.1672** Crankcase



**RK.01.159.21** Repair Kit

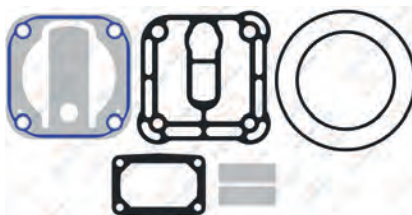

**RK.01.757** Complete Cylinder Head



**RK.01.757.01** Cylinder Head

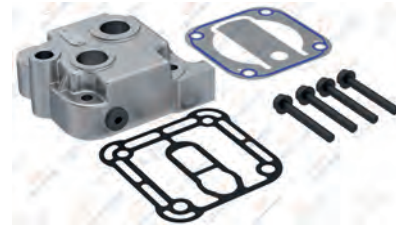

Knorr No: K151008K50

**RK.01.756.03** Valve Plate Kit

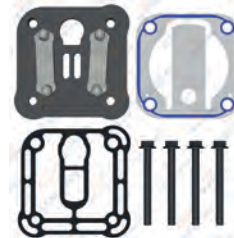

Knorr No: K149864K50\*

**RK.01.756.02** Valve Plate Kit

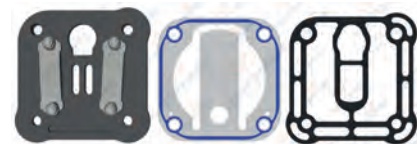

**RK.01.159.34** Repair Kit

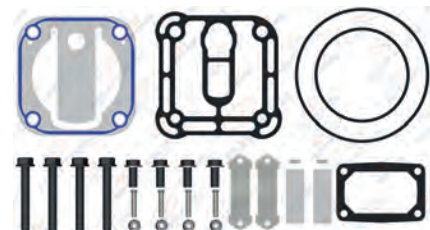

**RK.01.159.15** Repair Kit

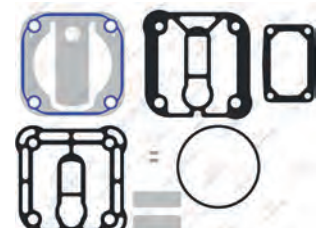



# IVECO - DEUTZ

## AIR COMPRESSOR AND REPAIR KIT

**01.1674** Cylinder Head



Knorr No: K012234  
8 680437 127871

**01.1676** Cooling Plate



Knorr No: SEB01938004  
8 680437 127895

**01.1673** Crankshaft



M20X1.5 - Right Hand  
8 680437 127864

**01.1332** Bushing



42X38X22

8 680437 009924

**01.1677** Crankshaft Flange



8 680437 128205

**01.587** Connecting Rod



8 680437 024323

**RK.01.601.00** Piston&Ring (Ø80,00 mm)

- RK.01.601.10 80,25 mm
- RK.01.601.20 80,50 mm
- RK.01.601.30 80,75 mm
- RK.01.601.40 81,00 mm



2.50x2,50x4,00

Knorr No: SEB22517  
8 680437 067054

**01.1201.00** Piston (Ø80,00 mm)

- 01.1201.10 80,25 mm
- 01.1201.20 80,50 mm
- 01.1201.30 80,75 mm
- 01.1201.40 81,00 mm

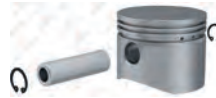

2.50x2,50x4,00

8 680437 017530

**01.1226.00** Ring (Ø80,00 mm)

- 01.1226.10 80,25 mm
- 01.1226.20 80,50 mm
- 01.1226.30 80,75 mm
- 01.1226.40 81,00 mm



2.50x2,50x4,00

8 680437 017882

**RK.01.601.05** Piston&Ring Full Kit

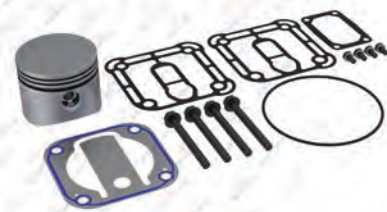

Knorr No: K149865K50  
8 680437 127901

**01.374** Cover



8 680437 077022

**01.144** Nut



M20X1.5 - Right Hand  
8 680437 018742

IVECO  
DEUTZ

# Single Cylinder Compressor Ø92 mm-359 CC-Stroke 54 mm

Application - Vehicle  
DEUTZ



**01.04.192**

Oem. Ref. No.  
04903511

Knorr No.  
LP3955  
K003084



**01.1714**

Crankcase



**RK.01.614.10**

Repair Kit



Knorr No: K011818

**RK.01.766**

Complete Cylinder Head



Knorr No: K149863K50

**RK.01.766.01**

Cylinder Head



Knorr No: K137935K50

**RK.01.611.01**

Valve Plate Kit

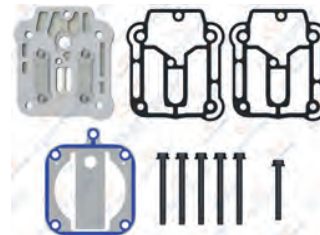

Knorr No: K137938

**RK.01.611**

Valve Plate Kit

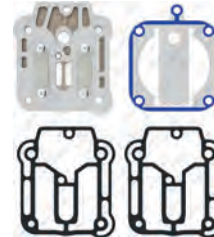

**RK.01.614.11**

Repair Kit

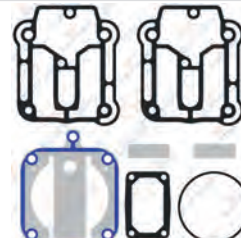

Knorr No: K011815

**RK.01.614.09**

Repair Kit

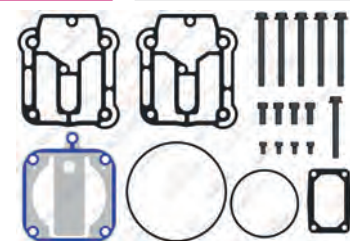

Knorr No: K137936

# IVECO - DEUTZ

## AIR COMPRESSOR AND REPAIR KIT

01.1715

Cylinder Head



Knorr No: K011809

01.1212

Cooling Plate



01.1779

Crankshaft



M20X1.5 - Right Hand



01.1213

Valve Plate

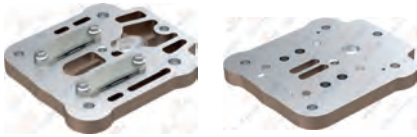

Knorr No: K011811

01.1677

Crankshaft Flange



01.1101

Connecting Rod



RK.01.318.00

Piston&Ring (Ø92,00 mm)

- RK.01.318.10 92,25 mm
- RK.01.318.20 92,50 mm
- RK.01.318.30 92,75 mm
- RK.01.318.40 93,00 mm



2.50x2,50x4,00



Knorr No: K012079 - K006026

01.862.00

Piston (Ø92,00 mm)

- 01.862.10 92,25 mm
- 01.862.20 92,50 mm
- 01.862.30 92,75 mm
- 01.862.40 93,00 mm



2.50x2,50x4,00



01.942.00

Ring (Ø92,00 mm)

- 01.942.10 92,25 mm
- 01.942.20 92,50 mm
- 01.942.30 92,75 mm
- 01.942.40 93,00 mm



2.50x2,50x4,00



RK.01.614.08

Repair Kit



Knorr No: K137939

RK.01.614.12

Repair Kit

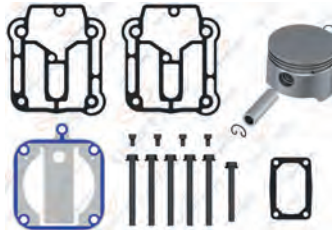

Knorr No: K099418

01.144

Nut



M20X1.5 - Right Hand





# Single Cylinder Compressor Ø92 mm-359 CC-Stroke 54 mm

Application - Vehicle  
DEUTZ



**01.04.209**

Oem. Ref. No.  
04909170

Knorr No.  
LK8905  
K040690N00



**01.1714** Crankcase



**RK.01.614.10** Repair Kit



Knorr No: K011818

**RK.01.614.09** Repair Kit

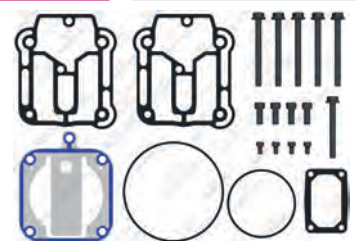

Knorr No: K137936

**RK.01.766**

Complete Cylinder Head



Knorr No: K149863K50

**RK.01.766.01**

Cylinder Head



Knorr No: K137935K50

**RK.01.611.01**

Valve Plate Kit

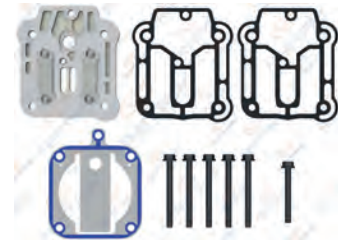

Knorr No: K137938

**RK.01.611**

Valve Plate Kit

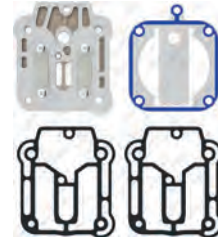

**RK.01.614.11**

Repair Kit

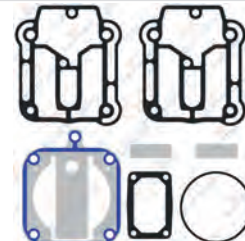

Knorr No: K011815

# IVECO - DEUTZ

## AIR COMPRESSOR AND REPAIR KIT

01.1715

Cylinder Head



Knorr No: K011809

01.1212

Cooling Plate



01.1779

Crankshaft



M20X1.5 - Right Hand



01.1213

Valve Plate



Knorr No: K011811

01.1206

Crankshaft Flange



01.1101

Connecting Rod



RK.01.318.00

Piston&Ring (Ø92,00 mm)

- RK.01.318.10 92,25 mm
- RK.01.318.20 92,50 mm
- RK.01.318.30 92,75 mm
- RK.01.318.40 93,00 mm



2.50x2,50x4,00



Knorr No: K012079 - K006026

01.862.00

Piston (Ø92,00 mm)

- 01.862.10 92,25 mm
- 01.862.20 92,50 mm
- 01.862.30 92,75 mm
- 01.862.40 93,00 mm



2.50x2,50x4,00



01.942.00

Ring (Ø92,00 mm)

- 01.942.10 92,25 mm
- 01.942.20 92,50 mm
- 01.942.30 92,75 mm
- 01.942.40 93,00 mm



2.50x2,50x4,00



RK.01.614.08

Repair Kit

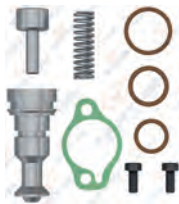

Knorr No: K137939

RK.01.614.12

Repair Kit

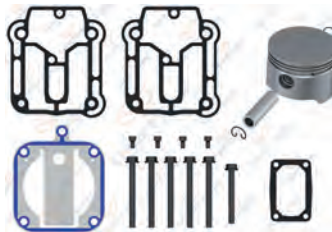

Knorr No: K099418

01.144

Nut



M20X1.5 - Right Hand



**RK.01.229**

Repair Kit



**RK.01.229.01**

Repair Kit

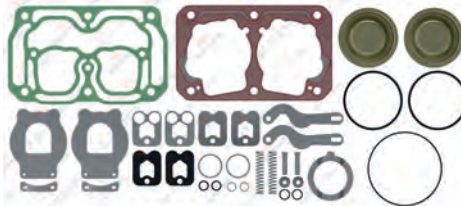

**RK.01.358**

Repair Kit

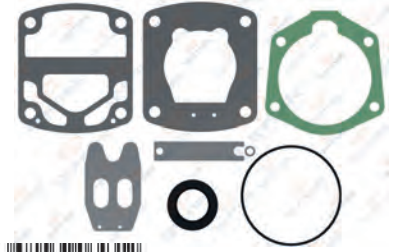

**RK.01.358.01**

Repair Kit

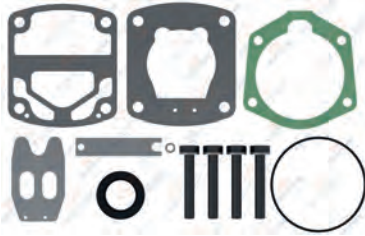

**RK.01.358.02**

Repair Kit



**RK.01.358.05**

Repair Kit

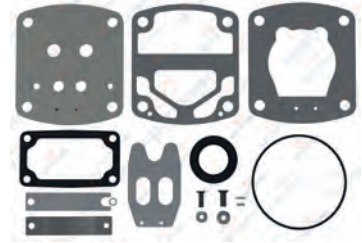

**RK.01.358.20**

Repair Kit

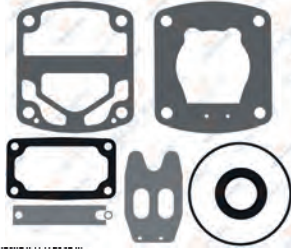

**RK.01.152**

Repair Kit

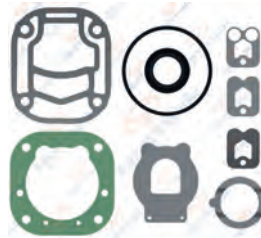

For 9111455600

**RK.01.152.01**

Repair Kit

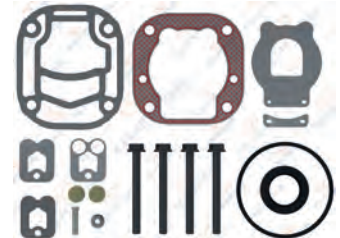

For 9111455600

**RK.01.152.02**

Repair Kit



For 9111455600



# IVECO - DEUTZ

AIR COMPRESSOR AND REPAIR KIT

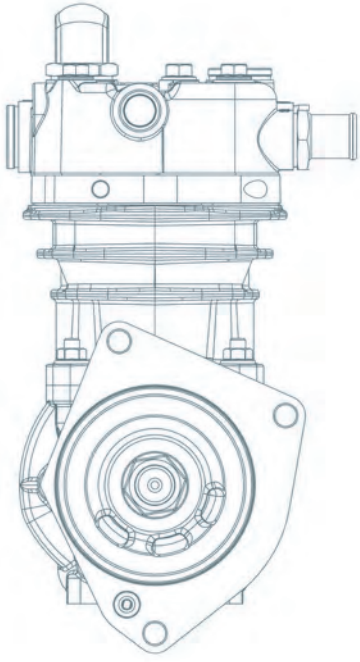
# FORD BMC CUMMINS VOLKSWAGEN

**HAVA KOMPRESÖRLERİ  
ve TAMİR TAKIMLARI**

AIR COMPRESSORS AND REPAIR KITS

# FORD BMC

FORD-BMC  
CUMMINS-VOLKSWAGEN





## Twin Cylinder Compressor Ø86 mm-630 CC-Stroke 54 mm

Application - Vehicle  
FORD 3235 - 1835  
CARGO

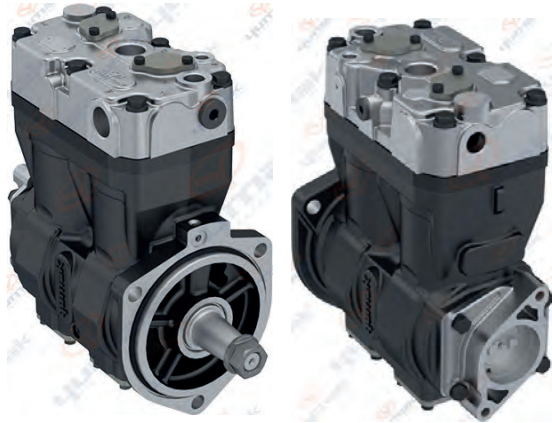

**01.04.157**

Oem. Ref. No.  
7C46 2875 AD N  
7C462875ADN

Knorr No.  
LK4958-  
K094132N00



8 680437 079743



**01.1400** Crankcase



8 680437 075109

**RK.01.499.20** Complete Cylinder Head



8 680437 074984

**RK.01.339.20** Valve Plate Kit

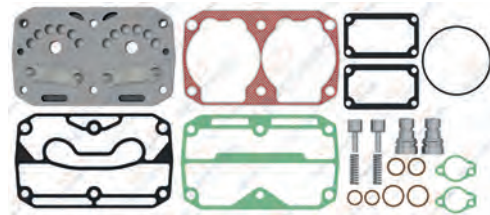

8 680437 112594

**RK.01.339** Valve Plate Kit

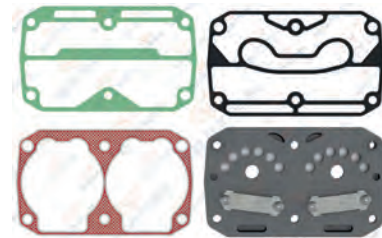

8 680437 064039

**RK.01.136.01** Repair Kit

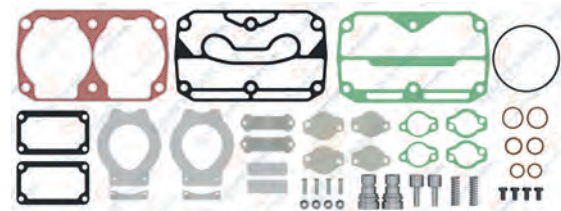

Knorr No: SEB22549

**RK.01.136** Repair Kit

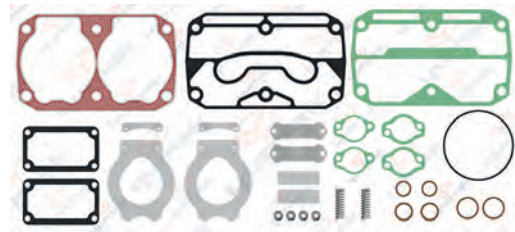

8 680437 060956

**RK.01.136.10** Repair Kit

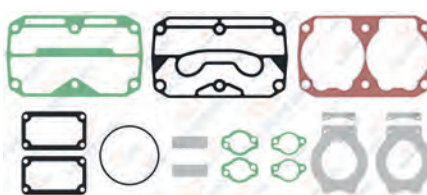

8 680437 120667

**RK.01.136.11** Repair Kit



8 680437 120674

# FORD - BMC

## AIR COMPRESSOR AND REPAIR KIT

**01.1318** Cylinder Head



8 680437 101789

**01.964** Valve Plate



8 680437 028987

**01.1030** Crankshaft



M18X1.5 - Right Hand



8 680437 014980

**01.208** Bushing



44X40X20



8 680437 019602

**01.1454** Crankshaft Flange



8 680437 084679

**01.587** Connecting Rod



8 680437 024323

**RK.01.272.00** Piston&Ring (Ø86,00 mm)

- RK.01.272.10 86,25 mm
- RK.01.272.20 86,50 mm
- RK.01.272.30 86,75 mm
- RK.01.272.40 87,00 mm



2.00x2,00x3,00



Knorr No: SEB22547 - SEB22548

**01.868.00** Piston (Ø86,00 mm)

- 01.868.10 86,25 mm
- 01.868.20 86,50 mm
- 01.868.30 86,75 mm
- 01.868.40 87,00 mm



2.00x2,00x3,00



8 680437 027676

**01.869.00** Ring (Ø86,00 mm)

- 01.869.10 86,25 mm
- 01.869.20 86,50 mm
- 01.869.30 86,75 mm
- 01.869.40 87,00 mm



2.00x2,00x3,00



8 680437 027737

**RK.01.184** Repair Kit



8 680437 061885

**01.026** Bushing



44X40X26



8 680437 071679

**01.752** Nut



M18X1.5 - Right Hand



8 680437 026204

**RK.01.381** Repair Kit



8 680437 064640

## Twin Cylinder Compressor Ø86 mm-630 CC-Stroke 54 mm

Application - Vehicle  
FORD 3235 - 1835  
CARGO

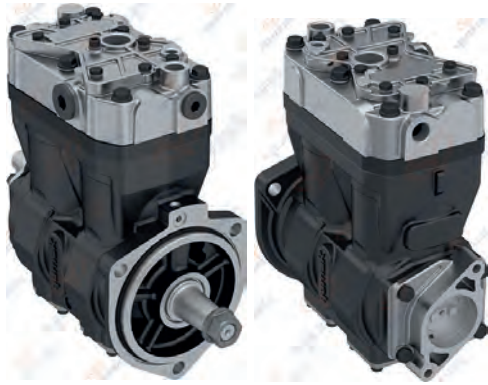

**01.04.157.10**

Oem. Ref. No.  
7C46 2875 AD N  
7C462875ADN

Knorr No.  
LK4958-K094132N00



8 680437 080350



**01.1400** Crankcase



8 680437 075109

**RK.01.679** Repair Kit

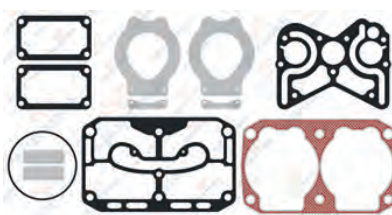

8 680437 071662

Knorr No: K083735K50

**RK.01.136.13** Repair Kit

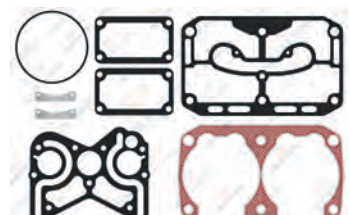

8 680437 120599

**RK.01.677.10**

Complete Cylinder Head



8 680437 079774

**RK.01.676.11**

Valve Plate Kit

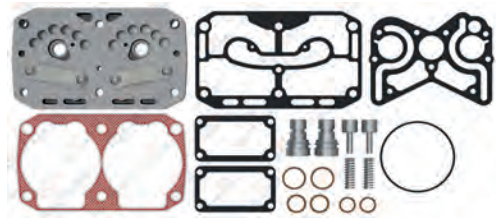

8 680437 112617

**RK.01.676.10**

Valve Plate Kit



8 680437 112600

Oem. No: 42562099  
Knorr No: K041488K50

**RK.01.136.02**

Repair Kit

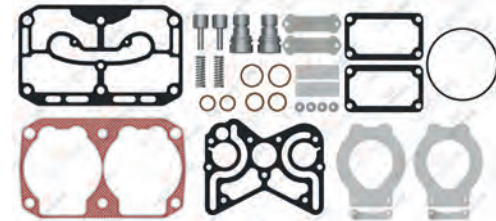

8 680437 060987

**RK.01.136.03**

Repair Kit

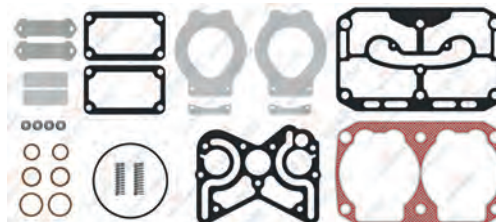

8 680437 060994



# FORD - BMC

## AIR COMPRESSOR AND REPAIR KIT

**RK.01.677.11** Complete Cylinder Head



Knorr No: K094157K50  
8 680437 082835

**01.1492** Valve Plate



8 680437 079927

**01.1030** Crankshaft



M18X1.5 - Right Hand  
8 680437 014980

**01.208** Bushing



44X40X20

8 680437 019602

**01.1454** Crankshaft Flange



8 680437 084679

**01.587** Connecting Rod



8 680437 024323

**RK.01.272.00** Piston&Ring (Ø86,00 mm)

RK.01.272.10 86,25 mm  
RK.01.272.20 86,50 mm  
RK.01.272.30 86,75 mm  
RK.01.272.40 87,00 mm



2.00x2,00x3,00

Knorr No: SEB22547 - SEB22548  
8 680437 063209

**01.868.00** Piston (Ø86,00 mm)

01.868.10 86,25 mm  
01.868.20 86,50 mm  
01.868.30 86,75 mm  
01.868.40 87,00 mm



2.00x2,00x3,00

8 680437 027676

**01.869.00** Ring (Ø86,00 mm)

01.869.10 86,25 mm  
01.869.20 86,50 mm  
01.869.30 86,75 mm  
01.869.40 87,00 mm



2.00x2,00x3,00

8 680437 027737

**RK.01.184** Repair Kit



8 680437 061885

**01.752** Nut



M18X1.5 - Right Hand  
8 680437 026204

**01.026** Bushing



44X40X26  
8 680437 071679

**RK.01.381.01** Repair Kit



Knorr No: K114137K50  
8 680437 118213

## Twin Cylinder Compressor Ø86 mm-460 CC-Stroke 40 mm

Application - Vehicle  
BMC (Turkey) FALCON 1100



**01.05.149**

Oem. Ref. No.  
9P925474

Knorr No.  
LP4865-K033404N00



**01.1519** Crankcase



**RK.01.679** Repair Kit

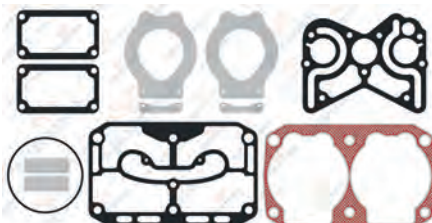

**RK.01.677.20** Complete Cylinder Head



**RK.01.676** Valve Plate Kit



**RK.01.676.01** Valve Plate Kit



**RK.01.679.01** Repair Kit



**RK.01.679.05** Repair Kit

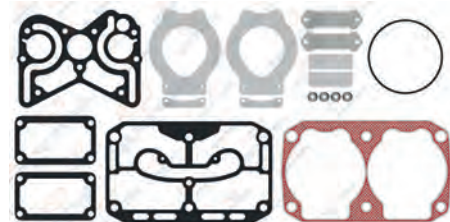

**RK.01.679.06** Repair Kit



Oem. No: 42549151  
Knorr No: SEB22550

# FORD - BMC

## AIR COMPRESSOR AND REPAIR KIT

**01.1374** Cylinder Head



8 680437 076803

**01.1373** Cylinder Head



8 680437 077831

**01.1520** Crankshaft



M18X1.5 - Left Hand



8 680437 076384

**01.1372** Valve Plate



8 680437 074144

Knorr No: K044410K50

**RK.01.677.21** Complete Cylinder Head



8 680437 079378

Knorr No: K047839K50

**01.1016** Connecting Rod



8 680437 014775

**RK.01.272.00** Piston&Ring (Ø86,00 mm)

- RK.01.272.10 86,25 mm
- RK.01.272.20 86,50 mm
- RK.01.272.30 86,75 mm
- RK.01.272.40 87,00 mm



2.00x2.00x3.00



8 680437 063209

Knorr No: SEB22547 - SEB22548

**01.868.00** Piston (Ø86,00 mm)

- 01.868.10 86,25 mm
- 01.868.20 86,50 mm
- 01.868.30 86,75 mm
- 01.868.40 87,00 mm



2.00x2.00x3.00



8 680437 027676

**01.869.00** Ring (Ø86,00 mm)

- 01.869.10 86,25 mm
- 01.869.20 86,50 mm
- 01.869.30 86,75 mm
- 01.869.40 87,00 mm



2.00x2.00x3.00



8 680437 027737

**01.1521** Crankshaft Flange



8 680437 083238

**01.026** Bushing



44X40X26



8 680437 071679

**01.1522** Adapter



8 680437 109006

**RK.01.184** Repair Kit



8 680437 061885

**01.079** Cover



8 680437 014232

**01.870** Nut



M18X1.5 - Left Hand



8 680437 027799



## Twin Cylinder Compressor Ø86 mm-460 CC-Stroke 40 mm

Application - Vehicle  
BMC (Turkey) FALCON 1100



**01.05.149.10**

Oem. Ref. No.  
9P925474

Knorr No.  
LP4865-K033404N00



**01.1519** Crankcase



**RK.01.136.05** Repair Kit

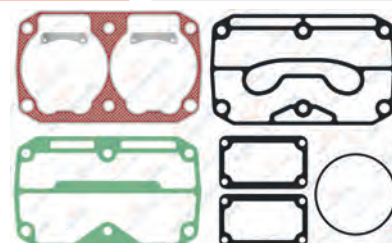

**RK.01.184** Repair Kit



**RK.01.662** Complete Cylinder Head



**RK.01.339.10** Valve Plate Kit

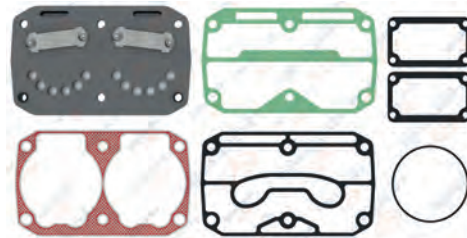

**RK.01.339.30** Valve Plate Kit

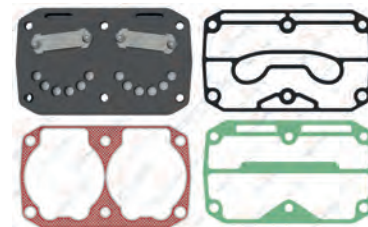

**RK.01.136.09** Repair Kit

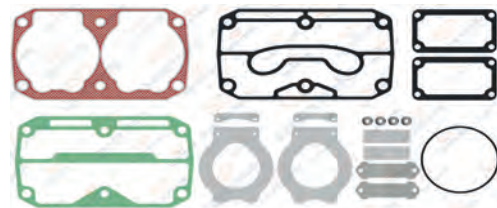

**RK.01.136.20** Repair Kit

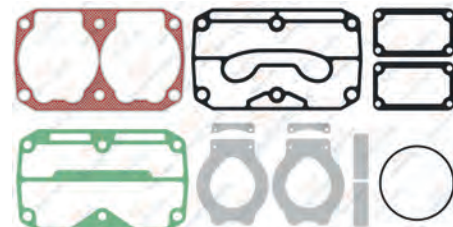

# FORD - BMC

## AIR COMPRESSOR AND REPAIR KIT

**01.1620** Cylinder Head



8 680437 101697

**01.1566** Valve Plate



8 680437 114109

**01.1520** Crankshaft



M18X1.5 - Left Hand



8 680437 076384

**01.026** Bushing



44X40X26



8 680437 071679

**01.1521** Crankshaft Flange



8 680437 083238

**01.1016** Connecting Rod



8 680437 014775

**RK.01.272.00** Piston&Ring (Ø86,00 mm)

- RK.01.272.10 86,25 mm
- RK.01.272.20 86,50 mm
- RK.01.272.30 86,75 mm
- RK.01.272.40 87,00 mm



2.00x2,00x3,00



8 680437 063209

Knorr No: SEB22547 - SEB22548

**01.868.00** Piston (Ø86,00 mm)

- 01.868.10 86,25 mm
- 01.868.20 86,50 mm
- 01.868.30 86,75 mm
- 01.868.40 87,00 mm



2.00x2,00x3,00



8 680437 027676

**01.869.00** Ring (Ø86,00 mm)

- 01.869.10 86,25 mm
- 01.869.20 86,50 mm
- 01.869.30 86,75 mm
- 01.869.40 87,00 mm



2.00x2,00x3,00



8 680437 027737

**01.870** Nut



M18X1.5 - Left Hand



8 680437 027799

**01.079** Cover



8 680437 014232

**01.1522** Adapter



8 680437 109006

**01.302** Cap



8 680437 020769

## Twin Cylinder Compressor Ø75 mm-495 CC-Stroke 56 mm

Application - Vehicle  
BMC  
BELDE OTOBÜS



**01.04.127**

**Oem. Ref. No.**  
4945947RX  
CB280  
CB260

**Wabco No.**  
9115160100



**01.1221** Crankcase



**RK.01.617** Complete Cylinder Head



**Knorr No:** 9115169202

8 680437 067313

**RK.01.618.01** Repair Kit

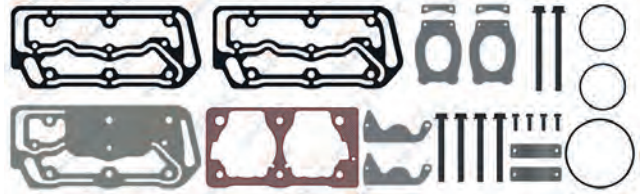

8 680437 121701

**RK.01.618** Repair Kit



8 680437 067320

**RK.01.618.04** Repair Kit



8 680437 067337

Use for old version cylinder repair kit. Yıpranmış kapaklar için.

**RK.01.618.23** Repair Kit

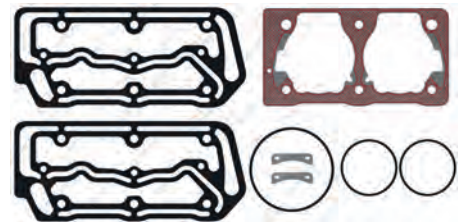

8 680437 072751

**RK.01.618.06** Repair Kit



8 680437 163893

**RK.01.618.07** Repair Kit

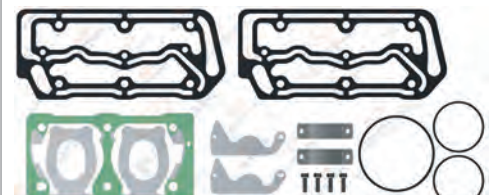

8 680437 163909



# FORD - BMC

## AIR COMPRESSOR AND REPAIR KIT

**01.1209** Cylinder Head



8 680437 017653

**01.1210** Valve Plate

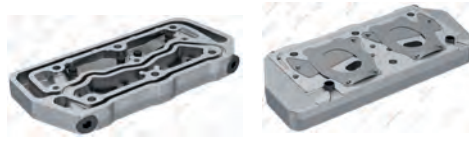

8 680437 017684

**01.1220** Crankshaft



8 680437 017820

**01.1095** Valve Plate



8 680437 015949

**01.1222** Flange



Wabco No: 9111539252

**01.1224** Connecting Rod



8 680437 017868

**RK.01.118.00** Piston&Ring (Ø75,00 mm)

- RK.01.118.10 75,25 mm
- RK.01.118.20 75,50 mm
- RK.01.118.30 75,75 mm
- RK.01.118.40 76,00 mm



2,00x2,00x4,00



Wabco No: 4111416232

**01.911.00** Piston (Ø75,00 mm)

- 01.911.10 75,25 mm
- 01.911.20 75,50 mm
- 01.911.30 75,75 mm
- 01.911.40 76,00 mm



2,00x2,00x4,00



8 680437 028277

**01.134.00** Ring (Ø75,00 mm)

- 01.134.10 75,25 mm
- 01.134.20 75,50 mm
- 01.134.30 75,75 mm
- 01.134.40 76,00 mm



2,00x2,00x4,00



8 680437 018278

**01.1223** Cover



8 680437 017851

**01.1225** Gear



8 680437 017875

**RK.01.618.30** Repair Kit



8 680437 124092

## Single Cylinder Compressor Ø88 mm-300 CC-Stroke 37 mm

Application - Vehicle  
FORD CARGO

16-25-13-15-28-34-38-30-32



### 01.04.023

Oem. Ref. No.

01174474  
01173720  
11001360

Knorr No.

LK3904-I78976



8 680437 010968



01.338

Crankcase

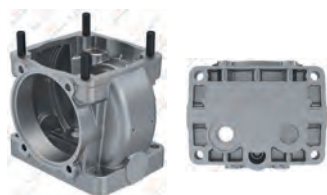

8 680437 021278

RK.01.148.02

Repair Kit

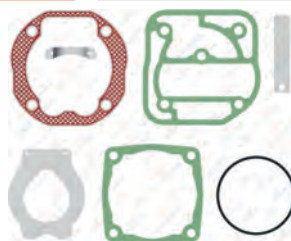

8 680437 006978

RK.01.068 Complete Cylinder Head



8 680437 059493

Knorr No: ZB4275

RK.01.068.01

Complete Cylinder Head

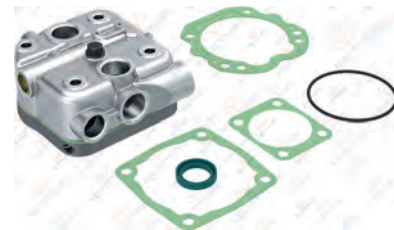

8 680437 105558

Knorr No: ZB4275\*

RK.01.035.01

Valve Plate Kit

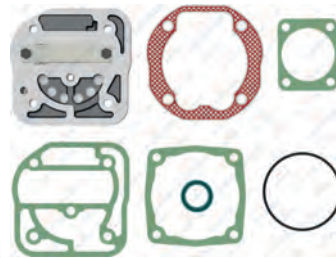

8 680437 112426

RK.01.035.02

Valve Plate Kit



8 680437 112433

RK.01.148

Repair Kit

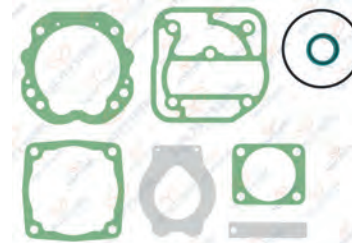

8 680437 061236

RK.01.148.03

Repair Kit



8 680437 120193

# FORD - BMC

## AIR COMPRESSOR AND REPAIR KIT

### 01.076 Cylinder Head



8 680437 014164

### 01.139 Valve Plate



Knorr No: I84870004

### 01.099 Crankshaft



M18X1.5 - Right Hand



8 680437 014560

### 01.013 Bushing



30x34x16



8 680437 009993

### 01.066 Crankshaft Flange



8 680437 013976

### 01.008 Connecting Rod



8 680437 009795

### RK.01.034.00 Piston&Ring (Ø88,00 mm)

- RK.01.034.10 88,25 mm
- RK.01.034.20 88,50 mm
- RK.01.034.30 88,75 mm
- RK.01.034.40 89,00 mm



2.50x2,50x4,00



Knorr No:I81169004 - SEB22555

8 680437 058616

### 01.110.00 Piston (Ø88,00 mm)

- 01.110.10 88,25 mm
- 01.110.20 88,50 mm
- 01.110.30 88,75 mm
- 01.110.40 89,00 mm



2.50x2,50x4,00



8 680437 015994

### 01.136.00 Ring (Ø88,00 mm)

- 01.136.10 88,25 mm
- 01.136.20 88,50 mm
- 01.136.30 88,75 mm
- 01.136.40 89,00 mm



2.50x2,50x4,00



8 680437 018384

Knorr No: I139526F0061

### RK.01.032 Cylinder Liner Set



8 680437 058779

### 01.057 Cylinder Liner



8 680437 013181

### 01.143 Nut



M18X1.5 - Right Hand



8 680437 018735

### RK.01.148.05 Repair Kit



8 680437 120209

### 01.073 Cover



8 680437 014133

### 00.140 Roller Bearing



6305



8 680437 001577



## Single Cylinder Compressor Ø92 mm-360 CC-Stroke 56 mm

Application - Vehicle  
FORD CARGO 3230

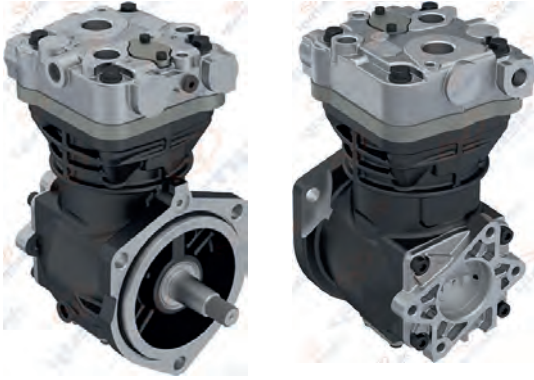

**01.04.121**

Oem. Ref. No.  
7C462875BA

Knorr No.  
LP3974-K017428



**01.1202** Crankcase



**RK.01.395.06** Repair Kit

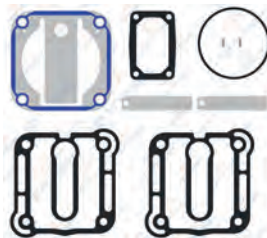

Knorr No: SEB22532

**RK.01.607** Complete Cylinder Head



**RK.01.609.01** Valve Plate Kit



**RK.01.609** Valve Plate Kit

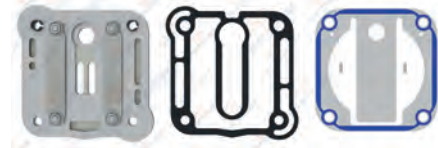

**RK.01.608.01** Repair Kit

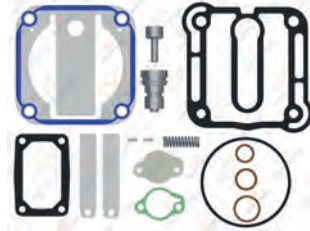

Oem. No: 4C462B956AA  
Knorr No: SEB22597

**RK.01.608** Repair Kit

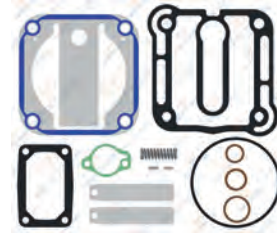

Oem. No: 4C462B956BA

**RK.01.608.04** Repair Kit

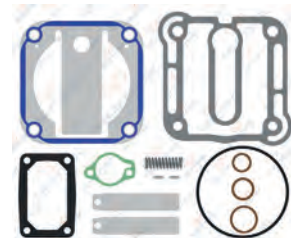

Use for old version cylinder repair kit.  
Yıpranmış kapaklar için.

# FORD - BMC

## AIR COMPRESSOR AND REPAIR KIT

### 01.1203 Cylinder Head



8 680437 017592 **OEM No:** 4C462B960AA  
**Knorr No:** SEB01894004

### 01.1204 Valve Plate



8 680437 017608 **Knorr No:** Y004552004

### 01.1207 Crankshaft



**M18X1.5 - Left Hand**  
8 680437 017639

### 01.292 Bushing



42X38X25

8 680437 073871

### 01.1206 Crankshaft Flange



8 680437 017622

### 01.1101 Connecting Rod



8 680437 016069

### RK.01.318.00 Piston&Ring (Ø92,00 mm)

- RK.01.318.10 92,25 mm
- RK.01.318.20 92,50 mm
- RK.01.318.30 92,75 mm
- RK.01.318.40 93,00 mm



2.50x2,50x4,00

8 680437 063773 **OEM No:** SEB22530  
**Knorr No:** K012079

### 01.862.00 Piston (Ø92,00 mm)

- 01.862.10 92,25 mm
- 01.862.20 92,50 mm
- 01.862.30 92,75 mm
- 01.862.40 93,00 mm



2.50x2,50x4,00

8 680437 027584

### 01.942.00 Ring (Ø92,00 mm)

- 01.942.10 92,25 mm
- 01.942.20 92,50 mm
- 01.942.30 92,75 mm
- 01.942.40 93,00 mm



2.50x2,50x4,00

8 680437 028666

### 01.374 Cover



8 680437 077022

### 01.870 Nut



**M18X1.5 - Left Hand**  
8 680437 027799

## Single Cylinder Compressor Ø92 mm-360 CC-Stroke 54 mm

Application - Vehicle  
FORD

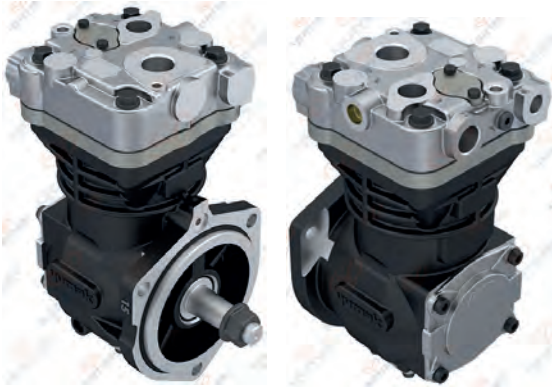

**01.04.245**

Oem. Ref. No.  
GC462875BB

Knorr No.  
LK8921  
K099480N00



**01.1202** Crankcase



**RK.01.395.06** Repair Kit

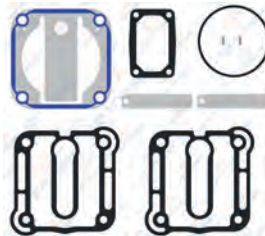

Knorr No: SEB22532

**RK.01.870** Complete Cylinder Head



**RK.01.609.01** Valve Plate Kit

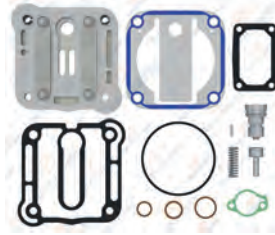

**RK.01.609** Valve Plate Kit

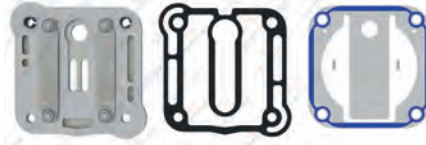

**RK.01.608.01** Repair Kit

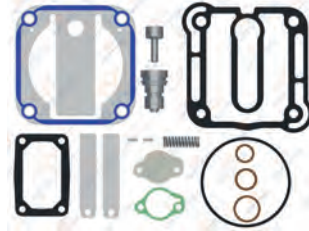

Oem. No: 4C462B956AA  
Knorr No: SEB22597

**RK.01.608** Repair Kit

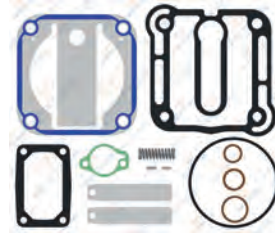

Oem. No: 4C462B956BA

**RK.01.608.04** Repair Kit

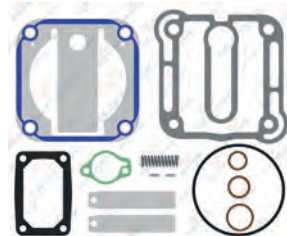

Use for old version cylinder repair kit.  
Yıpranmış kapaklar için.



# FORD - BMC

## AIR COMPRESSOR AND REPAIR KIT

### 01.1203.20 Cylinder Head



8 680437 017592 **OEM No:** 4C462B960AA  
**Knorr No:** SEB01894004

### 01.1204 Valve Plate



8 680437 017608 **Knorr No:** Y004552004

### 01.1207 Crankshaft



**M18X1.5 - Left Hand**  
8 680437 017639

### 01.870 Nut



**M18X1.5 - Left Hand**  
8 680437 027799

### 01.1915 Crankshaft Flange



8 680437 164135

### 01.1101 Connecting Rod



8 680437 016069

### RK.01.318.00 Piston&Ring (Ø92,00 mm)

- RK.01.318.10 92,25 mm
- RK.01.318.20 92,50 mm
- RK.01.318.30 92,75 mm
- RK.01.318.40 93,00 mm



2.50x2,50x4,00  
8 680437 063773 **OEM No:** SEB22530  
**Knorr No:** K012079

### 01.862.00 Piston (Ø92,00 mm)

- 01.862.10 92,25 mm
- 01.862.20 92,50 mm
- 01.862.30 92,75 mm
- 01.862.40 93,00 mm



2.50x2,50x4,00  
8 680437 027584

### 01.942.00 Ring (Ø92,00 mm)

- 01.942.10 92,25 mm
- 01.942.20 92,50 mm
- 01.942.30 92,75 mm
- 01.942.40 93,00 mm



2.50x2,50x4,00  
8 680437 028666

## Single Cylinder Compressor Ø92 mm-360 CC-Stroke 54 mm

Application - Vehicle  
FORD

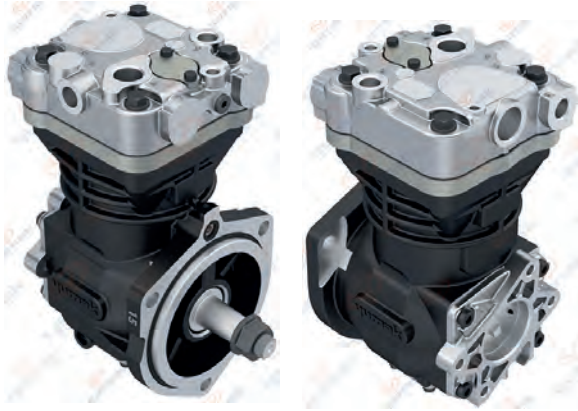

**01.04.246**

Oem. Ref. No.  
GC462875CA

Knorr No.  
LK8922  
K099511N00



**01.1202** Crankcase



**RK.01.395.06** Repair Kit

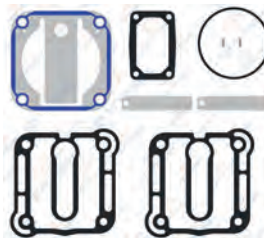

Knorr No: SEB22532

**RK.01.871** Complete Cylinder Head



**RK.01.609.01** Valve Plate Kit



**RK.01.609** Valve Plate Kit

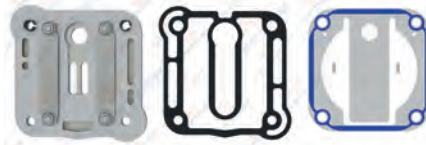

**RK.01.608.01** Repair Kit

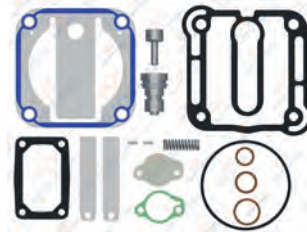

Oem. No: 4C462B956AA  
Knorr No: SEB22597

**RK.01.608** Repair Kit

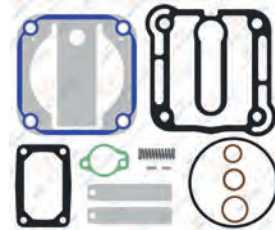

Oem. No: 4C462B956BA

**RK.01.608.04** Repair Kit

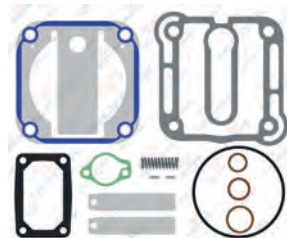

Use for old version cylinder repair kit.  
Yıpranmış kapaklar için.

# FORD - BMC

## AIR COMPRESSOR AND REPAIR KIT

### 01.1203.30 Cylinder Head



8 680437 017592 **OEM No:** 4C462B960AA  
**Knorr No:** SEB01894004

### 01.1204 Valve Plate



8 680437 017608 **Knorr No:** Y004552004

### 01.1207 Crankshaft



**M18X1.5 - Left Hand**

8 680437 017639

### 01.870 Nut



**M18X1.5 - Left Hand**

8 680437 027799

### 01.1206 Crankshaft Flange



8 680437 017622

### 01.1101 Connecting Rod



8 680437 016069

### RK.01.318.00 Piston&Ring (Ø92,00 mm)

- RK.01.318.10 92,25 mm
- RK.01.318.20 92,50 mm
- RK.01.318.30 92,75 mm
- RK.01.318.40 93,00 mm



2.50x2,50x4,00

8 680437 063773 **OEM No:** SEB22530  
**Knorr No:** K012079

### 01.862.00 Piston (Ø92,00 mm)

- 01.862.10 92,25 mm
- 01.862.20 92,50 mm
- 01.862.30 92,75 mm
- 01.862.40 93,00 mm



2.50x2,50x4,00

8 680437 027584

### 01.942.00 Ring (Ø92,00 mm)

- 01.942.10 92,25 mm
- 01.942.20 92,50 mm
- 01.942.30 92,75 mm
- 01.942.40 93,00 mm



2.50x2,50x4,00

8 680437 028666



# Single Cylinder Compressor Ø88 mm-300 CC-Stroke 50 mm

Application - Vehicle  
FORD CARGO 32-27



**01.04.027**

Oem. Ref. No.  
1180656

Knorr No.  
LK3965  
II33163-K021890



**01.306** Crankcase



**RK.01.115** Repair Kit

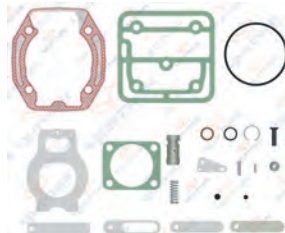

**RK.01.112** Complete Cylinder Head



**RK.01.112.20** Complete Cylinder Head



**RK.01.113.01** Valve Plate Kit

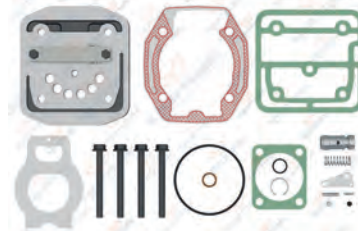

**RK.01.113** Valve Plate Kit



**RK.01.115.01** Repair Kit

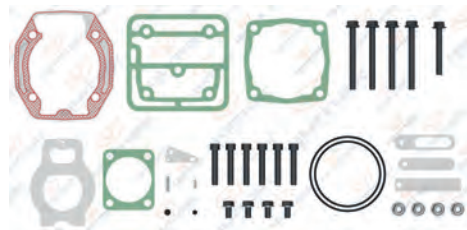

Knorr No: K110174K50

**RK.01.115.03** Repair Kit

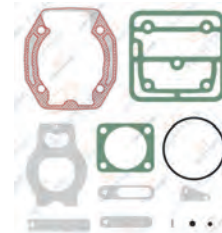

# FORD - BMC

## AIR COMPRESSOR AND REPAIR KIT

01.304

Cylinder Head



8 680437 020783

01.355

Valve Plate



Knorr No: II14777004

01.307

Crankshaft



M20X1.5 - Right Hand



8 680437 020844

01.195

Bushing



34X30X19



8 680437 019411

01.308

Crankshaft Flange



8 680437 020851

01.008

Connecting Rod



8 680437 009795

RK.01.034.00

Piston&Ring (Ø88,00 mm)

- RK.01.034.10 88,25 mm
- RK.01.034.20 88,50 mm
- RK.01.034.30 88,75 mm
- RK.01.034.40 89,00 mm



2.50x2,50x4,00



Knorr No: I81169004 - SEB22555

01.110.00

Piston (Ø88,00 mm)

- 01.110.10 88,25 mm
- 01.110.20 88,50 mm
- 01.110.30 88,75 mm
- 01.110.40 89,00 mm



2.50x2,50x4,00



8 680437 015994

01.136.00

Ring (Ø88,00 mm)

- 01.136.10 88,25 mm
- 01.136.20 88,50 mm
- 01.136.30 88,75 mm
- 01.136.40 89,00 mm



2.50x2,50x4,00



Knorr No: II39526F0061

RK.01.114

Cylinder Liner Set



8 680437 060437

01.305

Cylinder Liner



8 680437 020806

01.013

Bushing



34X30X16



8 680437 009993

RK.01.029

Repair Kit



8 680437 058700

01.881

Pump Support



8 680437 027942

## Single Cylinder Compressor Ø80 mm-225 CC-Stroke 45 mm

Application - Vehicle  
BMC

PRO 522 / PRO 620 / PRO 624 / PRO  
625 / FTH200 / FTH170 / PROBUS



**01.04.126**

Oem. Ref. No.  
57RS300781

Knorr No.  
LK3857-SEB01813



**01.1390** Crankcase



**RK.01.159.20** Repair Kit

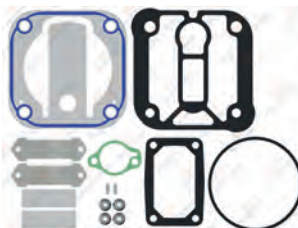

**RK.01.615** Complete Cylinder Head



**RK.01.616.01** Valve Plate Kit



**RK.01.616** Valve Plate Kit



Oem. No: 9P918391  
Knorr No: SEB01593004

**RK.01.159.25** Repair Kit

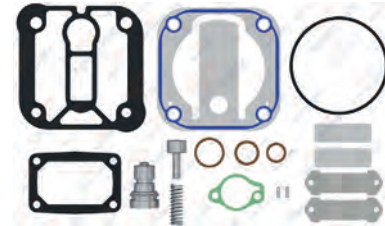

Oem. No: 9P918389

**RK.01.159.18** Repair Kit

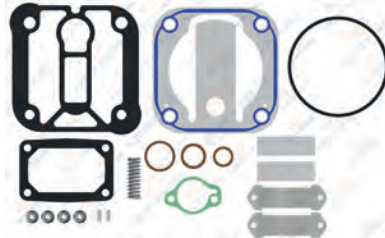

**RK.01.159.22** Repair Kit

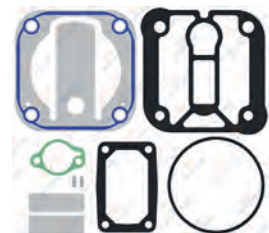



# FORD - BMC

## AIR COMPRESSOR AND REPAIR KIT

### 01.1208 Cylinder Head



Oem. No: 9P918392  
Knorr No: SEB01814004

### 01.1219 Valve Plate



Knorr No: SEB01915004

### 01.1338 Crankshaft



5/8 - 18 UNF

8 680437 109372

### 01.820 Bushing



42x38x25

8 680437 027058

### 01.1389 Crankshaft Flange



8 680437 072096

### 01.1101 Connecting Rod



8 680437 016069

### RK.01.601.00 Piston&Ring (Ø80,00 mm)

- RK.01.601.10 80,25 mm
- RK.01.601.20 80,50 mm
- RK.01.601.30 80,75 mm
- RK.01.601.40 81,00 mm



2.50x2,50x4,00

Knorr No: SEB22517  
8 680437 067054

### 01.1201.00 Piston (Ø80,00 mm)

- 01.1201.10 80,25 mm
- 01.1201.20 80,50 mm
- 01.1201.30 80,75 mm
- 01.1201.40 81,00 mm

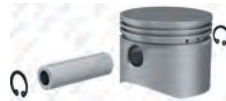

2.50x2,50x4,00

8 680437 017530

### 01.1226.00 Ring (Ø80,00 mm)

- 01.1226.10 80,25 mm
- 01.1226.20 80,50 mm
- 01.1226.30 80,75 mm
- 01.1226.40 81,00 mm



2.50x2,50x4,00

8 680437 017882

### RK.01.159.05 Repair Kit

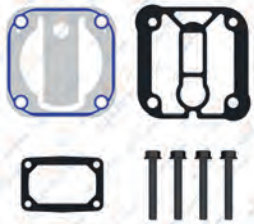

Knorr No: SEB018190051  
8 680437 120377

### RK.01.159.27 Repair Kit



Knorr No: SEB22519\*  
8 680437 121121

### 01.374 Cover



8 680437 077022

### RK.01.532 Repair Kit

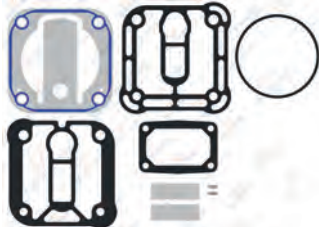

8 680437 066279

### 01.1658 Nut



5/8 - 18 UNF

8 680437 117957

## Single Cylinder Compressor Ø80 mm-225 CC-Stroke 45 mm

Application - Vehicle  
FORD CARGO 2524 / 2520L / 1826 /  
2526 / 2526D



**01.04.128**

Oem. Ref. No.  
7C462875CA

Wabco No.  
LK3848-K019284



8 680437 011989



**01.1590** Crankcase



8 680437 103691

**RK.01.159.20** Repair Kit

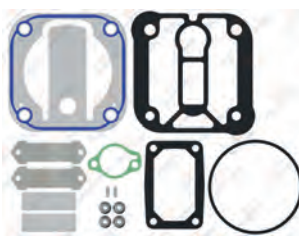

8 680437 073956

**RK.01.640** Complete Cylinder Head



8 680437 072065

**RK.01.616.01** Valve Plate Kit



8 680437 112297

**RK.01.616** Valve Plate Kit



8 680437 067306

Oem. No: 9P918391  
Knorr No: SEB01593004

**RK.01.159.25** Repair Kit

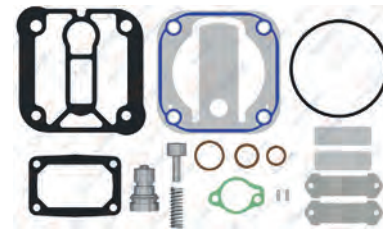

8 680437 081807

Oem. No: 9P918389

**RK.01.159.18** Repair Kit

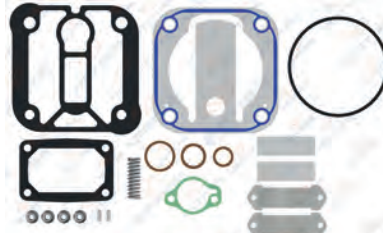

8 680437 119050

**RK.01.159.22** Repair Kit

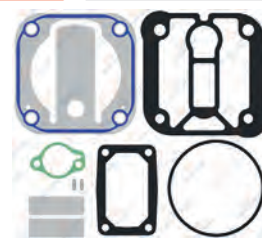

8 680437 119067

# FORD - BMC

## AIR COMPRESSOR AND REPAIR KIT

**01.1303** Cylinder Head



8 680437 079941

**01.1219** Valve Plate



Knorr No: SEB01915004  
8 680437 017776

**01.1339** Crankshaft



M18X1.5 - Left Hand  
8 680437 072430

**01.820** Bushing



42x38x25  
8 680437 027056

**01.1206** Crankshaft Flange



8 680437 017622

**01.587** Connecting Rod



8 680437 024323

**RK.01.601.00** Piston&Ring (Ø80,00 mm)

RK.01.601.10	80,25 mm
RK.01.601.20	80,50 mm
RK.01.601.30	80,75 mm
RK.01.601.40	81,00 mm



2.50x2,50x4,00  
Knorr No: SEB22517  
8 680437 067054

**01.1201.00** Piston (Ø80,00 mm)

01.1201.10	80,25 mm
01.1201.20	80,50 mm
01.1201.30	80,75 mm
01.1201.40	81,00 mm



2.50x2,50x4,00  
8 680437 017530

**01.1226.00** Ring (Ø80,00 mm)

01.1226.10	80,25 mm
01.1226.20	80,50 mm
01.1226.30	80,75 mm
01.1226.40	81,00 mm



2.50x2,50x4,00  
8 680437 017882

**RK.01.159.05** Repair Kit

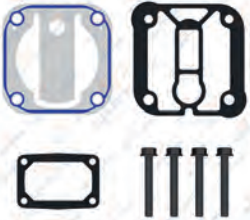

Knorr No: SEB018190051  
8 680437 120377

**RK.01.159.19** Repair Kit



Knorr No: SEB22519  
8 680437 121114

**01.374** Cover



8 680437 077022

**RK.01.532** Repair Kit

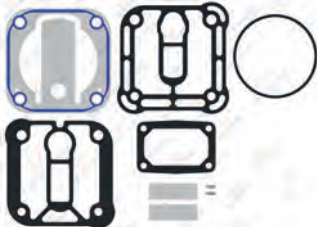

8 680437 066279



# Single Cylinder Compressor Ø80 mm-225 CC-Stroke 45 mm

Application - Vehicle  
FORD CARGO 815



**01.04.130**

Oem. Ref. No.

Knorr No.

LK3833-SEB01586000



8 680437 072126



**01.1387**

Crankcase



8 680437 072102

**RK.01.159.20**

Repair Kit

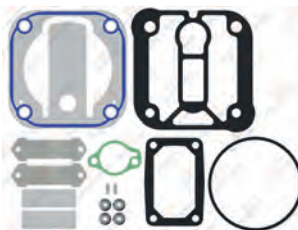

8 680437 073956

**RK.01.641** Complete Cylinder Head



8 680437 072201

**RK.01.616.01**

Valve Plate Kit



8 680437 112297

**RK.01.616**

Valve Plate Kit



8 680437 067306

Oem. No: 9P918391

Knorr No: SEB01593004

**RK.01.159.25**

Repair Kit



8 680437 081807

Oem. No: 9P918389

**RK.01.159.18**

Repair Kit

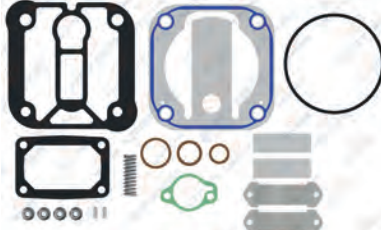

8 680437 119050

**RK.01.159.22**

Repair Kit

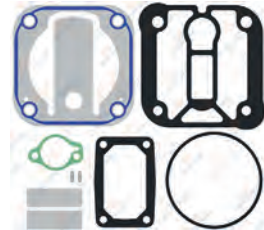

8 680437 119067

# FORD - BMC

## AIR COMPRESSOR AND REPAIR KIT

### 01.1302 Cylinder Head



8 680437 079415

### 01.1219 Valve Plate



Knorr No: SEB01915004

### 01.1339 Crankshaft



M18X1.5 - Left Hand



8 680437 072430

### 01.820 Bushing



42x38x25



8 680437 027058

### 01.1389 Crankshaft Flange



8 680437 072096

### 01.1101 Connecting Rod



8 680437 016069

### RK.01.601.00 Piston&Ring (Ø80,00 mm)

- RK.01.601.10 80,25 mm
- RK.01.601.20 80,50 mm
- RK.01.601.30 80,75 mm
- RK.01.601.40 81,00 mm



2.50x2,50x4,00



Knorr No: SEB22517

8 680437 067054

### 01.1201.00 Piston (Ø80,00 mm)

- 01.1201.10 80,25 mm
- 01.1201.20 80,50 mm
- 01.1201.30 80,75 mm
- 01.1201.40 81,00 mm

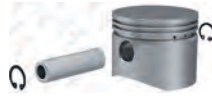

2.50x2,50x4,00



8 680437 017530

### 01.1226.00 Ring (Ø80,00 mm)

- 01.1226.10 80,25 mm
- 01.1226.20 80,50 mm
- 01.1226.30 80,75 mm
- 01.1226.40 81,00 mm



2.50x2,50x4,00



8 680437 017882

### RK.01.159.05 Repair Kit

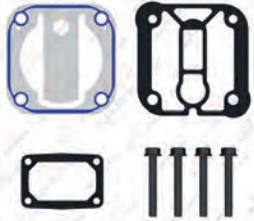

Knorr No: SEB018190051

8 680437 120377

### RK.01.159.27 Repair Kit

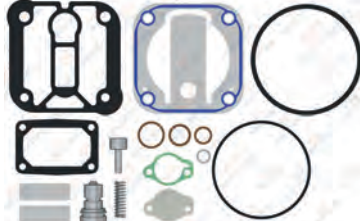

Knorr No: SEB22519\*

8 680437 121121

### 01.374 Cover



8 680437 077022

# Single Cylinder Compressor Ø90 mm-229 CC-Stroke 36 mm

Application - Vehicle  
FORD



**01.05.120**

Oem. Ref. No.  
0041318601  
01173854

Wabco No.  
4111426820  
4111428800



**01.1250**

Crankcase



**RK.01.183**

Repair Kit



**RK.01.019**

Complete Cylinder Head



**RK.01.013**

Valve Plate Kit



**RK.01.636.01**

Repair Kit

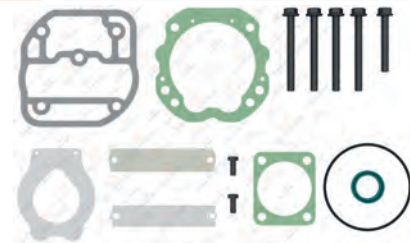

**RK.01.636**

Repair Kit

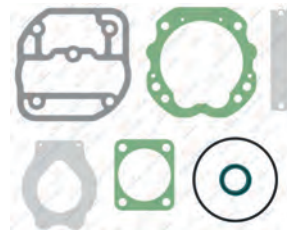

**RK.01.636.02**

Repair Kit

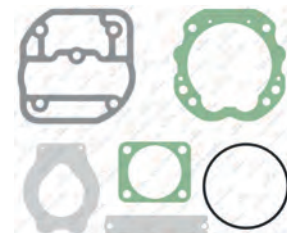



# FORD - BMC

## AIR COMPRESSOR AND REPAIR KIT

### 01.070 Cylinder Head



Wabco No: 4110336532 - 4110336572

### 01.122 Valve Plate



### 01.1254 Crankshaft



M18X1.5 - Right Hand



Wabco No: 4111416904

### 01.073 Cover



### 01.234 Crankshaft Flange



Wabco No: 4111406622

### 01.230.10 Connecting Rod



Wabco No: 4111427342

### RK.01.635.00 Piston&Ring (Ø90,00 mm)

- RK.01.635.10 90,25 mm
- RK.01.635.20 90,50 mm
- RK.01.635.30 90,75 mm
- RK.01.635.40 91,00 mm



2.50x2,50x4,00



Wabco No: 4111426232

### 01.1255.00 Piston (Ø90,00 mm)

- 01.1255.10 90,25 mm
- 01.1255.20 90,50 mm
- 01.1255.30 90,75 mm
- 01.1255.40 91,00 mm



2.50x2,50x4,00



### 01.138.00 Ring (Ø90,00 mm)

- 01.138.10 90,25 mm
- 01.138.20 90,50 mm
- 01.138.30 90,75 mm
- 01.138.40 91,00 mm



2.50x2,50x4,00



### 01.437 Bushing



39X35X20



### 01.656 Bushing



34x30x20



Wabco No: 4111412054

### 01.143 Nut



M18X1.5 - Right Hand



### 01.241 Connecting Rod Bearing Kit



Wabco No: 4110423414

## Single Cylinder Compressor Ø85 mm-318 CC-Stroke 56 mm

Application - Vehicle  
BMC PRO 935 - PRO 940

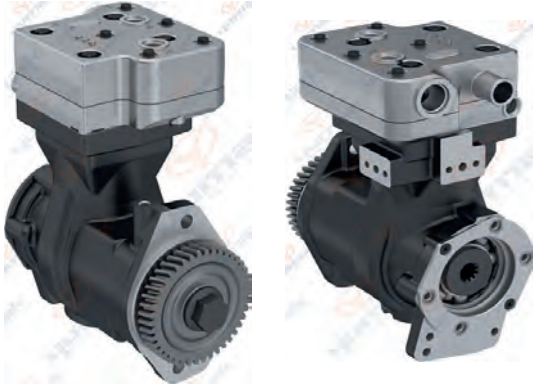

**01.04.178**

Oem. Ref. No.  
9P921823

Wabco No.  
9111539380

**01.04.178.10**

Without Gear



**01.1604** Crankcase



**RK.01.067.05** Repair Kit



**RK.01.430** Complete Cylinder Head



Wabco No: 9111539202

**RK.01.067.01** Repair Kit

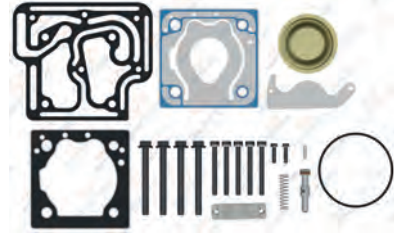

**RK.01.067.02** Repair Kit

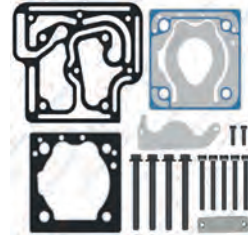

Wabco No: 9111549292

**RK.01.067** Repair Kit

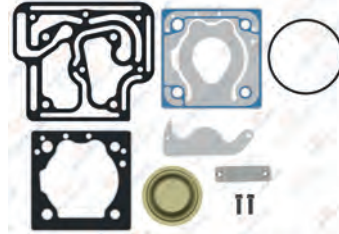

**RK.01.067.04** Repair Kit

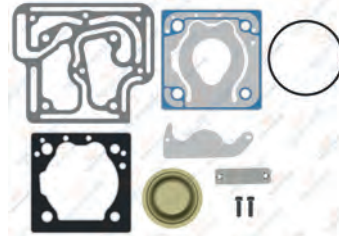

Use for old version cylinder repair kit. Yıpranmış kapaklar için.

**RK.01.067.06** Repair Kit

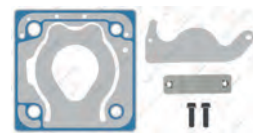

# FORD - BMC

## AIR COMPRESSOR AND REPAIR KIT

### 01.990 Cylinder Head



8 680437 029559

### 01.901 Valve Plate



8 680437 028178

### 01.1636 Crankshaft



8 680437 079811

Left Hand - Sol Dis

### 00.999 Roller Bearing



6308



8 680437 009627

### 01.1222 Flange



8 680437 017844

Wabco No: 9111539252

### 01.272 Connecting Rod



8 680437 020400

### RK.01.104.00 Piston&Ring (Ø85,00 mm)

- RK.01.104.10 85,25 mm
- RK.01.104.20 85,50 mm
- RK.01.104.30 85,75 mm
- RK.01.104.40 86,00 mm



2.00x2,00x4,00



8 680437 060277

### 01.142.00 Piston (Ø85,00 mm)

- 01.142.10 85,25 mm
- 01.142.20 85,50 mm
- 01.142.30 85,75 mm
- 01.142.40 86,00 mm



2.00x2,00x4,00



8 680437 018674

Wabco No: 9115016242 - 9115016252

### 01.373.00 Ring (Ø85,00 mm)

- 01.373.10 85,25 mm
- 01.373.20 85,50 mm
- 01.373.30 85,75 mm
- 01.373.40 86,00 mm



2.00x2,00x4,00



8 680437 075431

Wabco No: 9115019202

### RK.01.513 Repair Kit

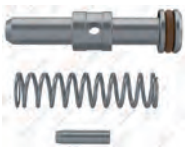

8 680437 066057

### 01.1225 Gear



8 680437 017875

Wabco No: 3942497 - 3940239

### 01.1643 Screw



M20X50 - Right Hand



8 680437 091073



## Single Cylinder Compressor Ø85 mm-318 CC-Stroke 56 mm

Application - Vehicle  
BMC

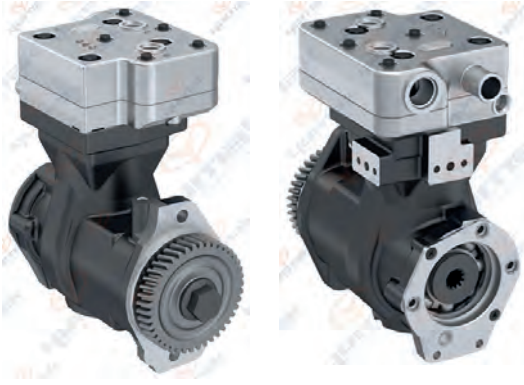

**01.04.183**

Oem. Ref. No.  
9P921823

Wabco No.  
9111530200



**01.1650** Crankcase



**RK.01.067.05** Repair Kit



**RK.01.430** Complete Cylinder Head



Wabco No: 9111539202

**RK.01.067.01** Repair Kit

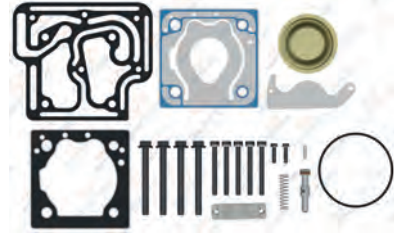

**RK.01.067.02** Repair Kit

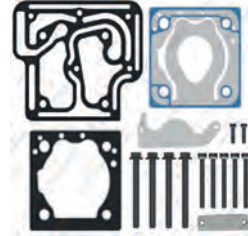

Wabco No: 9111549292

**RK.01.067** Repair Kit

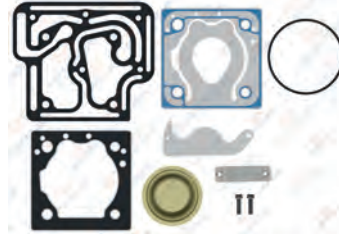

**RK.01.067.04** Repair Kit

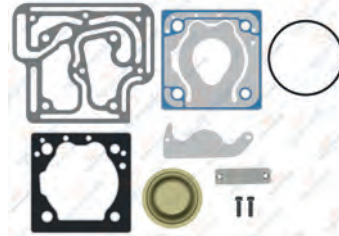

Use for old version cylinder repair kit. Yıpranmış kapaklar için.

**RK.01.067.06** Repair Kit



# FORD - BMC

## AIR COMPRESSOR AND REPAIR KIT

### 01.990 Cylinder Head

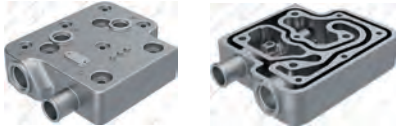

8 680437 029559

### 01.901 Valve Plate



8 680437 028178

### 01.1636 Crankshaft



8 680437 079811

### 00.999 Roller Bearing



6308



8 680437 009627

### 01.1222 Flange



8 680437 017844

Wabco No: 9111539252

### 01.272 Connecting Rod



8 680437 020400

### RK.01.104.00 Piston&Ring (Ø85,00 mm)

- RK.01.104.10 85,25 mm
- RK.01.104.20 85,50 mm
- RK.01.104.30 85,75 mm
- RK.01.104.40 86,00 mm



2.00x2.00x4.00



8 680437 060277

### 01.142.00 Piston (Ø85,00 mm)

- 01.142.10 85,25 mm
- 01.142.20 85,50 mm
- 01.142.30 85,75 mm
- 01.142.40 86,00 mm



2.00x2.00x4.00



8 680437 018674

Wabco No: 9115016242 - 9115016252

### 01.373.00 Ring (Ø85,00 mm)

- 01.373.10 85,25 mm
- 01.373.20 85,50 mm
- 01.373.30 85,75 mm
- 01.373.40 86,00 mm



2.00x2.00x4.00



8 680437 075431

Wabco No: 9115019202

### RK.01.513 Repair Kit

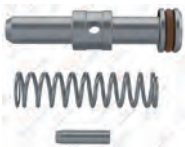

8 680437 066057

### 01.1225 Gear



8 680437 017875

Wabco No: 3942497 - 3940239

### 01.1643 Screw



M20X50 - Right Hand



8 680437 091073

## Twin Cylinder Compressor Ø86 mm- CC-Stroke mm

Application - Vehicle  
BMC  
PROCITY EURO6  
TEMSA AVENUE EURO6  
OTOKAR KENT EURO6



**01.04.191**

Oem. Ref. No.  
9P933187

Knorr No.  
LK4984-K068756N00



8 680437 127918



**01.1702** Crankcase



8 680437 127994

**RK.01.772.05** Repair Kit



8 680437 127970

Knorr No: K090939K50

**RK.01.772.06** Repair Kit



8 680437 127987

Knorr No: K091081K50

**RK.01.770**

Complete Cylinder Head



8 680437 127925

**RK.01.770.01**

Complete Cylinder Head



8 680437 127932

Knorr No: K090971K50

**RK.01.771**

Valve Plate Kit



8 680437 127949

Knorr No: K090953K50

**RK.01.772.01**

Repair Kit

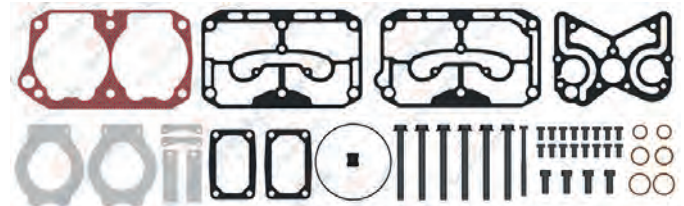

8 680437 127963

Knorr No: K090975K50

**RK.01.772**

Repair Kit

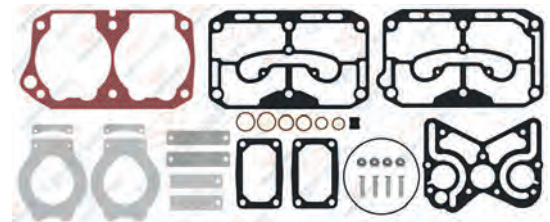

8 680437 127956



# FORD - BMC

## AIR COMPRESSOR AND REPAIR KIT

**01.1621** Cylinder Head



**01.1505** Cylinder Head



**01.1703** Crankshaft



**01.1704** Valve Plate



**01.1705** Cooling Plate

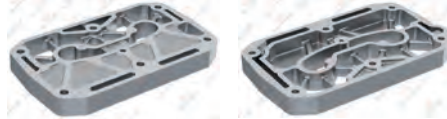

Knorr No: K068429

**01.226** Connecting Rod



Knorr No: SEB00967004

**RK.01.272.00** Piston&Ring (Ø86,00 mm)

- RK.01.272.10 86,25 mm
- RK.01.272.20 86,50 mm
- RK.01.272.30 86,75 mm
- RK.01.272.40 87,00 mm



2.00x2.00x3.00



Knorr No: SEB22547 - SEB22548

**01.868.00** Piston (Ø86,00 mm)

- 01.868.10 86,25 mm
- 01.868.20 86,50 mm
- 01.868.30 86,75 mm
- 01.868.40 87,00 mm



2.00x2.00x3.00



**01.869.00** Ring (Ø86,00 mm)

- 01.869.10 86,25 mm
- 01.869.20 86,50 mm
- 01.869.30 86,75 mm
- 01.869.40 87,00 mm



2.00x2.00x3.00



**01.1717** Crankshaft Flange

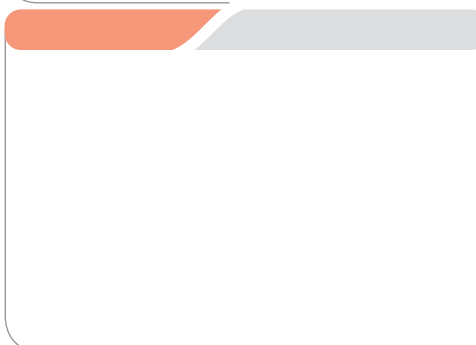

**RK.01.066**

Repair Kit

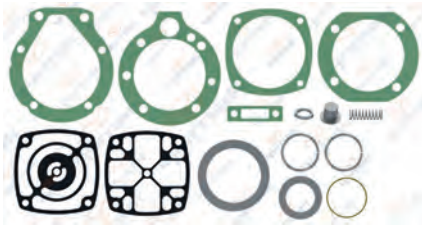

8 680437 059431

**RK.01.765**

Repair Kit



8 680437 128311

**RK.01.765.01**

Repair Kit

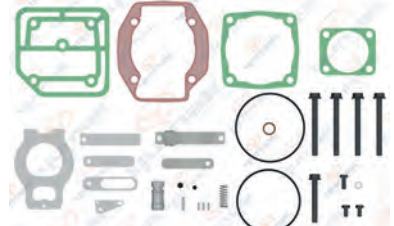

8 680437 128328

**RK.01.765.02**

Repair Kit

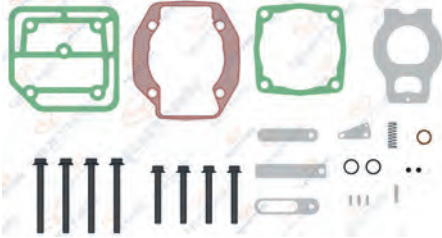

Knorr No: II313200061

8 680437 128335

**RK.01.765.03**

Repair Kit

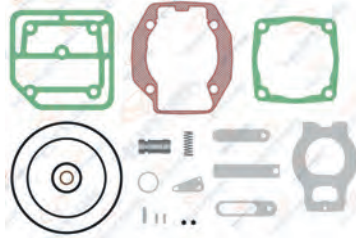

8 680437 128342

# FORD - BMC

AIR COMPRESSOR AND REPAIR KIT

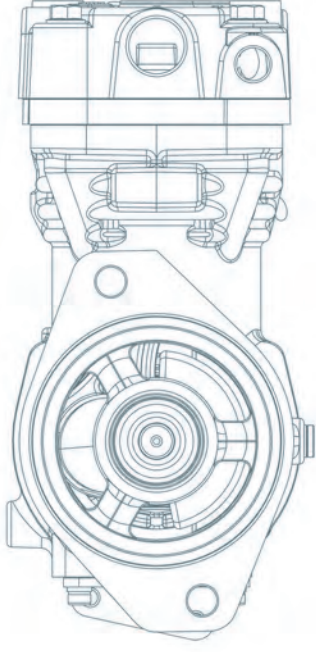

# MAGIRUS IKARUS PERKINS ISUZU

**HAVA KOMPRESÖRLERİ  
ve TAMİR TAKIMLARI**

AIR COMPRESSORS AND REPAIR KITS

# MAGIRUS IKARUS PERKINS ISUZU



MAGIRUS-IKARUS  
PERKINS-ISUZU

## Single Cylinder Compressor Ø80 mm-225 CC

Application - Vehicle  
PERKINS PHASER ENGINE



**01.04.131**

Oem. Ref. No.  
2488A292

Knorr No.  
LK3836-SEB01601



8 680437 080329



**01.1568**

Crankcase



8 680437 103653

**RK.01.159.17**

Repair Kit

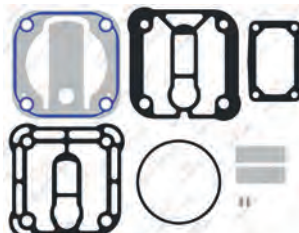

8 680437 119043

Knorr No: SEB22518\*\*

**RK.01.159.05**

Repair Kit

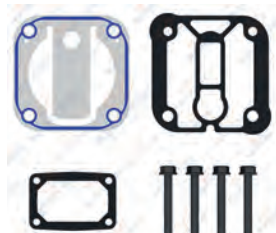

8 680437 120377

Knorr No: SEB018190051

**RK.01.273**

Complete Cylinder Head



8 680437 106302

**RK.01.638.02**

Valve Plate Kit



8 680437 112532

**RK.01.638**

Valve Plate Kit



8 680437 071365

**RK.01.159.03**

Repair Kit

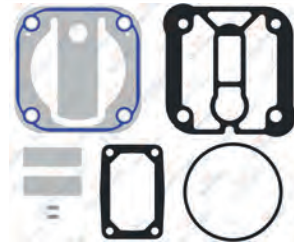

8 680437 072638

**RK.01.159.28**

Repair Kit

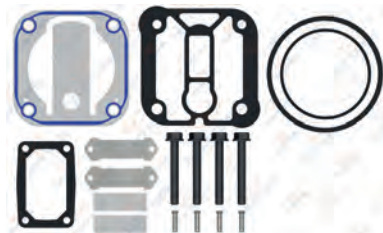

8 680437 122296



# MAGIRUS-IKARUS-PERKINS-ISUZU

## AIR COMPRESSOR AND REPAIR KIT

01.1291

Cylinder Head



8 680437 078258

01.1290

Valve Plate



8 680437 071624

01.1338

Crankshaft



5/8 - 18 UNF



8 680437 109372

01.820

Bushing



42x38x25



8 680437 027058

01.1389

Crankshaft Flange



8 680437 072096

01.1101

Connecting Rod



8 680437 016069

RK.01.601.00

Piston&Ring (Ø80,00 mm)

RK.01.601.10	80,25 mm
RK.01.601.20	80,50 mm
RK.01.601.30	80,75 mm
RK.01.601.40	81,00 mm



2.50x2.50x4,00



8 680437 067054

01.1201

Piston (Ø80,00 mm)

01.1201.10	80,25 mm
01.1201.20	80,50 mm
01.1201.30	80,75 mm
01.1201.40	81,00 mm

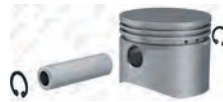

2.50x2.50x4,00



8 680437 017530

01.1226

Ring (Ø80,00 mm)

01.1226.10	80,25 mm
01.1226.20	80,50 mm
01.1226.30	80,75 mm
01.1226.40	81,00 mm



2.50x2.50x4,00



8 680437 017882

RK.01.159.04

Repair Kit

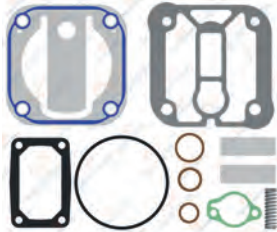

8 680437 061489

Use for old version cylinder repair kit.  
Yıpranmış kapaklar için.

01.374

Cover



8 680437 077022

## Single Cylinder Compressor Ø80 mm-225 CC

Application - Vehicle  
PERKINS PHASER ENGINE



**01.04.163**

Knorr No.  
LK3834-SEB01597



**01.1568** Crankcase



**RK.01.159.20** Repair Kit

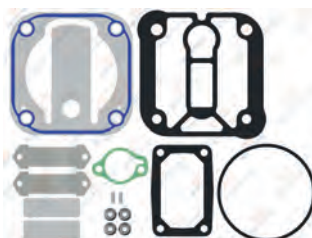

**RK.01.159.22** Repair Kit

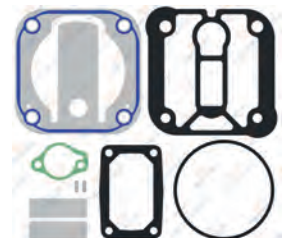

**RK.01.615**

Complete Cylinder Head



**RK.01.616.01**

Repair Kit



**RK.01.616**

Repair Kit



Oem. No: 9P918391  
Knorr No: SEB01593004

**RK.01.159.01**

Repair Kit



**RK.01.159**

Repair Kit

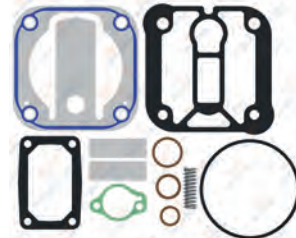

# MAGIRUS-IKARUS-PERKINS-ISUZU

## AIR COMPRESSOR AND REPAIR KIT

01.1208

Cylinder Head



8 680437 017646

01.1219

Valve Plate



8 680437 017776

01.1338

Crankshaft



5/8 - 18 UNF



8 680437 109372

01.820

Bushing



42x38x25



8 680437 027058

01.1389

Crankshaft Flange



8 680437 072096

01.1101

Connecting Rod



8 680437 016069

RK.01.601

Piston&Ring (Ø80,00 mm)

RK.01.601.10 80,25 mm

RK.01.601.20 80,50 mm

RK.01.601.30 80,75 mm

RK.01.601.40 81,00 mm



2.50x2.50x4,00



8 680437 067054

01.1201

Piston (Ø80,00 mm)

01.1201.10 80,25 mm

01.1201.20 80,50 mm

01.1201.30 80,75 mm

01.1201.40 81,00 mm



2.50x2.50x4,00



8 680437 017530

01.1226

Ring (Ø80,00 mm)

01.1226.10 80,25 mm

01.1226.20 80,50 mm

01.1226.30 80,75 mm

01.1226.40 81,00 mm



2.50x2.50x4,00



8 680437 017882

RK.01.159.04

Repair Kit

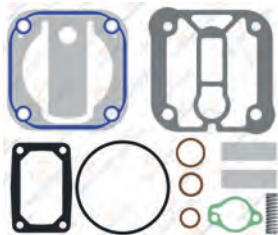

8 680437 061489

01.374

Cover



8 680437 077022



## Twin Cylinder Compressor Ø88 mm-600 cc-Stroke 50 mm

Application - Vehicle  
PERKINS



### 01.04.011

Oem. No.  
OE52096

Knorr No.  
LP4934  
II30895



01.228

Crankcase



RK.01.083

Repair Kit

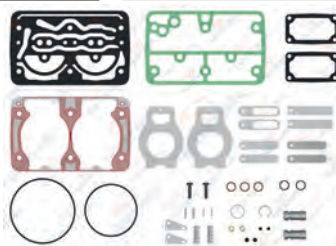

RK.01.309 Complete Cylinder Head



RK.01.309.20

Complete Cylinder Head

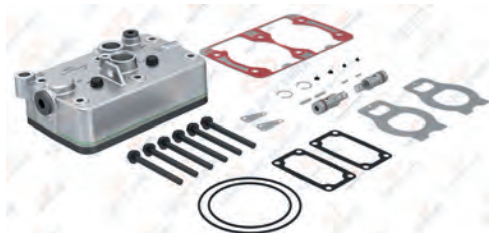

RK.01.082.20

Valve Plate Kit

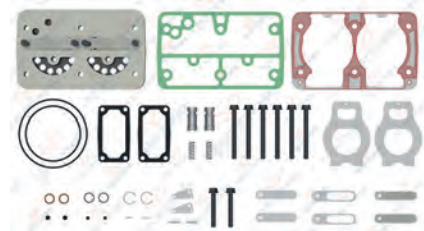

RK.01.082

Valve Plate Kit

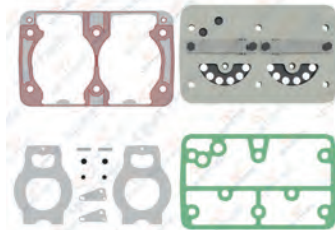

RK.01.083.01

Repair Kit

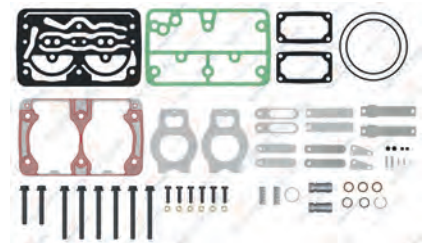

RK.01.083.03

Repair Kit



# MAGIRUS-IKARUS-PERKINS-ISUZU

## AIR COMPRESSOR AND REPAIR KIT

01.225

Cylinder Head



8 680437 019800

RK.01.309.01

Complete Cylinder Head

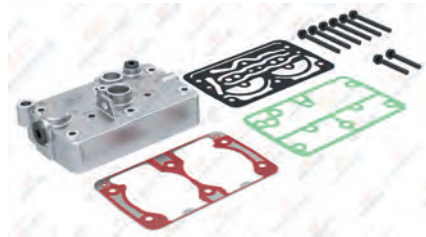

OEM No : 3097144  
Knorr No : SEB01052004 - K070845K50

01.227

Crankshaft



M20X1.5 Right Hand



8 680437 019831

RK.01.082.02

Valve Plate Kit



OEM No : 3097146  
Knorr No : SEB01033004

01.288

Crankshaft Flange



OEM No : 3097150  
Knorr No : I1159920065

01.226

Connecting Rod



OEM No : 3097151  
Knorr No : SEB00967004

RK.01.034.00

Piston&Ring (Ø88,00 mm)

RK.01.034.10 88,25 mm

RK.01.034.20 88,50 mm

RK.01.034.30 88,75 mm

RK.01.034.40 89,00 mm



2,50x2,50x4,00



OEM No : 85101375-3095841-1698848  
Knorr No : SEB22555 - I81169004

01.110.00

Piston (Ø88,00 mm)

01.110.10 88,25 mm

01.110.20 88,50 mm

01.110.30 88,75 mm

01.110.40 89,00 mm



2,50x2,50x4,00



8 680437 015994

01.136.00

Ring (Ø88,00 mm)

01.136.10 88,25 mm

01.136.20 88,50 mm

01.136.30 88,75 mm

01.136.40 89,00 mm



2,50x2,50x4,00



Knorr No : I139526F0061

01.292

Bushing



42X38X25



8 680437 073871

01.414

Cover



8 680437 022312

01.144

Nut



M20X1.5 Right Hand



OEM No : 1698672

RK.01.083.20

Repair Kit

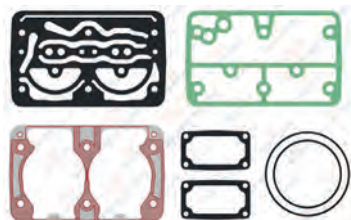

Knorr No : SEB22561\*

RK.01.088.20

Repair Kit



OEM No : 3091739  
Knorr No : I1326840061

RK.01.088

Repair Kit



8 680437 059943

RK.01.126

Repair Kit



OEM No : 3097147  
Knorr No : I1159920063



## Single Cylinder Compressor Ø75 mm-300 CC-Stroke 50 mm

Application - Vehicle  
MAGIRUS M130 / 160 / 170



**01.05.001**

**Knorr No.**  
LK1500-I77107  
LK1503-I78519  
LK1504-I78520



**01.313** Crankcase



**RK.01.046.21** Repair Kit

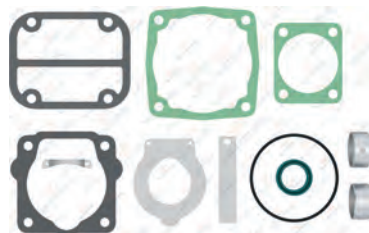

**RK.01.046** Repair Kit

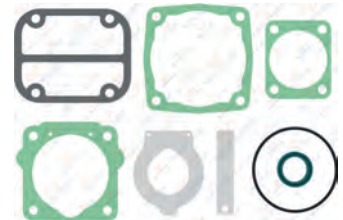

**RK.01.048** Complete Cylinder Head



**Knorr No:** STW63841

**RK.01.048.20** Complete Cylinder Head

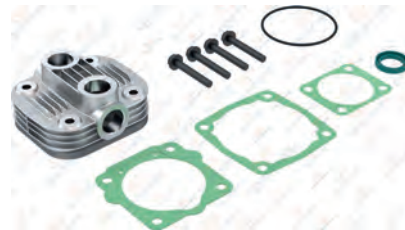

**RK.01.047.20** Valve Plate Kit

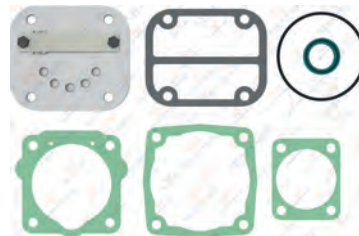

**RK.01.047** Valve Plate Kit



**RK.01.046.01** Repair Kit

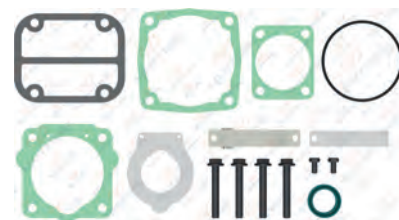



# MAGIRUS-IKARUS-PERKINS-ISUZU

## AIR COMPRESSOR AND REPAIR KIT

01.067

Cylinder Head



Knorr No: II38602F004

01.119

Valve Plate



01.089

Crankshaft



Strong 17.5 mm  
M18X1.5 - Right Hand



01.013

Bushing



34X30X16



01.066

Crankshaft Flange



01.003

Connecting Rod



RK.01.073.00

Piston&Ring (Ø75,00 mm)

RK.01.073.10 75,25 mm

RK.01.073.20 75,50 mm

RK.01.073.30 75,75 mm

RK.01.073.40 76,00 mm



2.00x2.00x4.00



Knorr No: SEB22539 - SEB22540

01.193.00

Piston (Ø75,00 mm)

01.193.10 75,25 mm

01.193.20 75,50 mm

01.193.30 75,75 mm

01.193.40 76,00 mm



2.00x2.00x4.00



01.134.00

Ring (Ø75,00 mm)

01.134.10 75,25 mm

01.134.20 75,50 mm

01.134.30 75,75 mm

01.134.40 76,00 mm



2.00x2.00x4.00



RK.01.045

Cylinder Liner Set



Knorr No: ZB4265 - I77246

01.056

Cylinder Liner



01.073

Cover



RK.01.046.02

Repair Kit

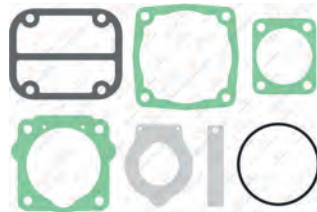

00.140

Roller Bearing



6305



## Single Cylinder Compressor Ø75 mm-155 CC-Stroke 35 mm

Application - Vehicle  
MAGIRUS M130 / 160 / 170



**01.05.078**

Knorr No.  
LK1517  
LK1520  
LK1521  
LK1522



**01.313** Crankcase



**RK.01.046.21** Repair Kit

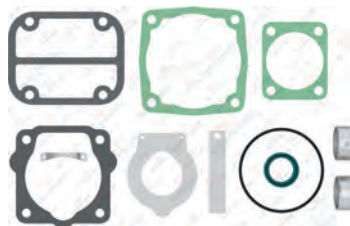

**RK.01.046** Repair Kit

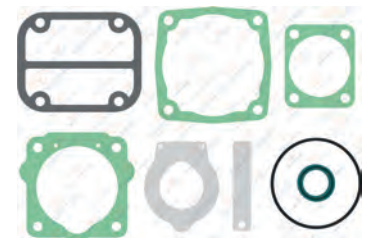

**RK.01.048** Complete Cylinder Head



Knorr No: STW63841

**RK.01.048.20** Complete Cylinder Head

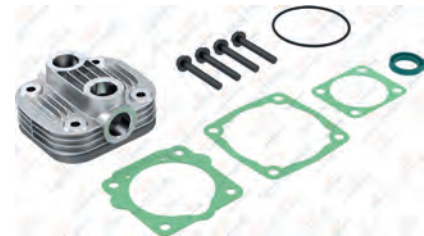

**RK.01.047.20** Valve Plate Kit

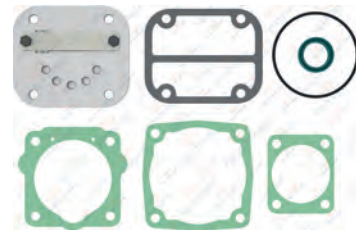

**RK.01.047** Valve Plate Kit



**RK.01.046.01** Repair Kit

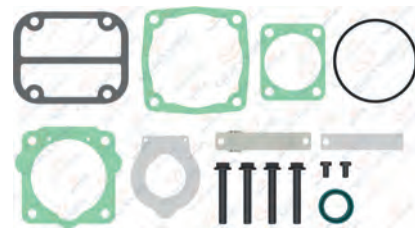

# MAGIRUS-IKARUS-PERKINS-ISUZU

## AIR COMPRESSOR AND REPAIR KIT

01.067

Cylinder Head



Knorr No: II38602F004

01.119

Valve Plate



01.089

Crankshaft



Strong 17.5 mm  
M18X1.5 - Right Hand



01.013

Bushing



34X30X16



01.066

Crankshaft Flange



01.003

Connecting Rod



RK.01.073

Piston&Ring (Ø75,00 mm)

RK.01.073.10 75,25 mm

RK.01.073.20 75,50 mm

RK.01.073.30 75,75 mm

RK.01.073.40 76,00 mm



2.00x2.00x4.00



Knorr No: SEB22539 - SEB22540

01.193

Piston (Ø75,00 mm)

01.193.10 75,25 mm

01.193.20 75,50 mm

01.193.30 75,75 mm

01.193.40 76,00 mm



2.00x2.00x4.00



01.134

Ring (Ø75,00 mm)

01.134.10 75,25 mm

01.134.20 75,50 mm

01.134.30 75,75 mm

01.134.40 76,00 mm



2.00x2.00x4.00



RK.01.045

Cylinder Liner Set



Knorr No: ZB4265 - I77246

01.056

Cylinder Liner



01.409

Pump Support



RK.01.046.02

Repair Kit

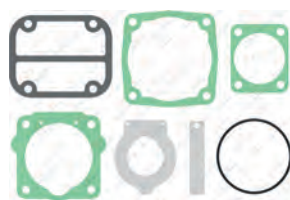

01.143

Nut



M18X1.5 - Right Hand



00.140

Roller Bearing



6305





## Single Cylinder Compressor Ø88 mm-300 CC-Stroke 50 mm

Application - Vehicle  
MAGIRUS M130 / 160 / 170



**01.05.084**

**Knorr No.**

LK1523-I84953  
LK1534-I92972  
LK1543-I97495  
LK1545-I98498  
LK1560-II17393



**01.313** Crankcase



**RK.01.046.21** Repair Kit

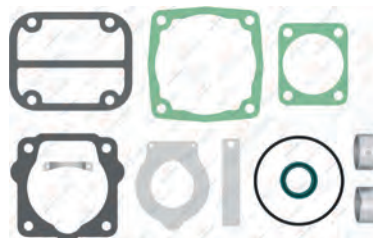

**RK.01.046** Repair Kit

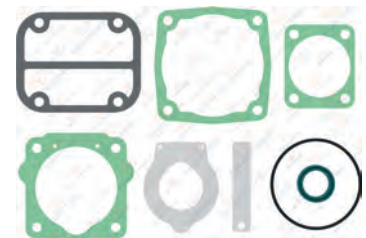

**RK.01.048** Complete Cylinder Head



Knorr No: STW63841

**RK.01.048.20** Complete Cylinder Head



**RK.01.047.20** Valve Plate Kit

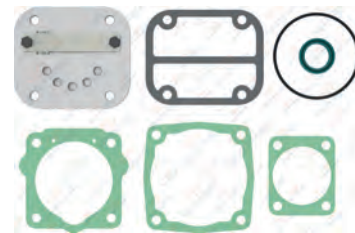

**RK.01.047** Valve Plate Kit



**RK.01.046.01** Repair Kit

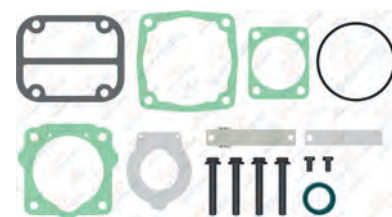

# MAGIRUS-IKARUS-PERKINS-ISUZU

## AIR COMPRESSOR AND REPAIR KIT

01.067

Cylinder Head



Knorr No: II38602F004

01.119

Valve Plate



01.089

Crankshaft



Strong 17.5 mm  
M18X1.5 - Right Hand



01.013

Bushing



34X30X16



01.066

Crankshaft Flange



01.003

Connecting Rod



RK.01.073

Piston&Ring (Ø75,00 mm)

RK.01.073.10	75,25 mm
RK.01.073.20	75,50 mm
RK.01.073.30	75,75 mm
RK.01.073.40	76,00 mm



2.00x2.00x4.00



Knorr No: SEB22539 - SEB22540

01.193

Piston (Ø75,00 mm)

01.193.10	75,25 mm
01.193.20	75,50 mm
01.193.30	75,75 mm
01.193.40	76,00 mm



2.00x2.00x4.00



01.134

Ring (Ø75,00 mm)

01.134.10	75,25 mm
01.134.20	75,50 mm
01.134.30	75,75 mm
01.134.40	76,00 mm



2.00x2.00x4.00



RK.01.045

Cylinder Liner Set



Knorr No: ZB4265 - I77246

01.056

Cylinder Liner



01.073

Cover



RK.01.046.02

Repair Kit

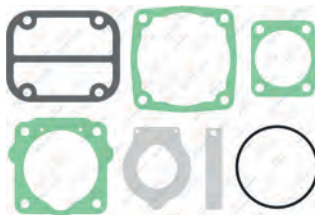

01.143

Nut



M18X1.5 - Right Hand



00.140

Roller Bearing



6305



## Single Cylinder Compressor Ø75 mm-155 CC-Stroke 35 mm

Application - Vehicle  
MAGIRUS M130 / 160 / 170



**01.05.085**

Knorr No.  
LK1524-I85395



**01.314** Crankcase

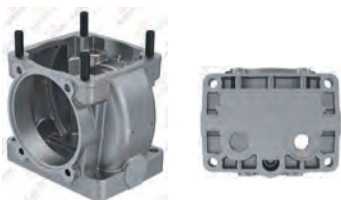

**RK.01.046.21** Repair Kit

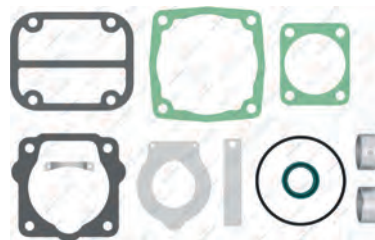

**RK.01.046** Repair Kit

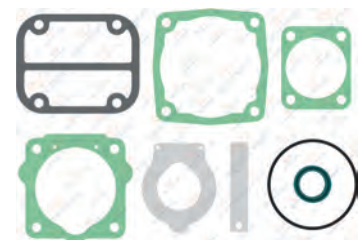

**RK.01.048** Complete Cylinder Head



Knorr No: STW63841

**RK.01.048.20** Complete Cylinder Head

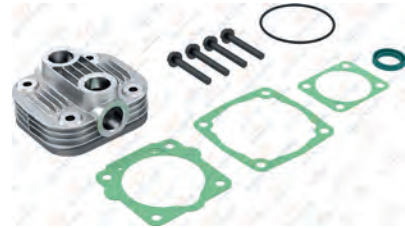

**RK.01.047.20** Valve Plate Kit

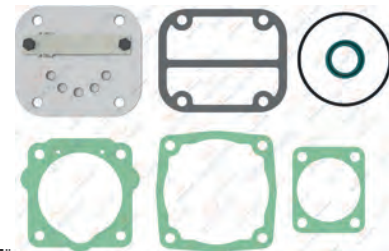

**RK.01.047** Valve Plate Kit



**RK.01.046.01** Repair Kit

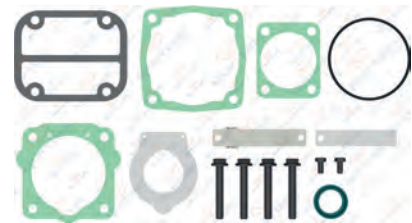



# MAGIRUS-IKARUS-PERKINS-ISUZU

## AIR COMPRESSOR AND REPAIR KIT

01.067

Cylinder Head



Knorr No: II38602F004

01.119

Valve Plate



01.089

Crankshaft



M18X1.5 - Right Hand



01.013

Bushing



34X30X16



01.066

Crankshaft Flange



01.003

Connecting Rod



RK.01.073

Piston&Ring (Ø75,00 mm)

RK.01.073.10 75,25 mm

RK.01.073.20 75,50 mm

RK.01.073.30 75,75 mm

RK.01.073.40 76,00 mm



2.00x2.00x4.00



Knorr No: SEB22539 - SEB22540

01.193

Piston (Ø75,00 mm)

01.193.10 75,25 mm

01.193.20 75,50 mm

01.193.30 75,75 mm

01.193.40 76,00 mm



2.00x2.00x4.00



01.134

Ring (Ø75,00 mm)

01.134.10 75,25 mm

01.134.20 75,50 mm

01.134.30 75,75 mm

01.134.40 76,00 mm



2.00x2.00x4.00



RK.01.045

Cylinder Liner Set



Knorr No: ZB4265 - I77246

01.056

Cylinder Liner



01.073

Cover



RK.01.046.02

Repair Kit

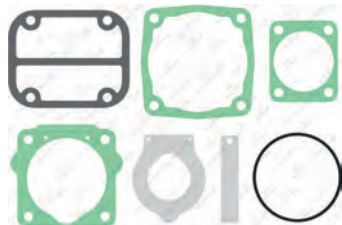

01.143

Nut



M18X1.5 - Right Hand



00.140

Roller Bearing



6305



## Single Cylinder Compressor Ø88 mm-300 CC-Stroke 50 mm

Application - Vehicle  
IRISBUS KAROSA  
Series 900 E - Series 900 - Series 700



**01.04.086**

Knorr No.  
LK3993  
LK3963  
K001611



**01.085**

Crankcase

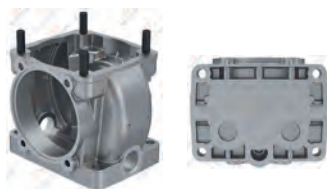

**RK.01.148.02**

Repair Kit

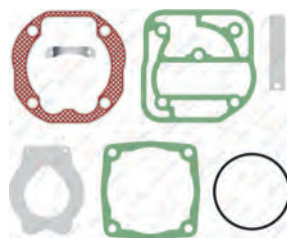

**RK.01.068** Complete Cylinder Head



Knorr No: ZB4275 - I88057

**RK.01.068.01**

Complete Cylinder Head



Knorr No: ZB4275\* - I88057\*

**RK.01.035.01**

Valve Plate Kit

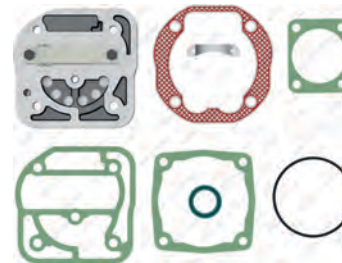

**RK.01.035.02**

Valve Plate Kit



**RK.01.148**

Repair Kit

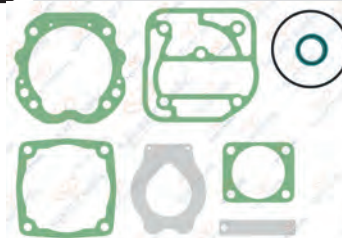

**RK.01.148.03**

Repair Kit



# MAGIRUS-IKARUS-PERKINS-ISUZU

## AIR COMPRESSOR AND REPAIR KIT

01.076

Cylinder Head



8 680437 014164

01.139

Valve Plate



8 680437 018537

01.099

Crankshaft



M18X1.5 - Right Hand



8 680437 014560

01.013

Bushing



34X30X16



8 680437 009993

01.066

Crankshaft Flange



8 680437 015976

01.008

Connecting Rod



8 680437 009795

RK.01.034

Piston&Ring (Ø88,00 mm)

RK.01.034.10	88,25 mm
RK.01.034.20	88,50 mm
RK.01.034.30	88,75 mm
RK.01.034.40	89,00 mm



2.50x2,50x4,00



8 680437 058816

Knorr No: I81169004

01.110

Piston (Ø88,00 mm)

01.110.10	88,25 mm
01.110.20	88,50 mm
01.110.30	88,75 mm
01.110.40	89,00 mm



2.50x2,50x4,00



8 680437 015994

01.136

Ring (Ø88,00 mm)

01.136.10	88,25 mm
01.136.20	88,50 mm
01.136.30	88,75 mm
01.136.40	89,00 mm



2.50x2,50x4,00



8 680437 018384

RK.01.032

Cylinder Liner Set



8 680437 058779

Knorr No: I789790061 - 81541056009

01.057

Cylinder Liner



8 680437 013181

01.073

Cover



8 680437 014133

RK.01.148.05

Repair Kit

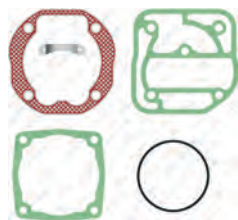

8 680437 120209

01.143

Nut



M18X1.5 - Right Hand



8 680437 018735

00.140

Roller Bearing



6305



8 680437 001577



## Single Cylinder Compressor Ø75 mm-155 CC-Stroke 35 mm

Application - Vehicle  
MAGIRUS M130 / 160 / 170



**01.05.089**

Knorr No.  
LK1553-II17251  
LK1559-II17257



8 680437 012955



**01.085** Crankcase

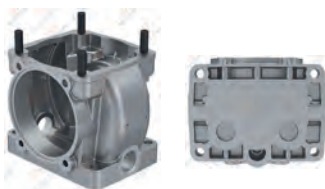

8 680437 014331

**RK.01.046.21** Repair Kit

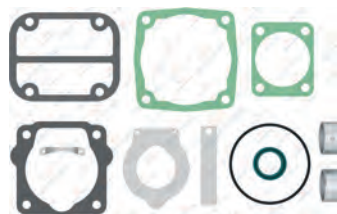

8 680437 120766

**RK.01.048** Complete Cylinder Head



8 680437 059042

Knorr No: STW63841

**RK.01.048.20** Complete Cylinder Head



8 680437 106265

**RK.01.047.20** Valve Plate Kit

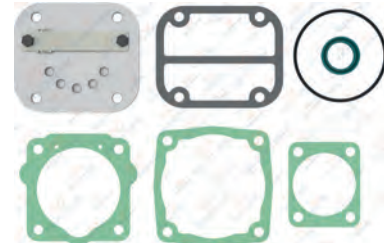

8 680437 112884

**RK.01.047** Valve Plate Kit



8 680437 078739

**RK.01.046.01** Repair Kit

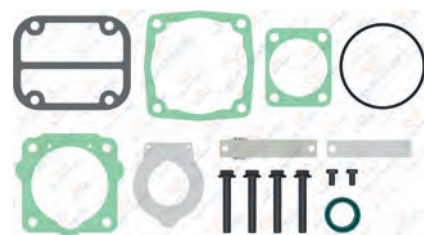

8 680437 059028

**RK.01.046** Repair Kit

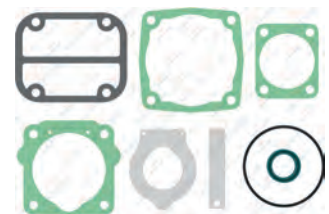

8 680437 078647

# MAGIRUS-IKARUS-PERKINS-ISUZU

## AIR COMPRESSOR AND REPAIR KIT

01.067

Cylinder Head

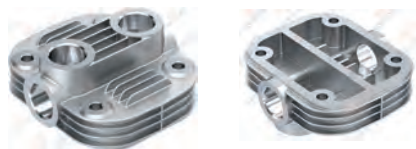

Knorr No: II38602F004

01.119

Valve Plate



01.089

Crankshaft



M18X1.5 - Right Hand



01.013

Bushing



34X30X16



01.066

Crankshaft Flange



01.003

Connecting Rod



RK.01.073

Piston&Ring (Ø75,00 mm)

RK.01.073.10	75,25 mm
RK.01.073.20	75,50 mm
RK.01.073.30	75,75 mm
RK.01.073.40	76,00 mm



2.00x2.00x4.00



Knorr No: SEB22539 - SEB22540

01.193

Piston (Ø75,00 mm)

01.193.10	75,25 mm
01.193.20	75,50 mm
01.193.30	75,75 mm
01.193.40	76,00 mm



2.00x2.00x4.00



01.134

Ring (Ø75,00 mm)

01.134.10	75,25 mm
01.134.20	75,50 mm
01.134.30	75,75 mm
01.134.40	76,00 mm



2.00x2.00x4.00



RK.01.045

Cylinder Liner Set



Knorr No: ZB4265 - I77246

01.056

Cylinder Liner



01.073

Cover



RK.01.046.02

Repair Kit

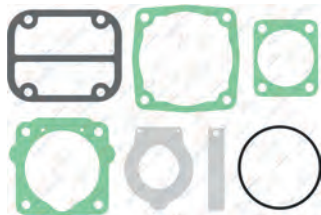

01.143

Nut



M18X1.5 - Right Hand



00.140

Roller Bearing



6305



## Single Cylinder Compressor Ø88 mm-300 CC-Stroke 50 mm

Application - Vehicle  
IKARUS  
DAEWOO BH115



**01.04.009**

Knorr No.  
LP3927-I76067



**01.338** Crankcase

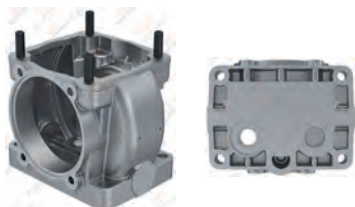

**RK.01.148.02** Repair Kit

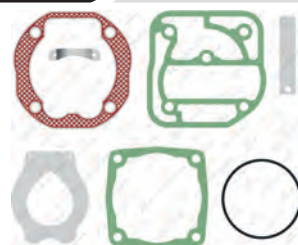

**RK.01.148.03** Repair Kit



**RK.01.068**

Complete Cylinder Head



Knorr No: ZB4275 - I88057

**RK.01.068.01**

Complete Cylinder Head

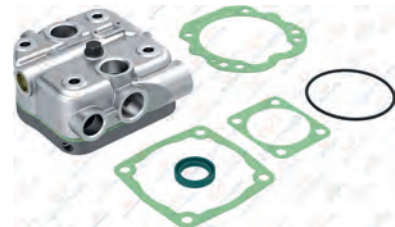

Knorr No: ZB4275\* - I88057\*

**RK.01.035.01**

Valve Plate Kit

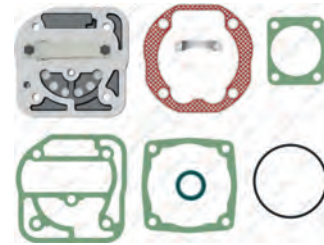

**RK.01.035.02**

Valve Plate Kit



**RK.01.148**

Repair Kit

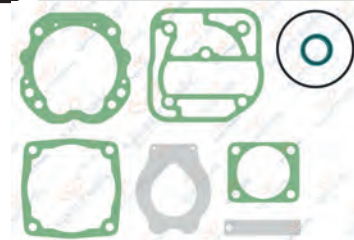



# MAGIRUS-IKARUS-PERKINS-ISUZU

## AIR COMPRESSOR AND REPAIR KIT

01.076

Cylinder Head



8 680437 014164

01.646

Valve Plate



8 680437 025122

01.099

Crankshaft



M18X1.5 - Right Hand



8 680437 014560

00.140

Roller Bearing



6305



8 680437 001577

01.066

Crankshaft Flange



8 680437 015976

01.008

Connecting Rod



8 680437 009795

RK.01.034

Piston&Ring (Ø88,00 mm)

RK.01.034.10	88,25 mm
RK.01.034.20	88,50 mm
RK.01.034.30	88,75 mm
RK.01.034.40	89,00 mm



2.50x2,50x4,00



8 680437 058816

Knorr No: I81169004

01.110

Piston (Ø88,00 mm)

01.110.10	88,25 mm
01.110.20	88,50 mm
01.110.30	88,75 mm
01.110.40	89,00 mm



2.50x2,50x4,00



8 680437 015994

01.136

Ring (Ø88,00 mm)

01.136.10	88,25 mm
01.136.20	88,50 mm
01.136.30	88,75 mm
01.136.40	89,00 mm



2.50x2,50x4,00



8 680437 018384

RK.01.032

Cylinder Liner Set



8 680437 058779

Knorr No: I789790061 - 81541056009

01.057

Cylinder Liner



8 680437 013181

01.143

Nut



M18X1.5 - Right Hand



8 680437 018735

RK.01.143

Repair Kit

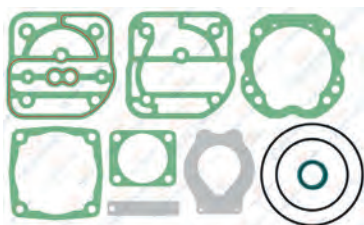

8 680437 061168

RK.01.143.01

Repair Kit

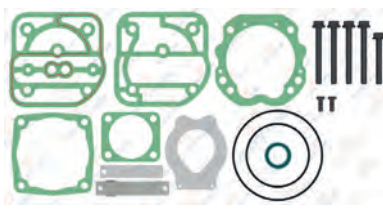

8 680437 061182

RK.01.143.02

Repair Kit

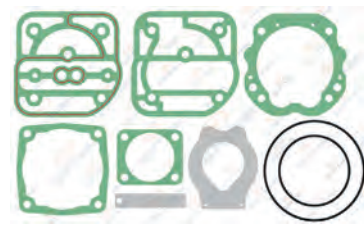

8 680437 075530

## Single Cylinder Compressor Ø88 mm-300 CC-Stroke 50 mm

### Application - Vehicle

DAEWOO BH115 IKARUS 260/00-260/01-260/02-260/03-260/04-260/06-260/13-260/17-260/18-260/20-260/22-260/25-260/27-260/29-260/32-260/36-260/39-260/42260/43-260/44-260/45 RABA S16- S22- 831



**01.04.010**

**Knorr No.**  
LP3940-II14385



8 680437 010838



**01.313** Crankcase



8 680437 020929

**RK.01.148.02** Repair Kit

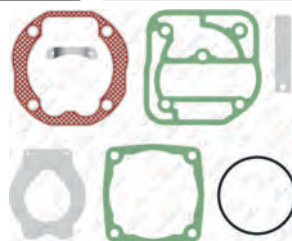

8 680437 006978

**RK.01.068** Complete Cylinder Head



**Knorr No:** ZB4275 - I88057

**RK.01.068.01** Complete Cylinder Head

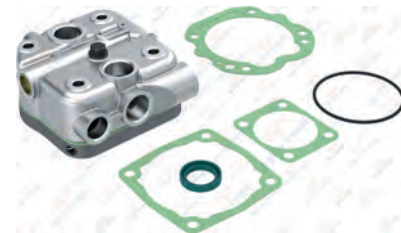

**Knorr No:** ZB4275\* - I88057\*

**RK.01.035.01** Valve Plate Kit

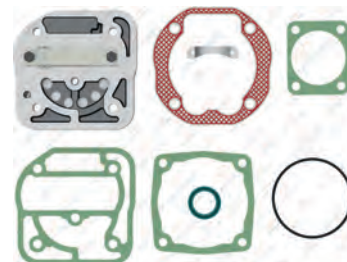

8 680437 112426

**RK.01.035.02** Valve Plate Kit



8 680437 112433

**RK.01.148** Repair Kit

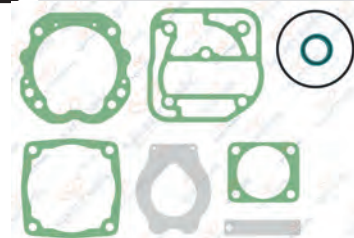

8 680437 061236

**RK.01.148.03** Repair Kit



8 680437 120193

# MAGIRUS-IKARUS-PERKINS-ISUZU

## AIR COMPRESSOR AND REPAIR KIT

01.076

Cylinder Head



8 680437 014164

01.139

Valve Plate



8 680437 018537

01.099

Crankshaft



M18X1.5 - Right Hand



8 680437 014560

01.013

Bushing



34X30X16



8 680437 009993

01.066

Crankshaft Flange



8 680437 015976

01.381

Connecting Rod



8 680437 021926

RK.01.034

Piston&Ring (Ø88,00 mm)

RK.01.034.10 88,25 mm

RK.01.034.20 88,50 mm

RK.01.034.30 88,75 mm

RK.01.034.40 89,00 mm



2.50x2,50x4,00



8 680437 058816

Knorr No: I81169004

01.110

Piston (Ø88,00 mm)

01.110.10 88,25 mm

01.110.20 88,50 mm

01.110.30 88,75 mm

01.110.40 89,00 mm



2.50x2,50x4,00



8 680437 015994

01.136

Ring (Ø88,00 mm)

01.136.10 88,25 mm

01.136.20 88,50 mm

01.136.30 88,75 mm

01.136.40 89,00 mm



2.50x2,50x4,00



8 680437 018384

RK.01.128

Cylinder Liner Set



8 680437 060666

01.357

Cylinder Liner



8 680437 021506

01.073

Cover



8 680437 014133

RK.01.148.05

Repair Kit



8 680437 120209

01.143

Nut



M18X1.5 - Right Hand



8 680437 018735

00.140

Roller Bearing



6305



8 680437 001577



# Single Cylinder Compressor Ø65 mm-76 CC-Stroke 23 mm

Application - Vehicle  
ISUZU



**01.09.001**

Oem. Ref. No.  
5000048155

Wabco No.  
9110047250  
9110048960



8 680437 014409



**01.624**

Crankcase



8 680437 024880

**01.625**

Cover



8 680437 024905

Wabco No: 9110226522

**RK.01.664**

Complete Cylinder Head



8 680437 105510

**RK.01.477**

Valve Plate Kit



8 680437 065647

**RK.01.203**

Repair Kit

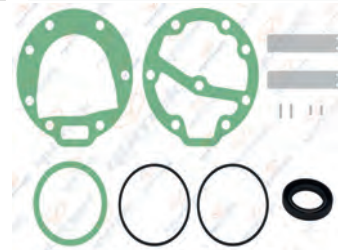

8 680437 062134

**RK.01.214**

Repair Kit

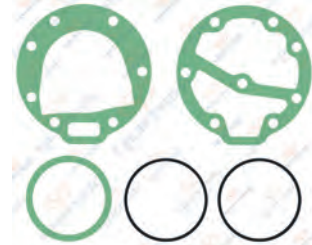

8 680437 062271

**RK.01.215**

Repair Kit



8 680437 062288

# MAGIRUS-IKARUS-PERKINS-ISUZU

## AIR COMPRESSOR AND REPAIR KIT

01.616

Cylinder Head



Wabco No: 9110046514

01.628

Crankshaft Flange



Wabco No: 9119016612

01.629

Crankshaft



M18X1.5 - Right Hand



Wabco No: 9110046934

01.617

Cooling Plate



01.626

Crankshaft Flange



Wabco No: 9119016622

01.620

Connecting Rod



RK.01.231.00

Piston&Ring (Ø65,00 mm)

RK.01.231.10 65,25 mm

RK.01.231.20 65,50 mm

RK.01.231.30 65,75 mm

RK.01.231.40 66,00 mm



2.50x2,50x4,00x4,00



01.608.00

Piston (Ø65,00 mm)

01.608.10 65,25 mm

01.608.20 65,50 mm

01.608.30 65,75 mm

01.608.40 66,00 mm



2.50x2,50x4,00x4,00



01.611.00

Ring (Ø65,00 mm)

01.611.10 65,25 mm

01.611.20 65,50 mm

01.611.30 65,75 mm

01.611.40 66,00 mm



2.50x2,50x4,00x4,00



00.138

Roller Bearing



6206



01.1929

Bushing



34X30X18



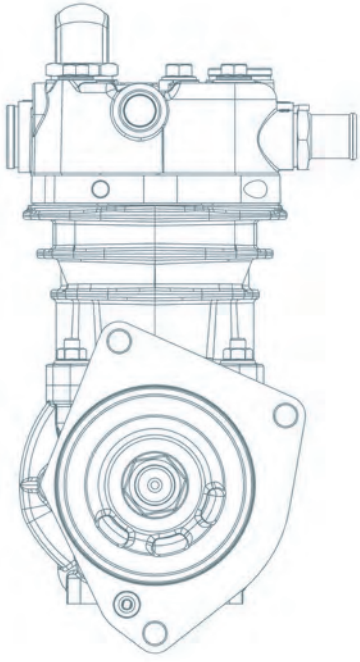

**CUMMINS - MACK**  
**VOLKSWAGEN**  
**JOHN DEERE**  
**FORD BRASIL**  
**CATERPILLAR**

**HAVA KOMPRESÖRLERİ**  
**ve TAMİR TAKIMLARI**

AIR COMPRESSORS AND REPAIR KITS



**CUMMINS  
VOLKSWAGEN  
JOHN DEERE  
FORD BRASIL  
CATERPILLAR  
MACK**



CUMMINS  
MACK-FORD  
VOLKSWAGEN

## Single Cylinder Compressor Ø75 mm - 160 CC - Stroke 36 mm

**Application - Vehicle**  
JOHN DEERE TRACTORS  
1550-1750-1850-1950-2250  
2450-2650-2850-3050-3350-3650  
NEW HOLLAND



**01.05.012**

Oem. No.	Wabco No.
04415517	4111410000
82003029	
1517932	
01173877	
AL68237	



**01.235** Crankcase



**RK.01.087.20** Repair Kit

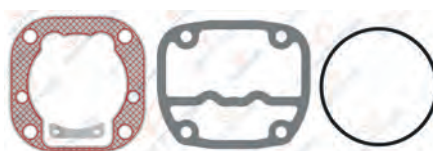

**RK.01.084** Complete Cylinder Head



**RK.01.085** Valve Plate Kit



**RK.01.087.01** Repair Kit



**RK.01.087** Repair Kit



**RK.01.087.02** Repair Kit

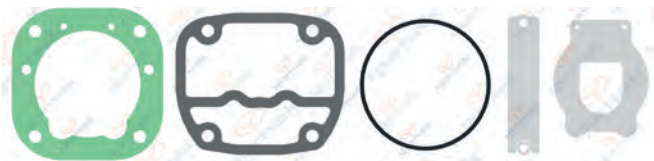

**RK.01.087.21** Repair Kit

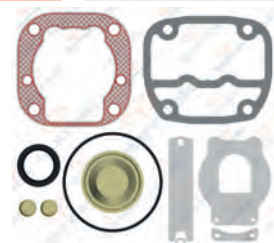

# CUMMINS-VOLKSWAGEN-JOHN DEERE FORD BRASIL-CATERPILLAR-MACK

## AIR COMPRESSOR AND REPAIR KIT

01.229

Cylinder Head

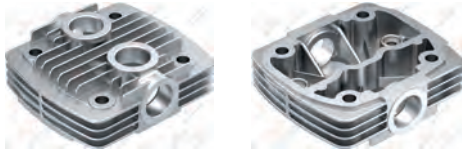

8 680437 019862

01.909

Valve Plate



8 680437 028253

01.1254

Crankshaft



M18x1.5 Right Hand



8 680437 076759

01.437

Bushing



39X35X20



8 680437 022589

OEM No : 066975 - 1253536 - 1304463

01.234

Crankshaft Flange



8 680437 019916

Wabco No : 4111419232

01.230

Connecting Rod



8 680437 072935

RK.01.118.00

Piston&Ring (Ø75,00 mm)

- RK.01.118.10 75,25 mm
- RK.01.118.20 75,50 mm
- RK.01.118.30 75,75 mm
- RK.01.118.40 76,00 mm



2,00x2,00x4,00



8 680437 060482

Wabco No : 4111416232 - 4115226202

01.911.00

Piston (Ø75,00 mm)

- 01.911.10 75,25 mm
- 01.911.20 75,50 mm
- 01.911.30 75,75 mm
- 01.911.40 76,00 mm



2,00x2,00x4,00



8 680437 028277

01.134.00

Ring (Ø75,00 mm)

- 01.134.10 75,25 mm
- 01.134.20 75,50 mm
- 01.134.30 75,75 mm
- 01.134.40 76,00 mm



2,00x2,00x4,00



8 680437 018278

RK.01.087.22

Repair Kit



8 680437 120933

RK.01.087.05

Repair Kit

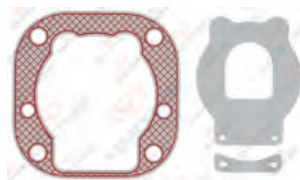

8 680437 128434

01.515

Cover



8 680437 116165



## Single Cylinder Compressor Ø85 mm-18 CC-Stroke 56 mm

Application - Vehicle  
CUMMINS ISX ENGINE



**01.04.177**

Oem. Ref. No.  
3687343  
3104216RX

Wabco No.  
9111536070

**01.04.177.10**

Without Gear



**01.1594**

Crankcase



**RK.01.067.05**

Repair Kit

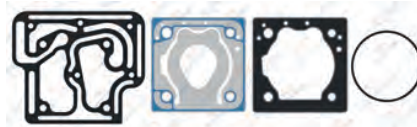

**RK.01.483** Complete Cylinder Head



OEM No: 4089206  
Wabco No: 9111539212

**RK.01.067.01**

Repair Kit

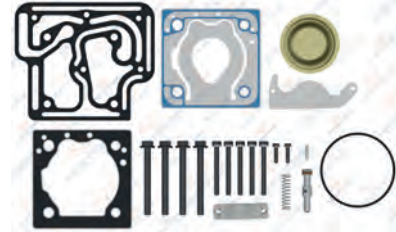

**RK.01.067.02**

Repair Kit

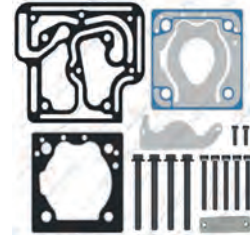

OEM No: 4089238  
Wabco No: 9111549292

**RK.01.067**

Repair Kit

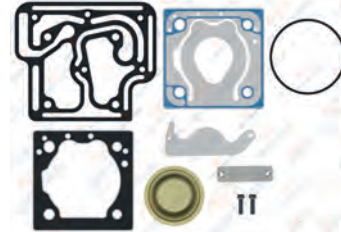

**RK.01.067.04**

Repair Kit

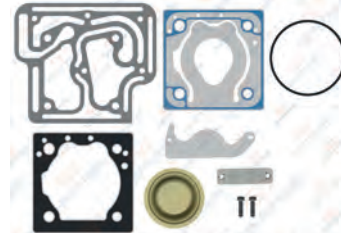

Use for old version cylinder repair kit. Yıpranmış kapaklar için.

**RK.01.067.06**

Repair Kit



# CUMMINS-VOLKSWAGEN-JOHN DEERE FORD BRASIL-CATERPILLAR-MACK AIR COMPRESSOR AND REPAIR KIT

## 01.900 Cylinder Head

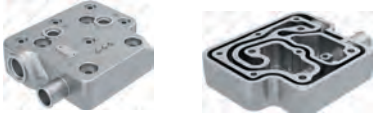

8 680437 028154

## 01.901 Valve Plate

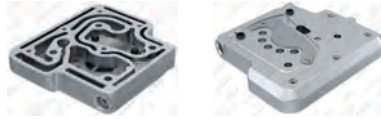

8 680437 028178

## 01.1564 Crankshaft



8 680437 077572

## 00.999 Roller Bearing



6308



8 680437 009627

## 01.1222 Flange



8 680437 017844

OEM No: 4089222  
Wabco No: 9111539252

## 01.272 Connecting Rod



8 680437 020400

Wabco No: 9111457372

## RK.01.104.00 Piston&Ring (Ø85,00 mm)

- RK.01.104.10 85,25 mm
- RK.01.104.20 85,50 mm
- RK.01.104.30 85,75 mm
- RK.01.104.40 86,00 mm



2.00x2.00x4.00



8 680437 060277

Wabco No: 9115016242

## 01.142.00 Piston (Ø85,00 mm)

- 01.142.10 85,25 mm
- 01.142.20 85,50 mm
- 01.142.30 85,75 mm
- 01.142.40 86,00 mm



2.00x2.00x4.00



8 680437 018674

Wabco No: 9115016252

## 01.373.00 Ring (Ø85,00 mm)

- 01.373.10 85,25 mm
- 01.373.20 85,50 mm
- 01.373.30 85,75 mm
- 01.373.40 86,00 mm



2.00x2.00x4.00



8 680437 075431

Wabco No: 9115019202

## RK.01.513 Repair Kit

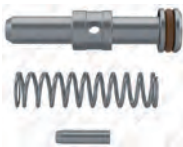

8 680437 066057

## 01.1646 Gear



8 680437 091004

OEM No: 3680550

## 01.1642 Adapter



8 680437 109037

OEM No: 4089677  
Wabco No: 9115019202

## 01.1782 Gear Adapter



8 680437 128571

## Single Cylinder Compressor Ø85 mm-318 CC-Stroke 56 mm

Application - Vehicle  
CUMMINS  
ISB/QSB/ISF ENGINE



**01.04.178**

Oem. Ref. No.  
5301094

Wabco No.  
9111539380

**01.04.178.10**

Without Gear



**01.1604**

Crankcase



**RK.01.067.05**

Repair Kit



**RK.01.430** Complete Cylinder Head



OEM No: 4936226  
Wabco No: 9111539202

**RK.01.067.01**

Repair Kit

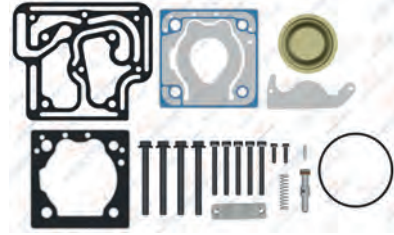

**RK.01.067.02**

Repair Kit

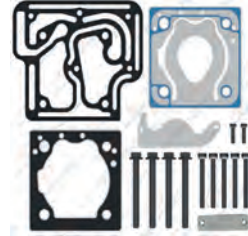

OEM No: 4089238  
Wabco No: 9111549292

**RK.01.067**

Repair Kit

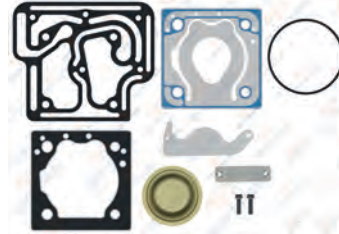

**RK.01.067.04**

Repair Kit

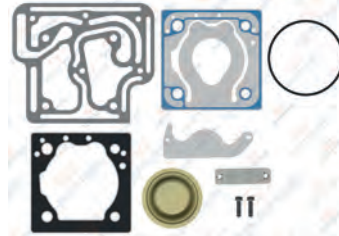

Use for old version cylinder repair kit. Yıpranmış kapaklar için.

**RK.01.067.06**

Repair Kit





# CUMMINS-VOLKSWAGEN-JOHN DEERE FORD BRASIL-CATERPILLAR-MACK AIR COMPRESSOR AND REPAIR KIT

01.990

Cylinder Head



8 680437 029559

01.901

Valve Plate



8 680437 028178

01.1636

Crankshaft



8 680437 079811

Left Hand - Sol Dis

00.999

Roller Bearing



6308



8 680437 009627

01.1222

Flange



8 680437 017844

OEM No: 4089222  
Wabco No: 9111539252

01.272

Connecting Rod



8 680437 020400

Wabco No: 9111457372

RK.01.104.00

Piston&Ring (Ø85,00 mm)

- RK.01.104.10 85,25 mm
- RK.01.104.20 85,50 mm
- RK.01.104.30 85,75 mm
- RK.01.104.40 86,00 mm



2.00x2,00x4,00



8 680437 060277

Wabco No: 9115016242

01.142.00

Piston (Ø85,00 mm)

- 01.142.10 85,25 mm
- 01.142.20 85,50 mm
- 01.142.30 85,75 mm
- 01.142.40 86,00 mm



2.00x2,00x4,00



8 680437 018674

Wabco No: 9115016252

01.373.00

Ring (Ø85,00 mm)

- 01.373.10 85,25 mm
- 01.373.20 85,50 mm
- 01.373.30 85,75 mm
- 01.373.40 86,00 mm



2.00x2,00x4,00



8 680437 075431

Wabco No: 9115019202

RK.01.513

Repair Kit

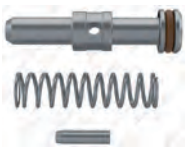

8 680437 066057

01.1225

Gear



8 680437 017875

Wabco No: 3942497 - 3940239

01.1643

Screw



M20X1.5 - Right Hand



8 680437 091073

01.1642

Adapter



8 680437 109057

OEM No: 4089677  
Wabco No: 9115019202

## Single Cylinder Compressor Ø85 mm-318 CC-Stroke 56 mm

Application - Vehicle  
CUMMINS  
ISB/QSB/ISF ENGINE



**01.04.215**

Oem. Ref. No.  
3558163  
4059825

Wabco No.  
9111535200



**01.1865** Crankcase



**RK.01.067.05** Repair Kit

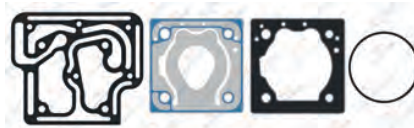

**RK.01.430** Complete Cylinder Head



Cummins: 4936226  
Wabco No: 9111539202

**RK.01.067.01** Repair Kit

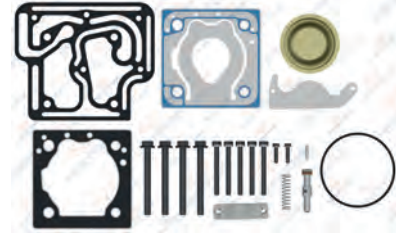

**RK.01.067.02** Repair Kit

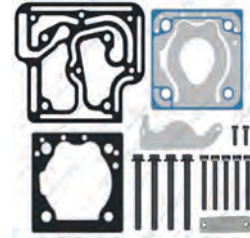

OEM No: 4089238  
Wabco No: 9111549292

**RK.01.067** Repair Kit

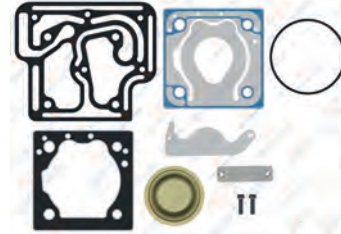

**RK.01.067.04** Repair Kit

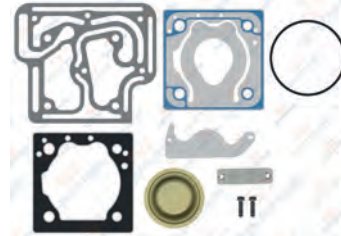

Use for old version cylinder repair kit. Yıpranmış kapaklar için.

**RK.01.067.06** Repair Kit



# CUMMINS-VOLKSWAGEN-JOHN DEERE FORD BRASIL-CATERPILLAR-MACK

AIR COMPRESSOR AND REPAIR KIT

01.990

Cylinder Head

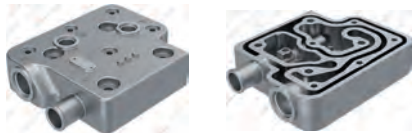

8 680437 029359

01.901

Valve Plate



8 680437 028178

01.1850

Crankshaft



8 680437 141136

00.999

Roller Bearing



6308



8 680437 009627

01.1851

Pump Adapter



8 680437 141143

01.272

Connecting Rod



8 680437 020400

Wabco No: 9111457372

RK.01.104.00

Piston&Ring (Ø85,00 mm)

RK.01.104.10 85,25 mm

RK.01.104.20 85,50 mm

RK.01.104.30 85,75 mm

RK.01.104.40 86,00 mm



2.00x2.00x4.00



8 680437 060277

Wabco No: 9115016242

01.142.00

Piston (Ø85,00 mm)

01.142.10 85,25 mm

01.142.20 85,50 mm

01.142.30 85,75 mm

01.142.40 86,00 mm



2.00x2.00x4.00



8 680437 018674

Wabco No: 9115016252

01.373.00

Ring (Ø85,00 mm)

01.373.10 85,25 mm

01.373.20 85,50 mm

01.373.30 85,75 mm

01.373.40 86,00 mm



2.00x2.00x4.00



8 680437 075431

Wabco No: 9115019202

RK.01.513

Repair Kit

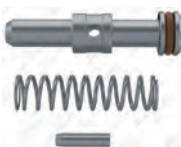

8 680437 066057

01.1909

Gear



8 680437 163619



## Single Cylinder Compressor Ø85 mm-318 CC-Stroke 56 mm

Application - Vehicle  
FORD BRASIL  
CUMMINS

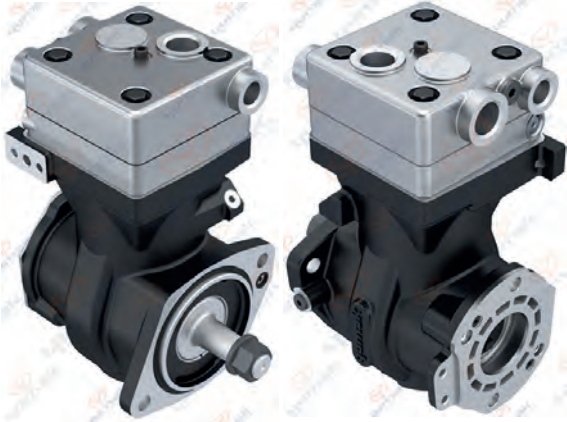

**01.04.217**

Oem. Ref. No.  
BG7X2875BA  
5301094

Wabco No.  
9111535520



**01.1855** Crankcase



**RK.01.414.02** Repair Kit

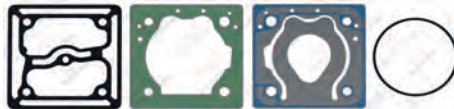

**RK.01.414.05** Repair Kit

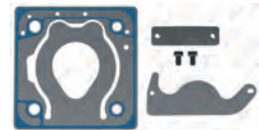

**RK.01.720**

Complete Cylinder Head

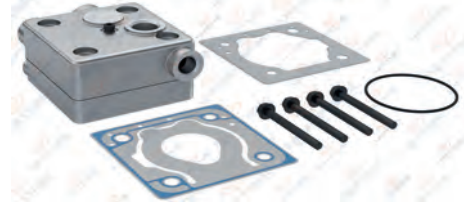

Wabco No: 9111558042

**RK.01.414.01**

Repair Kit

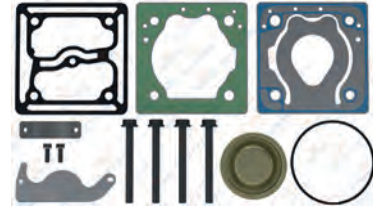

**RK.01.414**

Repair Kit

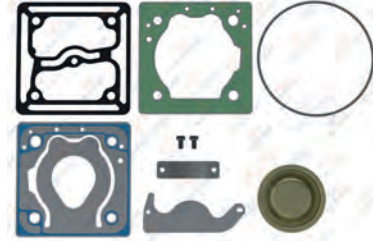

Wabco No: 9111559202

**RK.01.414.04**

Repair Kit

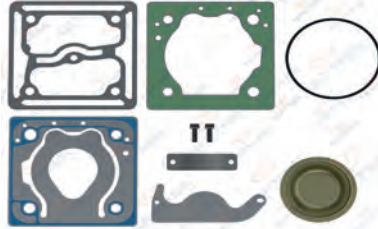

Use for old version cylinder repair kit. Yıpranmış kapaklar için.

**RK.01.414.03**

Repair Kit

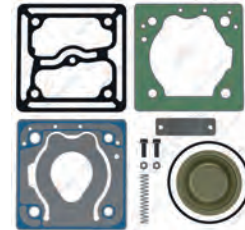

Wabco No: 9111559202

# CUMMINS-VOLKSWAGEN-JOHN DEERE FORD BRASIL-CATERPILLAR-MACK

## AIR COMPRESSOR AND REPAIR KIT

01.1517

Cylinder Head

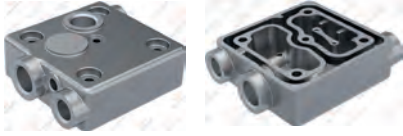

Wabco No: 8845025794 -  
8 680437 102410 9111556554

01.1431

Valve Plate



Wabco No: 8845032002 -  
8 680437 074793 9111556522

01.1856

Crankshaft



8 680437 141198

01.1123

Bushing



8 680437 016458

01.1649.20

Crankshaft Flange



8 680437 141204

01.272

Connecting Rod



8 680437 020400

RK.01.104.00

Piston&Ring (Ø85,00 mm)

- RK.01.104.10 85,25 mm
- RK.01.104.20 85,50 mm
- RK.01.104.30 85,75 mm
- RK.01.104.40 86,00 mm



2.00x2,00x4,00

Wabco No: 9115016242  
8 680437 060277

01.142.00

Piston (Ø85,00 mm)

- 01.142.10 85,25 mm
- 01.142.20 85,50 mm
- 01.142.30 85,75 mm
- 01.142.40 86,00 mm



2.00x2,00x4,00

Wabco No: 9115016252  
8 680437 018674

01.373.00

Ring (Ø85,00 mm)

- 01.373.10 85,25 mm
- 01.373.20 85,50 mm
- 01.373.30 85,75 mm
- 01.373.40 86,00 mm



2.00x2,00x4,00

Wabco No: 9115019202  
8 680437 075431

01.1854

Pump Adapter



8 680437 141174

01.957

Nut



8 680437 028871

01.1918

Gear



8 680437 164289

## Single Cylinder Compressor Ø85 mm-318 CC-Stroke 56 mm

Application - Vehicle  
CUMMINS ISB/QSB/ISF ENGINE  
FORD BRASIL : C 1317E / C 1517E / C 1717E /  
C 2428E

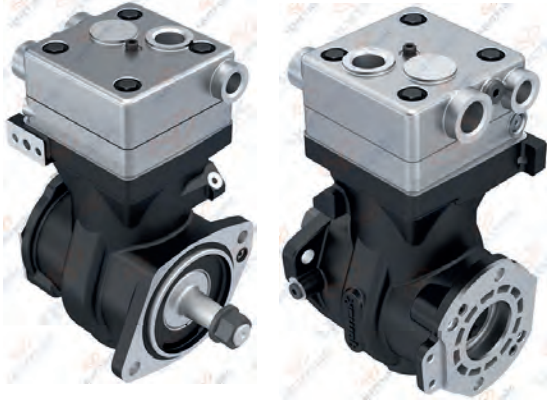

**01.04.216**

Oem. Ref. No.  
3968696  
BG5X2875BA

Wabco No.  
9111535480



**01.1855** Crankcase



**RK.01.414.02** Repair Kit

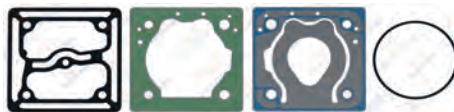

**RK.01.414.05** Repair Kit

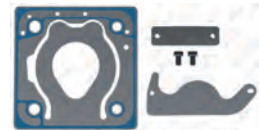

**RK.01.720**

Complete Cylinder Head



Wabco No: 9111558042

**RK.01.414.01**

Repair Kit

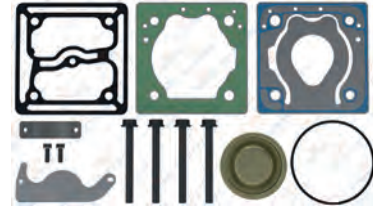

**RK.01.414**

Repair Kit

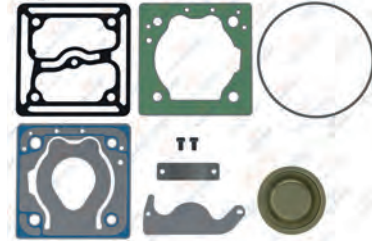

Wabco No: 9111559202

**RK.01.414.04**

Repair Kit

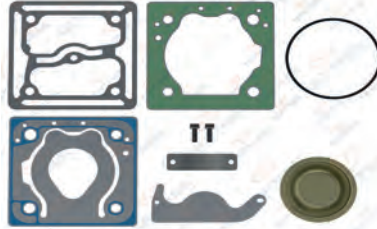

Use for old version cylinder repair kit. Yıpranmış kapaklar için.

**RK.01.414.03**

Repair Kit

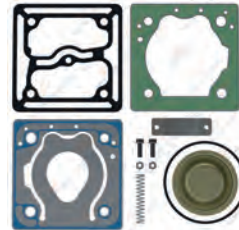

Wabco No: 9111559202



# CUMMINS-VOLKSWAGEN-JOHN DEERE FORD BRASIL-CATERPILLAR-MACK

## AIR COMPRESSOR AND REPAIR KIT

01.1517

Cylinder Head

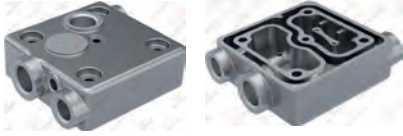

Wabco No: 8845025794 -  
8 680437 102410 9111556554

01.1431

Valve Plate



Wabco No: 8845032002 -  
8 680437 074793 9111556522

01.1856

Crankshaft



8 680437 141198

01.1123

Bushing



8 680437 016458

01.1649.20

Crankshaft Flange



8 680437 141204

01.272

Connecting Rod



8 680437 020400

RK.01.104.00

Piston&Ring (Ø85,00 mm)

- RK.01.104.10 85,25 mm
- RK.01.104.20 85,50 mm
- RK.01.104.30 85,75 mm
- RK.01.104.40 86,00 mm



2.00x2,00x4,00

Wabco No: 9115016242  
8 680437 060277

01.142.00

Piston (Ø85,00 mm)

- 01.142.10 85,25 mm
- 01.142.20 85,50 mm
- 01.142.30 85,75 mm
- 01.142.40 86,00 mm



2.00x2,00x4,00

Wabco No: 9115016252  
8 680437 018674

01.373.00

Ring (Ø85,00 mm)

- 01.373.10 85,25 mm
- 01.373.20 85,50 mm
- 01.373.30 85,75 mm
- 01.373.40 86,00 mm



2.00x2,00x4,00

Wabco No: 9115019202  
8 680437 075431

01.1854

Pump Adapter



8 680437 141174

01.957

Nut



8 680437 028871

## Single Cylinder Compressor Ø80 mm-225 CC-Stroke 45 mm

Application - Vehicle  
CUMMINS ECHO



**01.04.150**

Oem. Ref. No.  
3957726

Knorr No.  
LK3859  
K000854000



**01.1314** Crankcase



**RK.01.159.17** Repair Kit

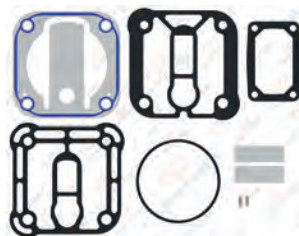

Knorr No: SEB22518\*\*

**RK.01.159.05** Repair Kit

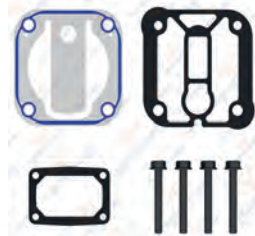

Knorr No: SEB018190051

**RK.01.273**

Complete Cylinder Head



**RK.01.638.02**

Valve Plate Kit



Knorr No: SEB01916K50

**RK.01.638**

Valve Plate Kit



**RK.01.638.01**

Valve Plate Kit



Knorr No: SEB01916K50

**RK.01.159.28**

Repair Kit

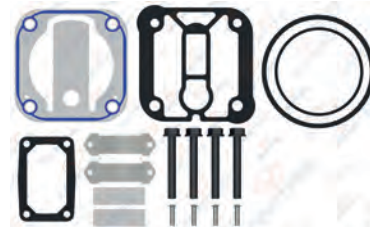

# CUMMINS-VOLKSWAGEN-JOHN DEERE FORD BRASIL-CATERPILLAR-MACK AIR COMPRESSOR AND REPAIR KIT

01.1291

Cylinder Head



Knorr No: SEB0176004

01.1290

Valve Plate



Knorr No: SEB01916004

01.1339

Crankshaft



M18X1.5 - Left Hand



01.820

Bushing



42x38x25



01.1392

Crankshaft Flange



01.1101

Connecting Rod



RK.01.601.00

Piston&Ring (Ø80,00 mm)

RK.01.601.10 80,25 mm

RK.01.601.20 80,50 mm

RK.01.601.30 80,75 mm

RK.01.601.40 81,00 mm



2.50x2,50x4,00



Knorr No: SEB22517

01.1201.00

Piston (Ø80,00 mm)

01.1201.10 80,25 mm

01.1201.20 80,50 mm

01.1201.30 80,75 mm

01.1201.40 81,00 mm



2.50x2,50x4,00



01.1226.00

Ring (Ø80,00 mm)

01.1226.10 80,25 mm

01.1226.20 80,50 mm

01.1226.30 80,75 mm

01.1226.40 81,00 mm



2.50x2,50x4,00



RK.01.159.03

Repair Kit

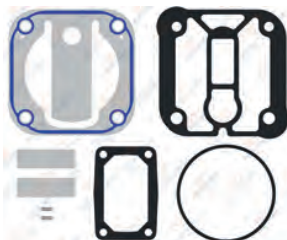

RK.01.159.04

Repair Kit

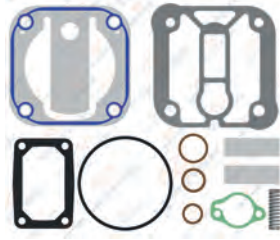

Use for old version cylinder repair kit.  
Yıpranmış kapaklar için.

01.374

Cover





## Single Cylinder Compressor 75 mm-247 CC-Stroke 56 mm

Application - Vehicle  
CUMMINS

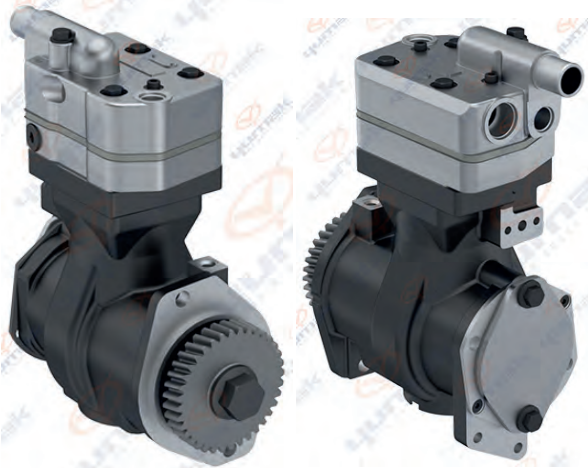

**01.05.153**

Oem. Ref. No.  
3944460  
3948842

Wabco No.  
9111545000

**01.05.153.10**

Without Gear



**01.1595**

Crankcase



**RK.01.450.03**

Repair Kit

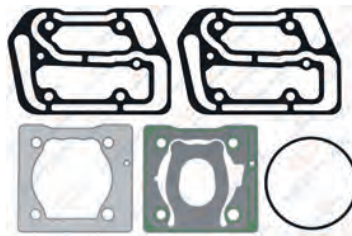

**RK.01.450.04**

Repair Kit

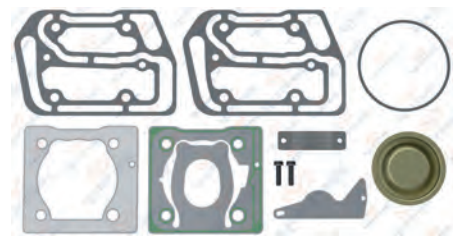

Use for old version cylinder repair kit.  
Yıpranmış kapaklar için.

**RK.01.540**

Complete Cylinder Head



Wabco No: 9111549202

**RK.01.450.02**

Repair Kit

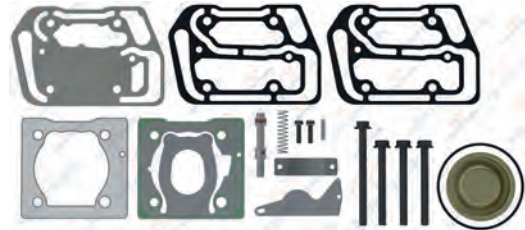

**RK.01.450.01**

Repair Kit

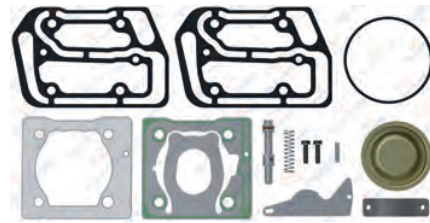

**RK.01.450**

Repair Kit

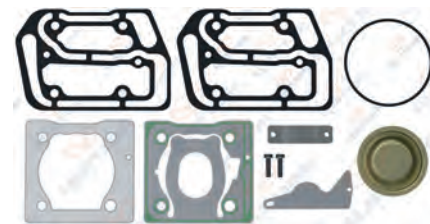

**RK.01.450.06**

Repair Kit



Wabco No: 9111549242

# CUMMINS-VOLKSWAGEN-JOHN DEERE FORD BRASIL-CATERPILLAR-MACK

## AIR COMPRESSOR AND REPAIR KIT

01.1596

Cylinder Head



8 680437 102597

01.1498

Valve Plate



8 680437 078418

01.1639

Crankshaft



8 680437 108894

01.1499

Cooling Plate



8 680437 079576

01.1222

Flange



8 680437 017844

OEM No: 4089222  
Wabco No: 9111539252

01.1224

Connecting Rod



8 680437 017868

RK.01.118.00

Piston&Ring (Ø75,00 mm)

- RK.01.118.10 75,25 mm
- RK.01.118.20 75,50 mm
- RK.01.118.30 75,75 mm
- RK.01.118.40 76,00 mm



2.00x2.00x4.00



8 680437 060482

Wabco No: 4111416232 - 4115226202

01.911.00

Piston (Ø75,00 mm)

- 01.911.10 75,25 mm
- 01.911.20 75,50 mm
- 01.911.30 75,75 mm
- 01.911.40 76,00 mm



2.00x2.00x4.00



8 680437 028277

01.134.00

Ring (Ø75,00 mm)

- 01.134.10 75,25 mm
- 01.134.20 75,50 mm
- 01.134.30 75,75 mm
- 01.134.40 76,00 mm



2.00x2.00x4.00



8 680437 018278

00.999

Roller Bearing



6308



8 680437 009627

01.1643

Screw



M20X1.5 - Right Hand



8 680437 091073

01.1642

Adapter



8 680437 109037

OEM No: 4089677  
Wabco No: 9115159262

RK.01.450.05

Pressure Valve



8 680437 122036

01.1647

Gear



8 680437 091011

## Single Cylinder Compressor Ø80 mm-225 CC-Stroke 44,50 mm

Application - Vehicle  
CUMMINS ISBE ENGINE



**01.04.133**

Oem. Ref. No.  
3971519

Knorr No.  
LK3875  
LK3839  
K008457000



**01.1314** Crankcase



**RK.01.159.08** Repair Kit

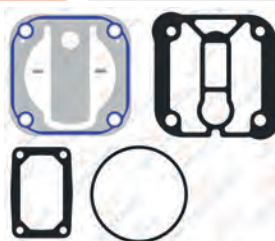

Knorr No: SEB018190052

**RK.01.159.16** Repair Kit



**RK.01.683.01**

Complete Cylinder Head



**RK.01.638**

Valve Plate Kit



**RK.01.638.01**

Valve Plate Kit



Knorr No: SEB01916K50

**RK.01.159.03**

Repair Kit

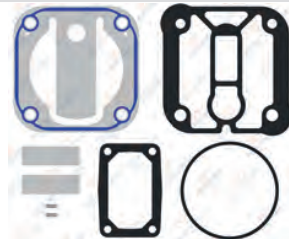

**RK.01.159.15**

Repair Kit

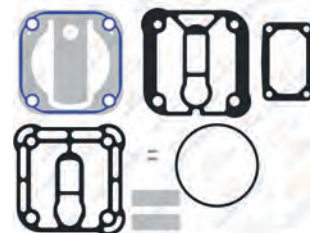

Knorr No: SEB22518



# CUMMINS-VOLKSWAGEN-JOHN DEERE FORD BRASIL-CATERPILLAR-MACK

## AIR COMPRESSOR AND REPAIR KIT

01.1301

Cylinder Head



OEM No : 1439981  
Knorr No : SEB01629004

01.1392

Crankshaft Flange



01.1339

Crankshaft



M18X1.5 - Right Hand



01.1290

Valve Plate



OEM No : 1689834  
Knorr No : SEB01916004

01.292

Bushing



42X38X25



01.1101

Connecting Rod



RK.01.601.00

Piston&Ring (Ø80,00 mm)

- RK.01.601.10 80,25 mm
- RK.01.601.20 80,50 mm
- RK.01.601.30 80,75 mm
- RK.01.601.40 81,00 mm



2.50x2,50x4,00



Knorr No: SEB22517

01.1201.00

Piston (Ø80,00 mm)

- 01.1201.10 80,25 mm
- 01.1201.20 80,50 mm
- 01.1201.30 80,75 mm
- 01.1201.40 81,00 mm



2.50x2,50x4,00



01.1226.00

Ring (Ø80,00 mm)

- 01.1226.10 80,25 mm
- 01.1226.20 80,50 mm
- 01.1226.30 80,75 mm
- 01.1226.40 81,00 mm



2.50x2,50x4,00



01.374

Cover



01.870

Nut



M18X1.5 - Right Hand



# Single Cylinder Compressor Ø80 mm-225 CC-Stroke 45 mm

Application - Vehicle  
CUMMINS B 3.9



**01.04.130**

Oem. Ref. No.  
3285923

Knorr No.  
LK3833  
SEB01586000



**01.1387** Crankcase



**RK.01.159.20** Repair Kit

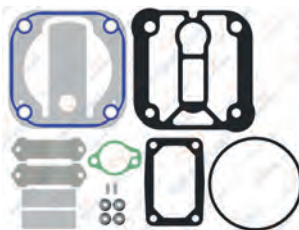

**RK.01.159.22** Repair Kit

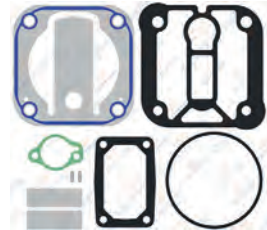

**RK.01.641** Complete Cylinder Head



**RK.01.616.01** Valve Plate Kit



**RK.01.616** Valve Plate Kit



Oem. No: 9P918391  
Knorr No: SEB01593004

**RK.01.159.25** Repair Kit

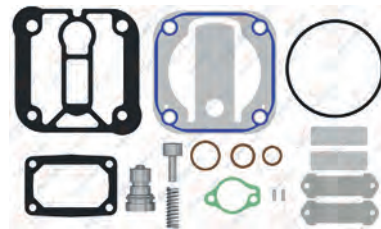

Oem. No: 9P918389

**RK.01.159.18** Repair Kit

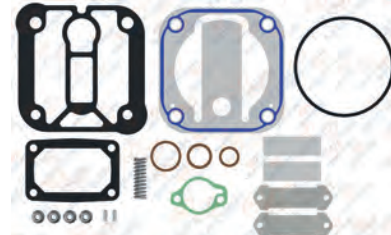

# CUMMINS-VOLKSWAGEN-JOHN DEERE FORD BRASIL-CATERPILLAR-MACK AIR COMPRESSOR AND REPAIR KIT

01.1302

Cylinder Head

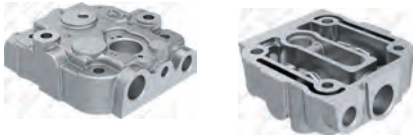

Knorr No: SEB01592004

01.1219

Valve Plate



Knorr No: SEB01915004

01.1339

Crankshaft



M18X1.5 - Left Hand



01.820

Bushing



42x38x25



01.1389

Crankshaft Flange



01.1101

Connecting Rod



RK.01.601.00

Piston&Ring (Ø80,00 mm)

- RK.01.601.10 80,25 mm
- RK.01.601.20 80,50 mm
- RK.01.601.30 80,75 mm
- RK.01.601.40 81,00 mm



2.50x2,50x4,00



Knorr No: SEB22517

01.1201.00

Piston (Ø80,00 mm)

- 01.1201.10 80,25 mm
- 01.1201.20 80,50 mm
- 01.1201.30 80,75 mm
- 01.1201.40 81,00 mm

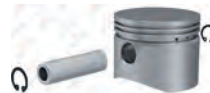

2.50x2,50x4,00



01.1226.00

Ring (Ø80,00 mm)

- 01.1226.10 80,25 mm
- 01.1226.20 80,50 mm
- 01.1226.30 80,75 mm
- 01.1226.40 81,00 mm



2.50x2,50x4,00



RK.01.159.05

Repair Kit

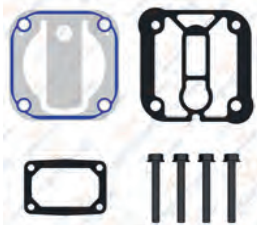

Knorr No: SEB018190051

RK.01.159.27

Repair Kit

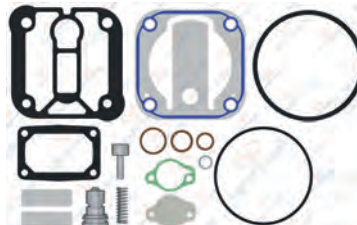

Knorr No: SEB22519\*

01.374

Cover





## Single Cylinder Compressor Ø80 mm-225 CC-Stroke 45 mm

Application - Vehicle  
CUMMINS  
VOLKSWAGEN 17.250E Constellation -  
24.250E Constellation



**01.04.210**

Oem. Ref. No.  
4980796  
2R0100759E

Knorr No.  
K01837101



**01.1314** Crankcase



**RK.01.159.17** Repair Kit

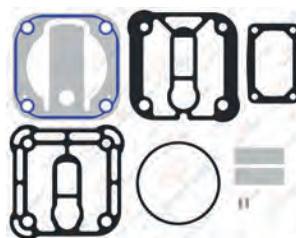

Knorr No: SEB22518\*\*

**RK.01.159.05** Repair Kit

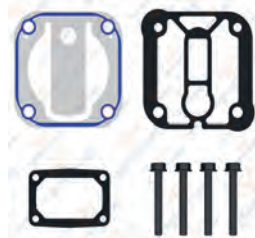

Knorr No: SEB018190051

**RK.01.868**

Complete Cylinder Head



**RK.01.616.02**

Valve Plate Kit



**RK.01.616**

Repair Kit



Oem. No: 9P918391  
Knorr No: SEB01593004

**RK.01.159.03**

Repair Kit

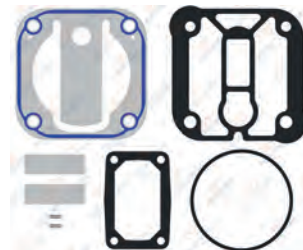

**RK.01.159.28**

Repair Kit

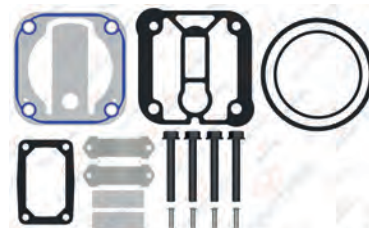

# CUMMINS-VOLKSWAGEN-JOHN DEERE FORD BRASIL-CATERPILLAR-MACK

AIR COMPRESSOR AND REPAIR KIT

01.1317

Cylinder Head



01.1219

Valve Plate



Knorr No: SEB01915004

01.1339

Crankshaft



M18X1.5 - Left Hand



01.292

Bushing



42X38X25



01.1392

Crankshaft Flange



01.1101

Connecting Rod



RK.01.601.00

Piston&Ring (Ø80,00 mm)

- RK.01.601.10 80,25 mm
- RK.01.601.20 80,50 mm
- RK.01.601.30 80,75 mm
- RK.01.601.40 81,00 mm



2.50x2,50x4,00



Knorr No: SEB22517

01.1201.00

Piston (Ø80,00 mm)

- 01.1201.10 80,25 mm
- 01.1201.20 80,50 mm
- 01.1201.30 80,75 mm
- 01.1201.40 81,00 mm



2.50x2,50x4,00



01.1226.00

Ring (Ø80,00 mm)

- 01.1226.10 80,25 mm
- 01.1226.20 80,50 mm
- 01.1226.30 80,75 mm
- 01.1226.40 81,00 mm



2.50x2,50x4,00



# Single Cylinder Compressor Ø80 mm-225 CC-Stroke 45 mm

Application - Vehicle  
CUMMINS  
COLHEITADEIRA



**01.04.211**

Oem. Ref. No.  
3975798

Knorr No.  
K006282



8 680437 137559



**01.1390** Crankcase



8 680437 102700

**RK.01.159.20** Repair Kit

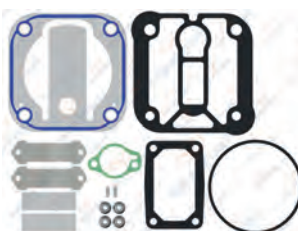

8 680437 073956

**RK.01.867** Complete Cylinder Head



8 680437 163961

**RK.01.616.01** Valve Plate Kit



8 680437 112297

**RK.01.616** Valve Plate Kit



8 680437 067306

Oem. No: 9P918391  
Knorr No: SEB01593004

**RK.01.159.25** Repair Kit

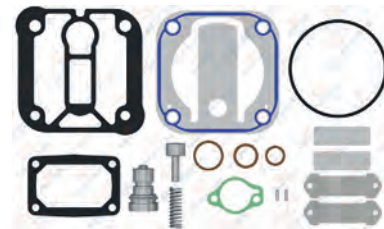

8 680437 081807

Oem. No: 9P918389

**RK.01.159.18** Repair Kit

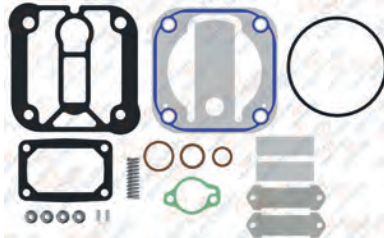

8 680437 119050

**RK.01.159.22** Repair Kit

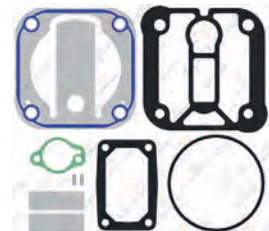

8 680437 119067



# CUMMINS-VOLKSWAGEN-JOHN DEERE FORD BRASIL-CATERPILLAR-MACK

## AIR COMPRESSOR AND REPAIR KIT

01.1914

Cylinder Head



8 680437 163985

01.1219

Valve Plate



8 680437 017776

Knorr No: SEB01915004

01.1338

Crankshaft



5/8 - 18 UNF



8 680437 109372

01.292

Bushing



42X38X25



8 680437 073871

01.1389

Crankshaft Flange



8 680437 072096

01.1101

Connecting Rod



8 680437 016069

RK.01.601.00

Piston&Ring (Ø80,00 mm)

RK.01.601.10 80,25 mm

RK.01.601.20 80,50 mm

RK.01.601.30 80,75 mm

RK.01.601.40 81,00 mm



2.50x2,50x4,00



8 680437 067054

Knorr No: SEB22517

01.1201.00

Piston (Ø80,00 mm)

01.1201.10 80,25 mm

01.1201.20 80,50 mm

01.1201.30 80,75 mm

01.1201.40 81,00 mm



2.50x2,50x4,00



8 680437 017530

01.1226.00

Ring (Ø80,00 mm)

01.1226.10 80,25 mm

01.1226.20 80,50 mm

01.1226.30 80,75 mm

01.1226.40 81,00 mm



2.50x2,50x4,00



8 680437 017882

RK.01.159.05

Repair Kit

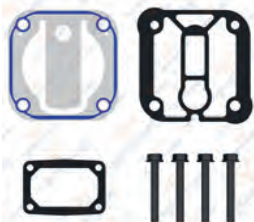

8 680437 120377

Knorr No: SEB018190051

RK.01.159.27

Repair Kit

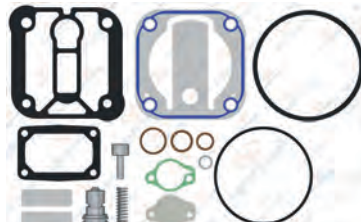

8 680437 121121

Knorr No: SEB22519\*

RK.01.532

Repair Kit

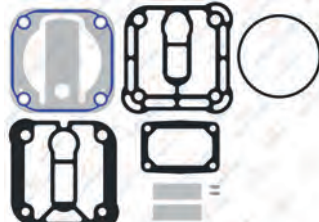

8 680437 066279

# Single Cylinder Compressor Ø80 mm-225 CC-Stroke 45 mm

Application - Vehicle  
CUMMINS  
COLHEITADEIRA



**01.04.212**

Oem. Ref. No.  
4948553

Knorr No.  
K019553



8 680437 137566



**01.1390** Crankcase



8 680437 102700

**RK.01.159.17** Repair Kit

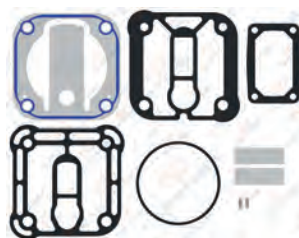

8 680437 119043

Knorr No: SEB22518\*\*

**RK.01.867**

Complete Cylinder Head



8 680437 163961

**RK.01.616.02**

Valve Plate Kit



8 680437 163954

**RK.01.616**

Repair Kit



8 680437 067306

Oem. No: 9P918391  
Knorr No: SEB01593004

**RK.01.159.03**

Repair Kit

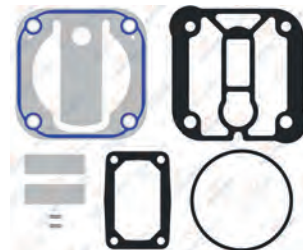

8 680437 072638

**RK.01.159.05**

Repair Kit

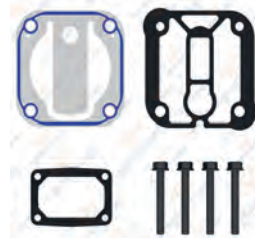

8 680437 120377

Knorr No: SEB018190051

# CUMMINS-VOLKSWAGEN-JOHN DEERE FORD BRASIL-CATERPILLAR-MACK

AIR COMPRESSOR AND REPAIR KIT

01.1914

Cylinder Head



8 680437 163985

01.1219

Valve Plate



8 680437 017776

Knorr No: SEB01915004

01.1338

Crankshaft



5/8 - 18 UNF



8 680437 109372

01.292

Bushing



42X38X25



8 680437 073871

01.1392

Crankshaft Flange



8 680437 072225

01.1101

Connecting Rod



8 680437 016069

RK.01.601.00

Piston&Ring (Ø80,00 mm)

RK.01.601.10 80,25 mm

RK.01.601.20 80,50 mm

RK.01.601.30 80,75 mm

RK.01.601.40 81,00 mm



2.50x2,50x4,00



8 680437 067054

Knorr No: SEB22517

01.1201.00

Piston (Ø80,00 mm)

01.1201.10 80,25 mm

01.1201.20 80,50 mm

01.1201.30 80,75 mm

01.1201.40 81,00 mm



2.50x2,50x4,00



8 680437 017530

01.1226.00

Ring (Ø80,00 mm)

01.1226.10 80,25 mm

01.1226.20 80,50 mm

01.1226.30 80,75 mm

01.1226.40 81,00 mm



2.50x2,50x4,00



8 680437 017882



## Single Cylinder Compressor Ø80 mm-225 CC-Stroke 45 mm

**Application - Vehicle**  
 CUMMINS INTERACT 4.0  
 FORD BRASIL Cargo 1317 e - Cargo 1517 e  
 Cargo 1717 e - Cargo 815 e



**01.04.213**

**Oem. Ref. No.**  
3968694

**Knorr No.**  
LK3870  
K002974TU



**01.1314** Crankcase



**RK.01.159.17** Repair Kit

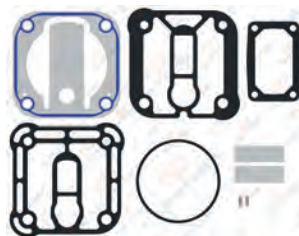

**Knorr No:** SEB22518\*\*

**RK.01.867**

Complete Cylinder Head



**RK.01.616.02**

Valve Plate Kit



**RK.01.616**

Repair Kit



**Oem. No:** 9P918391  
**Knorr No:** SEB01593004

**RK.01.159.03**

Repair Kit

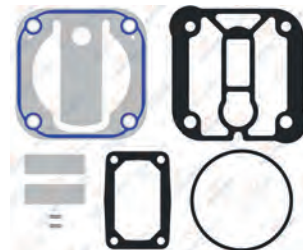

**RK.01.159.05**

Repair Kit

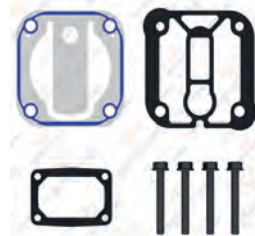

**Knorr No:** SEB018190051

# CUMMINS-VOLKSWAGEN-JOHN DEERE FORD BRASIL-CATERPILLAR-MACK

AIR COMPRESSOR AND REPAIR KIT

01.1914

Cylinder Head



8 680437 163985

01.1219

Valve Plate



8 680437 017776

Knorr No: SEB01915004

01.1339

Crankshaft



M18X1.5 - Left Hand



8 680437 072430

01.292

Bushing



42X38X25



8 680437 073871

01.1392

Crankshaft Flange



8 680437 072225

01.1101

Connecting Rod



8 680437 016069

RK.01.601.00

Piston&Ring (Ø80,00 mm)

- RK.01.601.10 80,25 mm
- RK.01.601.20 80,50 mm
- RK.01.601.30 80,75 mm
- RK.01.601.40 81,00 mm



2.50x2,50x4,00



8 680437 067054

Knorr No: SEB22517

01.1201.00

Piston (Ø80,00 mm)

- 01.1201.10 80,25 mm
- 01.1201.20 80,50 mm
- 01.1201.30 80,75 mm
- 01.1201.40 81,00 mm



2.50x2,50x4,00



8 680437 017530

01.1226.00

Ring (Ø80,00 mm)

- 01.1226.10 80,25 mm
- 01.1226.20 80,50 mm
- 01.1226.30 80,75 mm
- 01.1226.40 81,00 mm



2.50x2,50x4,00



8 680437 017882

## Twin Cylinder Compressor Ø75 mm-495 CC-Stroke 56 mm

Application - Vehicle  
CUMMINS

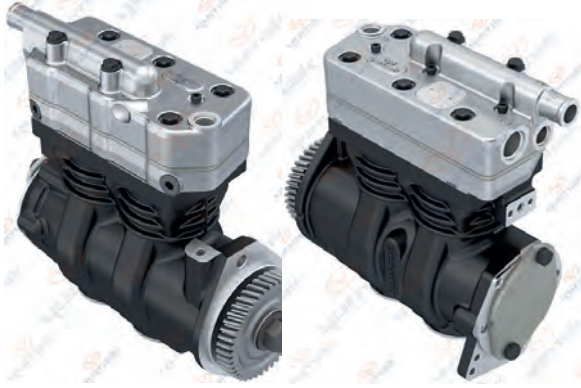

**01.04.127**

Oem. Ref. No.

5272391  
5286661  
4945947

Wabco No.

9115160100



**01.1221**

Crankcase



**RK.01.617**

Complete Cylinder Head

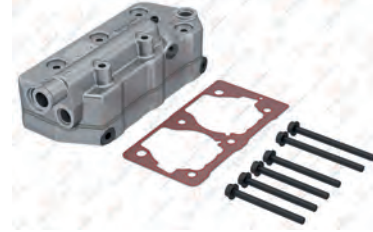

Knorr No: 9115169202

**RK.01.618.01**

Repair Kit

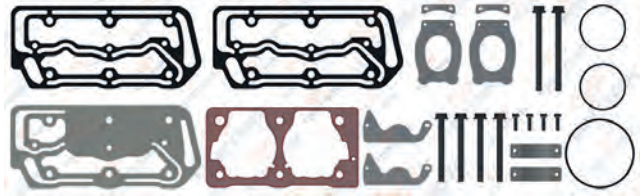

**RK.01.618**

Repair Kit

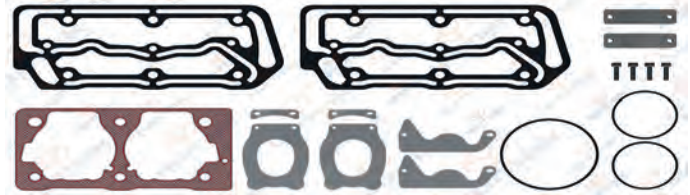

**RK.01.618.04**

Repair Kit

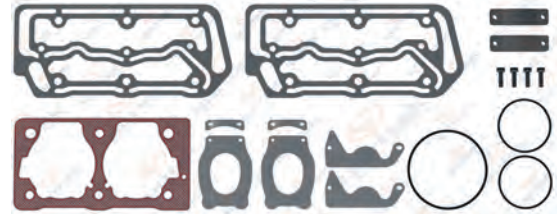

Use for old version cylinder repair kit. Yıpranmış kapaklar için.

**RK.01.618.23**

Repair Kit

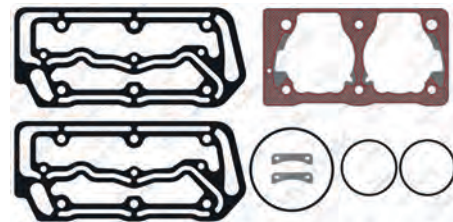

**RK.01.618.06**

Repair Kit

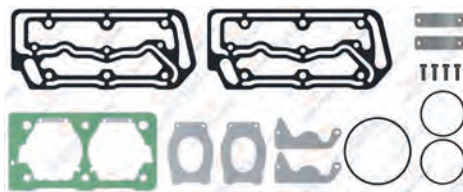

**RK.01.618.07**

Repair Kit

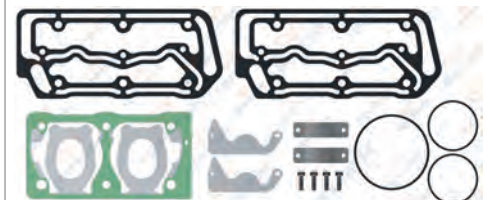



# CUMMINS-VOLKSWAGEN-JOHN DEERE FORD BRASIL-CATERPILLAR-MACK

## AIR COMPRESSOR AND REPAIR KIT

01.1209

Cylinder Head



8 680437 017653

01.1210

Valve Plate



8 680437 017684

01.1220

Crankshaft



8 680437 017820

01.1095

Valve Plate



8 680437 015949

01.1222

Flange



Wabco No: 9111539252

8 680437 017844

01.1224

Connecting Rod



8 680437 017868

RK.01.118.00

Piston&Ring (Ø75,00 mm)

RK.01.118.10 75,25 mm

RK.01.118.20 75,50 mm

RK.01.118.30 75,75 mm

RK.01.118.40 76,00 mm



2,00x2,00x4,00



8 680437 060482

Wabco No: 4111416232

01.911.00

Piston (Ø75,00 mm)

01.911.10 75,25 mm

01.911.20 75,50 mm

01.911.30 75,75 mm

01.911.40 76,00 mm



2,00x2,00x4,00



8 680437 028277

01.134.00

Ring (Ø75,00 mm)

01.134.10 75,25 mm

01.134.20 75,50 mm

01.134.30 75,75 mm

01.134.40 76,00 mm



2,00x2,00x4,00



8 680437 018278

01.1223

Cover



8 680437 017851

01.1225

Gear



8 680437 017875

01.1642

Adapter



8 680437 109037

OEM No: 4089677

Wabco No: 9111519262

RK.01.618.30

Repair Kit



8 680437 124092

## Single Cylinder Compressor Ø92 mm - 360 CC - Stroke 54 mm

Application - Vehicle  
INTERNATIONAL  
PROSTAR - MaxxForce G11/G13



**01.04.073.01**

Oem. No.  
362449C9  
3624499C91

Knorr No.  
K028383



**01.1178** Crankcase

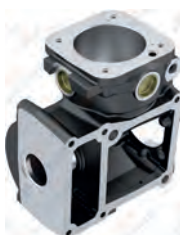

**RK.01.268.03** Repair Kit



**RK.01.518** Complete Cylinder Head



**RK.01.518.20** Complete Cylinder Head



**RK.01.478.02** Valve Plate Kit



**RK.01.478** Valve Plate Kit

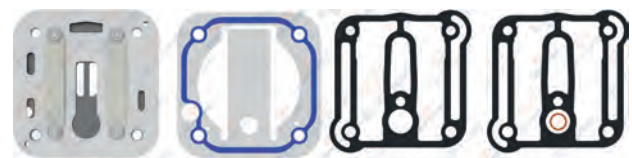

OEM No : 51541246004  
Knorr No : K015040

**RK.01.268.02** Repair Kit

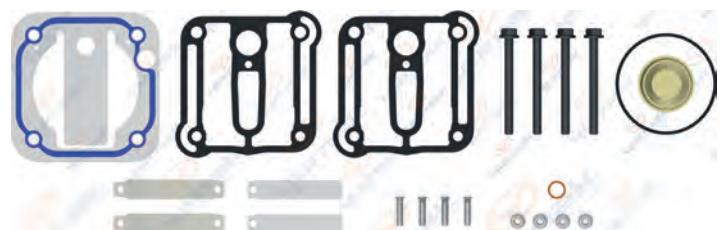

**RK.01.268.06** Repair Kit



# CUMMINS-VOLKSWAGEN-JOHN DEERE FORD BRASIL-CATERPILLAR-MACK AIR COMPRESSOR AND REPAIR KIT

01.939

Cylinder Head

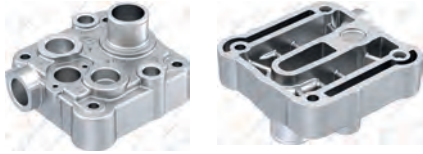

OEM No : 51541146084  
Knorr No : Z008260004 - K019286

01.940

Cooling Plate



Knorr No : SEB01728004

01.1022

Crankshaft



M18X1.5 Left Hand



01.1036

Valve Plate



01.1148

Crankshaft Flange



01.1101

Connecting Rod



RK.01.318.00

Piston&Ring (Ø92,00 mm)

- RK.01.318.10 92,25 mm
- RK.01.318.20 92,50 mm
- RK.01.318.30 92,75 mm
- RK.01.318.40 93,00 mm



2,50x2,50x4,00



Knorr. No.:SEB22530 - K006026

01.862.00

Piston (Ø92,00 mm)

- 01.862.10 92,25 mm
- 01.862.20 92,50 mm
- 01.862.30 92,75 mm
- 01.862.40 93,00 mm



2,50x2,50x4,00



01.942.00

Ring (Ø92,00 mm)

- 01.942.10 92,25 mm
- 01.942.20 92,50 mm
- 01.942.30 92,75 mm
- 01.942.40 93,00 mm



2,50x2,50x4,00



51.01.007

Safety Valve



M26X1.5 - 17 Bar



OEM No : 51541228001  
Knorr No : DR5125 - K081929K50

01.920

Cap



01.1174

Gear



Notch (Tooth) Pcs : 29



RK.01.802

Connecting Rod & Piston



STD.



01.292

Bushing



42X38X25



RK.01.722

Gear Kit



Knorr No: K017357

01.1416

Screw



M18X1.5 Left Hand





## Single Cylinder Compressor Ø92 mm - 360 CC - Stroke 54 mm

Application - Vehicle  
INTERNATIONAL  
PROSTAR - MaxxForce G11/G13



**01.04.073.11**

Oem. No.

Knorr No.

LK8902  
K025822N00



8 680437 137320



**01.1178** Crankcase



8 680437 017240

**RK.01.518.10** Complete Cylinder Head



8 680437 076889

Knorr No : K114439K50 - K105789K50

**RK.01.478.01** Valve Plate Kit

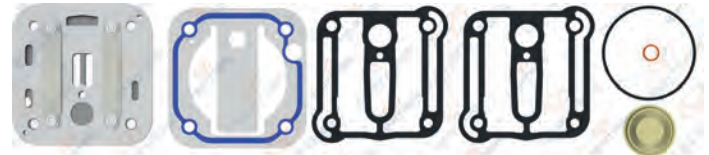

8 680437 112631

**RK.01.478.10** Valve Plate Kit

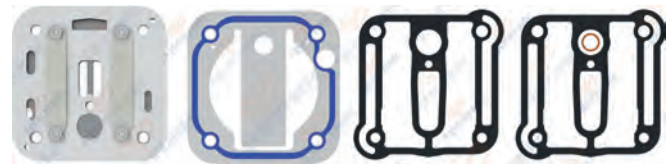

8 680437 112655

**RK.01.268.02** Repair Kit

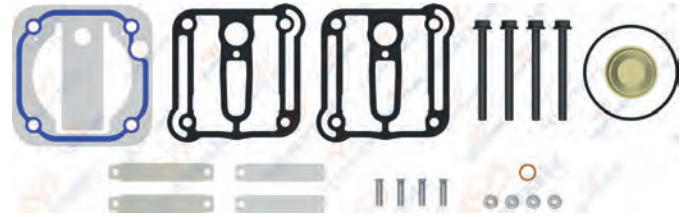

8 680437 063087

**RK.01.268.03** Repair Kit

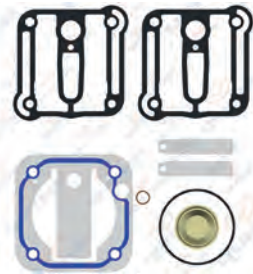

8 680437 073932

**RK.01.268.04** Repair Kit

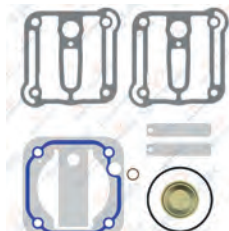

8 680437 063100

Use for old version cylinder repair kit.  
Yıpranmış kapaklar için.

**RK.01.268.06** Repair Kit



8 680437 124153

# CUMMINS-VOLKSWAGEN-JOHN DEERE FORD BRASIL-CATERPILLAR-MACK AIR COMPRESSOR AND REPAIR KIT

**01.939.10** Cylinder Head



**01.940.10** Cooling Plate



Knorr No : SEB01728004

**01.1022** Crankshaft



M18X1.5 Left Hand



**01.1036.100** Valve Plate



**01.1148** Crankshaft Flange



**01.1101** Connecting Rod



**RK.01.318.00** Piston&Ring (Ø92,00 mm)

- RK.01.318.10 92,25 mm
- RK.01.318.20 92,50 mm
- RK.01.318.30 92,75 mm
- RK.01.318.40 93,00 mm



2,50x2,50x4,00



Knorr No.: K006026

**01.862.00** Piston (Ø92,00 mm)

- 01.862.10 92,25 mm
- 01.862.20 92,50 mm
- 01.862.30 92,75 mm
- 01.862.40 93,00 mm



2,50x2,50x4,00



**01.942.00** Ring (Ø92,00 mm)

- 01.942.10 92,25 mm
- 01.942.20 92,50 mm
- 01.942.30 92,75 mm
- 01.942.40 93,00 mm



2,50x2,50x4,00



**51.01.007** Safety Valve



M26X1.5 - 17 Bar



OEM No : 51541228001  
Knorr No : DR5125 - K081929K50

**01.920** Cap



**01.1174** Gear



Notch (Tooth) Pcs : 29



**RK.01.802** Connecting Rod & Piston



STD.



**01.292** Bushing



42X38X25



**RK.01.722** Gear Kit



Knorr No: K017357

**01.1416** Screw



M18X1.5 Left Hand





## Twin Cylinder Compressor Ø86 mm-460 CC-Stroke 40 mm

Application - Vehicle  
CUMMINS ISC, ISB ENGINE



**01.05.149**

Oem. Ref. No.  
5257939

Knorr No.  
LP4865  
K033404N00



**01.1519** Crankcase



**RK.01.679** Repair Kit

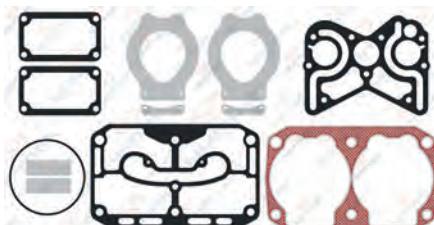

**RK.01.679.06** Repair Kit

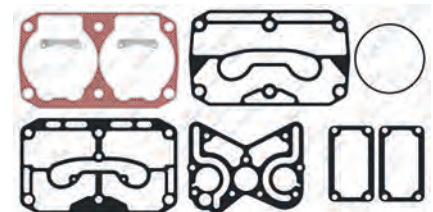

Oem. No: 42549151  
Knorr No: SEB22550

**RK.01.677.20**

Complete Cylinder Head



**RK.01.676**

Valve Plate Kit



**RK.01.676.01**

Valve Plate Kit



**RK.01.679.01**

Repair Kit

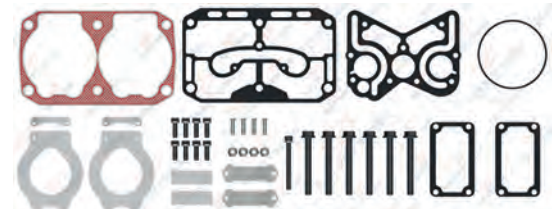

**RK.01.679.05**

Repair Kit

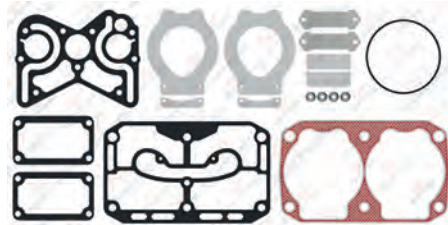



# CUMMINS-VOLKSWAGEN-JOHN DEERE FORD BRASIL-CATERPILLAR-MACK

## AIR COMPRESSOR AND REPAIR KIT

01.1374

Cylinder Head

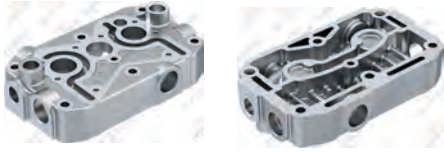

8 680437 076803

01.1373

Cylinder Head



8 680437 077831

01.1520

Crankshaft



M18X1.5 - Left Hand



8 680437 076384

01.1372

Valve Plate



8 680437 074144

Knorr No: K044410K50

RK.01.677.21

Complete Cylinder Head



8 680437 079378

Knorr No: K047839K50

01.1016

Connecting Rod



8 680437 014775

RK.01.272.00

Piston&Ring (Ø86,00 mm)

RK.01.272.10 86,25 mm

RK.01.272.20 86,50 mm

RK.01.272.30 86,75 mm

RK.01.272.40 87,00 mm



2.00x2.00x3.00



8 680437 063209

Knorr No: SEB22547 - SEB22548

01.868.00

Piston (Ø86,00 mm)

01.868.10 86,25 mm

01.868.20 86,50 mm

01.868.30 86,75 mm

01.868.40 87,00 mm



2.00x2.00x3.00



8 680437 027676

01.869.00

Ring (Ø86,00 mm)

01.869.10 86,25 mm

01.869.20 86,50 mm

01.869.30 86,75 mm

01.869.40 87,00 mm



2.00x2.00x3.00



8 680437 027737

01.1521

Crankshaft Flange



8 680437 083238

01.026

Bushing



44X40X26



8 680437 071679

01.1522

Adapter



8 680437 109006

RK.01.184

Repair Kit



8 680437 061885

01.079

Cover



8 680437 014232

01.870

Nut



M18X1.5 - Left Hand



8 680437 027799

## Twin Cylinder Compressor Ø86 mm-460 CC-Stroke 40 mm

Application - Vehicle  
CUMMINS ECHO



**01.05.149.10**

Oem. Ref. No.  
5257939

Knorr No.  
LP4865-K033404N00



**01.1519** Crankcase



**RK.01.136.05** Repair Kit

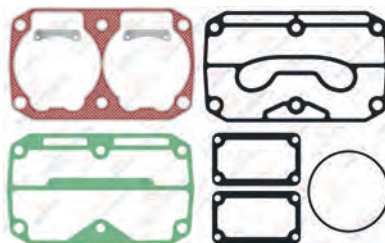

**RK.01.184** Repair Kit



**RK.01.662** Complete Cylinder Head

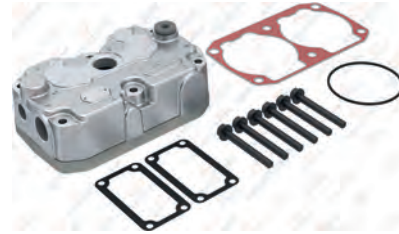

**RK.01.339.10** Valve Plate Kit

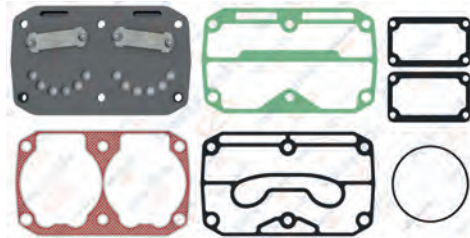

**RK.01.339.30** Valve Plate Kit

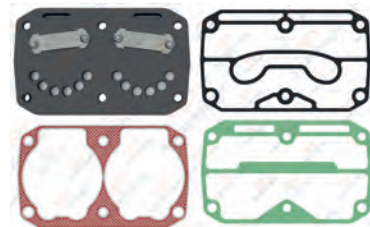

**RK.01.136.09** Repair Kit

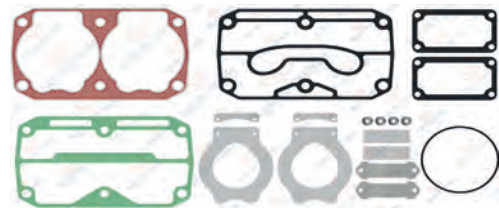

**RK.01.136.20** Repair Kit

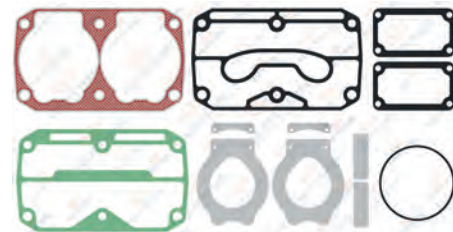

# CUMMINS-VOLKSWAGEN-JOHN DEERE FORD BRASIL-CATERPILLAR-MACK

AIR COMPRESSOR AND REPAIR KIT

01.1620

Cylinder Head



8 680437 101697

01.1566

Valve Plate



8 680437 114109

01.1520

Crankshaft



M18X1.5 - Left Hand



8 680437 076384

01.026

Bushing



44X40X26



8 680437 071679

01.1521

Crankshaft Flange



8 680437 083238

01.1016

Connecting Rod



8 680437 014775

RK.01.272.00

Piston&Ring (Ø86,00 mm)

RK.01.272.10 86,25 mm

RK.01.272.20 86,50 mm

RK.01.272.30 86,75 mm

RK.01.272.40 87,00 mm



2.00x2,00x3,00



8 680437 063209

Knorr No: SEB22547 - SEB22548

01.868.00

Piston (Ø86,00 mm)

01.868.10 86,25 mm

01.868.20 86,50 mm

01.868.30 86,75 mm

01.868.40 87,00 mm



2.00x2,00x3,00



8 680437 027676

01.869.00

Ring (Ø86,00 mm)

01.869.10 86,25 mm

01.869.20 86,50 mm

01.869.30 86,75 mm

01.869.40 87,00 mm



2.00x2,00x3,00



8 680437 027737

01.870

Nut



M18X1.5 - Left Hand



8 680437 027799

01.079

Cover



8 680437 014232

01.1522

Adapter



8 680437 109006

01.302

Cap



8 680437 020769



## Single Cylinder Compressor Ø92 mm-360 CC-Stroke 56 mm

Application - Vehicle  
CUMMINS QSB6.7 ENGINE



**01.04.149**

Oem. Ref. No.  
4936049

Knorr No.  
LP3977  
K014799000



**01.1633**

Valve Plate



**RK.01.395.04**

Repair Kit

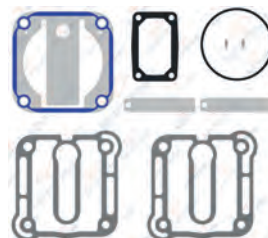

Use for old version cylinder repair kit.  
Yıpranmış kapaklar için.

**RK.01.395.02**

Repair Kit

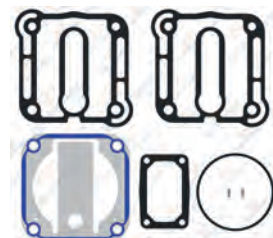

**RK.01.644.30**

Complete Cylinder Head



**RK.01.645.01**

Valve Plate Kit



**RK.01.645**

Valve Plate Kit



**RK.01.395.05**

Repair Kit

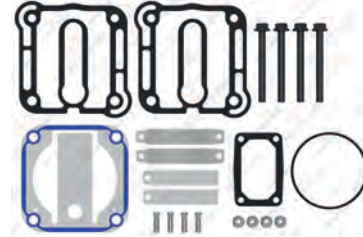

**RK.01.395.06**

Repair Kit

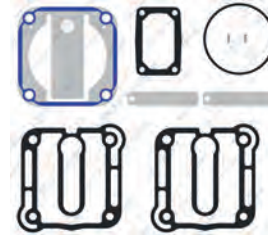

Knorr No: SEB22532

# CUMMINS-VOLKSWAGEN-JOHN DEERE FORD BRASIL-CATERPILLAR-MACK AIR COMPRESSOR AND REPAIR KIT

## 01.1304.30 Cylinder Head



Knorr No: K014824  
8 680437 102502

## 01.186 Valve Plate



Knorr No: SEB01694004  
8 680437 019190

## 01.1207 Crankshaft



M18X1.5 - Left Hand  
8 680437 017639

## 01.940 Cooling Plate



Knorr No: SEB01728004  
8 680437 028635

## 01.1392 Crankshaft Flange



Knorr No: SEB018190061  
8 680437 072225

## 01.1101 Connecting Rod



8 680437 016069

## RK.01.318.00 Piston&Ring (Ø92,00 mm)

- RK.01.318.10 92,25 mm
- RK.01.318.20 92,50 mm
- RK.01.318.30 92,75 mm
- RK.01.318.40 93,00 mm



2.50x2,50x4,00  
Knorr No: SEB22530 - K012079  
8 680437 063773

## 01.862.00 Piston (Ø92,00 mm)

- 01.862.10 92,25 mm
- 01.862.20 92,50 mm
- 01.862.30 92,75 mm
- 01.862.40 93,00 mm



2.50x2,50x4,00  
8 680437 027584

## 01.942.00 Ring (Ø92,00 mm)

- 01.942.10 92,25 mm
- 01.942.20 92,50 mm
- 01.942.30 92,75 mm
- 01.942.40 93,00 mm



2.50x2,50x4,00  
8 680437 028666

## 01.374 Cover



8 680437 077022

## 01.292 Bushing



42X38X25  
8 680437 075871

## 01.870 Nut



M18X1.5 - Left Hand  
8 680437 027799

## Single Cylinder Compressor Ø80 mm-225 CC-Stroke 44,50 mm

Application - Vehicle  
VOLKSWAGEN TRUCK  
CUMMINS

17.250E Constellation / 24.250E Constellation



**01.04.208**

Oem. Ref. No.  
4933229

Knorr No.  
K011246



**01.1314** Crankcase



**RK.01.159.08** Repair Kit

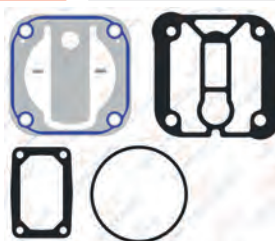

Knorr No: SEB018190052

**RK.01.159.16** Repair Kit



**RK.01.683.01**

Complete Cylinder Head



**RK.01.638**

Valve Plate Kit



**RK.01.638.01**

Valve Plate Kit



Knorr No: SEB01916K50

**RK.01.159.03**

Repair Kit

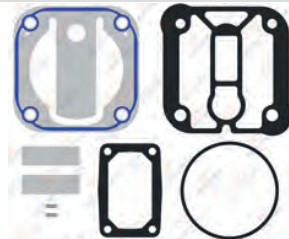

**RK.01.159.15**

Repair Kit

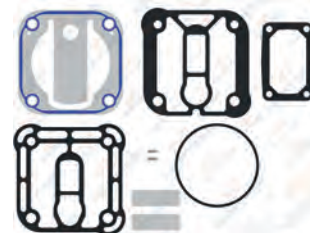

Knorr No: SEB22518



# CUMMINS-VOLKSWAGEN-JOHN DEERE FORD BRASIL-CATERPILLAR-MACK

AIR COMPRESSOR AND REPAIR KIT

01.1301

Cylinder Head

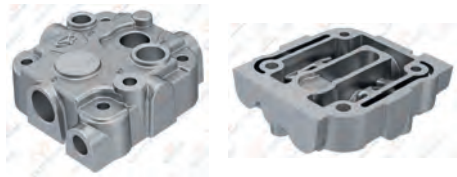

OEM No : 1439981  
Knorr No : SEB01629004

01.1389

Crankshaft Flange



01.1339

Crankshaft



M18X1.5 - Right Hand



01.1290

Valve Plate



OEM No : 1689834  
Knorr No : SEB01916004

01.292

Bushing



42X38X25



01.1101

Connecting Rod



RK.01.601.00

Piston&Ring (Ø80,00 mm)

- RK.01.601.10 80,25 mm
- RK.01.601.20 80,50 mm
- RK.01.601.30 80,75 mm
- RK.01.601.40 81,00 mm



2.50x2,50x4,00



Knorr No: SEB22517

01.1201.00

Piston (Ø80,00 mm)

- 01.1201.10 80,25 mm
- 01.1201.20 80,50 mm
- 01.1201.30 80,75 mm
- 01.1201.40 81,00 mm

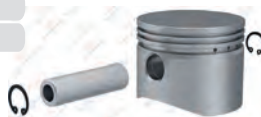

2.50x2,50x4,00



01.1226.00

Ring (Ø80,00 mm)

- 01.1226.10 80,25 mm
- 01.1226.20 80,50 mm
- 01.1226.30 80,75 mm
- 01.1226.40 81,00 mm



2.50x2,50x4,00



01.374

Cover



01.870

Nut



M18X1.5 - Right Hand



## Twin Cylinder Compressor Ø86 mm- CC-Stroke mm

Application - Vehicle  
CUMMINS



**01.04.191**

Oem. Ref. No.  
5339231

Knorr No.  
LK4984  
K068756N00



8 680437 127918



**01.1702** Crankcase



8 680437 127994

**RK.01.772.05** Repair Kit



8 680437 127970

Knorr No: K090939K50

**RK.01.772.06** Repair Kit



8 680437 127987

Knorr No: K091081K50

**RK.01.770**

Complete Cylinder Head



8 680437 127925

**RK.01.770.01**

Complete Cylinder Head



8 680437 127932

Knorr No: K090971K50

**RK.01.771**

Valve Plate Kit



8 680437 127949

Knorr No: K090953K50

**RK.01.772.01**

Repair Kit

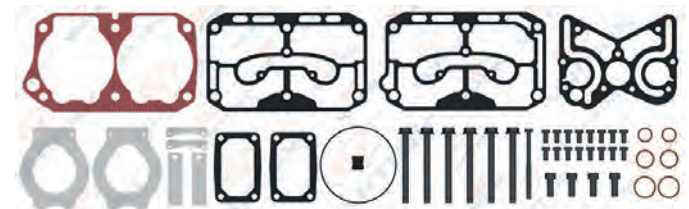

8 680437 127963

Knorr No: K090975K50

**RK.01.772**

Repair Kit

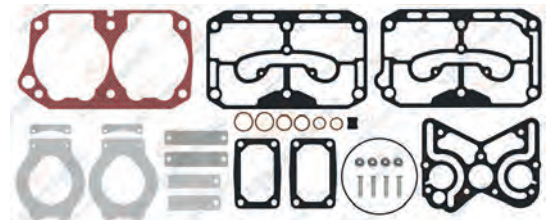

8 680437 127956

# CUMMINS-VOLKSWAGEN-JOHN DEERE FORD BRASIL-CATERPILLAR-MACK

AIR COMPRESSOR AND REPAIR KIT

01.1621

Cylinder Head



8 680437 128038

01.1505

Cylinder Head



8 680437 104544

01.1703

Crankshaft



8 680437 128007

01.1704

Valve Plate



8 680437 128014

01.1705

Cooling Plate



8 680437 128021

Knorr No: K068429

01.226

Connecting Rod



8 680437 019824

Knorr No: SEB00967004

RK.01.272.00

Piston&Ring (Ø86,00 mm)

- RK.01.272.10 86,25 mm
- RK.01.272.20 86,50 mm
- RK.01.272.30 86,75 mm
- RK.01.272.40 87,00 mm



2.00x2.00x3.00



8 680437 063209

Knorr No: SEB22547 - SEB22548

01.868.00

Piston (Ø86,00 mm)

- 01.868.10 86,25 mm
- 01.868.20 86,50 mm
- 01.868.30 86,75 mm
- 01.868.40 87,00 mm



2.00x2.00x3.00



8 680437 027676

01.869.00

Ring (Ø86,00 mm)

- 01.869.10 86,25 mm
- 01.869.20 86,50 mm
- 01.869.30 86,75 mm
- 01.869.40 87,00 mm



2.00x2.00x3.00



8 680437 027737

01.1717

Crankshaft Flange



8 680437 128045



# Single Cylinder Compressor Ø92 mm-360 CC-Stroke 54 mm

Application - Vehicle  
DETROIT DIESEL ENGINE DDC S60



**01.04.220**

**Oem. Ref. No.**

- 23536774
- 5018652
- 5018654
- 5018655
- 5018653
- 802789
- 5018653



**01.1922** Crankcase



**RK.01.614.08** Repair Kit

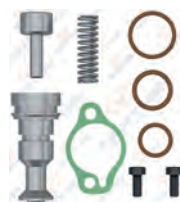

Knorr No: K137939

**RK.01.856** Complete Cylinder Head



**RK.01.611.01** Valve Plate Kit

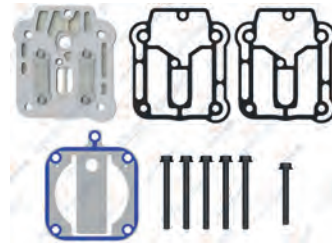

Knorr No: K137938

**RK.01.611** Valve Plate Kit

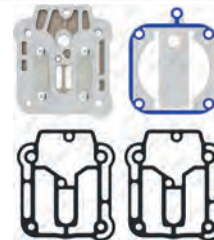

**RK.01.614** Repair Kit

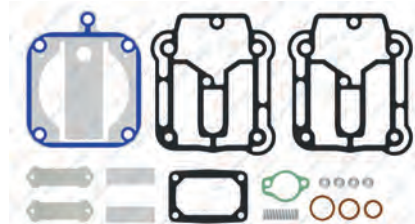

**RK.01.614.01** Repair Kit

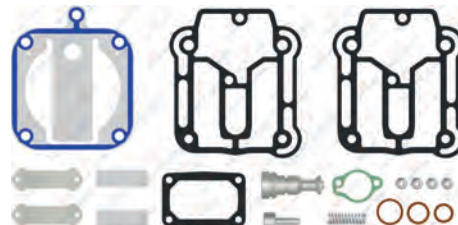

# CUMMINS-VOLKSWAGEN-JOHN DEERE FORD BRASIL-CATERPILLAR-MACK

## AIR COMPRESSOR AND REPAIR KIT

01.1849

Cylinder Head



8 680437 141105

01.1212

Cooling Plate



8 680437 017707

01.1904

Crankshaft



8 680437 163657

01.1213

Valve Plate



8 680437 017714

Knorr No: K011811

01.1905

Bearing



8 680437 163664

01.1895

Connecting Rod



8 680437 163671

RK.01.318.00

Piston&Ring (Ø92,00 mm)

- RK.01.318.10 92,25 mm
- RK.01.318.20 92,50 mm
- RK.01.318.30 92,75 mm
- RK.01.318.40 93,00 mm



2.50x2,50x4,00



8 680437 063773

Knorr No: K012079 - K006026

01.862.00

Piston (Ø92,00 mm)

- 01.862.10 92,25 mm
- 01.862.20 92,50 mm
- 01.862.30 92,75 mm
- 01.862.40 93,00 mm



2.50x2,50x4,00



8 680437 027584

01.942.00

Ring (Ø92,00 mm)

- 01.942.10 92,25 mm
- 01.942.20 92,50 mm
- 01.942.30 92,75 mm
- 01.942.40 93,00 mm



2.50x2,50x4,00



8 680437 028666

01.1902

Gear



8 680437 163688

01.1903

Flange for Gear



8 680437 163695

## Single Cylinder Compressor Ø92 mm-360 CC-Stroke 54 mm

Application - Vehicle  
BENDIX BA-921  
CATERPILLAR  
DETROIT DIESEL ENGINE DDC S60 (PRE 2007)



**01.04.221**

**Oem. Ref. No.**

5018485  
5018514  
5018522  
5018523  
5018516  
802767



8 680437 137658



**01.1890**

Crankcase



OEM No: 5010119

**680**

ALL ORIGINAL NUMBERS, MARKS AND MODELS FROM VEHICLE MANUFACTURES LISTED IN THIS CATALOGUE ARE FOR COMPARISON PURPOSES ONLY

**RK.01.865**

Complete Cylinder Head



8 680437 163701

**RK.01.609.03**

Valve Plate Kit

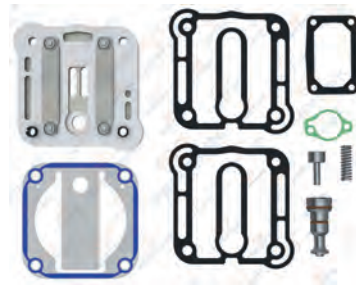

8 680437 160991

**RK.01.609.02**

Valve Plate Kit

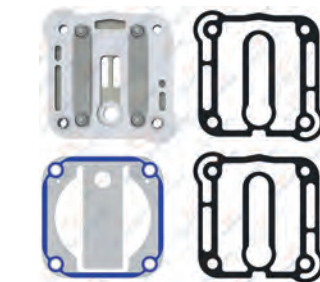

8 680437 160984

**RK.01.395.07**

Repair Kit

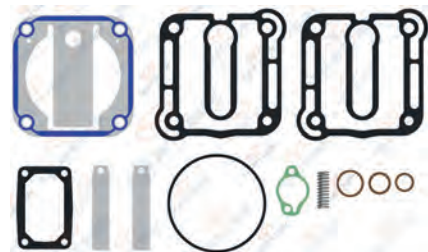

8 680437 078463

**RK.01.614.07**

Repair Kit

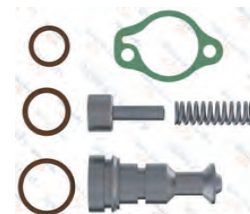

8 680437 118411



# CUMMINS-VOLKSWAGEN-JOHN DEERE FORD BRASIL-CATERPILLAR-MACK

## AIR COMPRESSOR AND REPAIR KIT

01.1906

Cylinder Head



01.1907

Cooling Plate



01.1904

Crankshaft



01.1204

Valve Plate



Knorr No: Y004552004

01.1905

Bearing



01.1895

Connecting Rod



RK.01.318.00

Piston&Ring (Ø92,00 mm)

- RK.01.318.10 92,25 mm
- RK.01.318.20 92,50 mm
- RK.01.318.30 92,75 mm
- RK.01.318.40 93,00 mm



2.50x2,50x4,00



OEM No: SEB22530  
Knorr No: K012079

01.862.00

Piston (Ø92,00 mm)

- 01.862.10 92,25 mm
- 01.862.20 92,50 mm
- 01.862.30 92,75 mm
- 01.862.40 93,00 mm



2.50x2,50x4,00



01.942.00

Ring (Ø92,00 mm)

- 01.942.10 92,25 mm
- 01.942.20 92,50 mm
- 01.942.30 92,75 mm
- 01.942.40 93,00 mm



2.50x2,50x4,00



01.374

Cover



01.1902

Gear



01.1903

Flange for Gear



## Single Cylinder Compressor Ø92 mm-360 CC-Stroke 54 mm

**Application - Vehicle**  
 CATERPILLAR BA-921  
 C7 ACERT - C9 ACERT  
 C11 ACERT - C13 ACERT  
 C15 ACERT - C18 ACERT



**01.04.222**

Oem. Ref. No.	Bendix / Knorr
2233636	5014428
2531736	5011441 / 5012459 /
2554160	5012464 / 5012510 /
3537136	5014177 / 5014180 /
3850936	5014235 / 5014236 /
	5014401 / 5014402 /
	5014427 / 801465 /
	801798 / 801826
	K048938 / K048939
	K048940 / K056647
	K056649 / K066811
	K066831 / K066837



**01.1889**

**Crankcase**



OEM No: 50111432

**RK.01.857**

**Complete Cylinder Head**



**RK.01.609.03**

**Valve Plate Kit**

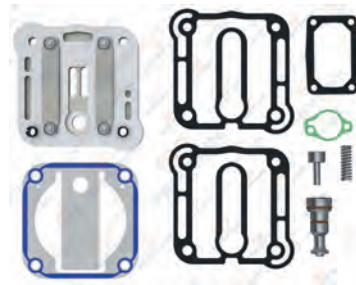

**RK.01.609.02**

**Valve Plate Kit**

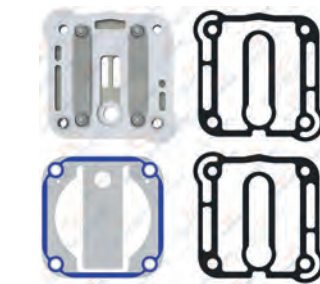

**RK.01.395.07**

**Repair Kit**

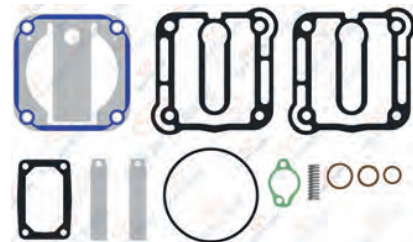

**RK.01.614.07**

**Repair Kit**

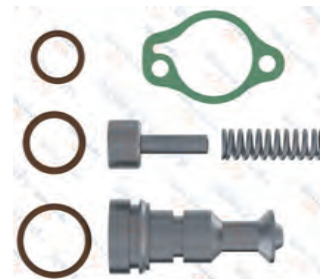

# CUMMINS-VOLKSWAGEN-JOHN DEERE FORD BRASIL-CATERPILLAR-MACK AIR COMPRESSOR AND REPAIR KIT

01.1859

Cylinder Head



01.1864

Cooling Plate



01.1901

Crankshaft

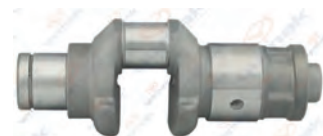

01.1204

Valve Plate



Knorr No: Y004552004

01.1893

Crankshaft Flange



01.1895

Connecting Rod



RK.01.318.00

Piston&Ring (Ø92,00 mm)

- RK.01.318.10 92,25 mm
- RK.01.318.20 92,50 mm
- RK.01.318.30 92,75 mm
- RK.01.318.40 93,00 mm



2.50x2,50x4,00



OEM No: SEB22530  
Knorr No: K012079

01.862.00

Piston (Ø92,00 mm)

- 01.862.10 92,25 mm
- 01.862.20 92,50 mm
- 01.862.30 92,75 mm
- 01.862.40 93,00 mm



2.50x2,50x4,00



01.942.00

Ring (Ø92,00 mm)

- 01.942.10 92,25 mm
- 01.942.20 92,50 mm
- 01.942.30 92,75 mm
- 01.942.40 93,00 mm



2.50x2,50x4,00



01.1900

Cover



01.1896

Screw



01.1891

Gear



OEM No: F5733X0

01.1898

Lubrication Hose





## Single Cylinder Compressor Ø92 mm-360 CC-Stroke 54 mm

Application - Vehicle  
BENDIX BA-921  
CATERPILLAR  
DETROIT DIESEL S60



**01.04.223**

Oem. Ref. No.	Bendix / Knorr
5012533	5012531
2233637	5012532
3049991	801463
3537137	
3850937	K020283 / K020284
	K020285 / K048941
	K048942 / K048943
	K066812 / K066832
	K066838



01.1889

Crankcase



OEM No: 50111432



RK.01.857

Complete Cylinder Head



RK.01.609.03

Valve Plate Kit

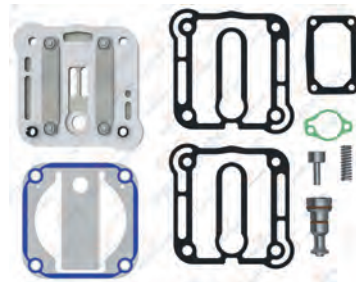

RK.01.609.02

Valve Plate Kit

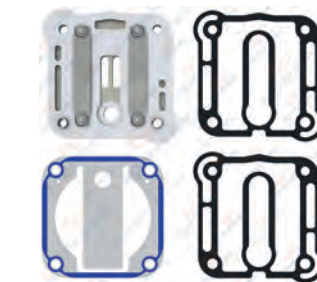

RK.01.395.07

Repair Kit

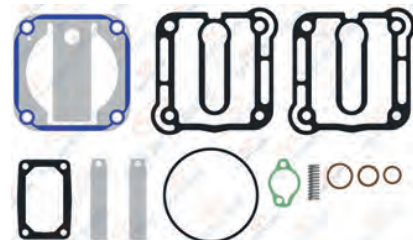

RK.01.614.07

Repair Kit

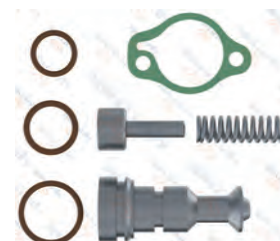

# CUMMINS-VOLKSWAGEN-JOHN DEERE FORD BRASIL-CATERPILLAR-MACK

## AIR COMPRESSOR AND REPAIR KIT

01.1859

Cylinder Head



01.1864

Cooling Plate



01.1901

Crankshaft



01.1204

Valve Plate



Knorr No: Y004552004

01.1894

Crankshaft Flange



01.1895

Connecting Rod



RK.01.318.00

Piston&Ring (Ø92,00 mm)

- RK.01.318.10 92,25 mm
- RK.01.318.20 92,50 mm
- RK.01.318.30 92,75 mm
- RK.01.318.40 93,00 mm



2.50x2,50x4,00



OEM No: SEB22530  
Knorr No: K012079

01.862.00

Piston (Ø92,00 mm)

- 01.862.10 92,25 mm
- 01.862.20 92,50 mm
- 01.862.30 92,75 mm
- 01.862.40 93,00 mm



2.50x2,50x4,00



01.942.00

Ring (Ø92,00 mm)

- 01.942.10 92,25 mm
- 01.942.20 92,50 mm
- 01.942.30 92,75 mm
- 01.942.40 93,00 mm



2.50x2,50x4,00



01.374

Cover



01.1896

Screw



01.1892

Gear



OEM No: F5733X0\*

## Single Cylinder Compressor Ø92 mm - 360 CC

Application - Vehicle  
BENDIX BA-921 CLOSED ROOM  
MAXXFORCE 11L/13L



**01.04.207**

Oem Ref. No.  
2514355C1  
3709220C92

Knorr No.  
K042162  
K044642SC



**01.1172.10** Crankcase



**RK.01.614.10** Repair Kit

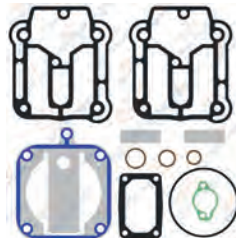

Knorr No: K011818

**RK.01.614.09** Repair Kit

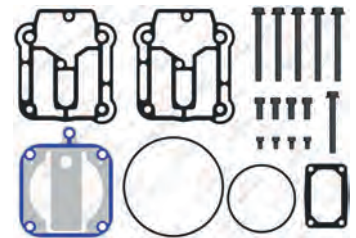

Knorr No: K137936

**RK.01.856**

Complete Cylinder Head



**RK.01.611.01**

Valve Plate Kit

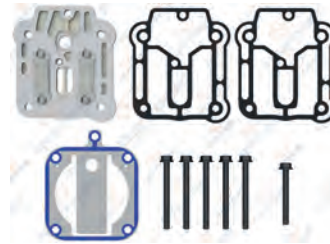

Knorr No: K137938

**RK.01.611**

Valve Plate Kit

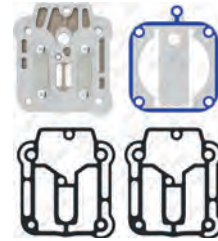

**RK.01.614.11**

Repair Kit

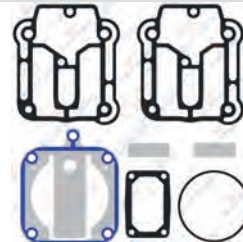

Knorr No: K011815

**RK.01.614.12**

Repair Kit

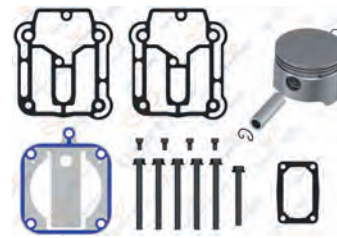

Knorr No: K099418



# CUMMINS-VOLKSWAGEN-JOHN DEERE FORD BRASIL-CATERPILLAR-MACK AIR COMPRESSOR AND REPAIR KIT

01.1849

Cylinder Head



8 680437 141105

01.1212

Cooling Plate



8 680437 017707

01.1022

Crankshaft



M18X1.5 Left Hand



8 680437 014874

01.1213

Valve Plate

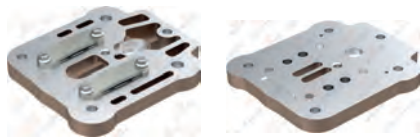

8 680437 017714

Knorr No: K011811

01.1148

Crankshaft Flange



8 680437 016816

01.1101

Connecting Rod



8 680437 016069

RK.01.318.00

Piston&Ring (Ø92,00 mm)

- RK.01.318.10 92,25 mm
- RK.01.318.20 92,50 mm
- RK.01.318.30 92,75 mm
- RK.01.318.40 93,00 mm



2.50x2,50x4,00



8 680437 063773

Knorr No: K012079 - K006026

01.862.00

Piston (Ø92,00 mm)

- 01.862.10 92,25 mm
- 01.862.20 92,50 mm
- 01.862.30 92,75 mm
- 01.862.40 93,00 mm



2.50x2,50x4,00



8 680437 027584

01.942.00

Ring (Ø92,00 mm)

- 01.942.10 92,25 mm
- 01.942.20 92,50 mm
- 01.942.30 92,75 mm
- 01.942.40 93,00 mm



2.50x2,50x4,00



8 680437 028666

RK.01.614.08

Repair Kit



8 680437 128229

Knorr No: K137939

RK.01.722

Gear Kit



8 680437 129295

Knorr No: K017357

01.1174

Gear



Notch (Tooth) Pcs : 29



8 680437 017202

OEM No: 51542106045

## Twin Cylinder Compressor Ø92 mm - 720 CC - Stroke 54 mm

Application - Vehicle  
INTERNATIONAL  
MAXXFORCE



**01.04.113**

Oem. No.  
3624500C92

Knorr No.  
K048595



**01.1229** Crankcase



**RK.01.602.04** Repair Kit

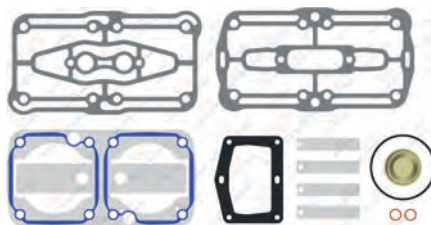

Use for old version cylinder repair kit.  
Yıpranmış kapaklar için.

**RK.01.494.05** Repair Kit

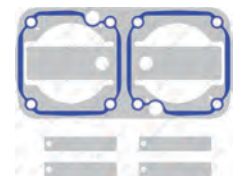

**RK.01.603**

Complete Cylinder Head



**RK.01.603.01**

Complete Cylinder Head



**RK.01.604**

Valve Plate Kit



**RK.01.602.01**

Repair Kit

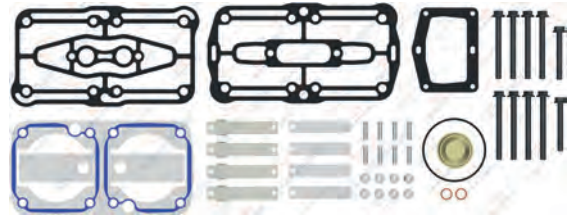

**RK.01.602**

Repair Kit

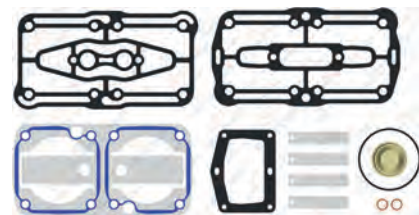

# CUMMINS-VOLKSWAGEN-JOHN DEERE FORD BRASIL-CATERPILLAR-MACK

## AIR COMPRESSOR AND REPAIR KIT

01.1025

Cylinder Head



Knorr No : Z008260004

01.1026

Cooling Plate



01.1080

Crankshaft



M18X1.5 Left Hand



01.1057

Valve Plate



OEM No : 51541246005  
Knorr No : K019525

01.1148

Crankshaft Flange



01.1056

Connecting Rod



RK.01.318.00

Piston&Ring (Ø92,00 mm)

- RK.01.318.10 92,25 mm
- RK.01.318.20 92,50 mm
- RK.01.318.30 92,75 mm
- RK.01.318.40 93,00 mm



2,50x2,50x4,00



Knorr. No.:K006026

01.862.00

Piston (Ø92,00 mm)

- 01.862.10 92,25 mm
- 01.862.20 92,50 mm
- 01.862.30 92,75 mm
- 01.862.40 93,00 mm



2,50x2,50x4,00



01.942.00

Ring (Ø92,00 mm)

- 01.942.10 92,25 mm
- 01.942.20 92,50 mm
- 01.942.30 92,75 mm
- 01.942.40 93,00 mm



2,50x2,50x4,00



01.1195

Cover



01.920

Cap



01.1174

Gear

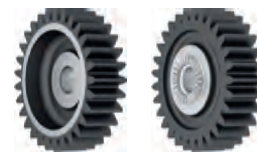

Notch (Tooth) Pcs : 29



01.292

Bushing



42X38X25



01.1416

Screw



M18X1.5 Left Hand



RK.01.722

Gear Kit



Knorr No: K017357



# Single Cylinder Compressor Ø80 mm-225 CC-Stroke 45 mm

Application - Vehicle  
CUMMINS



**01.04.126**

Oem. Ref. No.

Knorr No.  
LK3857  
SEB01813



**01.1390** Crankcase



**RK.01.159.20** Repair Kit

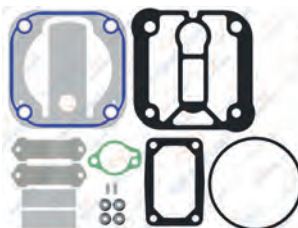

**RK.01.159.22** Repair Kit

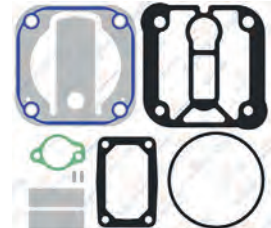

**RK.01.615** Complete Cylinder Head



**RK.01.616.01** Valve Plate Kit



**RK.01.616** Valve Plate Kit



Oem. No: 9P918391  
Knorr No: SEB01593004

**RK.01.159.25** Repair Kit

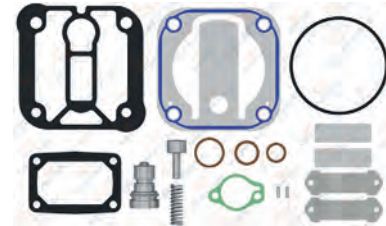

Oem. No: 9P918389

**RK.01.159.18** Repair Kit

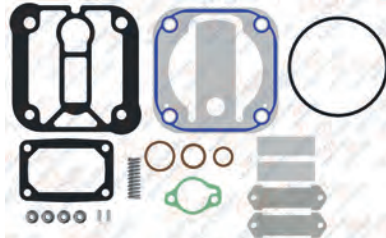

# CUMMINS-VOLKSWAGEN-JOHN DEERE FORD BRASIL-CATERPILLAR-MACK AIR COMPRESSOR AND REPAIR KIT

01.1208

Cylinder Head



Oem. No: 9P918392  
Knorr No: SEB01814004

01.1219

Valve Plate



Knorr No: SEB01915004

01.1338

Crankshaft



5/8 - 18 UNF



01.820

Bushing



42x38x25



01.1389

Crankshaft Flange



01.1101

Connecting Rod



RK.01.601.00

Piston&Ring (Ø80,00 mm)

RK.01.601.10 80,25 mm

RK.01.601.20 80,50 mm

RK.01.601.30 80,75 mm

RK.01.601.40 81,00 mm



2.50x2,50x4,00



Knorr No: SEB22517

01.1201.00

Piston (Ø80,00 mm)

01.1201.10 80,25 mm

01.1201.20 80,50 mm

01.1201.30 80,75 mm

01.1201.40 81,00 mm



2.50x2,50x4,00



01.1226.00

Ring (Ø80,00 mm)

01.1226.10 80,25 mm

01.1226.20 80,50 mm

01.1226.30 80,75 mm

01.1226.40 81,00 mm



2.50x2,50x4,00



RK.01.159.05

Repair Kit

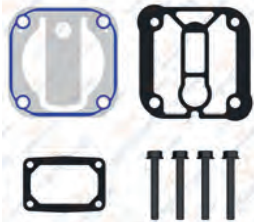

Knorr No: SEB018190051

RK.01.159.27

Repair Kit

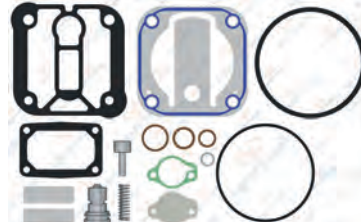

Knorr No: SEB22519\*

01.374

Cover



RK.01.532

Repair Kit

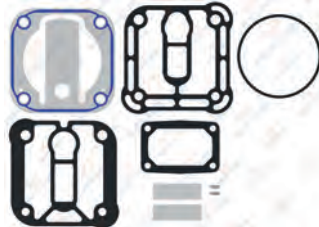

01.1658

Nut



5/8 - 18 UNF



## Single Cylinder Compressor Ø85 mm-318 CC-Stroke 56 mm

Application - Vehicle  
MACK

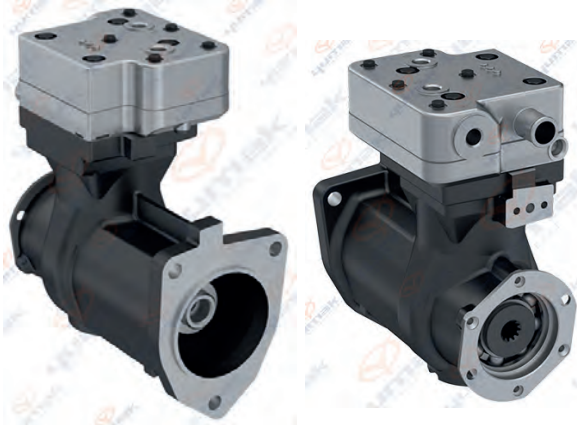

**01.04.123**

Oem. Ref. No.  
303GB5129M

Wabco No.  
9111535400



**01.1591**

Crankcase



**RK.01.067.05**

Repair Kit

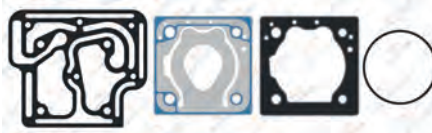

**RK.01.067.06**

Repair Kit



**RK.01.564**

Complete Cylinder Head



Wabco No: 9111539432

**RK.01.067.01**

Repair Kit

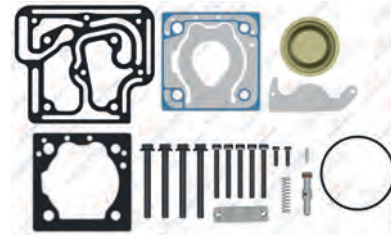

**RK.01.067.02**

Repair Kit

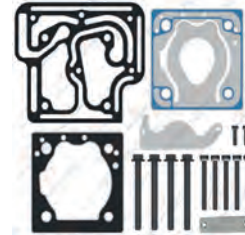

Wabco No: 9111549292

**RK.01.067**

Repair Kit

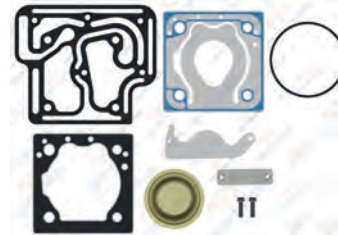

**RK.01.067.04**

Repair Kit

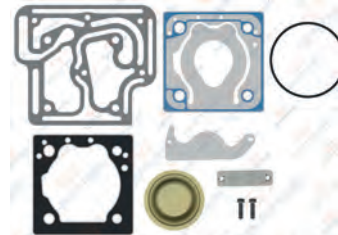

Use for old version cylinder repair kit. Yıpranmış kapaklar için.



# CUMMINS-VOLKSWAGEN-JOHN DEERE FORD BRASIL-CATERPILLAR-MACK

## AIR COMPRESSOR AND REPAIR KIT

01.953

Cylinder Head

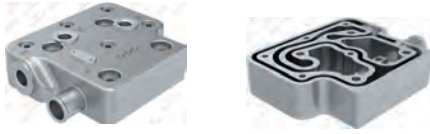

8 680437 028789

01.901.10

Valve Plate



8 680437 028178

01.1635

Crankshaft



8 680437 108870

01.1222

Flange



8 680437 017844

Wabco No: 9111539252

01.272

Connecting Rod



8 680437 020400

Wabco No: 9111457372

00.999

Roller Bearing



6308



8 680437 009627

RK.01.104.00

Piston&Ring (Ø85,00 mm)

- RK.01.104.10 85,25 mm
- RK.01.104.20 85,50 mm
- RK.01.104.30 85,75 mm
- RK.01.104.40 86,00 mm



2.00x2,00x4,00



8 680437 060277

01.142.00

Piston (Ø85,00 mm)

- 01.142.10 85,25 mm
- 01.142.20 85,50 mm
- 01.142.30 85,75 mm
- 01.142.40 86,00 mm



2.00x2,00x4,00



8 680437 018674

Wabco No: 9115016242 - 9115016252

01.373.00

Ring (Ø85,00 mm)

- 01.373.10 85,25 mm
- 01.373.20 85,50 mm
- 01.373.30 85,75 mm
- 01.373.40 86,00 mm



2.00x2,00x4,00



8 680437 075431

Wabco No: 9115019202

RK.01.513

Repair Kit

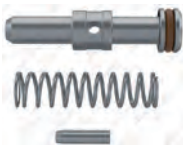

8 680437 066057

01.1884

Coupling



8 680437 163831

01.1683

Cover



8 680437 139508

## Single Cylinder Compressor Ø85 mm-318 CC-Stroke 56 mm

Application - Vehicle  
MACK



**01.04.206**

Oem. Ref. No.  
303GB5129AM

Wabco No.  
9111530550



**01.1591**

Crankcase



**RK.01.067.05**

Repair Kit



**RK.01.067.06**

Repair Kit

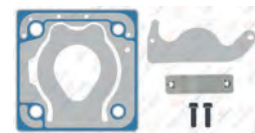

**RK.01.564**

Complete Cylinder Head

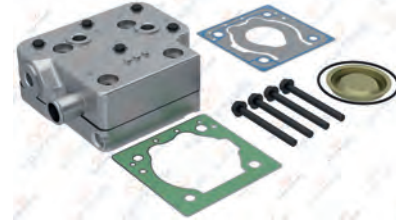

Wabco No: 9111539432

**RK.01.067.01**

Repair Kit

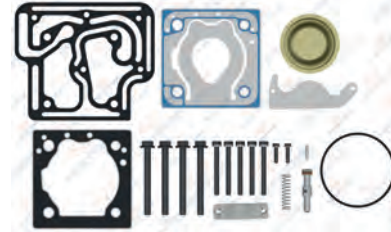

**RK.01.067.02**

Repair Kit

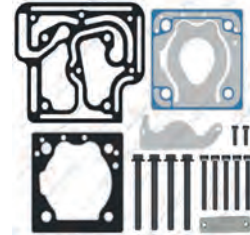

Wabco No: 9111549292

**RK.01.067**

Repair Kit

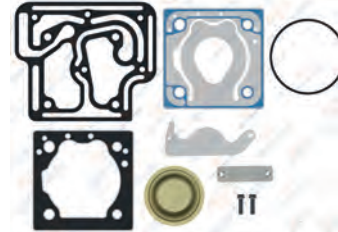

**RK.01.067.04**

Repair Kit

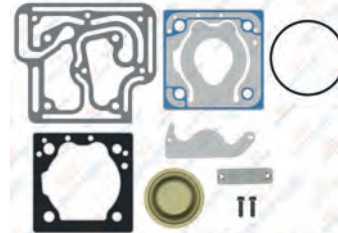

Use for old version cylinder repair kit. Yıpranmış kapaklar için.

# CUMMINS-VOLKSWAGEN-JOHN DEERE FORD BRASIL-CATERPILLAR-MACK

## AIR COMPRESSOR AND REPAIR KIT

01.953

Cylinder Head

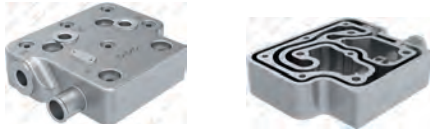

8 680437 028789

01.901.10

Valve Plate



8 680437 028178

01.1635

Crankshaft



8 680437 108870

01.1222

Flange



8 680437 017844

Wabco No: 9111539252

01.272

Connecting Rod



8 680437 020400

Wabco No: 9111457372

00.999

Roller Bearing



6308



8 680437 009627

RK.01.104.00

Piston&Ring (Ø85,00 mm)

- RK.01.104.10 85,25 mm
- RK.01.104.20 85,50 mm
- RK.01.104.30 85,75 mm
- RK.01.104.40 86,00 mm



2.00x2.00x4.00



8 680437 060277

01.142.00

Piston (Ø85,00 mm)

- 01.142.10 85,25 mm
- 01.142.20 85,50 mm
- 01.142.30 85,75 mm
- 01.142.40 86,00 mm



2.00x2.00x4.00



8 680437 018674

Wabco No: 9115016242 - 9115016252

01.373.00

Ring (Ø85,00 mm)

- 01.373.10 85,25 mm
- 01.373.20 85,50 mm
- 01.373.30 85,75 mm
- 01.373.40 86,00 mm



2.00x2.00x4.00



8 680437 075431

Wabco No: 9115019202

RK.01.513

Repair Kit

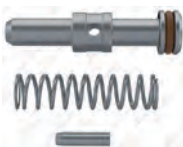

8 680437 066057

01.1884

Coupling



8 680437 163831

01.1863

Cover



8 680437 141327



## Single Cylinder Compressor Ø85 mm-318 CC-Stroke 56 mm

Application - Vehicle  
CUMMINS  
ISX / L / M / N / ISC / B

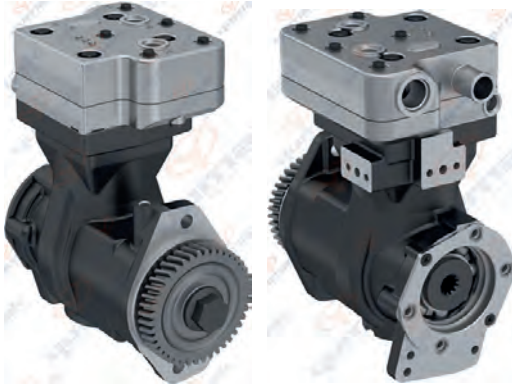

**01.04.124**

Oem. Ref. No.  
3944525

Wabco No.  
9111535300

**01.04.124.10**

Without Gear



**01.1592**

Crankcase



**RK.01.067.05**

Repair Kit

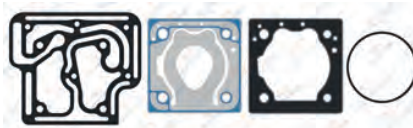

**RK.01.430** Complete Cylinder Head



Wabco No: 9111539202

**RK.01.067.01**

Repair Kit

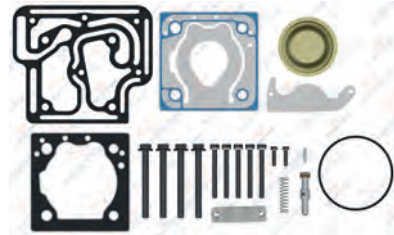

**RK.01.067.02**

Repair Kit

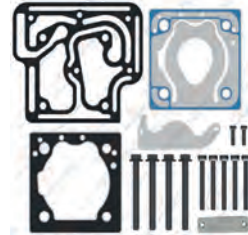

Wabco No: 9111549292

**RK.01.067**

Repair Kit

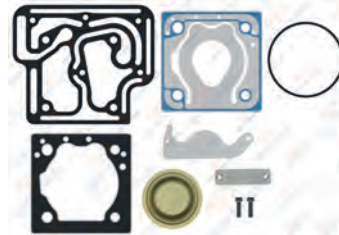

**RK.01.067.04**

Repair Kit

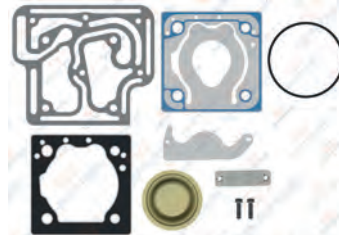

Use for old version cylinder repair kit. Yıpranmış kapaklar için.

**RK.01.067.06**

Repair Kit



# CUMMINS-VOLKSWAGEN-JOHN DEERE FORD BRASIL-CATERPILLAR-MACK

## AIR COMPRESSOR AND REPAIR KIT

01.990

Cylinder Head

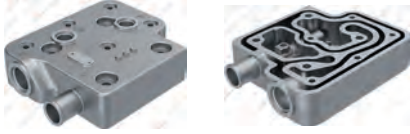

8 680437 029559

01.901

Valve Plate



8 680437 028178

01.1636

Crankshaft



8 680437 079811

01.1225

Gear



8 680437 017875

Wabco No: 3942497 - 3940239

01.1222

Flange



8 680437 017844

Wabco No: 9111539252

01.272

Connecting Rod



8 680437 020400

Wabco No: 9111457372

RK.01.104.00

Piston&Ring (Ø85,00 mm)

- RK.01.104.10 85,25 mm
- RK.01.104.20 85,50 mm
- RK.01.104.30 85,75 mm
- RK.01.104.40 86,00 mm



2.00x2,00x4,00



8 680437 060277

01.142.00

Piston (Ø85,00 mm)

- 01.142.10 85,25 mm
- 01.142.20 85,50 mm
- 01.142.30 85,75 mm
- 01.142.40 86,00 mm



2.00x2,00x4,00



8 680437 018674

Wabco No: 9115016242 - 9115016252

01.373.00

Ring (Ø85,00 mm)

- 01.373.10 85,25 mm
- 01.373.20 85,50 mm
- 01.373.30 85,75 mm
- 01.373.40 86,00 mm



2.00x2,00x4,00



8 680437 075431

Wabco No: 9115019202

RK.01.513

Repair Kit

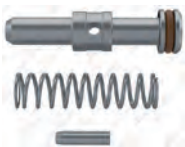

8 680437 066057

00.999

Roller Bearing



6308



8 680437 009627

01.1643

Screw



M20X1.5 - Right Hand



8 680437 091073

## Single Cylinder Compressor Ø85 mm-318 CC-Stroke 56 mm

Application - Vehicle  
CUMMINS  
ISX / L / M / N / ISC / B

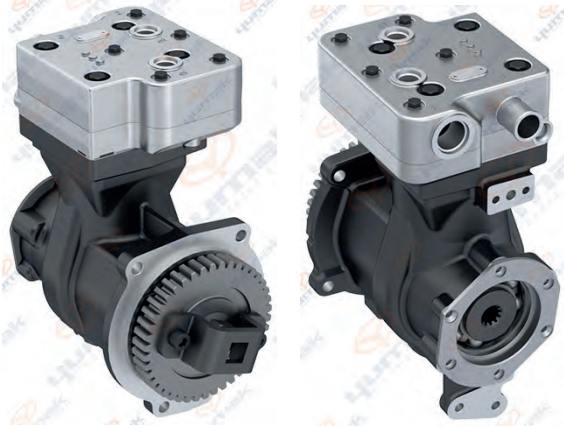

**01.04.125**

Oem. Ref. No.	Wabco No.
3681904	9111535100
3681902	
3103413	

**01.04.125.10**

Without Gear



**01.1593** Crankcase



**RK.01.067.05** Repair Kit



**RK.01.483** Complete Cylinder Head



Wabco No: 9111539212

**RK.01.067.01** Repair Kit

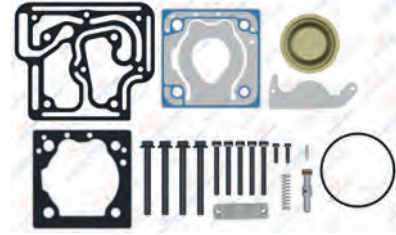

**RK.01.067.02** Repair Kit

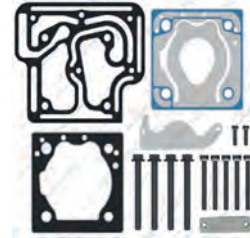

Wabco No: 9111549292

**RK.01.067** Repair Kit

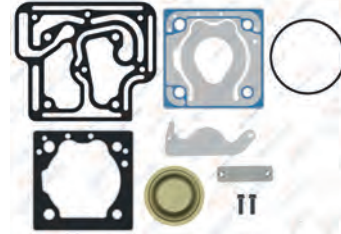

**RK.01.067.04** Repair Kit

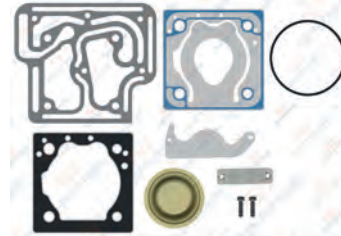

Use for old version cylinder repair kit. Yıpranmış kapaklar için.

**RK.01.067.06** Repair Kit

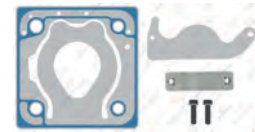



# CUMMINS-VOLKSWAGEN-JOHN DEERE FORD BRASIL-CATERPILLAR-MACK

## AIR COMPRESSOR AND REPAIR KIT

01.900

Cylinder Head



01.901

Valve Plate



01.1564

Crankshaft



00.999

Roller Bearing



6308



01.1222

Flange



Wabco No: 9111539252

01.272

Connecting Rod



Wabco No: 9111457372

RK.01.104.00

Piston&Ring (Ø85,00 mm)

- RK.01.104.10 85,25 mm
- RK.01.104.20 85,50 mm
- RK.01.104.30 85,75 mm
- RK.01.104.40 86,00 mm



2.00x2,00x4,00



01.142.00

Piston (Ø85,00 mm)

- 01.142.10 85,25 mm
- 01.142.20 85,50 mm
- 01.142.30 85,75 mm
- 01.142.40 86,00 mm

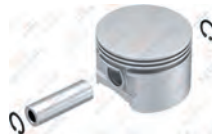

2.00x2,00x4,00



Wabco No: 9115016242 - 9115016252

01.373.00

Ring (Ø85,00 mm)

- 01.373.10 85,25 mm
- 01.373.20 85,50 mm
- 01.373.30 85,75 mm
- 01.373.40 86,00 mm



2.00x2,00x4,00



Wabco No: 9115019202

01.1646

Gear



Oem No: 3680550

01.1643

Screw



M20X1.5 - Right Hand



01.1641

Adapter



RK.01.513

Repair Kit

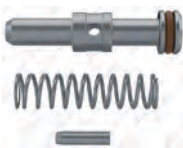

01.1782

Gear Adapter



## Single Cylinder Compressor Ø85 mm-318 CC-Stroke 56 mm

Application - Vehicle  
CUMMINS

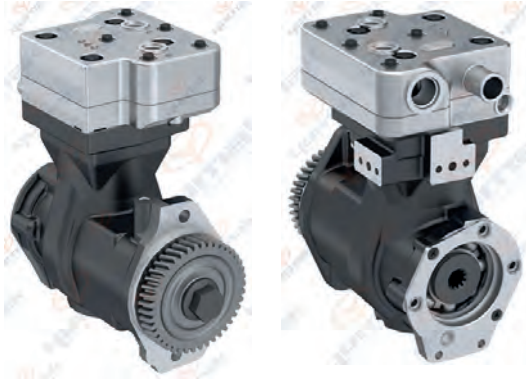

**01.04.183**

Oem. Ref. No.

5272928  
4991799  
5286970  
5301100

Wabco No.

9111530200



**01.1650**

Crankcase



**RK.01.067.05**

Repair Kit



**RK.01.067.06**

Repair Kit

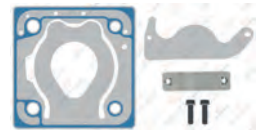

**RK.01.430**

Complete Cylinder Head



Wabco No: 9111539202

**RK.01.067.01**

Repair Kit

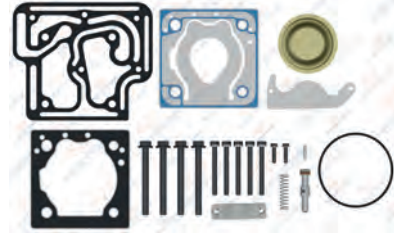

**RK.01.067.02**

Repair Kit

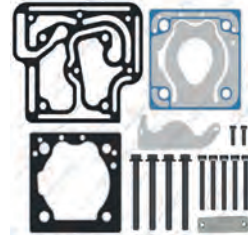

Wabco No: 9111549292

**RK.01.067**

Repair Kit

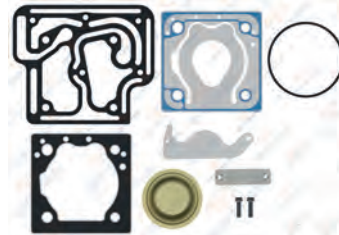

**RK.01.067.04**

Repair Kit

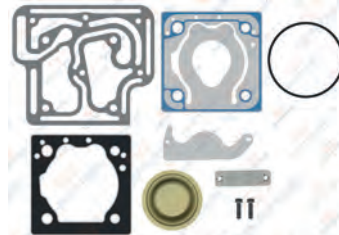

Use for old version cylinder repair kit. Yıpranmış kapaklar için.

# CUMMINS-VOLKSWAGEN-JOHN DEERE FORD BRASIL-CATERPILLAR-MACK AIR COMPRESSOR AND REPAIR KIT

01.990

Cylinder Head

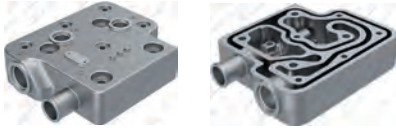

8 680437 029559

01.901

Valve Plate



8 680437 028178

01.1636

Crankshaft



8 680437 079811

00.999

Roller Bearing



6308



8 680437 009627

01.1222

Flange



Wabco No: 9111539252

01.272

Connecting Rod



Wabco No: 9111457372

RK.01.104.00

Piston&Ring (Ø85,00 mm)

- RK.01.104.10 85,25 mm
- RK.01.104.20 85,50 mm
- RK.01.104.30 85,75 mm
- RK.01.104.40 86,00 mm



2.00x2.00x4.00



8 680437 060277

01.142.00

Piston (Ø85,00 mm)

- 01.142.10 85,25 mm
- 01.142.20 85,50 mm
- 01.142.30 85,75 mm
- 01.142.40 86,00 mm



2.00x2.00x4.00



Wabco No: 9115016242 - 9115016252

01.373.00

Ring (Ø85,00 mm)

- 01.373.10 85,25 mm
- 01.373.20 85,50 mm
- 01.373.30 85,75 mm
- 01.373.40 86,00 mm



2.00x2.00x4.00



Wabco No: 9115019202

RK.01.513

Repair Kit

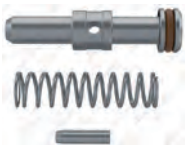

8 680437 066057

01.1225

Gear



Wabco No: 3942497 - 3940239

01.1643

Screw



M20X1.5 - Right Hand



8 680437 091073



## Single Cylinder Compressor Ø75 mm-247 CC-Stroke 56 mm

Application - Vehicle  
CUMMINS



**01.05.162**

Wabco No.  
9111545100



**RK.01.669**

Complete Cylinder Head



**RK.01.450.02**

Repair Kit

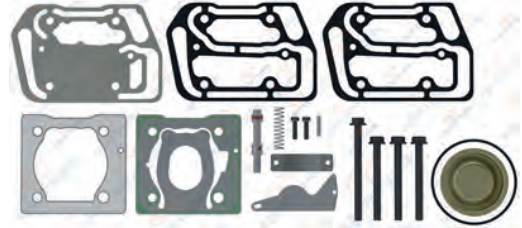

**RK.01.450.01**

Repair Kit

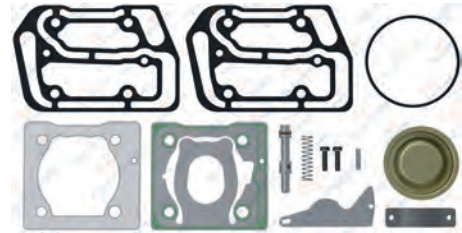

**RK.01.450**

Repair Kit

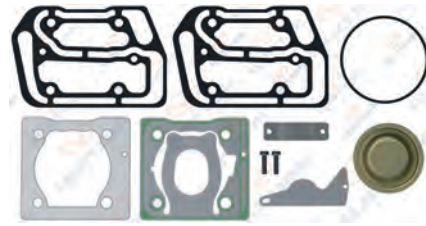

**RK.01.450.06**

Repair Kit



Wabco No: 9111549242

Crankcase

**RK.01.450.03**

Repair Kit

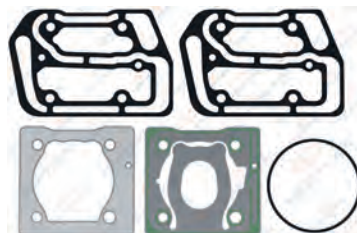

**RK.01.450.04**

Repair Kit

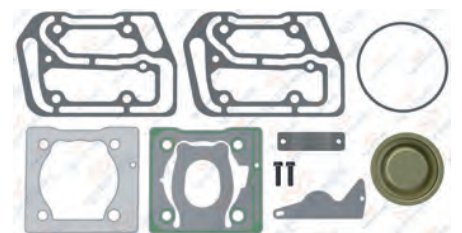

Use for old version cylinder repair kit.  
Yıpranmış kapaklar için.

# CUMMINS-VOLKSWAGEN-JOHN DEERE FORD BRASIL-CATERPILLAR-MACK

## AIR COMPRESSOR AND REPAIR KIT

01.1497

Cylinder Head



8 680437 080022

01.1498

Valve Plate



8 680437 078418

01.1404

Crankshaft



8 680437 108627

01.1499

Cooling Plate



8 680437 079576

01.1222

Flange



8 680437 017844

Wabco No: 9111539252

01.1224

Connecting Rod



8 680437 017868

RK.01.118.00

Piston&Ring (Ø75,00 mm)

RK.01.118.10 75,25 mm

RK.01.118.20 75,50 mm

RK.01.118.30 75,75 mm

RK.01.118.40 76,00 mm



2.00x2.00x4.00



8 680437 060482

Wabco No: 4111416232 - 4115226202

01.911.00

Piston (Ø75,00 mm)

01.911.10 75,25 mm

01.911.20 75,50 mm

01.911.30 75,75 mm

01.911.40 76,00 mm



2.00x2.00x4.00



8 680437 028277

01.134.00

Ring (Ø75,00 mm)

01.134.10 75,25 mm

01.134.20 75,50 mm

01.134.30 75,75 mm

01.134.40 76,00 mm



2.00x2.00x4.00



8 680437 018278

RK.01.450.05

Repair Kit



8 680437 122036

00.999

Roller Bearing



6308



8 680437 009627

01.1641

Adapter



8 680437 109020

## Single Cylinder Compressor Ø85 mm-318 CC-Stroke 56 mm

Application - Vehicle  
FORD BRASIL  
CUMMINS 6BTAA-5.9 / 6CTAA-8.3

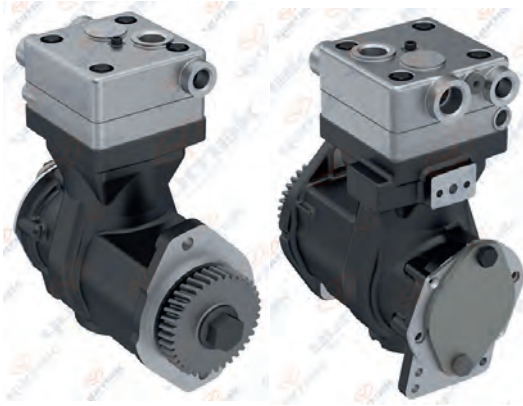

**01.06.086**

Oem. Ref. No.  
3357113  
BFOX2875AA

Wabco No.  
911155110

**01.06.086.10**

Without Gear



**01.1603**

Crankcase



**RK.01.414.02**

Repair Kit

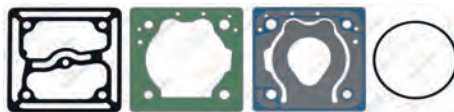

**RK.01.414.05**

Repair Kit



**RK.01.720**

Complete Cylinder Head

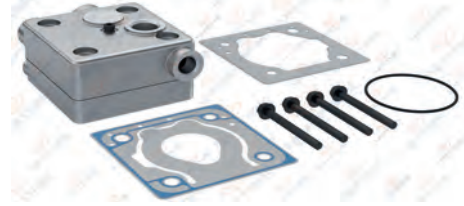

Wabco No: 9111558042

**RK.01.414.01**

Repair Kit

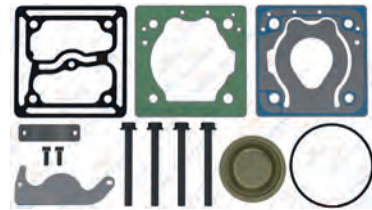

**RK.01.414**

Repair Kit

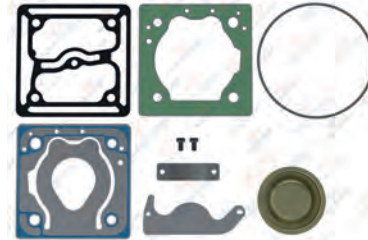

Wabco No: 9111559202

**RK.01.414.04**

Repair Kit

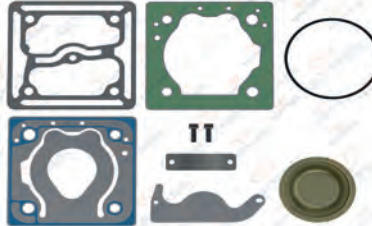

Use for old version cylinder repair kit. Yıpranmış kapaklar için.

**RK.01.414.03**

Repair Kit

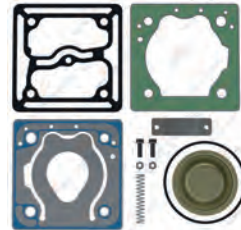

Wabco No: 9111559202



# CUMMINS-VOLKSWAGEN-JOHN DEERE FORD BRASIL-CATERPILLAR-MACK

## AIR COMPRESSOR AND REPAIR KIT

01.1517

Cylinder Head

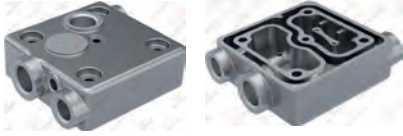

Wabco No: 8845025794 -  
8 680437 102410 9111556554

01.1431

Valve Plate



Wabco No: 8845032002 -  
8 680437 074793 9111556522

01.1640

Crankshaft



8 680437 108900

01.1648

Gear



8 680437 091028

01.1649

Crankshaft Flange



8 680437 084402

01.272

Connecting Rod



Wabco No: 9111457372  
8 680437 020400

RK.01.104.00

Piston&Ring (Ø85,00 mm)

- RK.01.104.10 85,25 mm
- RK.01.104.20 85,50 mm
- RK.01.104.30 85,75 mm
- RK.01.104.40 86,00 mm



2.00x2,00x4,00

8 680437 060277

01.142.00

Piston (Ø85,00 mm)

- 01.142.10 85,25 mm
- 01.142.20 85,50 mm
- 01.142.30 85,75 mm
- 01.142.40 86,00 mm



2.00x2,00x4,00

Wabco No: 9115016242 - 9115016252  
8 680437 018674

01.373.00

Ring (Ø85,00 mm)

- 01.373.10 85,25 mm
- 01.373.20 85,50 mm
- 01.373.30 85,75 mm
- 01.373.40 86,00 mm



2.00x2,00x4,00

Wabco No: 9115019202  
8 680437 075431

01.1643

Screw



M20X1.5 - Right Hand

8 680437 091073

01.1642

Adapter



8 680437 109037

01.302

Cap



8 680437 020769

## Single Cylinder Compressor Ø88 mm-300 CC-Stroke 50 mm

Application - Vehicle  
VOLKSWAGEN TRUCK  
13.180 - 15.180 - 16.210 CO - 17.210 -  
17.210 OD - 17.300 ATé 10/2001



**01.04.185**

Oem. Ref. No.  
2TJ145605

Knorr No.  
LK39..  
1135214



8 680437 079682



**01.306.10**

Crankcase



8 680437 103530

**RK.01.357**

Repair Kit



8 680437 064305

**RK.01.068**

Complete Cylinder Head



8 680437 059493

Knorr No: ZB4275

**RK.01.035**

Valve Plate Kit



8 680437 058878

**RK.01.037.06**

Repair Kit

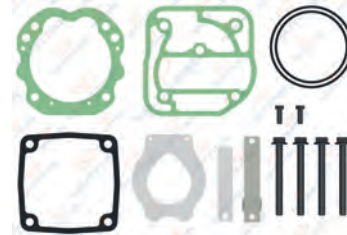

8 680437 058915

**RK.01.037.05**

Repair Kit

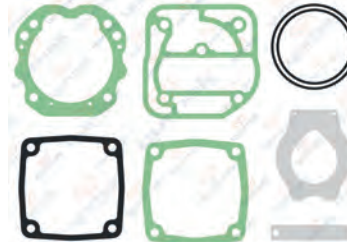

8 680437 058892

**RK.01.037.02**

Repair Kit



8 680437 120278

# CUMMINS-VOLKSWAGEN-JOHN DEERE FORD BRASIL-CATERPILLAR-MACK AIR COMPRESSOR AND REPAIR KIT

01.076

Cylinder Head



8 680437 014164

01.139

Valve Plate



8 680437 018537

01.1655

Crankshaft



M20X1.5 - Right Hand



8 680437 079668

01.1654

Flange



8 680437 079736

01.1287

Crankshaft Flange



8 680437 113287

01.951

Connecting Rod



8 680437 080053

RK.01.034.00

Piston&Ring (Ø88,00 mm)

- RK.01.034.10 88,25 mm
- RK.01.034.20 88,50 mm
- RK.01.034.30 88,75 mm
- RK.01.034.40 89,00 mm



2.50x2,50x4,00



8 680437 058616

Knorr No: I81169004 - SEB22555

01.110.00

Piston (Ø88,00 mm)

- 01.110.10 88,25 mm
- 01.110.20 88,50 mm
- 01.110.30 88,75 mm
- 01.110.40 89,00 mm



2.50x2,50x4,00



8 680437 015994

01.136.00

Ring (Ø88,00 mm)

- 01.136.10 88,25 mm
- 01.136.20 88,50 mm
- 01.136.30 88,75 mm
- 01.136.40 89,00 mm



2.50x2,50x4,00



8 680437 018384

Knorr No: I139526F0061

01.057.10

Cylinder Liner



8 680437 093598

RK.01.032.02

Cylinder Liner Set



8 680437 093282

01.144

Nut



M20X1.5 - Right Hand



8 680437 018742

01.195

Bushing



34X30X16



8 680437 019411

01.656

Bushing



34X30X20



8 680437 025221



## Single Cylinder Compressor Ø88 mm-225 CC-Stroke 37 mm

Application - Vehicle  
FORD BRASIL

13.180 - 15.180 - 16.210 CO - 17.210 -  
17.210 OD - 17.300 Até 10/2001



**01.04.186**

Knorr No.  
LK38..  
1135214



**01.1666** Crankcase



**RK.01.408** Repair Kit



**RK.01.761** Complete Cylinder Head



**RK.01.762** Valve Plate Kit



**RK.01.758.01** Repair Kit

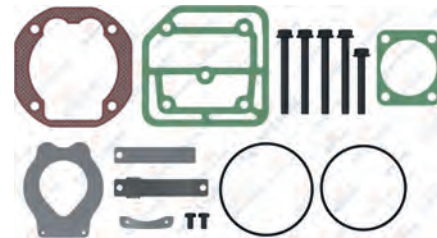

**RK.01.758.02** Repair Kit

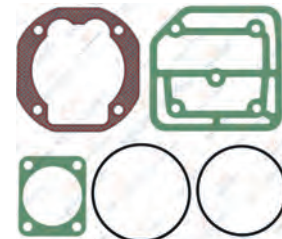

**RK.01.758** Repair Kit

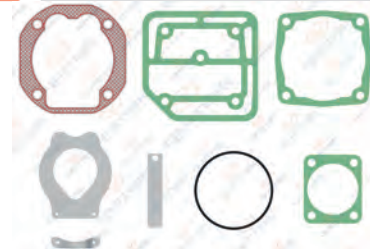

# CUMMINS-VOLKSWAGEN-JOHN DEERE FORD BRASIL-CATERPILLAR-MACK

## AIR COMPRESSOR AND REPAIR KIT

01.1668

Cylinder Head



8 680437 128373

01.1669

Valve Plate



8 680437 128380

01.1667

Crankshaft



8 680437 128366

01.1670

Flange



8 680437 128397

01.1287

Pump Support



8 680437 113287

01.003

Connecting Rod



8 680437 009672

RK.01.034.00

Piston&Ring (Ø88,00 mm)

- RK.01.034.10 88,25 mm
- RK.01.034.20 88,50 mm
- RK.01.034.30 88,75 mm
- RK.01.034.40 89,00 mm



2.50x2,50x4,00



8 680437 058616

Knorr No: I81169004 - SEB22555

01.110.00

Piston (Ø88,00 mm)

- 01.110.10 88,25 mm
- 01.110.20 88,50 mm
- 01.110.30 88,75 mm
- 01.110.40 89,00 mm



2.50x2,50x4,00



8 680437 015994

01.136.00

Ring (Ø88,00 mm)

- 01.136.10 88,25 mm
- 01.136.20 88,50 mm
- 01.136.30 88,75 mm
- 01.136.40 89,00 mm



2.50x2,50x4,00



8 680437 018384

Knorr No: I139526F0061

01.1671

Cylinder Liner



8 680437 128403

RK.01.760

Cylinder Liner Set



8 680437 128410

Knorr No: I1313740063

01.013

Bushing



34X30X16



8 680437 009993

01.195

Bushing



34X30X16



8 680437 019411

## Single Cylinder Compressor Ø85 mm-318 CC-Stroke 56 mm

### Application - Vehicle

CUMMINS - 6BTAA-5.9 / 6CTAA-8.3  
VOLKSWAGEN : 17 220 / 17 300 / 18 310 TITAN /  
24 220 / 24 250 / 40 300 / 42 300



**01.06.089**

Oem. Ref. No.  
3357110  
2T0100759

Wabco No.  
9111550600

**01.06.089.10**

Without Gear



**01.1656**

Crankcase



**RK.01.414.10**

Repair Kit



**RK.01.720.10**

Complete Cylinder Head

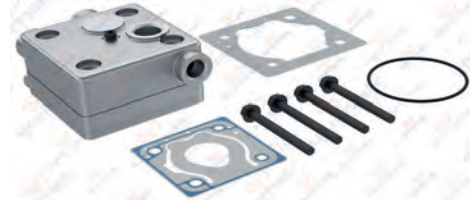

Wabco No: 9111558022

**RK.01.414.07**

Repair Kit

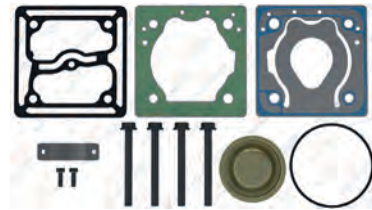

**RK.01.414.08**

Repair Kit



Wabco No: 9111559212

**RK.01.414.09**

Repair Kit



Use for old version cylinder repair kit. Yıpranmış kapaklar için.

**RK.01.414.02**

Repair Kit

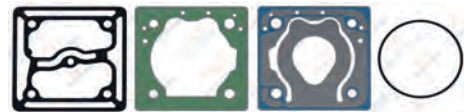



# CUMMINS-VOLKSWAGEN-JOHN DEERE FORD BRASIL-CATERPILLAR-MACK

AIR COMPRESSOR AND REPAIR KIT

01.1517.10

Cylinder Head



Wabco No: 8845025414 -  
9111556534



01.1431.10

Valve Plate



Wabco No: 9111556502 -  
9111558032



01.1640

Crankshaft



01.1648

Gear



01.1649

Crankshaft Flange



01.272

Connecting Rod



Wabco No: 9111457372

RK.01.104.00

Piston&Ring (Ø85,00 mm)

- RK.01.104.10 85,25 mm
- RK.01.104.20 85,50 mm
- RK.01.104.30 85,75 mm
- RK.01.104.40 86,00 mm



2.00x2.00x4.00



01.142.00

Piston (Ø85,00 mm)

- 01.142.10 85,25 mm
- 01.142.20 85,50 mm
- 01.142.30 85,75 mm
- 01.142.40 86,00 mm



2.00x2.00x4.00



Wabco No: 9115016242 - 9115016252

01.373.00

Ring (Ø85,00 mm)

- 01.373.10 85,25 mm
- 01.373.20 85,50 mm
- 01.373.30 85,75 mm
- 01.373.40 86,00 mm



2.00x2.00x4.00



Wabco No: 9115019202

01.1643

Screw



M20X1.5 - Right Hand



01.1642

Adapter



01.302

Cap



## Single Cylinder Compressor Ø85 mm-318 CC-Stroke 56 mm

**Application - Vehicle**  
**CUMMINS : 6 BTA A - 5,9**  
**FORD BRASIL : F 12000 / F 12000 L / F 14000 / F 14000 HD / F 16000**

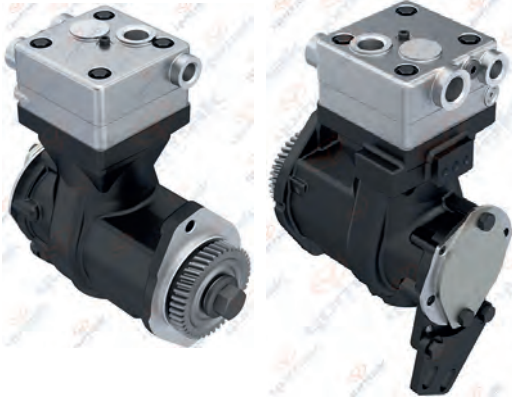

**01.06.096**

**Oem. Ref. No.**  
3357109  
BFOX2875CA

**Wabco No.**  
9111555010

**01.06.096.10**

**Without Gear**



**01.1603**

**Crankcase**



**RK.01.414.02**

**Repair Kit**

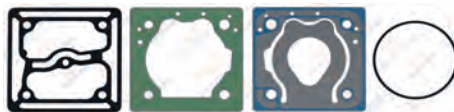

**RK.01.414.05**

**Repair Kit**



**RK.01.720**

**Complete Cylinder Head**

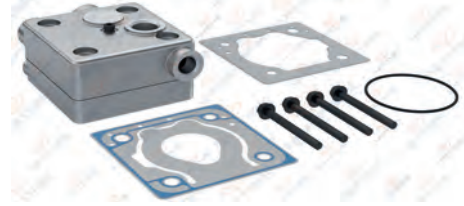

**Wabco No: 9111558042**

**RK.01.414.01**

**Repair Kit**

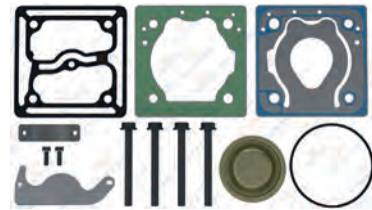

**RK.01.414**

**Repair Kit**

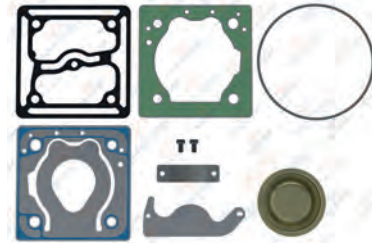

**RK.01.414.04**

**Repair Kit**

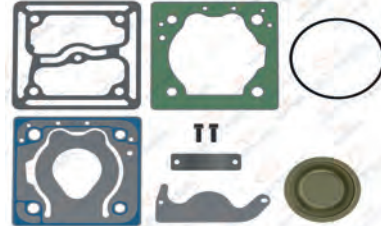

**Use for old version cylinder repair kit. Yıpranmış kapaklar için.**

**RK.01.414.03**

**Repair Kit**

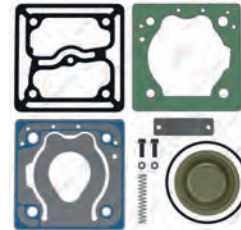

**Wabco No: 9111559202**

# CUMMINS-VOLKSWAGEN-JOHN DEERE FORD BRASIL-CATERPILLAR-MACK

AIR COMPRESSOR AND REPAIR KIT

01.1517

Cylinder Head



Wabco No: 8845025794 -  
8 680437 102410 9111556554

01.1431

Valve Plate



Wabco No: 8845032002 -  
8 680437 074793 9111556522

01.1640

Crankshaft



8 680437 108900

01.1123

Bushing



8 680437 016458

01.1649

Crankshaft Flange



8 680437 084402

01.272

Connecting Rod



Wabco No: 9111457372  
8 680437 020400

RK.01.104.00

Piston&Ring (Ø85,00 mm)

- RK.01.104.10 85,25 mm
- RK.01.104.20 85,50 mm
- RK.01.104.30 85,75 mm
- RK.01.104.40 86,00 mm



2.00x2.00x4.00

8 680437 060277

01.142.00

Piston (Ø85,00 mm)

- 01.142.10 85,25 mm
- 01.142.20 85,50 mm
- 01.142.30 85,75 mm
- 01.142.40 86,00 mm



2.00x2.00x4.00

Wabco No: 9115016242 - 9115016252  
8 680437 018674

01.373.00

Ring (Ø85,00 mm)

- 01.373.10 85,25 mm
- 01.373.20 85,50 mm
- 01.373.30 85,75 mm
- 01.373.40 86,00 mm



2.00x2.00x4.00

Wabco No: 9115019202  
8 680437 075431

01.1642

Adapter



8 680437 109037

01.1643

Screw



M20X1.5 - Right Hand

8 680437 091073

01.1888

Gear



8 680437 163855

OEM No: 3928861

01.1908

Pump Support



8 680437 163862



## Single Cylinder Compressor Ø85 mm-318 CC-Stroke 56 mm

### Application - Vehicle

VOLKSWAGEN : 24 250 / 19 320E  
CONSTELLATION / 26 260E / 31 320E / 19 350E /  
25 320E / 25 350E / 31 350E



**01.06.092**

**Oem. Ref. No.**  
3999917  
2T2100759B

**Wabco No.**  
9111555210



### 01.1603.11 Crankcase



### RK.01.130.13 Repair Kit

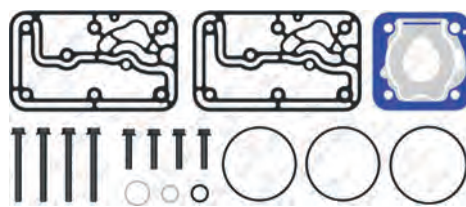

### RK.01.169 Complete Cylinder Head

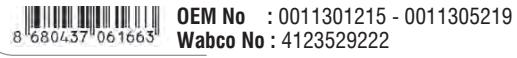

### RK.01.130.05 Repair Kit

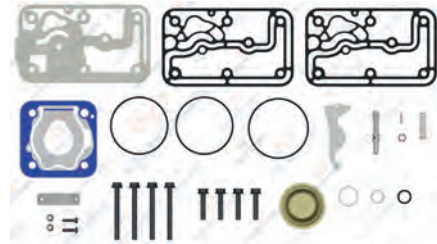

### RK.01.130.08 Repair Kit

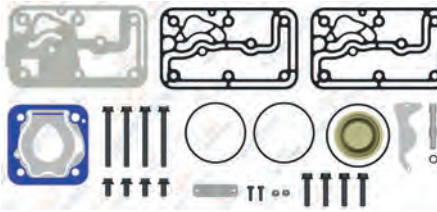

### RK.01.130.12 Repair Kit

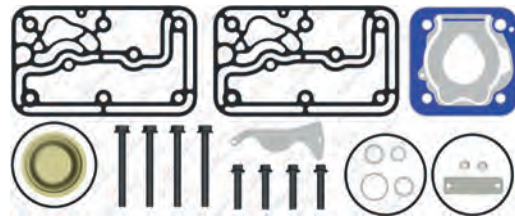

### RK.01.130 Repair Kit

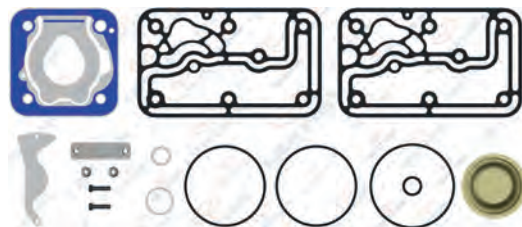

### RK.01.130.04 Repair Kit

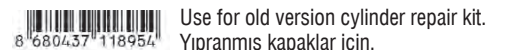
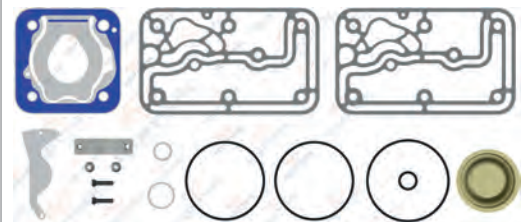

# CUMMINS-VOLKSWAGEN-JOHN DEERE FORD BRASIL-CATERPILLAR-MACK

## AIR COMPRESSOR AND REPAIR KIT

01.367

Cylinder Head



8 680437 021681

01.368

Valve Plate



8 680437 021704

01.1640

Crankshaft



8 680437 108900

01.369

Cooling Plate



8 680437 021728

01.1649.10

Crankshaft Flange



8 680437 139294

01.272

Connecting Rod



8 680437 020400

RK.01.104.00

Piston&Ring (Ø85,00 mm)

- RK.01.104.10 85,25 mm
- RK.01.104.20 85,50 mm
- RK.01.104.30 85,75 mm
- RK.01.104.40 86,00 mm



2.00x2.00x4.00



8 680437 060277

01.142.00

Piston (Ø85,00 mm)

- 01.142.10 85,25 mm
- 01.142.20 85,50 mm
- 01.142.30 85,75 mm
- 01.142.40 86,00 mm

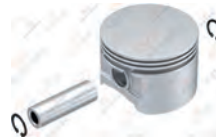

2.00x2.00x4.00



8 680437 018674

Wabco No: 9115016242 - 9115016252

01.373.00

Ring (Ø85,00 mm)

- 01.373.10 85,25 mm
- 01.373.20 85,50 mm
- 01.373.30 85,75 mm
- 01.373.40 86,00 mm



2.00x2.00x4.00



8 680437 075431

Wabco No: 9115019202

RK.01.130.10

Repair Kit



8 680437 124085

01.1854

Pump Adapter



8 680437 141174

01.1225

Gear



8 680437 017875

Wabco No: 3942497 - 3940239

RK.01.201

Repair Kit



8 680437 062110

## Single Cylinder Compressor Ø85 mm-318 CC-Stroke 56 mm

Application - Vehicle  
CUMMINS



**01.06.093**

Oem. Ref. No.  
4930344

Wabco No.  
9111550620



**01.1603.01**

Crankcase



**RK.01.414.10**

Repair Kit



**RK.01.720.10**

Complete Cylinder Head



Wabco No: 9111558022

**RK.01.414.07**

Repair Kit

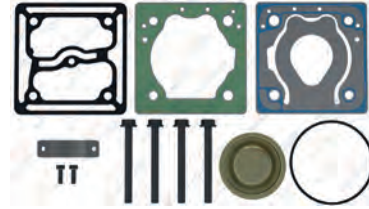

**RK.01.414.08**

Repair Kit



Wabco No: 9111559212

**RK.01.414.09**

Repair Kit

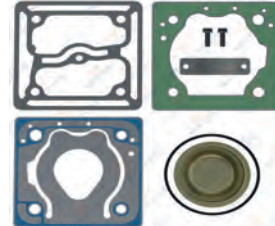

Use for old version cylinder repair kit. Yıpranmış kapaklar için.

**RK.01.414.02**

Repair Kit

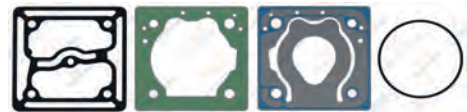



# CUMMINS-VOLKSWAGEN-JOHN DEERE FORD BRASIL-CATERPILLAR-MACK

## AIR COMPRESSOR AND REPAIR KIT

**01.1517.10** Cylinder Head



Wabco No: 8845025414 -  
8 680437 128427 9111556534

**01.1431.10** Valve Plate



Wabco No: 9111556502 -  
8 680437 100812 9111558032

**01.1640** Crankshaft



8 680437 108900

**01.1648** Gear



8 680437 091028

**01.1649.10** Crankshaft Flange



8 680437 139294

**01.272** Connecting Rod



8 680437 020400

**RK.01.104.00** Piston&Ring (Ø85,00 mm)

- RK.01.104.10 85,25 mm
- RK.01.104.20 85,50 mm
- RK.01.104.30 85,75 mm
- RK.01.104.40 86,00 mm



2.00x2.00x4.00

8 680437 060277

**01.142.00** Piston (Ø85,00 mm)

- 01.142.10 85,25 mm
- 01.142.20 85,50 mm
- 01.142.30 85,75 mm
- 01.142.40 86,00 mm



2.00x2.00x4.00

Wabco No: 9115016242 - 9115016252  
8 680437 018674

**01.373.00** Ring (Ø85,00 mm)

- 01.373.10 85,25 mm
- 01.373.20 85,50 mm
- 01.373.30 85,75 mm
- 01.373.40 86,00 mm



2.00x2.00x4.00

Wabco No: 9115019202  
8 680437 075431

**01.1854** Pump Adapter



8 680437 141174

## Single Cylinder Compressor Ø85 mm-318 CC-Stroke 56 mm

Application - Vehicle  
CUMMINS : 6 CTA A - 8,3  
VOLKSWAGEN : 13 170 / 15 170 / 17 210 / 17  
220 / 17 300

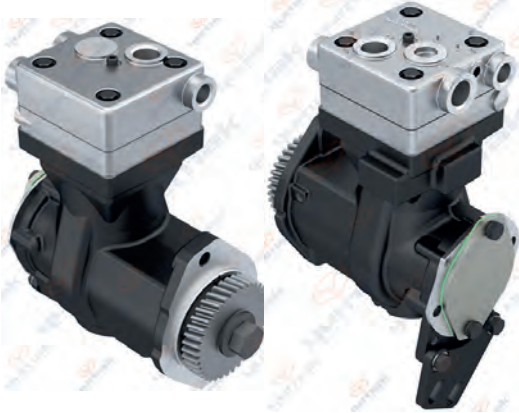

**01.06.094**

Oem. Ref. No.  
4930344  
2T0100759D

Wabco No.  
9111550620



**01.1603.01** Crankcase



**RK.01.414.10** Repair Kit



**RK.01.720.10**

Complete Cylinder Head



Wabco No: 9111558022

**RK.01.414.07**

Repair Kit

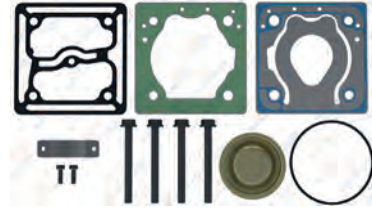

**RK.01.414.08**

Repair Kit



Wabco No: 9111559212

**RK.01.414.09**

Repair Kit

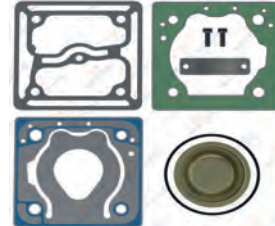

Use for old version cylinder repair kit. Yıpranmış kapaklar için.

**RK.01.414.02**

Repair Kit

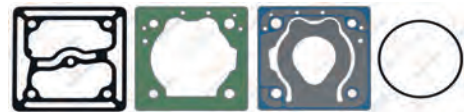

# CUMMINS-VOLKSWAGEN-JOHN DEERE FORD BRASIL-CATERPILLAR-MACK

## AIR COMPRESSOR AND REPAIR KIT

**01.1517.10** Cylinder Head



Wabco No: 8845025414 -  
8 680437 128427 9111556534

**01.1431.10** Valve Plate



Wabco No: 9111556502 -  
8 680437 100812 9111558032

**01.1640** Crankshaft



8 680437 108900

**01.1648** Gear



8 680437 091028

**01.1649.10** Crankshaft Flange



8 680437 139294

**01.272** Connecting Rod



8 680437 020400

**RK.01.104.00** Piston&Ring (Ø85,00 mm)

- RK.01.104.10 85,25 mm
- RK.01.104.20 85,50 mm
- RK.01.104.30 85,75 mm
- RK.01.104.40 86,00 mm



2.00x2.00x4.00

8 680437 060277

**01.142.00** Piston (Ø85,00 mm)

- 01.142.10 85,25 mm
- 01.142.20 85,50 mm
- 01.142.30 85,75 mm
- 01.142.40 86,00 mm



2.00x2.00x4.00

Wabco No: 9115016242 - 9115016252  
8 680437 018674

**01.373.00** Ring (Ø85,00 mm)

- 01.373.10 85,25 mm
- 01.373.20 85,50 mm
- 01.373.30 85,75 mm
- 01.373.40 86,00 mm



2.00x2.00x4.00

Wabco No: 9115019202  
8 680437 075431

**01.1642** Adapter



8 680437 109037



## Single Cylinder Compressor Ø85 mm-318 CC-Stroke 56 mm

### Application - Vehicle

CUMMINS : 6 BTA A - 5,9

VOLKSWAGEN : 13 150 / 13 170 / 13 180 / 13  
190 / 15 170 / 15 180 / 15 190 / 17 210 / 17 220  
/ 17 300 / 18 310 / 23 210 / 23 220 23 250 / 24  
220 / 24 250 / 40 300 / 42 300



**01.06.095**

Oem. Ref. No.  
3357106  
2T0100759A

Wabco No.  
9111550500



**01.1603.01**

Crankcase



**RK.01.414.10**

Repair Kit



**RK.01.720.10**

Complete Cylinder Head



Wabco No: 9111558022

**RK.01.414.07**

Repair Kit

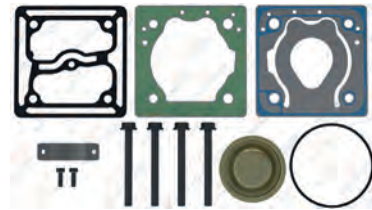

**RK.01.414.08**

Repair Kit

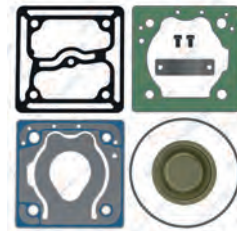

Wabco No: 9111559212

**RK.01.414.09**

Repair Kit

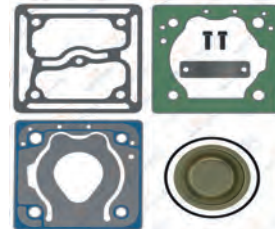

Use for old version cylinder repair kit. Yıpranmış kapaklar için.

**RK.01.414.02**

Repair Kit

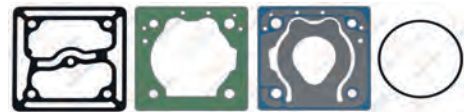

# CUMMINS-VOLKSWAGEN-JOHN DEERE FORD BRASIL-CATERPILLAR-MACK AIR COMPRESSOR AND REPAIR KIT

01.1517.10

Cylinder Head



Wabco No: 8845025414 -  
9111556534

01.1431.10

Valve Plate



Wabco No: 9111556502 -  
9111558032

01.1640

Crankshaft



Wabco No: 9111556502 -  
9111558032

01.1888

Gear



OEM No: 3928861

01.1649.10

Crankshaft Flange



Wabco No: 9111556502 -  
9111558032

01.272

Connecting Rod



Wabco No: 9111556502 -  
9111558032

RK.01.104.00

Piston&Ring (Ø85,00 mm)

- RK.01.104.10 85,25 mm
- RK.01.104.20 85,50 mm
- RK.01.104.30 85,75 mm
- RK.01.104.40 86,00 mm



2.00x2.00x4.00

Wabco No: 9115016242 - 9115016252

01.142.00

Piston (Ø85,00 mm)

- 01.142.10 85,25 mm
- 01.142.20 85,50 mm
- 01.142.30 85,75 mm
- 01.142.40 86,00 mm



2.00x2.00x4.00

Wabco No: 9115016242 - 9115016252

01.373.00

Ring (Ø85,00 mm)

- 01.373.10 85,25 mm
- 01.373.20 85,50 mm
- 01.373.30 85,75 mm
- 01.373.40 86,00 mm



2.00x2.00x4.00

Wabco No: 9115019202

01.1854

Pump Adapter



Wabco No: 9111556502 -  
9111558032

## Single Cylinder Compressor Ø85 mm-318 CC-Stroke 56 mm

Application - Vehicle  
NEW HOLLAND  
COLHEITADEIRA - CNH  
COLHEITADEIRA 2399  
FORD BRASIL : C 5032E



**01.06.090**

Oem. Ref. No.  
3977020  
BG6X2875AA  
87543702

Wabco No.  
911155190



**01.1603.10** Crankcase



**RK.01.414.02** Repair Kit

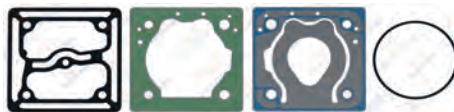

**RK.01.414.05** Repair Kit



**RK.01.720**

Complete Cylinder Head



Wabco No: 9111558042

**RK.01.414.01**

Repair Kit

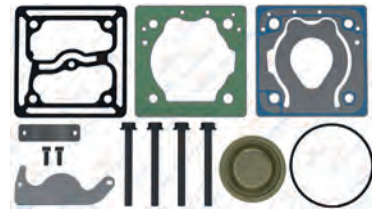

**RK.01.414**

Repair Kit

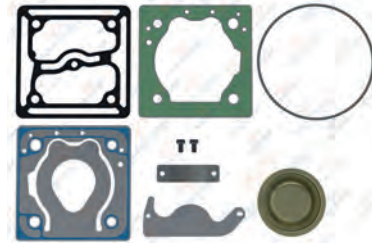

**RK.01.414.04**

Repair Kit

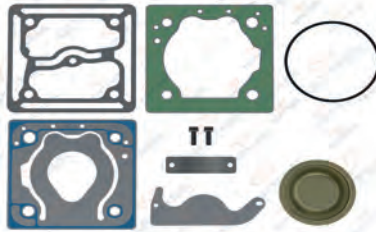

Use for old version cylinder repair kit. Yıpranmış kapaklar için.

**RK.01.414.03**

Repair Kit

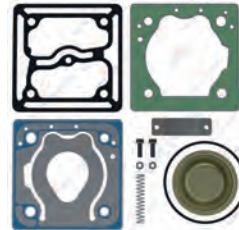

Wabco No: 9111559202



# CUMMINS-VOLKSWAGEN-JOHN DEERE FORD BRASIL-CATERPILLAR-MACK

## AIR COMPRESSOR AND REPAIR KIT

01.1517

Cylinder Head

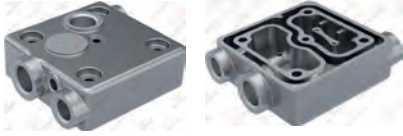

Wabco No: 8845025794 -  
8 680437 102410 9111556554

01.1431

Valve Plate



Wabco No: 8845032002 -  
8 680437 074793 9111556522

01.1640

Crankshaft



8 680437 108900

01.1225

Gear



Wabco No: 3942497 - 3940239  
8 680437 017875

01.1649.10

Crankshaft Flange



8 680437 139294

01.272

Connecting Rod



8 680437 020400

RK.01.104.00

Piston&Ring (Ø85,00 mm)

- RK.01.104.10 85,25 mm
- RK.01.104.20 85,50 mm
- RK.01.104.30 85,75 mm
- RK.01.104.40 86,00 mm



2.00x2.00x4.00

8 680437 060277

01.142.00

Piston (Ø85,00 mm)

- 01.142.10 85,25 mm
- 01.142.20 85,50 mm
- 01.142.30 85,75 mm
- 01.142.40 86,00 mm



2.00x2.00x4.00

8 680437 018674 Wabco No: 9115016242 - 9115016252

01.373.00

Ring (Ø85,00 mm)

- 01.373.10 85,25 mm
- 01.373.20 85,50 mm
- 01.373.30 85,75 mm
- 01.373.40 86,00 mm



2.00x2.00x4.00

8 680437 075431 Wabco No: 9115019202

01.1854

Pump Adapter



8 680437 141174

## Single Cylinder Compressor Ø85 mm-318 CC-Stroke 56 mm

Application - Vehicle  
CUMMINS ISX / L / M / N /  
ISC / B

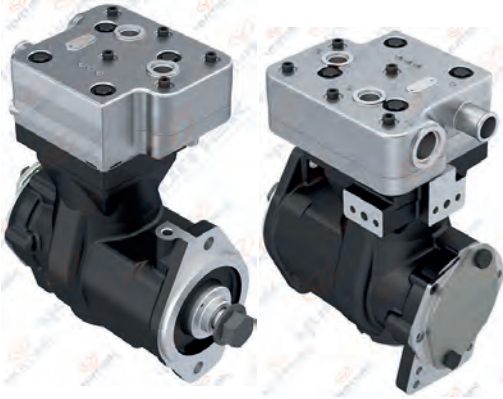

**01.04.227**

Oem. Ref. No.  
3977020  
BG6X2875AA  
87543702

Wabco No.  
9111530040



**01.1592** Crankcase



**RK.01.067.05** Repair Kit

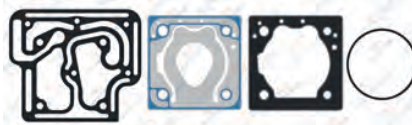

**RK.01.067.06** Repair Kit



**RK.01.430**

Complete Cylinder Head

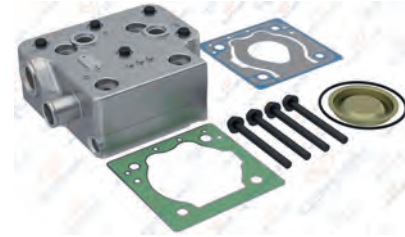

Wabco No: 9111539202

**RK.01.067.01**

Repair Kit

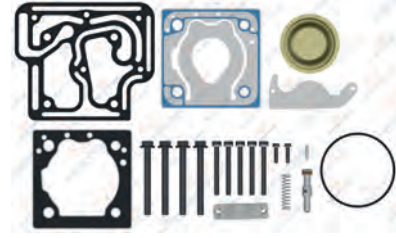

**RK.01.067.02**

Repair Kit

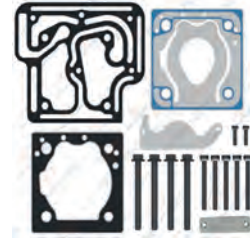

Wabco No: 9111549292

**RK.01.067**

Repair Kit

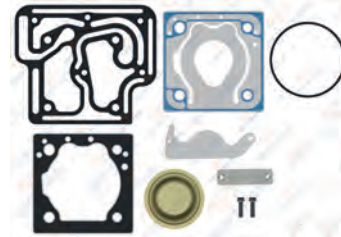

**RK.01.067.04**

Repair Kit

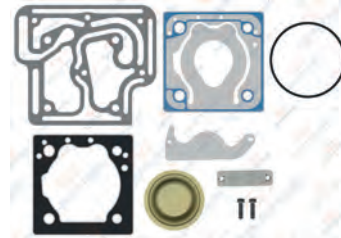

Use for old version cylinder repair kit. Yıpranmış kapaklar için.

# CUMMINS-VOLKSWAGEN-JOHN DEERE FORD BRASIL-CATERPILLAR-MACK

## AIR COMPRESSOR AND REPAIR KIT

**01.990** Cylinder Head



8 680437 029559

**01.901** Valve Plate



8 680437 028178

**01.1636** Crankshaft



8 680437 079811

**01.1643** Screw



M20X1.5 - Right Hand



8 680437 091073

**01.1222** Flange



8 680437 017844

Wabco No: 9111539252

**01.272** Connecting Rod



8 680437 020400

**RK.01.104.00** Piston&Ring (Ø85,00 mm)

- RK.01.104.10 85,25 mm
- RK.01.104.20 85,50 mm
- RK.01.104.30 85,75 mm
- RK.01.104.40 86,00 mm



2.00x2,00x4,00



8 680437 060277

**01.142.00** Piston (Ø85,00 mm)

- 01.142.10 85,25 mm
- 01.142.20 85,50 mm
- 01.142.30 85,75 mm
- 01.142.40 86,00 mm



2.00x2,00x4,00



8 680437 018674

Wabco No: 9115016242 - 9115016252

**01.373.00** Ring (Ø85,00 mm)

- 01.373.10 85,25 mm
- 01.373.20 85,50 mm
- 01.373.30 85,75 mm
- 01.373.40 86,00 mm



2.00x2,00x4,00



8 680437 075431

Wabco No: 9115019202

**RK.01.513** Repair Kit

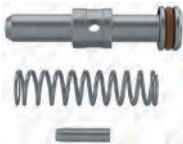

8 680437 066057

**01.1644** Pump Adapter





## Single Cylinder Compressor Ø85 mm-318 CC-Stroke 56 mm

Application - Vehicle  
CUMMINS ISX / L / M / N / ISC / B



**01.04.228**

Oem. Ref. No.  
3936810  
3966333

Wabco No.  
9111535330



**01.1870**

Crankcase



**RK.01.067.05**

Repair Kit

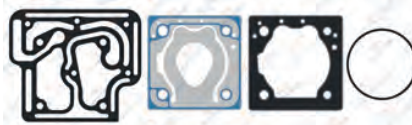

**RK.01.067.06**

Repair Kit



**RK.01.430**

Complete Cylinder Head



Wabco No: 9111539202

**RK.01.067.01**

Repair Kit

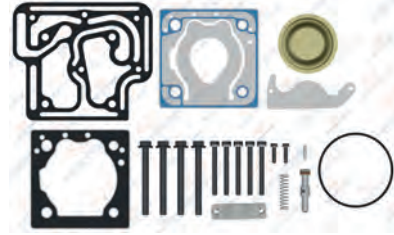

**RK.01.067.02**

Repair Kit

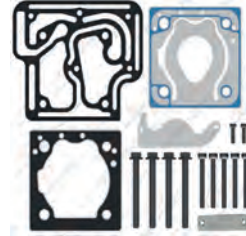

Wabco No: 9111549292

**RK.01.067**

Repair Kit

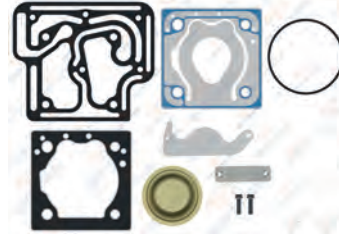

**RK.01.067.04**

Repair Kit

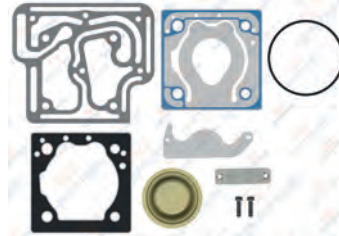

Use for old version cylinder repair kit. Yıpranmış kapaklar için.

# CUMMINS-VOLKSWAGEN-JOHN DEERE FORD BRASIL-CATERPILLAR-MACK

## AIR COMPRESSOR AND REPAIR KIT

01.990

Cylinder Head



8 680437 029559

01.901

Valve Plate



8 680437 028178

01.1636

Crankshaft



8 680437 079811

01.1643

Screw



M20X1.5 - Right Hand



8 680437 091073

01.1222

Flange



8 680437 017844

Wabco No: 9111539252

01.272

Connecting Rod



8 680437 020400

RK.01.104.00

Piston&Ring (Ø85,00 mm)

- RK.01.104.10 85,25 mm
- RK.01.104.20 85,50 mm
- RK.01.104.30 85,75 mm
- RK.01.104.40 86,00 mm



2.00x2,00x4,00



8 680437 060277

01.142.00

Piston (Ø85,00 mm)

- 01.142.10 85,25 mm
- 01.142.20 85,50 mm
- 01.142.30 85,75 mm
- 01.142.40 86,00 mm



2.00x2,00x4,00



8 680437 018674

Wabco No: 9115016242 - 9115016252

01.373.00

Ring (Ø85,00 mm)

- 01.373.10 85,25 mm
- 01.373.20 85,50 mm
- 01.373.30 85,75 mm
- 01.373.40 86,00 mm



2.00x2,00x4,00



8 680437 075431

Wabco No: 9115019202

RK.01.513

Repair Kit

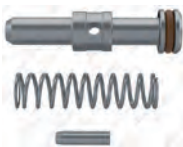

8 680437 066057

01.1644

Pump Adapter

## Twin Cylinder Compressor Ø85 mm-636 CC-Stroke 56 mm

Application - Vehicle  
MACK MP10

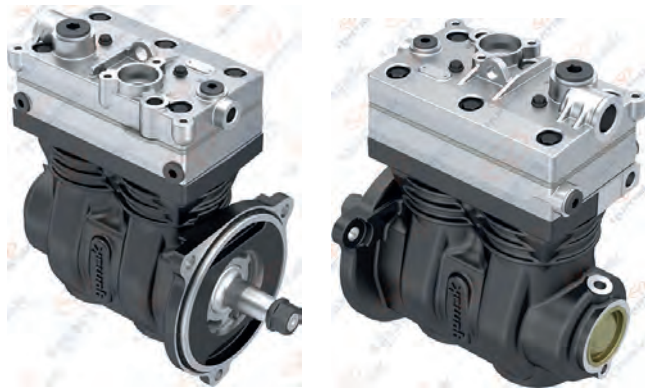

**01.05.073**

Oem. No.  
21170177

Wabco No.  
9125420020



**01.877**

Crankcase



**RK.01.352.11**

Repair Kit

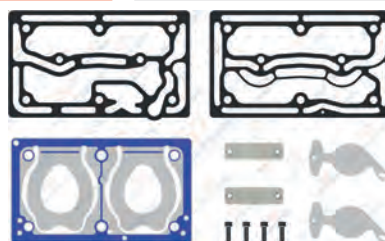

**RK.01.418**

Repair Kit

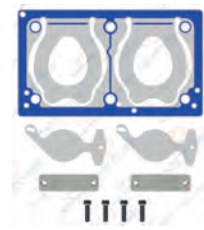

**RK.01.361**

Complete Cylinder Head

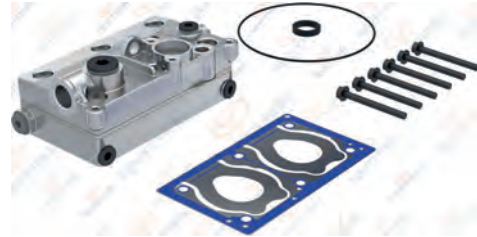

OEM No : 20889546 - 20774299 - 21418150 - 21707608

Wabco No : 4127049402 - 9125129262 - 9125129252 - 9125129242

**RK.01.352.05**

Repair Kit

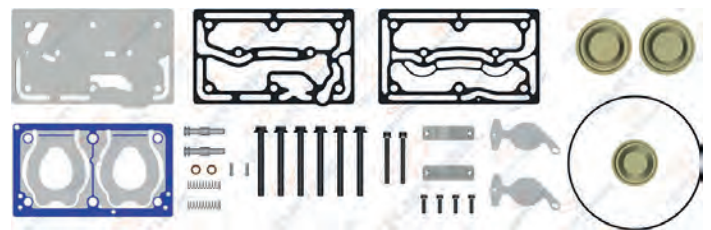

**RK.01.352.10**

Repair Kit

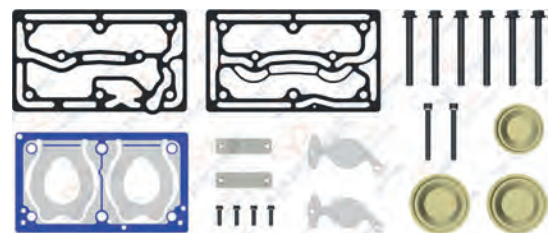

Wabco No : 9125129282

**RK.01.352**

Repair Kit

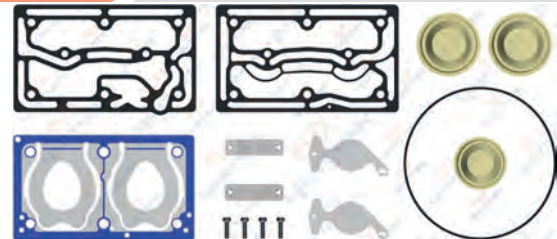

**RK.01.352.19**

Repair Kit

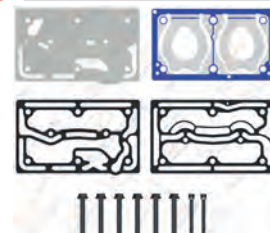

OEM No : 21322318 - 21477052

Wabco No : 9125129272 - 4127049382



# CUMMINS-VOLKSWAGEN-JOHN DEERE FORD BRASIL-CATERPILLAR-MACK AIR COMPRESSOR AND REPAIR KIT

01.874

Cylinder Head



8 680437 027836

01.1284

Valve Plate



8 680437 027220

01.876

Crankshaft



M20X1.5 Right Hand



8 680437 027874

01.565

Cooling Plate



8 680437 024095

01.878

Bushing



8 680437 027898

Wabco No : 9120003404 - 9120003406

01.272

Connecting Rod



8 680437 020400

RK.01.104.00

Piston&Ring (Ø85,00 mm)

- RK.01.104.10 85,25 mm
- RK.01.104.20 85,50 mm
- RK.01.104.30 85,75 mm
- RK.01.104.40 86,00 mm



2,00x2,00x4,00



8 680437 060277

01.142.00

Piston (Ø85,00 mm)

- 01.142.10 85,25 mm
- 01.142.20 85,50 mm
- 01.142.30 85,75 mm
- 01.142.40 86,00 mm



2,00x2,00x4,00



8 680437 018674

Wabco No : 9115016242 - 9115016252

01.373.00

Ring (Ø85,00 mm)

- 01.373.10 85,25 mm
- 01.373.20 85,50 mm
- 01.373.30 85,75 mm
- 01.373.40 86,00 mm



2,00x2,00x4,00



8 680437 075431

OEM No : 3094621

Wabco No : 9115019202

RK.01.803

Connecting Rod & Piston



STD.



8 680437 114567

Wabco No : 9125189242

RK.01.905

Crankshaft Repair Kit



8 680437 109242

Wabco No : 9125129302

01.144

Nut



M20X1.5 Right Hand



8 680437 018742

OEM No : 1698672

Wabco No : 8103410014

RK.01.512

Repair Kit



8 680437 066040

01.1227

Bushing



52X48X20



8 680437 017936

## Twin Cylinder Compressor Ø85 mm - 636 CC - Stroke 56 mm

Application - Vehicle  
MACK MP10



**01.06.081**

Oem. No.  
220062021

Wabco No.  
9125420070



**01.877** Crankcase



**RK.01.352.11** Repair Kit

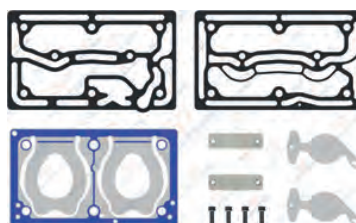

**RK.01.711** Complete Cylinder Head

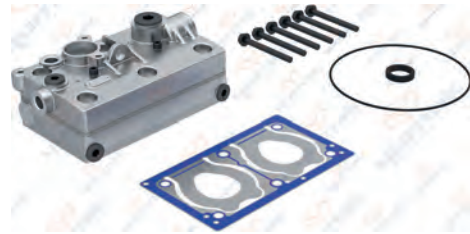

Wabco No : 9125129352

**RK.01.712.05** Repair Kit

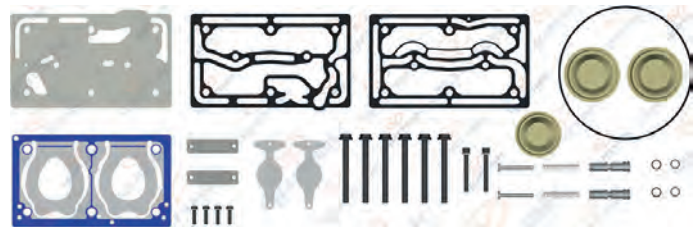

**RK.01.712.01** Repair Kit

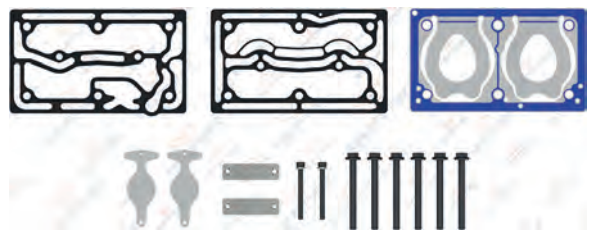

Wabco No : 9125129362

**RK.01.712** Repair Kit

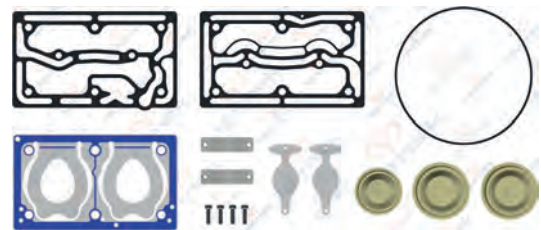

**RK.01.352.19** Repair Kit

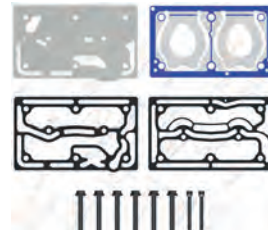

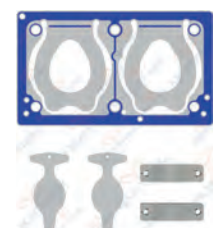

OEM No : 21322318 - 21477052  
Wabco No : 9125129272 - 4127049382

**RK.01.713** Repair Kit



# CUMMINS-VOLKSWAGEN-JOHN DEERE FORD BRASIL-CATERPILLAR-MACK AIR COMPRESSOR AND REPAIR KIT

**01.874** Cylinder Head

8 680437 027836

**01.1478** Valve Plate



8 680437 077459

**01.876** Crankshaft



M20x1.5 Right Hand



8 680437 027874

**01.565** Cooling Plate





8 680437 024095

**01.878** Bushing



Wabco No : 9120003404 - 9120003406



8 680437 027898

**01.272** Connecting Rod



8 680437 020400

**RK.01.104.00** Piston&Ring (Ø85,00 mm)

RK.01.104.10	85,25 mm
RK.01.104.20	85,50 mm
RK.01.104.30	85,75 mm
RK.01.104.40	86,00 mm



2,00x2,00x4,00



8 680437 060277

**01.142.00** Piston (Ø85,00 mm)

01.142.10	85,25 mm
01.142.20	85,50 mm
01.142.30	85,75 mm
01.142.40	86,00 mm



2,00x2,00x4,00

Wabco No : 9115016242 - 9115016252



8 680437 018674

**01.373.00** Ring (Ø85,00 mm)

01.373.10	85,25 mm
01.373.20	85,50 mm
01.373.30	85,75 mm
01.373.40	86,00 mm



2,00x2,00x4,00

OEM No : 3094621  
Wabco No : 9115019202



8 680437 075431

**RK.01.803** Connecting Rod & Piston



STD.

Wabco No : 9125189242



8 680437 114567

**RK.01.905** Crankshaft Repair Kit



Wabco No : 9125129302



8 680437 109242

**01.144** Nut





M20x1.5 Right Hand

OEM No : 1698672  
Wabco No : 8103410014



8 680437 018742

**RK.01.714** Repair Kit

8 680437 077244

**01.1227** Bushing



52X48X20



8 680437 017936

**01.1227** Bushing



52X48X20



8 680437 017936



**RK.01.066**

Repair Kit

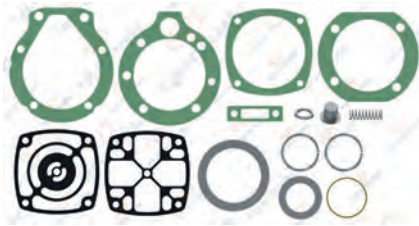

**RK.01.765**

Repair Kit

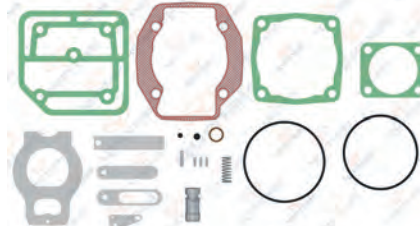

**RK.01.765.01**

Repair Kit

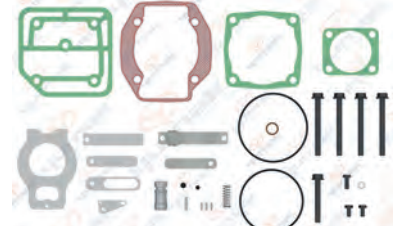

**RK.01.765.02**

Repair Kit

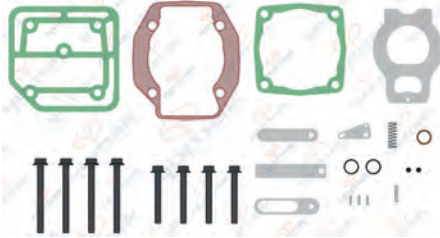

**RK.01.765.03**

Repair Kit

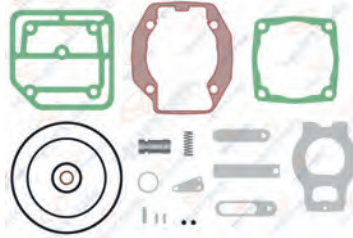

# CUMMINS-VOLKSWAGEN-JOHN DEERE FORD BRASIL-CATERPILLAR-MACK

AIR COMPRESSOR AND REPAIR KIT

WE ARE THE  
TURKISH QUALITY  
AUTHORITY!

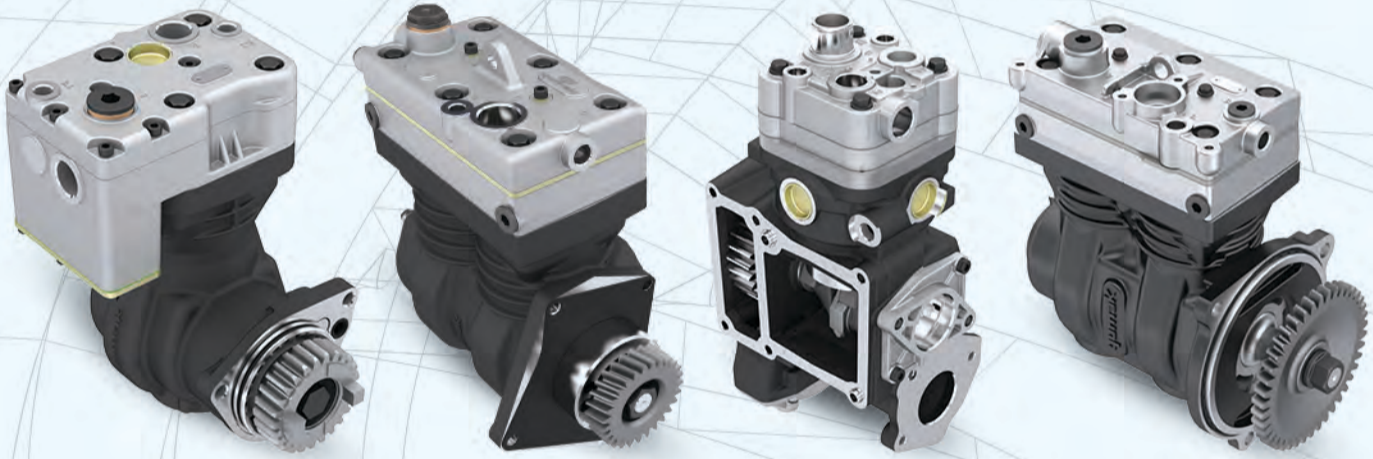

**Contact Information:**

Konya Organize Sanayi Bölgesi Büyük Kayalık Mahallesi  
T.Ziyaeddin Caddesi No:14 Selçuklu/Konya/TÜRKİYE

Tel: +90 332 346 36 60 // +90 332 444 1 965  
Fax: +90 332 346 36 65

Info@mehmetyumak.com  
satis@mehmetyumak.com

[www.mehmetyumak.com](http://www.mehmetyumak.com)

 / yumakautomotive

 / yumakautomotive

 / Yumak Air Brake Systems

+90. 332  
**444 1 965**  
[www.mehmetyumak.com](http://www.mehmetyumak.com)

