

WEWELER-COLAERT BV

Headoffice Apeldoorn

tel. +31 55 5385100

fax. +31 55 5385192

Kayersdijk 149
7332 AP Apeldoorn
Postbus 142
7300 AC Apeldoorn
Netherlands
info@weweler.nl

WEWELER-COLAERT NV

Headoffice Poperinge

tel. +32 57 346 201/202/222

fax. +32 57 346 208

Beneluxlaan 1-3
B 8970 Poperinge
Belgium

info@colaert.be

VOLVO

Catalogue Reference

WEWELER-COLAERT

VOLVO : Catalogue Reference

- 1 -index**
- 2 -info**
- 3 -vormen - formes -
shapes - Formen**
- 4 -index types**
- 5 -catalogus - catalogue
Katalog**
- 6 -veerstroppen - brides
U-bolts - Federbriden**
- 7 -toebehoren - accessoires
Zubehör**

Alle gegevens vermeld in deze catalogus werden zorgvuldig verzameld . Wij kunnen geen schadevergoedingen aanvaarden voor eventuele foutieve weergaven .

Toutes les données ont été assemblées soigneusement . Nous ne pouvons pas accepter des recours en indemnisation résultants d'une faute d'inadvertance commise lors de l'établissement du catalogue .

All data were carefully compiled . We cannot accept any claims for compensation due to errors inadvertently made in this catalogue .

Alle Daten wurden sorgfältig erarbeitet . Ersatzansprüche aufgrund von Angaben in diesem Katalog können nicht anerkannt werden .

NL Afkortingen

Voor	: voorveer
A/H	: achter-/hoofdveer + hulpveer
Achter	: achterveer
H	: hulpveer
Bladen	: aantal bladen
BR	: breedte
B	: lengte voor
C	: lengte achter
D1	: busdiam voor
D2	: busdiam achter
R	: oog zonder bus
D....	: draadbus
N....	: nylonbus
P....	: shackle pin
S....	: silentbloc
PH	: pijlhoogte
PAK	: pakketdikte

F Abbreviations

Voor	: ressort avant
A/H	: ressort principal/arrière + auxiliaire
Achter	: ressort arrière
H	: ressort auxiliaire
Lames	: nombre de lames
LRG	: largeur
B	: longueur avant
C	: longueur arrière
D1	: diamètre intérieur des douilles, av.
D2	: diamètre intérieur des douilles, ar.
R	: rouleau sans douille
D....	: rouleau avec bague filetée
N....	: rouleau avec bague nylon
P....	: shackle pin
S....	: silentbloc
FL	: flèche à vide
EP	: épaisseur du paquet

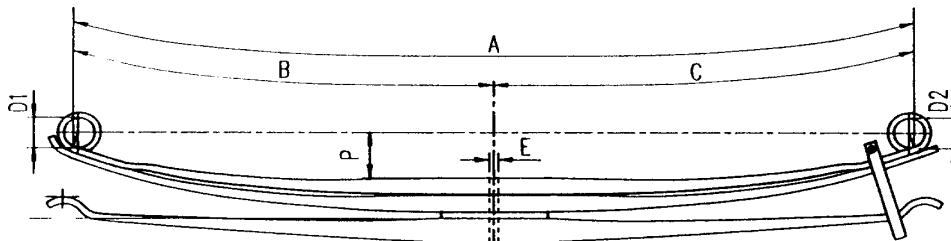

GB Abbreviations

Voor	: front spring
A/H	: main/rear spring + helper
Achter	: rear spring
H	: helper
Leaves	: number of leaves
WID	: width
B	: length front
C	: length rear
D1	: inside diam of front bushes
D2	: inside diam of rear bushes
R	: eye without bush
D....	: threaded bushing
N....	: nylon bushing
P....	: shackle pin
S....	: silentbloc
FA	: free arch
TH	: total height

D Kurzbezeichnungen

Voor	: Vorderfeder
A/H	: Hinter-/Hauptfeder + Zusatzfeder
Achter	: Hinterfeder
H	: Zusatzfeder
Blatt.	: Blattzahl
BR	: Breite
B	: Länge vorne
C	: Länge hinten
D1	: Büchsen diam innen vorne
D2	: Büchsen diam innen hinten
R	: Rolle ohne Büchsen
D....	: Gewinde Büchsen
N....	: Nylon Büchsen
P....	: Shackle pin
S....	: Silentbloc
SP	: Sprengung unbelastet
PAK	: Paketdicke

A01

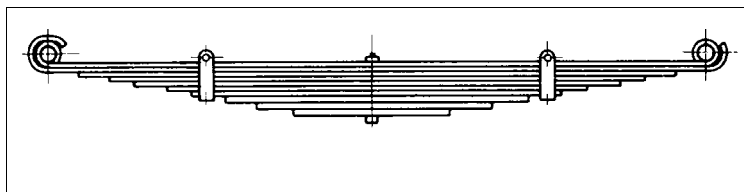

A01A

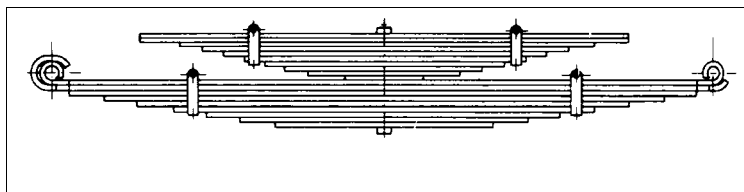

A03

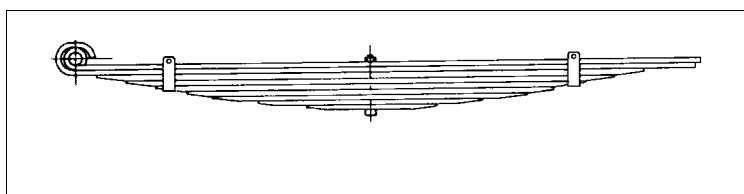

A03.07

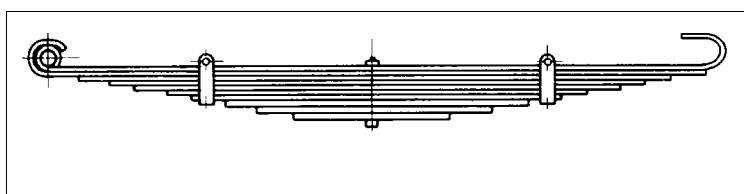

A03A

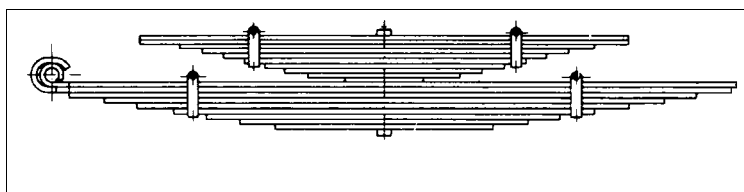

A03B

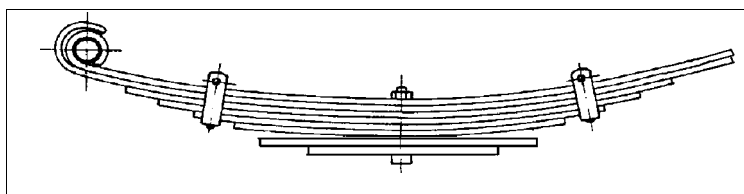

A03t

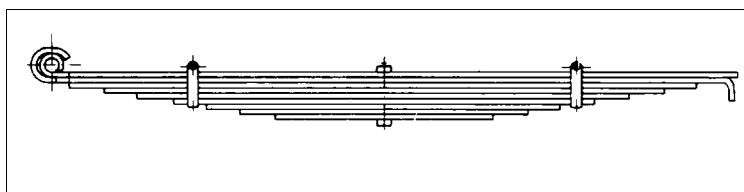

A08

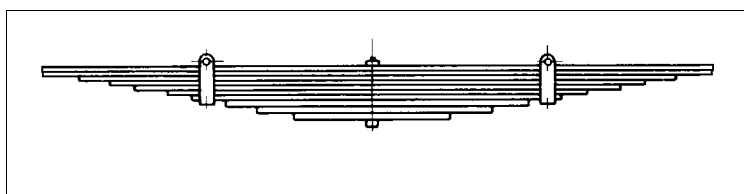

A08.09

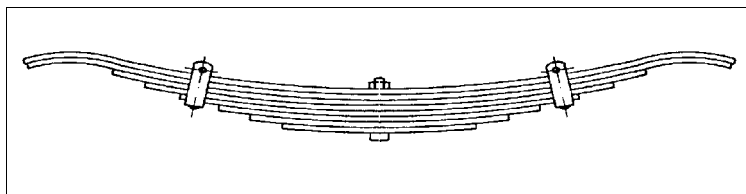

A08R

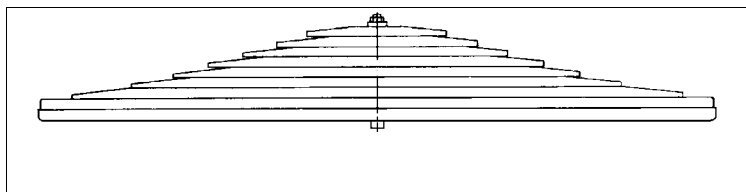

A08R.01

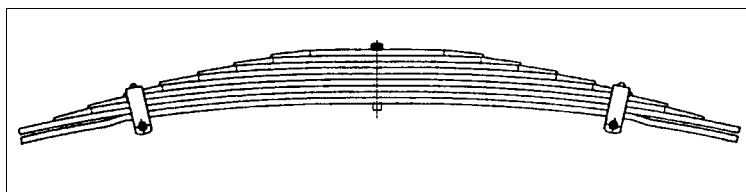

A08tt

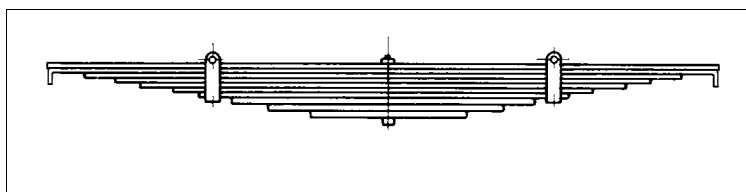

A08ttA

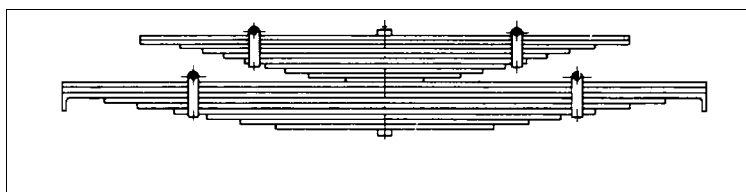

A54

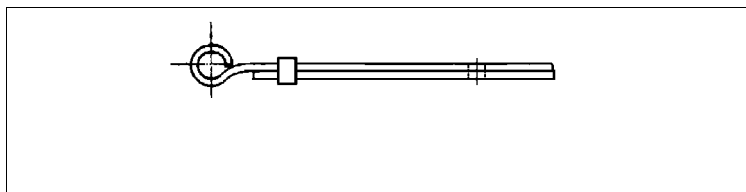

F01

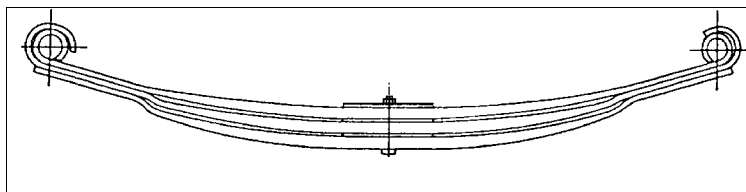

F01A

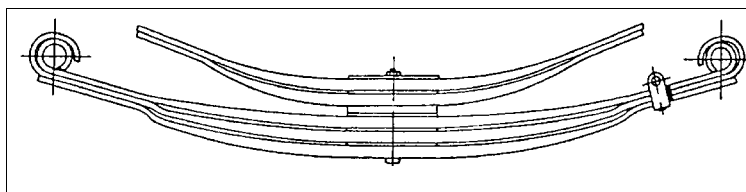

F03

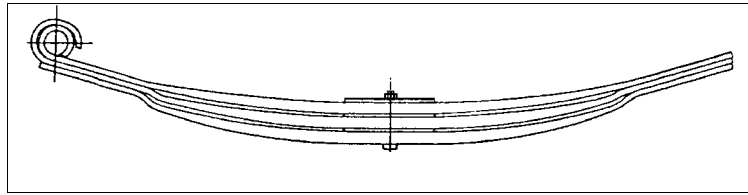

F03.07

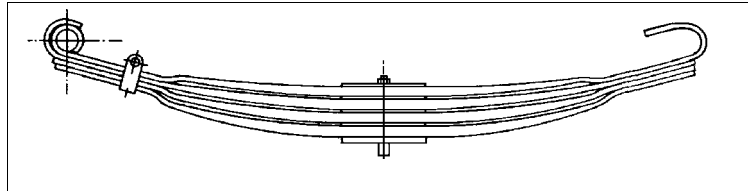

F03.14

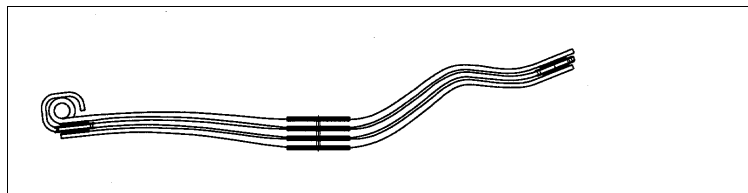

F03A

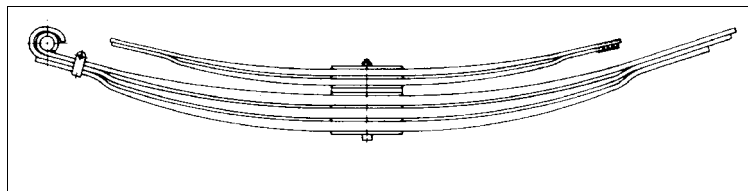

F03A.14

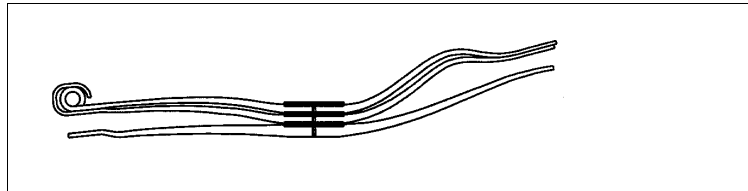

F03B

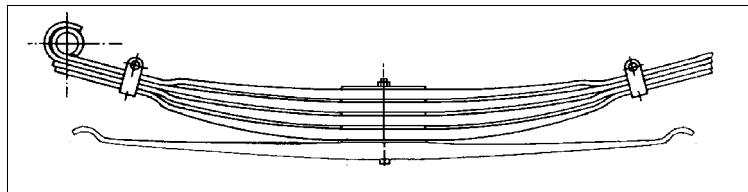

F08

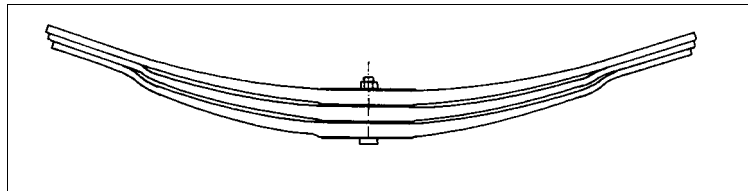

F08R

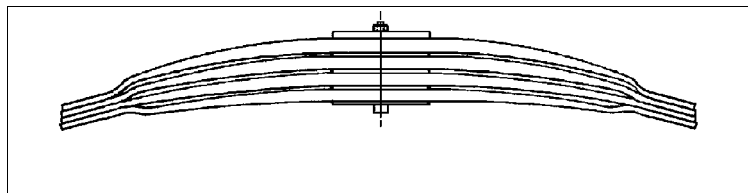

F08RB

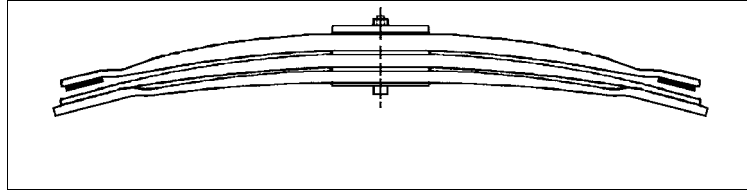

F08tt

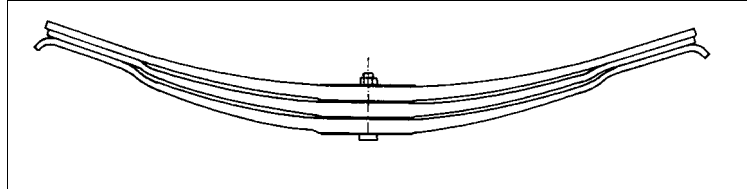

F08ttA

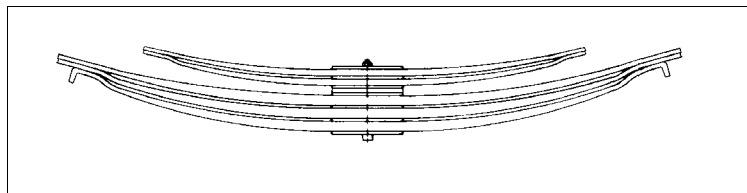

F54.01

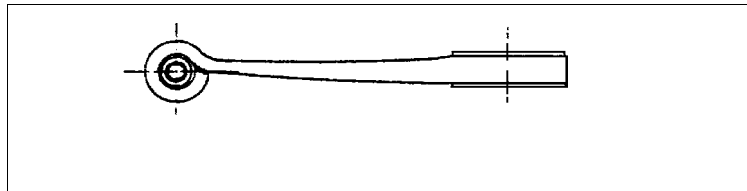

F74.31

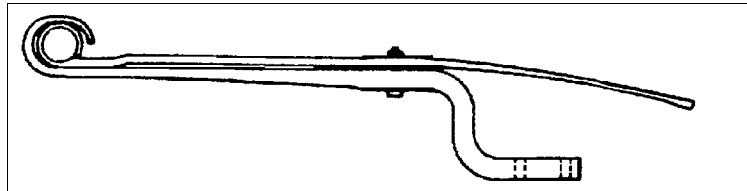

LR5812

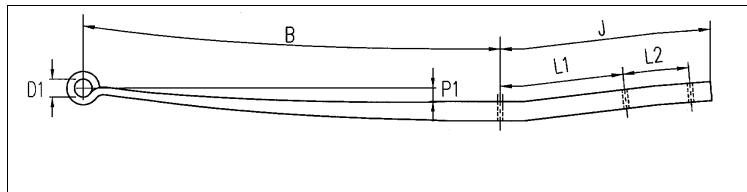

LR5821

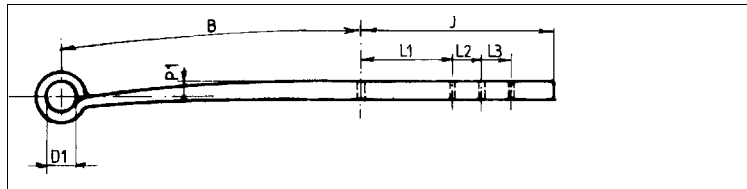

Index types

Serie

VOLVO

B

F 4

F 6

F 7

F10

F12

F16

FH12/FH16

FL 4

FL 6

FL 7

FL10

FM 7

FM10

FM12

FS 7

N 7

N10

N12

BESTELNR N° COMMANDE ORDER NR BESTELNR	BR LRG WID BR	BLADEN LAMES LEAVES BLATT.	B	C	D1	D2	PH FL FA SP	PAK EP TH PAK	DETAIL	MOD	OPMERKINGEN REMARKS REMARKS BEMERKUNGEN
---	------------------------	-------------------------------------	---	---	----	----	----------------------	------------------------	--------	-----	--

SERIE : B**B57****Bus - Coach****voor-avant-front-Vorne**

A022B005ZA75	100	12	800	800	D36X3	D36X3	115	126	1/12+4/11+7/10	A01	
--------------	-----	----	-----	-----	-------	-------	-----	-----	----------------	-----	--

achter-arrière-rear-Hinten

A022B006ZA75	100	15	800	800	D36X3	D36X3	180	144	3/11+3/10+9/9	A01	
--------------	-----	----	-----	-----	-------	-------	-----	-----	---------------	-----	--

B58**Bus - Coach****voor-avant-front-Vorne**

A022B007ZA75	100	13	800	800	D36X3	D36X3	160	134	1/12+2/11+10/10	A01	
--------------	-----	----	-----	-----	-------	-------	-----	-----	-----------------	-----	--

achter-arrière-rear-Hinten

A022B006ZA75	100	15	800	800	D36X3	D36X3	180	144	3/11+3/10+9/9	A01	
--------------	-----	----	-----	-----	-------	-------	-----	-----	---------------	-----	--

B58LUF**Bus - Coach****voor-avant-front-Vorne**

A022B009AB75	100	5	800	800	D36X3	D36X3	175	62	2/13+3/12	A01	
--------------	-----	---	-----	-----	-------	-------	-----	----	-----------	-----	--

A022B009ZB75	100	6	800	800	D36X3	D36X3	220	64	1/13+1/11+4/10	A01	
--------------	-----	---	-----	-----	-------	-------	-----	----	----------------	-----	--

achter-arrière-rear-Hinten

A022B010ZB75	100	6	800	800	D36X3	D36X3	160	58	1/11+2/10+3/9	A01	
--------------	-----	---	-----	-----	-------	-------	-----	----	---------------	-----	--

B7F**Bus - Coach****voor-avant-front-Vorne**

A022B005ZA75	100	12	800	800	D36X3	D36X3	115	126	1/12+4/11+7/10	A01	
--------------	-----	----	-----	-----	-------	-------	-----	-----	----------------	-----	--

achter-arrière-rear-Hinten

A022B006ZA75	100	15	800	800	D36X3	D36X3	180	144	3/11+3/10+9/9	A01	
--------------	-----	----	-----	-----	-------	-------	-----	-----	---------------	-----	--

BESTELNR N° COMMANDE ORDER NR BESTELLNR	BR LRG WID BR	BLADEN LAMES LEAVES BLATT.	B	C	D1	D2	PH FL FA SP	PAK EP TH PAK	DETAIL	MOD	OPMERKINGEN REMARQUES REMARKS BEMERKUNGEN
--	------------------------	-------------------------------------	---	---	----	----	----------------------	------------------------	--------	-----	--

SERIE : B

B7FA

Bus - Coach

voor-avant-front-Vorne

A022B005ZA75	100	12	800	800	D36X3	D36X3	115	126	1/12+4/11+7/10	A01	
--------------	-----	----	-----	-----	-------	-------	-----	-----	----------------	-----	--

achter-arrière-rear-Hinten

A022B006ZA75	100	15	800	800	D36X3	D36X3	180	144	3/11+3/10+9/9	A01	
--------------	-----	----	-----	-----	-------	-------	-----	-----	---------------	-----	--

BB57

Bus - Coach

voor-avant-front-Vorne

A022B005ZA75	100	12	800	800	D36X3	D36X3	115	126	1/12+4/11+7/10	A01	
--------------	-----	----	-----	-----	-------	-------	-----	-----	----------------	-----	--

achter-arrière-rear-Hinten

A022B006ZA75	100	15	800	800	D36X3	D36X3	180	144	3/11+3/10+9/9	A01	
--------------	-----	----	-----	-----	-------	-------	-----	-----	---------------	-----	--

BESTELNR N° COMMANDE ORDER NR BESTELLNR	BR LRG WID BR	BLADEN LAMES LEAVES BLATT.	B	C	D1	D2	PH FL FA SP	PAK EP TH PAK	DETAIL	MOD	OPMERKINGEN REMARKS BEMERKUNGEN
--	------------------------	-------------------------------------	---	---	----	----	----------------------	------------------------	--------	-----	---------------------------------------

SERIE : F 4**F406****voor-avant-front-Vorne**

A022T209ZB70	70	6	785	1075	R40	--	220	66	6/11	A03	
A022T209BB75	70	6	785	1075	P22	--	220	66	6/11	A03	
A022T209AB70	70	6/P	785	1075	R40	--	220	77	6/11+P/11	A03	

achter-arrière-rear-Hinten

A022T276ZA70	70	6/4/1	700	850	R40	--	146	119		A03B	
--------------	----	-------	-----	-----	-----	----	-----	-----	--	------	--

F407**voor-avant-front-Vorne**

A022T209BB75	70	6	785	1075	P22	--	220	66	6/11	A03	
A022T209ZB70	70	6	785	1075	R40	--	220	66	6/11	A03	
A022T209AB70	70	6/P	785	1075	R40	--	220	77	6/11+P/11	A03	

F408**voor-avant-front-Vorne**

A022T209AB70	70	6/P	785	1075	R40	--	220	77	6/11+P/11	A03	
--------------	----	-----	-----	------	-----	----	-----	----	-----------	-----	--

BESTELNR N° COMMANDE ORDER NR BESTELNR	BR LRG WID BR	BLADEN LAMES LEAVES BLATT.	B	C	D1	D2	PH FL FA SP	PAK EP TH PAK	DETAIL	MOD	OPMERKINGEN REMARKS REMARKS BEMERKUNGEN
---	------------------------	-------------------------------------	---	---	----	----	----------------------	------------------------	--------	-----	--

SERIE : F 6**F607****voor-avant-front-Vorne**

A022T213AA75	70	7	785	1075	P22	--	180	84	7/12	A03	
A022T213ZA75	70	7	785	1075	P22	--	180	84	7/12	A03	
A022T213ZB70	70	7/2P	785	1075	P22	--	180	108	7/12+2P/12	A03	

achter-arrière-rear-Hinten

A022T214ZA70	70	8/4	700	845	R40	--	180	140	8/10+4/15	A03B	
--------------	----	-----	-----	-----	-----	----	-----	-----	-----------	------	--

F608**voor-avant-front-Vorne**

A022T213AA75	70	7	785	1075	P22	--	180	84	7/12	A03	
A022T213ZA75	70	7	785	1075	P22	--	180	84	7/12	A03	
A022T213ZB70	70	7/2P	785	1075	P22	--	180	108	7/12+2P/12	A03	

achter-arrière-rear-Hinten

A022T214ZA70	70	8/4	700	845	R40	--	180	140	8/10+4/15	A03B	
--------------	----	-----	-----	-----	-----	----	-----	-----	-----------	------	--

F609**voor-avant-front-Vorne**

A022T213AA75	70	7	785	1075	P22	--	180	84	7/12	A03	
A022T213ZA75	70	7	785	1075	P22	--	180	84	7/12	A03	
A022T213ZB70	70	7/2P	785	1075	P22	--	180	108	7/12+2P/12	A03	

achter-arrière-rear-Hinten

A022T214ZA70	70	8/4	700	845	R40	--	180	140	8/10+4/15	A03B	
--------------	----	-----	-----	-----	-----	----	-----	-----	-----------	------	--

BESTELNR N° COMMANDE ORDER NR BESTELNR	BR LRG WID BR	BLADEN LAMES LEAVES BLATT.	B	C	D1	D2	PH FL FA SP	PAK EP TH PAK	DETAIL	MOD	OPMERKINGEN REMARKS REMARKS BEMERKUNGEN
---	------------------------	-------------------------------------	---	---	----	----	----------------------	------------------------	--------	-----	--

SERIE : F 6**F610****voor-avant-front-Vorne**

A022T255ZB70	70	6	785	1045	R40	--	151	80	2/14+4/13	A03	
A022T255ZA70	70	6/P	785	1045	R40	--	151	92	2/14+4/13+P/12	A03	

achter-arrière-rear-Hinten

A	A022T272ZA71	70	10/7	700	820	R40	--	165	163		A03A	
	A022T272ZA70	70	10	700	820	R40	--	165	100	10/10	A03	
H	A022T272HA80	70	7	590	590	--	--	100	63	7/9	A08	

F611**voor-avant-front-Vorne**

A022T245ZA70	80	5	785	1075	R45	--	120	70	5/14	A03	
--------------	----	---	-----	------	-----	----	-----	----	------	-----	--

achter-arrière-rear-Hinten

A	A022T308ZA71	80	9/6	800	950	R45	--	170	174		A03A	
	A022T308ZA70	80	9	800	950	R45	--	170	108	9/12	A03	
H	A022T308HA80	80	6	690	690	--	--	126	66	6/11	A08	
A	A022T254ZA71	80	8/P/P/5	800	950	R45	--	180	172		A03A	
	A022T254ZA70	80	8/P	800	950	R45	--	180	106	8/12+P/10	A03	
H	A022T254HA80	80	5/P	690	690	--	--	120	66	5/11+P/11	A08	

BESTELNR N° COMMANDE ORDER NR BESTELNR	BR LRG WID BR	BLADEN LAMES LEAVES BLATT.	B	C	D1	D2	PH FL FA SP	PAK EP TH PAK	DETAIL	MOD	OPMERKINGEN REMARQUES REMARKS BEMERKUNGEN
---	------------------------	-------------------------------------	---	---	----	----	----------------------	------------------------	--------	-----	--

SERIE : F 6

F612

voor-avant-front-Vorne

A022T207ZE70											
A022T207ZB70	80	5	785	1045	R45	--	105	75	5/15	A03	
A022T207ZD70	80	6	785	1045	R45	--	105	90	6/15	A03	
A022T263ZA75	80	8	785	1075	P25	--	145	96	8/12	A03	
A022T263AA75	80	8/P	785	1075	P25	--	145	108	8/12+P/12	A03	

achter-arrière-rear-Hinten

	A022T308ZA71	80	9/6	800	950	R45	--	170	174		A03A	
A	A022T308ZA70	80	9	800	950	R45	--	170	108	9/12	A03	
H	A022T308HA80	80	6	690	690	--	--	126	66	6/11	A08	
	A022T266ZA71	80	10/6	800	950	R45	--	170	192		A03A	
A	A022T266ZA70	80	10	800	950	R45	--	170	120	10/12	A03	
H	A022T266HA80	80	6	690	690	--	--	130	72	6/12	A08	
	A022T208ZA71	80	10/6	800	950	R45	--	185	186		A03A	
A	A022T208ZA70	80	10	800	950	R45	--	185	120	10/12	A03	
H	A022T208HA80	80	6	690	690	--	--	102	66	6/11	A08	
	A022T208ZB70	80	10/4	800	950	R45	--	185	184	10/12+4/16	A03B	

F613

voor-avant-front-Vorne

A022T207ZE70											
A022T207ZB70	80	5	785	1045	R45	--	105	75	5/15	A03	
A022T207ZD70	80	6	785	1045	R45	--	105	90	6/15	A03	
A022T263ZA75	80	8	785	1075	P25	--	145	96	8/12	A03	
A022T263AA75	80	8/P	785	1075	P25	--	145	108	8/12+P/12	A03	

achter-arrière-rear-Hinten

	A022T208ZA71	80	10/6	800	950	R45	--	185	186		A03A	
A	A022T208ZA70	80	10	800	950	R45	--	185	120	10/12	A03	
H	A022T208HA80	80	6	690	690	--	--	102	66	6/11	A08	
	A022T266ZA71	80	10/6	800	950	R45	--	170	192		A03A	
A	A022T266ZA70	80	10	800	950	R45	--	170	120	10/12	A03	
H	A022T266HA80	80	6	690	690	--	--	130	72	6/12	A08	
	A022T208ZB70	80	10/4	800	950	R45	--	185	184	10/12+4/16	A03B	

BESTELNR N° COMMANDE ORDER NR BESTELNR	BR LRG WID BR	BLADEN LAMES LEAVES BLATT.	B	C	D1	D2	PH FL FA SP	PAK EP TH PAK	DETAIL	MOD	OPMERKINGEN REMARKS BEMERKUNGEN
---	------------------------	-------------------------------------	---	---	----	----	----------------------	------------------------	--------	-----	---------------------------------------

SERIE : F 6

F614

voor-avant-front-Vorne

A022T207ZE70											
A022T207ZB70	80	5	785	1045	R45	--	105	75	5/15	A03	
A022T207ZD70	80	6	785	1045	R45	--	105	90	6/15	A03	

achter-arrière-rear-Hinten

A	A022T208ZA71	80	10/6	800	950	R45	--	185	186		A03A	
A	A022T208ZA70	80	10	800	950	R45	--	185	120	10/12	A03	
H	A022T208HA80	80	6	690	690	--	--	102	66	6/11	A08	
A	A022T266ZA71	80	10/6	800	950	R45	--	170	192		A03A	
A	A022T266ZA70	80	10	800	950	R45	--	170	120	10/12	A03	
H	A022T266HA80	80	6	690	690	--	--	130	72	6/12	A08	

F615

voor-avant-front-Vorne

A022T265ZA70	100	5	935	1035	R45	--	160	82	4/15	A03	
--------------	-----	---	-----	------	-----	----	-----	----	------	-----	--

achter-arrière-rear-Hinten

A	A022T226ZA71	100	5/P/4	1000	1000	--	--	170	147		A08ttA	
A	A022T228ZA70	100	5/P	1000	1000	--	--	170	95	5/17+P/10	A08tt	
H	A022T226HA80	100	4	725	725	--	--	110	52	4/13	A08	
A	A022T310ZA71	100	5/P/P/4	1000	1000	--	--	170	158		A08ttA	
A	A022T310ZA70	100	5/P/P	1000	1000	--	--	170	108	5/17+P/13+P/10	A08tt	
H	A022T310HA80	100	4	725	725	--	--	110	50	2/13+2/12	A08	

F616

achter-arrière-rear-Hinten

A	A022T310ZA71	100	5/P/P/4	1000	1000	--	--	170	158		A08ttA	
A	A022T310ZA70	100	5/P/P	1000	1000	--	--	170	108	5/17+P/13+P/10	A08tt	
H	A022T310HA80	100	4	725	725	--	--	110	50	2/13+2/12	A08	

BESTELNR N° COMMANDE ORDER NR BESTELNR	BR LRG WID BR	BLADEN LAMES LEAVES BLATT.	B	C	D1	D2	PH FL FA SP	PAK EP TH PAK	DETAIL	MOD	OPMERKINGEN REMARQUES REMARKS BEMERKUNGEN
---	------------------------	-------------------------------------	---	---	----	----	----------------------	------------------------	--------	-----	--

SERIE : F 7**F7 4 X 2****voor-avant-front-Vorne**

A022T303ZA75	100	9	845	1035	D36X3	--	145	126	9/14	A03	
A022T243ZA75	100	8	850	1035	D36X3	--	155	112	8/14	A03	
F022T261ZA75	100	3/P	840	1030	D36X3	--	191	97	3/22+P/22	F03	glijdop/pastille
F022T219ZA75	100	3/P	845	1030	D36X3	--	163	97	3/22+P/22	F03	

achter-arrière-rear-Hinten

	A022T300ZA70	100	11	828	828	--	--	65	154	11/14	A08tt	
	A022T226ZA71	100	5/P/4	1000	1000	--	--	170	147		A08ttA	
A	A022T228ZA70	100	5/P	1000	1000	--	--	170	95	5/17+P/10	A08tt	
H	A022T226HA80	100	4	725	725	--	--	110	52	4/13	A08	
	A022T228ZA71	100	5/P/6	1000	1000	--	--	170	181		A08ttA	
A	A022T228ZA70	100	5/P	1000	1000	--	--	170	95	5/17+P/10	A08tt	
H	A022T228HA80	100	6	725	725	--	--	55	86	2/15+4/14	A08	
	A022Z404ZA71	100	5/P/P/6	1000	1000	--	--	170	204		A08ttA	
A	A022Z404ZA70	100	5/P/P	1000	1000	--	--	170	118		A08tt	
H	A022T228HA80	100	6	725	725	--	--	55	86	2/15+4/14	A08	
	A022T228ZC75	100	2	885	120	P32	--	0	25	1/14+1/11	A54	
	F022T232ZA75	100	3	890	1025	D36X3	--	220	84	3/25	F03	
	F022T222ZA75	100	4/1	890	980	D36X3	--	190	138	4/22+1/35	F03B	
	F022T222ZB75	100	4/1	890	980	D36X3	--	110	138	4/22+1/35	F03B	
	F022T234ZA71	100	3/P/2	975	975	--	--	190	143		F08ttA	
A	F022T234ZA70	100	3	975	975	--	--	190	75	3/21	F08tt	
H	F022T234HA80	100	2/P	730	730	--	--	85	46	2/20+P/22	F08	
	F022T234ZB71	100	3/3	975	975	--	--	190	139		F08ttA	
A	F022T234ZA70	100	3	975	975	--	--	190	75	3/21	F08tt	
H	F022T234HB80	100	3	730	730	--	--	85	89	3/20	F08	
	F022T296ZA71	100	3/4/P/P/4	975	975	--	--	190	217		F08ttA	
A	F022T234ZA70	100	3	975	975	--	--	190	75	3/21	F08tt	
H	F022T296HA80	100	4/P/P	730	730	--	--	85	125	4/20+P/40+P/10	F08	

BESTELNR N° COMMANDE ORDER NR BESTELLNR	BR LRG WID BR	BLADEN LAMES LEAVES BLATT.	B	C	D1	D2	PH FL FA SP	PAK EP TH PAK	DETAIL	MOD	OPMERKINGEN REMARKS REMARKS BEMERKUNGEN
--	------------------------	-------------------------------------	---	---	----	----	----------------------	------------------------	--------	-----	--

SERIE : F 7**F7 6 X 2****voor-avant-front-Vorne**

F022T219ZA75	100	3/P	845	1030	D36X3	--	163	97	3/22+P/22	F03	
F022T223ZA75	100	4	850	1025	D36X3	--	175	104	4/22	F03	

achter-arrière-rear-Hinten

F022T216ZA75	100	5	840	920	D36X3	--	160	125	5/22	F03.07	
F022T268ZA70	80	5	640	960	--	--	20	170	5/32	F08R	YC022C400204

F7 6 X 4**voor-avant-front-Vorne**

A022T303ZA75	100	9	845	1035	D36X3	--	145	126	9/14	A03	
A022T243ZA75	100	8	850	1035	D36X3	--	155	112	8/14	A03	
F022T261ZA75	100	3/P	840	1030	D36X3	--	191	97	3/22+P/22	F03	glijdop/pastille
F022T219ZA75	100	3/P	845	1030	D36X3	--	163	97	3/22+P/22	F03	

achter-arrière-rear-Hinten

A022T236ZA70	90	8	775	775	--	--	55	192	8/24	A08R	
A022T320ZA70	90	8	778	778	--	--	50	192	8/24	A08R	
A022T322ZA70	90	8	790	790	--	--	55	192	8/24	A08R	
A022T230ZA70	100	10	0	0	--	--		110	10/11	A08R	tandem
F022T268ZA70	80	5	640	960	--	--	20	170	5/32	F08R	YC022C400204
F022T246ZA70	90	2/P	780	780	--	--	43	132	2/54+P/18	F08R	
F022T326ZA70	90	2/P	795	795	--	--	31	126	2/52+P/16	F08R	YC022C400204

BESTELNR N° COMMANDE ORDER NR BESTELNR	BR LRG WID BR	BLADEN LAMES LEAVES BLATT.	B	C	D1	D2	PH FL FA SP	PAK EP TH PAK	DETAIL	MOD	OPMERKINGEN REMARKS REMARKS BEMERKUNGEN
---	------------------------	-------------------------------------	---	---	----	----	----------------------	------------------------	--------	-----	--

SERIE : F 7**F7 8 X 2****voor-avant-front-Vorne**

A022T241ZB75	100	8	580	820	D36X3	--	115	80	8/10	A03	
A022T241ZA75	100	6	850	850	D36X3	--	105	84	6/14	A03	
F022T319ZA75	100	2	575	830	D36X3	--	90	50	2/24	F03	
F022T317ZA75	100	2	848	850	D36X3	--	90	61	2/29	F03	

achter-arrière-rear-Hinten

F022T216ZA75	100	5	840	920	D36X3	--	160	125	5/22	F03.07	
--------------	-----	---	-----	-----	-------	----	-----	-----	------	--------	--

F7 8 X 4**voor-avant-front-Vorne**

A022T241ZB75	100	8	580	820	D36X3	--	115	80	8/10	A03	
A022T241ZA75	100	6	850	850	D36X3	--	105	84	6/14	A03	
F022T319ZA75	100	2	575	830	D36X3	--	90	50	2/24	F03	
F022T317ZA75	100	2	848	850	D36X3	--	90	61	2/29	F03	

achter-arrière-rear-Hinten

A022T236ZA70	90	8	775	775	--	--	55	192	8/24	A08R	
A022T320ZA70	90	8	778	778	--	--	50	192	8/24	A08R	
A022T322ZA70	90	8	790	790	--	--	55	192	8/24	A08R	
A022T230ZA70	100	10	0	0	--	--		110	10/11	A08R	tandem
F022T268ZA70	80	5	640	960	--	--	20	170	5/32	F08R	YC022C400204
F022T244ZA70	90	2/P	845	845	--	--	13	127	2/54+P/13	F08R	
F022T304ZA70	90	2/P	860	860	--	--	15	126	2/54+P/12	F08R	

BESTELNR N° COMMANDE ORDER NR BESTELNR	BR LRG WID BR	BLADEN LAMES LEAVES BLATT.	B	C	D1	D2	PH FL FA SP	PAK EP TH PAK	DETAIL	MOD	OPMERKINGEN REMARQUES REMARKS BEMERKUNGEN
---	------------------------	-------------------------------------	---	---	----	----	----------------------	------------------------	--------	-----	--

SERIE : F10**F10 4 X 2****voor-avant-front-Vorne**

A022T291ZA75	100	10	890	815	D36X3	D36X3	153	130	10/13	A01	
A022T259ZA75	100	10	935	820	D36X3	D36X3	155	120	10/12	A01	
A022T257ZA75	100	10	935	820	D36X3	D36X3	155	130	10/13	A01	
A022T247ZB75	100	4/2P	935	1045	D36X3	--	165	96	2/18+2/19+2P/11	A03	
A022T281ZA75	100	9	940	1035	D36X3	--	170	126	9/14	A03	
A022T227ZA75	100	9	940	1035	D36X3	--	170	126	9/14	A03	
A022T277ZA75	100	10	930	1040	D36X3	--	215	120	10/12	A03t	
A022T279ZA75	100	10	930	1040	D36X3	--	215	120	10/12	A03t	
F022T293ZA75	100	2	890	820	D36X3	D36X3	115	65	2/30	F01	
F022T295ZA75	100	3	895	822	D36X3	D36X3	95	90	3/27	F01	
F022T289ZA75	100	3	935	815	D36X3	D36X3	145	87	3/25	F01	
F022T249ZA75	100	3/P	935	815	D36X3	D36X3	170	87	3/22+P/13	F01	glijdop/pastille
F022T221ZA75	100	3/P	935	1025	D36X3	--	155	90	3/23+P/12	F03	

BESTELNR N° COMMANDE ORDER NR BESTELNR	BR LRG WID BR	BLADEN LAMES LEAVES BLATT.	B	C	D1	D2	PH FL FA SP	PAK EP TH PAK	DETAIL	MOD	OPMERKINGEN REMARKS REMARKS BEMERKUNGEN
---	------------------------	-------------------------------------	---	---	----	----	----------------------	------------------------	--------	-----	--

SERIE : F10

F10 4 X 2

achter-arrière-rear-Hinten

	A022T300ZA70	100	11	828	828	--	--	65	154	11/14	A08tt	
	A022T226ZA71	100	5/P/4	1000	1000	--	--	170	147		A08ttA	
A	A022T228ZA70	100	5/P	1000	1000	--	--	170	95	5/17+P/10	A08tt	
H	A022T226HA80	100	4	725	725	--	--	110	52	4/13	A08	
	A022T228ZA71	100	5/P/6	1000	1000	--	--	170	181		A08ttA	
A	A022T228ZA70	100	5/P	1000	1000	--	--	170	95	5/17+P/10	A08tt	
H	A022T228HA80	100	6	725	725	--	--	55	86	2/15+4/14	A08	
	A022Z404ZA71	100	5/P/P/6	1000	1000	--	--	170	204		A08ttA	
A	A022Z404ZA70	100	5/P/P	1000	1000	--	--	170	118		A08tt	
H	A022T228HA80	100	6	725	725	--	--	55	86	2/15+4/14	A08	
	A022T298ZA71	100	14/P/11	1025	1025	--	--	275	260		A08ttA	
A	A022T298ZA70	100	14/P	1025	1025	--	--	275	150	14/10+P/10	A08tt	
H	A022T298HA80	100	11	725	725	--	--	110	110	11/10	A08	
	A022T228ZB75	100	1	885	120	P32	--	0	17	1/17	A54	
	A022T228ZC75	100	2	885	120	P32	--	0	25	1/14+1/11	A54	
	F022T274ZA75	100	3	895	822	D45X3	D45X3	120	105	3/32	F01	glijdop/pastille
	F022T232ZA75	100	3	890	1025	D36X3	--	220	84	3/25	F03	
	F022T222ZB75	100	4/1	890	980	D36X3	--	110	138	4/22+1/35	F03B	
	F022T222ZA75	100	4/1	890	980	D36X3	--	190	138	4/22+1/35	F03B	
	F022T234ZA71	100	3/P/2	975	975	--	--	190	143		F08ttA	
A	F022T234ZA70	100	3	975	975	--	--	190	75	3/21	F08tt	
H	F022T234HA80	100	2/P	730	730	--	--	85	46	2/20+P/22	F08	
	F022T234ZB71	100	3/3	975	975	--	--	190	139		F08ttA	
A	F022T234ZA70	100	3	975	975	--	--	190	75	3/21	F08tt	
H	F022T234HB80	100	3	730	730	--	--	85	89	3/20	F08	
	F022T296ZA71	100	3/4/P/P/4	975	975	--	--	190	217		F08ttA	
A	F022T234ZA70	100	3	975	975	--	--	190	75	3/21	F08tt	
H	F022T296HA80	100	4/P/P	730	730	--	--	85	125	4/20+P/40+P/10	F08	
	F022T302ZA75	100	2	760	1025	S24	--				F74.31	Lenker

BESTELNR N° COMMANDE ORDER NR BESTELLNR	BR LRG WID BR	BLADEN LAMES LEAVES BLATT.	B	C	D1	D2	PH FL FA SP	PAK EP TH PAK	DETAIL	MOD	OPMERKINGEN REMARQUES REMARKS BEMERKUNGEN
--	------------------------	-------------------------------------	---	---	----	----	----------------------	------------------------	--------	-----	--

SERIE : F10**F10 6 X 2****voor-avant-front-Vorne**

A022T291ZA75	100	10	890	815	D36X3	D36X3	153	130	10/13	A01	
A022T257ZA75	100	10	935	820	D36X3	D36X3	155	130	10/13	A01	
A022T259ZA75	100	10	935	820	D36X3	D36X3	155	120	10/12	A01	
A022T247ZB75	100	4/2P	935	1045	D36X3	--	165	96	2/18+2/19+2P/11	A03	
A022T227ZA75	100	9	940	1035	D36X3	--	170	126	9/14	A03	
A022T281ZA75	100	9	940	1035	D36X3	--	170	126	9/14	A03	
A022T277ZA75	100	10	930	1040	D36X3	--	215	120	10/12	A03t	
A022T279ZA75	100	10	930	1040	D36X3	--	215	120	10/12	A03t	
F022T293ZA75	100	2	890	820	D36X3	D36X3	115	65	2/30	F01	
F022T295ZA75	100	3	895	822	D36X3	D36X3	95	90	3/27	F01	
F022T289ZA75	100	3	935	815	D36X3	D36X3	145	87	3/25	F01	
F022T251ZA75	100	3	935	815	D36X3	D36X3	150	84	3/25	F01	glijdop/pastille
F022T249ZA75	100	3/P	935	815	D36X3	D36X3	170	87	3/22+P/13	F01	glijdop/pastille
F022T221ZA75	100	3/P	935	1025	D36X3	--	155	90	3/23+P/12	F03	
F022T231ZA75	100	4	935	1025	D36X3	--	175	104	4/23	F03	

achter-arrière-rear-Hinten

A022T212ZC75	100	8	845	930	D36X3	--	110	136	8/17	A03.07	
F022T216ZA75	100	5	840	920	D36X3	--	160	125	5/22	F03.07	
F022T216ZA76	100	6	840	920	D36	--	160	150	6/22	F03.07	
F022T216ZA75	100	5	840	920	D36X3	--	160	125	5/22	F03.07	
H F022T216HA80	100	1	865	920	--	--	235	22	1/22	F08	
F022T328ZA70	80	4	640	960	--	--	25	136	4/32	F08R	YC022C400204
F022T268ZA70	80	5	640	960	--	--	20	170	5/32	F08R	YC022C400204
F022T302ZA75	100	2	760	1025	S24	--				F74.31	Lenker

BESTELNR N° COMMANDE ORDER NR BESTELNR	BR LRG WID BR	BLADEN LAMES LEAVES BLATT.	B	C	D1	D2	PH FL FA SP	PAK EP TH PAK	DETAIL	MOD	OPMERKINGEN REMARQUES REMARKS BEMERKUNGEN
---	------------------------	-------------------------------------	---	---	----	----	----------------------	------------------------	--------	-----	--

SERIE : F10**F10 6 X 4****voor-avant-front-Vorne**

A022T291ZA75	100	10	890	815	D36X3	D36X3	153	130	10/13	A01	
A022T257ZA75	100	10	935	820	D36X3	D36X3	155	130	10/13	A01	
A022T259ZA75	100	10	935	820	D36X3	D36X3	155	120	10/12	A01	
A022T247ZB75	100	4/2P	935	1045	D36X3	--	165	96	2/18+2/19+2P/11	A03	
A022T227ZA75	100	9	940	1035	D36X3	--	170	126	9/14	A03	
A022T281ZA75	100	9	940	1035	D36X3	--	170	126	9/14	A03	
A022T279ZA75	100	10	930	1040	D36X3	--	215	120	10/12	A03t	
A022T277ZA75	100	10	930	1040	D36X3	--	215	120	10/12	A03t	
F022T293ZA75	100	2	890	820	D36X3	D36X3	115	65	2/30	F01	
F022T295ZA75	100	3	895	822	D36X3	D36X3	95	90	3/27	F01	
F022T289ZA75	100	3	935	815	D36X3	D36X3	145	87	3/25	F01	
F022T249ZA75	100	3/P	935	815	D36X3	D36X3	170	87	3/22+P/13	F01	glijdop/pastille
F022T221ZA75	100	3/P	935	1025	D36X3	--	155	90	3/23+P/12	F03	

achter-arrière-rear-Hinten

A022T236ZA70	90	8	775	775	--	--	55	192	8/24	A08R	
A022T320ZA70	90	8	778	778	--	--	50	192	8/24	A08R	
A022T322ZA70	90	8	790	790	--	--	55	192	8/24	A08R	
A022T284ZA70	90	9	790	790	--	--	55	234	9/26	A08R	YC022C400204
A022T248ZA70	90	9	790	790	--	--	55	234	9/26	A08R	
A022T230ZA70	100	10	0	0	--	--		110	10/11	A08R	tandem
F022T246ZA70	90	2/P	780	780	--	--	43	132	2/54+P/18	F08R	
F022T326ZA70	90	2/P	795	795	--	--	31	126	2/52+P/16	F08R	YC022C400204

BESTELNR N° COMMANDE ORDER NR BESTELNR	BR LRG WID BR	BLADEN LAMES LEAVES BLATT.	B	C	D1	D2	PH FL FA SP	PAK EP TH PAK	DETAIL	MOD	OPMERKINGEN REMARQUES REMARKS BEMERKUNGEN
---	------------------------	-------------------------------------	---	---	----	----	----------------------	------------------------	--------	-----	--

SERIE : F12

F12 4 X 2

voor-avant-front-Vorne

A022T291ZA75	100	10	890	815	D36X3	D36X3	153	130	10/13	A01	
A022T257ZA75	100	10	935	820	D36X3	D36X3	155	130	10/13	A01	
A022T259ZA75	100	10	935	820	D36X3	D36X3	155	120	10/12	A01	
A022T247ZB75	100	4/2P	935	1045	D36X3	--	165	96	2/18+2/19+2P/11	A03	
A022T227ZA75	100	9	940	1035	D36X3	--	170	126	9/14	A03	
A022T281ZA75	100	9	940	1035	D36X3	--	170	126	9/14	A03	
A022T279ZA75	100	10	930	1040	D36X3	--	215	120	10/12	A03t	
A022T277ZA75	100	10	930	1040	D36X3	--	215	120	10/12	A03t	
F022T293ZA75	100	2	890	820	D36X3	D36X3	115	65	2/30	F01	
F022T295ZA75	100	3	895	822	D36X3	D36X3	95	90	3/27	F01	
F022T297ZA75	100	4	895	822	D36X3	D36X3	100	120	4/27	F01	
F022T249ZA75	100	3/P	935	815	D36X3	D36X3	170	87	3/22+P/13	F01	glijdop/pastille
F022T251ZA75	100	3	935	815	D36X3	D36X3	150	84	3/25	F01	glijdop/pastille
F022T267ZA75	100	3	935	815	D36X3	D36X3	165	87	3/26	F01	
F022T289ZA75	100	3	935	815	D36X3	D36X3	145	87	3/25	F01	
F022T221ZA75	100	3/P	935	1025	D36X3	--	155	90	3/23+P/12	F03	
F022T231ZA75	100	4	935	1025	D36X3	--	175	104	4/23	F03	

BESTELNR N° COMMANDE ORDER NR BESTELNR	BR LRG WID BR	BLADEN LAMES LEAVES BLATT.	B	C	D1	D2	PH FL FA SP	PAK EP TH PAK	DETAIL	MOD	OPMERKINGEN REMARKS REMARKS BEMERKUNGEN
---	------------------------	-------------------------------------	---	---	----	----	----------------------	------------------------	--------	-----	--

SERIE : F12

F12 4 X 2

achter-arrière-rear-Hinten

	A022T300ZA70	100	11	828	828	--	--	65	154	11/14	A08tt	
	A022T226ZA71	100	5/P/4	1000	1000	--	--	170	147		A08ttA	
A	A022T228ZA70	100	5/P	1000	1000	--	--	170	95	5/17+P/10	A08tt	
H	A022T226HA80	100	4	725	725	--	--	110	52	4/13	A08	
	A022T228ZA71	100	5/P/6	1000	1000	--	--	170	181		A08ttA	
A	A022T228ZA70	100	5/P	1000	1000	--	--	170	95	5/17+P/10	A08tt	
H	A022T228HA80	100	6	725	725	--	--	55	86	2/15+4/14	A08	
	A022Z404ZA71	100	5/P/P/6	1000	1000	--	--	170	204		A08ttA	
A	A022Z404ZA70	100	5/P/P	1000	1000	--	--	170	118		A08tt	
H	A022T228HA80	100	6	725	725	--	--	55	86	2/15+4/14	A08	
	A022T298ZA71	100	14/P/11	1025	1025	--	--	275	260		A08ttA	
A	A022T298ZA70	100	14/P	1025	1025	--	--	275	150	14/10+P/10	A08tt	
H	A022T298HA80	100	11	725	725	--	--	110	110	11/10	A08	
	A022T228ZB75	100	1	885	120	P32	--	0	17	1/17	A54	
	A022T228ZC75	100	2	885	120	P32	--	0	25	1/14+1/11	A54	
	F022T274ZA75	100	3	895	822	D45X3	D45X3	120	105	3/32	F01	glijdop/pastille
	F022T232ZA75	100	3	890	1025	D36X3	--	220	84	3/25	F03	
	F022T222ZA75	100	4/1	890	980	D36X3	--	190	138	4/22+1/35	F03B	
	F022T222ZB75	100	4/1	890	980	D36X3	--	110	138	4/22+1/35	F03B	
	F022T234ZA71	100	3/P/2	975	975	--	--	190	143		F08ttA	
A	F022T234ZA70	100	3	975	975	--	--	190	75	3/21	F08tt	
H	F022T234HA80	100	2/P	730	730	--	--	85	46	2/20+P/22	F08	
	F022T234ZB71	100	3/3	975	975	--	--	190	139		F08ttA	
A	F022T234ZA70	100	3	975	975	--	--	190	75	3/21	F08tt	
H	F022T234HB80	100	3	730	730	--	--	85	89	3/20	F08	
	F022T296ZA71	100	3/4/P/P/4	975	975	--	--	190	217		F08ttA	
A	F022T234ZA70	100	3	975	975	--	--	190	75	3/21	F08tt	
H	F022T296HA80	100	4/P/P	730	730	--	--	85	125	4/20+P/40+P/10	F08	
	F022T302ZA75	100	2	760	1025	S24	--				F74.31	Lenker

BESTELNR N° COMMANDE ORDER NR BESTELNR	BR LRG WID BR	BLADEN LAMES LEAVES BLATT.	B	C	D1	D2	PH FL FA SP	PAK EP TH PAK	DETAIL	MOD	OPMERKINGEN REMARQUES REMARKS BEMERKUNGEN
---	------------------------	-------------------------------------	---	---	----	----	----------------------	------------------------	--------	-----	--

SERIE : F12

F12 6 X 2

voor-avant-front-Vorne

A022T291ZA75	100	10	890	815	D36X3	D36X3	153	130	10/13	A01	
A022T259ZA75	100	10	935	820	D36X3	D36X3	155	120	10/12	A01	
A022T257ZA75	100	10	935	820	D36X3	D36X3	155	130	10/13	A01	
A022T247ZB75	100	4/2P	935	1045	D36X3	--	165	96	2/18+2/19+2P/11	A03	
A022T281ZA75	100	9	940	1035	D36X3	--	170	126	9/14	A03	
A022T227ZA75	100	9	940	1035	D36X3	--	170	126	9/14	A03	
A022T277ZA75	100	10	930	1040	D36X3	--	215	120	10/12	A03t	
A022T279ZA75	100	10	930	1040	D36X3	--	215	120	10/12	A03t	
F022T293ZA75	100	2	890	820	D36X3	D36X3	115	65	2/30	F01	
F022T295ZA75	100	3	895	822	D36X3	D36X3	95	90	3/27	F01	
F022T297ZA75	100	4	895	822	D36X3	D36X3	100	120	4/27	F01	
F022T251ZA75	100	3	935	815	D36X3	D36X3	150	84	3/25	F01	glijdop/pastille
F022T267ZA75	100	3	935	815	D36X3	D36X3	165	87	3/26	F01	
F022T249ZA75	100	3/P	935	815	D36X3	D36X3	170	87	3/22+P/13	F01	glijdop/pastille
F022T289ZA75	100	3	935	815	D36X3	D36X3	145	87	3/25	F01	
F022T221ZA75	100	3/P	935	1025	D36X3	--	155	90	3/23+P/12	F03	
F022T231ZA75	100	4	935	1025	D36X3	--	175	104	4/23	F03	

achter-arrière-rear-Hinten

A022T212ZC75	100	8	845	930	D36X3	--	110	136	8/17	A03.07	
F022T216ZA75	100	5	840	920	D36X3	--	160	125	5/22	F03.07	
F022T216ZA76	100	6	840	920	D36	--	160	150	6/22	F03.07	
F022T216ZA75	100	5	840	920	D36X3	--	160	125	5/22	F03.07	
H F022T216HA80	100	1	865	920	--	--	235	22	1/22	F08	
F022T328ZA70	80	4	640	960	--	--	25	136	4/32	F08R	YC022C400204
F022T268ZA70	80	5	640	960	--	--	20	170	5/32	F08R	YC022C400204
F022T302ZA75	100	2	760	1025	S24	--				F74.31	Lenker

BESTELNR N° COMMANDE ORDER NR BESTELNR	BR LRG WID BR	BLADEN LAMES LEAVES BLATT.	B	C	D1	D2	PH FL FA SP	PAK EP TH PAK	DETAIL	MOD	OPMERKINGEN REMARKS REMARKS BEMERKUNGEN
---	------------------------	-------------------------------------	---	---	----	----	----------------------	------------------------	--------	-----	--

SERIE : F12**F12 6 X 4****voor-avant-front-Vorne**

A022T291ZA75	100	10	890	815	D36X3	D36X3	153	130	10/13	A01	
A022T259ZA75	100	10	935	820	D36X3	D36X3	155	120	10/12	A01	
A022T257ZA75	100	10	935	820	D36X3	D36X3	155	130	10/13	A01	
A022T247ZB75	100	4/2P	935	1045	D36X3	--	165	96	2/18+2/19+2P/11	A03	
A022T281ZA75	100	9	940	1035	D36X3	--	170	126	9/14	A03	
A022T227ZA75	100	9	940	1035	D36X3	--	170	126	9/14	A03	
A022T277ZA75	100	10	930	1040	D36X3	--	215	120	10/12	A03t	
A022T279ZA75	100	10	930	1040	D36X3	--	215	120	10/12	A03t	
F022T293ZA75	100	2	890	820	D36X3	D36X3	115	65	2/30	F01	
F022T295ZA75	100	3	895	822	D36X3	D36X3	95	90	3/27	F01	
F022T297ZA75	100	4	895	822	D36X3	D36X3	100	120	4/27	F01	
F022T249ZA75	100	3/P	935	815	D36X3	D36X3	170	87	3/22+P/13	F01	glijdop/pastille
F022T289ZA75	100	3	935	815	D36X3	D36X3	145	87	3/25	F01	
F022T251ZA75	100	3	935	815	D36X3	D36X3	150	84	3/25	F01	glijdop/pastille
F022T267ZA75	100	3	935	815	D36X3	D36X3	165	87	3/26	F01	
F022T221ZA75	100	3/P	935	1025	D36X3	--	155	90	3/23+P/12	F03	
F022T231ZA75	100	4	935	1025	D36X3	--	175	104	4/23	F03	

achter-arrière-rear-Hinten

A022T236ZA70	90	8	775	775	--	--	55	192	8/24	A08R	
A022T320ZA70	90	8	778	778	--	--	50	192	8/24	A08R	
A022T322ZA70	90	8	790	790	--	--	55	192	8/24	A08R	
A022T264ZA70	90	9	790	790	--	--	55	234	9/26	A08R	
A022T284ZA70	90	9	790	790	--	--	55	234	9/26	A08R	YC022C400204
A022T248ZA70	90	9	790	790	--	--	55	234	9/26	A08R	
A022T230ZA70	100	10	0	0	--	--		110	10/11	A08R	tandem
F022T246ZA70	90	2/P	780	780	--	--	43	132	2/54+P/18	F08R	
F022T326ZA70	90	2/P	795	795	--	--	31	126	2/52+P/16	F08R	YC022C400204

BESTELNR N° COMMANDE ORDER NR BESTELLNR	BR LRG WID BR	BLADEN LAMES LEAVES BLATT.	B	C	D1	D2	PH FL FA SP	PAK EP TH PAK	DETAIL	MOD	OPMERKINGEN REMARQUES REMARKS BEMERKUNGEN
--	------------------------	-------------------------------------	---	---	----	----	----------------------	------------------------	--------	-----	--

SERIE : F12

F12 8 X 2

voor-avant-front-Vorne

F022T249ZA75	100	3/P	935	815	D36X3	D36X3	170	87	3/22+P/13	F01	glijdop/pastille
F022T251ZA75	100	3	935	815	D36X3	D36X3	150	84	3/25	F01	glijdop/pastille
F022T289ZA75	100	3	935	815	D36X3	D36X3	145	87	3/25	F01	

F12 8 X 4

voor-avant-front-Vorne

F022T249ZA75	100	3/P	935	815	D36X3	D36X3	170	87	3/22+P/13	F01	glijdop/pastille
F022T251ZA75	100	3	935	815	D36X3	D36X3	150	84	3/25	F01	glijdop/pastille
F022T289ZA75	100	3	935	815	D36X3	D36X3	145	87	3/25	F01	

BESTELNR N° COMMANDE ORDER NR BESTELNR	BR LRG WID BR	BLADEN LAMES LEAVES BLATT.	B	C	D1	D2	PH FL FA SP	PAK EP TH PAK	DETAIL	MOD	OPMERKINGEN REMARKS BEMERKUNGEN
---	------------------------	-------------------------------------	---	---	----	----	----------------------	------------------------	--------	-----	---------------------------------------

SERIE : F16

F16 4 X 2

voor-avant-front-Vorne

F022T293ZA75	100	2	890	820	D36X3	D36X3	115	65	2/30	F01	
F022T295ZA75	100	3	895	822	D36X3	D36X3	95	90	3/27	F01	
F022T297ZA75	100	4	895	822	D36X3	D36X3	100	120	4/27	F01	

achter-arrière-rear-Hinten

A	A022T228ZA71	100	5/P/6	1000	1000	--	--	170	181		A08ttA	
A	A022T228ZA70	100	5/P	1000	1000	--	--	170	95	5/17+P/10	A08tt	
H	A022T228HA80	100	6	725	725	--	--	55	86	2/15+4/14	A08	
	A022T228ZC75	100	2	885	120	P32	--	0	25	1/14+1/11	A54	
	F022T306ZA75	100	4	895	825	D45X3	D45X3	90	132	4/30	F01	glijdop/pastille
	F022T234ZB71	100	3/3	975	975	--	--	190	139		F08ttA	
A	F022T234ZA70	100	3	975	975	--	--	190	75	3/21	F08tt	
H	F022T234HB80	100	3	730	730	--	--	85	89	3/20	F08	
	F022T296ZA71	100	3/4P/P/4	975	975	--	--	190	217		F08ttA	
A	F022T234ZA70	100	3	975	975	--	--	190	75	3/21	F08tt	
H	F022T296HA80	100	4/P/P	730	730	--	--	85	125	4/20+P/40+P/10	F08	

F16 6 X 2

voor-avant-front-Vorne

F022T293ZA75	100	2	890	820	D36X3	D36X3	115	65	2/30	F01	
F022T295ZA75	100	3	895	822	D36X3	D36X3	95	90	3/27	F01	
F022T297ZA75	100	4	895	822	D36X3	D36X3	100	120	4/27	F01	

achter-arrière-rear-Hinten

	F022T216ZA75	100	5	840	920	D36X3	--	160	125	5/22	F03.07	
	F022T216ZA76	100	6	840	920	D36	--	160	150	6/22	F03.07	
	F022T216ZA75	100	5	840	920	D36X3	--	160	125	5/22	F03.07	
H	F022T216HA80	100	1	865	920	--	--	235	22	1/22	F08	
	F022T268ZA70	80	5	640	960	--	--	20	170	5/32	F08R	YC022C400204

BESTELNR N° COMMANDE ORDER NR BESTELLNR	BR LRG WID BR	BLADEN LAMES LEAVES BLATT.	B	C	D1	D2	PH FL FA SP	PAK EP TH PAK	DETAIL	MOD	OPMERKINGEN REMARKS REMARKS BEMERKUNGEN
--	------------------------	-------------------------------------	---	---	----	----	----------------------	------------------------	--------	-----	--

SERIE : F16**F16 6 X 4****voor-avant-front-Vorne**

F022T293ZA75	100	2	890	820	D36X3	D36X3	115	65	2/30	F01	
F022T295ZA75	100	3	895	822	D36X3	D36X3	95	90	3/27	F01	
F022T297ZA75	100	4	895	822	D36X3	D36X3	100	120	4/27	F01	

achter-arrière-rear-Hinten

A022T322ZA70	90	8	790	790	--	--	55	192	8/24	A08R	
A022T284ZA70	90	9	790	790	--	--	55	234	9/26	A08R	YC022C400204
F022T326ZA70	90	2/P	795	795	--	--	31	126	2/52+P/16	F08R	YC022C400204

BESTELNR N° COMMANDE ORDER NR BESTELNR	BR LRG WID BR	BLADEN LAMES LEAVES BLATT.	B	C	D1	D2	PH FL FA SP	PAK EP TH PAK	DETAIL	MOD	OPMERKINGEN REMARKS REMARKS BEMERKUNGEN
---	------------------------	-------------------------------------	---	---	----	----	----------------------	------------------------	--------	-----	--

SERIE : FH12/FH16

FH12/16 4X2/6X2/6X4

Truck - Porteur - Rigid

voor-avant-front-Vorne

A022T367ZA75	100	6	990	900	D34X4	D34X4	230	90	6/15	A01	
A022T365ZA75	100	6	990	900	D36X3	D36X3	230	90	6/15	A01	
F022T359ZA75	100	2	990	900	D36	D36				F01	
F022T361ZA75	100	2	990	900	D34X4	D34X4				F01	
F022T343ZA75	100	2	990	900	D34X4	D34X4	117	70	2/32	F01	
F022T341ZA75	100	2	990	900	D34X4	D34X4	132	65	2/30	F01	
F022T339ZA75	100	2	990	900	D34X4	D34X4	140	63	1/28+1/30	F01	glijdop/pastille
F022T331ZA75	100	2	990	900	D36X3	D36X3	117	70	2/32	F01	
F022T329ZA75	100	2	990	900	D36X3	D36X3	132	65	2/30	F01	
F022T327ZA75	100	2	990	900	D36X3	D36X3	140	63	1/28+1/30	F01	glijdop/pastille
F022T363ZA75	100	3	990	900	D34X4	D34X4	125	99	2/32+1/26	F01	
F022T357ZA75	100	3	990	900	D36X3	D36X3	125	99	2/32+1/26	F01	

Trekker - Tracteur - Tractor

voor-avant-front-Vorne

A022T365ZA75	100	6	990	900	D36X3	D36X3	230	90	6/15	A01	
A022T367ZA75	100	6	990	900	D34X4	D34X4	230	90	6/15	A01	
F022T339ZA75	100	2	990	900	D34X4	D34X4	140	63	1/28+1/30	F01	glijdop/pastille
F022T359ZA75	100	2	990	900	D36	D36				F01	
F022T361ZA75	100	2	990	900	D34X4	D34X4				F01	
F022T343ZA75	100	2	990	900	D34X4	D34X4	117	70	2/32	F01	
F022T331ZA75	100	2	990	900	D36X3	D36X3	117	70	2/32	F01	
F022T327ZA75	100	2	990	900	D36X3	D36X3	140	63	1/28+1/30	F01	glijdop/pastille
F022T353ZA75	100	2	990	900	D34X4	D34X4	135	65	2/30	F01	glijdop/pastille
F022T333ZA75	100	2	990	900	D36X3	D36X3	135	65	2/30	F01	glijdop/pastille
F022T357ZA75	100	3	990	900	D36X3	D36X3	125	99	2/32+1/26	F01	
F022T363ZA75	100	3	990	900	D34X4	D34X4	125	99	2/32+1/26	F01	

BESTELNR N° COMMANDE ORDER NR BESTELNR	BR LRG WID BR	BLADEN LAMES LEAVES BLATT.	B	C	D1	D2	PH FL FA SP	PAK EP TH PAK	DETAIL	MOD	OPMERKINGEN REMARKS REMARKS BEMERKUNGEN
---	------------------------	-------------------------------------	---	---	----	----	----------------------	------------------------	--------	-----	--

SERIE : FH12/FH16

FH12/16 4X2

Truck - Porteur - Rigid

achter-arrière-rear-Hinten

F022T364ZA75	90	3	905	970	S26	--		124	2/35+1/45	F03A.14	
F022T388ZA75	0		0	0				0		Z	
A022T380ZA75	0	15	0	0				212	1/16+14/14	Z	

Trekker - Tracteur - Tractor

achter-arrière-rear-Hinten

A022T382ZA75											
F022T366ZA75	90	3	905	970	S26	--		114	3/35	F03.14	
F022T368ZA75	90	3	905	970	S26	--		125	3/32	F03.14	
F022T388ZA75	0		0	0				0		Z	
A022T380ZA75	0	15	0	0				212	1/16+14/14	Z	

FH12/16 6X2

Truck - Porteur - Rigid

achter-arrière-rear-Hinten

F022T340ZA75											
F022T386ZA75											
F022T348ZA75	100	5	840	945	D36X3	--	160	135	5/24	F03.07	
F022T374ZA75	100	5	840	949	D36X3	--		135	5/24	F03.07	

Trekker - Tracteur - Tractor

achter-arrière-rear-Hinten

F022T340ZA75											
F022T386ZA75											
F022T348ZA75	100	5	840	945	D36X3	--	160	135	5/24	F03.07	
F022T374ZA75	100	5	840	949	D36X3	--		135	5/24	F03.07	

FH12/16 6X2/4

Truck - Porteur - Rigid

achter-arrière-rear-Hinten

F022T364ZA75	90	3	905	970	S26	--		124	2/35+1/45	F03A.14	
F022T388ZA75	0		0	0				0		Z	

BESTELNR N° COMMANDE ORDER NR BESTELNR	BR LRG WID BR	BLADEN LAMES LEAVES BLATT.	B	C	D1	D2	PH FL FA SP	PAK EP TH PAK	DETAIL	MOD	OPMERKINGEN REMARQUES REMARKS BEMERKUNGEN
---	------------------------	-------------------------------------	---	---	----	----	----------------------	------------------------	--------	-----	--

SERIE : FH12/FH16

FH12/16 6X4

Truck - Porteur - Rigid

achter-arrière-rear-Hinten

A022T372ZA70	75	11	815	815	--	--	47	286	11/26	A08R.01	
A022T370ZA70	90	9	815	815	--	--	54	234	9/26	A08R.01	
F022T354ZA70	75	4	820	820	--	--	90		4/32	F08R	
F022T356ZA70	75	5	820	820	--	--	90		5/32	F08R	
F022T346ZA70	75	2/1	812	812	--	--	59		2/45+1/68	F08RB	
F022T346ZA85	75	2	812	812	--	--			2/45	F	
F022T384ZA70	75	2/1	815	815	--	--	73	147	2/43+1/55	F08RB	
A022T378ZA70	75		0	0				0		Z	

Trekker - Tracteur - Tractor

achter-arrière-rear-Hinten

A022T372ZA70	75	11	815	815	--	--	47	286	11/26	A08R.01	
A022T370ZA70	90	9	815	815	--	--	54	234	9/26	A08R.01	
F022T354ZA70	75	4	820	820	--	--	90		4/32	F08R	
F022T356ZA70	75	5	820	820	--	--	90		5/32	F08R	
F022T346ZA70	75	2/1	812	812	--	--	59		2/45+1/68	F08RB	
F022T346ZA85	75	2	812	812	--	--			2/45	F	
F022T384ZA70	75	2/1	815	815	--	--	73	147	2/43+1/55	F08RB	
A022T378ZA70	75		0	0				0		Z	

FH12/16 8X2

Truck - Porteur - Rigid

voor-avant-front-Vorne

F022T399ZA75	100	3	795	795	D34X4	D34X4	123	79	1/22+2/24	F01	
F022T345ZA75	100	3	800	800	D36X3	D36X3	126	79	1/22+2/24	F01	
F022T349ZA75	100	2	990	900	D36X3	D36X3	145	70	2/32	F01	
F022T351ZA75	100	2	990	900	D34X4	D34X4	145	70	2/32	F01	

achter-arrière-rear-Hinten

F022T386ZA75											
F022T340ZA75											
F022T348ZA75	100	5	840	945	D36X3	--	160	135	5/24	F03.07	
F022T374ZA75	100	5	840	949	D36X3	--		135	5/24	F03.07	

BESTELNR N° COMMANDE ORDER NR BESTELNR	BR LRG WID BR	BLADEN LAMES LEAVES BLATT.	B	C	D1	D2	PH FL FA SP	PAK EP TH PAK	DETAIL	MOD	OPMERKINGEN REMARKS REMARKS BEMERKUNGEN
---	------------------------	-------------------------------------	---	---	----	----	----------------------	------------------------	--------	-----	--

SERIE : FH12/FH16**FH12/16 8X4****Truck - Porteur - Rigid****voor-avant-front-Vorne**

F022T399ZA75	100	3	795	795	D34X4	D34X4	123	79	1/22+2/24	F01	
F022T345ZA75	100	3	800	800	D36X3	D36X3	126	79	1/22+2/24	F01	
F022T351ZA75	100	2	990	900	D34X4	D34X4	145	70	2/32	F01	
F022T349ZA75	100	2	990	900	D36X3	D36X3	145	70	2/32	F01	

achter-arrière-rear-Hinten

A022T372ZA70	75	11	815	815	--	--	47	286	11/26	A08R.01	
A022T370ZA70	90	9	815	815	--	--	54	234	9/26	A08R.01	
F022T354ZA70	75	4	820	820	--	--	90		4/32	F08R	
F022T356ZA70	75	5	820	820	--	--	90		5/32	F08R	
F022T346ZA70	75	2/1	812	812	--	--	59		2/45+1/68	F08RB	
F022T346ZA85	75	2	812	812	--	--			2/45	F	
F022T384ZA70	75	2/1	815	815	--	--	73	147	2/43+1/55	F08RB	
A022T378ZA70	75		0	0				0		Z	

BESTELNR N° COMMANDE ORDER NR BESTELLNR	BR LRG WID BR	BLADEN LAMES LEAVES BLATT.	B	C	D1	D2	PH FL FA SP	PAK EP TH PAK	DETAIL	MOD	OPMERKINGEN REMARQUES REMARKS BEMERKUNGEN
--	------------------------	-------------------------------------	---	---	----	----	----------------------	------------------------	--------	-----	--

SERIE : FL 4

FL4 4 X 2

achter-arrière-rear-Hinten

F022T344ZA75	80	3/P	700	700	R45	S16	130	93	3/21+P/21	F01	glijdop/pastille
--------------	----	-----	-----	-----	-----	-----	-----	----	-----------	-----	------------------

BESTELNR N° COMMANDE ORDER NR BESTELLNR	BR LRG WID BR	BLADEN LAMES LEAVES BLATT.	B	C	D1	D2	PH FL FA SP	PAK EP TH PAK	DETAIL	MOD	OPMERKINGEN REMARQUES REMARKS BEMERKUNGEN
--	------------------------	-------------------------------------	---	---	----	----	----------------------	------------------------	--------	-----	--

SERIE : FL 6**FL6 4 X 2****voor-avant-front-Vorne**

A022T299ZA75	80	5	850	850	R45	S16	88	72	2/15+3/14	A01	
A022T283ZA75	80	5	900	900	R45	S16	120	82	2/17+3/16	A01	
A022T287ZA75	100	6	940	930	R45	S20			6/17	A01	
A022T285ZA75	100	6	940	930	R45	S20	96	102	6/17	A01	
F022T273ZA75	80	1/P	850	850	D36X3	D36X3	115	53	1/33+P/16	F01	
F022T271ZA75	80	1/P	900	900	D36X3	D36X3	145	59	1/36+P/20	F01	
F022T275ZA75	100	2	935	935	R45	S20	184	62	2/28	F01	glijdop/pastille
F022T309ZA75	100	2	935	935	D36X3	D36X3	171	65	2/30	F01	

BESTELNR N° COMMANDE ORDER NR BESTELNR	BR LRG WID BR	BLADEN LAMES LEAVES BLATT.	B	C	D1	D2	PH FL FA SP	PAK EP TH PAK	DETAIL	MOD	OPMERKINGEN REMARQUES REMARKS BEMERKUNGEN
---	------------------------	-------------------------------------	---	---	----	----	----------------------	------------------------	--------	-----	--

SERIE : FL 6**FL6 4 X 2****achter-arrière-rear-Hinten**

	A022T396ZA75	80	10	650	650	D36	D36		140	10/14	A01	
	A022T352ZA75	80	9	800	800	S16	S16	157	108	9/12	A01	Silentbloc
	A022T294ZA75	100	10	650	650	D36X3	D36X3	82	130	10/13	A01	
A	A022T390ZA76	80	9/6	800	800	R45	S16		0		A01A	
	A022T390ZA75	80	9	800	800	R45	S16		0		A01	
H	A022T390HA80	80	6	660	660	--	--		0		A08	
A	A022T288ZA76	80	10/6	800	800	R45	S16	165	192		A01A	
	A022T288ZA75	80	10	800	800	R45	S16	165	120	10/12	A01	
H	A022T288HA80	80	6	660	660	--	--	125	72	6/12	A08	
A	A022T290ZA76	100	5/P/P/4	880	880	R45	S20	132	174		A01A	
	A022T290ZA75	100	5/P	880	880	R45	S20	132	99	5/17+P/14	A01	
H	A022T290HA80	100	4/P	725	725	--	--	100	75	4/13+P/23	A08	
A	A022T292ZA76	100	5/P/6	880	880	R45	S20	132	171		A01A	
	A022T292ZA75	100	5/P	880	880	R45	S20	132	99	5/17+P/14	A01	
H	A022T292HA80	100	6	725	725	--	--	105	72	6/12	A08	
	F022T350ZA75	80	3/P	800	800	S16	S16	159	97	3/22+P/22	F01	glijdop/pastille
A	F022T330ZA76	80	3/P/1	800	800	S16	S16	175	125		F01A	glijdop/pastille
	F022T330ZA75	80	3/P	800	800	S16	S16	175	97	3/22+P/25	F01	glijdop/pastille
H	F022T330HA80	80	1	655	655	--	--	85	28	1/25	F08	
A	F022T332ZA76	80	3/P/1	800	800	S16	S16	175	125		F01A	glijdop/pastille
	F022T332ZA75	80	3/P	800	800	S16	S16	175	97	3/22+P/25	F01	glijdop/pastille
H	F022T332HA80	80	1	655	655	--	--	85	28	1/25	F08	
A	F022T334ZA76	80	3/P/P/1	800	800	P25	S16	175	147		F01A	glijdop/pastille
	F022T334ZA75	80	3/P	800	800	P25	S16	175	97	3/22+P/25	F01	glijdop/pastille
H	F022T334HA80	80	1/P	655	655	--	--	85	50	1/25+P/22	F08	
A	F022T280ZA76	80	3/P/2	800	800	R45	S16	175	149		F01A	glijdop/pastille
	F022T280ZA75	80	3/P	800	800	R45	S16	175	97	3/22+P/22	F01	glijdop/pastille
H	F022T280HA80	80	2	650	650	--	--	105	52	2/23	F08	
A	F022T324ZA76	100	3/P/P/2	880	880	R45	S20	168	160		F01A	glijdop/pastille
	F022T324ZA75	100	3/P	880	880	R45	S20	168	93	3/23+P/15	F01	glijdop/pastille
H	F022T324HA80	100	2/P	730	730	--	--	107	67	2/23+P/15	F08	
A	F022T282ZA76	100	3/P/3	880	880	R45	S20	168	161		F01A	glijdop/pastille
	F022T282ZA75	100	3/P	880	880	R45	S20	168	92	3/23+P/14	F01	glijdop/pastille
H	F022T282HA80	100	3	730	730	--	--	116	69	3/20	F08	

BESTELNR N° COMMANDE ORDER NR BESTELLNR	BR LRG WID BR	BLADEN LAMES LEAVES BLATT.	B	C	D1	D2	PH FL FA SP	PAK EP TH PAK	DETAIL	MOD	OPMERKINGEN REMARQUES REMARKS BEMERKUNGEN
--	------------------------	-------------------------------------	---	---	----	----	----------------------	------------------------	--------	-----	--

SERIE : FL 6

FL608-FL611 4X2

Truck - Porteur - Rigid

voor-avant-front-Vorne

A022T299ZA75	80	5	850	850	R45	S16	88	72	2/15+3/14	A01	
A022T283ZA75	80	5	900	900	R45	S16	120	82	2/17+3/16	A01	
F022T273ZA75	80	1/P	850	850	D36X3	D36X3	115	53	1/33+P/16	F01	
F022T383ZA75	80	2	850	850	D36X3	D36X3	92	64	2/29	F01	
F022T271ZA75	80	1/P	900	900	D36X3	D36X3	145	59	1/36+P/20	F01	
F022T381ZA75	80	2	900	900	D36X3	D36X3	114	68	2/31	F01	
F022T385ZA75	80	1	900	1015	D36X3	D36X3		25	1/22	F01	Speciaal

achter-arrière-rear-Hinten

	A022T352ZA75	80	9	800	800	S16	S16	157	108	9/12	A01	Silentbloc
A	A022T392ZA76	80	8/6	800	800	S16	S16		168	8/12+6/12	A01A	
H	A022T392ZA75	80	8	800	800	S16	S16	160	96	8/12	A01	
H	A022T392HA80	80	6	660	660	--	--	100	72	6/12	A08	
	F022T350ZA75	80	3/P	800	800	S16	S16	159	97	3/22+P/22	F01	glijdop/pastille
	F022T332ZA76	80	3/P/1	800	800	S16	S16	175	125		F01A	glijdop/pastille
A	F022T332ZA75	80	3/P	800	800	S16	S16	175	97	3/22+P/25	F01	glijdop/pastille
H	F022T332HA80	80	1	655	655	--	--	85	28	1/25	F08	
	F022T394ZA76	0		0	0				0		Z	
A	F022T394ZA75	0		0	0				0		Z	
H	F022T394HA80											

FL612 4X2

Truck - Porteur - Rigid

achter-arrière-rear-Hinten

	A022T288ZA76	80	10/6	800	800	R45	S16	165	192		A01A	
A	A022T288ZA75	80	10	800	800	R45	S16	165	120	10/12	A01	
H	A022T288HA80	80	6	660	660	--	--	125	72	6/12	A08	
	F022T334ZA76	80	3/P/P/1	800	800	P25	S16	175	147		F01A	glijdop/pastille
A	F022T334ZA75	80	3/P	800	800	P25	S16	175	97	3/22+P/25	F01	glijdop/pastille
H	F022T334HA80	80	1/P	655	655	--	--	85	50	1/25+P/22	F08	
	F022T280ZA76	80	3/P/2	800	800	R45	S16	175	149		F01A	glijdop/pastille
A	F022T280ZA75	80	3/P	800	800	R45	S16	175	97	3/22+P/22	F01	glijdop/pastille
H	F022T280HA80	80	2	650	650	--	--	105	52	2/23	F08	

BESTELNR N° COMMANDE ORDER NR BESTELNR	BR LRG WID BR	BLADEN LAMES LEAVES BLATT.	B	C	D1	D2	PH FL FA SP	PAK EP TH PAK	DETAIL	MOD	OPMERKINGEN REMARKS BEMERKUNGEN
---	------------------------	-------------------------------------	---	---	----	----	----------------------	------------------------	--------	-----	---------------------------------------

SERIE : FL 6

FL612-FL614 4X2

Truck - Porteur - Rigid

voor-avant-front-Vorne

A022T283ZA75	80	5	900	900	R45	S16	120	82	2/17+3/16	A01	
F022T271ZA75	80	1/P	900	900	D36X3	D36X3	145	59	1/36+P/20	F01	
F022T387ZA75	80	2	900	900	D36X3	D36X3	145	66	2/29	F01	

achter-arrière-rear-Hinten

A022T396ZA75	80	10	650	650	D36	D36		140	10/14	A01	
--------------	----	----	-----	-----	-----	-----	--	-----	-------	-----	--

FL612-FL615 4X2

Truck - Porteur - Rigid

voor-avant-front-Vorne

F022T387ZA75	80	2	900	900	D36X3	D36X3	145	66	2/29	F01	
F022T385ZA75	80	1	900	1015	D36X3	D36X3		25	1/22	F01	Speciaal
A022T389ZA75	0	6	0	0				0		Z	

achter-arrière-rear-Hinten

A	A022T288ZA76	80	10/6	800	800	R45	S16	165	192		A01A	
	A022T288ZA75	80	10	800	800	R45	S16	165	120	10/12	A01	
H	A022T288HA80	80	6	660	660	--	--	125	72	6/12	A08	
	F022T280ZA76	80	3/P/2	800	800	R45	S16	175	149		F01A	glijdop/pastille
A	F022T280ZA75	80	3/P	800	800	R45	S16	175	97	3/22+P/22	F01	glijdop/pastille
H	F022T280HA80	80	2	650	650	--	--	105	52	2/23	F08	
	F022T404ZA76	0		0	0				0		Z	
A	F022T404ZA75	0		0	0				0		Z	
H	F022T404HA80	0		0	0				0		Z	
	F022T402ZA75	0		0	0				0		Z	
	A022T398ZA76	0		0	0				0		Z	
A	A022T398ZA75	0		0	0				0		Z	
H	A022T398HA80	0		0	0				0		Z	
	A022T400ZA76	0		0	0				0		Z	
A	A022T400ZA75											
H	A022T400HA80	0		0	0				0		Z	

BESTELNR N° COMMANDE ORDER NR BESTELNR	BR LRG WID BR	BLADEN LAMES LEAVES BLATT.	B	C	D1	D2	PH FL FA SP	PAK EP TH PAK	DETAIL	MOD	OPMERKINGEN REMARQUES REMARKS BEMERKUNGEN
---	------------------------	-------------------------------------	---	---	----	----	----------------------	------------------------	--------	-----	--

SERIE : FL 6**FL616-FL619 4X2****Truck - Porteur - Rigid****achter-arrière-rear-Hinten**

	F022T362ZA75	80	5	650	725	D36X3	--	70	130	5/23	F03	
	F022T342ZA76	80	3/P/P/2	880	985	D36X3	--	155	188		F03A	glijdop/pastille
A	F022T342ZA75	80	3/P	880	985	D36X3	--	155	101	3/26+P/15	F03	glijdop/pastille
H	F022T342HA80	80	2/P	750	750	--	--	88	87	2/26+P/30	F08	
	F022T360ZA76	80	3/P/3	880	985	D36X3	--	155	187		F03A	glijdop/pastille
A	F022T360ZA75	80	3/P	880	985	D36X3	--	155	101	3/26+P/15	F03	glijdop/pastille
H	F022T360HA80	80	3	750	750	--	--		86	3/26	F08	

FL616-FL619 6X2**Truck - Porteur - Rigid****achter-arrière-rear-Hinten**

	F022T348ZA75	100	5	840	945	D36X3	--	160	135	5/24	F03.07	
	F022T374ZA75	100	5	840	949	D36X3	--		135	5/24	F03.07	

FL616-FL619 6X4**Truck - Porteur - Rigid****achter-arrière-rear-Hinten**

	F022T356ZA70	75	5	820	820	--	--	90		5/32	F08R	
	F022T384ZA70	75	2/1	815	815	--	--	73	147	2/43+1/55	F08RB	

FL616-FL626 4X2/6X2/6X4**Truck - Porteur - Rigid****voor-avant-front-Vorne**

	A022T369ZA75	100	5	900	900	D36	D36				A01	
	A022T371ZA75	100	6	900	900	D36X3	D36X3	127	107	6/17	A01	
	F022T375ZA75	100	2	900	900	D36X3	D36X3	157	60	2/27	F01	
	F022T379ZA75	100	2	900	900	D36	D36				F01	
	F022T337ZA75	100	2	900	900	D36X3	D36X3	145	66	2/30	F01	
	F022T335ZA75	100	2/P	900	900	D36X3	D36X3	145	106	2/30+P/40	F01	

BESTELNR N° COMMANDE ORDER NR BESTELNR	BR LRG WID BR	BLADEN LAMES LEAVES BLATT.	B	C	D1	D2	PH FL FA SP	PAK EP TH PAK	DETAIL	MOD	OPMERKINGEN REMARKS REMARKS BEMERKUNGEN
---	------------------------	-------------------------------------	---	---	----	----	----------------------	------------------------	--------	-----	--

SERIE : FL 7

FL7 4 X 2

voor-avant-front-Vorne

A022T259ZA75	100	10	935	820	D36X3	D36X3	155	120	10/12	A01	
A022T257ZA75	100	10	935	820	D36X3	D36X3	155	130	10/13	A01	
F022T315ZA75	100	2/P	935	815	D36X3	D36X3	155	75	2/27+P/12	F01	glijdop/pastille
F022T269ZA75	100	2/P	935	815	D36X3	D36X3	155	83	2/29+P/20	F01	
F022T267ZA75	100	3	935	815	D36X3	D36X3	165	87	3/26	F01	

achter-arrière-rear-Hinten

	A022T286ZA70	100	11	720	820	--	--	62	148	3/12+8/14	A08tt	
	A022T226ZA71	100	5/P/4	1000	1000	--	--	170	147		A08ttA	
A	A022T228ZA70	100	5/P	1000	1000	--	--	170	95	5/17+P/10	A08tt	
H	A022T226HA80	100	4	725	725	--	--	110	52	4/13	A08	
	A022T228ZA71	100	5/P/6	1000	1000	--	--	170	181		A08ttA	
A	A022T228ZA70	100	5/P	1000	1000	--	--	170	95	5/17+P/10	A08tt	
H	A022T228HA80	100	6	725	725	--	--	55	86	2/15+4/14	A08	
	A022T298ZA71	100	14/P/11	1025	1025	--	--	275	260		A08ttA	
A	A022T298ZA70	100	14/P	1025	1025	--	--	275	150	14/10+P/10	A08tt	
H	A022T298HA80	100	11	725	725	--	--	110	110	11/10	A08	
	A022T286ZC75	100	2	705	123	P32	--	0	25	1/14+1/11	A54	
	A022T228ZC75	100	2	885	120	P32	--	0	25	1/14+1/11	A54	
	F022T274ZA75	100	3	895	822	D45X3	D45X3	120	105	3/32	F01	glijdop/pastille
	F022T318ZA71	100	3/3	975	975	--	--	175	144		F08ttA	
A	F022T318ZA70	100	3	975	975	--	--	175	75	3/21	F08tt	
H	F022T318HA80	100	3	730	730	--	--	67	69	3/20	F08	
	F022T296ZA71	100	3/4/P/4	975	975	--	--	190	217		F08ttA	
A	F022T234ZA70	100	3	975	975	--	--	190	75	3/21	F08tt	
H	F022T296HA80	100	4/P/P	730	730	--	--	85	125	4/20+P/40+P/10	F08	

BESTELNR N° COMMANDE ORDER NR BESTELNR	BR LRG WID BR	BLADEN LAMES LEAVES BLATT.	B	C	D1	D2	PH FL FA SP	PAK EP TH PAK	DETAIL	MOD	OPMERKINGEN REMARKS REMARKS BEMERKUNGEN
---	------------------------	-------------------------------------	---	---	----	----	----------------------	------------------------	--------	-----	--

SERIE : FL 7**FL7 6 X 2****voor-avant-front-Vorne**

A022T257ZA75	100	10	935	820	D36X3	D36X3	155	130	10/13	A01	
A022T259ZA75	100	10	935	820	D36X3	D36X3	155	120	10/12	A01	
F022T315ZA75	100	2/P	935	815	D36X3	D36X3	155	75	2/27+P/12	F01	glijdop/pastille
F022T269ZA75	100	2/P	935	815	D36X3	D36X3	155	83	2/29+P/20	F01	
F022T267ZA75	100	3	935	815	D36X3	D36X3	165	87	3/26	F01	

achter-arrière-rear-Hinten

A022T286ZA70	100	11	720	820	--	--	62	148	3/12+8/14	A08tt	
F022T274ZA75	100	3	895	822	D45X3	D45X3	120	105	3/32	F01	glijdop/pastille
F022T316ZA75	100	3	840	920	D36X3	--	145	99	3/30	F03.07	
F022T216ZA75	100	5	840	920	D36X3	--	160	125	5/22	F03.07	
F022T216ZA76	100	6	840	920	D36	--	160	150	6/22	F03.07	
F022T216ZA75	100	5	840	920	D36X3	--	160	125	5/22	F03.07	
H F022T216HA80	100	1	865	920	--	--	235	22	1/22	F08	
F022T328ZA70	80	4	640	960	--	--	25	136	4/32	F08R	YC022C400204
F022T268ZA70	80	5	640	960	--	--	20	170	5/32	F08R	YC022C400204

FL7 6 X 4**voor-avant-front-Vorne**

A022T259ZA75	100	10	935	820	D36X3	D36X3	155	120	10/12	A01	
A022T257ZA75	100	10	935	820	D36X3	D36X3	155	130	10/13	A01	
F022T315ZA75	100	2/P	935	815	D36X3	D36X3	155	75	2/27+P/12	F01	glijdop/pastille
F022T269ZA75	100	2/P	935	815	D36X3	D36X3	155	83	2/29+P/20	F01	
F022T267ZA75	100	3	935	815	D36X3	D36X3	165	87	3/26	F01	

achter-arrière-rear-Hinten

A022T322ZA70	90	8	790	790	--	--	55	192	8/24	A08R	
A022T284ZA70	90	9	790	790	--	--	55	234	9/26	A08R	YC022C400204
A022T230ZA70	100	10	0	0	--	--		110	10/11	A08R	tandem
F022T376ZA70	90	2	795	795	--	--	52	96	2/45	F08R	
F022T326ZA70	90	2/P	795	795	--	--	31	126	2/52+P/16	F08R	YC022C400204
F022T304ZA70	90	2/P	860	860	--	--	15	126	2/54+P/12	F08R	

BESTELNR N° COMMANDE ORDER NR BESTELNR	BR LRG WID BR	BLADEN LAMES LEAVES BLATT.	B	C	D1	D2	PH FL FA SP	PAK EP TH PAK	DETAIL	MOD	OPMERKINGEN REMARKS BEMERKUNGEN
---	------------------------	-------------------------------------	---	---	----	----	----------------------	------------------------	--------	-----	---------------------------------------

SERIE : FL 7**FL7 8 X 2****voor-avant-front-Vorne**

F022T307ZA75	100	2/P	835	815	D36X3	D36X3	116	89	2/27+P/30	F01	glijdop/pastille
F022T313ZA75	100	2	835	815	D36X3	D36X3	120	60	2/27	F01	glijdop/pastille
F022T305ZA75	100	2/P	935	815	D36X3	D36X3	125	63	2/29+P/36	F01	glijdop/pastille
F022T311ZA75	100	2	935	815	D36X3	D36X3	135	63	2/29	F01	glijdop/pastille

FL7 8 X 4**voor-avant-front-Vorne**

F022T307ZA75	100	2/P	835	815	D36X3	D36X3	116	89	2/27+P/30	F01	glijdop/pastille
F022T313ZA75	100	2	835	815	D36X3	D36X3	120	60	2/27	F01	glijdop/pastille
F022T305ZA75	100	2/P	935	815	D36X3	D36X3	125	63	2/29+P/36	F01	glijdop/pastille
F022T311ZA75	100	2	935	815	D36X3	D36X3	135	63	2/29	F01	glijdop/pastille

achter-arrière-rear-Hinten

A022T322ZA70	90	8	790	790	--	--	55	192	8/24	A08R	
A022T284ZA70	90	9	790	790	--	--	55	234	9/26	A08R	YC022C400204
A022T230ZA70	100	10	0	0	--	--		110	10/11	A08R	tandem
F022T326ZA70	90	2/P	795	795	--	--	31	126	2/52+P/16	F08R	YC022C400204
F022T304ZA70	90	2/P	860	860	--	--	15	126	2/54+P/12	F08R	

BESTELNR N° COMMANDE ORDER NR BESTELLNR	BR LRG WID BR	BLADEN LAMES LEAVES BLATT.	B	C	D1	D2	PH FL FA SP	PAK EP TH PAK	DETAIL	MOD	OPMERKINGEN REMARQUES REMARKS BEMERKUNGEN
--	------------------------	-------------------------------------	---	---	----	----	----------------------	------------------------	--------	-----	--

SERIE : FL10

FL10 4 X 2

voor-avant-front-Vorne

A022T257ZA75	100	10	935	820	D36X3	D36X3	155	130	10/13	A01	
A022T259ZA75	100	10	935	820	D36X3	D36X3	155	120	10/12	A01	
F022T315ZA75	100	2/P	935	815	D36X3	D36X3	155	75	2/27+P/12	F01	glijdop/pastille
F022T269ZA75	100	2/P	935	815	D36X3	D36X3	155	83	2/29+P/20	F01	
F022T267ZA75	100	3	935	815	D36X3	D36X3	165	87	3/26	F01	

achter-arrière-rear-Hinten

	A022T286ZA70	100	11	720	820	--	--	62	148	3/12+8/14	A08tt	
	A022T226ZA71	100	5/P/4	1000	1000	--	--	170	147		A08ttA	
A	A022T228ZA70	100	5/P	1000	1000	--	--	170	95	5/17+P/10	A08tt	
H	A022T226HA80	100	4	725	725	--	--	110	52	4/13	A08	
	A022T228ZA71	100	5/P/6	1000	1000	--	--	170	181		A08ttA	
A	A022T228ZA70	100	5/P	1000	1000	--	--	170	95	5/17+P/10	A08tt	
H	A022T228HA80	100	6	725	725	--	--	55	86	2/15+4/14	A08	
	A022T298ZA71	100	14/P/11	1025	1025	--	--	275	260		A08ttA	
A	A022T298ZA70	100	14/P	1025	1025	--	--	275	150	14/10+P/10	A08tt	
H	A022T298HA80	100	11	725	725	--	--	110	110	11/10	A08	
	A022T286ZC75	100	2	705	123	P32	--	0	25	1/14+1/11	A54	
	A022T228ZC75	100	2	885	120	P32	--	0	25	1/14+1/11	A54	
	F022T274ZA75	100	3	895	822	D45X3	D45X3	120	105	3/32	F01	glijdop/pastille
	F022T318ZA71	100	3/3	975	975	--	--	175	144		F08ttA	
A	F022T318ZA70	100	3	975	975	--	--	175	75	3/21	F08tt	
H	F022T318HA80	100	3	730	730	--	--	67	69	3/20	F08	
	F022T296ZA71	100	3/4/P/4	975	975	--	--	190	217		F08ttA	
A	F022T234ZA70	100	3	975	975	--	--	190	75	3/21	F08tt	
H	F022T296HA80	100	4/P/P	730	730	--	--	85	125	4/20+P/40+P/10	F08	

BESTELNR N° COMMANDE ORDER NR BESTELNR	BR LRG WID BR	BLADEN LAMES LEAVES BLATT.	B	C	D1	D2	PH FL FA SP	PAK EP TH PAK	DETAIL	MOD	OPMERKINGEN REMARQUES REMARKS BEMERKUNGEN
---	------------------------	-------------------------------------	---	---	----	----	----------------------	------------------------	--------	-----	--

SERIE : FL10**FL10 6 X 2****voor-avant-front-Vorne**

A022T257ZA75	100	10	935	820	D36X3	D36X3	155	130	10/13	A01	
A022T259ZA75	100	10	935	820	D36X3	D36X3	155	120	10/12	A01	
F022T269ZA75	100	2/P	935	815	D36X3	D36X3	155	83	2/29+P/20	F01	
F022T315ZA75	100	2/P	935	815	D36X3	D36X3	155	75	2/27+P/12	F01	glijdop/pastille
F022T267ZA75	100	3	935	815	D36X3	D36X3	165	87	3/26	F01	

achter-arrière-rear-Hinten

A022T286ZA70	100	11	720	820	--	--	62	148	3/12+8/14	A08tt	
F022T274ZA75	100	3	895	822	D45X3	D45X3	120	105	3/32	F01	glijdop/pastille
F022T316ZA75	100	3	840	920	D36X3	--	145	99	3/30	F03.07	
F022T216ZA75	100	5	840	920	D36X3	--	160	125	5/22	F03.07	
F022T216ZA76	100	6	840	920	D36	--	160	150	6/22	F03.07	
F022T216ZA75	100	5	840	920	D36X3	--	160	125	5/22	F03.07	
H F022T216HA80	100	1	865	920	--	--	235	22	1/22	F08	
F022T328ZA70	80	4	640	960	--	--	25	136	4/32	F08R	YC022C400204
F022T268ZA70	80	5	640	960	--	--	20	170	5/32	F08R	YC022C400204

FL10 6 X 4**voor-avant-front-Vorne**

A022T259ZA75	100	10	935	820	D36X3	D36X3	155	120	10/12	A01	
A022T257ZA75	100	10	935	820	D36X3	D36X3	155	130	10/13	A01	
F022T315ZA75	100	2/P	935	815	D36X3	D36X3	155	75	2/27+P/12	F01	glijdop/pastille
F022T269ZA75	100	2/P	935	815	D36X3	D36X3	155	83	2/29+P/20	F01	
F022T267ZA75	100	3	935	815	D36X3	D36X3	165	87	3/26	F01	

achter-arrière-rear-Hinten

A022T322ZA70	90	8	790	790	--	--	55	192	8/24	A08R	
A022T284ZA70	90	9	790	790	--	--	55	234	9/26	A08R	YC022C400204
A022T230ZA70	100	10	0	0	--	--		110	10/11	A08R	tandem
F022T376ZA70	90	2	795	795	--	--	52	96	2/45	F08R	
F022T326ZA70	90	2/P	795	795	--	--	31	126	2/52+P/16	F08R	YC022C400204
F022T304ZA70	90	2/P	860	860	--	--	15	126	2/54+P/12	F08R	

BESTELNR N° COMMANDE ORDER NR BESTELNR	BR LRG WID BR	BLADEN LAMES LEAVES BLATT.	B	C	D1	D2	PH FL FA SP	PAK EP TH PAK	DETAIL	MOD	OPMERKINGEN REMARQUES REMARKS BEMERKUNGEN
---	------------------------	-------------------------------------	---	---	----	----	----------------------	------------------------	--------	-----	--

SERIE : FL10

FL10 8 X 2

voor-avant-front-Vorne

F022T313ZA75	100	2	835	815	D36X3	D36X3	120	60	2/27	F01	glijdop/pastille
F022T307ZA75	100	2/P	835	815	D36X3	D36X3	116	89	2/27+P/30	F01	glijdop/pastille
F022T321ZA75	100	3	835	815	D36X3	D36X3	112	90	3/27	F01	glijdop/pastille
F022T305ZA75	100	2/P	935	815	D36X3	D36X3	125	63	2/29+P/36	F01	glijdop/pastille
F022T311ZA75	100	2	935	815	D36X3	D36X3	135	63	2/29	F01	glijdop/pastille
F022T323ZA75	100	3	935	815	D36X3	D36X3	103	99	3/30	F01	glijdop/pastille

FL10 8 X 4

voor-avant-front-Vorne

F022T307ZA75	100	2/P	835	815	D36X3	D36X3	116	89	2/27+P/30	F01	glijdop/pastille
F022T313ZA75	100	2	835	815	D36X3	D36X3	120	60	2/27	F01	glijdop/pastille
F022T321ZA75	100	3	835	815	D36X3	D36X3	112	90	3/27	F01	glijdop/pastille
F022T311ZA75	100	2	935	815	D36X3	D36X3	135	63	2/29	F01	glijdop/pastille
F022T305ZA75	100	2/P	935	815	D36X3	D36X3	125	63	2/29+P/36	F01	glijdop/pastille
F022T323ZA75	100	3	935	815	D36X3	D36X3	103	99	3/30	F01	glijdop/pastille

achter-arrière-rear-Hinten

A022T322ZA70	90	8	790	790	--	--	55	192	8/24	A08R	
A022T284ZA70	90	9	790	790	--	--	55	234	9/26	A08R	YC022C400204
A022T230ZA70	100	10	0	0	--	--		110	10/11	A08R	tandem
F022T326ZA70	90	2/P	795	795	--	--	31	126	2/52+P/16	F08R	YC022C400204
F022T304ZA70	90	2/P	860	860	--	--	15	126	2/54+P/12	F08R	

BESTELNR N° COMMANDE ORDER NR BESTELNR	BR LRG WID BR	BLADEN LAMES LEAVES BLATT.	B	C	D1	D2	PH FL FA SP	PAK EP TH PAK	DETAIL	MOD	OPMERKINGEN REMARQUES REMARKS BEMERKUNGEN
---	------------------------	-------------------------------------	---	---	----	----	----------------------	------------------------	--------	-----	--

SERIE : FM 7**FM 7 4 X 2****voor-avant-front-Vorne**

A022T367ZA75	100	6	990	900	D34X4	D34X4	230	90	6/15	A01	
F022T339ZA75	100	2	990	900	D34X4	D34X4	140	63	1/28+1/30	F01	glijdop/pastille
F022T361ZA75	100	2	990	900	D34X4	D34X4				F01	

achter-arrière-rear-Hinten

F022T388ZA75	0		0	0				0		Z	
A022T380ZA75	0	15	0	0				212	1/16+14/14	Z	

Truck - Porteur - Rigid**voor-avant-front-Vorne**

F022T341ZA75	100	2	990	900	D34X4	D34X4	132	65	2/30	F01	
--------------	-----	---	-----	-----	-------	-------	-----	----	------	-----	--

achter-arrière-rear-Hinten

F022T364ZA75	90	3	905	970	S26	--		124	2/35+1/45	F03A.14	
--------------	----	---	-----	-----	-----	----	--	-----	-----------	---------	--

Trekker - Tracteur - Tractor**voor-avant-front-Vorne**

F022T353ZA75	100	2	990	900	D34X4	D34X4	135	65	2/30	F01	glijdop/pastille
F022T343ZA75	100	2	990	900	D34X4	D34X4	117	70	2/32	F01	

achter-arrière-rear-Hinten

F022T366ZA75	90	3	905	970	S26	--		114	3/35	F03.14	
--------------	----	---	-----	-----	-----	----	--	-----	------	--------	--

BESTELNR N° COMMANDE ORDER NR BESTELNR	BR LRG WID BR	BLADEN LAMES LEAVES BLATT.	B	C	D1	D2	PH FL FA SP	PAK EP TH PAK	DETAIL	MOD	OPMERKINGEN REMARQUES REMARKS BEMERKUNGEN
---	------------------------	-------------------------------------	---	---	----	----	----------------------	------------------------	--------	-----	--

SERIE : FM 7**FM 7 6 X 2****voor-avant-front-Vorne**

F022T339ZA75	100	2	990	900	D34X4	D34X4	140	63	1/28+1/30	F01	glijdop/pastille
F022T363ZA75	100	3	990	900	D34X4	D34X4	125	99	2/32+1/26	F01	

achter-arrière-rear-Hinten

F022T348ZA75	100	5	840	945	D36X3	--	160	135	5/24	F03.07	
F022T374ZA75	100	5	840	949	D36X3	--		135	5/24	F03.07	
F022T388ZA75	0		0	0				0		Z	

Truck - Porteur - Rigid**voor-avant-front-Vorne**

F022T341ZA75	100	2	990	900	D34X4	D34X4	132	65	2/30	F01	
--------------	-----	---	-----	-----	-------	-------	-----	----	------	-----	--

achter-arrière-rear-Hinten

F022T364ZA75	90	3	905	970	S26	--		124	2/35+1/45	F03A.14	
--------------	----	---	-----	-----	-----	----	--	-----	-----------	---------	--

Trekker - Tracteur - Tractor**voor-avant-front-Vorne**

F022T343ZA75	100	2	990	900	D34X4	D34X4	117	70	2/32	F01	
F022T353ZA75	100	2	990	900	D34X4	D34X4	135	65	2/30	F01	glijdop/pastille

achter-arrière-rear-Hinten

F022T366ZA75	90	3	905	970	S26	--		114	3/35	F03.14	
--------------	----	---	-----	-----	-----	----	--	-----	------	--------	--

BESTELNR N° COMMANDE ORDER NR BESTELNR	BR LRG WID BR	BLADEN LAMES LEAVES BLATT.	B	C	D1	D2	PH FL FA SP	PAK EP TH PAK	DETAIL	MOD	OPMERKINGEN REMARQUES REMARKS BEMERKUNGEN
---	------------------------	-------------------------------------	---	---	----	----	----------------------	------------------------	--------	-----	--

SERIE : FM 7**FM 7 6 X 4****voor-avant-front-Vorne**

A022T367ZA75	100	6	990	900	D34X4	D34X4	230	90	6/15	A01	
F022T395ZA75	100		0	0				0		F01	
F022T361ZA75	100	2	990	900	D34X4	D34X4				F01	
F022T339ZA75	100	2	990	900	D34X4	D34X4	140	63	1/28+1/30	F01	glijdop/pastille
F022T363ZA75	100	3	990	900	D34X4	D34X4	125	99	2/32+1/26	F01	

achter-arrière-rear-Hinten

A022T410ZA70	90	9	0	0	--	--		0		A08R.01	
A022T408ZA70	90	11	0	0	--	--		0		A08R.01	
F022T354ZA70	75	4	820	820	--	--	90		4/32	F08R	
F022T356ZA70	75	5	820	820	--	--	90		5/32	F08R	
F022T346ZA70	75	2/1	812	812	--	--	59		2/45+1/68	F08RB	
F022T346ZA85	75	2	812	812	--	--			2/45	F	
F022T384ZA70	75	2/1	815	815	--	--	73	147	2/43+1/55	F08RB	

Truck - Porteur - Rigid**voor-avant-front-Vorne**

F022T341ZA75	100	2	990	900	D34X4	D34X4	132	65	2/30	F01	
--------------	-----	---	-----	-----	-------	-------	-----	----	------	-----	--

Trekker - Tracteur - Tractor**voor-avant-front-Vorne**

F022T343ZA75	100	2	990	900	D34X4	D34X4	117	70	2/32	F01	
F022T353ZA75	100	2	990	900	D34X4	D34X4	135	65	2/30	F01	glijdop/pastille

BESTELNR N° COMMANDE ORDER NR BESTELLNR	BR LRG WID BR	BLADEN LAMES LEAVES BLATT.	B	C	D1	D2	PH FL FA SP	PAK EP TH PAK	DETAIL	MOD	OPMERKINGEN REMARKS REMARKS BEMERKUNGEN
--	------------------------	-------------------------------------	---	---	----	----	----------------------	------------------------	--------	-----	--

SERIE : FM 7**FM 7 8 X 2****voor-avant-front-Vorne**

F022T397ZA75	100		795	795	D34X4	D34X4		0		F01	
F022T399ZA75	100	3	795	795	D34X4	D34X4	123	79	1/22+2/24	F01	
F022T351ZA75	100	2	990	900	D34X4	D34X4	145	70	2/32	F01	

achter-arrière-rear-Hinten

F022T348ZA75	100	5	840	945	D36X3	--	160	135	5/24	F03.07	
F022T374ZA75	100	5	840	949	D36X3	--		135	5/24	F03.07	

FM 7 8 X 4**voor-avant-front-Vorne**

F022T397ZA75	100		795	795	D34X4	D34X4		0		F01	
F022T399ZA75	100	3	795	795	D34X4	D34X4	123	79	1/22+2/24	F01	
F022T351ZA75	100	2	990	900	D34X4	D34X4	145	70	2/32	F01	

achter-arrière-rear-Hinten

A022T410ZA70	90	9	0	0	--	--		0		A08R.01	
A022T408ZA70	90	11	0	0	--	--		0		A08R.01	
F022T354ZA70	75	4	820	820	--	--	90		4/32	F08R	
F022T346ZA70	75	2/1	812	812	--	--	59		2/45+1/68	F08RB	
F022T346ZA85	75	2	812	812	--	--			2/45	F	
F022T384ZA70	75	2/1	815	815	--	--	73	147	2/43+1/55	F08RB	

BESTELNR N° COMMANDE ORDER NR BESTELNR	BR LRG WID BR	BLADEN LAMES LEAVES BLATT.	B	C	D1	D2	PH FL FA SP	PAK EP TH PAK	DETAIL	MOD	OPMERKINGEN REMARQUES REMARKS BEMERKUNGEN
---	------------------------	-------------------------------------	---	---	----	----	----------------------	------------------------	--------	-----	--

SERIE : FM10**FM10 4 X 2****voor-avant-front-Vorne**

A022T367ZA75	100	6	990	900	D34X4	D34X4	230	90	6/15	A01	
F022T339ZA75	100	2	990	900	D34X4	D34X4	140	63	1/28+1/30	F01	glijdop/pastille
F022T361ZA75	100	2	990	900	D34X4	D34X4				F01	

achter-arrière-rear-Hinten

F022T388ZA75	0		0	0				0		Z	
A022T380ZA75	0	15	0	0				212	1/16+14/14	Z	

Truck - Porteur - Rigid**voor-avant-front-Vorne**

F022T341ZA75	100	2	990	900	D34X4	D34X4	132	65	2/30	F01	
--------------	-----	---	-----	-----	-------	-------	-----	----	------	-----	--

achter-arrière-rear-Hinten

F022T364ZA75	90	3	905	970	S26	--		124	2/35+1/45	F03A.14	
--------------	----	---	-----	-----	-----	----	--	-----	-----------	---------	--

Trekker - Tracteur - Tractor**voor-avant-front-Vorne**

F022T353ZA75	100	2	990	900	D34X4	D34X4	135	65	2/30	F01	glijdop/pastille
F022T343ZA75	100	2	990	900	D34X4	D34X4	117	70	2/32	F01	

achter-arrière-rear-Hinten

F022T366ZA75	90	3	905	970	S26	--		114	3/35	F03.14	
--------------	----	---	-----	-----	-----	----	--	-----	------	--------	--

BESTELNR N° COMMANDE ORDER NR BESTELNR	BR LRG WID BR	BLADEN LAMES LEAVES BLATT.	B	C	D1	D2	PH FL FA SP	PAK EP TH PAK	DETAIL	MOD	OPMERKINGEN REMARQUES REMARKS BEMERKUNGEN
---	------------------------	-------------------------------------	---	---	----	----	----------------------	------------------------	--------	-----	--

SERIE : FM10**FM10 6 X 2****voor-avant-front-Vorne**

F022T339ZA75	100	2	990	900	D34X4	D34X4	140	63	1/28+1/30	F01	glijdop/pastille
F022T363ZA75	100	3	990	900	D34X4	D34X4	125	99	2/32+1/26	F01	

achter-arrière-rear-Hinten

F022T348ZA75	100	5	840	945	D36X3	--	160	135	5/24	F03.07	
F022T374ZA75	100	5	840	949	D36X3	--		135	5/24	F03.07	
F022T388ZA75	0		0	0				0		Z	

Truck - Porteur - Rigid**voor-avant-front-Vorne**

F022T341ZA75	100	2	990	900	D34X4	D34X4	132	65	2/30	F01	
--------------	-----	---	-----	-----	-------	-------	-----	----	------	-----	--

achter-arrière-rear-Hinten

F022T364ZA75	90	3	905	970	S26	--		124	2/35+1/45	F03A.14	
--------------	----	---	-----	-----	-----	----	--	-----	-----------	---------	--

Trekker - Tracteur - Tractor**voor-avant-front-Vorne**

F022T343ZA75	100	2	990	900	D34X4	D34X4	117	70	2/32	F01	
F022T353ZA75	100	2	990	900	D34X4	D34X4	135	65	2/30	F01	glijdop/pastille

achter-arrière-rear-Hinten

F022T366ZA75	90	3	905	970	S26	--		114	3/35	F03.14	
--------------	----	---	-----	-----	-----	----	--	-----	------	--------	--

BESTELNR N° COMMANDE ORDER NR BESTELNR	BR LRG WID BR	BLADEN LAMES LEAVES BLATT.	B	C	D1	D2	PH FL FA SP	PAK EP TH PAK	DETAIL	MOD	OPMERKINGEN REMARQUES REMARKS BEMERKUNGEN
---	------------------------	-------------------------------------	---	---	----	----	----------------------	------------------------	--------	-----	--

SERIE : FM10**FM10 6 X 4****voor-avant-front-Vorne**

A022T367ZA75	100	6	990	900	D34X4	D34X4	230	90	6/15	A01	
F022T395ZA75	100		0	0				0		F01	
F022T361ZA75	100	2	990	900	D34X4	D34X4				F01	
F022T339ZA75	100	2	990	900	D34X4	D34X4	140	63	1/28+1/30	F01	glijdop/pastille
F022T363ZA75	100	3	990	900	D34X4	D34X4	125	99	2/32+1/26	F01	

achter-arrière-rear-Hinten

A022T410ZA70	90	9	0	0	--	--		0		A08R.01	
A022T408ZA70	90	11	0	0	--	--		0		A08R.01	
F022T354ZA70	75	4	820	820	--	--	90		4/32	F08R	
F022T356ZA70	75	5	820	820	--	--	90		5/32	F08R	
F022T346ZA70	75	2/1	812	812	--	--	59		2/45+1/68	F08RB	
F022T346ZA85	75	2	812	812	--	--			2/45	F	
F022T384ZA70	75	2/1	815	815	--	--	73	147	2/43+1/55	F08RB	

Truck - Porteur - Rigid**voor-avant-front-Vorne**

F022T341ZA75	100	2	990	900	D34X4	D34X4	132	65	2/30	F01	
--------------	-----	---	-----	-----	-------	-------	-----	----	------	-----	--

Trekker - Tracteur - Tractor**voor-avant-front-Vorne**

F022T343ZA75	100	2	990	900	D34X4	D34X4	117	70	2/32	F01	
F022T353ZA75	100	2	990	900	D34X4	D34X4	135	65	2/30	F01	glijdop/pastille

BESTELNR N° COMMANDE ORDER NR BESTELLNR	BR LRG WID BR	BLADEN LAMES LEAVES BLATT.	B	C	D1	D2	PH FL FA SP	PAK EP TH PAK	DETAIL	MOD	OPMERKINGEN REMARKS BEMERKUNGEN
--	------------------------	-------------------------------------	---	---	----	----	----------------------	------------------------	--------	-----	---------------------------------------

SERIE : FM10**FM10 8 X 2****voor-avant-front-Vorne**

F022T397ZA75	100		795	795	D34X4	D34X4		0		F01	
F022T399ZA75	100	3	795	795	D34X4	D34X4	123	79	1/22+2/24	F01	
F022T351ZA75	100	2	990	900	D34X4	D34X4	145	70	2/32	F01	

achter-arrière-rear-Hinten

F022T348ZA75	100	5	840	945	D36X3	--	160	135	5/24	F03.07	
F022T374ZA75	100	5	840	949	D36X3	--		135	5/24	F03.07	

FM10 8 X 4**voor-avant-front-Vorne**

F022T397ZA75	100		795	795	D34X4	D34X4		0		F01	
F022T399ZA75	100	3	795	795	D34X4	D34X4	123	79	1/22+2/24	F01	
F022T351ZA75	100	2	990	900	D34X4	D34X4	145	70	2/32	F01	

achter-arrière-rear-Hinten

A022T410ZA70	90	9	0	0	--	--		0		A08R.01	
A022T408ZA70	90	11	0	0	--	--		0		A08R.01	
F022T354ZA70	75	4	820	820	--	--	90		4/32	F08R	
F022T346ZA70	75	2/1	812	812	--	--	59		2/45+1/68	F08RB	
F022T346ZA85	75	2	812	812	--	--			2/45	F	
F022T384ZA70	75	2/1	815	815	--	--	73	147	2/43+1/55	F08RB	

BESTELNR N° COMMANDE ORDER NR BESTELNR	BR LRG WID BR	BLADEN LAMES LEAVES BLATT.	B	C	D1	D2	PH FL FA SP	PAK EP TH PAK	DETAIL	MOD	OPMERKINGEN REMARQUES REMARKS BEMERKUNGEN
---	------------------------	-------------------------------------	---	---	----	----	----------------------	------------------------	--------	-----	--

SERIE : FM12**FM12 4 X 2****voor-avant-front-Vorne**

A022T367ZA75	100	6	990	900	D34X4	D34X4	230	90	6/15	A01	
F022T361ZA75	100	2	990	900	D34X4	D34X4				F01	
F022T339ZA75	100	2	990	900	D34X4	D34X4	140	63	1/28+1/30	F01	glijdop/pastille

achter-arrière-rear-Hinten

F022T388ZA75	0		0	0				0		Z	
A022T380ZA75	0	15	0	0				212	1/16+14/14	Z	

Truck - Porteur - Rigid**voor-avant-front-Vorne**

F022T341ZA75	100	2	990	900	D34X4	D34X4	132	65	2/30	F01	
--------------	-----	---	-----	-----	-------	-------	-----	----	------	-----	--

achter-arrière-rear-Hinten

F022T364ZA75	90	3	905	970	S26	--		124	2/35+1/45	F03A.14	
--------------	----	---	-----	-----	-----	----	--	-----	-----------	---------	--

Trekker - Tracteur - Tractor**voor-avant-front-Vorne**

F022T343ZA75	100	2	990	900	D34X4	D34X4	117	70	2/32	F01	
F022T353ZA75	100	2	990	900	D34X4	D34X4	135	65	2/30	F01	glijdop/pastille

achter-arrière-rear-Hinten

F022T366ZA75	90	3	905	970	S26	--		114	3/35	F03.14	
--------------	----	---	-----	-----	-----	----	--	-----	------	--------	--

BESTELNR N° COMMANDE ORDER NR BESTELNR	BR LRG WID BR	BLADEN LAMES LEAVES BLATT.	B	C	D1	D2	PH FL FA SP	PAK EP TH PAK	DETAIL	MOD	OPMERKINGEN REMARQUES REMARKS BEMERKUNGEN
---	------------------------	-------------------------------------	---	---	----	----	----------------------	------------------------	--------	-----	--

SERIE : FM12**FM12 6 X 2****voor-avant-front-Vorne**

F022T339ZA75	100	2	990	900	D34X4	D34X4	140	63	1/28+1/30	F01	glijdop/pastille
F022T363ZA75	100	3	990	900	D34X4	D34X4	125	99	2/32+1/26	F01	

achter-arrière-rear-Hinten

F022T348ZA75	100	5	840	945	D36X3	--	160	135	5/24	F03.07	
F022T374ZA75	100	5	840	949	D36X3	--		135	5/24	F03.07	
F022T388ZA75	0		0	0				0		Z	

Truck - Porteur - Rigid**voor-avant-front-Vorne**

F022T341ZA75	100	2	990	900	D34X4	D34X4	132	65	2/30	F01	
--------------	-----	---	-----	-----	-------	-------	-----	----	------	-----	--

achter-arrière-rear-Hinten

F022T364ZA75	90	3	905	970	S26	--		124	2/35+1/45	F03A.14	
--------------	----	---	-----	-----	-----	----	--	-----	-----------	---------	--

Trekker - Tracteur - Tractor**voor-avant-front-Vorne**

F022T343ZA75	100	2	990	900	D34X4	D34X4	117	70	2/32	F01	
F022T353ZA75	100	2	990	900	D34X4	D34X4	135	65	2/30	F01	glijdop/pastille

achter-arrière-rear-Hinten

F022T366ZA75	90	3	905	970	S26	--		114	3/35	F03.14	
--------------	----	---	-----	-----	-----	----	--	-----	------	--------	--

BESTELNR N° COMMANDE ORDER NR BESTELNR	BR LRG WID BR	BLADEN LAMES LEAVES BLATT.	B	C	D1	D2	PH FL FA SP	PAK EP TH PAK	DETAIL	MOD	OPMERKINGEN REMARQUES REMARKS BEMERKUNGEN
---	------------------------	-------------------------------------	---	---	----	----	----------------------	------------------------	--------	-----	--

SERIE : FM12**FM12 6 X 4****voor-avant-front-Vorne**

A022T367ZA75	100	6	990	900	D34X4	D34X4	230	90	6/15	A01	
F022T395ZA75	100		0	0				0		F01	
F022T339ZA75	100	2	990	900	D34X4	D34X4	140	63	1/28+1/30	F01	glijdop/pastille
F022T361ZA75	100	2	990	900	D34X4	D34X4				F01	
F022T363ZA75	100	3	990	900	D34X4	D34X4	125	99	2/32+1/26	F01	

achter-arrière-rear-Hinten

A022T410ZA70	90	9	0	0	--	--		0		A08R.01	
A022T408ZA70	90	11	0	0	--	--		0		A08R.01	
F022T354ZA70	75	4	820	820	--	--	90		4/32	F08R	
F022T356ZA70	75	5	820	820	--	--	90		5/32	F08R	
F022T346ZA70	75	2/1	812	812	--	--	59		2/45+1/68	F08RB	
F022T346ZA85	75	2	812	812	--	--			2/45	F	
F022T384ZA70	75	2/1	815	815	--	--	73	147	2/43+1/55	F08RB	

Truck - Porteur - Rigid**voor-avant-front-Vorne**

F022T341ZA75	100	2	990	900	D34X4	D34X4	132	65	2/30	F01	
--------------	-----	---	-----	-----	-------	-------	-----	----	------	-----	--

Trekker - Tracteur - Tractor**voor-avant-front-Vorne**

F022T343ZA75	100	2	990	900	D34X4	D34X4	117	70	2/32	F01	
F022T353ZA75	100	2	990	900	D34X4	D34X4	135	65	2/30	F01	glijdop/pastille

BESTELNR N° COMMANDE ORDER NR BESTELLNR	BR LRG WID BR	BLADEN LAMES LEAVES BLATT.	B	C	D1	D2	PH FL FA SP	PAK EP TH PAK	DETAIL	MOD	OPMERKINGEN REMARKS BEMERKUNGEN
--	------------------------	-------------------------------------	---	---	----	----	----------------------	------------------------	--------	-----	---------------------------------------

SERIE : FM12**FM12 8 X 2****voor-avant-front-Vorne**

F022T397ZA75	100		795	795	D34X4	D34X4		0		F01	
F022T399ZA75	100	3	795	795	D34X4	D34X4	123	79	1/22+2/24	F01	
F022T351ZA75	100	2	990	900	D34X4	D34X4	145	70	2/32	F01	

achter-arrière-rear-Hinten

F022T348ZA75	100	5	840	945	D36X3	--	160	135	5/24	F03.07	
F022T374ZA75	100	5	840	949	D36X3	--		135	5/24	F03.07	

FM12 8 X 4**voor-avant-front-Vorne**

F022T397ZA75	100		795	795	D34X4	D34X4		0		F01	
F022T399ZA75	100	3	795	795	D34X4	D34X4	123	79	1/22+2/24	F01	
F022T351ZA75	100	2	990	900	D34X4	D34X4	145	70	2/32	F01	

achter-arrière-rear-Hinten

A022T410ZA70	90	9	0	0	--	--		0		A08R.01	
A022T408ZA70	90	11	0	0	--	--		0		A08R.01	
F022T354ZA70	75	4	820	820	--	--	90		4/32	F08R	
F022T346ZA70	75	2/1	812	812	--	--	59		2/45+1/68	F08RB	
F022T346ZA85	75	2	812	812	--	--			2/45	F	
F022T384ZA70	75	2/1	815	815	--	--	73	147	2/43+1/55	F08RB	

BESTELNR N° COMMANDE ORDER NR BESTELNR	BR LRG WID BR	BLADEN LAMES LEAVES BLATT.	B	C	D1	D2	PH FL FA SP	PAK EP TH PAK	DETAIL	MOD	OPMERKINGEN REMARQUES REMARKS BEMERKUNGEN
---	------------------------	-------------------------------------	---	---	----	----	----------------------	------------------------	--------	-----	--

SERIE : FS 7

FS7 4X2

Truck - Porteur - Rigid

voor-avant-front-Vorne

A022T369ZA75	100	5	900	900	D36	D36					A01	
A022T371ZA75	100	6	900	900	D36X3	D36X3	127	107	6/17		A01	
F022T335ZA75	100	2/P	900	900	D36X3	D36X3	145	106	2/30+P/40		F01	
F022T337ZA75	100	2	900	900	D36X3	D36X3	145	66	2/30		F01	
F022T375ZA75	100	2	900	900	D36X3	D36X3	157	60	2/27		F01	
F022T377ZA75	100	2	900	900	D36	D36					F01	
F022T379ZA75	100	2	900	900	D36	D36					F01	
F022T373ZA75	100	3	900	900	D36	D36			3/26		F01	

achter-arrière-rear-Hinten

	F022T362ZA75	80	5	650	725	D36X3	--	70	130	5/23		F03	
	F022T342ZA76	80	3/P/P/2	880	985	D36X3	--	155	188			F03A	glijdop/pastille
A	F022T342ZA75	80	3/P	880	985	D36X3	--	155	101	3/26+P/15		F03	glijdop/pastille
H	F022T342HA80	80	2/P	750	750	--	--	88	87	2/26+P/30		F08	
	F022T360ZA76	80	3/P/3	880	985	D36X3	--	155	187			F03A	glijdop/pastille
A	F022T360ZA75	80	3/P	880	985	D36X3	--	155	101	3/26+P/15		F03	glijdop/pastille
H	F022T360HA80	80	3	750	750	--	--		86	3/26		F08	

BESTELNR N° COMMANDE ORDER NR BESTELNR	BR LRG WID BR	BLADEN LAMES LEAVES BLATT.	B	C	D1	D2	PH FL FA SP	PAK EP TH PAK	DETAIL	MOD	OPMERKINGEN REMARQUES REMARKS BEMERKUNGEN
---	------------------------	-------------------------------------	---	---	----	----	----------------------	------------------------	--------	-----	--

SERIE : N 7

N7 4 X 2

voor-avant-front-Vorne

A022T257ZA75	100	10	935	820	D36X3	D36X3	155	130	10/13	A01	
A022T259ZA75	100	10	935	820	D36X3	D36X3	155	120	10/12	A01	
A022Z403ZA75	100	4/4P	935	1045	D36X3	--	180	118	2/18+2/19+4P/11	A03	
A022T227ZA75	100	9	940	1035	D36X3	--	170	126	9/14	A03	
A022T281ZA75	100	9	940	1035	D36X3	--	170	126	9/14	A03	
A022T277ZA75	100	10	930	1040	D36X3	--	215	120	10/12	A03t	
A022T279ZA75	100	10	930	1040	D36X3	--	215	120	10/12	A03t	
F022T221ZA75	100	3/P	935	1025	D36X3	--	155	90	3/23+P/12	F03	

achter-arrière-rear-Hinten

A	A022T206ZA76	90	11/P/9	750	750	D36X3	D36X3	145	227		A01A	
H	A022T206ZA75	90	11	750	750	D36X3	D36X3	145	134	2/13+9/12	A01	
H	A022T206HA80	90	9/P	560	560	--	--	90	93	9/9+P/12	A08	
A	A022T226ZA71	100	5/P/4	1000	1000	--	--	170	147		A08ttA	
H	A022T228ZA70	100	5/P	1000	1000	--	--	170	95	5/17+P/10	A08tt	
H	A022T226HA80	100	4	725	725	--	--	110	52	4/13	A08	
A	A022T228ZA71	100	5/P/6	1000	1000	--	--	170	181		A08ttA	
H	A022T228ZA70	100	5/P	1000	1000	--	--	170	95	5/17+P/10	A08tt	
H	A022T228HA80	100	6	725	725	--	--	55	86	2/15+4/14	A08	
A	A022Z404ZA71	100	5/P/P/6	1000	1000	--	--	170	204		A08ttA	
H	A022Z404ZA70	100	5/P/P	1000	1000	--	--	170	118		A08tt	
H	A022T228HA80	100	6	725	725	--	--	55	86	2/15+4/14	A08	
A	A022T298ZA71	100	14/P/11	1025	1025	--	--	275	260		A08ttA	
H	A022T298ZA70	100	14/P	1025	1025	--	--	275	150	14/10+P/10	A08tt	
H	A022T298HA80	100	11	725	725	--	--	110	110	11/10	A08	
	A022T228ZB75	100	1	885	120	P32	--	0	17	1/17	A54	
	A022T228ZC75	100	2	885	120	P32	--	0	25	1/14+1/11	A54	

BESTELNR N° COMMANDE ORDER NR BESTELNR	BR LRG WID BR	BLADEN LAMES LEAVES BLATT.	B	C	D1	D2	PH FL FA SP	PAK EP TH PAK	DETAIL	MOD	OPMERKINGEN REMARQUES REMARKS BEMERKUNGEN
---	------------------------	-------------------------------------	---	---	----	----	----------------------	------------------------	--------	-----	--

SERIE : N 7**N7 6 X 2****voor-avant-front-Vorne**

A022T257ZA75	100	10	935	820	D36X3	D36X3	155	130	10/13	A01	
A022T259ZA75	100	10	935	820	D36X3	D36X3	155	120	10/12	A01	
A022Z403ZA75	100	4/4P	935	1045	D36X3	--	180	118	2/18+2/19+4P/11	A03	
A022T281ZA75	100	9	940	1035	D36X3	--	170	126	9/14	A03	
A022T227ZA75	100	9	940	1035	D36X3	--	170	126	9/14	A03	
A022T279ZA75	100	10	930	1040	D36X3	--	215	120	10/12	A03t	
A022T277ZA75	100	10	930	1040	D36X3	--	215	120	10/12	A03t	
F022T221ZA75	100	3/P	935	1025	D36X3	--	155	90	3/23+P/12	F03	

achter-arrière-rear-Hinten

A022T212ZB75											
A022T212ZA75	100	7	845	930	D36X3	--	110	119	7/17	A03.07	
A022T212ZC75	100	8	845	930	D36X3	--	110	136	8/17	A03.07	
A022T212ZD75	100	9	845	930	D36X3	--	100	153	9/17	A03.07	
F022T216ZA75	100	5	840	920	D36X3	--	160	125	5/22	F03.07	

N7 6 X 4**voor-avant-front-Vorne**

A022T257ZA75	100	10	935	820	D36X3	D36X3	155	130	10/13	A01	
A022T259ZA75	100	10	935	820	D36X3	D36X3	155	120	10/12	A01	
A022Z403ZA75	100	4/4P	935	1045	D36X3	--	180	118	2/18+2/19+4P/11	A03	
A022T281ZA75	100	9	940	1035	D36X3	--	170	126	9/14	A03	
A022T227ZA75	100	9	940	1035	D36X3	--	170	126	9/14	A03	
A022T277ZA75	100	10	930	1040	D36X3	--	215	120	10/12	A03t	
A022T279ZA75	100	10	930	1040	D36X3	--	215	120	10/12	A03t	
F022T221ZA75	100	3/P	935	1025	D36X3	--	155	90	3/23+P/12	F03	

achter-arrière-rear-Hinten

A022T230ZA70	100	10	0	0	--	--		110	10/11	A08R	tandem
--------------	-----	----	---	---	----	----	--	-----	-------	------	--------

BESTELNR N° COMMANDE ORDER NR BESTELNR	BR LRG WID BR	BLADEN LAMES LEAVES BLATT.	B	C	D1	D2	PH FL FA SP	PAK EP TH PAK	DETAIL	MOD	OPMERKINGEN REMARQUES REMARKS BEMERKUNGEN
---	------------------------	-------------------------------------	---	---	----	----	----------------------	------------------------	--------	-----	--

SERIE : N10**N10 4 X 2****voor-avant-front-Vorne**

A022T259ZA75	100	10	935	820	D36X3	D36X3	155	120	10/12	A01	
A022T257ZA75	100	10	935	820	D36X3	D36X3	155	130	10/13	A01	
A022Z403ZA75	100	4/4P	935	1045	D36X3	--	180	118	2/18+2/19+4P/11	A03	
A022T227ZA75	100	9	940	1035	D36X3	--	170	126	9/14	A03	
A022T281ZA75	100	9	940	1035	D36X3	--	170	126	9/14	A03	
A022T277ZA75	100	10	930	1040	D36X3	--	215	120	10/12	A03t	
A022T279ZA75	100	10	930	1040	D36X3	--	215	120	10/12	A03t	
F022T315ZA75	100	2/P	935	815	D36X3	D36X3	155	75	2/27+P/12	F01	glijdop/pastille
F022T289ZA75	100	3	935	815	D36X3	D36X3	145	87	3/25	F01	
F022T249ZA75	100	3/P	935	815	D36X3	D36X3	170	87	3/22+P/13	F01	glijdop/pastille
F022T267ZA75	100	3	935	815	D36X3	D36X3	165	87	3/26	F01	

achter-arrière-rear-Hinten

A022T206ZA76	90	11/P/9	750	750	D36X3	D36X3	145	227		A01A	
A022T206ZA75	90	11	750	750	D36X3	D36X3	145	134	2/13+9/12	A01	
A022T206HA80	90	9/P	560	560	--	--	90	93	9/9+P/12	A08	
A022T300ZA70	100	11	828	828	--	--	65	154	11/14	A08tt	
A022T226ZA71	100	5/P/4	1000	1000	--	--	170	147		A08ttA	
A022T228ZA70	100	5/P	1000	1000	--	--	170	95	5/17+P/10	A08tt	
A022T226HA80	100	4	725	725	--	--	110	52	4/13	A08	
A022T228ZA71	100	5/P/6	1000	1000	--	--	170	181		A08ttA	
A022T228ZA70	100	5/P	1000	1000	--	--	170	95	5/17+P/10	A08tt	
A022T228HA80	100	6	725	725	--	--	55	86	2/15+4/14	A08	
A022Z404ZA71	100	5/P/P/6	1000	1000	--	--	170	204		A08ttA	
A022Z404ZA70	100	5/P/P	1000	1000	--	--	170	118		A08tt	
A022T228HA80	100	6	725	725	--	--	55	86	2/15+4/14	A08	
A022T298ZA71	100	14/P/11	1025	1025	--	--	275	260		A08ttA	
A022T298ZA70	100	14/P	1025	1025	--	--	275	150	14/10+P/10	A08tt	
A022T298HA80	100	11	725	725	--	--	110	110	11/10	A08	
A022T228ZB75	100	1	885	120	P32	--	0	17	1/17	A54	
A022T228ZC75	100	2	885	120	P32	--	0	25	1/14+1/11	A54	

BESTELNR N° COMMANDE ORDER NR BESTELNR	BR LRG WID BR	BLADEN LAMES LEAVES BLATT.	B	C	D1	D2	PH FL FA SP	PAK EP TH PAK	DETAIL	MOD	OPMERKINGEN REMARKS REMARKS BEMERKUNGEN
---	------------------------	-------------------------------------	---	---	----	----	----------------------	------------------------	--------	-----	--

SERIE : N10**N10 6 X 2****voor-avant-front-Vorne**

A022T259ZA75	100	10	935	820	D36X3	D36X3	155	120	10/12	A01	
A022T257ZA75	100	10	935	820	D36X3	D36X3	155	130	10/13	A01	
A022Z403ZA75	100	4/4P	935	1045	D36X3	--	180	118	2/18+2/19+4P/11	A03	
A022T227ZA75	100	9	940	1035	D36X3	--	170	126	9/14	A03	
A022T281ZA75	100	9	940	1035	D36X3	--	170	126	9/14	A03	
A022T277ZA75	100	10	930	1040	D36X3	--	215	120	10/12	A03t	
A022T279ZA75	100	10	930	1040	D36X3	--	215	120	10/12	A03t	
F022T315ZA75	100	2/P	935	815	D36X3	D36X3	155	75	2/27+P/12	F01	glijdop/pastille
F022T267ZA75	100	3	935	815	D36X3	D36X3	165	87	3/26	F01	
F022T249ZA75	100	3/P	935	815	D36X3	D36X3	170	87	3/22+P/13	F01	glijdop/pastille
F022T289ZA75	100	3	935	815	D36X3	D36X3	145	87	3/25	F01	

achter-arrière-rear-Hinten

A022T212ZB75											
A022T212ZA75	100	7	845	930	D36X3	--	110	119	7/17	A03.07	
A022T212ZC75	100	8	845	930	D36X3	--	110	136	8/17	A03.07	
A022T212ZD75	100	9	845	930	D36X3	--	100	153	9/17	A03.07	
F022T316ZA75	100	3	840	920	D36X3	--	145	99	3/30	F03.07	
F022T216ZA75	100	5	840	920	D36X3	--	160	125	5/22	F03.07	

BESTELNR N° COMMANDE ORDER NR BESTELNR	BR LRG WID BR	BLADEN LAMES LEAVES BLATT.	B	C	D1	D2	PH FL FA SP	PAK EP TH PAK	DETAIL	MOD	OPMERKINGEN REMARKS REMARKS BEMERKUNGEN
---	------------------------	-------------------------------------	---	---	----	----	----------------------	------------------------	--------	-----	--

SERIE : N10**N10 6 X 4****voor-avant-front-Vorne**

A022T259ZA75	100	10	935	820	D36X3	D36X3	155	120	10/12	A01	
A022T257ZA75	100	10	935	820	D36X3	D36X3	155	130	10/13	A01	
A022Z403ZA75	100	4/4P	935	1045	D36X3	--	180	118	2/18+2/19+4P/11	A03	
A022T227ZA75	100	9	940	1035	D36X3	--	170	126	9/14	A03	
A022T281ZA75	100	9	940	1035	D36X3	--	170	126	9/14	A03	
A022T279ZA75	100	10	930	1040	D36X3	--	215	120	10/12	A03t	
A022T277ZA75	100	10	930	1040	D36X3	--	215	120	10/12	A03t	
F022T315ZA75	100	2/P	935	815	D36X3	D36X3	155	75	2/27+P/12	F01	glijdop/pastille
F022T249ZA75	100	3/P	935	815	D36X3	D36X3	170	87	3/22+P/13	F01	glijdop/pastille
F022T267ZA75	100	3	935	815	D36X3	D36X3	165	87	3/26	F01	
F022T289ZA75	100	3	935	815	D36X3	D36X3	145	87	3/25	F01	

achter-arrière-rear-Hinten

A022T262ZA70	90	8	752	752	--	--	55	192	8/24	A08R	
A022T236ZA70	90	8	775	775	--	--	55	192	8/24	A08R	
A022T320ZA70	90	8	778	778	--	--	50	192	8/24	A08R	
A022T322ZA70	90	8	790	790	--	--	55	192	8/24	A08R	
A022T284ZA70	90	9	790	790	--	--	55	234	9/26	A08R	YC022C400204
A022T248ZA70	90	9	790	790	--	--	55	234	9/26	A08R	
A022T264ZA70	90	9	790	790	--	--	55	234	9/26	A08R	
A022T230ZA70	100	10	0	0	--	--		110	10/11	A08R	tandem
F022T246ZA70	90	2/P	780	780	--	--	43	132	2/54+P/18	F08R	
F022T326ZA70	90	2/P	795	795	--	--	31	126	2/52+P/16	F08R	YC022C400204

BESTELNR N° COMMANDE ORDER NR BESTELNR	BR LRG WID BR	BLADEN LAMES LEAVES BLATT.	B	C	D1	D2	PH FL FA SP	PAK EP TH PAK	DETAIL	MOD	OPMERKINGEN REMARQUES REMARKS BEMERKUNGEN
---	------------------------	-------------------------------------	---	---	----	----	----------------------	------------------------	--------	-----	--

SERIE : N12

N12 4 X 2

voor-avant-front-Vorne

A022T259ZA75	100	10	935	820	D36X3	D36X3	155	120	10/12	A01	
A022T257ZA75	100	10	935	820	D36X3	D36X3	155	130	10/13	A01	
A022Z403ZA75	100	4/4P	935	1045	D36X3	--	180	118	2/18+2/19+4P/11	A03	
A022T281ZA75	100	9	940	1035	D36X3	--	170	126	9/14	A03	
A022T227ZA75	100	9	940	1035	D36X3	--	170	126	9/14	A03	
A022T279ZA75	100	10	930	1040	D36X3	--	215	120	10/12	A03t	
A022T277ZA75	100	10	930	1040	D36X3	--	215	120	10/12	A03t	
F022T315ZA75	100	2/P	935	815	D36X3	D36X3	155	75	2/27+P/12	F01	glijdop/pastille
F022T267ZA75	100	3	935	815	D36X3	D36X3	165	87	3/26	F01	
F022T289ZA75	100	3	935	815	D36X3	D36X3	145	87	3/25	F01	
F022T249ZA75	100	3/P	935	815	D36X3	D36X3	170	87	3/22+P/13	F01	glijdop/pastille
F022T221ZA75	100	3/P	935	1025	D36X3	--	155	90	3/23+P/12	F03	

achter-arrière-rear-Hinten

A022T300ZA70	100	11	828	828	--	--	65	154	11/14	A08tt	
A022T226ZA71	100	5/P/4	1000	1000	--	--	170	147		A08ttA	
A022T228ZA70	100	5/P	1000	1000	--	--	170	95	5/17+P/10	A08tt	
A022T226HA80	100	4	725	725	--	--	110	52	4/13	A08	
A022T228ZA71	100	5/P/6	1000	1000	--	--	170	181		A08ttA	
A022T228ZA70	100	5/P	1000	1000	--	--	170	95	5/17+P/10	A08tt	
A022T228HA80	100	6	725	725	--	--	55	86	2/15+4/14	A08	
A022Z404ZA71	100	5/P/P/6	1000	1000	--	--	170	204		A08ttA	
A022Z404ZA70	100	5/P/P	1000	1000	--	--	170	118		A08tt	
A022T228HA80	100	6	725	725	--	--	55	86	2/15+4/14	A08	
A022T298ZA71	100	14/P/11	1025	1025	--	--	275	260		A08ttA	
A022T298ZA70	100	14/P	1025	1025	--	--	275	150	14/10+P/10	A08tt	
A022T298HA80	100	11	725	725	--	--	110	110	11/10	A08	
A022T228ZB75	100	1	885	120	P32	--	0	17	1/17	A54	
A022T228ZC75	100	2	885	120	P32	--	0	25	1/14+1/11	A54	

BESTELNR N° COMMANDE ORDER NR BESTELNR	BR LRG WID BR	BLADEN LAMES LEAVES BLATT.	B	C	D1	D2	PH FL FA SP	PAK EP TH PAK	DETAIL	MOD	OPMERKINGEN REMARKS REMARKS BEMERKUNGEN
---	------------------------	-------------------------------------	---	---	----	----	----------------------	------------------------	--------	-----	--

SERIE : N12

N12 6 X 2

voor-avant-front-Vorne

A022T257ZA75	100	10	935	820	D36X3	D36X3	155	130	10/13	A01	
A022T259ZA75	100	10	935	820	D36X3	D36X3	155	120	10/12	A01	
A022Z403ZA75	100	4/4P	935	1045	D36X3	--	180	118	2/18+2/19+4P/11	A03	
A022T281ZA75	100	9	940	1035	D36X3	--	170	126	9/14	A03	
A022T227ZA75	100	9	940	1035	D36X3	--	170	126	9/14	A03	
A022T279ZA75	100	10	930	1040	D36X3	--	215	120	10/12	A03t	
A022T277ZA75	100	10	930	1040	D36X3	--	215	120	10/12	A03t	
F022T315ZA75	100	2/P	935	815	D36X3	D36X3	155	75	2/27+P/12	F01	glijdop/pastille
F022T289ZA75	100	3	935	815	D36X3	D36X3	145	87	3/25	F01	
F022T267ZA75	100	3	935	815	D36X3	D36X3	165	87	3/26	F01	
F022T249ZA75	100	3/P	935	815	D36X3	D36X3	170	87	3/22+P/13	F01	glijdop/pastille
F022T221ZA75	100	3/P	935	1025	D36X3	--	155	90	3/23+P/12	F03	

achter-arrière-rear-Hinten

A022T212ZB75											
A022T212ZA75	100	7	845	930	D36X3	--	110	119	7/17	A03.07	
A022T212ZC75	100	8	845	930	D36X3	--	110	136	8/17	A03.07	
A022T212ZD75	100	9	845	930	D36X3	--	100	153	9/17	A03.07	
F022T316ZA75	100	3	840	920	D36X3	--	145	99	3/30	F03.07	
F022T216ZA75	100	5	840	920	D36X3	--	160	125	5/22	F03.07	
F022T216ZA76	100	6	840	920	D36	--	160	150	6/22	F03.07	
F022T216ZA75	100	5	840	920	D36X3	--	160	125	5/22	F03.07	
H F022T216HA80	100	1	865	920	--	--	235	22	1/22	F08	

BESTELNR N° COMMANDE ORDER NR BESTELNR	BR LRG WID BR	BLADEN LAMES LEAVES BLATT.	B	C	D1	D2	PH FL FA SP	PAK EP TH PAK	DETAIL	MOD	OPMERKINGEN REMARQUES REMARKS BEMERKUNGEN
---	------------------------	-------------------------------------	---	---	----	----	----------------------	------------------------	--------	-----	--

SERIE : N12

N12 6 X 4

voor-avant-front-Vorne

A022T259ZA75	100	10	935	820	D36X3	D36X3	155	120	10/12	A01	
A022T257ZA75	100	10	935	820	D36X3	D36X3	155	130	10/13	A01	
A022Z403ZA75	100	4/4P	935	1045	D36X3	--	180	118	2/18+2/19+4P/11	A03	
A022T281ZA75	100	9	940	1035	D36X3	--	170	126	9/14	A03	
A022T227ZA75	100	9	940	1035	D36X3	--	170	126	9/14	A03	
A022T277ZA75	100	10	930	1040	D36X3	--	215	120	10/12	A03t	
A022T279ZA75	100	10	930	1040	D36X3	--	215	120	10/12	A03t	
F022T315ZA75	100	2/P	935	815	D36X3	D36X3	155	75	2/27+P/12	F01	glijdop/pastille
F022T249ZA75	100	3/P	935	815	D36X3	D36X3	170	87	3/22+P/13	F01	glijdop/pastille
F022T267ZA75	100	3	935	815	D36X3	D36X3	165	87	3/26	F01	
F022T289ZA75	100	3	935	815	D36X3	D36X3	145	87	3/25	F01	
F022T221ZA75	100	3/P	935	1025	D36X3	--	155	90	3/23+P/12	F03	

achter-arrière-rear-Hinten

A022T262ZA70	90	8	752	752	--	--	55	192	8/24	A08R	
A022T236ZA70	90	8	775	775	--	--	55	192	8/24	A08R	
A022T320ZA70	90	8	778	778	--	--	50	192	8/24	A08R	
A022T322ZA70	90	8	790	790	--	--	55	192	8/24	A08R	
A022T284ZA70	90	9	790	790	--	--	55	234	9/26	A08R	YC022C400204
A022T264ZA70	90	9	790	790	--	--	55	234	9/26	A08R	
A022T248ZA70	90	9	790	790	--	--	55	234	9/26	A08R	
A022T230ZA70	100	10	0	0	--	--		110	10/11	A08R	tandem
F022T246ZA70	90	2/P	780	780	--	--	43	132	2/54+P/18	F08R	
F022T326ZA70	90	2/P	795	795	--	--	31	126	2/52+P/16	F08R	YC022C400204

DIAM	DR	BESTELNUMMER N° DE CDE ORDER NUMBER BESTELNR	B(1)	B(2)	L(1)	L(2)	HD(1)	HD(2)	PL	OPMERKINGEN REMARKS BEMERKUNGEN
------	----	---	------	------	------	------	-------	-------	----	---------------------------------------

VOLVO

Vorm* : B01

(*) Vorm : Forme/Schape/Form

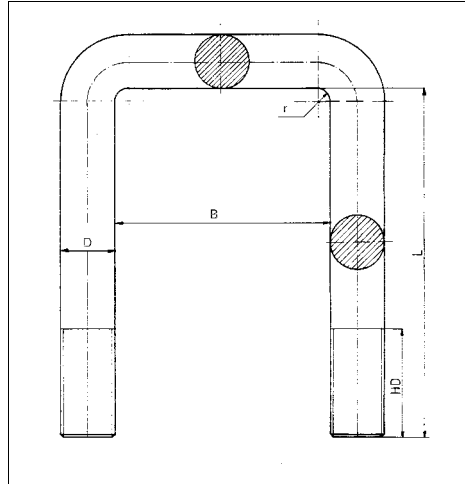

16.0	M16*2	B022M16A003	72		130		50			B022M16A012
	M16*2	B022M16A013	72		138		50			B022M16A012
	M16*2	B022M16A004	72		145		50			B022M16A012
	M16*2	B022M16A006	72		150		60			B022M16A012
	M16*2	B022M16A007	72		160		60			B022M16A012
	M16*2	B022M16A005	72		170		50			B022M16A012
	M16*2	B022M16A008	72		185		60			B022M16A012
	M16*2	B022M16A012	72		185		110			
	M16*2	B022M16A009	72		295		60			B061M16A052
16.0	M16*2	B022M16A014	78		140		50			
	M16*2	B022M16A015	78		145		50			
	M16*2	B022M16A016	78		160		50			
16.0	M16*2	B022M16A017	79		170		50			
	M16*2	B022M16A018	79		195		50			
16.0	M16*2	B022M16A010	86		105		40			
16.0	M16*2	B022M16A011	90		100		30			

DIAM	DR	BESTELNUMMER N° DE CDE ORDER NUMBER BESTELLNR	B(1)	B(2)	L(1)	L(2)	HD(1)	HD(2)	PL	OPMERKINGEN REMARKS REMARKS BEMERKUNGEN
------	----	--	------	------	------	------	-------	-------	----	--

VOLVO

Vorm* : B01

(*) Vorm : Forme/Schape/Form

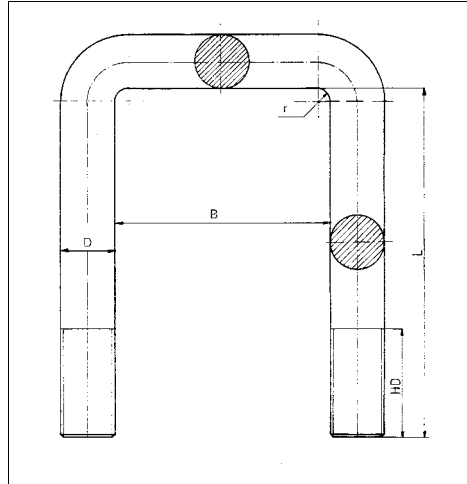

18.0	M18*2.5	B022M18A010	72		320		60			B022M18A022
	M18*2.5	B022M18A011	72		330		60			B022M18A022
	M18*2.5	B022M18A012	72		345		60			B022M18A022
	M18*2.5	B022M18A022	72		360		100			
	M18*2.5	B022M18A013	72		360		60			B022M18A022
18.0	M18*2.5	B022M18A014	82		120		50			B022M18A023
	M18*2.5	B022M18A015	82		130		50			B022M18A023
	M18*2.5	B022M18A016	82		140		50			B022M18A023
	M18*2.5	B022M18A017	82		150		50			B022M18A023
	M18*2.5	B022M18A018	82		165		50			B022M18A023
	M18*2.5	B022M18A023	82		165		95			
	M18*2.5	B022M18A040	82		180		70			B022M18A024
	M18*2.5	B022M18A019	82		200		70			B022M18A024
	M18*2.5	B022M18A038	82		210		75			B022M18A024
	M18*2.5	B022M18A024	82		220		100			
	M18*2.5	B022M18A021	82		220		70			B022M18A024

DIAM	DR	BESTELNUMMER N° DE CDE ORDER NUMBER BESTELLNR	B(1)	B(2)	L(1)	L(2)	HD(1)	HD(2)	PL	OPMERKINGEN REMARKS REMARKS BEMERKUNGEN
------	----	--	------	------	------	------	-------	-------	----	--

VOLVO

Vorm* : B01

(*) Vorm : Forme/Schape/Form

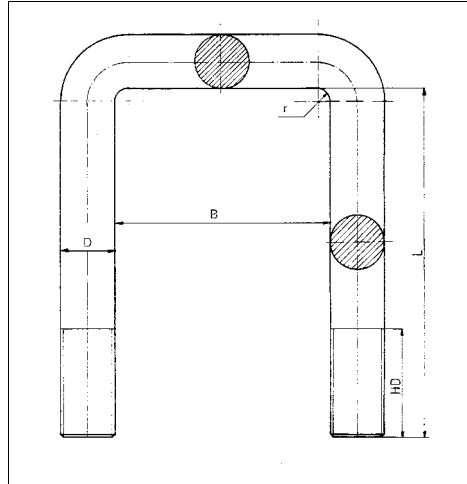

20.0	M20*2.5	B022M20A019	102		140		50			
	M20*2.5	B022M20A058	102		155		70			B022M20A069
	M20*2.5	B022M20A059	102		175		70			B022M20A069
	M20*2.5	B022M20A076	102		185		70			B022M20A069
	M20*2.5	B022M20A060	102		195		70			B022M20A069
	M20*2.5	B022M20A061	102		200		70			B022M20A069
	M20*2.5	B022M20A062	102		210		70			B022M20A069
	M20*2.5	B022M20A069	102		210		90			
	M20*2.5	B022M20A063	102		215		70			B022M20A070
	M20*2.5	B022M20A080	102		220		70			
	M20*2.5	B022M20A064	102		225		70			B022M20A070
	M20*2.5	B022M20A065	102		235		70			B022M20A070
	M20*2.5	B022M20A066	102		240		70			B022M20A070
	M20*2.5	B022M20A067	102		255		70			B022M20A070
	M20*2.5	B022M20A068	102		260		70			B022M20A070
	M20*2.5	B022M20A070	102		260		120			

DIAM	DR	BESTELNUMMER N° DE CDE ORDER NUMBER BESTELLNr	B(1)	B(2)	L(1)	L(2)	HD(1)	HD(2)	PL	OPMERKINGEN REMARQUES REMARKS BEMERKUNGEN
------	----	--	------	------	------	------	-------	-------	----	--

VOLVO

Vorm* : B01

(*) Vorm : Forme/Schape/Form

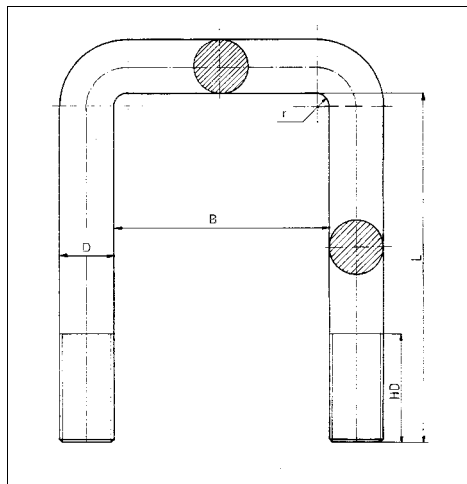

20.0	M20*2.5	B022M20B083	102		280		70			B011M20A020
	M20*2.5	B022M20A079	102		285		70			

DIAM	DR	BESTELNUMMER N° DE CDE ORDER NUMBER BESTELLNR	B(1)	B(2)	L(1)	L(2)	HD(1)	HD(2)	PL	OPMERKINGEN REMARQUES REMARKS BEMERKUNGEN
------	----	--	------	------	------	------	-------	-------	----	--

VOLVO

Vorm* : B03

(*) *Vorm : Forme/Schape/Form*

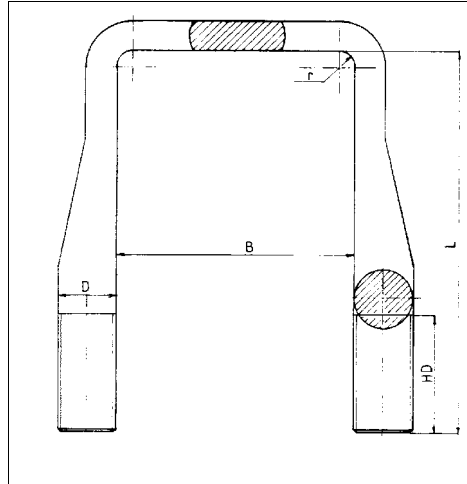

24.0	M24*3	B022M24B584	104		215		60			
------	-------	-------------	-----	--	-----	--	----	--	--	--

DIAM	DR	BESTELNUMMER N° DE CDE ORDER NUMBER BESTELLNR	B(1)	B(2)	L(1)	L(2)	HD(1)	HD(2)	PL	OPMERKINGEN REMARKS BEMERKUNGEN
------	----	--	------	------	------	------	-------	-------	----	---------------------------------------

VOLVO

Vorm* : B03S

(*) Vorm : Forme/Schape/Form

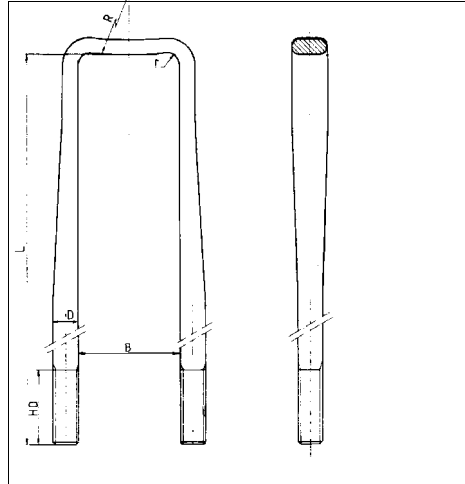

20.0	M20*2.5	B022M20B028	82		275		60		45	
	M20*2.5	B022M20B029	82		290		60		45	
	M20*2.5	B022M20B030	82		315		60		45	
	M20*2.5	B022M20B031	82		330		60		45	
	M20*2.5	B022M20B032	82		360		60		45	B022M20B013
	M20*2.5	B022M20B033	82		370		60		45	B022M20B013
	M20*2.5	B022M20B034	82		385		60		45	B022M20B013
	M20*2.5	B022M20B013	82		405		105		45	
	M20*2.5	B022M20B035	82		405		60		45	B022M20B013
	M20*2.5	B022M20B036	82		420		60		45	
	M20*2.5	B022M20B041	82		420		105		45	
	M20*2.5	B022M20B037	82		430		60		45	
	M20*2.5	B022M20B038	82		440		60		45	
	M20*2.5	B022M20B039	82		450		60		45	
	M20*2.5	B022M20B040	82		460		60		45	
24.0	M24*3	B022M24B572	82		360		60		45	B022M24B585

DIAM	DR	BESTELNUMMER N° DE CDE ORDER NUMBER BESTELLNR	B(1)	B(2)	L(1)	L(2)	HD(1)	HD(2)	PL	OPMERKINGEN REMARQUES REMARKS BEMERKUNGEN
------	----	--	------	------	------	------	-------	-------	----	--

VOLVO

Vorm* : B03S

(*) Vorm : Forme/Schape/Form

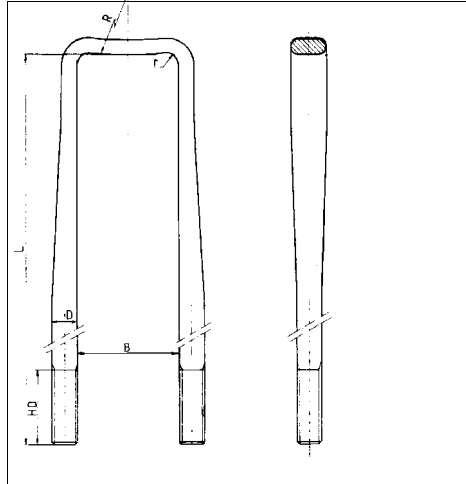

24.0	M24*3	B022M24B573	82		380		60		45	B022M24B585
	M24*3	B022M24B574	82		400		60		45	B022M24B585
	M24*3	B022M24B575	82		410		60		45	B022M24B585
	M24*3	B022M24B576	82		430		60		45	B022M24B585
	M24*3	B022M24B577	82		460		60		45	B022M24B585
	M24*3	B022M24B585	82		460		160		45	
24.0	M24*3	B022M24B550	102		350		60		45	B022M24B578
	M24*3	B022M24B551	102		380		60		45	B022M24B578
	M24*3	B022M24B552	102		390		60		45	B022M24B578
	M24*3	B022M24B578	102		400		110		45	
	M24*3	B022M24B553	102		400		60		45	B022M24B578
	M24*3	B022M24B554	102		420		60		45	B022M24B579
	M24*3	B022M24B555	102		430		60		45	B022M24B579
	M24*3	B022M24B556	102		450		60		45	B022M24B579
	M24*3	B022M24B579	102		450		110		45	
	M24*3	B022M24B557	102		460		60		45	B022M24B580
	M24*3	B022M24B558	102		470		60		45	B022M24B580

DIAM	DR	BESTELNUMMER N° DE CDE ORDER NUMBER BESTELNR	B(1)	B(2)	L(1)	L(2)	HD(1)	HD(2)	PL	OPMERKINGEN REMARQUES REMARKS BEMERKUNGEN
------	----	---	------	------	------	------	-------	-------	----	--

VOLVO

Vorm* : B03S

(*) Vorm : Forme/Schape/Form

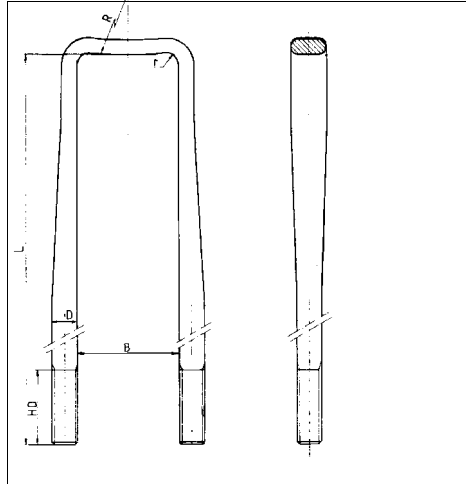

24.0	M24*3	B022M24B559	102		480		60		45	B022M24B580
	M24*3	B022M24B560	102		500		60		45	B022M24B580
	M24*3	B022M24B561	102		510		60		45	B022M24B580
	M24*3	B022M24B580	102		510		120		45	
	M24*3	B022M24B562	102		520		60		45	B022M24B581
	M24*3	B022M24B563	102		530		60		45	B022M24B581
	M24*3	B022M24B534	102		540		120		45	B022M24B581
	M24*3	B022M24B564	102		570		60		45	B022M24B581
	M24*3	B022M24B565	102		580		60		45	B022M24B581
	M24*3	B022M24B583	102		580		250		45	
	M24*3	B022M24B581	102		580		120		45	
24.0	M24*3	B022M24B571	150		380		60		45	

DIAM	DR	BESTELNUMMER N° DE CDE ORDER NUMBER BESTELNR	B(1)	B(2)	L(1)	L(2)	HD(1)	HD(2)	PL	OPMERKINGEN REMARQUES REMARKS BEMERKUNGEN
------	----	---	------	------	------	------	-------	-------	----	--

VOLVO

Vorm* : B10

(*) Vorm : Forme/Schape/Form

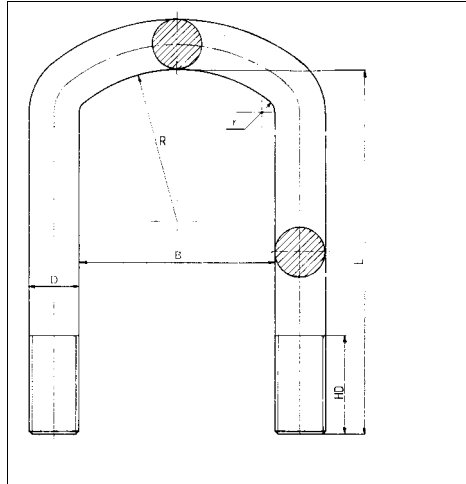

18.0	M18*1.5	B022M18A033	78	170	55					
	M18*1.5	B022M18A041	78	180	55					
	M18*1.5	B022M18A042	78	190	55					
	M18*1.5	B022M18A036	78	200	55					
	M18*1.5	B022M18A037	78	210	55					
	M18*1.5	B022M18A026	78	220	55					
	M18*1.5	B022M18A007	78	225	90					
	M18*1.5	B022M18A043	78	250	55					
	M18*1.5	B022M18A044	78	270	55					
	M18*1.5	B022M18A045	78	280	55					
	M18*1.5	B022M18A046	78	290	55					
	M18*1.5	B022M18A047	78	340	55					
	M18*1.5	B022M18A048	78	360	55					
	M18*1.5	B022M18A049	78	380	55					
	M18*1.5	B022M18A050	78	390	55					
	M18*1.5	B022M18A051	78	400	55					

DIAM	DR	BESTELNUMMER N° DE CDE ORDER NUMBER BESTELNR	B(1)	B(2)	L(1)	L(2)	HD(1)	HD(2)	PL	OPMERKINGEN REMARQUES REMARKS BEMERKUNGEN
------	----	---	------	------	------	------	-------	-------	----	--

VOLVO

Vorm* : B10

(*) Vorm : Forme/Schape/Form

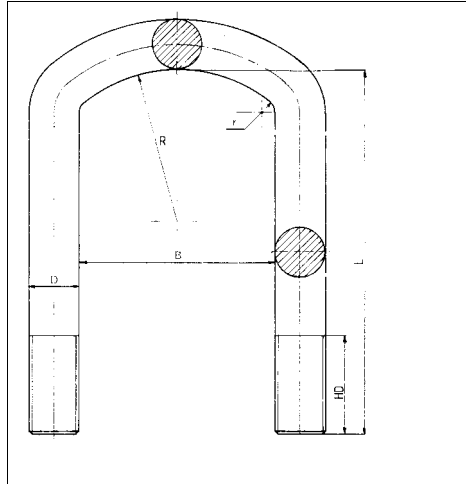

20.0	M20*1.5	B022M20A020	78	130	55					
	M20*1.5	B022M20A074	78	140	55					
	M20*1.5	B022M20A077	78	230	55					
	M20*1.5	B022M20A078	78	360	55					
	M20*1.5	B022M20A075	78	400	55					
	M20*1.5	B022M20A057	78	440	55					
20.0	M20*1.5	B022M20A071	91	160	70					
	M20*1.5	B022M20A003	91	205	70					
	M20*1.5	B022M20A072	91	290	70					
	M20*1.5	B022M20A016	91	315	70					
	M20*1.5	B022M20A073	91	420	70					
24.0	M24*3	B022M24A079	78		70					
	M24*3	B022M24A026	78	210	60					
	M24*3	B022M24A056	78	225	70					
	M24*3	B022M24A057	78	235	60					
	M24*3	B022M24A058	78	260	60					

DIAM	DR	BESTELNUMMER N° DE CDE ORDER NUMBER BESTELLNR	B(1)	B(2)	L(1)	L(2)	HD(1)	HD(2)	PL	OPMERKINGEN REMARQUES REMARKS BEMERKUNGEN
------	----	--	------	------	------	------	-------	-------	----	--

VOLVO

Vorm* : B10

(*) Vorm : Forme/Schape/Form

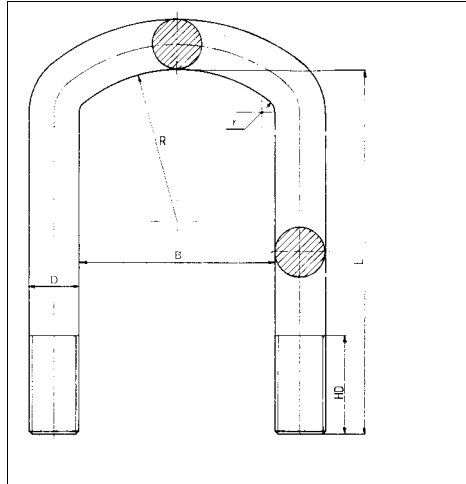

24.0	M24*3	B022M24A082	78	435	70					
------	-------	--------------------	----	-----	----	--	--	--	--	--

	M24*3	B022M24A078	78	445	70					
--	-------	-------------	----	-----	----	--	--	--	--	--

	M24*3	B022M24A059	78	510	60					
--	-------	-------------	----	-----	----	--	--	--	--	--

24.0	M24*3	B022M24A043	91	255	60					
------	-------	-------------	----	-----	----	--	--	--	--	--

	M24*3	B022M24A044	91	310	60					
--	-------	-------------	----	-----	----	--	--	--	--	--

	M24*3	B022M24A045	91	320	60					
--	-------	-------------	----	-----	----	--	--	--	--	--

	M24*3	B022M24A046	91	330	60					
--	-------	--------------------	----	-----	----	--	--	--	--	--

	M24*3	B022M24A060	91	370	60				B022M24A047	
--	-------	-------------	----	-----	----	--	--	--	-------------	--

	M24*3	B022M24A047	91	370	60					
--	-------	--------------------	----	-----	----	--	--	--	--	--

	M24*3	B022M24A008	91	385	60				B022M24A018	
--	-------	--------------------	----	-----	----	--	--	--	-------------	--

	M24*3	B022M24A027	91	400	60				B022M24A018	
--	-------	-------------	----	-----	----	--	--	--	-------------	--

	M24*3	B022M24A061	91	410	60				B022M24A018	
--	-------	-------------	----	-----	----	--	--	--	-------------	--

	M24*3	B022M24A075	91	420	70					
--	-------	--------------------	----	-----	----	--	--	--	--	--

	M24*3	B022M24A053	91	430	60				B022M24A018	
--	-------	-------------	----	-----	----	--	--	--	-------------	--

	M24*3	B022M24A030	91	450	60				B022M24A018	
--	-------	-------------	----	-----	----	--	--	--	-------------	--

	M24*3	B022M24A018	91	470	150					
--	-------	--------------------	----	-----	-----	--	--	--	--	--

DIAM	DR	BESTELNUMMER N° DE CDE ORDER NUMBER BESTELLNR	B(1)	B(2)	L(1)	L(2)	HD(1)	HD(2)	PL	OPMERKINGEN REMARQUES REMARKS BEMERKUNGEN
------	----	--	------	------	------	------	-------	-------	----	--

VOLVO

Vorm* : B10

(*) Vorm : Forme/Schape/Form

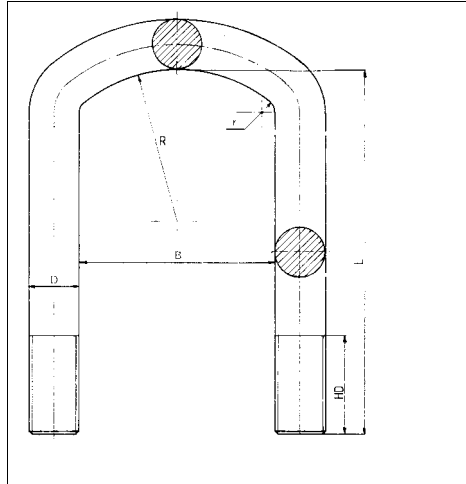

24.0	M24*3	B022M24A048	102		370		70			B022M24A054
	M24*3	B022M24A049	102		380		70			B022M24A054
	M24*3	B022M24A050	102		390		70			B022M24A054
	M24*3	B022M24A051	102		410		70			B022M24A054
	M24*3	B022M24A054	102		425		150			
	M24*3	B022M24A052	102		425		70			B022M24A054
24.0	M24*	B022M24A062	104		145		60			
	M24*	B022M24A063	104		150		60			
	M24*	B022M24A064	104		160		75			
	M24*	B022M24A065	104		180		60			
	M24*	B022M24A066	104		190		60			
	M24*2	B022M24A028	104		200		60			
	M24*	B022M24A067	104		205		60			
	M24*2	B022M24A019	104		210		70			
	M24*2	B022M24A031	104		225		70			
	M24*2	B022M24A032	104		245		70			
	M24*	B022M24A068	104		260		70			

DIAM	DR	BESTELNUMMER N° DE CDE ORDER NUMBER BESTELNR	B(1)	B(2)	L(1)	L(2)	HD(1)	HD(2)	PL	OPMERKINGEN REMARQUES REMARKS BEMERKUNGEN
------	----	---	------	------	------	------	-------	-------	----	--

VOLVO

Vorm* : B10

(*) *Vorm : Forme/Schape/Form*

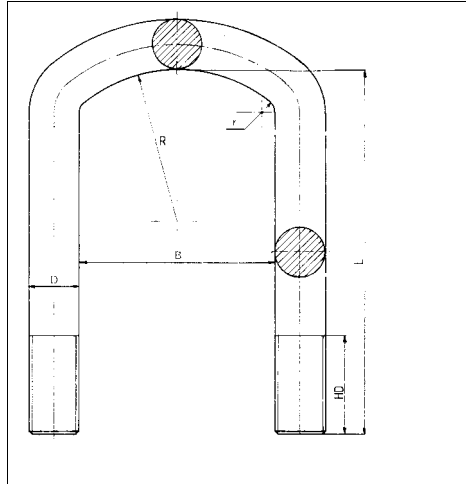

24.0	M24*2	B022M24A004	104		275		70			
	M24*2	B022M24A033	104		300		100			
24.0	M24*	B022M24A069	150		370		65			
	M24*	B022M24A070	150		375		60			
	M24*	B022M24A071	150		385		60			
	M24*	B022M24A072	150		390		65			
	M24*	B022M24A073	150		395		65			
	M24*	B022M24A074	150		402		60			

DIAM	DR	BESTELNUMMER N° DE CDE ORDER NUMBER BESTELNR	B(1)	B(2)	L(1)	L(2)	HD(1)	HD(2)	PL	OPMERKINGEN REMARQUES REMARKS BEMERKUNGEN
------	----	---	------	------	------	------	-------	-------	----	--

VOLVO

Vorm* : B14

(*) *Vorm : Forme/Schape/Form*

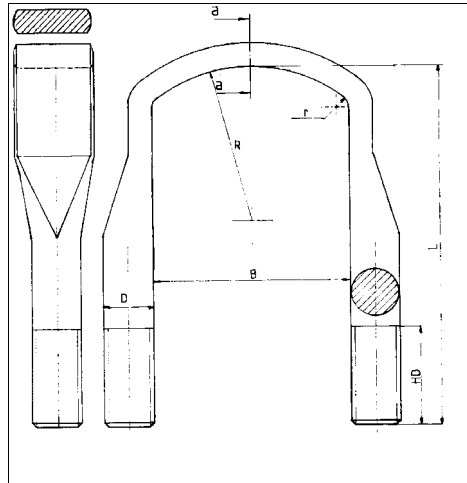

20.0	M20*1.5	B022M20B007	78		325		60			
	M20*1.5	B022M20B006	78		400		60			
	M20*1.5	B022M20B008	78		425		60			
	M20*1.5	B022M20B009	78		460		60			
24.0	M24*2	B022M24B025	78		490		60			
	M24*2	B022M24B026	78		510		60			
24.0	M24*2	B022M24B015	91		370		60			
	M24*2	B022M24B017	91		405		60			
	M24*2	B022M24B019	91		432		60			
	M24*2	B022M24B014	91		438		60			
	M24*2	B022M24B024	91		445		60			
	M24*2	B022M24B010	91		450		60			
	M24*2	B022M24B011	91		470		60			
	M24*2	B022M24B016	91		480		60			
	M24*2	B022M24B023	91		495		60			
	M24*2	B022M24B018	91		505		60			

DIAM	DR	BESTELNUMMER N° DE CDE ORDER NUMBER BESTELNR	B(1)	B(2)	L(1)	L(2)	HD(1)	HD(2)	PL	OPMERKINGEN REMARQUES REMARKS BEMERKUNGEN
------	----	---	------	------	------	------	-------	-------	----	--

VOLVO

Vorm* : B14

(*) Vorm : Forme/Schape/Form

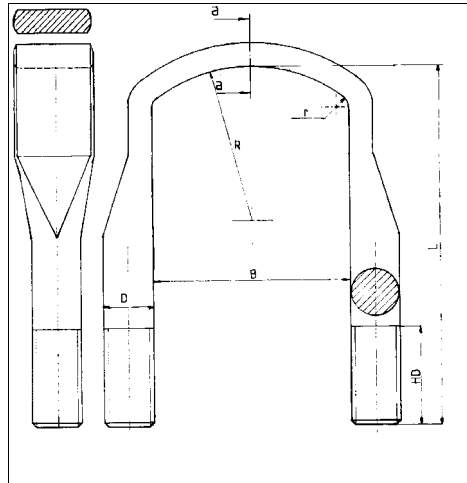

24.0	M24*2	B022M24B021	91		510		60			
	M24*2	B022M24B020	91		525		60			
	M24*2	B022M24B022	91		540		60			
	M24*2	B022M24B533	91		545					
	M24*2	B022M24B012	91		550		60			
	M24*2	B022M24B528	91		600		120			

DIAM	DR	BESTELNUMMER N° DE CDE ORDER NUMBER BESTELLNR	B(1)	B(2)	L(1)	L(2)	HD(1)	HD(2)	PL	OPMERKINGEN REMARQUES REMARKS BEMERKUNGEN
------	----	--	------	------	------	------	-------	-------	----	--

VOLVO

Vorm* : B16

(*) *Vorm : Forme/Schape/Form*

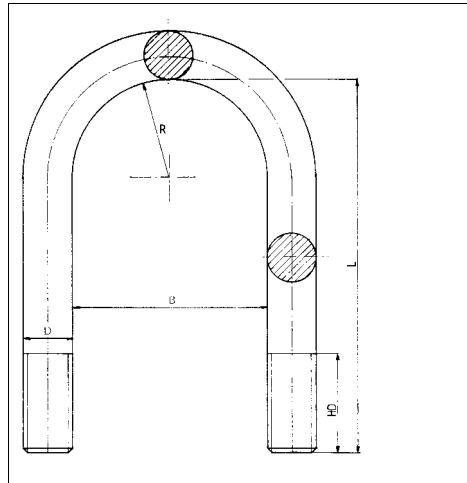

18.0	M18*2.5	B022M18A039	83		190		60			
20.0	M20*2.5	B022M20A086	79		280		85			
	M20*2.5	B022M20A085	79		310		85			
20.0	M20*2.5	B022M20A087	82		310		85			

Vorm Dia B(1) B(2) L(1) L(2) HD1 HD2

A022T207ZB70

Pen ; Axe ; Pin ; Bolzen :

YC022C234319	in B
--------------	------

A022T208ZA71

Veerstrop ; Bride ; U Bolt ; Federbride :

B022M20B036	B03S	20.0	82		420		60	
-------------	------	------	----	--	-----	--	----	--

A022T212ZA75

Pen ; Axe ; Pin ; Bolzen :

YC022C401113	
--------------	--

A022T212ZB75

Pen ; Axe ; Pin ; Bolzen :

YC022C401113	
--------------	--

A022T212ZC75

Pen ; Axe ; Pin ; Bolzen :

YC022C401113	
--------------	--

A022T212ZD75

Pen ; Axe ; Pin ; Bolzen :

YC022C401113	
--------------	--

A022T213ZB70

Pen ; Axe ; Pin ; Bolzen :

YC022C234318	
--------------	--

A022T227ZA75

Veerstrop ; Bride ; U Bolt ; Federbride :

B022M20A070	B01	20.0	102		260		120	
--------------------	-----	------	-----	--	-----	--	-----	--

A022T228ZA71

Veerstrop ; Bride ; U Bolt ; Federbride :

B022M24B559	B03S	24.0	102		480		60	
B022M24B580	B03S	24.0	102		510		120	

A022T241ZA75

Pen ; Axe ; Pin ; Bolzen :

C300959	in B (2st)
YC022C401159	

A022T241ZB75

Pen ; Axe ; Pin ; Bolzen :

C300959	in B (2st)
YC022C401159	

Vorm Dia B(1) B(2) L(1) L(2) HD1 HD2

A022T243ZA75 *Veerstrop ; Bride ; U Bolt ; Federbride :*

B022M20A069	B01	20.0
B022M20A070	B01	20.0

102		210		90	
102		260		120	

Pen ; Axe ; Pin ; Bolzen :

C300959	in B (2st)
YC022C401159	

A022T247ZB75 *Veerstrop ; Bride ; U Bolt ; Federbride :*

B022M20A069	B01	20.0
--------------------	-----	------

102		210		90	
-----	--	-----	--	----	--

A022T255ZA70

Pen ; Axe ; Pin ; Bolzen :

YC022C234318	in B
--------------	------

A022T257ZA75 *Veerstrop ; Bride ; U Bolt ; Federbride :*

B022M20A070	B01	20.0
--------------------	-----	------

102		260		120	
-----	--	-----	--	-----	--

Pen ; Axe ; Pin ; Bolzen :

C300959	in B, C en D (6st)
YC022C401159	in C
YC022C401160	in B en D

A022T259ZA75 *Veerstrop ; Bride ; U Bolt ; Federbride :*

B022M20A070	B01	20.0
--------------------	-----	------

102		260		120	
-----	--	-----	--	-----	--

Pen ; Axe ; Pin ; Bolzen :

C300959	in B, C en D (6st)
YC022C401159	in C
YC022C401160	in B en D

A022T266ZA71 *Veerstrop ; Bride ; U Bolt ; Federbride :*

B022M20B036	B03S	20.0
-------------	------	------

82		420		60	
----	--	-----	--	----	--

Pen ; Axe ; Pin ; Bolzen :

YC022C234319	in B
--------------	------

A022T272ZA71 *Veerstrop ; Bride ; U Bolt ; Federbride :*

B022M18A013	B01	18.0
B022M18A022	B01	18.0

72		360		60	
72		360		100	

Pen ; Axe ; Pin ; Bolzen :

YC022C234318	in B
--------------	------

A022T277ZA75 *Veerstrop ; Bride ; U Bolt ; Federbride :*

B022M20A070	B01	20.0
--------------------	-----	------

102		260		120	
-----	--	-----	--	-----	--

Vorm Dia B(1) B(2) L(1) L(2) HD1 HD2

A022T279ZA75 Veerstrop ; Bride ; U Bolt ; Federbride :

B022M20A070	B01	20.0
--------------------	-----	------

102		260		120	
-----	--	-----	--	-----	--

Pen ; Axe ; Pin ; Bolzen :

C300959	in B (2st)
YC022C401107	in B
YC022C401159	in B

A022T281ZA75 Veerstrop ; Bride ; U Bolt ; Federbride :

B022M20A070	B01	20.0
--------------------	-----	------

102		260		120	
-----	--	-----	--	-----	--

A022T283ZA75

Pen ; Axe ; Pin ; Bolzen :

YC022C234319	in B
--------------	------

A022T284ZA70 Veerstrop ; Bride ; U Bolt ; Federbride :

B022M24A047	B10	24.0
B022M24A008	B10	24.0
B022M24A018	B10	24.0

91		370		60	
91		385		60	
91		470		150	

A022T285ZA75

Pen ; Axe ; Pin ; Bolzen :

YC022C234320	in B
--------------	------

A022T285ZS75 Veerstrop ; Bride ; U Bolt ; Federbride :

B022M20A070	B01	20.0
--------------------	-----	------

102		260		120	
-----	--	-----	--	-----	--

A022T286ZA70 Veerstrop ; Bride ; U Bolt ; Federbride :

B022M24B579	B03S	24.0
--------------------	------	------

102		450		110	
-----	--	-----	--	-----	--

A022T288ZA76 Veerstrop ; Bride ; U Bolt ; Federbride :

B022M20B035	B03S	20.0
B022M20B013	B03S	20.0
B022M20B037	B03S	20.0
B022M20B040	B03S	20.0

82		405		60	
82		405		105	
82		430		60	
82		460		60	

Pen ; Axe ; Pin ; Bolzen :

YC022C234319	
--------------	--

A022T291ZA75

Pen ; Axe ; Pin ; Bolzen :

c300959	in B, C en D (6st)
YC022C401159	in B en D
YC022C401160	in C

A022T292ZS76 Veerstrop ; Bride ; U Bolt ; Federbride :

B022M24B579	B03S	24.0
--------------------	------	------

102		450		110	
-----	--	-----	--	-----	--

Vorm Dia B(1) B(2) L(1) L(2) HD1 HD2

A022T299ZA75

Pen ; Axe ; Pin ; Bolzen :

YC022C234319	in B
--------------	------

A022T303ZA75

Pen ; Axe ; Pin ; Bolzen :

C300959	in B (2st)
YC022C401159	

A022T322ZA70

Veerstrop ; Bride ; U Bolt ; Federbride :

B022M24A046	B10	24.0	91		330		60	
--------------------	-----	------	----	--	-----	--	----	--

A022T365ZA75

Pen ; Axe ; Pin ; Bolzen :

YC022C401160	in B en C
--------------	-----------

A022T367ZA75

Veerstrop ; Bride ; U Bolt ; Federbride :

B022M20A076	B01	20.0	102		185		70	
-------------	-----	------	-----	--	-----	--	----	--

Pen ; Axe ; Pin ; Bolzen :

C300959	in B, C en D (6st)
YC022C401191	in B en C
YC022C401195	in D

A022T369ZA75

Veerstrop ; Bride ; U Bolt ; Federbride :

B022M20A076	B01	20.0	102		185		70	
B022M20A069	B01	20.0	102		210		90	

Pen ; Axe ; Pin ; Bolzen :

YC022C401123	bout in C en D
YC022C401196	bout in B

A022T371ZA75

Veerstrop ; Bride ; U Bolt ; Federbride :

B022M20A062	B01	20.0	102		210		70	
B022M20A069	B01	20.0	102		210		90	
B022M20A065	B01	20.0	102		235		70	
B022M20A070	B01	20.0	102		260		120	

Pen ; Axe ; Pin ; Bolzen :

YC022C401123	bout in C en D
YC022C401196	bout in B

A022T408ZA70

Veerstrop ; Bride ; U Bolt ; Federbride :

B022M24A078	B10	24.0	78		445		70	
-------------	-----	------	----	--	-----	--	----	--

F022T216ZA75

Veerstrop ; Bride ; U Bolt ; Federbride :

B022M24A049	B10	24.0	102		380		70	
B022M24A054	B10	24.0	102		425		150	

Pen ; Axe ; Pin ; Bolzen :

YC022C401113	in B
YC022C401264	in B

Vorm Dia B(1) B(2) L(1) L(2) HD1 HD2

F022T216ZA76

Pen ; Axe ; Pin ; Bolzen :

YC022C401113	F7,F10,F12,N10,N12
YC022C401264	FL10,FL12

F022T219ZA75

Pen ; Axe ; Pin ; Bolzen :

C300959	in B (2st)
YC022C401159	

F022T221ZA75

Veerstrop ; Bride ; U Bolt ; Federbride :

B022M20A069	B01	20.0	102		210		90	
--------------------	-----	------	-----	--	-----	--	----	--

F022T223ZA75

Pen ; Axe ; Pin ; Bolzen :

C300959	in B (2st)
YC022C401159	

F022T231ZA75

Veerstrop ; Bride ; U Bolt ; Federbride :

B022M20A069	B01	20.0	102		210		90	
--------------------	-----	------	-----	--	-----	--	----	--

F022T249ZA75

Veerstrop ; Bride ; U Bolt ; Federbride :

B022M20A069	B01	20.0	102		210		90	
--------------------	-----	------	-----	--	-----	--	----	--

Pen ; Axe ; Pin ; Bolzen :

C300959	in B, C en D (6st)
YC022C401159	in C
YC022C401160	in B en D

F022T251ZA75

Veerstrop ; Bride ; U Bolt ; Federbride :

B022M20A069	B01	20.0	102		210		90	
--------------------	-----	------	-----	--	-----	--	----	--

Pen ; Axe ; Pin ; Bolzen :

C300959	in B, C en D (6 st)
YC022C401159	in C
YC022C401160	in B en D

F022T261ZA75

Veerstrop ; Bride ; U Bolt ; Federbride :

B022M20A067	B01	20.0	102		255		70	
B022M20A070	B01	20.0	102		260		120	

Pen ; Axe ; Pin ; Bolzen :

C300959	in B (2st)
YC022C401159	

F022T267ZA75

Pen ; Axe ; Pin ; Bolzen :

C300959	in b, C en D (6st)
YC022C401159	in C
YC022C401160	in B en D

Vorm Dia B(1) B(2) L(1) L(2) HD1 HD2

F022T269ZA75

Pen ; Axe ; Pin ; Bolzen :

C300959	in b, C en D (6st)
YC022C401159	in C
YC022C401160	in B en D

F022T271ZA75

Veerstrop ; Bride ; U Bolt ; Federbride :

B022M18A017	B01	18.0	82		150		50	
B022M18A023	B01	18.0	82		165		95	

Pen ; Axe ; Pin ; Bolzen :

YC022C233422	in C en D zie Toep
YC022C401192	in B, C en D zie Toep
YC022C401193	in B zie Toep

F022T271ZS75

Pen ; Axe ; Pin ; Bolzen :

YC022C234319	in B los bijgeleverd
--------------	----------------------

F022T273ZA75

Pen ; Axe ; Pin ; Bolzen :

YC022C233422	in C en D
YC022C401192	in C en D
YC022C401193	in B

F022T274ZA75

Veerstrop ; Bride ; U Bolt ; Federbride :

B022M24B550	B03S	24.0	102		350		60	
B022M24B551	B03S	24.0	102		380		60	
B022M24B578	B03S	24.0	102		400		110	
B022M24B554	B03S	24.0	102		420		60	
B022M24B579	B03S	24.0	102		450		110	

Pen ; Axe ; Pin ; Bolzen :

YC022C233415	bus uitw dr in B & C
YC022C233433	bus uitw dr in D
YC022C401104	in B
YC022C401105	schommel in D
YC022C401106	in C

F022T275ZA75

Pen ; Axe ; Pin ; Bolzen :

YC022C234320	in B
--------------	------

F022T280ZA76

Pen ; Axe ; Pin ; Bolzen :

YC022C234319	in B
--------------	------

F022T289ZA75

Veerstrop ; Bride ; U Bolt ; Federbride :

B022M20A069	B01	20.0	102		210		90	
--------------------	-----	------	-----	--	-----	--	----	--

Pen ; Axe ; Pin ; Bolzen :

C300959	in B, C en D (6st)
YC022C401159	in C
YC022C401160	in B en D

Vorm Dia B(1) B(2) L(1) L(2) HD1 HD2

F022T293ZA75 Veerstrap ; Bride ; U Bolt ; Federbride :

B022M20A069	B01	20.0	102		210		90	
--------------------	-----	------	-----	--	-----	--	----	--

Pen ; Axe ; Pin ; Bolzen :

C300959	in B, C en D (6st)
YC022C401159	in B en D
YC022C401160	in C

F022T295ZA75 Veerstrap ; Bride ; U Bolt ; Federbride :

B022M20A069	B01	20.0	102		210		90	
--------------------	-----	------	-----	--	-----	--	----	--

Pen ; Axe ; Pin ; Bolzen :

C300959	in B, C en D (6st)
YC022C401159	in B en D
YC022C401160	in C

F022T305ZA75 Veerstrap ; Bride ; U Bolt ; Federbride :

B022M20A068	B01	20.0	102		260		70	
-------------	-----	------	-----	--	-----	--	----	--

Pen ; Axe ; Pin ; Bolzen :

C300959	in B, C en D (6st)
YC022C401159	in C
YC022C401160	in B en D

F022T306ZA75

Pen ; Axe ; Pin ; Bolzen :

YC022C233415	bus uitw dr in B & C
YC022C233433	bus uitw dr in D
YC022C401104	in B
YC022C401105	schommel in D
YC022C401106	in C

F022T307ZA75 Veerstrap ; Bride ; U Bolt ; Federbride :

B022M20A062	B01	20.0	102		210		70	
B022M20A069	B01	20.0	102		210		90	

Pen ; Axe ; Pin ; Bolzen :

C300959	in B, C en d (6st)
YC022C401159	in C
YC022C401160	in B en D

F022T311ZA75 Veerstrap ; Bride ; U Bolt ; Federbride :

B022M20A068	B01	20.0	102		260		70	
B022M20A070	B01	20.0	102		260		120	

Pen ; Axe ; Pin ; Bolzen :

C300959	in B, C en D (2st)
YC022C401159	in C
YC022C401160	in B en D

Vorm Dia B(1) B(2) L(1) L(2) HD1 HD2

F022T313ZA75 *Veerstrop ; Bride ; U Bolt ; Federbride :*

B022M20A062	B01	20.0
B022M20A069	B01	20.0

102		210		70	
102		210		90	

Pen ; Axe ; Pin ; Bolzen :

C300959	in B, C en d (6st)
YC022C401159	in C
YC022C401160	in B en D

F022T315ZA75

Pen ; Axe ; Pin ; Bolzen :

C300959	in B, c en D (6st)
YC022C401159	in C
YC022C401160	in B en D

F022T316ZA75

Pen ; Axe ; Pin ; Bolzen :

YC022C401113	in B
YC022C401264	in B

F022T321ZA75 *Veerstrop ; Bride ; U Bolt ; Federbride :*

B022M20A062	B01	20.0
B022M20A069	B01	20.0

102		210		70	
102		210		90	

Pen ; Axe ; Pin ; Bolzen :

C300959	in B, C en D (6st)
YC022C401159	in C
YC022C401160	in B en D

F022T323ZA75 *Veerstrop ; Bride ; U Bolt ; Federbride :*

B022M20A068	B01	20.0
B022M20A070	B01	20.0

102		260		70	
102		260		120	

Pen ; Axe ; Pin ; Bolzen :

C300959	in B, C en D (6st)
YC022C401159	in C
YC022C401160	in B en D

F022T327ZA75 *Veerstrop ; Bride ; U Bolt ; Federbride :*

B022M20A069	B01	20.0
B022M20A070	B01	20.0

102		210		90	
102		260		120	

Pen ; Axe ; Pin ; Bolzen :

C300959	in B, C en D (6st)
YC022C401159	in D
YC022C401160	in B en C

F022T329ZA75 *Veerstrop ; Bride ; U Bolt ; Federbride :*

B022M20A069	B01	20.0
B022M20A070	B01	20.0

102		210		90	
102		260		120	

Pen ; Axe ; Pin ; Bolzen :

c300959	in B, C en D (6st)
YC022C401159	in D
YC022C401160	in B en C

Vorm Dia B(1) B(2) L(1) L(2) HD1 HD2

F022T331ZA75 *Veerstrop ; Bride ; U Bolt ; Federbride :*

B022M20A069	B01	20.0
B022M20A070	B01	20.0

102		210		90	
102		260		120	

Pen ; Axe ; Pin ; Bolzen :

C300959	in B, C en D (6st)
YC022C401159	in D
YC022C401160	in B en C

F022T333ZA75 *Veerstrop ; Bride ; U Bolt ; Federbride :*

B022M20A069	B01	20.0
B022M20A070	B01	20.0

102		210		90	
102		260		120	

Pen ; Axe ; Pin ; Bolzen :

YC022C401159	in D
YC022C401160	in B en C

F022T335ZA75 *Veerstrop ; Bride ; U Bolt ; Federbride :*

B022M20A067	B01	20.0
B022M20A070	B01	20.0
B022M20A079	B01	20.0

102		255		70	
102		260		120	
102		285		70	

Pen ; Axe ; Pin ; Bolzen :

YC022C401123	bout in C en D
YC022C401196	bout in B

F022T337ZA75 *Veerstrop ; Bride ; U Bolt ; Federbride :*

B022M20A062	B01	20.0
B022M20A069	B01	20.0
B022M20A065	B01	20.0
B022M20A070	B01	20.0

102		210		70	
102		210		90	
102		235		70	
102		260		120	

Pen ; Axe ; Pin ; Bolzen :

YC022C401123	bout in C en D
YC022C401196	bout in B

F022T339ZA75 *Veerstrop ; Bride ; U Bolt ; Federbride :*

B022M20A069	B01	20.0
B022M20A070	B01	20.0

102		210		90	
102		260		120	

Pen ; Axe ; Pin ; Bolzen :

C300959	in B, C en D (6st)
YC022C401191	in B en C
YC022C401195	in D

F022T341ZA75 *Veerstrop ; Bride ; U Bolt ; Federbride :*

B022M20A069	B01	20.0
B022M20A070	B01	20.0

102		210		90	
102		260		120	

Pen ; Axe ; Pin ; Bolzen :

C300959	in B, C en D (6st)
YC022C401191	in B en C
YC022C401195	in D

Vorm Dia B(1) B(2) L(1) L(2) HD1 HD2

F022T342ZA76 *Veerstrop ; Bride ; U Bolt ; Federbride :*

B022M24B576	B03S	24.0
B022M24B577	B03S	24.0
B022M24B585	B03S	24.0

82		430		60	
82		460		60	
82		460		160	

Pen ; Axe ; Pin ; Bolzen :

YC022C401197	bout in B
--------------	-----------

F022T343ZA75 *Veerstrop ; Bride ; U Bolt ; Federbride :*

B022M20A069	B01	20.0
B022M20A070	B01	20.0

102		210		90	
102		260		120	

Pen ; Axe ; Pin ; Bolzen :

C300959	in B, C en D (6st)
YC022C401191	in B en C
YC022C401195	in D

F022T345ZA75 *Veerstrop ; Bride ; U Bolt ; Federbride :*

B022M20A061	B01	20.0
B022M20A069	B01	20.0

102		200		70	
102		210		90	

Pen ; Axe ; Pin ; Bolzen :

C300959	in B, C en d (6st)
YC022C401159	in D
YC022C401160	in B en C

F022T346ZA70 *Veerstrop ; Bride ; U Bolt ; Federbride :*

B022M24A079	B10	24.0
-------------	-----	------

78				70	
----	--	--	--	----	--

F022T347ZA75 *Veerstrop ; Bride ; U Bolt ; Federbride :*

B022M20A061	B01	20.0
B022M20A069	B01	20.0
B022M20A080	B01	20.0
B022M20B083	B01	20.0

102		200		70	
102		210		90	
102		220		70	
102		280		70	

Pen ; Axe ; Pin ; Bolzen :

C300959	in b, C en D (6st)
YC022C401191	in B en C
YC022C401195	in D

F022T348ZA75 *Veerstrop ; Bride ; U Bolt ; Federbride :*

B022M24A051	B10	24.0
-------------	-----	------

102		410		70	
-----	--	-----	--	----	--

Vorm Dia B(1) B(2) L(1) L(2) HD1 HD2

F022T349ZA75 *Veerstrop ; Bride ; U Bolt ; Federbride :*

B022M20A061	B01	20.0	102		200		70	
B022M20A069	B01	20.0	102		210		90	
B022M20A080	B01	20.0	102		220		70	
B022M20A066	B01	20.0	102		240		70	
B022M20A068	B01	20.0	102		260		70	
B022M20A070	B01	20.0	102		260		120	

Pen ; Axe ; Pin ; Bolzen :

YC022C401160	in B en C
--------------	-----------

F022T351ZA75 *Veerstrop ; Bride ; U Bolt ; Federbride :*

B022M20A061	B01	20.0	102		200		70	
B022M20A061	B01	20.0	102		200		70	
B022M20A069	B01	20.0	102		210		90	
B022M20A065	B01	20.0	102		235		70	
B022M20A066	B01	20.0	102		240		70	
B022M20A068	B01	20.0	102		260		70	
B022M20A070	B01	20.0	102		260		120	

Pen ; Axe ; Pin ; Bolzen :

C300959	in B, C en D (6st)
YC022C401191	in B en C
YC022C401195	in D

F022T353ZA75 *Veerstrop ; Bride ; U Bolt ; Federbride :*

B022M20A069	B01	20.0	102		210		90	
B022M20A070	B01	20.0	102		260		120	

Pen ; Axe ; Pin ; Bolzen :

C300959	in B, c en D (6st)
YC022C401191	in B en C
YC022C401195	in D

F022T354ZA70 *Veerstrop ; Bride ; U Bolt ; Federbride :*

B022M20A086	B16	20.0	79		280		85	
-------------	-----	------	----	--	-----	--	----	--

F022T356ZA70 *Veerstrop ; Bride ; U Bolt ; Federbride :*

B022M20A085	B16	20.0	79		310		85	
-------------	-----	------	----	--	-----	--	----	--

F022T357ZA75

Pen ; Axe ; Pin ; Bolzen :

C300959	in B, C en D (6st)
YC022C401159	in D
YC022C401160	in B en C

F022T359ZA75

Pen ; Axe ; Pin ; Bolzen :

YC022C401160	in B en C
--------------	-----------

Vorm Dia B(1) B(2) L(1) L(2) HD1 HD2

F022T360ZA76 *Veerstrop ; Bride ; U Bolt ; Federbride :*

B022M24B576	B03S	24.0
B022M24B577	B03S	24.0
B022M24B585	B03S	24.0

82		430		60	
82		460		60	
82		460		160	

Pen ; Axe ; Pin ; Bolzen :

YC022C401197	bout in B
--------------	-----------

F022T361ZA75 *Veerstrop ; Bride ; U Bolt ; Federbride :*

B022M20A069	B01	20.0
--------------------	-----	------

102		210		90	
-----	--	-----	--	----	--

Pen ; Axe ; Pin ; Bolzen :

C300959	in B, C en D (6st)
YC022C401191	in B en C
YC022C401195	in D

F022T362ZA75 *Veerstrop ; Bride ; U Bolt ; Federbride :*

B022M24B573	B03S	24.0
B022M24B575	B03S	24.0
B022M24B585	B03S	24.0

82		380		60	
82		410		60	
82		460		160	

Pen ; Axe ; Pin ; Bolzen :

YC022C401197	bout in B
--------------	-----------

F022T363ZA75 *Veerstrop ; Bride ; U Bolt ; Federbride :*

B022M20A076	B01	20.0
-------------	-----	------

102		185		70	
-----	--	-----	--	----	--

Pen ; Axe ; Pin ; Bolzen :

C300959	in B, C en D (6st)
YC022C401191	in B en C
YC022C401195	in D

F022T373ZA75 *Veerstrop ; Bride ; U Bolt ; Federbride :*

B022M20A062	B01	20.0
B022M20A069	B01	20.0
B022M20A065	B01	20.0
B022M20A070	B01	20.0

102		210		70	
102		210		90	
102		235		70	
102		260		120	

Pen ; Axe ; Pin ; Bolzen :

YC022C401123	bout in C en D
YC022C401196	bout in B

F022T374ZA75 *Veerstrop ; Bride ; U Bolt ; Federbride :*

B022M24A051	B10	24.0
-------------	-----	------

102		410		70	
-----	--	-----	--	----	--

F022T375ZA75 *Veerstrop ; Bride ; U Bolt ; Federbride :*

B022M20A076	B01	20.0
B022M20A069	B01	20.0

102		185		70	
102		210		90	

Pen ; Axe ; Pin ; Bolzen :

YC022C401123	
--------------	--

Vorm Dia B(1) B(2) L(1) L(2) HD1 HD2

F022T377ZA75 *Veerstrop ; Bride ; U Bolt ; Federbride :*

B022M20A062	B01	20.0
B022M20A069	B01	20.0
B022M20A065	B01	20.0
B022M20A070	B01	20.0

102		210		70	
102		210		90	
102		235		70	
102		260		120	

Pen ; Axe ; Pin ; Bolzen :

YC022C401123	bout in C en D
YC022C401196	bout in B

F022T379ZA75 *Veerstrop ; Bride ; U Bolt ; Federbride :*

B022M20A076	B01	20.0
B022M20A069	B01	20.0

102		185		70	
102		210		90	

Pen ; Axe ; Pin ; Bolzen :

YC022C401123	bout in C en D
YC022C401196	bout in B

F022T384ZA70 *Veerstrop ; Bride ; U Bolt ; Federbride :*

B022M20A085	B16	20.0
-------------	-----	------

79		310		85	
----	--	-----	--	----	--

F022T387ZA75

Pen ; Axe ; Pin ; Bolzen :

YC022C233422	in C en D
YC022C234319	in B
YC022C401192	in C en D

F022T395ZA75 *Veerstrop ; Bride ; U Bolt ; Federbride :*

B022M20A076	B01	20.0
-------------	-----	------

102		185		70	
-----	--	-----	--	----	--

Pen ; Axe ; Pin ; Bolzen :

C300959	in B, C en D (6st)
YC022C401191	in B en C
YC022C401195	in D

F022T397ZA75 *Veerstrop ; Bride ; U Bolt ; Federbride :*

B022M20A065	B01	20.0
-------------	-----	------

102		235		70	
-----	--	-----	--	----	--

Pen ; Axe ; Pin ; Bolzen :

C300959	in B, C en D (6st)
YC022C401191	in B en C
YC022C401195	in D