

# UNIBRAKE®

## Brake Caliper Repair Kit



**the world knows unibrake**

### PRODUCT CATALOGUE



[www.unibrake.com.tr](http://www.unibrake.com.tr)





# Sertifika

## NECMİ KARATAŞ – KARATAŞ OTOMOTİV

FEVZİÇAKMAK MAHALLESİ 10733. SK. NO:13/1  
KARATAY – KONYA / TÜRKİYE

*Goldcert, yukarıda bilgileri bulunan kuruluşun*

**ISO 9001:2015**  
KALİTE YÖNETİM SİSTEMİ

*standardına uygunluğunun*

**FRENLER, SERVO FRENLER, AKSAMLARI VE PARÇALARI TEMİNİ,  
PAZARLAMA VE SATIŞI**

*kapsamında değerlendirildiğini, kuruluşun ilgili standardın gereklerine uygun bir yönetim sistemi kurduğunu ve uygulamakta olduğunu teyit eder.*

Sertifika Numarası : GC-18-2185  
Belgelendirme Tarihi : 20/10/2018  
Sertifika Yayın Tarihi : 20/10/2018 Rev:0  
Geçerlilik Tarihi : 19/10/2021



TÜRKAK BDS NO  
YS-68E9-9C94

Genel Müdür

*Erdin Aydin*



Bu sertifika, Goldcert belgelendirme kurallarına uyulduğu sürece geçerlidir. Sertifika Doğrulama işlemi; mobil cihazlar aracılığıyla belge üzerindeki karekod okutularak veya "TÜRKAK BDS No" ile <https://tbd.s.turkak.org.tr> belge doğrulama sisteminden yapılabilir.

SERTİFİKA BELGELENDİRME DENETİM MUAYENE ve EĞİTİM HİZMETLERİ LTD. ŞTİ.  
İktili OSB Çiyim Sanatkarları Sanayi Sitesi 3. Ada A Blok No: 301 Başakşehir 34490 İstanbul/TÜRKİYE  
Tel: +90 212 407 01 00 Faks: +90 212 407 00 17 info@goldcert.com.tr





T.C.  
TÜRK PATENT ENSTİTÜSÜ

# MARKA TESCİL BELGESİ SURETİ

Marka No : 2010 48385 - Ticaret - Hizmet

## UNIBRAKE

Marka Sahibi : NECMİ KARATAŞ (T.C Kimlik No: 44332601474)  
TÜRKİYE CUMHURİYETİ  
Horozluhan Mah. Ayça Sk. No: 40 Selçuklu / KONYA

Emtiası : 12 , 35  
İlişiktir

Markaların Korunması Hakkında 556 Sayılı Kanun Hükmünde  
Kararnameye göre 23/07/2010 tarihinden itibaren ON YIL müddetle  
02/11/2011 tarihinde tescil edilmiştir.

ASLI GİBİDİR

Elif B. AKIN  
Enstitü Başkanı a.  
Markalar Dairesi Başkanı

Hüseyin ÖZDEMİR  
Şube Müdürü

TÜRK PATENT [ ] ENSTİTÜSÜ





**СЕРТИФИКАТ СООТВЕТСТВИЯ**

№ TC RU C-TR.AД50.B.00532

Серия RU № 0751892

**ОРГАН ПО СЕРТИФИКАЦИИ** Общество с ограниченной ответственностью «СТАНДАРТМАШТЕСТ». Место нахождения: 117437, Российская Федерация, город Москва, улица Академика Арцимовича, дом 17, помещение V, комната 9. Адрес места осуществления деятельности: 115114, Российская Федерация, город Москва, улица Летниковская, дом 9, строение 1. Аттестат аккредитации регистрационный № RA.RU.10AД50. Дата регистрации аттестата аккредитации 03.03.2017 года. Телефон: +74954813360. Адрес электронной почты: info@standartmashtest.ru

**ЗАЯВИТЕЛЬ** Общество с ограниченной ответственностью «Мир Технологий». Основной государственный регистрационный номер: 1187746469096. Место нахождения: 117042, Российская Федерация, город Москва, улица Адмирала Руднева, дом 4, этаж 6, помещение IV, офис 613. Телефон: 89154152183, адрес электронной почты: MirTehnologiy@gmail.com

**ИЗГОТОВИТЕЛЬ** «KARATAS OTOMOTIV - NECMI KARATAS». Место нахождения: ТУРЦИЯ, Fevzi Cakmak Mah.10733 Sok. No:13 Karatay/Konya

**ПРОДУКЦИЯ** Компоненты, поставляемые в качестве сменных (запасных) частей для послепродажного технического обслуживания автотранспортных средств, торговой марки «UNIBRAKE»: согласно приложению - бланки №№ 0553716, 0553717. Продукция изготовлена в соответствии с Директивой 2007/46/ЕС. Серийный выпуск

КОД ТН ВЭД ТС 8708 30 990 9, 8708 30 990 0, 7317 00 800 9

**СООТВЕТСТВУЕТ ТРЕБОВАНИЯМ** Технического регламента Таможенного союза ТР ТС 018/2011 "О безопасности колесных транспортных средств"

**СЕРТИФИКАТ ВЫДАН НА ОСНОВАНИИ** протоколов испытаний №№ 981АТС-2018, 982АТС-2018 от 25.09.2018 года, выданных испытательной лабораторией «АвтоТракторные Средства» Общества с ограниченной ответственностью «ПРОММАШ ТЕСТ», аттестат аккредитации № RA.RU.21НА71.

Схема сертификации: 11с

**ДОПОЛНИТЕЛЬНАЯ ИНФОРМАЦИЯ** Условия хранения, срок хранения (службы, годности) продукции указаны в прилагаемой к продукции эксплуатационной документации. Стандарт, обеспечивающий соблюдение требований Технического регламента Таможенного союза ТР ТС 018/2011 "О безопасности колесных транспортных средств": ГОСТ Р 52847-2007 "Автомобильные транспортные средства. Тормозные механизмы. Технические требования и методы стендовых испытаний"; Правила ЕЭК ООН N 26 "Единообразные предписания, касающиеся официального утверждения транспортных средств в отношении их наружных выступов".

СРОК ДЕЙСТВИЯ С 25.09.2018 ПО 24.09.2022 ВКЛЮЧИТЕЛЬНО

Руководитель (уполномоченное лицо) органа по сертификации

Эксперт (эксперт-аудитор) (эксперты (эксперты-аудиторы))

Игорь Олегович Ежов  
(инициалы, фамилия)Антон Васильевич Еремченко  
(инициалы, фамилия)



**SB5 TYPE**



**SB6 TYPE**



**SB7 AXIAL TYPE**



**ST7 TYPE**



**SB7 RADIAL TYPE**



**SK7 TYPE**



**SL7-SM7 TYPE**



**CALIPER CARRIER**



**SN5 TYPE**



**SN6 TYPE**



**SN7 TYPE**



**CALIPER CARRIER**



---

# KNORR

## BRAKE CALIPER REPAIR KITS



*You can follow our new products from our website.*



**5000 / Caliper Piston Tappet & Seals Repair Kit  
SN6 / SN7 / SK7 Type - Ø69 mm**

KNORR: K001300-K010603-K000366-K092079 / MB: 000 420 2382 - 000 420 4082 - 000 420 4982  
MAN: 81.50822.6020 - 81.50822.6031 / SCANIA: 1723417 - 2121858 - 2198394  
DAF: 1622785 - 1616894 - 1689313 / IVECO: 42541413 / 09.801.06.32.0 / SAF: 3 434 3814 00 / CKSK.4.2



**5001 / Caliper Piston Tappet Repair Kit - Ø69 mm  
SN6 / SN7 / SK7 Type**



**5002 / Caliper Piston Tappet Repair Kit - Ø69 mm  
SN6 / SN7 / SK7 Type**



**5003 / Caliper Piston Tappet & Seal Kit - Ø69 mm  
SN6 / SN7 / SK7 Type**



**5004 / Caliper Piston Tappet & Boot Set - Ø69 mm  
SN6 / SN7 / SK7 Type**



**5005 / Caliper Piston Tappet & Boot Set - Ø69 mm  
SN6 / SN7 / SK7 Type**





**5006 / Caliper Piston Tappet & Seals Repair Kit**

SB5 / SB6 / SB7 / SN6 / SN7 / SK7 / SB7 Radial Type - Ø74 mm

KNORR: K000944 - K010604 / MB: 000 420 0682 - 000 420 3982 - 000 420 4882 / MAN: 81.50822.6007 - 81.50822.6022 - 81.50822.6032 / SCANIA: 1743421 - 1746824 - 1756389 - 1759811 - 1723414 - 2121859 / DAF: 1448913 - 1623221 / IVECO: 93162050 / SAF: 3 434 3804 00 / CKSK.4



**5007 / Caliper Piston Tappet Repair Kit**

SB5 / SB6 / SB7 / SN6 / SN7 / SK7 / SB7 Radial Type - Ø74 mm

KNR: II179320065 - II304130065 / SCN: 1390429



**5008 / Caliper Piston Tappet Repair Kit**

SB5 / SB6 / SB7 / SN6 / SN7 / SK7 / SB7 Radial Type - Ø74 mm



**5009 / Caliper Piston Tappet & Seal Kit - Ø74 mm**

SB5 / SB6 / SB7 / SN6 / SN7 / SK7 / SB7 Radial Type - Ø74 mm



**5010 / Caliper Pin & Boot Set - Ø74 mm**

SB5 / SB6 / SB7 / SB7 Radial Type



**5011 / Caliper Pin & Boot Set - Ø74 mm**

SB5 / SB6 / SB7 / SB7 Radial Type





**5012 / Caliper Piston Tappet & Seal Kit - Ø69 mm  
SN5 Type**



**5013 / Caliper Piston Tappet Kit - Ø69 mm  
SN5 Type**

KNORR: K001929 / MB: 000 420 4282 / MAN: 81.50822.6027



**5014 / Caliper Complete Mechanism Repair Kit - Ø74 mm  
SB6 / SB7 Type**

5031 / Caliper Bridge Assembly



5038 / Calibration Bolt



5022 / Caliper Lever



5006 / Caliper Piston Tappet & Seals Kit



5027 / Caliper Pinion Shaft



5047 / Caliper Roller Bearing Set



5028 / Caliper Adjusting Mechanism



5039 / Caliper Calibration Shaft Chain  
29 Link





**5015 / Caliper Complete Mechanism Repair Kit - Ø74 mm  
SB6 / SB7 Type**

5031 / Caliper Bridge Assembly



5038 / Calibration Bolt



5025 / Caliper Lever



5006 / Caliper Piston Tappet & Seals Kit



5027 / Caliper Pinion Shaft



5047 / Caliper Roller Bearing Set



5028 / Caliper Adjusting Mechanism



5039 / Caliper Calibration Shaft Chain  
29 Link



**5016 / Caliper Complete Mechanism Repair Kit - Ø74 mm  
SB6 / SB7 Type**

5031 / Caliper Bridge Assembly



5038 / Calibration Bolt



5024 / Caliper Lever



5006 / Caliper Piston Tappet & Seals Kit



5027 / Caliper Pinion Shaft



5047 / Caliper Roller Bearing Set



5028 / Caliper Adjusting Mechanism



5039 / Caliper Calibration Shaft Chain  
29 Link





**5017 / Caliper Complete Mechanism Repair Kit - Ø69 mm  
SN6 / SN7 / SK7 Type**

5034 / Caliper Bridge Assembly



5038 / Calibration Bolt



5021 / Caliper Lever



5000 / Caliper Piston Tappet & Seals Kit  
Ø69 mm



5027 / Caliper Pinion Shaft



5046 / Caliper Roller Bearing Set



5028 / Caliper Adjusting Mechanism



5039 / Caliper Calibration Shaft Chain  
29 Link



**5018 / Caliper Complete Mechanism Repair Kit - Ø69 mm  
SN6 / SN7 / SK7 Type**

5034 / Caliper Bridge Assembly



5038 / Calibration Bolt



5023 / Caliper Lever



5000 / Caliper Piston Tappet & Seals Kit  
Ø69 mm



5027 / Caliper Pinion Shaft



5046 / Caliper Roller Bearing Set



5028 / Caliper Adjusting Mechanism



5039 / Caliper Calibration Shaft Chain  
29 Link





**5019 / Caliper Complete Mechanism Repair Kit - Ø69 mm  
SN6 / SN7 / SK7 Type**

5034 / Caliper Bridge Assembly



5038 / Calibration Bolt



5099 / Caliper Lever



5000 / Caliper Piston Tappet & Seals Kit  
Ø69 mm



5027 / Caliper Pinion Shaft



5046 / Caliper Roller Bearing Set



5028 / Caliper Adjusting Mechanism



5039 / Caliper Calibration Shaft Chain  
29 Link



**5020 / Caliper Complete Mechanism Repair Kit - Ø69 mm  
SN6 / SN7 / SK7 Type**

5037 / Caliper Bridge Assembly



5038 / Calibration Bolt



5026 / Caliper Lever



5000 / Caliper Piston Tappet & Seals Kit  
Ø69 mm



5027 / Caliper Pinion Shaft



5046 / Caliper Roller Bearing Set



5028 / Caliper Adjusting Mechanism



5039 / Caliper Calibration Shaft Chain  
29 Link





**5021 / Caliper Lever  
SN6 / SN7 / SK7 Type**

KNR:Z002881



**5022 / Caliper Lever  
SB6 / SB7 Type**

KNR: C73158



**5023 / Caliper Lever  
SN6 / SN7 / SK7 Type**

KNR:Z002965 / CKSK18.3



**5024 / Caliper Lever  
SB6 / SB7 Type**

CKSK.18.1



**5025 / Caliper Lever  
SB6 / SB7 Type**

CKSK.18



**5026 / Caliper Lever  
SN6 / SN7 / SK7 / SL7 / SM7 / ST7 Type**

KNR: Z002962



**5027 / Caliper Adjusting Shaft (With Spring)  
SB6 / SB7 / SN6 / SN7 / SK7 / SL7 / SM7 / ST7 / SB7 Radial Type**

CKSK.10.1



**5028 / Caliper Adjusting Mechanism  
SB6 / SB7 / SN6 / SN7 / SK7 / SL7 / SM7 / ST7 / SB7 Radial Type**

CKSK.10.4





**5029 / Caliper Bridge Assembly**  
SB6 / SB7 / SB7 Radial Type



**5031 / Caliper Bridge Assembly**  
SB6 / SB7 / SB7 Radial Type



5029 / Caliper Bridge Assembly

**5030 / Caliper Bridge Assembly**  
SB6 / SB7 / SB7 Radial  
CKSK.17



5029 / Caliper Bridge Assembly

5048 / Lever Bearing

5038 / Calibration Bolt

**5032 / Caliper Bridge Assembly**  
SN6 / SN7 / SK7 Type



**5034 / Caliper Bridge Assembly**  
SN6 / SN7 / SK7 Type



5032 / Caliper Bridge Assembly

**5033 / Caliper Bridge Assembly**  
SN6 / SN7 / SK7 Type  
CKSK.17.1



5032 / Caliper Bridge Assembly

5048 / Lever Bearing

5038 / Calibration Bolt



**5035 / Caliper Bridge Assembly**  
SN6 / SN7 / SK7 / SL7 / SM7 / ST7 Type



**5037 / Caliper Bridge Assembly**  
SN6 / SN7 / SK7 / SL7 / SM7 / ST7 Type



5035 / Caliper Bridge Assembly

0505 / Spring

**5036 / Caliper Bridge Assembly**  
SN6 / SN7 / SK7 Type



5035 / Caliper Bridge Assembly



0505 / Spring



5038 / Calibration Bolt

**5038 / Caliper Calibration Bolt**  
SB5 / SB6 / SB7 / SN5 / SN6 / SN7 / SK7 / SB7 Radial Type



**5039 / Caliper Calibration Shaft Chain ( Long )**  
SB6 / SB7 / SN6 / SN7 / SK7 / SL7 / SM7 / ST7 / SB7 Radial Type

29 Link  
CKSK.11



**5040 / Caliper Adjusting Mechanism**  
SN5 Type  
CKSK.10.5



**5041 / Caliper Calibration Shaft Chain 14 Link**  
SN5 Type



14 Links



**5042 / Caliper Mechanism Gear**

SB6 / SB7 / SN6 / SN7 / SK7 / SL7 / SM7 / ST7 / SB7 Radial Type  
CKSK.11.1



**5043 / Caliper Pinion Shaft  
SN5 Type**



**5044 / Caliper Bridge Assembly  
SN5 Type**



0115 / Shaft Housing



0106 / Spring

**5045 / Caliper Bridge Assembly  
SB5 Type**



0104 / Shaft Housing



0106 / Spring

**5046 / Caliper Roller Bearing Set  
SB6 / SB7 / SN6 / SN7 / SK7 / SB7 Radial Type**  
CKSK.14.1



0908 / Roller Bearing

**5047 / Caliper Roller Bearing Set  
SB5 / SB6 / SB7 / SN6 / SN7 / SK7 / SB7 Radial Type**  
CKSK.14



0909 / Roller Bearing

**5048 / Caliper Lever Bearing  
SB6 / SB7 / SN6 / SN7 / SK7 / SB7 Radial Type**  
CKSK.15



**5049 / Adjusting Mechanism Adapter  
SB6 / SB7 / SN6 / SN7 / SK7 / SB7 Radial Type**





**5050 / Caliper Pin Repair Kit**  
**SB6 / SB7 / SB7 Radial Type**  
KNORR:K010813 / MAN:81.50822.6033



**5051 / Caliper Plastic Cover (Without Sensor)**  
**SB6 / SB7 / SN6 / SN7 / SK7 / SL7 / SM7 / ST7 Type**  
CKSK.16.1



**5052 / Caliper Sensor Cover (2 Cables Sensor)**  
**SB6 / SB7 / SN6 / SN7 / SK7 / SL7 / SM7 / ST7 Type**

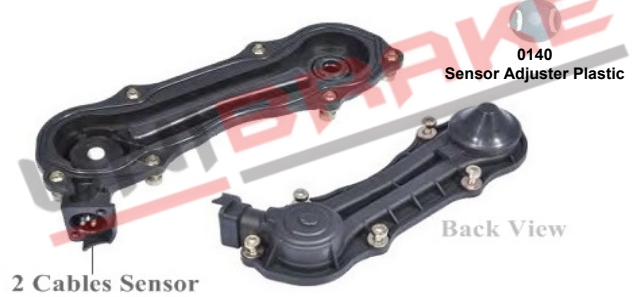

**5053 / Caliper Sensor Cover (3 Cables Sensor)**  
**SB6 / SB7 / SN6 / SN7 / SK7 / SL7 / SM7 / ST7 Type / MERCEDES**



**5054 / Caliper Pin Repair Kit**  
**SB5 / SB6 / SB7 / SB7 Radial Type**

KNR: II369100062 - II339680062 / MB: 000 420 1282 / MN: 81.50822.6009 / SCN: 1390427 - 2121643 / DF: 1142142 - 1198153 - 1198154 - 1448915 / IVC: 93162048 / NPLN: 11015565





**5055 / Caliper Pin Repair Kit  
SB5 / SB6 / SB7 / SB7 Radial Type**

KNR: K000935 / SF: 3 434 3802 00



**5056 / Caliper Pin Repair Kit  
SN6 / SN7 / SK7 Type**

KNORR: K052759K50

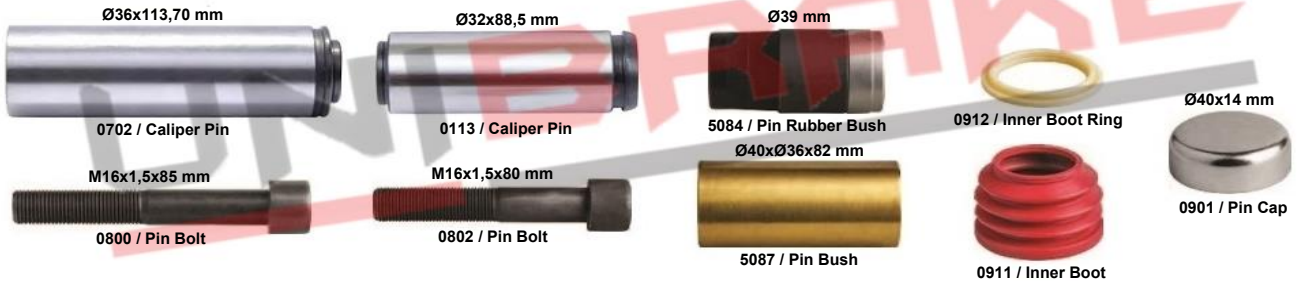

**5057 / Caliper Pin Repair Kit  
SB6 / SB7 / SB7 Radial Type**

KNR: K000132 / MB: 000 420 1082 - 000 420 2182 / SCN: 1390426 - 1798063 - 2121644

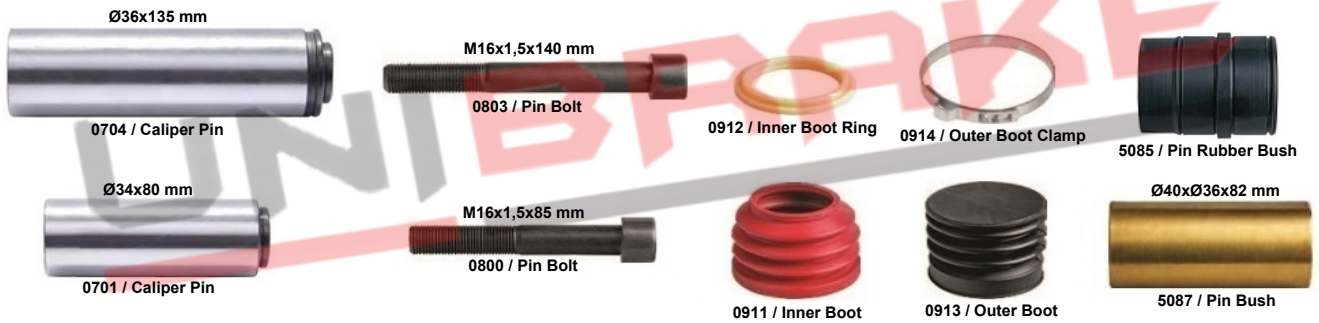

**5058 / Caliper Short Pin Repair Kit  
SB5 / SB6 / SB7 / SB7 Radial Type**

KNR: II368470064 / SCN: 2121840 / DF: 1448910 / SF: 3 434 3801 00



**5059 / Caliper Pin Repair Kit  
SB6 / SB7 / SB7 Radial Type**



**5060 / Caliper Pin Repair Kit  
SB6 / SB7 / SB7 Radial Type**



**5061 / Caliper Pin Repair Kit  
SB6 / SB7 / SN6 / SN7 / SK7 / SL7 / SM7 / ST7 Type**

**KNR:** K001915 - K048389K50 / **MB:** 000 420 4682 / **MN:** 81.50822.6034 - 81.50822.6037 / **SCN:** 1477675 - 1527631 - 2121646 / **DF:** 1639100



**5062 / Caliper Pin Boot  
SB5/SB6/SB7/SN6/SN7/SK7/SL7/SM7/ST7/SB7 Radial Type**

**KNR:** K019508 / **BV:** 02.1011.24.00 - 09.801.06.34.0



**5063 / Caliper Lever  
SN6 / SN7 / SK7 Type**





**5065 / Caliper Complete Mechanism Repair Kit - Ø69 mm  
SN6 / SN7 / SK7 Type**

5037 / Caliper Bridge Assembly



5038 / Calibration Bolt



5063 / Caliper Lever



5000 / Caliper Piston Tappet & Seals Kit  
Ø69 mm



5027 / Caliper Pinion Shaft



5046 / Caliper Roller Bearing Set



5028 / Caliper Adjusting Mechanism



5039 / Caliper Calibration Shaft Chain



**5064 / Caliper Pin Repair Kit  
SN6 / SN7 / SK7 / SL7 / SM7 / ST7 Type**



**5066 / Caliper Short Pin Repair Kit  
SN6 / SN7 / SK7 / SL7 / SM7 / ST7 Type**



**5067 / Caliper Pin Repair Kit  
SB6 / SB7 / SN6 / SN7 / SK7 / SB7 Radial Type**

KNR: K001532 / SCN: 1472919 / B: 09.801.06.31.0



**5068 / Caliper Pin Repair Kit  
SN6 / SN7 / SK7 Type**

KNORR: K000472 - K017707 / MAN: 81.50822.6019 - 81.50822.6034 / SCANIA: 1527631 - 1477675 / IVECO: 42541412 / B: 09.801.06.33.0 / SAF: 3 434 3812 00 / MERCEDES: 000 420 3482 / CKSK.3.2

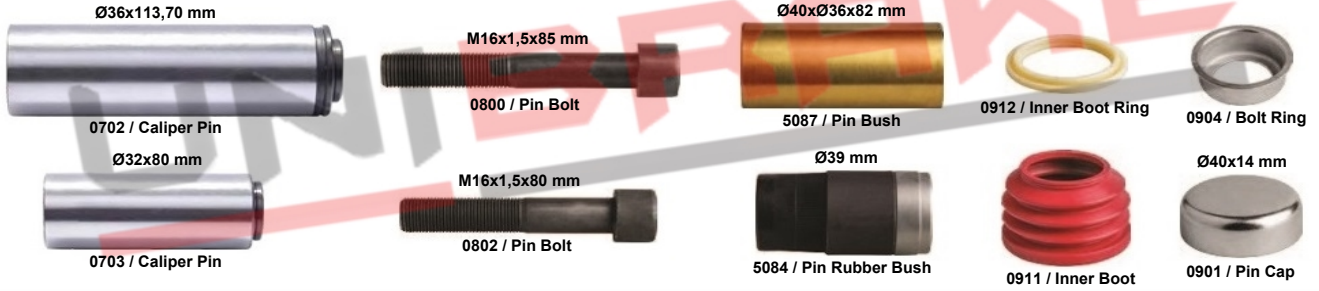

**5069 / Caliper Short Pin Repair Kit  
SB5 / SB6 / SB7 / SN6 / SN7 / SK7 Type**

KNR: K000698 / BV: 09.801.06.91.0 / SAF: 3 434 3813 00 / CKSK.13.5



**5071 / Caliper Pin Rubber Bush (Short - Ø39 mm)  
SB6 / SB7 / SN6 / SN7 / SK7 / SL7 / SM7 / ST7 / SB7 Radial Type**

KNR: K000698 / BV: 09.801.06.91.0 / SAF: 3 434 3813 00 / CKSK.13.5



**5070 / Caliper Pin Repair Kit  
SB6 / SB7 / SB7 Radial Type**

KNR: K000696 - II310370066 / MB: 002 420 0383 / SF: 3 434 3805 00



**5072 / Caliper Pin Repair Kit  
SB6 / SB7 / SN6 / SN7 / SK7 / SB7 Radial Type**

KNORR: K000365 / MERCEDES: 000 420 0782 - 000 420 2282





**5074 / Caliper Pin Repair Kit  
SN5 Type**

KNORR: K001928 / MAN: 81.50822.6026 / 000 420 4182 / SCANIA: 2121650



**5075 / Caliper Pin Repair Kit  
SN6 / SN7 / SK7 Type**

KNORR: K004100 - K010766 - K004168 / MB: 000 420 5082 / SAF: 3 434 3815 00 / SCANIA: 1748131 - 2121647 - 2198395 / 1008450 / 803114  
HNDRCXSN: S-29152-9 / MODEL: ADB22X



**5073 Caliper Pin Rubber Bush (Ø35 mm)  
SB6 / SB7 / SN6 / SN7 / SK7 / SB7 Radial Type**



**5076 / Caliper Short Pin Repair Kit  
SN6 / SN7 / SK7 Type**



**5077 / Caliper Cap Set  
SB5 / SB6 / SB7 / SB7 Radial Type**

KNR: K001301 / MN: 81.50822.6025 / SCN: 1439494 - 2121839







**5086 / Caliper Pin Bellow Cap**  
SB5 / SB6 / SB7 / SB7 Radial Type  
KNORR: II350470063



0913 / Outer Boot



0914 / Outer Boot Clamp

**5087 / Caliper Pin Bush**  
SB5/SB6/SB7/SN6/SN7/SK7/SL7/SM7/ST7/SB7 Radial Type

Ø40xØ36x82 mm



**5088 / Caliper Pinion Shaft**  
SB5 Type  
CKSK.10.8



**5089 / Caliper Calibration Shaft Chain**  
SB5 Type  
CKSK.12



12 Links

**5090 / Caliper Pin Repair Kit**  
SB6 / SB7 / SB7 Radial Type  
KNR: K000687 / DF: 1603326

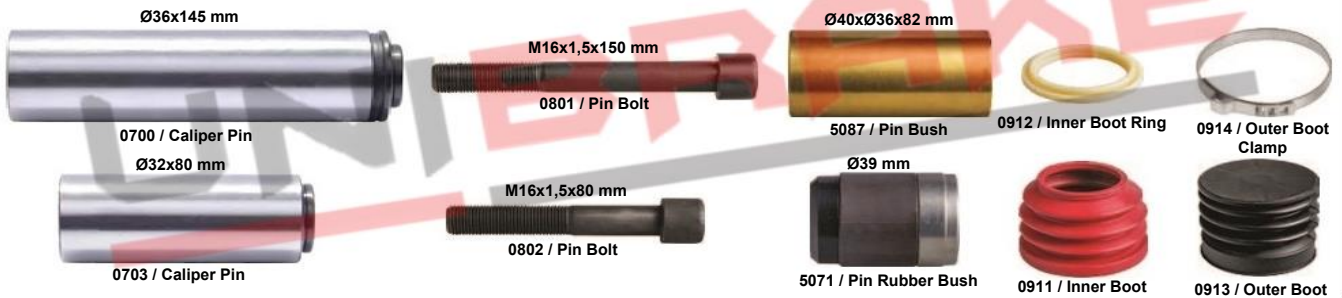

**5091 / Caliper Pin Boot & Cap Set**  
SB5 / SB6 / SB7 / SB7 Radial Type  
KNR: II350470061 / MB: 001 420 6683 / MN: 81.50822.6005



**5092 / Caliper Short Pin Repair Kit**  
SB5 / SB6 / SB7 / SB7 Radial Type  
CKSK.13.3



**5093 / Caliper Short Pin Repair Kit**  
**SB5 / SB6 / SB7 / SN6 / SN7 / SK7 / SB7 Radial Type**  
KNR: K000697



**5094 / Caliper Pin Repair Kit**  
**SB6 / SB7 / SB7 Radial Type**  
KNR: I139769F0062 / SCN: 2121645 / IVC: 42537451



**5095 / Caliper Adjusting Mechanism Adapter Kit**  
**SB6 / SB7 / SN6 / SN7 / SK7 / SB7 Radial Type**  
KNR: Z001548 / HNDRCKSN: S-29152-5



**5096 / Caliper Lever**  
**SN6 / SN7 / SK7 Type**



**5097 / Caliper Cap Set**  
**SB6 / SB7 / SN6 / SN7 / SK7 / SL7 / SM7 / ST7 Type**  
KNORR:K000945 / MAN 81.50822.6024 / SCN: 2121868 / DF:1439493 / SF: 8 531 7002 500 / CKSK.7





**5098 / Caliper Complete Mechanism Repair Kit - Ø69 mm  
SL7 / SM7 / ST7 Type**

**5037 / Caliper Bridge Assembly**



**5117 / Calibration Bolt**



**5120 / Caliper Lever**



**5118 / Caliper Piston Tappet & Seals Kit  
Ø69 mm**



**5121 / Caliper Pinion Shaft**



**5119 / Caliper Roller Bearing Set**



**5028 / Caliper Adjusting Mechanism**



**5039 / Caliper Calibration Shaft Chain  
29 Link**



**5099 / Caliper Lever  
SN6 / SN7 / SK7 Type  
CKSK.18.2**



**5100 / Caliper Lever  
SB5 Type**



**5101 / Caliper Lever  
SB7 Radial Type**

KNORR: K100259 - K000250 / SCANIA: 1480809 - 1480810



**5102 / Caliper Cover Set  
SN6 / SN7 / SK7 Type  
CKSK.22**



**0119 / Caliper Cover**

M8x16 mm



**0120 / Bolt**

**5103 / Caliper Roller Bearing Set  
SN5 Type**



0910 / Roller Bearing

**5104 / Caliper Lever  
SN5 Type**



Back View

**5105 / Caliper Pin Repair Kit  
SB6 / SB7 / SB7 Radial Type**

KNR: II179320062 / MB: 050 121 0167 / DF: B230397

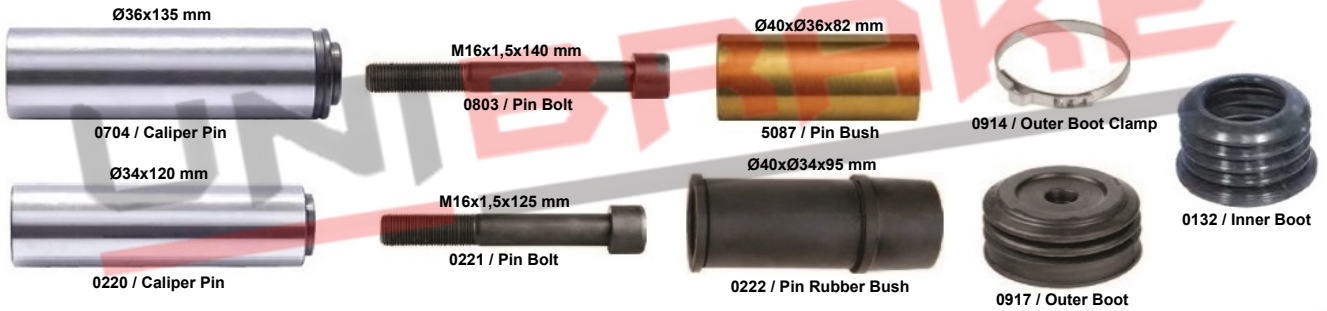

**5106 / Caliper Pin Repair Kit  
SB6 / SB7 / SB7 Radial Type**

KNR: II358510062 / MB: 000 420 1182 - 050 121 1047 / SCN: 1415149 - 1415154 - 1415515

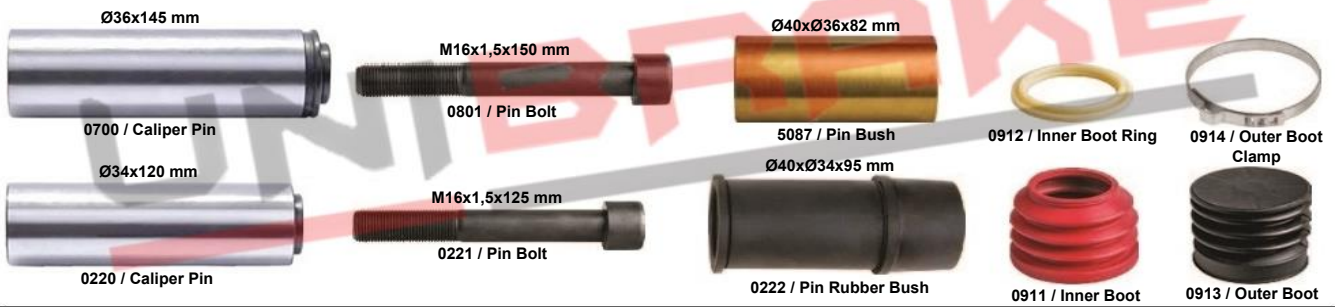

**5107 / Caliper Pin Repair Kit  
SB6 / SB7 / SB7 Radial Type**

KNORR: II197330062





**5108 / Caliper Pin Repair Kit  
SB6 / SB7 Type**

KNORR: II197140062 / MAN: 81.50822.6006



**5109 / Caliper Pin Bellow Cap  
SB6 / SB7 / SB7 Radial Type**

KNORR: II344730063 / MAN: 81.50822.6010 / DAF: 1448600



**5110 / Caliper Cap  
SB6 / SB7 Type**

KNORR: II197140063



**5111 / Caliper Pin Repair Kit  
SB5 Type**

KNR: K001274 - K002716



**5112 / Caliper Bellow Kit  
KNORR BENDIX**

KNORR: 381.413 / IVECO: 93161192 / ADB: 3700 - 4300







**5120 / Caliper Lever**  
SL7 / SM7 / ST7 Type



**5121 / Caliper Pinion Shaft**  
SB6 / SB7 / SN6 / SN7 / SK7 / SL7 / SM7 / ST7 Type



**5122 / Caliper Piston Tappet Set**  
SL7 / SM7 / ST7 Type



**5123 / Caliper Piston Tappet**  
SL7 / SM7 / ST7 Type



**5124 / Caliper Piston Tappet & Seal Kit**  
SL7 / SM7 / ST7 Type



**5126 / Caliper Cover Set**  
SN6 / SN7 / SK7 / SL7 / SM7 / ST7 Type



**5125 / Caliper Bridge Assembly**  
SL7 / SM7 / ST7 Type



**5127 / Caliper Complete Repair Kit 12-160 MAN  
SB5 Type / KNORR SET**

5045 / Caliper Bridge Assembly



5038 / Calibration Bolt



5047 / Roller Bearing Set



5054 / Caliper Pin Repair Kit



5182 / Adjusting Mechanism Shaft



5088 / Pinion Shaft



5009 / Caliper Piston Tappet & Seal Kit - 74 mm



5080 / Pin Cap



5089 / Caliper Shaft Chain  
12 Links



**5128 / Caliper Complete Repair Kit 12-180 TGL MAN  
SN5 Type / KNORR SET**

5044 / Caliper Bridge Assembly



5038 / Calibration Bolt



5103 / Roller Bearing



5074 / Caliper Pin Repair Kit



5040 / Adjusting Mechanism Shaft



5043 / Pinion Shaft



5114 / Caliper Cover Set



5013 / Caliper Piston Tappet



5041 / Caliper Shaft Chain  
14 Links





**5129 / Caliper Complete Repair Kit ACTROS B OLD MODEL SET  
SN6 / SN7 / SK7 Type / KNORR SET**

5036 / Caliper Bridge Assembly



5102 / Caliper Cover Set



5067 / Caliper Pin Repair Kit



5047 / Roller Bearing Set



5000 / Caliper Piston Tappet & Seals Kit  
Ø69 mm



5028 / Adjusting Mechanism Shaft



5039 / Caliper Shaft Chain  
29 Link



5027 / Pinion Shaft



**5130 / Caliper Complete Repair Kit ACTROS B NEW MODEL SET  
SN6 / SN7 / SK7 Type / KNORR SET**

5034 / Caliper Bridge Assembly



5038 / Calibration Bolt



5102 / Caliper Cover Set



5068 / Caliper Pin Repair Kit



5046 / Roller Bearing Set



5000 / Caliper Piston Tappet & Seals Kit  
Ø69 mm



5028 / Adjusting Mechanism Shaft



5039 / Caliper Shaft Chain  
29 Link



5027 / Pinion Shaft



**5131 / Caliper Complete Repair Kit AXOR OLD MODEL SET  
SB6 / SB7 Type / KNORR SET**

5031 / Caliper Bridge Assembly



5038 / Calibration Bolt



5006 / Caliper Piston Tappet & Seals Kit  
Ø74 mm



5061 / Caliper Pin Repair Kit



5046 / Roller Bearing Set



5028 / Adjusting Mechanism Shaft



5039 / Caliper Shaft Chain  
29 Link



5027 / Pinion Shaft



**5132 / Caliper Complete Repair Kit AXOR NEW MODEL SET  
SN6 / SN7 / SK7 Type / KNORR SET**

5034 / Caliper Bridge Assembly



5038 / Calibration Bolt



5006 / Caliper Piston Tappet & Seals Kit  
Ø74 mm



5061 / Caliper Pin Repair Kit



5046 / Roller Bearing Set



5028 / Adjusting Mechanism Shaft



5039 / Caliper Shaft Chain  
29 Link



5027 / Pinion Shaft





**5133 / Caliper Complete Repair Kit MAN TGA NEW MODEL SET  
SB6 / SB7 Type / KNORR SET**

5031 / Caliper Bridge Assembly



5038 / Calibration Bolt



5006 / Caliper Piston Tappet & Seals Kit  
Ø74 mm



5061 / Caliper Pin Repair Kit



5047 / Roller Bearing Set



5028 / Adjusting Mechanism Shaft



5039 / Caliper Shaft Chain  
29 Link



5027 / Pinion Shaft



**5134 / Caliper Complete Repair Kit SCANIA SET  
SN6 / SN7 / SK7 Type / KNORR SET**

5037 / Caliper Bridge Assembly



5038 / Calibration Bolt



5102 / Caliper Cover Set



5075 / Caliper Pin Repair Kit



5047 / Roller Bearing Set



5000 / Caliper Piston Tappet & Seals Kit  
Ø69 mm



5028 / Adjusting Mechanism Shaft



5039 / Caliper Shaft Chain  
29 Link



5027 / Pinion Shaft



**5135 / Caliper Complete Repair Kit AXOR NEW MODEL SET  
SL7 / SM7 / ST7 Type**

**5037 / Caliper Bridge Assembly**



**5117 / Calibration Bolt**



**5126 / Caliper Cover Set**



**5061 / Caliper Pin Repair Kit**



**5119 / Roller Bearing Set**



**5118 / Caliper Piston Tappet & Seals Kit  
Ø69 mm**



**5028 / Adjusting Mechanism Shaft**



**5039 / Caliper Shaft Chain  
29 Link**



**5121 / Pinion Shaft**



**5136 / Caliper Sensor Cover (3 Cables Sensor)  
SN5 Type / MERCEDES**



0139 / Sensor Adjuster Plastic

**5136-1 / Caliper Sensor Cover (3 Cables Sensor)  
SN5 Type / 12-180 MAN TGL**



0139 / Sensor Adjuster Plastic

**5137 / Caliper Sensor Cover (2 Cables Sensor)  
SN5 Type**



0139 / Sensor Adjuster Plastic

**5138 / Caliper Plastic Cover (Without Sensor)  
SN5 Type**



Without Sensor



**5139 / Caliper Sensor Cover (3 Cables Sensor)  
SB5 Type / MERCEDES**



**5139-1 / Caliper Sensor Cover (3 Cables Sensor)  
SB5 Type / 12-160 MAN TGL**



**5140 / Caliper Sensor Cover (2 Cables Sensor)  
SB5 Type**



**5141 / Caliper Plastic Cover (Without Sensor)  
SB5 Type**



**5142 / Caliper Pin Repair Kit  
SB6 / SB7 / SB7 Radial Type**

KNR: K000375 / MB: 000 420 2982 / MN: 81.50822.6023 / IVC: 42538002 / B: 09.801.06.24.0



**5143 / Caliper Short Pin Repair Kit  
SN6 / SN7 / SK7 Type**



**5144 / Caliper Short Pin Repair Kit  
SN6 / SN7 / SK7 Type**







**5152 / Caliper Complete Mechanism Repair Kit  
SB6 / SB7 Type**

**5031 / Caliper Bridge Assembly**



**5038 / Calibration Bolt**



**5153 / Caliper Lever**



**5006 / Caliper Piston Tappet & Seals Kit  
Ø74 mm**



**5027 / Pinion Shaft**



**5047 / Roller Bearing Set**



**5028 / Adjusting Mechanism Shaft**



**5039 / Caliper Shaft Chain  
29 Link**



**5153 / Caliper Lever  
SB6 / SB7 Type**



**5154 / Caliper Lever Support  
SB5 / SB6 / SB7 / SB7 Radial Type**



0109 / Lever Support

**5155 / Caliper Caps Kit  
SB5/SB6/SB7/SN5/SN6/SN7/SK7/SL7/SM7/ST7 Type  
CKSK.3.4**



0112 / Cap

**5156 / Caliper Pad Retainer Repair Kit  
SN5 / SB5 / SB6 / SB7 / SN6 / SN7 / SK7 / SB7 Radial Type**



**5157 / Caliper Complete Mechanism Repair Set  
SN6 / SN7 / SK7 Type**

5037 / Caliper Bridge Assembly



5038 / Calibration Bolt



5096 / Caliper Lever



5000 / Caliper Piston Tappet & Seals Kit  
Ø69 mm



5027 / Pinion Shaft



5046 / Roller Bearing Set



5028 / Adjusting Mechanism



5039 / Caliper Shaft Chain  
29 Link



**5158 / Caliper Short Pin Repair Kit  
SB6 / SB7 / SN6 / SN7 / SK7 / SL7 / SM7 / ST7 / SB7 Radial Type**

Ø32x80 mm



0703 / Caliper Pin

M16x1,5x80 mm



0802 / Pin Bolt

Ø39 mm



5071 / Pin Rubber Bush

**5159 / Caliper Pin Repair Kit  
SB6 / SB7 / SB7 Radial Type**

KNORR: K048371K50 / MAN: 81.50822.6036 / SCANIA: 2121648

Ø36x113,70 mm



0702 / Caliper Pin

M16x1,5x85 mm



0800 / Pin Bolt

0912 / Inner Boot Ring

0915 / O-ring

Ø39 mm



5071 / Pin Rubber Bush

Ø32x80 mm



0703 / Caliper Pin

M16x1,5x80 mm



0802 / Pin Bolt

0911 / Inner Boot

0916 / Pin Cap

Ø40xØ36x82 mm



5087 / Pin Bush



**5160 / Caliper Pin & Pad Retainer Repair Kit  
SN6 / SN7 / SK7 Type**



**5161 / Caliper Cap Set  
SB6 / SB7 / SN6 / SN7 / SK7 Type**



**5162 / Caliper Sensor Cover (3 Cables Sensor)  
SB7 Radial Type**



**5163 / Caliper Sensor Cover (2 Cables Sensor)  
SB7 Radial Type**



**5164 / Caliper Plastic Cover (Without Sensor)  
SB7 Radial Type**



**5165 / Caliper Sensor Cover (3 Cables Sensor)  
SB7 Radial Type**



**5166 / Caliper Sensor Cover (2 Cables Sensor)  
SB7 Radial Type**



**5167 / Caliper Plastic Cover (Without Sensor)  
SB7 Radial Type**



**5168 / Caliper Sensor Cover (3 Cables Sensor)  
SB6 / SB7 / SN6 / SN7 / SK7 Type**



**5169 / Caliper Sensor Cover (2 Cables Sensor)  
SB6 / SB7 / SN6 / SN7 / SK7 Type**



**5170 / Caliper Pin Repair Kit  
SB6 / SB7 / SN6 / SN7 / SK7 / SB7 Radial Type**

KNORR: K067417K50 / SAF: 3 434 3820 00 / SCANIA: 2064260 - 2292232



**5171 / Caliper Seal Kit - Ø45 mm  
SN6 / SN7 / SK7 Type**



**5172 / Caliper Seal Kit - Ø42 mm  
SN6 / SN7 / SK7 Type**





**5173 / Caliper Pin Repair Kit  
SB6 / SB7 Type**

KNORR: K048396K50 / SCANIA: 2121641

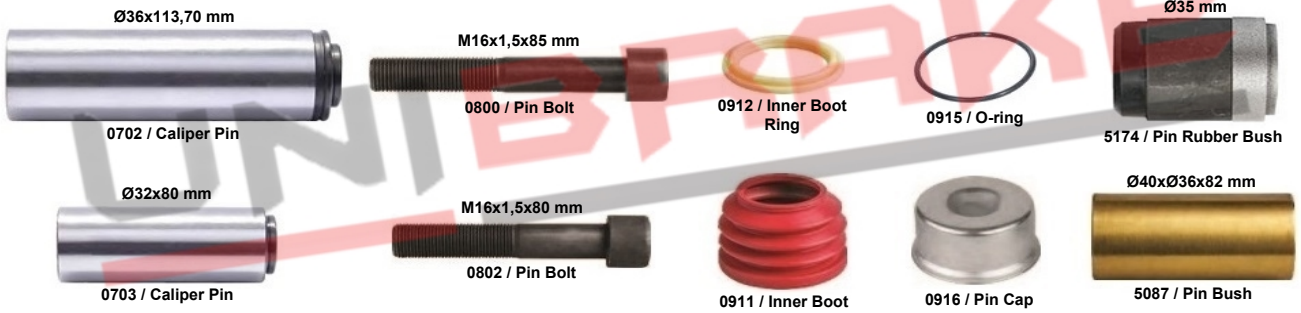

**5174 / Caliper Pin Rubber Bush (Short - Ø35 mm)  
SB6 / SB7 Type**



**5175 / Caliper Adjusting Mechanism  
(With Spring - New Type)  
SB6 / SB7 / SN6 / SN7 / SK7 / SL7 / SM7 / ST7 Type**



**5176 / Caliper Calibration Mechanism Set  
SB6 / SB7 / SN6 / SN7 / SK7 / SL7 / SM7 / ST7 / SB7 Radial Type**



**5177 / Caliper Cover Bolt Kit  
SB5 / SB6 / SB7 / SB7 Radial Type**



**5178 / Caliper Cover Bolt Kit  
SB5 / SB6 / SB7 / SB7 Radial Type**



**5179 / Caliper Cover Bolt Kit  
SB5 / SB6 / SB7 / SB7 Radial Type**



**5180 / Caliper Adjusting Mechanism Shaft**  
SB6/SB7/SN6/SN7/SK7/SL7/SM7/ST7/SB7 Radial Type  
CKSK.10.3



**5182 / Caliper Adjusting Mechanism Shaft**  
SB5 Type



**5181 / Caliper Pin Repair Kit**  
SB6 / SB7 / SB7 Radial Type

KNR: 11328090062 / SCN: 2121642 / B: 09.801.02.58.0 - 09.801.02.88.0 / SF: 8 531 7002 100 - 8 531 7002 200



**5183 / Caliper Complete Mechanism Repair Kit**  
SL7 / SM7 / ST7 Type





**5185 / Caliper Pin Repair Kit  
SL7 / SM7 / ST7 Type**

KNORR: K108002K50 - K108002K64 - K108002K62 / SCHMITZ: 1227598 / SAF: 3 434 3824 00

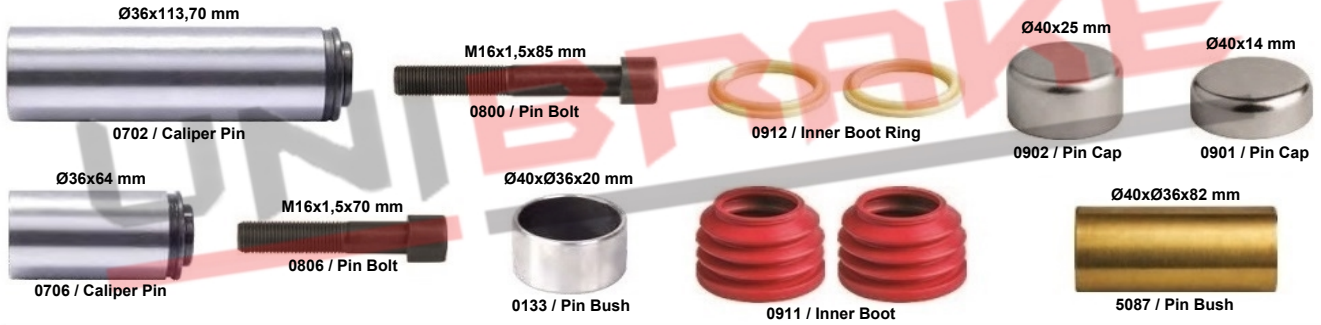

**5184 / Caliper Piston Tappet & Seal Kit  
SN5 Type**



**5186 / Caliper Cap Set  
SB5/SB6/SB7/SL7/SM7/ST7/SN6/SN7/SK7/SB7 Radial Type**



**5187 / Caliper Cap Set**

SB5/SB6/SB7/SL7/SM7/ST7/SN6/SN7/SK7/SB7 Radial Type



**5188 / Caliper Lever  
SL7 / SM7 / ST7 Type**



**5189 / Caliper Adjusting Mechanism  
SL7 / SM7 / ST7 Type**



**5190 / Caliper Adjusting Mechanism  
SN5 Type**



**5191 / Caliper Lever**  
SB6 / SB7 Type  
C73164



**5192 / Sensor Adjuster Plastic Kit**  
SB5 / SN5 Type



0139  
Sensor Adjuster Plastic

**5193 / Caliper Plastic Cover**  
SB6 / SB7 / SN6 / SN7 / SK7 / SL7 / SM7 / ST7 Type



**5194 / Caliper Repair Kit**  
SB6 / SB7 Type  
KNORR: K000421



**5195 / Caliper Repair Kit**  
SB6 / SB7 Type





**5196 / Caliper Complete Mechanism Repair Kit  
SB7 Radial Type**

**5031 / Caliper Bridge Assembly**



**5038 / Calibration Bolt**



**5101 / Caliper Lever**



**5006 / Caliper Piston Tappet & Seals Kit  
Ø74 mm**



**5027 / Pinion Shaft**



**5047 / Roller Bearing Set**



**5028 / Adjusting Mechanism**



**5039 / Caliper Shaft Chain - 29 Link**



**5196-1 / Caliper Complete Mechanism Repair Kit  
SB7 Radial Type**

**5031 / Caliper Bridge Assembly**



**5038 / Calibration Bolt**



**5147 / Caliper Lever**

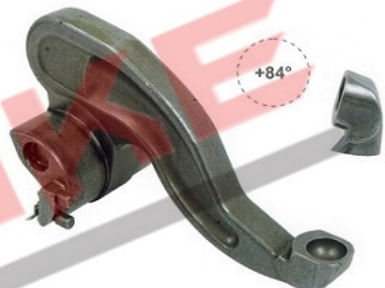

**5006 / Caliper Piston Tappet & Seals Kit  
Ø74 mm**



**5027 / Pinion Shaft**



**5047 / Roller Bearing Set**



**5028 / Adjusting Mechanism**



**5039 / Caliper Shaft Chain - 29 Link**



**5197 / Caliper Complete Mechanism Repair Kit  
SB6 / SB7 Type**

**5031 / Caliper Bridge Assembly**



**5038 / Calibration Bolt**



**5191 / Caliper Lever**



**5006 / Caliper Piston Tappet & Seals Kit  
Ø74 mm**



**5027 / Pinion Shaft**



**5047 / Roller Bearing Set**



**5028 / Adjusting Mechanism**



**5039 / Caliper Shaft Chain - 29 Link**



**5198 / Brake Pad Retainer Repair Kit  
SB6 / SB7 Type  
K000946**



**5199 / Brake Pad Retainer Repair Kit  
SB6 / SB7 Type**



0134 / Brake Pad Retainer

**5200 / Brake Pad Retainer Repair Kit  
SB6 / SB7 Type**



0145 / Brake Pad Retainer

**5201 / Brake Pad Retainer Repair Kit  
SB6 / SB7 Type**



0145 / Brake Pad Retainer



**5202 / Brake Pad Retainer Repair Kit**  
SB6 / SB7 / SN6 / SN7 / SK7 Type



**5203 / Brake Pad Retainer Repair Kit**  
SB6 / SB7 / SN6 / SN7 / SK7 / SL7 / SM7 / ST7 / SB7 Radial Type



**5204 / Brake Pad Retainer Repair Kit**

**SB6 / SB7 / SN6 / SN7 / SK7 / SL7 / SM7 / ST7 / SB7 Radial Type**

**KNORR:** K000129 - II19712004 - II30679004 - II197120061 / **MB:** 050 121 1049 - 627 420 0188 / **DAF:** 1448911 / **MAN:** 36.50822.6001 - 36.50822.6005 -  
**RENAULT:** 5021 175 165 / **IVECO:** 42538004 - 97131548 / **B:** 09.801.02.66.0 - 09.801.02.76.0 / **SCHMITZ:** 015420 - **FRUEHAUF:** M100969 - M91000201  
**SAF:** 3 434 3807 00 - 3 434 3809 00 - 5 317 0026 00 - 8 531 7002 600



**5205 / Caliper Pin Repair Kit**  
SN6 / SN7 / SK7 Type

**KNORR:** K001925 - K028451 - **MB:** 000 420 4382

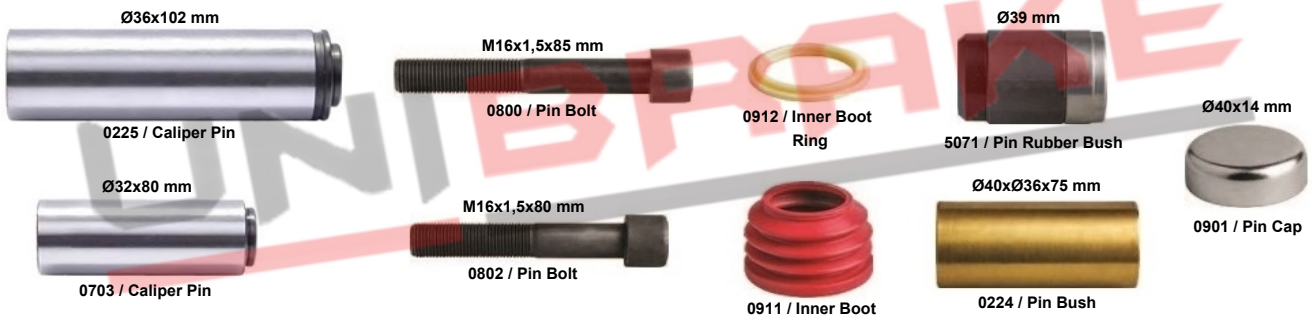

**5206 / Caliper Pin Repair Kit**  
SN6 / SN7 / SK7 Type

**KNORR:** K002872



**5207 / Caliper Pin Repair Kit**  
SN6 / SN7 / SK7 Type  
KNORR: K001691



**5208 / Caliper Pin Repair Kit**  
SN6 / SN7 / SK7 Type  
KNORR: K001692



**5209 / Caliper Cap Kit**  
SN6 / SN7 / SK7 Type



**5210 / Caliper Cap Kit**  
SN6 / SN7 / SK7 Type



**5211 / Caliper Piston Tappet & Seals Kit Ø69 mm**  
SN6 / SN7 / SK7 Type





**5212 / Caliper Pin & Pad Retainer Repair Kit**  
SL7 / SM7 / ST7 Type

KNORR: K012912



**5213 / Caliper Complete Mechanism Repair Kit**  
SL7 / SM7 / ST7 Type



**5214 / Caliper Pin Repair Kit**  
SB6 / SB7 / SN6 / SN7 / SK7 Type

KNORR: K105599K55 / SCANIA: 2286677



**5215 / Caliper Pin Repair Kit**  
SB6 / SB7 / SB7 Radial Type

KNR: 11339830064



**5216 / Caliper Short Pin Repair Kit**  
SB6 / SB7 / SN6 / SN7 / SK7 / SB7 Radial Type



**5217 / Caliper Repair Kit**  
SB6 / SB7 / SN6 / SN7 / SK7 / SB7 Radial Type



**5218 / Sensor Stabilizer Plastic Kit**  
SB6 / SB7 / SN6 / SN7 / SK7 / SL7 / SM7 / ST7 Type



**5219 / Caliper Piston Tappet & Seals Repair Kit**  
SL7 / SM7 / ST7 Type



**5220 / Caliper Piston Tappet Repair Kit**  
SL7 / SM7 / ST7 Type



**5221 / Caliper Clibration Bolt New Model**  
SL7 / SM7 / ST7 Type



**5222 / Caliper Inner Boot & Ring**  
SB6 / SB7 / SN6 / SN7 / SK7 / SB7 Radial Type





**5223 / Caliper Cover**  
SL / SM7 / ST7 Type



**5224 / Sensor Adjuster Plastic Kit**  
SB6 / SB7 / SN6 / SN7 / SK7 / SL7 / SM7 / ST7 Type



0140  
Sensor Adjuster Plastic

**5225 / Sensor Adjuster Plastic Kit**  
SB7 Radial Type



0141 / Sensor Adjuster Plastic

**5226 / Sensor Adjuster Plastic Kit**  
SB6 / SB7 / SN6 / SN7 / SK7 / SL7 / SM7 / ST7 Type



0147 / Sensor Adjuster Plastic

**5800 / Caliper Carrier / B AXLE  
KNORR CARRIER**

KNORR: K004099 / SCANIA: 212600 / SF:3 080 0054 01 - 3 080 0055 01



**5801 / Caliper Carrier / MAN 12-180  
KNORR CARRIER**

KNORR: K005606



**5802 / Caliper Carrier / MB FRONT AXLE  
KNORR CARRIER**

KNORR: K000026 - Z007541 / MB: 000 421 1106 / SCN: 2121591



**5803 / Caliper Carrier / B AXLE  
KNORR CARRIER**

KNORR: K012619 - Z006715 / SCN: 2379697 / B: 01.303.88.56.0



**5804 / Caliper Carrier / MB NEW 4140 REAR  
KNORR CARRIER**

KNORR: K052379K50 - Z025197 / MB: 000 423 1006



**5805 / Caliper Carrier / MB NEW 4140 FRONT  
KNORR CARRIER**

KNORR: K046498K50 / MB: 000 421 5706



**5806 / Caliper Carrier / SCANIA NEW MODEL  
KNORR CARRIER**

KNORR: K001507



**5807 / Caliper Carrier / MB AXOR  
KNORR CARRIER**

KNORR: K000027 - Z006582 / MB: 000 423 0606 / SCANIA: 2121592





**5808 / Caliper Carrier / MB ATEGO  
KNORR CARRIER**

KNORR: K000690 - K001926 / MB: 000 421 2006 - 000 421 3106 / JOST: JAE0110402006



**5809 / Caliper Carrier / SCANIA OLD MODEL  
KNORR CARRIER**

KNORR: K010765 / SCANIA: 1756388



**5810 / Caliper Carrier / SAF AXLE  
KNORR CARRIER**

KNORR: K015308 - Z019050 / SF: 3 080 0059 00 - 3 080 0060 00



**5811 / Caliper Carrier / B AXLE  
KNORR CARRIER**

KNORR: K004679 / SCN: 2379695 B: 01.303.88.55.0



**5812 / Caliper Carrier / MAN TGA  
KNORR CARRIER**

KNORR: K001278



**5813 / Caliper Carrier / DAF TRUCK  
KNORR CARRIER**

KNORR: K011479 / DAF: 1689314 - Z006590 / DF LF 55 IV / DF 75 CF - 85 CF / DF CF 65 II-IV / DF CF 75 IV / DF CF 85 IV / DF XF 95 / DF XF 105



**5814 / Caliper Carrier / B AXLE  
KNORR CARRIER**

KNORR: K001105 - K003673



**5815 / Caliper Carrier / MB CONNECTO - RIGHT  
KNORR CARRIER**

KNORR: K001530 / MB: 000 421 3806



**5816 / Caliper Carrier / MB CONNECTO - LEFT  
KNORR CARRIER**

KNORR: K001529 / MB: 000 421 3706



**5817 / Caliper Carrier / SCHMITZ TRAILER  
KNORR CARRIER**

KNORR: K007475 - Z000968



**5818 / Caliper Carrier / B AXLE  
KNORR CARRIER**

KNORR: K004680 / SCN: 2379696 / BP: 01.303.88.57.0

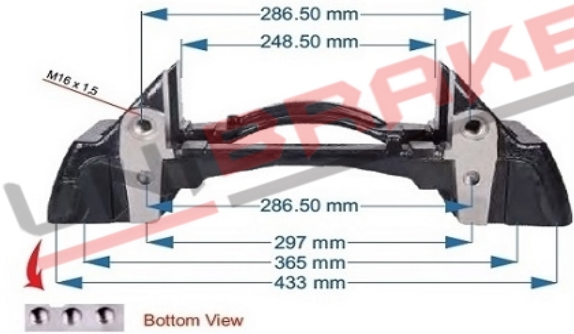

**5819 / Caliper Carrier / MB AXOR  
KNORR CARRIER**

KNORR: K000028 / MB: 000 421 1206



**5820 / Caliper Carrier / MB ATEGO  
KNORR CARRIER**

KNORR: K001927 / MB: 000 421 3006 / SCANIA: 2121599

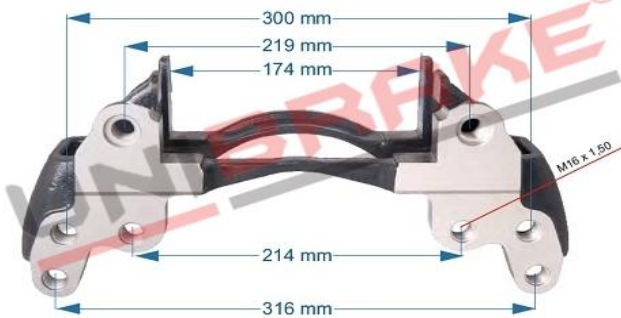

**5821 / Caliper Carrier / MB 4140 FRONT  
KNORR CARRIER**

KNORR: K046764K50 / MB: 000 421 5806 / Z046338



**5822 / Caliper Carrier / B AXLE  
KNORR CARRIER**

KNORR: K001505



**5823 / Caliper Carrier / B AXLE - RIGHT  
KNORR CARRIER**

KNORR: K001497





**5824 / Caliper Carrier / B AXLE - LEFT  
KNORR CARRIER**  
KNORR: K004206



**5825 / Caliper Carrier / MERCEDES ATEGO  
KNORR CARRIER**  
KNORR: K001494 / MB: 000 421 1306



**5826 / Caliper Carrier / SMB AXLE  
KNORR CARRIER**  
KNORR: K001525



**5827 / Caliper Carrier / IVECO TRUCK  
KNORR CARRIER**  
KNORR: K108814K50 - K001510

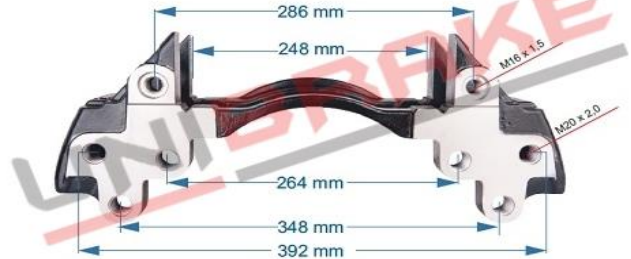

**5828 / Caliper Carrier / SCHMITZ TRAILER  
KNORR CARRIER**  
KNORR: K108001K50

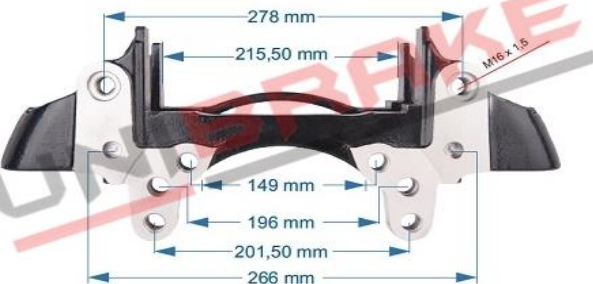

**5829 / Caliper Carrier / MB ATEGO  
KNORR CARRIER**  
KNORR: K000358 / MB: 000 421 1606



**5830 / Caliper Carrier / IVECO TRUCK RIGHT  
KNORR CARRIER**  
KNORR: K002314

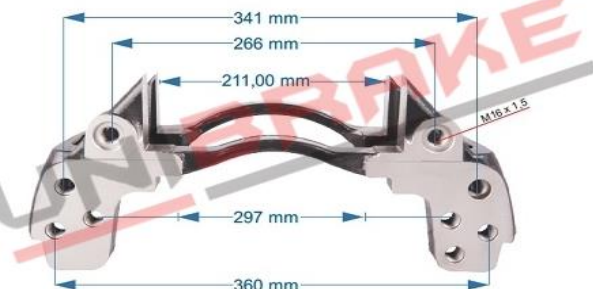

**5831 / Caliper Carrier / IVECO TRUCK LEFT  
KNORR CARRIER**  
KNORR: K002313

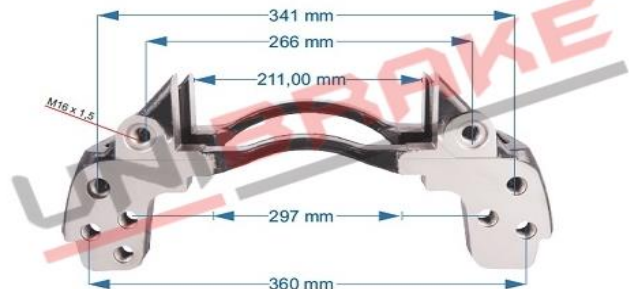



*You can follow our new products from our website.*



**1000 VG TYPE**

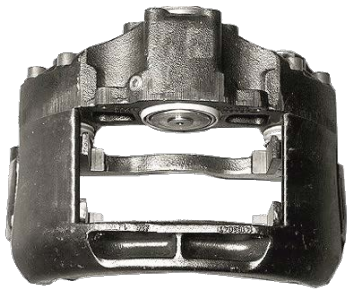

**WABCO CARRIERS**



**MAXX22 TYPE**



**1300 VG TYPE**

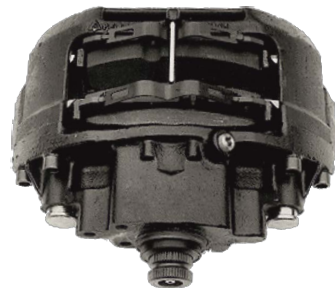

**PAN 17 TYPE**



**WABCO CARRIERS**



**PAN 19 / 22 TYPE**



---

# **WABCO**

## **BRAKE CALIPER REPAIR KITS**



*You can follow our new products from our website.*

**6000 / Caliper Repair Set  
PAN 17 Type**

**6003 / Caliper Boot & Pin Repair Kit**



**6008 / Caliper Adjusting Mechanism Set**



**6009 / Adjusting Mechanism Washer & Spring Set**



**6001 / Caliper Repair Set  
PAN 17 Type**

**6003 / Caliper Boot & Pin Repair Kit**



**6011 / Caliper Adjusting Mechanism Set**



**6009 / Adjusting Mechanism Washer & Spring Set**





**6002 / Caliper Repair Set  
PAN 17 Type**

**6003 / Caliper Boot & Pin Repair Kit**



**6008 / Caliper Adjusting Mechanism Set**



**6003 / Caliper Boot & Pin Repair Kit ( 12-153 MN )  
PAN 17 Type**

WABCO: 12 999 699 - 12 999 702 / DAF: 1436853 / IVECO: 42536957 / OTOKAR: 13C3508276AA / CWSK.2



**6004 / Caliper Boot & Pin Repair Kit  
PAN 17 Type**



**6005 / Caliper Boot Set  
PAN 17 Type**



1500 / Tappet Boot



1505 / Pin Bellow Green

**6006 / Caliper Adjusting Mechanism Set  
PAN 17 Type**

6008 / Caliper Adjusting Mechanism Set



6009 / Adjusting Mechanism Washer & Spring Set



**6007 / Caliper Adjusting Mechanism Set  
PAN 17 Type**

6011 / Caliper Adjusting Mechanism Set



6009 / Adjusting Mechanism Washer & Spring Set



**6008 / Caliper Adjusting Mechanism Set  
PAN 17 Type**



1000 / Adjusting Mechanism

6012 / Calibration Bolt

1001 / Spring Ring Thick

1002 / Spring Ring Thin

1003 / Spring

**6009 / Adjusting Mechanism Washer & Spring Set  
PAN 17 Type**

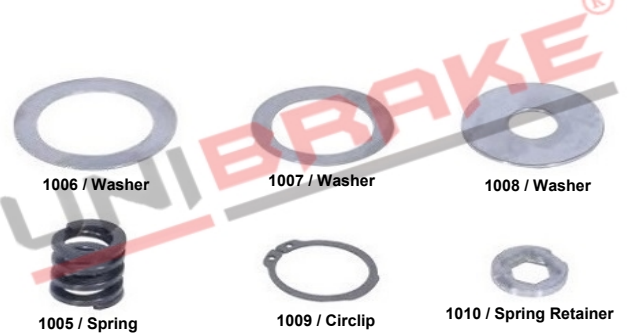

1006 / Washer

1007 / Washer

1008 / Washer

1005 / Spring

1009 / Circlip

1010 / Spring Retainer



**6010 / Caliper Repair Set  
PAN 17 Type**

**6003 / Caliper Boot & Pin Repair Kit**



**6011 / Adjusting Mechanism Set**



**6011 / Caliper Adjusting Mechanism Set  
PAN 17 Type**



**6012 / Calibration Bolt  
PAN 17 Type**



**6013 / Calibration Bolt  
PAN 17 Type**



**6014 / Caliper Lever  
PAN 17 / 19 / 22 Type  
CWSK.12.3**



**6015 / Caliper Shaft Housing Set  
PAN 17 Type**



1512 / Shaft Housing

1513 / Spring

**6016 / Caliper Boot & Pin Bolt Repair Kit  
PAN 17 Type**

WBC: 12 999 704 / DF: 1519363 / RNL: 5001 852 880



M16x1,5x90 mm

1504 / Pin Bolt

M16x1,5x70 mm

0806 / Pin Bolt

1505 / Pin Bellow Green  
Ø34x16 mm

1507 / Pin Cap

1500 / Tappet Boot  
Ø34xØ30x20 mm

1506 / Pin Bush

**6017 / Caliper Boot & Bolt Set  
PAN 17 Type**

WBC: 12 999 580 / MN: 81.50822.6003 / DF: 1517407

**6016 / Caliper Boot & Pin Bolt Repair Kit**

**6018 / Caliper Head Gasket Set**

**1511 / Caliper Screw**



**6018 / Caliper Head Gasket Set  
PAN 17 / 19 / 22 / MAXX 17 Type**



1508 / Cover Gasket

1510 / Head Cap

1509 / Head Seal

**6019 / Caliper Lining Plate - Left (With Pin)  
PAN 17 Type**





**6020 / Caliper Brake Lining Plate - Right (With Pin)  
PAN 17 Type**



**6021 / Caliper Brake Lining Plate - Left (With Groove)  
PAN 17 Type  
CWSK.17.3**



**6022 / Caliper Brake Lining Plate - Right (With Groove)  
PAN 17 Type  
CWSK.17.5**



**6023 / Roller Bearing Set  
PAN 17 / 19 / 22 / MAXX 17 / 17 CWS Type  
CWSK.12**



1603 / Roller Bearing

**6024 / Caliper Brake Lining Plate - Left (With Groove)  
PAN 19 / 22 Type  
CWSK.19.3**



**6025 / Caliper Brake Lining Plate - Right (With Groove)  
PAN 19 / 22 Type  
CWSK.19.5**



**6026 / Caliper Repair Set  
PAN 19 / 22 Type**

**6028 / Caliper Boot & Pin Repair Kit**



**6031 / Caliper Adjusting Mechanism Set**



**6032 / Adjusting Mechanism Washer & Spring Set**



**6027 / Caliper Repair Set  
PAN 19 / 22 Type**

**6028 / Caliper Boot & Pin Repair Kit**



**6031 / Caliper Adjusting Mechanism Set**





**6028 / Caliper Boot & Pin Repair Kit  
PAN 19 / 22 Type**

WBC: 12 999 776 / DF: 1628065 / RNL: 5001 866 626 / SF: 3 434 3828 00 / SCB: 1068.119  
NSSN: 411209X605 / KGL: 6500700 / LECITRAILER: 050340001 / VLV: 85108166 / CWSK.6



**6029 / Caliper Boot & Pin Repair Kit  
PAN 19 / 22 Type**



**6030 / Caliper Repair Set  
PAN 19 / 22 Type**

**6031 / Caliper Adjusting Mechanism Set**



**6032 / Adjusting Mechanism Washer & Spring Set**



**6031 / Caliper Adjusting Mechanism Set  
PAN 19 / 22 Type**



**6032 / Adjusting Mechanism Washer & Spring Set  
PAN 19 / 22 Type**



**6033 / Caliper Repair Set - Left  
MAXX 22 Type**

6070 / Caliper Guide & Bush Repair Kit



6073 / Adjusting Mechanism Set



6068 / Caliper Lever Set

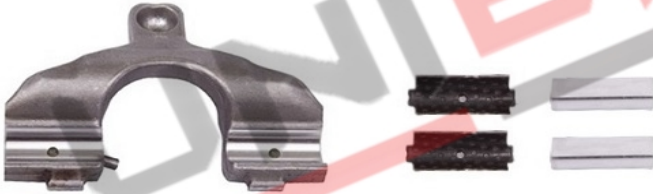

6106 / Caliper Brake Lining Plate - Left



6076 / Caliper Roller Bearing Set



1550  
Caliper Seal



1551  
Caliper Gear



1552  
Caliper Pin



6104 / Caliper Metal Cover Kit



"OLD NUMBER / 6107"

**6033-1 / Caliper Repair Set - Right  
MAXX 22 Type**

6070 / Caliper Guide & Bush Repair Kit



6073 / Adjusting Mechanism Set

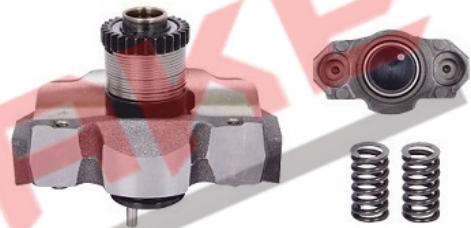

6068 / Caliper Lever Set

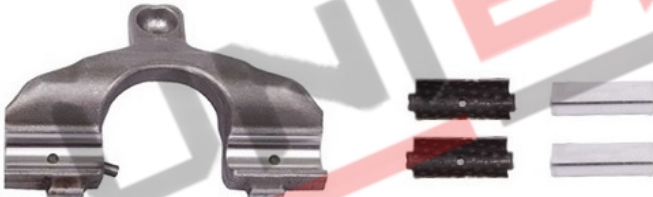

6105 / Caliper Brake Lining Plate - Right



6076 / Caliper Roller Bearing Set



1550  
Caliper Seal



1551  
Caliper Gear



1552  
Caliper Pin



6104 / Caliper Metal Cover Kit





**6034 / Shaft Housing (With Springs)**  
PAN 19 / 22 Type



1514 / Shaft Housing

1513 / Spring

**6035 / Calibration Bolt (With Pin)**  
PAN 19 / 22 Type



**6036 / Caliper Lining Plate - Right (With Groove)**  
PAN 19 / 22 / MAXX 22T Type



**6037 / Caliper Lining Plate - Left (With Groove)**  
PAN 19 / 22 / MAXX 22T Type



**6038 / Caliper Boot & Pin Repair Kit  
PAN 19 / 22 Type**

WBC: 12 999 738 / DF: 1505890 / SF: 3 434 3827 01 / CWSK.4



**6039 / Caliper Boot & Pin Bush Repair Kit  
PAN 19 / 22 Type**



**6040 / Caliper Boot Set  
PAN 19 / 22 / MAXX 22 Type**



**6041 / Caliper Boot Pin Repair Kit  
PAN 19 / 22 Type**







**6048 / Caliper Adjusting Set  
PAN 17 Type**



**6049 / Caliper Adjusting Set  
PAN 19 / 22 Type**



**6050 / Caliper Pin Repair Kit  
1000 VG Type**

WBC: 12 999 729 / MAN: 81.50800.6023 - N1011015566 / NEOPLAN: 82139200 - 11015566 / DAF: 1517354

Ø25x81 mm



1200 / Caliper Pin With Hole

Ø25x81 mm



1211 / Caliper Pin (Without Hole)

M12x1,5x90 mm

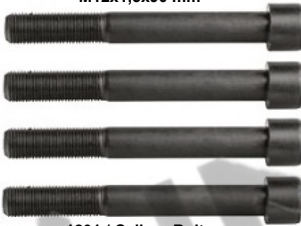

1201 / Caliper Bolt

Ø28x16 mm



1203 / Pin Cap

1209 / Bolt & Spring

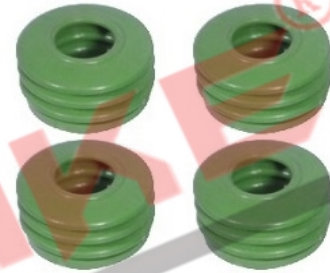

1205 / Pin Boot



1204 / Tappet Boot

Ø28xØ25x15 mm



1202 / Pin Bush



1207 / O-ring



1206 / Seal



1208 / Rubber Cap

**6051 / Roller Bearing Set  
DOUBLE PISTONS Type**



1212 / Roller Bearing

**6052 / Caliper Lever  
DOUBLE PISTONS Type**





**6053 / Caliper Lever & Bearing Set  
DOUBLE PISTONS Type**



6052 / Caliper Lever



6051 / Caliper Roller Bearing Set



6067 / Caliper Roller Bearing Set

**6054 / Caliper Lever Repair Kit  
DOUBLE PISTONS Type**

6056 / Caliper Lever Repair Kit



6052 / Caliper Lever



**6055 / Caliper Lever Repair Kit  
DOUBLE PISTONS Type**

6056 / Caliper Lever Repair Kit

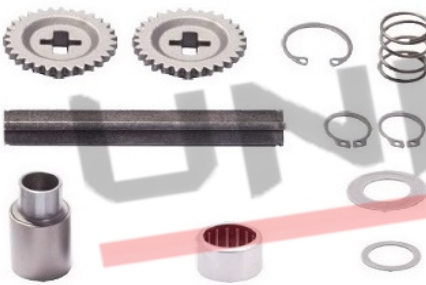

6051  
Caliper Roller Bearing Set



6067  
Caliper Roller Bearing Set



6052 / Caliper Lever



**6056 / Caliper Lever Repair Kit  
DOUBLE PISTONS Type**

1517 / Caliper Bearing



6057 / Caliper Gear



1518 / Caliper Bearing



6061 / Caliper Lever Pin



1520 / Washer



1521 / Washer



1522 / Circlip



1523 / Circlip



1519 / Spring



**6057 / Caliper Gear Repair Kit**  
DOUBLE PISTONS Type



1213 / Caliper Gear

**6058 / Caliper Gear Repair Kit / Right**  
DOUBLE PISTONS Type



1214 / Caliper Gear Right

**6059 / Caliper Gear Repair Kit / Left**  
DOUBLE PISTONS Type



1215 / Caliper Gear Left

**6060 / Caliper Adjusting Mechanism Pin**  
DOUBLE PISTONS Type



1216 / Adjusting Mechanism Pin

**6061 / Caliper Lever Pin**  
DOUBLE PISTONS Type



**6062 / Caliper Gear Wheel Adjusting Repair Kit**  
DOUBLE PISTONS Type



1216 / Caliper Adjusting Mechanism Pin



1524 / Washer



1526 / Circlip



1525 / Spring



1509 / Caliper Seal



**6063 / Caliper Adjusting Mechanism Housing  
DOUBLE PISTONS Type**



**6064 / Caliper Calibration Bolt Right  
DOUBLE PISTONS Type**



1516 / Anti Rotation Plate



1515 / Circlip

6044 / Calibration Bolt Right

**6065 / Caliper Calibration Bolt Left  
DOUBLE PISTONS Type**



1516 / Anti Rotation Plate



1515 / Circlip

6045 / Calibration Bolt Left

**6066 / Caliper Gasket Set  
DOUBLE PISTONS Type**



1217 / Gasket

M10x1x40 mm



1511 / Screw

M16x1,5x40 mm



4008 / Screw



4008 / Screw

**6067 / Roller Bearing Set  
DOUBLE PISTONS Type**



1218 / Roller Bearing

**6068 / Caliper Lever Set  
MAXX 22 Type**



1541 / Caliper Lever

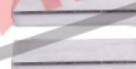

1543 / Ball Bearing



1542 / Bushing

**6069 / Caliper Repair Kit  
MAXX 22 Type**

MN: 81.50822.6039 / WBC: 640 322 927 2



1550 / Caliper Seal



1551 / Caliper Gear



1552 / Caliper Pin



1510 / Caliper Plug

**6070 / Caliper Guide & Bush Repair Kit  
MAXX 22 Type**

640 322 926 2 / MAN 81.50822.6038



**6071 / Caliper Plug Set  
MAXX 22 Type**



**6072 / Caliper Dust Cover Set  
MAXX 22 Type**



**6073 / Adjusting Mechanism Set  
MAXX 22 Type**



**6074 / Calibration Mechanism Washer Set  
MAXX 22 Type**





**6075 / Calibration Bolt**  
MAXX 19 / 22 / 22L / 22 MERCEDES Type



**6076 / Caliper Roller Bearing Set**  
MAXX 19 / 22 MERCEDES / 22L / 22T Type



1011 / Roller Bearing

**6077 / Caliper Roller Bearing Set**  
MAXX 19 / 22 / 22 MERCEDES / 22L / 22T



6076 / Caliper Roller Bearing



1542 / Ball Bearing



1543 / Bushing

**6078 / Caliper Adjusting Mechanism**  
MAXX 22 Type



1528 / Adjusting Mechanism



6075 / Calibration Bolt



1532 / Spring



1535 / Spring Ring Thick



1539 / Washer



1533 / Spring Ring Thin



1534 / Adjusting Gear



1531 / Plug

**6079 / Caliper Washer Set**  
MAXX 19 / 22 / 22 MERCEDES / 22L



1533 / Spring Ring Thin



1532 / Spring



1540 / Washer



1530 / Washer



1534 / Adjusting Gear



1535 / Spring Ring Thick



1538 / Washer



1536 / Circlip



1537 / Circlip

**6080 / Caliper Shaft Housing With Springs  
MAXX 22 Type**

100831

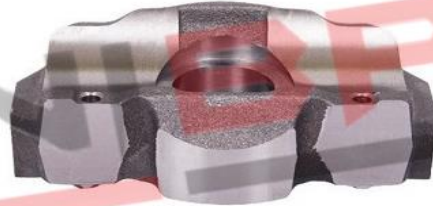

1549 / Shaft Housing



1548 / Spring

**6081 / Caliper Repair Set With Groove - Right  
PAN 17 Type**

6003 / Caliper Boot & Pin Repair Kit



1513 / Spring



6022 / Caliper Brake Lining Plate - Right  
(With Groove)



6023 / Roller Bearing Set



1509 / Head Seal



1511 / Caliper Screw



6048 / Caliper Adjusting Set



1508 / Cover Gasket



6014 / Caliper Lever





**6082 / Caliper Repair Set With Groove - Left  
PAN 17 Type**

6003 / Caliper Boot & Pin Repair Kit



1513 / Spring



6021 / Caliper Brake Lining Plate - Left  
(With Groove)



6023 / Roller Bearing Set



1509 / Head Seal



1511 / Caliper Screw



6048 / Caliper Adjusting Set



1508 / Cover Gasket



6014 / Caliper Lever



**6083 / Caliper Repair Set With Pin - Right  
PAN 17 Type**

6003 / Caliper Boot & Pin Repair Kit



1513 / Spring



6020 / Caliper Brake Lining Plate - Right  
(With Pin)



6023 / Roller Bearing Set



1509 / Head Seal



1511 / Caliper Screw



6090 / Adjusting Mechanism Set



1508 / Cover Gasket



6014 / Caliper Lever



**6084 / Caliper Repair Set With Pin - Left  
PAN 17 Type**

6003 / Caliper Boot & Pin Repair Kit



1513 / Spring



6019 / Caliper Brake Lining Plate - Left  
(With Pin)



6023 / Roller Bearing Set



1509 / Head Seal



1511 / Caliper Screw



6090 / Adjusting Mechanism Set



1508 / Cover Gasket



6014 / Caliper Lever



**6085 / Caliper Repair Set With Groove - Right  
PAN 19-22 Type**

6028 Caliper Boot & Pin Repair Kit



1513 / Spring



6025 / Caliper Brake Lining Plate - Right  
(With Groove)



6023 / Roller Bearing Set



1509 / Head Seal



1511 / Caliper Screw



6049 / Adjusting Mechanism Set



1508 / Cover Gasket



6014 / Caliper Lever





**6086 / Caliper Repair Set With Groove - Left  
PAN 19-22 Type**



**6087 / Caliper Repair Set  
DOUBLE PISTONS Type**

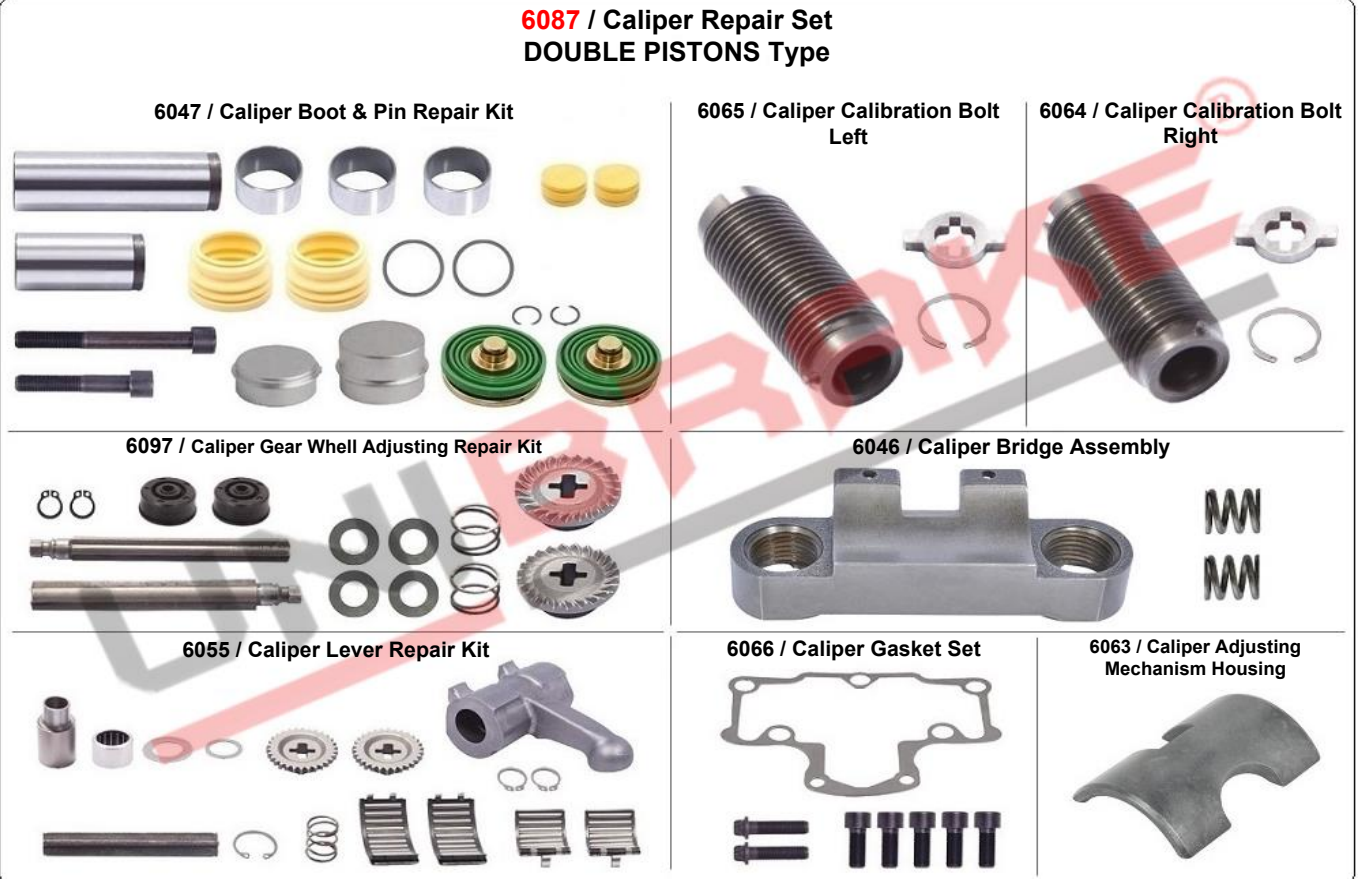





**6095 / Caliper Guide & Bush Repair Kit**

**DOUBLE PISTONS Type**

WABCO: 12 999 677 / DAF: 865965 / RENAULT: 5021 170 487 / SMB: M100667



**6096 / Caliper Guide & Bush Repair Kit**

**DOUBLE PISTONS Type**

WBC: 12 999 678 / DF: 865966 / RNL: 5021 170 488 / SMB: M100675



**6097 / Caliper Gear Wheel Adjusting Repair Kit**

**DOUBLE PISTONS Type**



**6098 / Caliper Gear Wheel Adjusting Repair Kit**  
**DOUBLE PISTONS Type**



**6099 / Caliper Tappet Boot**  
**DOUBLE PISTONS Type**

WABCO: 8977500002



**6100 / Caliper Shaft Housing Set  
DOUBLE PISTONS Type**



**6101 / Caliper Guide & Bush Repair Kit  
MAXX 22 Type**

6070 / Caliper Guide & Bush Repair Kit



6074 / Calibration Mechanism Washer Set





**6102 / Caliper Guide & Bush Repair Kit  
MAXX 22 Type**

**6070 / Caliper Guide & Bush Repair Kit**



**6078 / Caliper Adjusting Mechanism**



**6103 / Caliper Sealing Ring Set  
MAXX 22 Type**



1546 / Sealing Ring

**6104 / Caliper Metal Cover Kit  
MAXX 22 Type**

640 322 650 4



1544 / Caliper Metal Cover

1546 / Sealing Ring

M8x16 mm



0120 / Bolt

**6105 / Caliper Brake Lining Plate - R  
MAXX 22 Type**



**6106 / Caliper Brake Lining Plate - L  
MAXX 22 Type**



**6108 / Caliper Boot & Pin Repair Kit  
MAXX 22T Type**

640 222 928 2 / SCHMTZ : 1199858



**6109 / Caliper Boot Set  
MAXX 19 / 22T Type**



**6110 / Caliper Adjusting Mechanism Set  
MAXX 22T Type**



**6111 / Caliper Adjusting Mechanism Set  
MAXX 22T Type**



**6112 / Adjusting Mechanism Washer & Spring Set  
MAXX 22T Type**

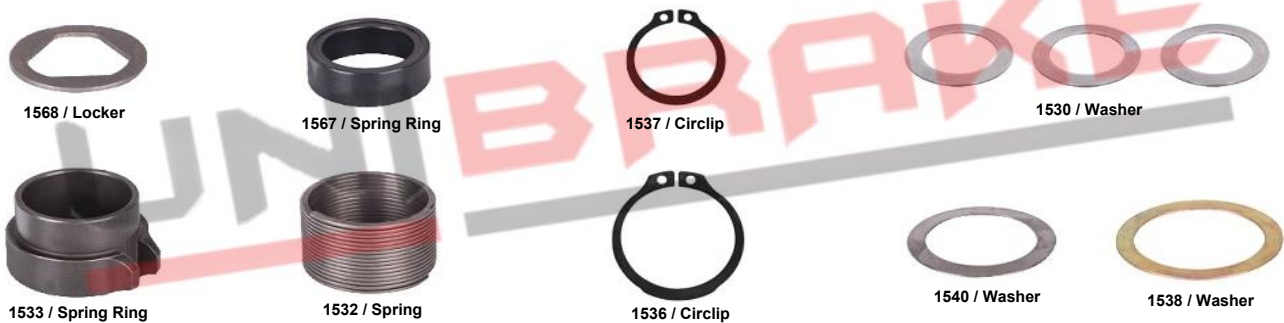



**6113 / Caliper Leveller Repair Kit  
MAXX 22T Type**



**6114 / Calibration Mechanism Set  
MAXX 22T Type**

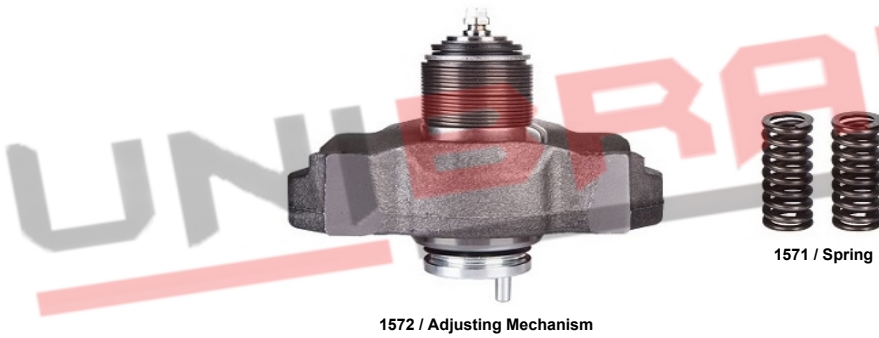

**6115 / Metal Cover Kit  
MAXX 22T Type**



**6116 / Caliper Leveller  
MAXX 19 / 22T Type**



**6117 / Plastic Sensor  
MAXX 22 Type**

640 322 928 2 - 441 039 001 0 4811 / MAN:81.50822.6040



**6118 / Caliper Guide & Bush Repair Kit  
1300 VG**

MB: 000 420 0982



**6119 / Caliper Guide & Bush Repair Kit  
1300 VG**

12 999 734VT



**6120 / Caliper Guide & Bush Repair Kit  
1300 VG Type**

12 999 733VT / MB : 4054200083





**6121 / Caliper Boot Set  
1300 VG Type**



**6122 / Caliper Washer Set  
1300 VG Type**



**6123 / Adjusting Mechanism Shaft - Right  
1300 VG Type**



**6124 / Adjusting Mechanism Shaft - Left  
1300 VG Type**



**6125 / Adjusting Mechanism Shaft - Right  
1300 VG Type**

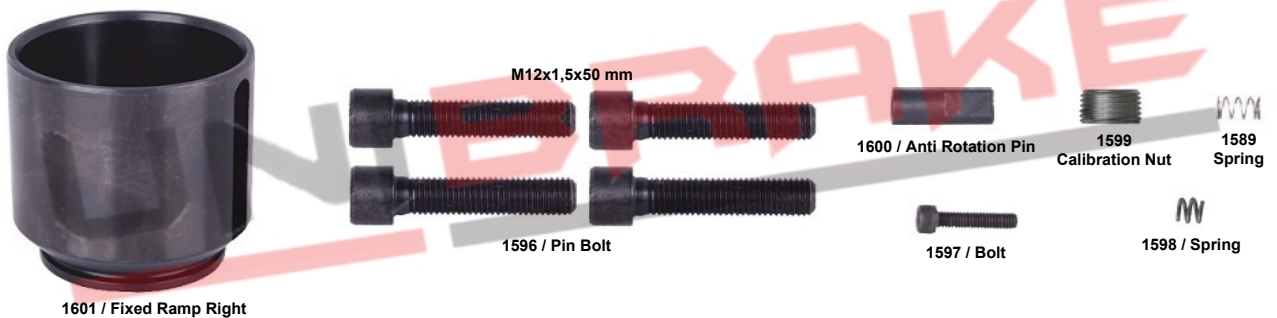

**6126 / Caliper Shaft Set - Left  
1300 VG Type**



1602 / Fixed Ramp Left

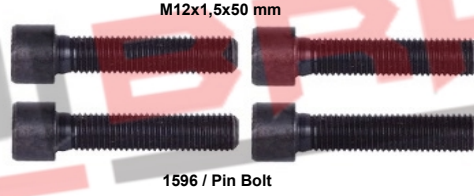

M12x1,5x50 mm

1596 / Pin Bolt



1600 / Anti Rotation Pin



1599  
Calibration Nut



1589  
Spring



1597 / Bolt



1598 / Spring

**6127 / Caliper Brake Lining Plate  
1300 VG Type**



1606 / Brake Lining Plate



1597 / Bolt



1598 / Spring

**6128 / Caliper Shaft Lever  
1300 VG Type**



**6129 / Caliper Dust Cover  
MAXX 22 MERCEDES / 22L Type**



**6130 / Caliper Brake Pad Retainer Kit  
DOUBLE PISTONS Type**

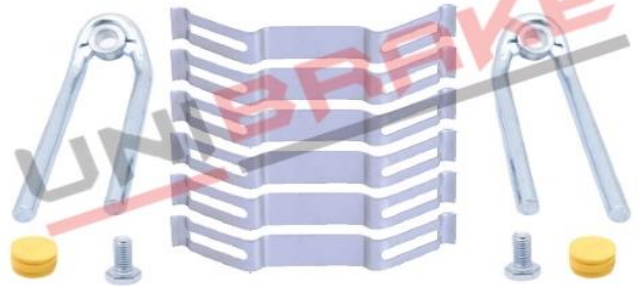

**6131 / Caliper Dust Cover Set  
1000 VG Type**

12 999 199VT / IVECO: 93161181 / OTOKAR:12E0008228AA



1607 / Caliper Piston Boot



1608 / Caliper Piston Seal



**6132 / Caliper Repair Kit Complete - Right  
1300 VG Type**

6118 / Caliper Guide & Bush Repair Kit



6127 / Caliper Brake Lining Plate

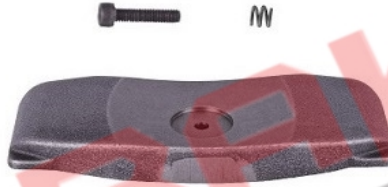

6128 / Caliper Shaft Lever



6123 / Adjusting Mechanism Shaft - Right



1601 / Fixed Ramp Right



1600 / Anti Rotation Pin



1599 / Calibration Nut



1589 / Spring



**6133 / Caliper Repair Kit Complete - Left  
1300 VG Type**

6118 / Caliper Guide & Bush Repair Kit



6127 / Caliper Brake Lining Plate

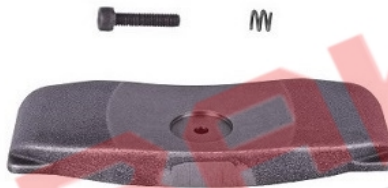

6128 / Caliper Shaft Lever



6124 / Adjusting Mechanism Shaft - Left



1602 / Fixed Ramp Left



1600 / Anti Rotation Pin



1599 / Calibration Nut



1589 / Spring



**6134 / Caliper Guide & Bush Repair Kit  
MAXX 22T Type**

6108 / Caliper Boot & Pin Repair Kit



6111 / Caliper Adjusting Mechanism Set



**6135 / Caliper Repair Kit Complete - Right  
MAXX 22T Type**

6108 / Caliper Boot & Pin Repair Kit



6114 / Calibration Mechanism Set

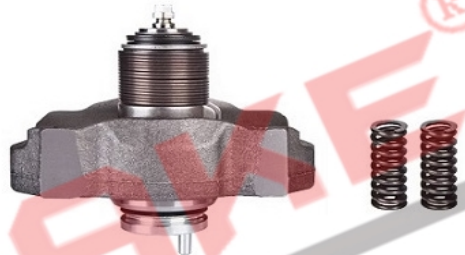

6116 / Caliper Leveller



6076 / Caliper Roller Bearing Set



1509 / Head Seal



6036 / Caliper Lining Plate - Right (With Groove)



6115 / Metal Cover Kit





**6136 / Caliper Repair Kit Complete - Left  
MAXX 22T Type**

**6108 / Caliper Boot & Pin Repair Kit**



**6114 / Calibration Mechanism Set**

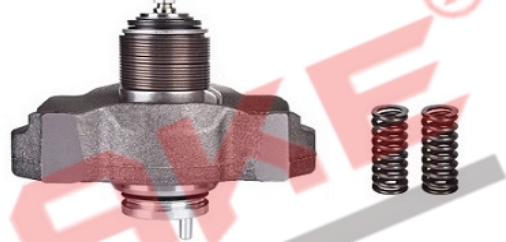

**6116 / Caliper Leveller**



**6076 / Caliper Roller Bearing Set**



**1509 / Head Seal**



**6037 / Caliper Lining Plate - Left (With Groove)**



**6115 / Metal Cover Kit**



**6137 / Caliper Leveller  
MAXX 22 L Type**



**6138 / Caliper Leveller  
MAXX 22 MERCEDES Type**



**6139 / Caliper Guide & Bush Repair Kit  
MAXX 22 MERCEDES / 22L Type**

640.322.938.2



**6139-1 / Caliper Guide & Bush Repair Kit  
MAXX 22 MERCEDES / 22L Type**  
640.322.951.2



**6140 / Caliper Guide & Bush Repair Kit  
MAXX 22 MERCEDES / 22L Type**



**6140-1 / Caliper Guide & Bush Repair Kit  
MAXX 22 MERCEDES / 22L Type**  
640.319.922.2



**6141 / Calibration Mechanism Set  
MAXX 22 MERCEDES / 22L Type**



**6142 / Caliper Bridge Assembly  
MAXX 22 MERCEDES / 22L Type**  
322388



**6143 / Calibration Mechanism  
MAXX 19 / 22 MERCEDES / 22L Type**







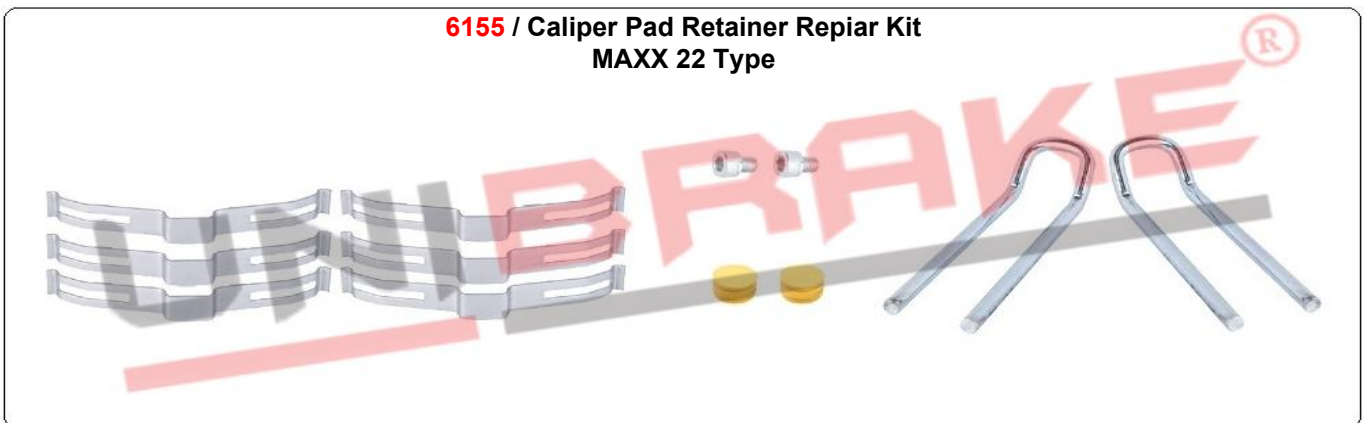



**6156 / Caliper Repair Kit Complete - Right  
MAXX 22 Type**

6070 / Caliper Guide & Bush Repair Kit



6073 / Adjusting Mechanism Set

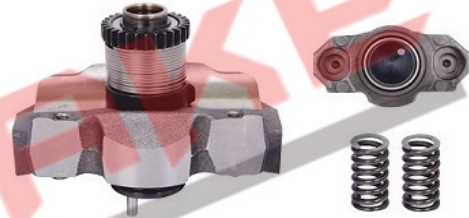

6076 / Caliper Roller Bearing Set



1550 / Caliper Seal



6105 / Caliper Brake Lining Plate - Right



1551 / Caliper Gear



1552  
Caliper Manual Adjuster Shaft



6104 / Caliper Metal Cover Kit



**6157 / Caliper Repair Kit Complete - Left  
MAXX 22 Type**

6070 / Caliper Guide & Bush Repair Kit



6073 / Adjusting Mechanism Set

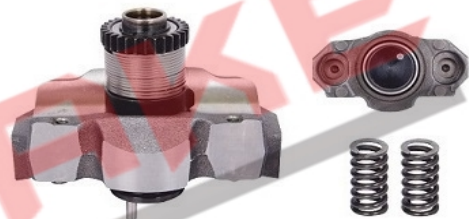

6076 / Caliper Roller Bearing Set



1550 / Caliper Seal



6106 / Caliper Brake Lining Plate - Left



1551 / Caliper Gear



1552  
Caliper Manual Adjuster Shaft



6104 / Caliper Metal Cover Kit



**6158 / Caliper Guide & Bush Repair Kit  
MAXX 22 MERCEDES / 22L Type**

6139 / Caliper Guide & Bush Repair Kit



6143 / Calibration Mechanism



**6159 / Caliper Guide & Bush Kit  
MAXX 22 MERCEDES / 22L Type**

6139 / Caliper Guide & Bush Repair Kit



6144 / Calibration Mechanism



**6160 / Caliper Metal Cover Set  
MAXX 19 / 22 MERCEDES / 22L Type**



**6161 / Caliper Dust Cover Set  
MAXX 19 / 22 MERCEDES / 22L Type**





**6162 / Caliper Repair Kit Complete / MERCEDES AROCS FRONT RIGHT  
MAXX 22L Type**

6139 / Caliper Guide & Bush Repair Kit



6171 / Caliper Brake Lining Plate - Right

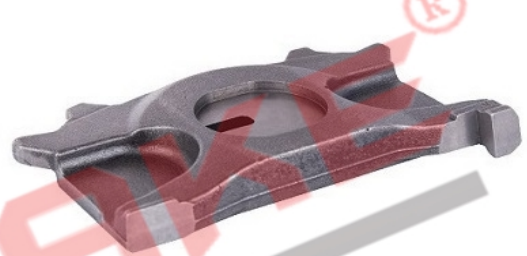

6160 / Caliper Metal Cover Set



6141 / Calibration Mechanism Set



6077 / Caliper Roller Bearing Set

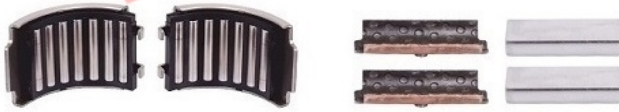

1529  
Caliper Manual Adjuster Shaft



1551 / Caliper Gear



1550 / Caliper Seal



**6162-1 / Caliper Repair Kit Complete / MERCEDES AROCS FRONT RIGHT  
MAXX 22L Type**

6139 / Caliper Guide & Bush Repair Kit



6171 / Caliper Brake Lining Plate - Right

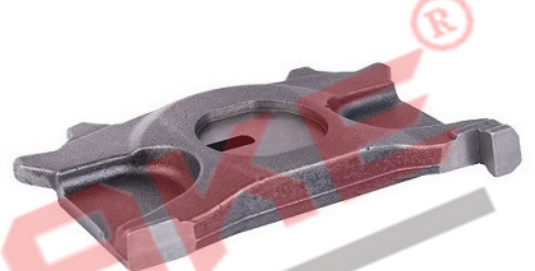

6160 / Caliper Metal Cover Set



6141 / Calibration Mechanism Set



6137 / Caliper Leveller



6077 / Caliper Roller Bearing Set



1529  
Caliper Manual Adjuster Shaft



1551 / Caliper Gear



1550 / Caliper Seal



**6163 / Caliper Repair Kit Complete / MERCEDES AROCS FRONT LEFT  
MAXX 22L Type**

6139 / Caliper Guide & Bush Repair Kit



6172 / Caliper Brake Lining Plate - Left



6160 / Caliper Metal Cover Set



6141 / Calibration Mechanism Set



6077 / Caliper Roller Bearing Set



1529  
Caliper Manual Adjuster Shaft



1551 / Caliper Gear



1550 / Caliper Seal



**6163-1 / Caliper Repair Kit Complete / MERCEDES AROCS FRONT LEFT  
MAXX 22L Type**

6139 / Caliper Guide & Bush Repair Kit



6172 / Caliper Brake Lining Plate - Left



6160 / Caliper Metal Cover Set



6141 / Calibration Mechanism Set



6137 / Caliper Leveller



6077 / Caliper Roller Bearing Set



1529  
Caliper Manual Adjuster Shaft



1551 / Caliper Gear



1550 / Caliper Seal





**6164 / Caliper Repair Kit Complete / MERCEDES AROCS REAR RIGHT  
MAXX 22 MERCEDES Type**

6139 / Caliper Guide & Bush Repair Kit



6171 / Caliper Brake Lining Plate - Right

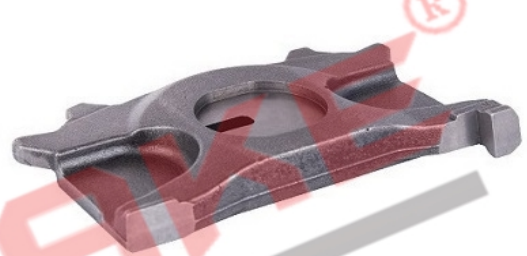

6160 / Caliper Metal Cover Set



6141 / Calibration Mechanism Set



6077 / Caliper Roller Bearing Set



1529  
Caliper Manual Adjuster Shaft



1551 / Caliper Gear



1560 / Caliper Seal



**6165 / Caliper Repair Kit Complete / MERCEDES AROCS REAR RIGHT  
MAXX 22 MERCEDES Type**

6139 / Caliper Guide & Bush Repair Kit



6171 / Caliper Brake Lining Plate - Right

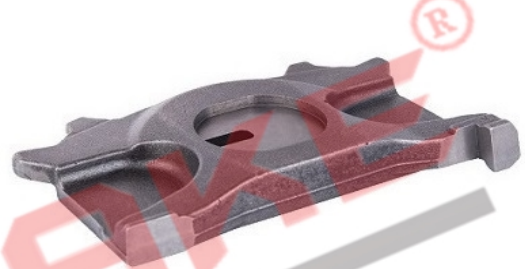

6160 / Caliper Metal Cover Set



6141 / Calibration Mechanism Set



6138 / Caliper Leveller



6077 / Caliper Roller Bearing Set



1529  
Caliper Manual Adjuster Shaft



1551 / Caliper Gear



1560 / Caliper Seal



**6166 / Caliper Repair Kit Complete / MERCEDES AROCS REAR LEFT  
MAXX 22 MERCEDES Type**

6139 / Caliper Guide & Bush Repair Kit



6172 / Caliper Brake Lining Plate - Left



6160 / Caliper Metal Cover Set



6141 / Calibration Mechanism Set



6077 / Caliper Roller Bearing Set



1529  
Caliper Manual Adjuster Shaft



1551 / Caliper Gear



1560 / Caliper Seal



**6167 / Caliper Repair Kit Complete / MERCEDES AROCS REAR LEFT  
MAXX 22 MERCEDES Type**

6139 / Caliper Guide & Bush Repair Kit



6172 / Caliper Brake Lining Plate - Left



6160 / Caliper Metal Cover Set



6141 / Calibration Mechanism Set



6138 / Caliper Leveller



6077 / Caliper Roller Bearing Set



1529  
Caliper Manual Adjuster Shaft



1551 / Caliper Gear



1560 / Caliper Seal





**6168 / Caliper Guide & Bush Repair Kit  
MAXX 22T Type**

6108 / Caliper Boot & Pin Repair Kit



6110 / Caliper Adjusting Mechanism Set



**6169 / Caliper Repair Kit Complete - Right  
MAXX 22T Type**

6108 / Caliper Boot & Pin Repair Kit



1509 / Head Seal



6036 / Caliper Lining Plate - Right (With Groove)



6114 / Calibration Mechanism Set



6115 / Metal Cover Kit



6076 / Caliper Roller Bearing Set



**6170 / Caliper Repair Kit Complete - Left  
MAXX 22T Type**

**6108 / Caliper Boot & Pin Repair Kit**



**1509 / Head Seal**



**6037 / Caliper Lining Plate - Left (With Groove)**



**6114 / Calibration Mechanism Set**



**6115 / Metal Cover Kit**



**6076 / Caliper Roller Bearing Set**



**6171 / Caliper Brake Lining Plate - Right  
MAXX 22 MERCEDES / 22L Type**



**6172 / Caliper Brake Lining Plate - Left  
MAXX 22 MERCEDES / 22L Type**



**6173 / Caliper Dust Cover Kit  
MAXX 17 / 17 CWS Type**



6042 / Tappet Boot

1505 / Pin Bellow Green





**6178 / Caliper Head Gasket Set  
PAN 17 / 19 / 22 Type**



**6179 / Caliper Dust Cover Kit  
MAXX 17 / 22 Type**

WABCO: 640.322.932.2



**6180 / Caliper Brake Lining Plate - Right  
MAXX 17 / 17 CWS Type**



**6181 / Caliper Brake Lining Plate - Left  
MAXX 17 / 17 CWS Type**



**6182 / Caliper Leveller  
MAXX 17 / 17 CWS Type**



**6183 / Calibration Mechanism Set  
MAXX 17 Type**



**6184 / Caliper Bridge Assembly  
MAXX 17 / 17 CWS Type**





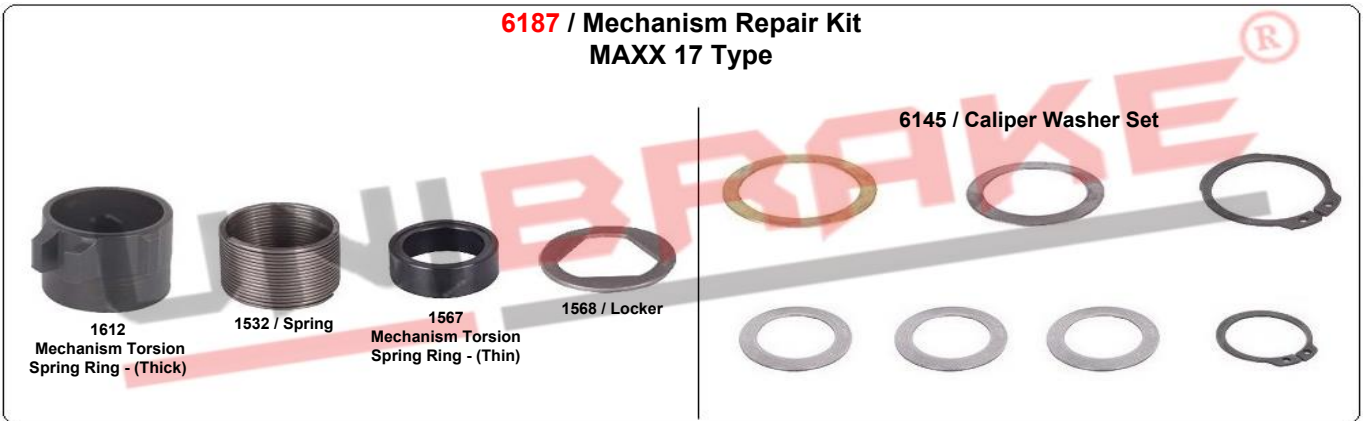

**6189 / Caliper Repair Kit Complete - Right ( GAZ )  
MAXX 17 Type**

6174 / Caliper Guide & Bush Repair Kit



6180 / Caliper Brake Lining Plate - Right



6183 / Calibration Mechanism Set



6023 / Roller Bearing Set



1511 / Caliper Screw



1509 / Head Seal



1508 / Cover Gasket



**6190 / Caliper Repair Kit Complete - Right ( GAZ )  
MAXX 17 Type**

6174 / Caliper Guide & Bush Repair Kit



6180 / Caliper Brake Lining Plate - Right



6182 / Caliper Leveller



6183 / Calibration Mechanism Set



6023 / Roller Bearing Set



1511 / Caliper Screw



1509 / Head Seal



1508 / Cover Gasket





**6191 / Caliper Repair Kit Complete - Left ( GAZ )  
MAXX 17 Type**

6174 / Caliper Guide & Bush Repair Kit



6181 / Caliper Brake Lining Plate - Left



6183 / Calibration Mechanism Set



6023 / Roller Bearing Set



1511 / Caliper Screw



1509 / Head Seal



1508 / Cover Gasket



**6192 / Caliper Repair Kit Complete - Left ( GAZ )  
MAXX 17 Type**

6174 / Caliper Guide & Bush Repair Kit



6181 / Caliper Brake Lining Plate - Left

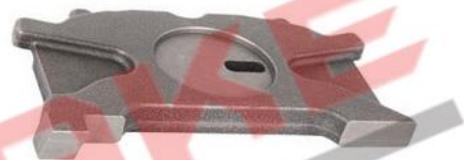

6182 / Caliper Leveller



6183 / Calibration Mechanism Set



6023 / Roller Bearing Set



1511 / Caliper Screw



1509 / Head Seal



1508 / Cover Gasket



**6193 / Caliper Guide & Bush Repair Kit  
MAXX 17 CWS Type**



**6194 / Caliper Guide & Bush Repair Kit  
MAXX 17 CWS Type**

WABCO: 640.317.922.2 / VOLVO: 21748964 / RENAULT: 7421748963



**6195 / Caliper Dust Cover & Bush Repair Kit  
MAXX 17 CWS Type**



**6196 / Caliper Cover Gasket Set  
MAXX 17 CWS Type**

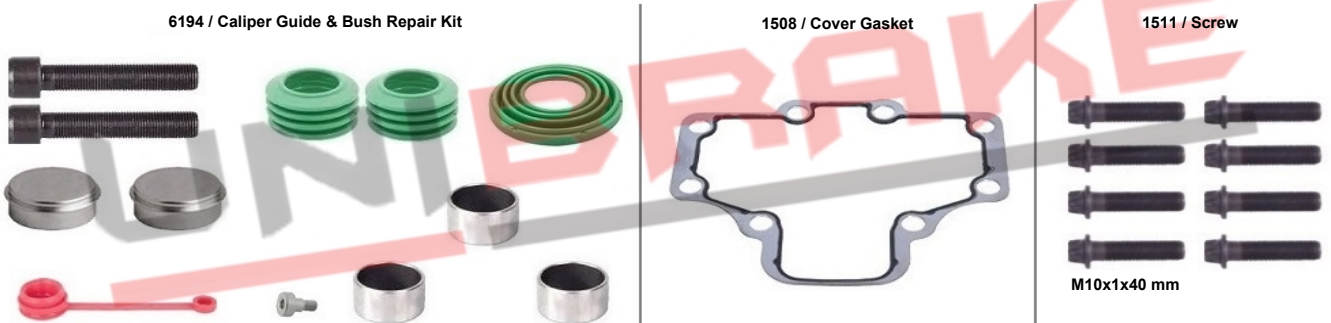



**6197 / Caliper Cover Set  
MAXX 17 CWS Type**



**6198 / Caliper Dust Cover Kit  
MAXX 17 CWS / 19 Type**



**6199 / Caliper Mechanism Repair Kit  
MAXX 17 CWS / 19 Type**

WABCO: 640.317.926.2 / VOLVO: 21749015 / RENAULT: 7421749014



**6200 / Calibration Mechanism Set  
MAXX 17 CWS Type**



**6201 / Calibration Mechanism Repair Kit  
MAXX 17 CWS Type**



**6202 / Calibration Mechanism Repair Kit  
MAXX 17 CWS Type**



**6203 / Caliper Mechanism Repair Kit  
MAXX 17 CWS Type**



**6204 / Calibration Mechanism Bolt  
MAXX 17 CWS Type**



**6205 / Caliper Repair Kit Complete - Right ( RENAULT & VOLVO )  
MAXX 17 CWS Type**

6193 / Caliper Guide & Bush Repair Kit



6180 / Caliper Brake Lining Plate - Right

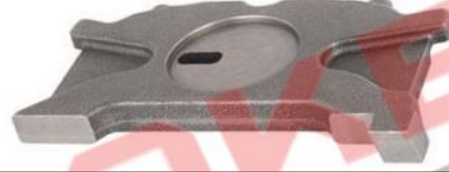

6200 / Calibration Mechanism Set



1551  
Caliper Gear



1552  
Caliper Pin



1550 / Seal



6023  
Roller Bearing Set



1511 / Screw



1508 / Gasket



**6206 / Caliper Repair Kit Complete - Right ( RENAULT & VOLVO )  
MAXX 17 CWS Type**

6193 / Caliper Guide & Bush Repair Kit



6180 / Caliper Brake Lining Plate - Right



6182 / Caliper Leveller



6200 / Calibration Mechanism Set



1551  
Caliper Gear



1552  
Caliper Pin



1550 / Seal



6023  
Roller Bearing Set



1511 / Screw



1508 / Gasket





**6207 / Caliper Repair Kit Complete - Left ( RENAULT & VOLVO )  
MAXX 17 CWS Type**

6193 / Caliper Guide & Bush Repair Kit



6181 / Caliper Brake Lining Plate - Left



6200 / Calibration Mechanism Set



1551  
Caliper Gear



1552  
Caliper Pin



1550 / Seal



6023  
Roller Bearing Set



1511 / Screw



1508 / Gasket



**6208 / Caliper Repair Kit Complete - Left ( RENAULT & VOLVO )  
MAXX 17 CWS Type**

6193 / Caliper Guide & Bush Repair Kit



6181 / Caliper Brake Lining Plate - Left



6182 / Caliper Leveller



6200 / Calibration Mechanism Set



1551  
Caliper Gear



1552  
Caliper Pin



1550 / Seal



6023  
Roller Bearing Set



1511 / Screw



1508 / Gasket



**6209 / Caliper Guide & Bush Repair Kit  
MAXX 19 Type**



**6210 / Caliper Bolt & Bush Repair Kit  
MAXX 19 Type**

WABCO: 640.318.922.2 / VOLVO: 21748973 / RENAULT: 7421748972



**6211 / Caliper Boot & Bush Repair Kit  
MAXX 19 Type**



**6212 / Calibration Mechanism Set  
MAXX 19 Type**



**6213 / Caliper Bridge Assembly  
MAXX 19 Type**



**6214 / Caliper Brake Lining Plate Right  
MAXX 19 Type**

WABCO: 640.319.929.2 - R



**6215 / Caliper Brake Lining Plate Left  
MAXX 19 Type**

WABCO: 640.319.929.2 - L





**6216 / Caliper Repair Kit Complete - Right (RENAULT)  
MAXX 19 Type**

6209 / Caliper Guide & Bush Repair Kit



6214 / Caliper Brake Lining Plate Right



6160 / Caliper Metal Cover Set



6212 / Calibration Mechanism Set



6077 / Caliper Roller Bearing Set



1551 / Caliper Gear



1552 / Caliper Pin



1550 / Seal



**6217 / Caliper Repair Kit Complete - Right (RENAULT)  
MAXX 19 Type**

6209 / Caliper Guide & Bush Repair Kit



6214 / Caliper Brake Lining Plate Right



6160 / Caliper Metal Cover Set



6212 / Calibration Mechanism Set



6116 / Caliper Leveller



6076 / Caliper Roller Bearing Set



1551  
Caliper Gear



1552  
Caliper Pin



1550 / Seal



**6218 / Caliper Repair Kit Complete - Left (RENAULT)  
MAXX 19 Type**

6209 / Caliper Guide & Bush Repair Kit



6215 / Caliper Brake Lining Plate Left



6160 / Caliper Metal Cover Set



6212 / Calibration Mechanism Set



6077 / Caliper Roller Bearing Set



1551 / Caliper Gear



1552 / Caliper Pin



1550 / Seal



**6219 / Caliper Repair Kit Complete - Left (RENAULT)  
MAXX 19 Type**

6209 / Caliper Guide & Bush Repair Kit



6215 / Caliper Brake Lining Plate Left



6160 / Caliper Metal Cover Set



6212 / Calibration Mechanism Set



6116 / Caliper Leveller



6076 / Caliper Roller Bearing Set



1551  
Caliper Gear



1552  
Caliper Pin



1550 / Seal





**6800 / Caliper Carrier / MERCEDES FRONT - RIGHT  
WABCO CARRIER**



**6801 / Caliper Carrier / MERCEDES FRONT - LEFT  
WABCO CARRIER**



**6802 / Caliper Carrier / 12-153 MAN - RIGHT  
WABCO CARRIER**



**6803 / Caliper Carrier / 12-153 MAN - LEFT  
WABCO CARRIER**



**6804 / Caliper Carrier / SAF AXLE - RIGHT  
WABCO CARRIER**



**6805 / Caliper Carrier / SAF AXLE - LEFT  
WABCO CARRIER**



**6806 / Caliper Carrier / MAN TGX-TGS / RIGHT  
WABCO CARRIER**



**6807 / Caliper Carrier / MAN TGX-TGS / LEFT  
WABCO CARRIER**



**6808 / Caliper Carrier / RENAULT MIDLUM  
WABCO CARRIER**



**6809 / Caliper Carrier / SAF AXLE - RIGHT  
WABCO CARRIER**



**6810 / Caliper Carrier / SAF AXLE - LEFT  
WABCO CARRIER**



**6811 / Caliper Carrier / SCHMITZ AXLE - RIGHT  
WABCO CARRIER**



**6812 / Caliper Carrier / SCHMITZ AXLE - LEFT  
WABCO CARRIER**



**6813 / Caliper Carrier / SAF AXLE - RIGHT  
WABCO CARRIER**



**6814 / Caliper Carrier / SAF AXLE - LEFT  
WABCO CARRIER**





**6815 / Caliper Carrier / SAF AXLE - RIGHT  
WABCO CARRIER**



**6816 / Caliper Carrier / SAF AXLE - LEFT  
WABCO CARRIER**



**6817 / Caliper Carrier / SAF AXLE - RIGHT  
WABCO CARRIER**



**6818 / Caliper Carrier / SAF AXLE - LEFT  
WABCO CARRIER**



**6819 / Caliper Carrier / SCHMITZ TRAILER - RIGHT  
WABCO CARRIER**



**6820 / Caliper Carrier / SCHMITZ TRAILER - LEFT  
WABCO CARRIER**

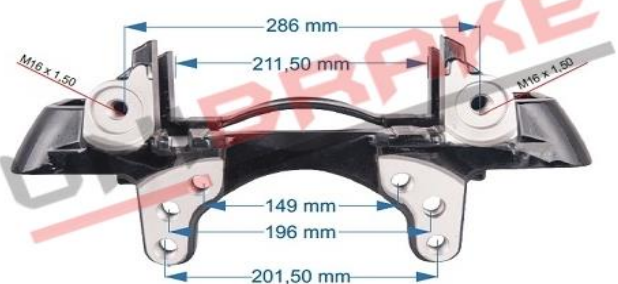

**6821 / Caliper Carrier / MB AROCS REAR - RIGHT  
WABCO CARRIER**  
640.915.745.4 / MB: 000 423 2206

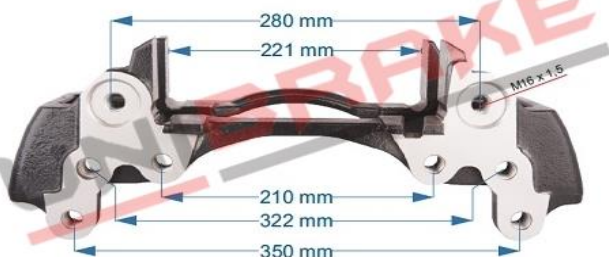

**6822 / Caliper Carrier / MB AROCS REAR - LEFT  
WABCO CARRIER**  
640.915.744.4 / MB: 000 423 2306



**6823 / Caliper Carrier / MB AROCS FRONT - RIGHT  
WABCO CARRIER**



**6824 / Caliper Carrier / MB AROCS FRONT - LEFT  
WABCO CARRIER**



**6825 / Caliper Carrier / SCHMITZ TRAILER - RIGHT  
WABCO CARRIER**



**6826 / Caliper Carrier / SCHMITZ TRAILER - LEFT  
WABCO CARRIER**



**6827 / Caliper Carrier / DAF LF55 - RIGHT  
WABCO CARRIER**



**6828 / Caliper Carrier / DAF LF55 - LEFT  
WABCO CARRIER**



**6829 / Caliper Carrier / MERCEDES REAR  
WABCO CARRIER**





**B DUCO**



**C / LE DUCO**



**D DUCO AXIAL**



**D DUCO RADIAL**



**C LISA**



**D LISA**



**D3**



**DX 175**



**DX 195**

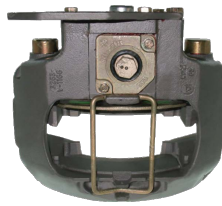

**DX 225**



**ELSA 1 AXIAL**



**ELSA 1 RADIAL**

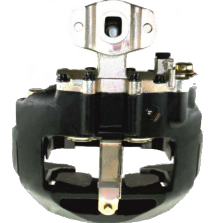

**ELSA 2 AXIAL**

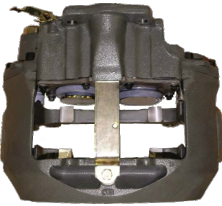

**ELSA 2 RADIAL**



**ELSA 195/225/EX225  
AXIAL**



**ELSA 195/225/EX225  
RADIAL**



**MERITOR CARRIERS**



---

# MERITOR

## BRAKE CALIPER REPAIR KITS



*You can follow our new products from our website.*

**7000 / Caliper Pin Repair Kit  
ELSA 1 Type**

MERITOR: MCK1102 - ST1157 / MAN: 81.50802.6017 - 81.50802.6020 - 81.50802.6021 - 35.50310.9496 / DAF: 1522034 / VANHOOL: 10770779 / ZF: 0501213164 / CMSK.5

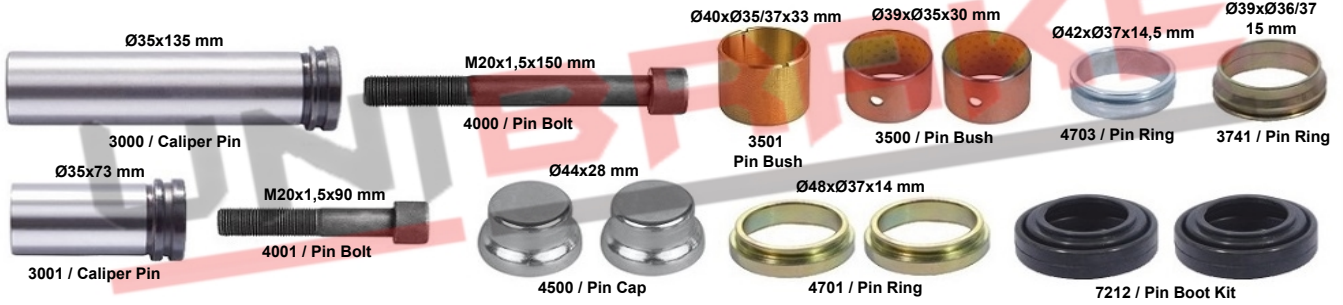

**7001 / Caliper Pin Repair Kit  
ELSA 1 Type**



**7002 / Caliper Boot & Pin Repair Kit  
ELSA 1 Type**



**7003 / Caliper Boot & Pin Repair Kit  
ELSA 1 Type**

MERITOR: MCK1103 / MAN: 81.50802.6022 / CMSK.23





**7004 / Locking Shim**  
ELSA 1 Type

MERITOR: 68321678 / MAN: 81.50822.0006 / ZF: 0501318076 / CMSK.5.4



**7005 / Intermediate Gear**  
ELSA 1 Type



**7006 / Caliper Adjusting Gear - Right**  
ELSA 1 Type



Ø35 mm

**7007 / Caliper Adjusting Gear - Left**  
ELSA 1 Type



Ø35 mm

**7008 / Caliper Adjusting Gear Set - Left**  
ELSA 1 Type

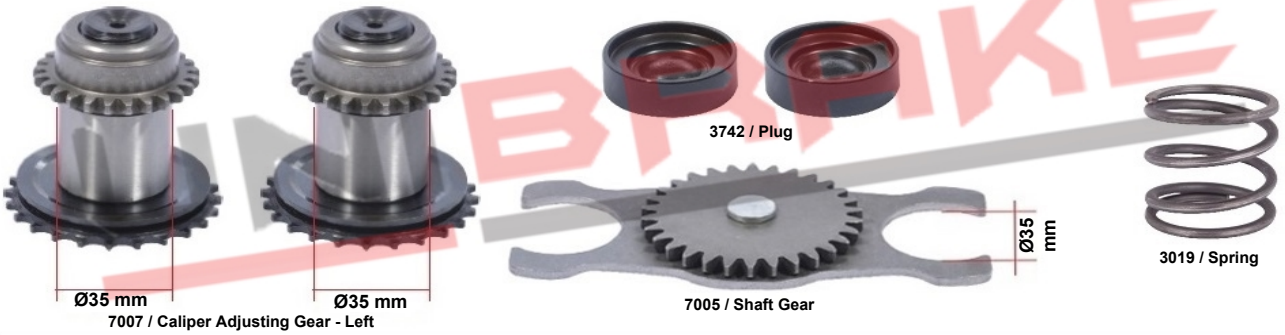

Ø35 mm

Ø35 mm

Ø35 mm

7007 / Caliper Adjusting Gear - Left

7005 / Shaft Gear

3019 / Spring

**7008-1 / Caliper Adjusting Gear Set - Right**  
ELSA 1 Type

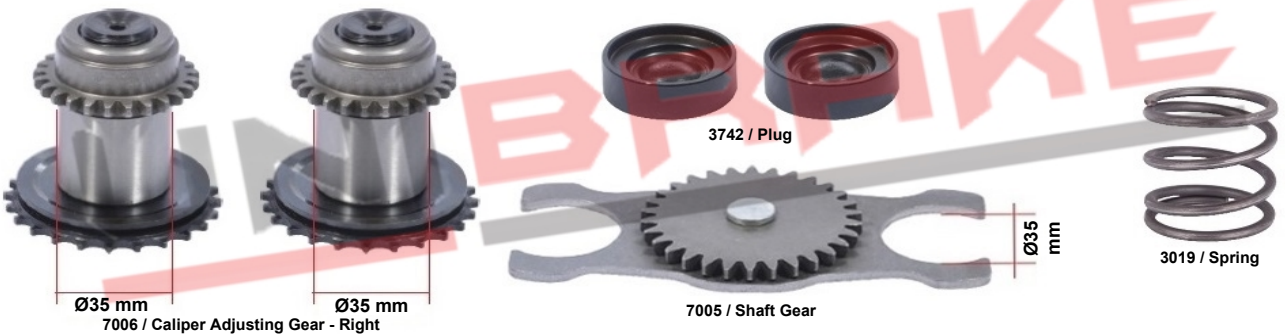

Ø35 mm

Ø35 mm

Ø35 mm

7006 / Caliper Adjusting Gear - Right

7005 / Shaft Gear

3019 / Spring

**7009 / Intermediate Gear  
ELSA 1 Type**



**7010 / Caliper Adjusting Gear Right  
ELSA 1 Type**



**7011 / Caliper Adjusting Gear Left  
ELSA 1 Type**



**7012 / Caliper Adjusting Gear Set Left  
ELSA 1 Type**



**7012-1 / Caliper Adjusting Gear Set Right  
ELSA 1 Type**





**7013 / Caliper Half Bearing Set**  
ELSA 1 / ELSA 2 / ELSA 195-225-EX225  
B DUCO / C-LE DUCO / D DUCO Type



3710 / Roller Bearing

**7014 / Caliper Bearing Set**  
ELSA 1 / ELSA 2 / ELSA 195-225-EX225  
B DUCO / C-LE DUCO / D DUCO Type

MERITOR: SJ4112 / VOLVO: 3092329 / DAF: 1522169 / CMSK.3.3



7013 / Roller Bearing



3012 / Lever Bush



3013 / Ball Bearing

**7015 / Caliper Lever With Bearings - Right**  
ELSA 1 Type

CMSK.5.14



3748 / Caliper Lever - Right



3012 / Lever Bush



3013 / Ball Bearing

**7016 / Caliper Lever With Bearings - Left**  
ELSA 1 Type

CMSK.5.15



3749 / Caliper Lever - Left



3012 / Lever Bush



3013 / Ball Bearing

**7017 / Caliper Boot & Pin Repair Kit**  
ELSA 2 Type



3003 / Caliper Pin



4002 / Pin Bolt



7096 / Pin Boot Kit

Ø42xØ31/32x45 mm



Ø42xØ37x14,5 mm

4703 / Pin Ring

3821 / Pin Rubber Bush

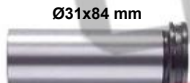

Ø31x84 mm

3004 / Caliper Pin



M18x1,5x90 mm

4003 / Pin Bolt



Ø44x28 mm

4501 / Pin Cap



Ø39xØ35x30 mm

3500 / Pin Bush



7043 / Tappet Boot Kit

**7018 / Caliper Boot & Pin Repair Kit**  
ELSA 2 Type



Ø35x144 mm

3003 / Caliper Pin



7096 / Pin Boot Kit

Ø42xØ31/32x45 mm



3821 / Pin Rubber Bush



Ø42xØ37x14,5 mm

4703 / Pin Ring



Ø31x84 mm

3004 / Caliper Pin

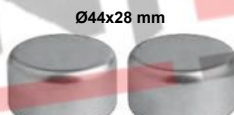

Ø44x28 mm

4501 / Pin Cap



Ø39xØ35x30 mm

3500 / Pin Bush



7043 / Tappet Boot Kit

**7019 / Caliper Guide & Repair Kit**  
**ELSA 2 Type**



**7020 / Caliper Guide & Repair Kit**  
**ELSA 2 Type**

MERITOR: MCK1086 / RENAULT: 5001 858 717 / DAF: 1522185 / ERF: 35503075532 / MAN: ZG002950002 / CMSK.46



**7021 / Caliper Guide & Repair Kit**  
**D LISA Type**

MERITOR: SJ4076 - MCK1104 / RENAULT: 5001 837 006 / VOLVO : 8550880 - 3098108 - 3097542 - 85103129 / DAF: 1522184 / DENNIS: 6553777 - 6565644 / CMSK.13  
Ø39xØ35/36x47 mm



**7022 / Caliper Guide & Repair Kit**  
**D LISA Type**

MERITOR: SJ4021 / VOLVO: 8550881 / DENNIS: 65537710





**7023 / Caliper Boot & Pin Repair Kit  
ELSA 2 Type**

MAN: 81.50802.6025 - 35.40311.2205 / IVECO: 42555201 / MERITOR: MCK1140 - MCK1243 / VOLVO: 85107912 - AMMCK1243 / RENAULT: 5001 860 791 / PACCAR: 1522058 / ZF: 0501215220 / CSMK.26



**7023-1 Caliper Boot & Pin Repair Kit  
ELSA 2 Type**

MAN: 81.50802.6025 - 35.40311.2205 / IVECO: 42555201 / MERITOR: MCK1140 - MCK1243 / VOLVO: 85107912 - AMMCK1243 / RENAULT: 5001 860 791 / PACCAR: 1522058 / ZF: 0501215220 / CSMK.26



**7024 / Caliper Lever Return Spring Set - Right  
ELSA 1 Type**



**7025 / Caliper Lever Return Spring Set - Left  
ELSA 1 Type**



**7026 / Adjusting Mechanism Shaft - Left  
C-LE DUCO / D DUCO**

MERITOR: MCK1113 / VOLVO: 3092267 - 85102093



"Locks clokwise / turns freely anti - clokwise"

**7026-1 / Adjusting Mechanism Shaft - Right  
C-LE DUCO / D DUCO**

MERITOR: MCK1113 / VOLVO: 3092267 - 85102093



"Locks anti - clokwise / turns freely clokwise"

**7027 / Adjusting Mechanism Shaft - Right  
C-LE DUCO / D DUCO**

MERITOR: SJ4103 - MCK1112 / VOLVO: 85102096 - 3092266 / CMSK.3.17



3709 / Adjusting Mechanism - Right



3704 / Sealing Ring Small

" Locks anti - clokwise / turns freely clokwise "

**7028 / Adjusting Mechanism Shaft - Left  
C-LE DUCO / D DUCO**

MERITOR: SJ4102 - MCK1111 / VOLVO: 85102095 - 3092265 / CMSK.3.16



3708 / Adjusting Mechanism - Left



3704 / Sealing Ring Small

" Locks clokwise / turns freely anti - clokwise "

**7029 / Caliper Gasket Set  
C-LE DUCO**

MERITOR: MCK1041 / VOLVO: 3095669



3705 / Plug



3703 / Sealing Ring Big



3704 / Sealing Ring Small



3702 / Gasket

**7030 / Caliper Gasket Set  
D DUCO**

MERITOR: SJ4105 / VOLVO: 3092269 / CMSK.3.7



3705 / Plug



3703 / Sealing Ring Big



3704 / Sealing Ring Small



3706 / Gasket

**7031 / Caliper Gasket Set  
D DUCO**

MERITOR: SJ4109 / VOLVO: 3092270 - DAF: 1522168



3823 / Plug



3703 / Sealing Ring Big



3704 / Sealing Ring Small



3707 / Gasket

**7032 / Caliper Tappet & Boot Set  
B DUCO / C-LE DUCO / D DUCO**

MAN: STRMCK1238 / DAF: 868378 / MERITOR: MCK1238 / VOLVO: 3092264  
AMMCK1238 / RENAULT: 5021 202 828



7051 / Tappet Boot Kit



7051 / Tappet Boot Kit

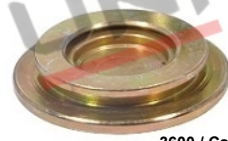

3600 / Caliper Tappet



3600 / Caliper Tappet



3800 / Circlip

**7033 / Caliper Adjusting Mechanism Set - Right  
B DUCO / C-LE DUCO / D DUCO**

MERITOR: MCK1237 - MCK1239 / VOLVO: 3092263 - 3095642 / CMSK.4.2



3700 / Adjusting Mechanism Right



4708 / Plasting Bushing



4708 / Plasting Bushing



7051 / Tappet Boot Kit

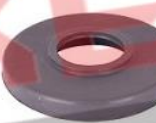

7051 / Tappet Boot Kit



4706 / Seal Big



4706 / Seal Big



3600 / Caliper Tappet



3600 / Caliper Tappet



3800 / Circlip



**7034 / Caliper Adjusting Mechanism Set - Left**  
B DUCO / C-LE DUCO / D DUCO Type

MERITOR: MCK1236 / VOLVO: 3092262 / CMSK.3.2



**7035 / Calibration Mechanism Set - Right**  
B DUCO / C-LE DUCO / D DUCO Type



**7036 / Calibration Mechanism Set - Left**  
B DUCO / C-LE DUCO / D DUCO Type



**7037 / Caliper Guide & Bush Repair Kit**  
B DUCO / C-LE DUCO / D DUCO Type

MERITOR: MCK1116 / MAN: STRMCK1116 / DAF: 1489197 / RENAULT: 5021 202 776 / VOLVO: 85102094 - AMMCK1116 / CMSK.3.1



**7037-1 / Caliper Guide & Bush Repair Kit**  
B DUCO / C-LE DUCO / D DUCO Type

MERITOR: MCK1116 / MAN: STRMCK1116 / DAF: 1489197 / RENAULT: 5021 202 776 / VOLVO: 85102094 - AMMCK1116 / CMSK.3.1



**7038 / Caliper Guide & Repair Kit**  
**D DUCO Type**

MERITOR:- MCK1118 / VOLVO: 85102092



**7038-1 / Caliper Guide & Repair Kit**  
**D DUCO Type**

MERITOR:- MCK1118 / VOLVO: 85102092



**7039 / Calibration Mechanism Set**  
**ELSA 2 Type**



**7040 / Caliper Boot & Pin Repair Kit**  
**D DUCO Type**





**7040-1 / Caliper Boot & Pin Repair Kit  
D DUCO Type**



**7041 / Caliper Guide & Repair Kit  
B DUCO / C-LE DUCO / D DUCO**

MERITOR: MCK1065 / MCK1066 / CMSK.3.14



**7042 / Caliper Guide & Repair Kit  
B DUCO / C-LE DUCO / D DUCO**

MERITOR: MCK1299 / MAN: STRMCK1299 / VOLVO: 3092268 - 3095628 - 3096769 - 85107718 - AMMCK1299 / PCCR: Y07100312 / DF: 1522170



**7043 / Caliper Dust Cover Kit  
ELSA 2 / 195 / 225 / EX225 Type**

MERITOR: 68324854PK10



**7044 / Caliper Dust Cover Kit  
ELSA 1 Type**

MERITOR: ST1156 / RNL: 5001 849 886 / MAN: 81.50802.6016 - 35.50310.9502 / VNHL: N508026022 / ZF: 0501211883 / CMSK.5.5



**7045 / Caliper Repair Kit Complete Rear - Left  
D3 Type**

**7067 / Caliper Repair Set Rear - Left ( 26 Teeth )**



**7071 / Caliper Pin Repair Kit**



**7074 / Caliper Brake Lining Plate**



**7228 / Caliper Lever ( 26 Teeth )**



**7227  
Caliper Adjusting Mechanism Spring**



**3775 / Washer**



**3777 / Washer**



**3776 / Spring Housing**



**3773 / Seal**



**3774 / Circlip**



**3831 / Circlip**



" OLD NUMBER / 7232 "

**7045-1 / Caliper Repair Kit Complete Rear - Right  
D3 Type**

**7068 / Caliper Repair Set Rear - Right ( 26 Teeth )**



**7071 / Caliper Pin Repair Kit**



**7074 / Caliper Brake Lining Plate**



**7228 / Caliper Lever ( 26 Teeth )**



**7227  
Caliper Adjusting Mechanism Spring**



**3775 / Washer**



**3777 / Washer**



**3776 / Spring Housing**



**3773 / Seal**



**3774 / Circlip**



**3831 / Circlip**





**7046 / Caliper Full Repair Kit Front - Right**  
**D3 Type**

**7070 / Caliper Repair Set Front - Right ( 26 Teeth )**



**7071 / Caliper Pin Repair Kit**



**7074 / Caliper Brake Lining Plate**



**7228 / Caliper Lever ( 26 Teeth )**



**7227**  
**Caliper Adjusting Mechanism Spring**



**3775 / Washer**



**3777 / Washer**



**3776 / Spring Housing**



**3773 / Seal**



**3774 / Circlip**



**3831 / Circlip**



" OLD NUMBER / 7120 "

**7046-1 / Caliper Full Repair Kit Front - Left**  
**D3 Type**

**7069 / Caliper Repair Set Front - Left ( 26 Teeth )**



**7071 / Caliper Pin Repair Kit**



**7074 / Caliper Brake Lining Plate**



**7228 / Caliper Lever ( 26 Teeth )**



**7227**  
**Caliper Adjusting Mechanism Spring**



**3775 / Washer**



**3777 / Washer**



**3776 / Spring Housing**



**3773 / Seal**



**3774 / Circlip**



**3831 / Circlip**



**7047 / Caliper Leveller  
D DUCO Type**



**7048 / Caliper Leveller  
ELSA 195-225-EX225 Type**



**7049 / Caliper Shaft Gear Set  
D DUCO Type**

MERITOR: MCK1067 / VOLVO: 3095626 / CMSK.3.10



**7050 / Caliper Anti Rotation Plate  
D DUCO Type**

MERITOR: 68322900 / CMSK.3.11



**7051 / Caliper Dust Cover Kit  
B DUCO / C-LE DUCO / D DUCO Type**

MN: 35.40311.2182 - 81.50802.6024 / DF: 1487339 / MRT: MCK1139 - MCK1288 / VLV: 85107913 / ZF: 0501215022 / RVI: 5006 028 414 - 5021 179 952 - 68324854PK10







**Complete Set**

**7052 / Caliper Adjusting Mechanism Set  
ELSA 2 Type**



**7053 / Caliper Mechanism Cap**



**7055 / Adjusting Mechanism**



**7056 / Adjusting Gear**



**7054 / Gasket**



**M8x45 mm**

**3727 / Bolt**

**7053 / Caliper Adjusting Mechanism Cap  
ELSA 2 Type**  
68324625 / CMSK.7.5



**7054 / Caliper Adjusting Mechanism Gasket  
ELSA 2 Type**



**7055 / Caliper Adjusting Mechanism  
ELSA 2 / ELSA 195-225-EX225 Type**



**7056 / Caliper Adjusting Mechanism  
ELSA 2 / ELSA 195-225-EX225 Type**







**7065 / Caliper Adjusting Mechanism - Left  
C / D LISA Type**

MERITOR: SJ4113 / VOLVO: 3092763 / NISSAN: 69029730 / DENNIS: CASSJ4113 - DEP100073  
LEYLAND: XBU1066 / RVI: 5001 856 319 / CMSK.10

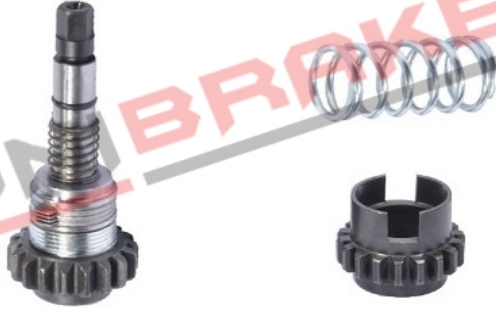

**7066 / Caliper Adjusting Mechanism - Right  
C / D LISA Type**

MERITOR: SJ4114 / VOLVO: 3092764 / DENNIS: CASJ4114 - DEP100074 / LEYLAND: LBSJ4114 /  
RENAULT: 5001 856 320 / NISSAN: 69030020 CMSK.10.2



**7067 / Caliper Repair Set Rear - Left  
D3 Type**



**7068 / Caliper Repair Set Rear - Right  
D3 Type**



**7069 / Caliper Repair Set Front - Left  
D3 Type**





**7070 / Caliper Repair Set Front - Right  
D3 Type**



**7071 / Caliper Pin Repair Kit  
D3 Type**

MERITOR: SJ4011 - MCK1213 / MAN: 81.50802.6009 - 81.50802.6008 / MB: 000 420 0276 / DENNIS: 65507911 CMSK.1

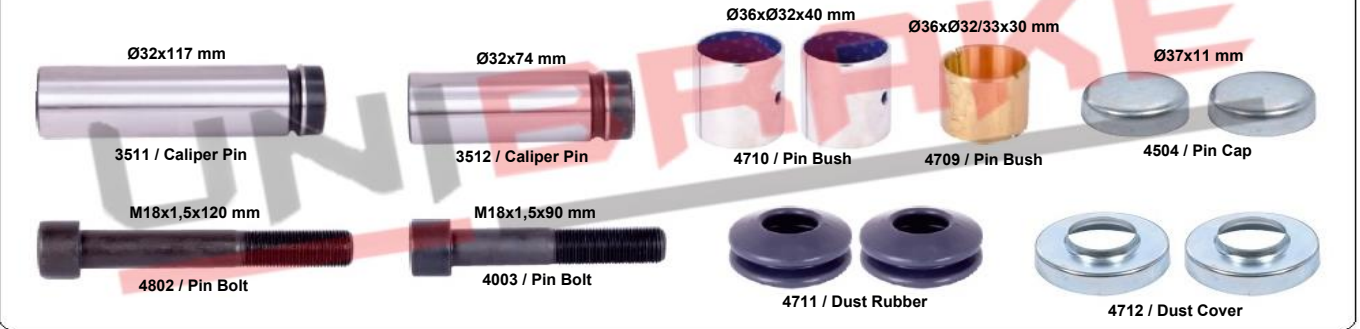

**7072 / Caliper Pin Repair Kit D3 Type**

MERITOR: SJ4001 / RENAULT: 5001 822 994 - 5001 822 998



**7073 / Spline Shaft Cover Set  
D3 Type**

MERITOR: SJ1212 / MB: 000 423 0082 / MN: 81.50802.6007 / DF: 1522063 /  
RNL: 5001 831 176 / ZF: 0501208810 - 0501209883 / DNNS: 6535631 - 65507910 /  
KSSBHRR: 8285388441 / RB: 650459



3766 / Dust Cover

M8x16 mm



0120 / Bolt

M8x40 mm



3770 / Bolt



3765 / Plastic Cap

**7074 / Caliper Brake Lining Plate  
D3 Type**

MERITOR: 68321272 - 68320912 / MERCEDES: 000 423 0062 / MAN: 81.50822.0003  
RNL: 5001 822 997 / ZF: 0501314109 / KSSBHRR: 8285388449  
RB: 746871 / ORION: F0102502DG



**7075 / Spline Shaft Set Front - Right  
D3 Type**

CMSK.29

26 Teeth



**7076 / Spline Shaft Set Front - Left  
D3 Type**

CMSK.28

26 Teeth



**7077 / Spline Shaft Set Rear - Right  
D3 Type**

26 Teeth



**7078 / Spline Shaft Set Rear - Left  
D3 Type**

26 Teeth



**7079 / Caliper Adjusting Gear Big - Left  
D3 Type**

CMSK.24.4



**7080 / Caliper Adjusting Gear Big - Right  
D3 Type**

CMSK.25.4





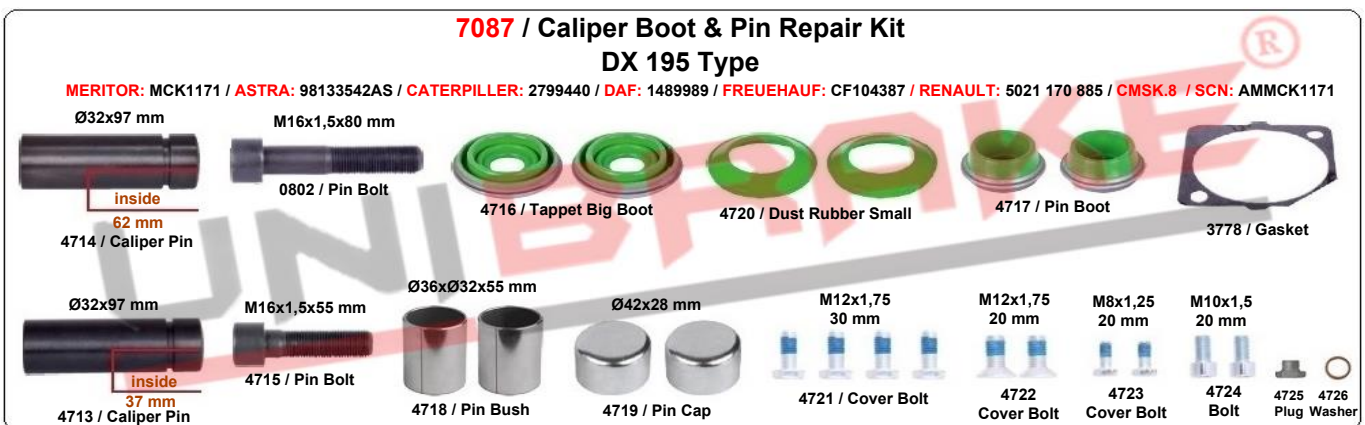

**7088 / Caliper Boot & Pin Bolt Repair Kit  
DX 195 Type**

MRTR: MCK1192 / ASTRA: 98133544AS / CTRPLLR: 2799674 / DF: 1489991 / FRUEHAUF: CF104388 / RNLTL: 5021 170 886 / SCANIA: 1034001 / VLV: AMMCK1192 CMSK.2.1



**7089 / Spline Shaft Set Front - Right  
D3 Type**

CMSK.24

48 Teeth



**7090 / Spline Shaft Set Front - Left  
D3 Type**

CMSK.25

48 Teeth



**7091 / Caliper Adjusting Mechanism Cap Small  
ELSA 195-225-EX225 Type**

68325646 / CMSK.7.3



**7092 / Manuel Adjusting Gear  
ELSA 195-225-EX225 Type**

CMSK.7.11.1



**7093 / Caliper Boot & Seal Set  
C LISA / D LISA Type**

SJ4061 / CMSK.54.1



**7094 / Caliper Tappet & Boot Set  
ELSA 2 / ELSA 195-225-EX225 Type**

MERITOR: MCK1309 / VOLVO: 85109891 / RENAULT: 5001 866 398 / CMSK.7.7







**Complete Set**

**7095 / Caliper Adjusting Mechanism Set  
ELSA 195-225-EX225 Type**



7091 / Caliper Mechanism Cap

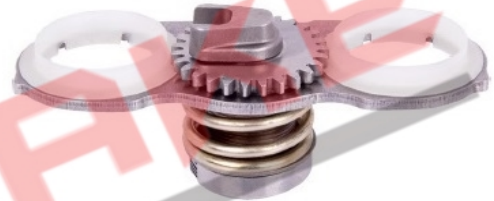

7055 / Adjusting Mechanism



7056 / Adjusting Gear

Ø 49,5 mm



7140 / Gasket



M8x45 mm

3729 / Bolt

**7096 / Caliper Pin Boot Set**

ELSA 195-225-EX225 / ELSA 2 / B DUCO / C-LE DUCO / D DUCO



3014 / Pin Boot

**7097 / Caliper Eccentric Shaft Set  
DX 195 / DX 225 Type**

CMSK.2.GR



3787 / Crank



3788 / Seal



3822 / Bearing

**7098 / Caliper Bridge Assembly  
DX 195 Type**

CMSK.19.1



163 mm

**7099 / Caliper Bearing Saddle Set  
ELSA 2 / ELSA 195-225-EX225 Type**



3016 / Bearing Cap





**7103 / Caliper Full Repair Kit Front - Right**

**D3 Type**

**7222 / Caliper Repair Set Front - Right**



**7071 / Caliper Pin Repair Kit**



**7074 / Caliper Brake Lining Plate**



**7229 / Caliper Lever - 48 Teeth**



**7227 / Adjusting Mechanism Spring**



**3775 / Washer**



**3777 / Washer**



**3776 / Spring Housing**



**3773 / Seal**



**3774 / Circlip**



**3831 / Circlip**



**7104 / Caliper Bearing Set  
C LISA / D LISA Type**

MERITOR: SJ4031 / VOLVO: 8550893 / NISSAN: 69029760 / DENNIS: 6553778 - 6553779 / CMSK.14



3820 / Shaft Roller Bearing

3751 / Washer

3752 / Dust Excluder

3819 / Shaft Roller Bearing

3750 / Plain Bush

**7105 / Caliper Brake Lining Plate  
D LISA Type**

MRTR: SJ4117 - 68321441 / VLV: 3092765 / DNNS: 65537714 / NSSN: 69029810 CMSK.11.5



**7106 / Caliper Lever With Bearing Set - Left D  
DUCO Type**

MERITOR: SJ4096 - MCK1398 / VOLVO: 85109975 - 3092258 - 21109753 / CMSK.3.4



7013 / Roller Bearing

7108 / Caliper Lever

3703 / Sealing Ring Big

**7106-1 / Caliper Lever With Bearing Set - Right  
D DUCO Type**

MERITOR: SJ4097 - MCK1399 / VOLVO: 3092259 - 85109976 - 21109754 / CMSK.3.4



7013 / Roller Bearing

7107 / Caliper Lever

3703 / Sealing Ring Big

"OLD NUMBER / 7191"

**7107 / Caliper Lever With Bearings - Right  
D DUCO Type**



**7108 / Caliper Lever With Bearings - Left  
D DUCO Type**



**7109 / Caliper Pin Repair Kit  
ELSA 195-225-EX225 Type**

MERITOR: MCK1298 / VOLVO: 85109890 / RENAULT: 5001 866 989 / PACCAR: 9500931



**7109-1 / Caliper Pin Repair Kit  
ELSA 195-225-EX225 Type**

MERITOR: MCK1298 / VOLVO: 85109890 / RENAULT: 5001 866 989 / PACCAR: 9500931



**7110 / Caliper Pin Repair Kit  
ELSA 195-225-EX225 Type**

MERITOR: MCK1317 / VOLVO: 85109889







**7114 / Caliper Shaft Set - Left  
C / D LISA Type**

MERITOR: MCK1021 / MCK1151 / VOLVO: 85104827 / NSSN: 69029750 /  
DNNS: 6553776 / CMSK.11V



**7115 / Caliper Shaft Set - Right  
C / D LISA Type**

MERITOR: MCK1022 - MCK1152 / VOLVO: 85104828 / NSSN: 69030040 /  
DNNS: 6553784 / CAMCK1152 / CMSK.12V



**7116 / Calibration Mechanism Cover  
ELSA 2 Type  
68323564**



**7117 / Caliper Plate Repair Kit - Right  
DX 195 Type  
CMSK.9.1**



3783 / Caliper Plate

M10x1,5x20 mm



4724 / Bolt

3781 / Pin Bolt Right

**7118 / Caliper Plate Repair Kit - Left  
DX 195 Type  
CMSK.9.2**



3783 / Caliper Plate

M10x1,5x20 mm



4724 / Bolt

3786 / Pin Bolt Left

**7119 / Caliper Mechanism Central Fork & Pinion  
DX 195 / DX 225 Type  
CMSK.19.3**



3813 / Caliper Mechanism Central Fork

3814  
Caliper Mechanism Pinion

**7121 / Caliper Cover Plate Set  
DX 195 / DX 225 Type**



3829 / Caliper Cover Plate  
( With Needle Bearing )



3778 / Gasket

M8x1,25x20 mm



4723 / Cover Bolt



4725  
Plug



4726  
Washer



**7122 / Caliper Shaft Housing Set - Right  
DX 195 Type**

MERITOR: MCK1293 / CATERPILLAR: 2799439 / DAF: 0876053

7098 / Caliper Bridge Assembly



7117 / Caliper Bush Plate Repair Kit  
Right



7127  
Caliper Piston & Pignon Set  
Right



7119 / Mechanism  
Central Fork & Pinion Set



**7123 / Caliper Shaft Housing Set - Left  
DX 195 Type**

MERITOR: MCK1292 / DAF: 0876052

7098 / Caliper Bridge Assembly



7118 / Caliper Bush Plate Repair Kit  
Left



7128  
Caliper Piston & Pignon Set  
Left



7119 / Mechanism  
Central Fork & Pinion Set



**7124 / Caliper Adjusting Minor Repair Kit - Right  
DX 195 Type**

DSB5R / FRUEHAUF: CF104619 / CMSK.2.E

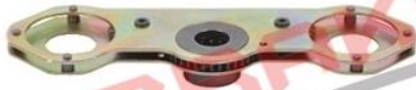

3792 / Adjusting Mechanism - Right



3793 / Seal Green



3795 / Calibration Bolt



3796 / Spring



3797 / Clamp



3794 / Washer

**7125 / Caliper Adjuster Minor Repair Kit - Left  
DX 195 Type**

DSB5L / FRUEHAUF: CF104620 / CMSK.2.F

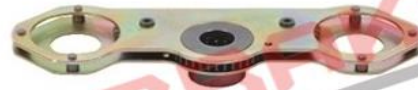

3798 / Adjusting Mechanism - Left



3793 / Seal Green



3795 / Calibration Bolt



3796 / Spring



3797 / Clamp



3794 / Washer

**7126 / Caliper Eccentric Shaft With Ball  
DX 195 / DX 225 Type**

MERITOR: MCK1294 / CMSK.2R

3787 / Crank



7101 / Roller Bearing

7121 / Caliper Cover Plate Set



**7127 / Caliper Piston & Pignon Set - Right  
DX 195 Type**

CMSK.19.2



3779 / Caliper Piston Right

**7128 / Caliper Piston & Pignon Set - Left**  
DX 195 Type

CMSK.20.2



3785 / Caliper Piston Left

**7129 / Small Gear Mechanism Set - Left**  
ELSA 1 / B DUCO / C-LE DUCO / D DUCO Type

VOLVO: 3092281 / 68322562 / CMSK.5.2



**7130 / Small Gear Mechanism Set - Right**  
ELSA 1 / B DUCO / C-LE DUCO / D DUCO Type

VOLVO: 3092280 / 68322563 / CMSK.5.3



**7131 / Caliper Visual Indicator**  
B DUCO / C-LE DUCO / B DUCO Type

MERITOR: SJ4111 / VOLVO:3092283 / CMSK.3.13



**7132 / Caliper Lever With Bearings**  
ELSA 195-225-EX225 Type

Back View



3740 / Caliper Lever

3012 / Lever Bush

3013 / Ball Bearing

**7133 / Caliper Clutch System - Right**  
D3 Type

CMSK.24.3



3776 / Spring Housing

3775 / Washer

3767 / Spring - Right

3777 / Washer

**7134 / Caliper Clutch System - Left**  
D3 Type

CMSK.25.3

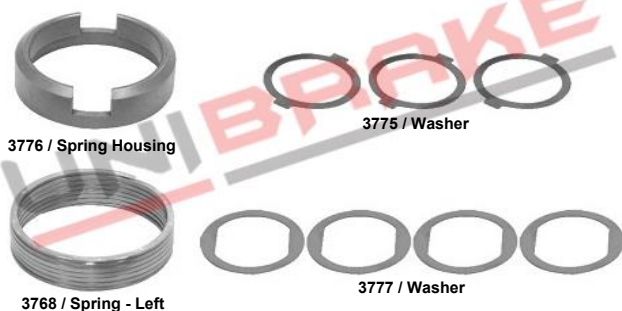

3776 / Spring Housing

3775 / Washer

3768 / Spring - Left

3777 / Washer

**7135 / Caliper Repair Kit**  
ELSA 2 / ELSA 195-225-EX225 Type

CMSK.7.4



3824 / Bushing

3826 / Washer

3825 / Seal



**7136 / Caliper Gasket  
ELSA 1 Type**



**7137 / Caliper Gasket  
ELSA 1 Type**



**7138 / Caliper Gasket  
ELSA 1 Type**



**7139 / Stabilizer Bar  
DX 195 / DX 225 Type**  
MERITOR: MCK1154 / CMSK.2.H



**7140 / Caliper Gasket  
ELSA 195-225-EX225 Type**



**7141 / Caliper Visual Indicator With Screw Set  
ELSA 2 Type**

MERITOR: MCK1240 / RNL: 5021 177 423 / MN: N2509990107 - 33.50307.5665  
CMSK.8.13



**7142 / Caliper Guide & Bush Repair Kit  
C LISA Type**

MERITOR: SJ4052 / DAF: 1522192 / RENAULT: 5001 845 385 / NISSAN: 69029720 / CMSK.54

Ø34xØ30/31  
26 mm



**7143 / Brake Pad Retainer Repair Kit  
ELSA 1 Type**

MERITOR: MCK1262 / MN: 81.50822.0007 / RNL: 503128759



**7144 / Brake Pad Retainer Repair Kit  
C-LE DUCO / D DUCO / B DUCO Type**

MERITOR: MCK1264 / VOLVO: 3092276 - 3092277 / CMSK.3.12



**7145 / Caliper Visual Indicator  
ELSA 195-225-EX225 Type**

MERITOR: MCK1311 / VOLVO: 85109893 / RVI: 7485 109 893



Ø14 x 80 mm

3017 / Caliper Visual Indicator

3018 / Spring



**7146 / Old Model Caliper Full Repair Set - Right  
ELSA 1 Type**

7012-1 / Caliper Adjusting Gear Set - Right



7002 / Caliper Boot & Pin Repair Kit



7004 / Locking Shim



7163 / Caliper Lever Return Spring Set  
Right



7136 / Caliper Gasket



7061 / Caliper Adjusting Mechanism



7060 / Adjusting Mechanism  
Clutch System - Right



7014 / Caliper Bearing Set



**7147 / Old Model Caliper Full Repair Set - Left  
ELSA 1 Type**

7012 / Caliper Adjusting Gear Set - Left



7002 / Caliper Boot & Pin Repair Kit



7004 / Locking Shim



7164 / Caliper Lever Return Spring Set  
Left



7136 / Caliper Gasket



7061 / Caliper Adjusting Mechanism



7059 / Adjusting Mechanism  
Clutch System - Left



7014 / Caliper Bearing Set



**7148 / New Model Caliper Full Repair Set Right  
ELSA 1 Type**

7008-1 / Caliper Adjusting Gear Set - Right



7000 / Caliper Pin Repair Kit



7004 / Locking Shim



7163  
Lever Return Spring Set Right



7044 / Dust Cover Set



7138 / Caliper Gasket



7061 / Caliper Adjusting Mechanism

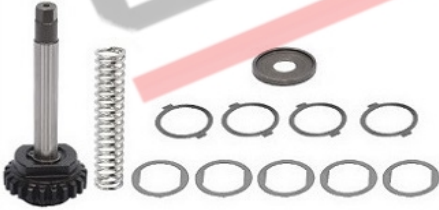

7060 / Adjusting Mechanism Clutch  
System - Right



7014 / Caliper Bearing Set



**7149 / New Model Caliper Full Repair Set - Left  
ELSA 1 Type**

7008 / Caliper Adjusting Gear Set - Left



7000 / Caliper Pin Repair Kit



7004 / Locking Shim



7164  
Lever Return Spring Set - Left



7044 / Dust Cover Set



7138 / Caliper Gasket



7061 / Caliper Adjusting Mechanism

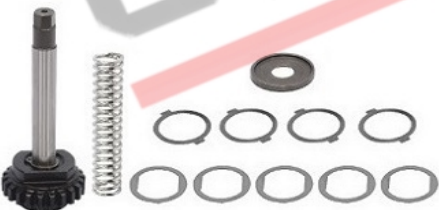

7059 / Adjusting Mechanism Clutch  
System - Left



7014 / Caliper Bearing Set





**7150 / Old Model Caliper Full Repair Set - Right**  
**ELSA 2 Type**  
RENAULT 420

7052 / Caliper Adjusting Mechanism Set



7023 / Caliper Boot & Pin Repair Kit



7014 / Caliper Bearing Set



7043 / Caliper Dust Cover Kit



7243 / Caliper Visual Indicator

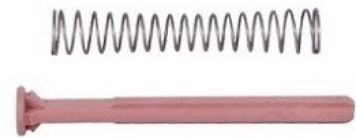

7057 / Manuel Adjusting Gear - Right

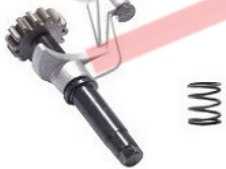

7099 / Caliper Bearing Saddle Set



7167 / Caliper Rubber Plug With Rings



7175 / Caliper Seal



**7150-1 / Old Model Caliper Full Repair Set - Right**  
**ELSA 2 Type**  
RENAULT 420

7052 / Caliper Adjusting Mechanism Set



7023-1 / Caliper Boot & Pin Repair Kit



7014 / Caliper Bearing Set



7043 / Caliper Dust Cover Kit



7243 / Caliper Visual Indicator

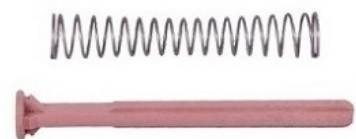

7057 / Manuel Adjusting Gear - Right



7099 / Caliper Bearing Saddle Set



7167 / Caliper Rubber Plug With Rings



7175 / Caliper Seal



**7151 / New Model Full Repair Set - Left**  
**ELSA 2 Type**  
RENAULT 420 MAN TGA

**7052 / Caliper Adjusting Mechanism Set**



**7023 / Caliper Boot & Pin Repair Kit**



**7014 / Caliper Bearing Set**



**7043 / Caliper Dust Cover Kit**



**7243 / Caliper Visual Indicator**

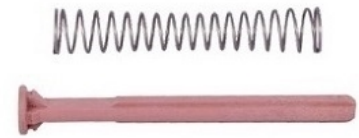

**7058 / Manuel Adjusting Gear - Left**



**7099 / Caliper Bearing Saddle Set**



**7167 / Caliper Rubber Plug With Rings**



**7175 / Caliper Seal**



**7151-1 / New Model Full Repair Set - Left**  
**ELSA 2 Type**  
RENAULT 420 MAN TGA

**7052 / Caliper Adjusting Mechanism Set**



**7023-1 / Caliper Boot & Pin Repair Kit**



**7014 / Caliper Bearing Set**



**7043 / Caliper Dust Cover Kit**



**7243 / Caliper Visual Indicator**

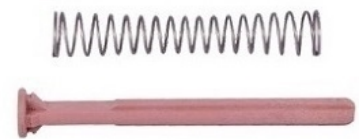

**7058 / Manuel Adjusting Gear - Left**



**7099 / Caliper Bearing Saddle Set**



**7167 / Caliper Rubber Plug With Rings**



**7175 / Caliper Seal**





**7152 / New Model Caliper Full Repair Set - Right  
ELSA 2 Type**



**7153 / New Model Caliper Full Repair Set - Left  
ELSA 2 Type**



**7154 / Caliper Full Repair Set  
ELSA 195-225-EX225 Type**

RENAULT 440

**7095 / Caliper Adjusting Mechanism Set**



**7111 / Caliper Pin Repair Kit**



**7014 / Caliper Bearing Set**



**7043 / Caliper Dust Cover Kit**



**7145 / Caliper Visual Indicator**



**7092 / Manuel Adjusting Gear**

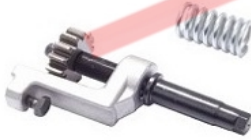

**7099 / Caliper Bearing Saddle Set**



**7167 / Caliper Rubber Plug With Rings**



**7175 / Caliper Seal**



**7154-1 / Caliper Full Repair Set  
ELSA 195-225-EX225 Type**

RENAULT 440

**7095 / Caliper Adjusting Mechanism Set**



**7111-1 / Caliper Pin Repair Kit**



**7014 / Caliper Bearing Set**



**7043 / Caliper Dust Cover Kit**



**7145 / Caliper Visual Indicator**



**7092 / Manuel Adjusting Gear**

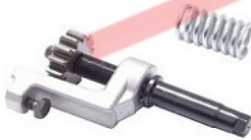

**7099 / Caliper Bearing Saddle Set**



**7167 / Caliper Rubber Plug With Rings**



**7175 / Caliper Seal**





**7155 / Caliper Full Repair Set - Right  
D LISA Type**



**7156 / Caliper Full Repair Set - Left  
D LISA Type**



**7157 / Caliper Full Repair Set - Right  
DX 195 Type**

**7087 / Caliper Boot & Pin Repair Kit**



**7097 / Caliper Eccentric Shaft Set**



**7098 / Caliper Bridge Assembly**



**7117 / Caliper Plate Repair Kit  
Right**



**7124 / Caliper Adjusting Minor Repair Kit  
Right**



**7127 / Piston & Pignon Set  
Right**



**7119  
Mechanism Central Fork & Pinion Set**



**7101  
Caliper Roller Bearing**



**7190 / Caliper Shaft Lever  
80 mm**



**3829 / Caliper Cover Plate  
( With Needle Bearing )**



**7185  
Caliper Seal**



**7184  
Caliper Eccentric  
Shaft Dust Cover**



**3830  
Caliper Eccentric  
Shaft Bevel Washer**



**7158 / Caliper Full Repair Set - Left  
DX 195 Type**

**7087 / Caliper Boot & Pin Repair Kit**



**7097 / Caliper Eccentric Shaft Set**



**7098 / Caliper Bridge Assembly**



**7118 / Caliper Plate Repair Kit - Left**



**7125 / Caliper Adjuster Minor Repair Kit  
Left**



**7128 / Piston & Pignon Set  
Left**



**7119  
Mechanism Central Fork & Pinion Set**



**7101  
Caliper Roller Bearing**



**7190 / Caliper Shaft Lever  
80 mm**



**3829 / Caliper Cover Plate  
( With Needle Bearing )**



**7185  
Caliper Seal**



**7184  
Caliper Eccentric  
Shaft Dust Cover**



**3830  
Caliper Eccentric  
Shaft Bevel Washer**





**7159 / Caliper Full Repair Set - Right**  
**D DUCO Type**

7038 / Caliper Guide & Repair Kit



7033 / Caliper Adjusting Mechanism Set - Right



3707 / Gasket



7027 / Adjusting Mechanism Shaft - Right

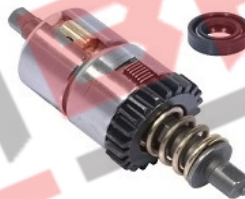

7130 / Small Gear Mechanism Set - Right



7049 / Caliper Shaft Gear Set



3703 Sealing Ring



3823 Plug



7131 Caliper Visual Indicator

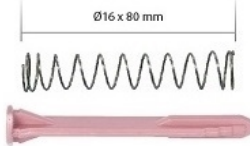

7170 / Caliper Bearing Set



7050 / Caliper Anti Rotation Plate



**7159-1 / Caliper Full Repair Set - Right**  
**D DUCO Type**

7038-1 / Caliper Guide & Repair Kit



7033 / Caliper Adjusting Mechanism Set - Right



3707 / Gasket



7027 / Adjusting Mechanism Shaft - Right

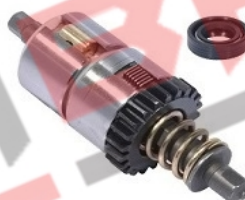

7130 / Small Gear Mechanism Set - Right



7049 / Caliper Shaft Gear Set



3703 Sealing Ring



3823 Plug



7131 Caliper Visual Indicator

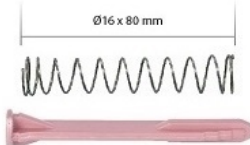

7170 / Caliper Bearing Set











7050 / Caliper Anti Rotation Plate

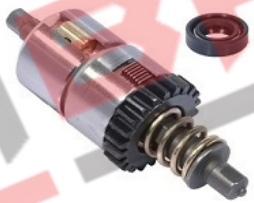

**7160 / Caliper Full Repair Set - Left  
D DUCO Type**



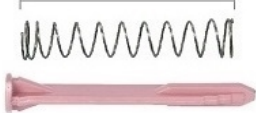







<p><b>7038 / Caliper Guide &amp; Repair Kit</b></p> 		<p><b>7034 / Caliper Adjusting Mechanism Set - Left</b></p> 			
<p><b>3707 / Gasket</b></p> 		<p><b>7028 / Adjusting Mechanism Shaft - Left</b></p> 	<p><b>7129 / Small Gear Mechanism Set - Left</b></p> 	<p><b>7049 / Caliper Shaft Gear Set</b></p> 	
<p><b>3703 Sealing Ring</b></p> 	<p><b>3823 Plug</b></p> 	<p><b>7131 Caliper Visual Indicator</b> Ø16 x 80 mm</p> 	<p><b>7170 / Caliper Bearing Set</b></p> 		<p><b>7050 / Caliper Anti Rotation Plate</b></p> 

**7160-1 / Caliper Full Repair Set - Left  
D DUCO Type**

<p><b>7038-1 / Caliper Guide &amp; Repair Kit</b></p> 		<p><b>7034 / Caliper Adjusting Mechanism Set - Left</b></p> 			
<p><b>3707 / Gasket</b></p> 		<p><b>7028 / Adjusting Mechanism Shaft - Left</b></p> 	<p><b>7129 / Small Gear Mechanism Set - Left</b></p> 	<p><b>7049 / Caliper Shaft Gear Set</b></p> 	
<p><b>3703 Sealing Ring</b></p> 	<p><b>3823 Plug</b></p> 	<p><b>7131 Caliper Visual Indicator</b> Ø16 x 80 mm</p> 	<p><b>7170 / Caliper Bearing Set</b></p> 		<p><b>7050 / Caliper Anti Rotation Plate</b></p> 



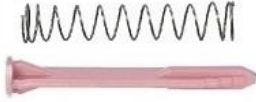









**7161 / Caliper Full Repair Set - Right  
D DUCO Type / VOLVO**

<p><b>7037 / Caliper Guide &amp; Bush Repair Kit</b></p> 		<p><b>7033 / Caliper Adjusting Mechanism Set - Right</b></p> 		
<p><b>3706 / Gasket</b></p> 	<p><b>7027 / Adjusting Mechanism Shaft - Right</b></p> 	<p><b>7130 / Small Gear Mechanism Set - Right</b></p> 	<p><b>7049 / Caliper Shaft Gear Set</b></p> 	
<p><b>3703 Sealing Ring</b></p> 	<p><b>3705 Plug</b></p> 	<p><b>7131 Caliper Visual Indicator</b></p> <p>Ø16 x 80 mm</p> 	<p><b>7014 / Caliper Bearing Set</b></p> 	<p><b>7050 / Caliper Anti Rotation Plate</b></p> 

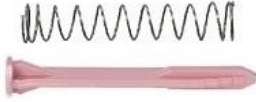

**7161-1 / Caliper Full Repair Set - Right  
D DUCO Type / VOLVO**

<p><b>7037-1 / Caliper Guide &amp; Bush Repair Kit</b></p> 		<p><b>7033 / Caliper Adjusting Mechanism Set - Right</b></p> 		
<p><b>3706 / Gasket</b></p> 	<p><b>7027 / Adjusting Mechanism Shaft - Right</b></p> 	<p><b>7130 / Small Gear Mechanism Set - Right</b></p> 	<p><b>7049 / Caliper Shaft Gear Set</b></p> 	
<p><b>3703 Sealing Ring</b></p> 	<p><b>3705 Plug</b></p> 	<p><b>7131 Caliper Visual Indicator</b></p> <p>Ø16 x 80 mm</p> 	<p><b>7014 / Caliper Bearing Set</b></p> 	<p><b>7050 / Caliper Anti Rotation Plate</b></p> 

**7162 / Caliper Full Repair Set - Left**  
**D DUCO Type / VOLVO**

<p><b>7037 / Caliper Guide &amp; Bush Repair Kit</b></p> 		<p><b>7034 / Caliper Adjusting Mechanism Set - Left</b></p> 		
<p><b>3706 / Gasket</b></p> 	<p><b>7028 / Adjusting Mechanism Shaft - Left</b></p> 	<p><b>7129 / Small Gear Mechanism Set - Left</b></p> 	<p><b>7049 / Caliper Shaft Gear Set</b></p> 	
<p><b>3703 Sealing Ring</b></p> 	<p><b>3705 Plug</b></p> 	<p><b>7131 Caliper Visual Indicator</b></p> <p>Ø16 x 80 mm</p> 	<p><b>7014 / Caliper Bearing Set</b></p> 	<p><b>7050 / Caliper Anti Rotation Plate</b></p> 

**7162-1 / Caliper Full Repair Set - Left**  
**D DUCO Type / VOLVO**

<p><b>7037-1 / Caliper Guide &amp; Bush Repair Kit</b></p> 		<p><b>7034 / Caliper Adjusting Mechanism Set - Left</b></p> 		
<p><b>3706 / Gasket</b></p> 	<p><b>7028 / Adjusting Mechanism Shaft - Left</b></p> 	<p><b>7129 / Small Gear Mechanism Set - Left</b></p> 	<p><b>7049 / Caliper Shaft Gear Set</b></p> 	
<p><b>3703 Sealing Ring</b></p> 	<p><b>3705 Plug</b></p> 	<p><b>7131 Caliper Visual Indicator</b></p> <p>Ø16 x 80 mm</p> 	<p><b>7014 / Caliper Bearing Set</b></p> 	<p><b>7050 / Caliper Anti Rotation Plate</b></p> 



**7163 / Caliper Lever Return Spring Set - Right**  
**ELSA 1 Type**  
CMSK.5.12



**7164 / Caliper Lever Return Spring Set - Left**  
**ELSA 1 Type**  
CMSK.5.11



**7165 / Caliper Rubber & Screw Set**  
**ELSA 2 Type**

MERITOR: MCK1244 / RENAULT: 5001 858 718 - 5001 860 792 / CMSK.7.15



**7166 / Caliper Rubber & Screw Set**  
**ELSA 2 / ELSA 195-225 Type**

MERITOR: MCK1088 / MAN: 35.50307.5636 - N2965026008 / CMSK.46.1



**7167 / Caliper Rubber Plug With Rings**  
**ELSA 2 / ELSA 195-225-EX225**  
**B DUCO / C-LE DUCO / D DUCO Type**



**7168 / Caliper Adjusting Mechanism Cap Big**  
**ELSA 2 Type**



**7169 / Manuel Adjusting Gear**  
ELSA 195-225-EX225 Type  
CMSK.7.11.2



**7170 / Caliper Bearing Set**  
D DUCO / ELSA 2 Type  
MERITOR: SJ4098 / VOLVO: 3092261 / CMSK.98.3

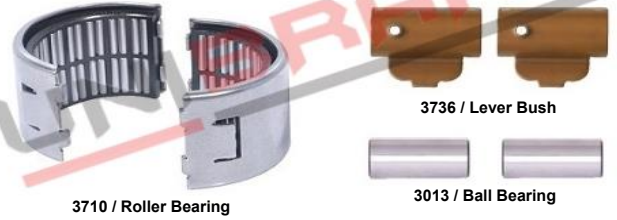

**7171 / Caliper Adjusting Mechanism Set**  
ELSA 2 Type



Complete Set



7116 / Calibration Mechanism Cover



7172 / Caliper Adjusting Mechanism



7173 / Caliper Adjusting Gear



7039 / Gasket

M8x45 mm



3727 / Bolt

**7172 / Caliper Adjusting Mechanism**  
ELSA 2 Type



**7173 / Caliper Adjusting Gear Single**  
ELSA 2 Type





**7174 / Caliper Lever With Bearings**  
ELSA 195-225-EX225 Type



**7175 / Caliper Seal**  
ELSA 195-225-EX225 / ELSA 2 Type



**7176 / Caliper Seal**  
ELSA 2 Type

MERITOR: 68323746PK10



**7177 / Brake Pad Retainer Repair Kit**  
ELSA 195-225-EX225 / ELSA 2 Type

MERITOR: MCK1174 / VOLVO: 85107958 / RENAULT: 5001 858 719 - 5001 866 486  
MAN: 81.50822.0014 - 06.01771.8107 - 35.50307.5700 / DAF: 868303  
IVECO: 503131342 / ZF: 0501321591 / CMSK.44.12



**7178 / Caliper Boot & Seal Set**  
C LISA / D LISA Type

MERITOR: SJ4078 - SJ4032 / VOLVO:3098113 - 3097526 - 8550895 / DENNIS: 6565643 - 6553773 / DEP100080 / CMSK.7



**7179 / Caliper Boot & Seal Set**  
C LISA Type



**7180 / Caliper Pin Boot Set**

D LISA / B DUCO / C-LE DUCO / D DUCO / C LISA Type

MERITOR: SJ4077 / DENNIS: 6565644 / VOLVO:3098109 / DAF: 1524607



7096 / Pin Boot Kit

7212 / Pin Boot Kit

**7181 / Caliper Brake Lining Plate  
C LISA Type**



**7182 / Caliper Shaft Adjustment Mechanism  
C LISA / DLISA Type**

MERITOR: 68915080 - 68915081 / DENNIS: 6565645 - 6565646



**7183 / Caliper Boot Repair Kit  
DX 195 Type**



4717 / Pin Boot

4720 / Dust Rubber Small

4716 / Tappet Big Boot

**7184 / Caliper Eccentric Shaft Dust Cover  
DX 195 / DX 225 Type**



**7185 / Caliper Seal  
DX 195 / DX 225 Type**



**7186 / Caliper Shaft Housing Set - Right  
DX 195 Type**

DSL6R / CMSK.19



7098 / Caliper Bridge Assembly

7119 Mechanism Central Fork & Pinion Set

7127 / Caliper Piston & Pignon Set

**7187 / Caliper Shaft Housing Set - Left  
DX 195 Type**

DSL6L / CMSK.20



7098 / Caliper Bridge Assembly

7119 Mechanism Central Fork & Pinion Set

7128 / Caliper Piston & Pignon Set



**7188 / Caliper Mechanism Repair Kit - Right  
DX 195 Type**

MERITOR: MCK1291 / CATERPILLAR: 2799438 / DAF: 0876051

7124 / Caliper Adjusting Minor Repair Kit - Right

7119  
Mechanism Central  
Fork & Pinion Set



**7189 / Caliper Mechanism Repair Kit - Left  
DX 195 Type**

MERITOR: MCK1290 / DF: 0876050

7125 / Caliper Adjusting Minor Repair Kit - Left

7119  
Mechanism Central  
Fork & Pinion Set



**7190 / Caliper Shaft Lever / 80 mm  
DX 195 / DX 225 Type**

MERITOR: MCK1160 / MN: N250990221 - STRMCK1160 / DF: 1675768 / VLVO:AMMCK1160 / RNL: 5021 139 150 - 5021 170 882



**7192 / Caliper Bearing Set  
DX 195 / DX 225 Type**

MRTR: MCK1344 / ASTRA: 98133545AS / CTRPLLR: 3429202 / BRDMNRNBS: 193107 / CMSK.2.D

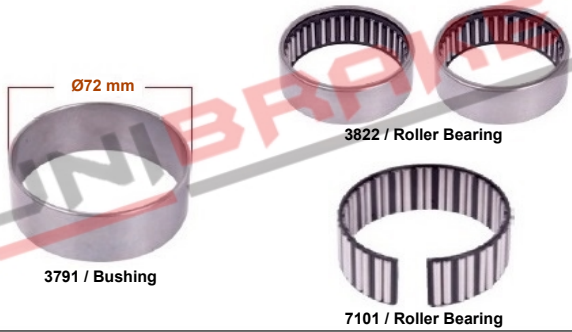

**7193 / Caliper Bushing Kit  
DX 195 / DX 225 Type**



**7194 / Caliper Washer Set  
DX 195 / DX 225 Type**



**7195 / Brake Pad Retainer Repair Kit  
DX 195 / DX 225 Type**



**7196 / Caliper Boot & Pin Repair Kit**  
**DX 225 Type**

MERITOR: MCK1172 / BREDAMENARINIBUS: 193108



**7197 / Caliper Boot & Pin Bolt Repair Kit**  
**DX 225 Type** / MRTR: MCK1193 / BRDMNRNBS: 193102

Ø42x31 mm



**7198 / Caliper Boots Repair Kit**  
**DX 225 Type**



**7199 / Caliper Shaft Housing Set - Right**  
**DX 225 Type**

7211 / Caliper Bridge Assembly

169 mm



7119  
Mechanism Central Fork & Pinion Set



7203 / Caliper Bush Plate Repair Kit - Right



7205 / Caliper Piston & Pignon Set - Right



**7200 / Caliper Shaft Housing Set - Left**  
**DX 225 Type**

7211 / Caliper Bridge Assembly

169 mm



7119  
Mechanism Central Fork & Pinion Set



7204 / Caliper Bush Plate Repair Kit - Left



7206 / Caliper Piston & Pignon Set - Left





**7201 / Caliper Shaft Housing Set - Right**  
**DX 225 Type**

7211 / Caliper Bridge Assembly



7119 / Mechanism Central Fork & Pinion Set



7205 / Caliper Piston & Pignon Set - Right



**7202 / Caliper Shaft Housing Set - Left**  
**DX 225 Type**

7211 / Caliper Bridge Assembly



7119 / Mechanism Central Fork & Pinion Set



7206 / Caliper Piston & Pignon Set - Left



**7203 / Caliper Bush Plate Repair Kit - Right**  
**DX 225 Type**



3781 / Pin Bolt - Right

M10x1,5x20 mm



4724 / Bolt



3808 / Caliper Plate

**7204 / Caliper Bush Plate Repair Kit - Left**  
**DX 225 Type**



3786 / Caliper Bolt - Left

M10x1,5x20 mm



4724 / Caliper Bolt



3808 / Caliper Plate

**7205 / Caliper Piston & Pignon Set - Right**  
**DX 225 Type**



3811 / Caliper Piston Right

**7206 / Caliper Piston & Pignon Set - Left**  
**DX 225 Type**



3828 / Caliper Piston Left

**7207 / Caliper Adjuster Minor Repair Kit - Right  
DX 225 Type**



**7208 / Caliper Adjuster Minor Repair Kit - Left  
DX 225 Type**



**7209 / Caliper Adjuster Repair Kit - Right  
DX 225 Type**



**7210 / Caliper Adjuster Repair Kit - Left  
DX 225 Type**



**7211 / Caliper Bridge Assembly  
DX 225 Type**



**7212 / Caliper Pin Boot Kit  
ELSA 1 / D LISA Type  
SJ4053**



**7213 / Calibration Mechanism Set  
B DUCO Type**

MERITOR: MCK1050 / VOLVO: 3095646 / CSMK.52.16



**7214 / Caliper Lever With Bearings - Right  
C-LE DUCO Type**







**7222 / Caliper Repair Set Front - Right  
D3 Type**



**7223 / Caliper Repair Set Front - Left  
D3 Type**





**7224 / Caliper Adjusting Gear Kit - Right  
D3 Type**



**7225 / Caliper Adjusting Gear Kit - Left  
D3 Type**



**7226 / Caliper Seal Kit  
D3 Type**



**7227 / Caliper Adjusting Mechanism Spring  
D3 Type**



**7228 / Caliper Lever - 26 Teeth  
D3 Type**

MERITOR: 68321507 - 68321508 - 31932070 / MAN: 81.50812.0011 /  
VOLVO: 2111686 - 82854415090



**7229 / Caliper Lever - 48 Teeth  
D3 Type**

MERITOR: 68321502 / MAN: 81.50812.0009 / VOLVO: 10552713



**7230 / Caliper Full Repair Set - Right  
DX 225 Type**

<p><b>7196 / Caliper Boot &amp; Pin Repair Kit</b></p> <p>Inside 68 mm Inside 35 mm</p>		<p><b>7097 / Caliper Eccentric Shaft Set</b></p>		<p><b>7211 / Caliper Bridge Assembly</b></p> <p>169 mm</p>			
<p><b>7203 / Caliper Bush Plate Repair Kit Right</b></p>		<p><b>7207 / Caliper Adjuster Minor Repair Kit Right</b></p>		<p><b>7205 / Caliper Piston &amp; Pignon Set - Right</b></p>		<p><b>7119 Caliper Mechanism Central Fork &amp; Pinion</b></p>	
<p><b>7101 Caliper Roller Bearing</b></p>	<p><b>7190 / Caliper Shaft Lever 80 mm</b></p>	<p><b>3829 / Caliper Cover Plate (With Needle Bearing)</b></p>	<p><b>7185 Caliper Seal</b></p>	<p><b>7184 Caliper Eccentric Shaft Dust Cover</b></p>	<p><b>3830 Caliper Eccentric Shaft Bevel Washer</b></p>		

**7231 / Caliper Full Repair Set - Left  
DX 225 Type**

<p><b>7196 / Caliper Boot &amp; Pin Repair Kit</b></p> <p>Inside 68 mm Inside 35 mm</p>		<p><b>7097 / Caliper Eccentric Shaft Set</b></p>		<p><b>7211 / Caliper Bridge Assembly</b></p> <p>169 mm</p>			
<p><b>7204 / Caliper Bush Plate Repair Kit Left</b></p>		<p><b>7208 / Caliper Adjuster Minor Repair Kit Left</b></p>		<p><b>7206 / Caliper Piston &amp; Pignon Set - Left</b></p>		<p><b>7119 Caliper Mechanism Central Fork &amp; Pinion</b></p>	
<p><b>7101 Caliper Roller Bearing</b></p>	<p><b>7190 / Caliper Shaft Lever 80 mm</b></p>	<p><b>3829 / Caliper Cover Plate (With Needle Bearing)</b></p>	<p><b>7185 Caliper Seal</b></p>	<p><b>7184 Caliper Eccentric Shaft Dust Cover</b></p>	<p><b>3830 Caliper Eccentric Shaft Bevel Washer</b></p>		





**7240 / Calibration Gear Bushing  
ELSA 1 Type**

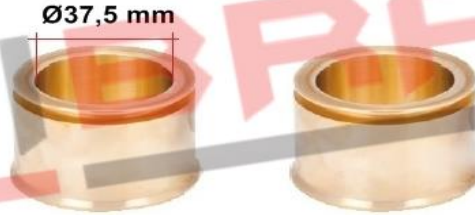

**7241 / Calibration Mechanism Right  
ELSA 1 Type**

MCK1212

7061 / Caliper Adjusting Mechanism

7236 / Mechanism Clutch System  
Right

3832  
Lever Pin

3833  
Lever Spring  
Retainer

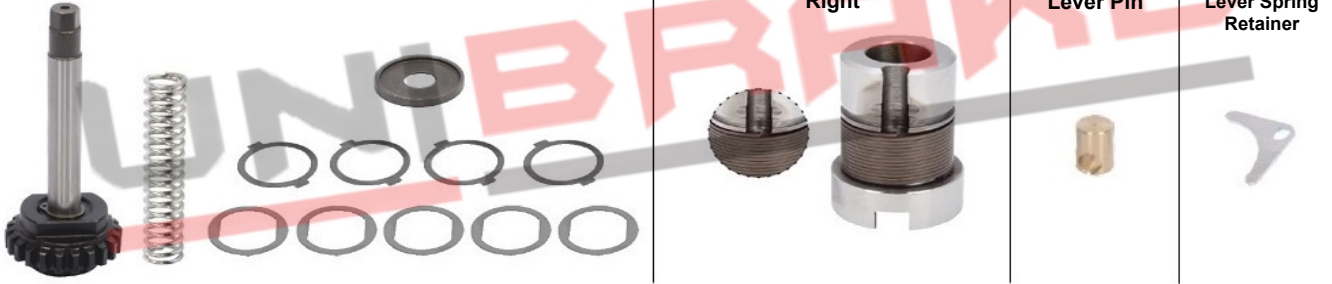

**7242 / Calibration Mechanism Left  
ELSA 1 Type**

MCK1211

7061 / Caliper Adjusting Mechanism

7237 / Mechanism Clutch System  
Left

3832  
Lever Pin

3833  
Lever Spring  
Retainer

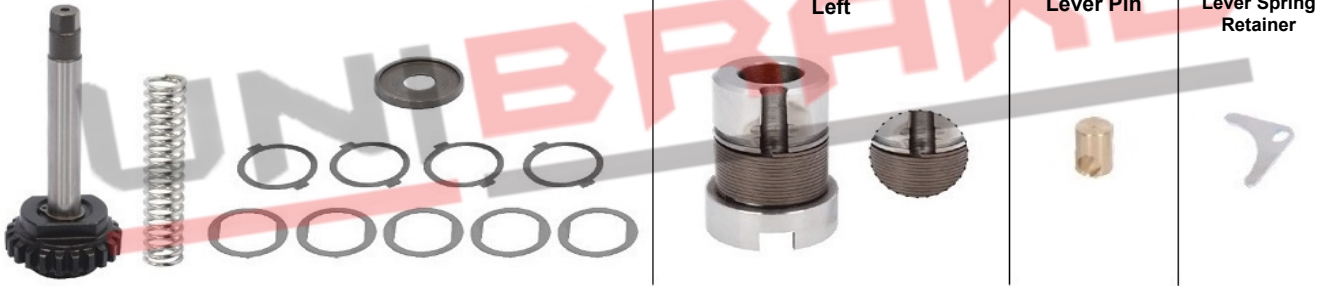

**7243 / Caliper Visual Indicator  
ELSA 2 Type**

Ø14 x 80 mm

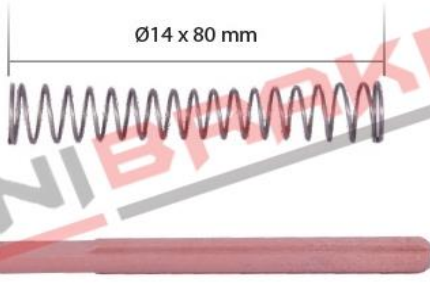

**7244 / Brake Pad Retainer Repair Kit  
B DUCO Type**





**7245 / Mechanism Clutch System - Right  
ELSA 1 Type**



**7246 / Mechanism Clutch System - Left  
ELSA 1 Type**



**7247 / Caliper Leveller - Right  
ELSA 1 Type**



3839 / Caliper Lever

3736 / Lever Bush

3013 / Ball Bearing

**7248 / Caliper Leveller - Left  
ELSA 1 Type**



3840 / Caliper Lever

3736 / Lever Bush

3013 / Ball Bearing

**7249 / Caliper Repair Kit  
ELSA 2 / ELSA 195-225-EX225  
B DUCO / C-LE DUCO / D DUCO Type  
MERITOR: MCK1352 / MST1504 / 68324331 / 68130055**



**7250 / Caliper Leveller  
ELSA 195-225-EX225 Type**



3842 / Caliper Lever

3841 / Lever Bush

3013 / Ball Bearing

**7251 / Caliper Guides & Seals Repair Kit  
D DUCO Type**

DAF: 1522166 / MERITOR: MCK1135 - SJ4107 / VOLVO: 3092256 - 3096788 - 85103891

Ø40xØ37x11 mm

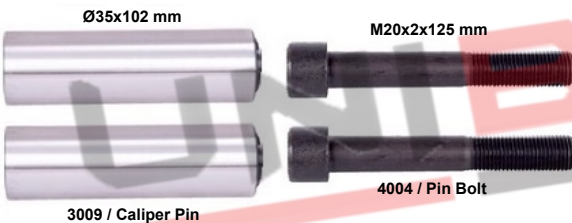

Ø35x102 mm

M20x2x125 mm

3009 / Caliper Pin

4004 / Pin Bolt

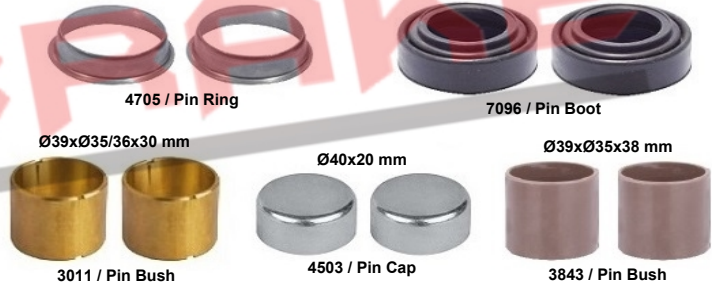

4705 / Pin Ring

7096 / Pin Boot

Ø39xØ35/36x30 mm

Ø40x20 mm

Ø39xØ35x38 mm

3011 / Pin Bush

4503 / Pin Cap

3843 / Pin Bush

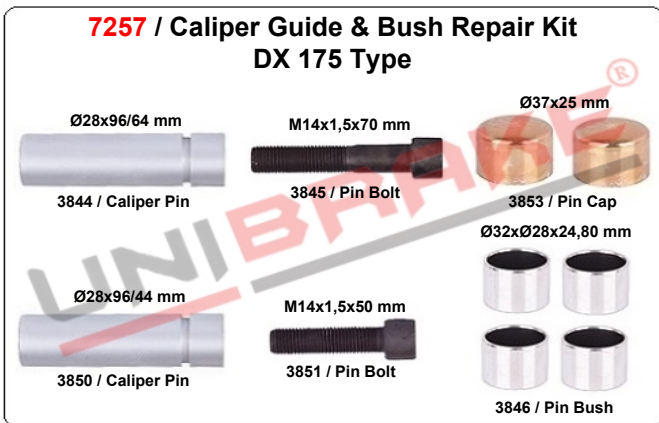
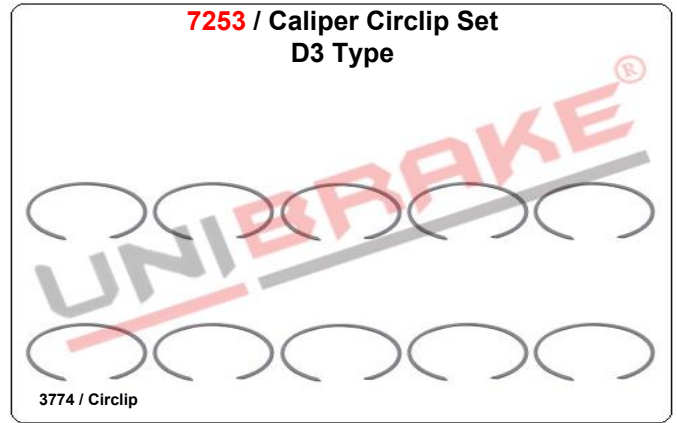





**7267 / Caliper Plate Repair Kit - Right  
DX 175 Type**



3865 / Caliper Plate



3855 / Bolt



3866 / Calibration Bolt - Right

**7268 / Caliper Plate Repair Kit - Left  
DX 175 Type**



3865 / Caliper Plate



3855 / Bolt



3867 / Calibration Bolt - Left

**7269 / Caliper Repair Kit - Right  
DX 175 Type**

7263 / Caliper Bridge Assembly



7265 / Caliper Pistons & Pinion Kit  
Right



7267 / Caliper Plate Repair Kit  
Right



7264  
Caliper Mechanism Central  
Fork & Pinion



**7270 / Caliper Repair Kit - Left  
DX 175 Type**

7263 / Caliper Bridge Assembly



7266 / Caliper Pistons & Pinion Kit  
Left



7268 / Caliper Plate Repair Kit  
Left



7264  
Caliper Mechanism Central  
Fork & Pinion



**7271 / Caliper Repair Kit - Right  
DX 175 Type**

7263 / Caliper Bridge Assembly



7265 / Caliper Pistons & Pinion Kit - Right



7264  
Caliper Mechanism Central  
Fork & Pinion





**7272 / Caliper Repair Kit - Left DX 175 Type**

7263 / Caliper Bridge Assembly

7266 / Caliper Pistons & Pinion Kit - Left

7264 / Caliper Mechanism Central Fork & Pinion

**7273 / Caliper Adjusting Mechanism Set - Right DX 175 Type**

3868 / Caliper Adjusting Mechanism Right

3870 / Washer

3793 / Seal Green

3871 / Ring

3795 / Bolt

3796 / Spring

**7274 / Caliper Adjusting Mechanism Set - Left DX 175 Type**

3869 / Caliper Adjusting Mechanism Left

3870 / Washer

3793 / Seal Green

3871 / Ring

3795 / Bolt

3796 / Spring

**7275 / Caliper Adjusting Mechanism Set - Right DX 175 Type**

7273 / Caliper Adjusting Mechanism Set - Right

7264 / Caliper Mechanism Central Fork & Pinion

3868 / Caliper Adjusting Mechanism Right

3870 / Washer

3793 / Seal Green

3871 / Ring

3795 / Bolt

3796 / Spring

**7276 / Caliper Adjusting Mechanism Set - Right DX 175 Type**

7274 / Caliper Adjusting Mechanism Set - Left

7264 / Caliper Mechanism Central Fork & Pinion

3869 / Caliper Adjusting Mechanism Left

3870 / Washer

3793 / Seal Green

3871 / Ring

3795 / Bolt

3796 / Spring

**7277 / Caliper Adjusting Shaft Repair Kit DX 175 Type**

3868 / Caliper Eccentric Shaft

7280 / Caliper Needle Bearing Kit

**7278 / Caliper Bearing Kit DX 175 Type**

7280 / Caliper Needle Bearing Kit

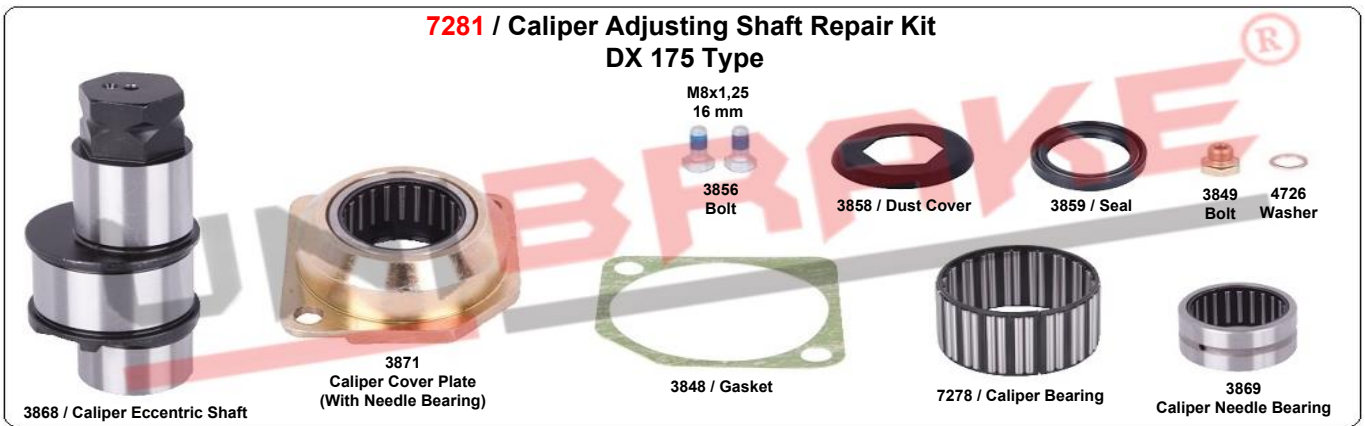



**7286 / Caliper Actuator & Plate - Left  
DX 175 Type**



**7287 / Caliper Repair Kit Complete - Right  
DX 175 Type**

**7256 / Caliper Guide & Bush Repair Kit**



**7273 / Caliper Adjusting Mechanism Set - Right**



**7269 / Caliper Repair Kir - Right**



**3868  
Caliper Eccentric Shaft**



**3858  
Dust Cover**



**3859 / Seal**



**3869 / Caliper  
Needle Bearing**



**3871 / Caliper Cover Plate  
(With Needle Bearing)**



**7278 / Caliper Bearing**



**7288 / Caliper Repair Kit Complete - Left  
DX 175 Type**

7256 / Caliper Guide & Bush Repair Kit



7274 / Caliper Adjusting Mechanism Set - Left



7270 / Caliper Repair Kit - Left



3868  
Caliper Eccentric Shaft



3858  
Dust Cover



3859 / Seal



3869 / Caliper  
Needle Bearing



3871 / Caliper Cover Plate  
(With Needle Bearing)



7278 / Caliper Bearing



**7289 / Caliper Repair Kit Complete - Right  
C LISA Type**

7142 / Caliper Guide & Bush Repair Kit



7181 / Caliper Brake Lining Plate

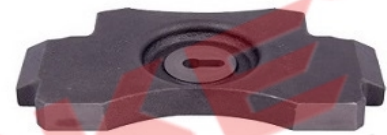

4016 / Plug



4015 / Seal



7182 / Caliper Lever



4014 / Cover Gasket



4017 / Dust Cover



4018 / Seal



4019 / Seal



4020  
Seal Cover



7104 / Caliper Bearing Set



7066 / Caliper Adjusting  
Mechanism - Right



7115 / Caliper Shaft Set - Right



7063 / Caliper Adjusting  
Gear - Right





**7290 / Caliper Repair Kit Complete - Left  
C LISA Type**



**7291 / Caliper Repair Kit  
D3 Type**



**7292 / Caliper Shaft Level / 90 mm  
DX 195 / DX 225 Type**

DAF: 1675766 / FRUEHAUF: CF103650 / MAN: N2509990223 /  
ERF: STRMCK1161 / ASTRA: 98133540AS / RENAULT: 5021 139 151 - 5021 170 883 /  
MCK1161



**7293 / Caliper Pin Bolt  
ELSA 1 Type**



**7294 / Caliper Repair Kit  
ELSA 195-225-EX225 Type**

KIT225221



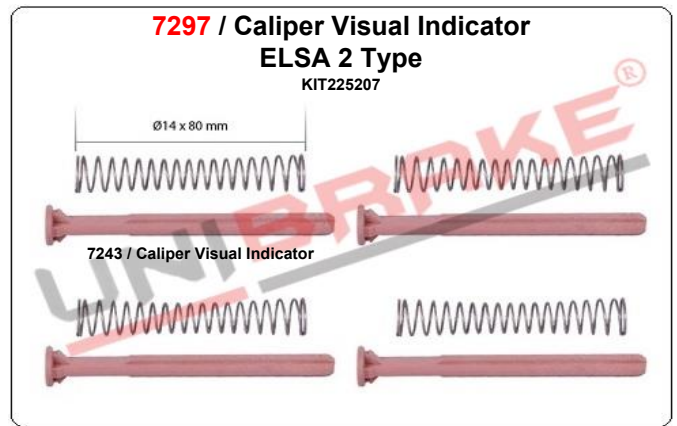



**7300 / Mechanism Clutch System - Right  
ELSA 1 Type**

MCK1210 / Renault: 503129554

7061 / Caliper Adjusting Mechanism

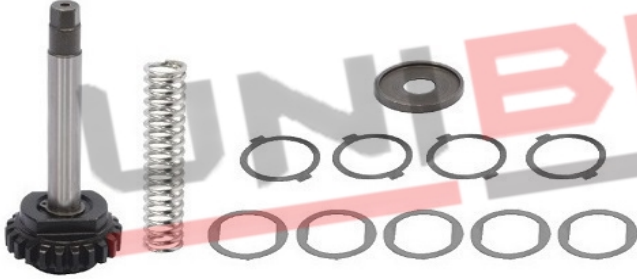

7245 / Mechanism Clutch System  
Right



3832  
Lever Pin



3833  
Lever Spring  
Retainer



**7301 / Mechanism Clutch System - Left  
ELSA 1 Type**

MCK1209 / Renault: 503129553

7061 / Caliper Adjusting Mechanism

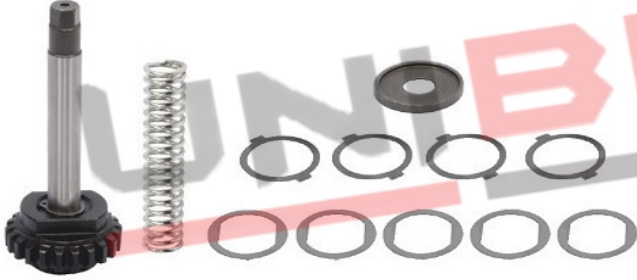

7246 / Mechanism Clutch System  
Left



3832  
Lever Pin



3833  
Lever Spring  
Retainer



**7302 / Caliper Repair Kit  
ELSA 2 Type**

MCK1087 / MAN: 35.50307.5607



**7303 / Caliper Pad Fitting Kit  
ELSA 2 Type**

MBA105 / VWA 29131



**7304 / Caliper Leveller  
ELSA 195-225-EX225 Type**



**7305 / Caliper Pad Fitting Kit  
ELSA 195-225-EX225 Type**

MBA112 / VLV: 85109894 / ELSA 225 FOR VWA 29174 - VWA 29218 - VWA 29273



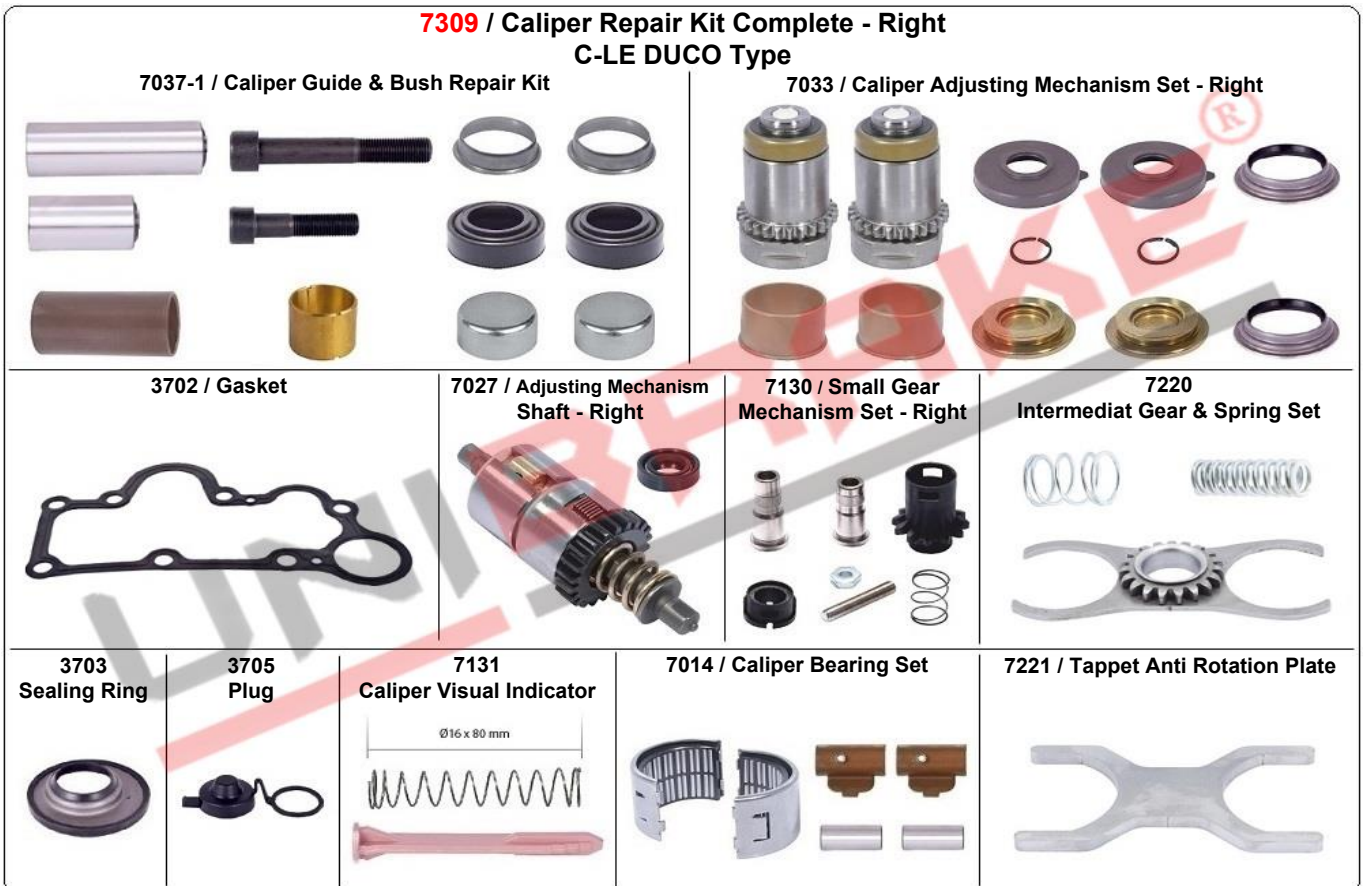



**7310 / Caliper Repair Kit Complete - Left**  
**C-LE DUCO Type**



**7311 / Caliper Pad Fitting Kit**  
**D DUCO Type**  
MBA104 / D DUCO FOR WVA 29125 - WVA 29277



**7312 / Caliper Pad Fitting Kit**  
**D LISA Type**  
SJ4022 / **RENAULT**: 5001 836 607



**7313 / Caliper Pad Fitting Kit**  
**D LISA Type**  
MBA101



**7314 / Caliper Actuator & Plate - Right**  
**DX 195 Type**



**7315 / Caliper Actuator & Plate - Left  
DX 195 Type**



**7316 / Caliper Actuator & Plate - Right  
DX 225 Type**



**7317 / Caliper Actuator & Plate - Left  
DX 225 Type**



**7318 / Caliper Pad Fitting Kit  
C-LE DUCO Type**

MBA103 / VOLVO: 85109445 / C DUCO FOR WVA 29137





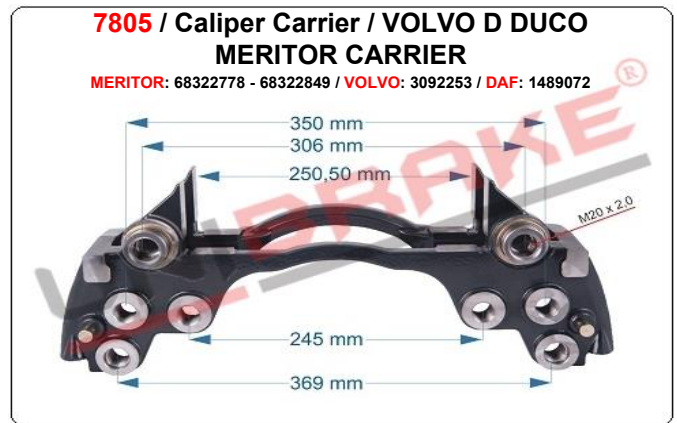
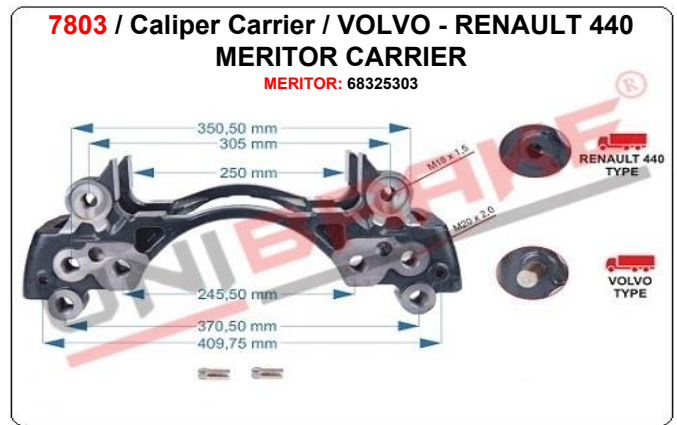
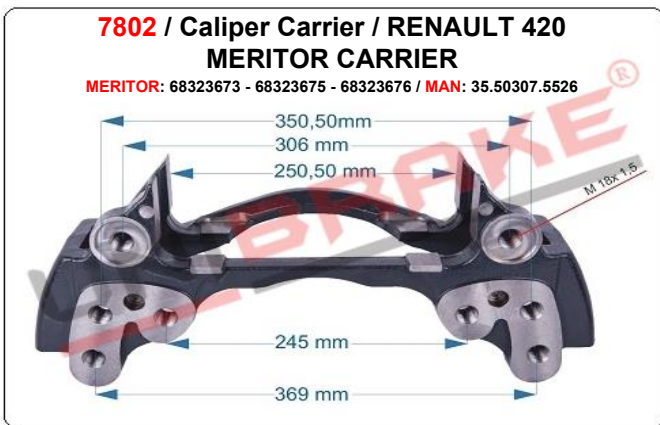
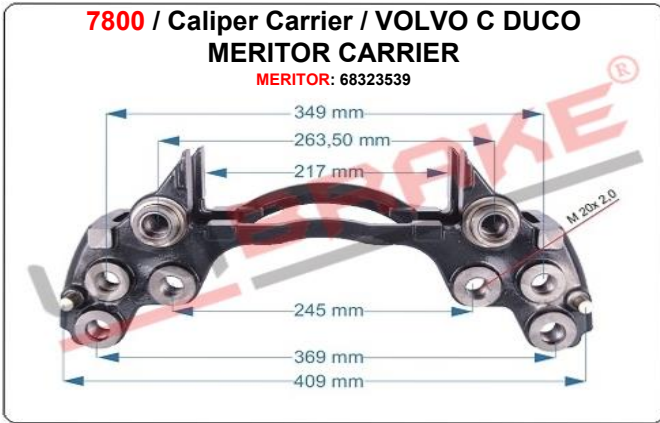

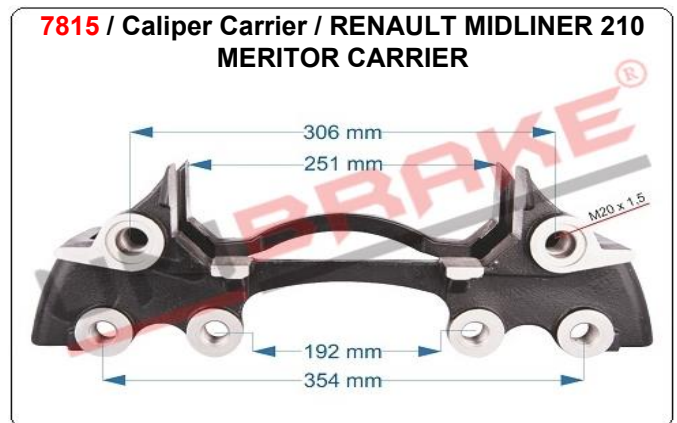
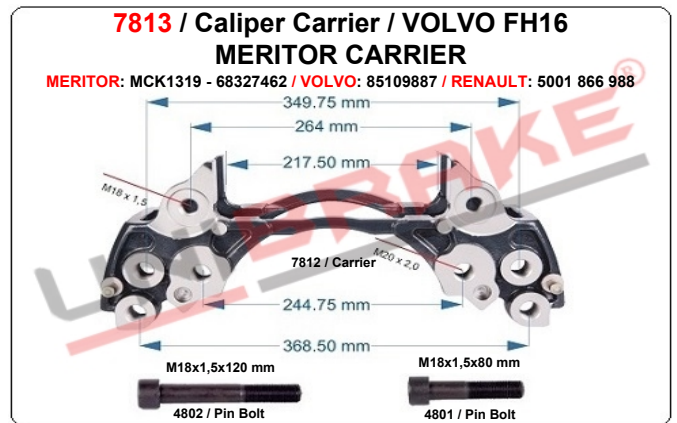
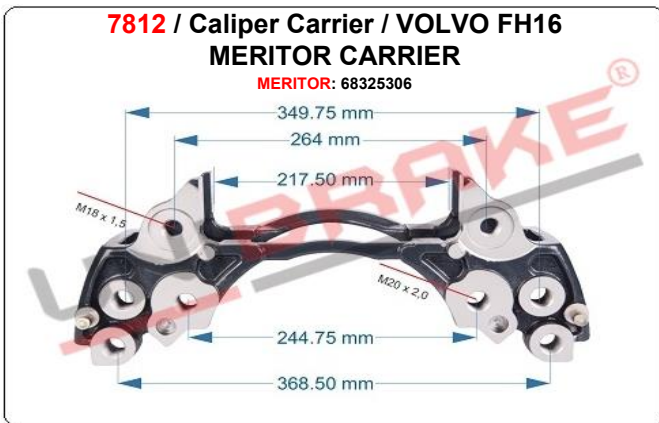
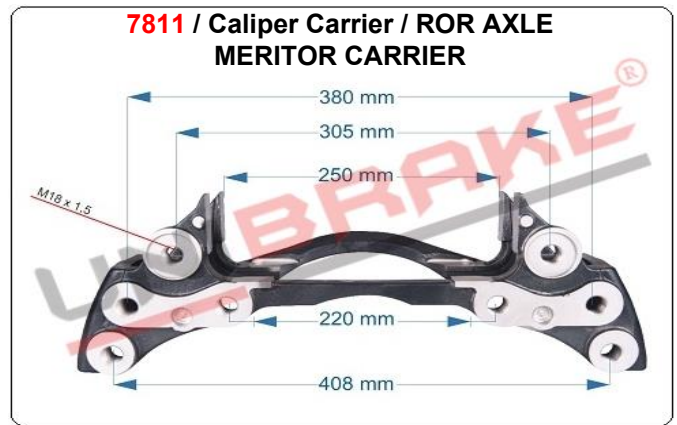
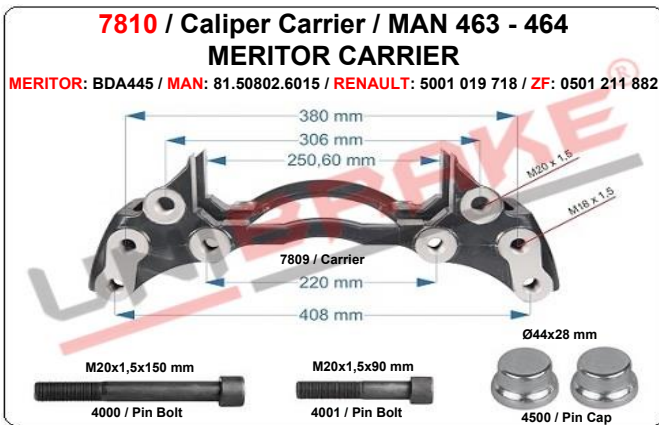
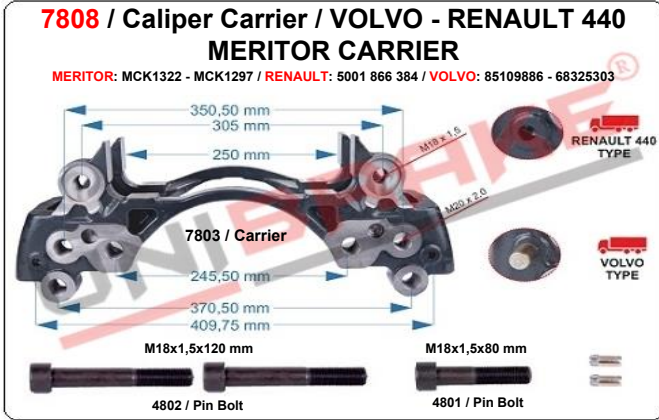



**7816 / Caliper Carrier / RENAULT PREMIUM  
MERITOR CARRIER**



**7817 / Caliper Carrier / ROR AXLE  
MERITOR CARRIER**

MERITOR: 68325994



**7818 / Caliper Carrier / ROR AXLE  
MERITOR CARRIER**

MERITOR: MCK1384



**7819 / Caliper Carrier  
MERITOR CARRIER**

MERITOR: 68325992



**7820 / Caliper Carrier  
MERITOR CARRIER**

MERITOR: MCK1383



**MARK II**



**HALDEX CARRIERS**



**MARK III**



**SAF / MODUL T**



**MARK IV**



**MODUL X**



**SAF CARRIERS**



---

# **HALDEX**

## **BRAKE CALIPER REPAIR KIT**



*You can follow our new products from our website.*





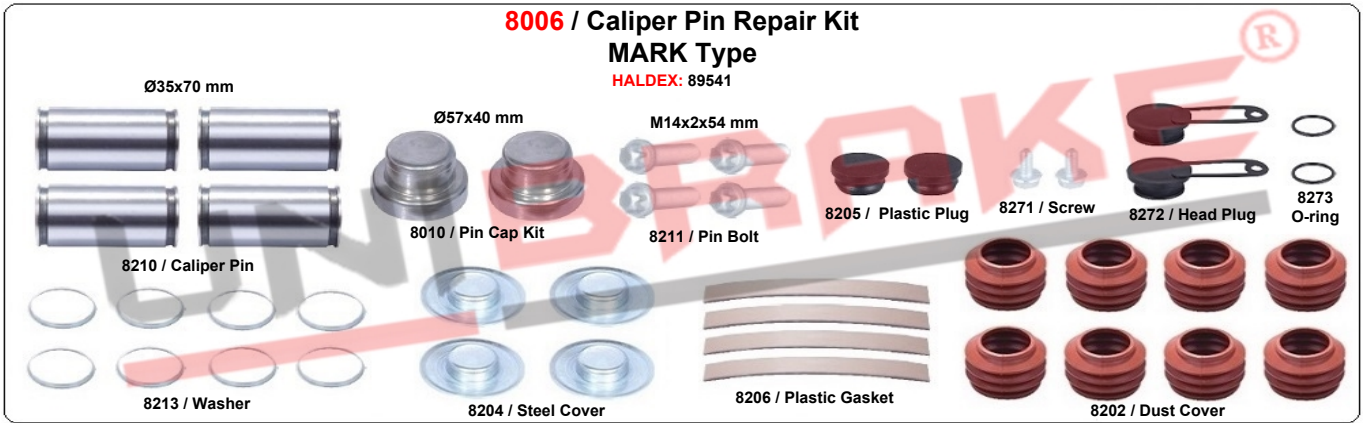



**8011 / Caliper Adjuster Shaft Set  
MARK / MODUL X Type**

HALDEX: 90693 / SAF: 3 434 3855 02 / RENAULT: 5021 174 163



**8012 / Caliper Calibration Bolt  
MARK Type**



**8013 / Caliper Tappet & Calibration Bolt  
MODUL X Type**



**8014 / Caliper Roller Bearing Set  
MODUL X Type**



**8015 / Caliper Intermediate Gear  
MARK / MODUL X Type**



**8016 / Caliper Manual Adjusting Gear  
MODUL X Type**



**8017 / Caliper Adjuster Mechanism  
MODUL X Type**



**8018 / Caliper Manual Adjusting Gear  
MARK / MODUL X Type**



**8019 / Caliper Roller Bearing Set  
MARK / MODUL X Type**



8274 / Roller Bearing

**8020 / Caliper Roller Bearing  
MARK / MODUL X Type**

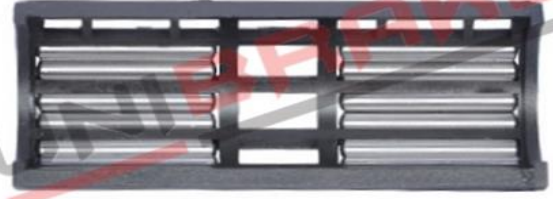

**8021 / Caliper Adjusting Sleeve  
MODUL X Type**



**8022 / Caliper Repair Kit Full  
MARK Type**



**8023 / Caliper Roller Bearing Set  
MODUL X Type**

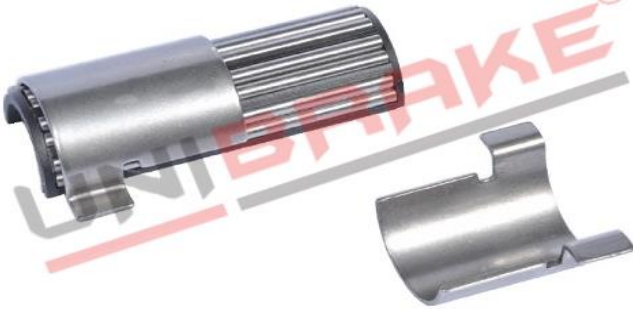

**8024 / Caliper Adjusting Gear  
MARK Type**



**8025 / Shaft Housing  
MARK / MODUL X Type**



**8026 / Caliper Lever  
MARK / MODUL X Type**





**8027 / Caliper Lever  
MODUL X Type**



**8028 / Caliper Adjusting Mechanism  
MARK / MODUL X Type**



**8029 / Cover For Adjusting Mechanism  
MODUL X Type**



**8030 / Caliper Adjusting Mechanism Cover  
MARK Type**



8220 / Cover



M8x45 mm

8221 / Bolt

**8031 / Shaft Housing  
MODUL X Type**



**8032 / Caliper Mechanism Clamp  
MARK Type**



**8033 / Caliper Mechanism Clamp  
MODUL X Type**



**8034 / Caliper Repair Kit Full  
MODUL X Type**



**8035 / Adjusting Mechanism  
MARK Type**



**8036 / Cover For Adjusting Mechanism  
MODUL X Type**



8029 / Adjusting Mechanism Cover

M8x30 mm 8261 / Bolt

**8037 / Brake Pad Retainer Repair Kit  
MARK / MODUL X Type**

HLDX: 90673



8281 / Brake Pad Retainer

8282 / Bolt

**8038 / Caliper Synchronisation Plate  
MODUL X Type**



**8039 / Anti Rotation Set  
MARK Type**



**8040 / Spring Set  
MARK / MODUL X Type**

Boot Protection Spring - Ø 78.5 mm



8226 / Spring

**8041 / Caliper Lever Pin  
MODUL X Type**



**8042 / Caliper Lever Pin  
MARK Type**





**8043 / Caliper Adjusting Bolt Kit  
MARK Type**



8228 / Calibration Bolt Right

8229 / Calibration Bolt Left

**8044 / Caliper Calibration Mechanism Set  
MODUL T Type**



**8060**  
Caliper Adjusting Screw



**8052**  
Roller Bearing Set



**8249**  
Dust Cover



**8258**  
Mechanism Locking Plastic



**8053**  
Roller Bearing Set



**8047**  
Caliper Bridge Assembly



**8050**  
Caliper Lever



**8048**  
Caliper Adjusting Mechanism Housing



**8045**  
Caliper Pinion Shaft



**8045 / Caliper Pinion Shaft  
MODUL T Type**



**8046 / Caliper Adjusting Gear Set  
MODUL T Type**



8250 / Adjusting Gear

**8047 / Caliper Bridge Assembly  
MODUL T Type**



**8048 / Caliper Adjusting Mechanism Housing  
MODUL T Type**



**8049 / Caliper Mechanism Bearing House  
MODUL T Type**



8259 / Mechanism Bearing House

**8050 / Caliper Lever  
MODUL T Type**



**8051 / Caliper Roller Bearing Set  
MODUL T Type**



8255 / Ball Bearing

8257 / Ball Bearing

8254 / Ball Bearing

8256 / Ball Bearing

**8052 / Roller Bearing Set  
MODUL T Type**



8264 / Roller Bearing - Left

8266 / Roller Bearing - Right

**8053 / Roller Bearing Set  
MODUL T Type**



8005 / Roller Bearing

8265 / Ball Bearing

**8054 / Brake Pad Retainer  
MODUL T Type**



8276 / Brake Pad Retainer Sheet Metal

8267 / Brake Pad Retainer Sheet Metal Spring



**8055 / Caliper Adjusting Gear Set  
MODUL T Type**



**8055-1 / Caliper Adjuster Gear Set  
MODUL T Type**



**8056 / Caliper Mechanism Locking Plastic Kit  
MODUL T Type**



**8057 / Dust Cover Set  
MODUL T Type**



**8058 / Sealing Ring  
MODUL T Type**



**8059 / Caliper Plug Set  
MODUL T Type**



**8060 / Caliper Adjusting Screw  
MODUL T Type**



**8061 / Caliper Repair Kit Full  
MARK Type**



**8062 / Caliper Guide & Bush Repair Kit  
MODUL T Type**

HLDX: 95397 - 95054 / SF: 3 434 3861 00 / KRONE: 550017811

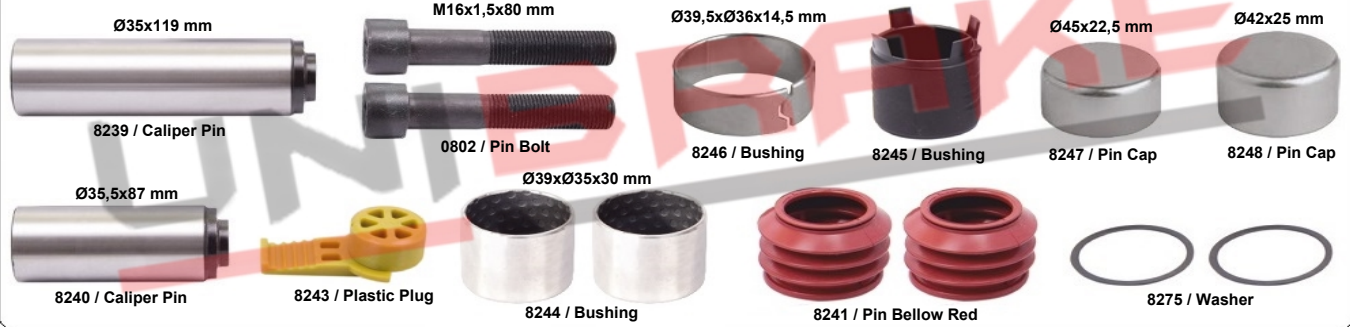

**8063 / Washer Repair Set  
MARK / MODUL X Type**



**8064 / Caliper Washer Set  
MARK Type**



**8065 / Caliper Washer Set  
MARK Type**



**8066 / Caliper Adjusting Mechanism Cover  
MARK Type**

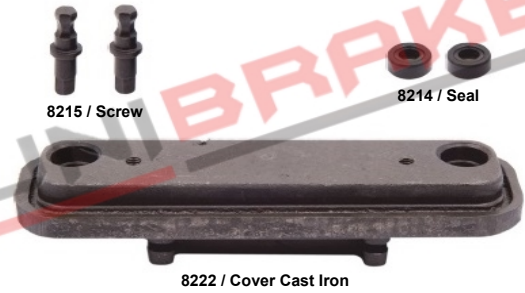

**8067 / Caliper Roller Bearing Set  
MARK Type**



**8068 / Mechanism Seal Kit  
MODUL T Type**

HLDX: 95399 - 95056 / SF: 3 434 3863 00 / KRONE: 550017813





**8069 / Reset Shaft Kit  
MODUL T Type**

HLDX: 95055 - 95398 / SF: 3 434 3862 00 / KRONE: 550017812



8251 / Adjusting Gear



8252 / Seal



8243 / Seal

**8070 / Caliper Repair Kit Full  
MODUL X Type**

**8079 / Caliper Pin Repair Kit**



**8037 / Brake Pad Retainer Repair Kit**



**8034 / Caliper Repair Kit Full**



**8071 / Caliper Repair Kit Full  
MARK / MODUL X Type**

**8000 / Caliper Pin Repair Kit**



**8037 / Brake Pad Retainer Repair Kit**



**8061 / Caliper Repair Kit Full**



**8072 / Caliper Repair Kit Full  
MARK Type**

**8006 / Caliper Pin Repair Kit**



**8037 / Brake Pad Retainer Repair Kit**



**8061 / Caliper Repair Kit Full**





**8073 / Caliper Repair Kit Full  
MODUL T Type**

**8054 / Brake Pad Retainer**



**8250 / Adjusting Gear**



**8253 / Sealing Ring**



**8055-1 / Adjuster Gear Set**



**8044 / Caliper Calibration Mechanism Set**



**8062 / Caliper Guide & Bush Repair Kit**



**8074 / Shaft Housing Set  
MARK / MODUL X Type**



**8025 / Shaft Housing**

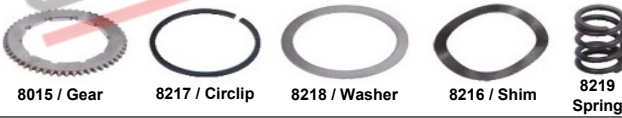

**8015 / Gear**

**8217 / Circlip**

**8218 / Washer**

**8216 / Shim**

**8219  
Spring**

**8075 / Caliper Tappet Plate With Calibration Bolts  
MARK / MODUL X Type**



**8004 / Caliper Tappet Plate**

**8076 / Calibration Bolt**

**8076 / Caliper Calibration Bolt  
MARK / MODUL X Type**



**8077 / Caliper Lever With Pin  
MARK Type**



**8026 / Caliper Lever**

**8042 / Lever Pin**

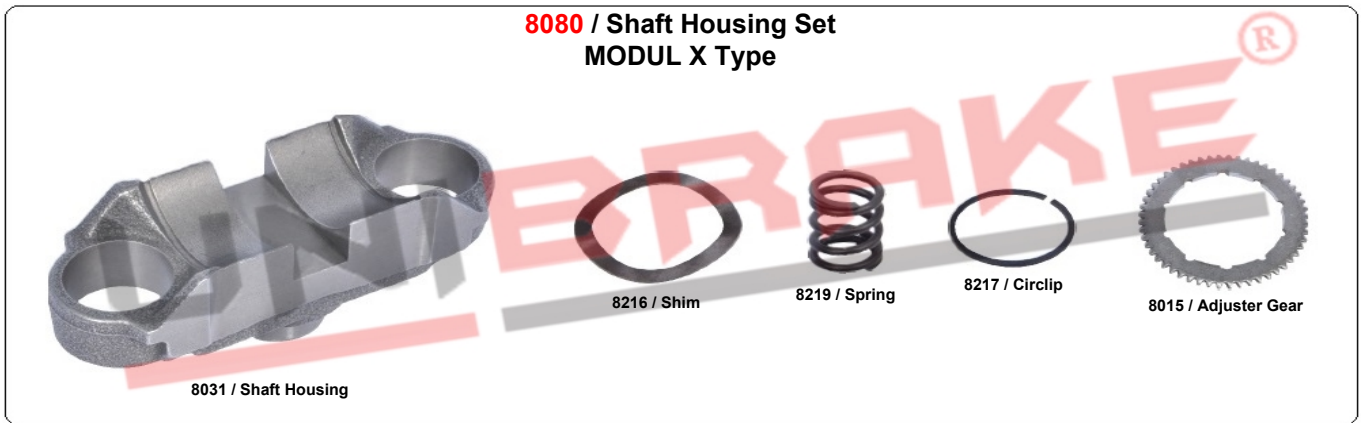



**8083 / Caliper Adjusting Gear  
MODUL X Type**



**8084 / Caliper Lever Set  
MODUL X Type**



**8085 / Caliper Lever Pin  
MODUL X Type**



**8086 / Caliper Mechanism Clamp  
MODUL X Type**



**8087 / Caliper Repair Kit Full  
MODUL X Type**

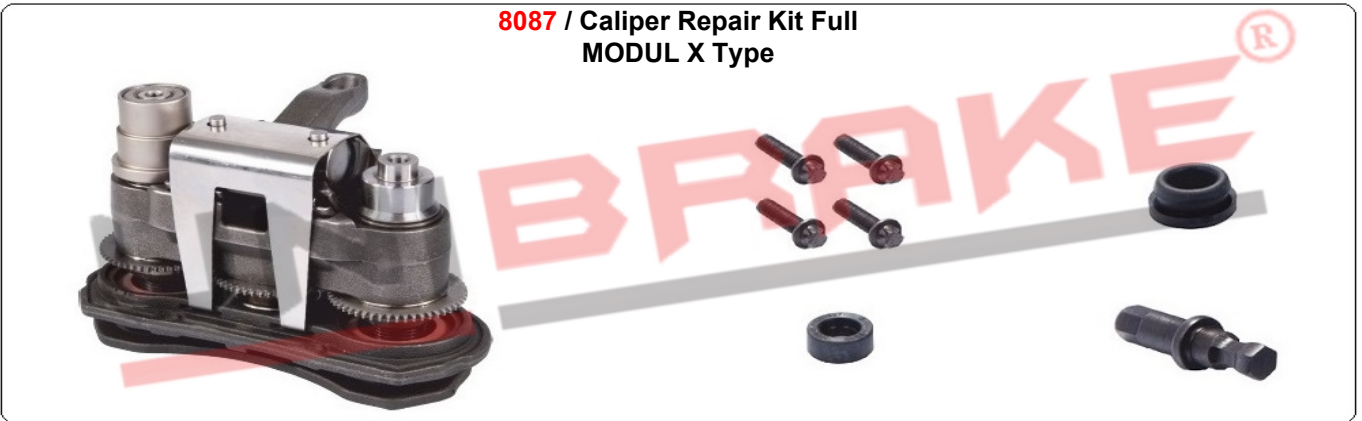

**8088 / Caliper Dust Cover & Spring Set  
MARK Type**  
HLDX: 84705

Boot Protection Spring - Ø 78.5 mm



**8089 / Shaft Housing Set  
MARK Type**



**8090 / Shaft Housing  
MARK Type**



**8091 / Caliper Repair Kit Full  
MARK Type**

**8078 / Caliper Pin Repair Kit**



**8022 / Caliper Repair Kit Full**





**8092 / Caliper Adjusting Mechanism Cover  
MARK Type**



**8093 / Caliper Lever  
MARK Type**



**8094 / Caliper Repair Kit Full  
MODUL X Type**

**8000 / Caliper Pin Repair Kit**



**8087 / Caliper Repair Kit Full**



**8095 / Caliper Roller Bearing Set  
MARK Type**



**8096 / Caliper Adjusting Mechanism Gear - Left  
MARK Type**



**8097 / Caliper Adjusting Mechanism Gear - Right  
MARK Type**



**8098 / Caliper Cover Set  
MARK Type**



**8099 / Caliper Brake Lining Plate  
MODUL X Type**



**8100 / Modul X Series Calibration Mechanism  
MODUL X Type**



**8101 / Caliper Mechanism Clamp  
MODUL X Type**



**8102 / Caliper Leveller Pin  
MODUL X Type**







**8106 / Caliper Guide & Bush Repair Kit  
MODUL T Type**

HLDX: 96202



**8107 / Caliper Guide & Bush Repair Kit  
MARK Type**

HLDX: 94661 / SF: 3 434 3858 00 - 3 434 3854 00

Ø57x40 mm



**8108 / Caliper Repair Kit  
MARK Type**

HLDX: 89723

Ø57x40 mm

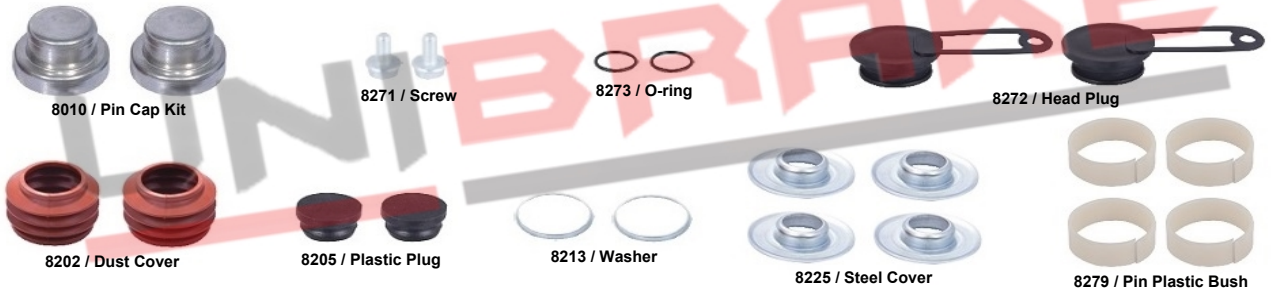

**8109 / Caliper Plug Kit  
MARK Type**

HLDX: 87408



**8110 / Caliper Plug Kit  
MARK Type**

HLDX: 89925





**8111 / Caliper Boot & Plug Set  
MARK Type**  
HALDEX: 94663

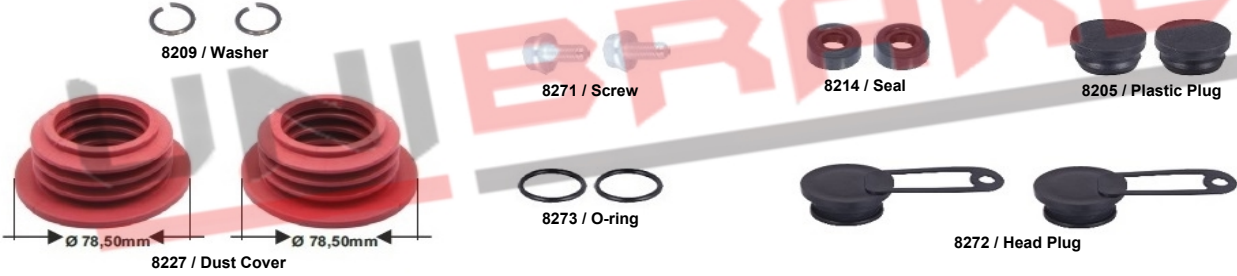

**8112 / Caliper Repair Kit  
MARK / MODUL X Type**  
HLDX: 94662



**8113 / Caliper Repair Kit  
MARK / MODUL X Type**  
HLDX: 94664



**8114 / Caliper Repair Kit  
MARK / MODUL X Type**  
HLDX: 92731

Boot Protection Spring - Ø 67 mm

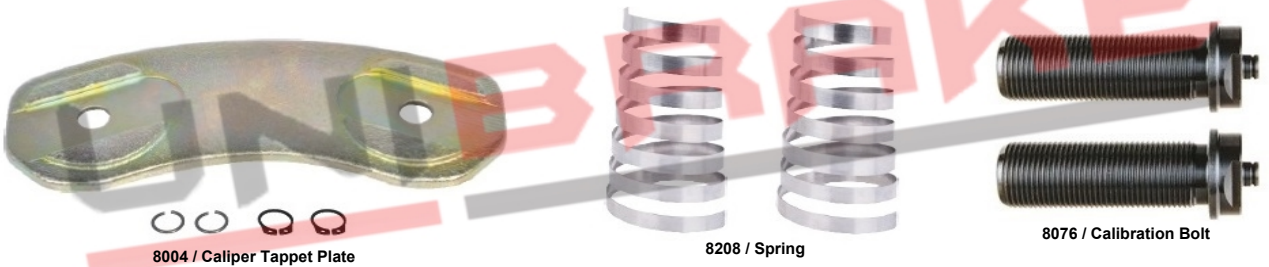

**8115 / Caliper Brake Lining Plate  
MARK / MODUL X Type**

HLDX: 94665

Boot Protection Spring - Ø 67 mm



8208 / Spring



8209 / Washer

**8116 / Caliper Ipat Retainer  
MARK / MODUL X Type**

HLDX: 91216



8282 / Bolt



8205 / Plastic Plug



8281 / Brake Pad Retainer



8283 / Brake Pad Spring Set

**8117 / Caliper Ipat Retainer Set  
MARK / MODUL X Type**

HLDX: 94659



8283 / Brake Pad Spring Set



8281 / Brake Pad Retainer



8282 / Bolt



8205 / Plastic Plug

**8118 / Caliper Guide & Bush Repair Kit  
MODUL X Type**

HLDX: 93299

M14x2x42 mm

Ø42x23 mm



8260 / Caliper Pin



8201 / Pin Bolt



8205 / Plastic Plug



8203 / Pin Cap



8206 / Plastic Gasket



8204 / Steel Cover



8202 / Dust Cover



**8119 / Caliper Guide & Bush Repair Kit**  
**MODUL X Type**  
HLDX: 94660

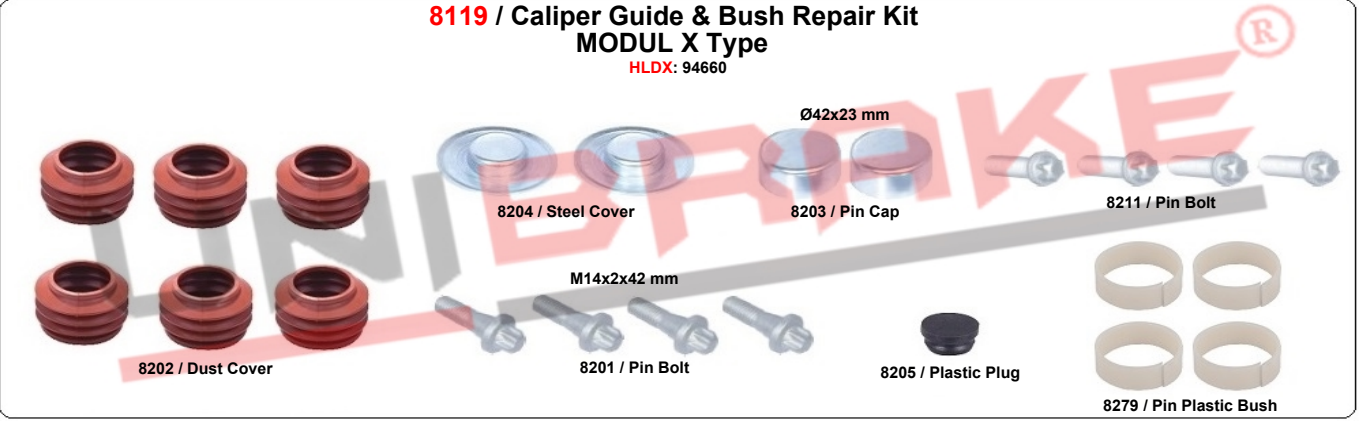

**8120 / Caliper Pin Cap**  
**MODUL X Type**  
HLDX: 91019



**8700 / Caliper Carrier / MODUL X VOLVO SERIES  
HALDEX CARRIER**



**8701 / Caliper Carrier / MODUL T SAF SERIES  
HALDEX CARRIER**

HLDX: 94861



**8702 / Caliper Carrier / MODUL T SAF SERIES  
HALDEX CARRIER**



**8703 / Caliper Carrier / MARK SERIES  
HALDEX CARRIER**



**8704 / Caliper Carrier / MODUL X B SERIES  
HALDEX CARRIER**



**8705 / Caliper Carrier / MODUL X SAF SERIES  
HALDEX CARRIER**





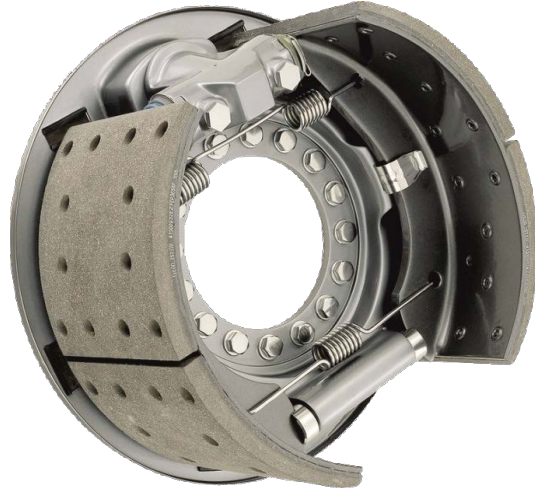

---

# Z-CAM BRAKE REPAIR KITS



*You can follow our new products from our website.*



**8500 / Adjusting Mechanism- Left  
Z-CAM Type**

MB: 1892003407231 / MN: 1494055 - 8603391 - N2509996057 / DF: 1694352  
IVC: 3346429R91 - 3348783R91 / MRT: 68192565 - A164061 - ST4014 - ST4023 RNL: 5001 868 118 - 5006 018 438 / PCCR: PPMST4014 / ZF: 0501210719  
DNNS: 61385913 - 65399613 / RB: 665135 / LYLND: XBU0910 /  
ZCAM: 272909 - 3097099 - 3098276 - 8550978 / BMC: 9P911107 / FRD: 9C462A105AA



**8501 / Adjusting Mechanism - Right  
Z-CAM Type**

MB: 1892003407221 / MN: 1472809 - 8603390 - N2509996054 / DF: 1694353 /  
IVC: 3348784R91 / MRT: 68192566 - A164062 - ST4013 - ST4024  
RNL: 5001 868 117 - 5006 018 437 / PCCR: PPMST4013 / DNNS: 61385911 - 65399612  
LYLND: XBU0911 / ZCAM: 272908 - 3097100 - 3098277 - 8550977 / BMC: 9P910414  
FRD: 9C462A105BA



**8502 / Pinion Gear - Right ( NEW MODEL )  
Z-CAM Type**

MB: 89200340794 - 1892003407941 / MN: 1350890 - 8605967 - N2509990131 / DF: 1694794 / IVC: 3346447R1 - 3346449R1 / MRT: 68191511 - A164055 / RNL: 5001 868 126 / PCCR: TP02006096  
DNNS: 6138606 - 6539963 - 6539975 LYLND: XBU0685 / ZCAM: 1696925 / FRD: 9C462K161AA /  
AWD: A4027691



**8503 / Pinion Gear - Left ( NEW MODEL )  
Z-CAM Type**

MB: 89200340793 - 1892003407931 / MN: 1350884 - 8605966 - N2509990129 / DF: 1694793  
IVC: 3346448R1 / MRT: 68191510 - A164052 / RNL: 5001 868 125 - 5006 018 474  
PCCR: TP02006095 / DNNS: 61385929 - 65399625 / LYLND: XBU0684 / ZCAM: 1696924  
FRD: 9C462K161BA / AWD: A4027705



**8504 / Mechanism Cross Shaft  
Z-CAM Type**

MB: 1892003407351 / MN: 1422829 - 8603403 - N2509996050 / DF: 1694368  
IVC: 3346443R91 / MRT: 68191219 - ST4018 - SP8540 /  
RNL: 5001 868 121 - 5006 018 458 / DNNS: 6138597 - 65399621  
ZCAM: 272910 - 1696453 - 3098271 / FRD: 9C462458AA / AWD: A4027696



**8505 / Brake Adjusting Pinion - Right ( NEW MODEL )  
Z-CAM Type**

MRT: 68020146 / RNL: 5006 046 766 / ZCAM: 1607502



**8506 / Brake Adjusting Pinion - Left ( NEW MODEL )  
Z-CAM Type**

MRT: 68020145 / RNL: 5006 046 765 / ZCAM: 1606775



**8507 / Brake Adjusting Pinion - Right ( OLD MODEL )  
Z-CAM Type**

MN: 1428758 - N2509996051 / MRT: ST1039 / ZCAM: 1081820 - 3090998





**8508 / Brake Adjusting Pinion - Left ( OLD MODEL )  
Z-CAM Type**

MN: 1428741 / MRT: ST1038 / ZCAM: 1081819 - 3090997



**8509 / Adjusting Pinion Set - Right  
Z-CAM Type**

272907

8525 / Adjusting Pinion - Right



8511 / Adjusting Pin Set

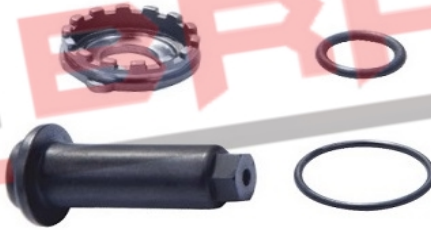

8521 / Reverse Lock - Right



**8510 / Adjusting Pinion Set - Left  
Z-CAM Type**

272906

8526 / Adjusting Pinion - Left



8511 / Adjusting Pin Set



8522 / Reverse Lock - Left



**8511 / Adjusting Pin Set  
Z-CAM Type**

MN: 1449350 / MRT: ST1033 / PCCR: TP02006268 / ZCAM: 276096



**8512 / Adjusting Pin Set  
Z-CAM Type**

MN: 1341829 - 8701361 - N2509996037 / DF: 1694364 / IVC: 42540290 - 3346439R91  
MRT: ST1035 - ST4022 / RNL: 7403 090 964 / PCCR: TP02006093 / ZF: 0501210721  
DNNS: 61385915 - 65399615 / ZCAM: 276100 - 3090964 - 3098275 / AWD: A4027698

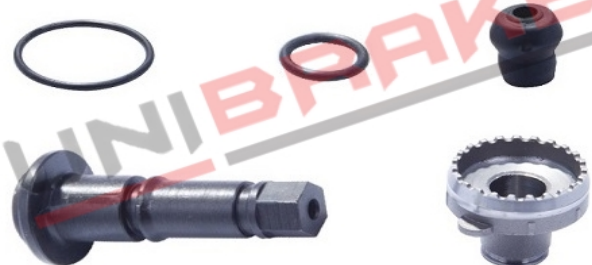

**8513 / Adjusting Pin Set  
Z-CAM Type**

MN: 2068777 - 8604735 - 85.500.013.424 / MRT: ST1034 / ZCAM: 276099



**8514 / Adjusting Pin  
Z-CAM Type**

MRT: 68192487 - 68200150 - 137075 / ZCAM: 1696445 - 1698346 - 3097299  
FRD: 9C462069AA



**8515 / Adjusting Pin  
Z-CAM Type**

MB: 1892003407251 / MN: 8603393 - N2970060001 / DF: 1694355 / IVC: 16352S1  
MRT: 64225252 - 137074 / RNLT: 5001 868 120 - 5006 018 440 / PCCR: AAU6457  
DNNS: 6138599 - 60889335 - 61049727 / RB: 665152 / ZCAM: 1696446  
FRD: 9C462B003AA



**8516 / Brake Adjusting Dust Cover  
Z-CAM Type**

MN: 1321228 - 8603384 - N2900000084 - N2900000152 / DF: 1694347 / IVC: 3346423R1 /  
MRT: 68191065 - 166062 / RNLT: 5001 868 127 - 5006 018 435 / DNNS: 6138593 - 6539967 /  
RB: 665145 / ZCAM: 1696449 / BMC: 9P901178 / FRD: 9C462213AA / AWD: A4027680

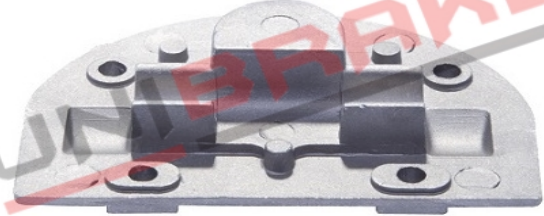

**8517 / Adjusting Dust Cover Gasket Set  
Z-CAM Type**

272905

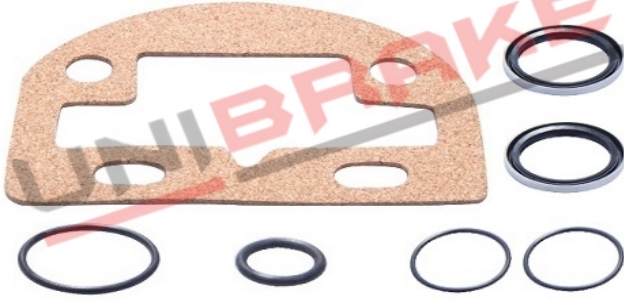

**8518 / Dust Cover Gasket  
Z-CAM Type**

MN: 1321234 - 8603385 - N2966010119 / DF: 1694348 / MRT: 68191066 - 166063 /  
RNLT: 5001 868 122 - 5006 018 436 / DNNS: 6138594 - 6539968 - 65356315 / LYLND: XBU0889  
ZCAM: 1696450 / FRD: 9C462B032AA

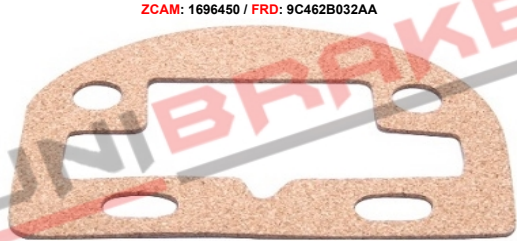

**8519 / Brake Adjusting Dust Seal  
Z-CAM Type**

MB: 89200340815 / MN: 8701359 - 1427340 - N2509990143 / DF: 1694354 / IVC: 42540274 - 3346430R91  
MRT: 68192410 / PCCR: TP08023002 / ZF: 0501316391 / DNNS: 61385910 - 65399614 - 65399620  
RB: 665151 / ZCAM: 1696448 - 3090954 / FRD: 9C462B009AA / AWD: A4027686 /  
RVI: 5001 868 119 - 5006 018 439



**8520 / Return Spring  
Z-CAM Type**

MB: 1892003407951 / MN: 1398023 - 8607130 - N2900000088 / DF: 1694362 / IVC: 3346437R1  
MRT: 68192115 - 167090 / RNLT: 5001 868 113 - 5006 018 480 / DNNS: 61385919 - 65399619  
RB: 665153 / ZCAM: 1696444 - 3097092 / BMC: 9P901265 / FRD: 9C462296AA





**8521 / Reverse Lock - Right  
Z-CAM Type**

MB: 1892003407911 / MN: 1386099 - 8604737 - N2509996047 / DF: 1694366  
IVC: 3346441R91 / MRT: 68191541 - ST1037 - ST4020 / RNL: 7400 276 098  
DNNS: 6138604 - 6539973 / ZCAM: 276098 - 3098273 / BMC: 9P910412  
FRD: 9C462K400BA / AWD: A4027699

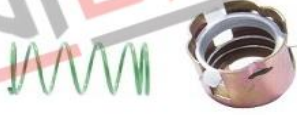

**8522 / Reverse Lock - Left  
Z-CAM Type**

MN: 1336762 - 8604736 - N2509996035 / DF: 1694365 / IVC: 3346440R91  
MRT: 68191540 - ST1036 - ST4021 / RNL: 7400 276 097 / PCCR: TP02006094  
DNNS: 61385928 - 65399617 / ZCAM: 276097 - 3098274 / BMC: 9P910411  
FRD: 9C462K400AA / AWD: A4027706



**8523 / Mechanism Cover  
Z-CAM Type**

272904



**8524 / Brake Adjusting Pin  
Z-CAM Type**

MN: 1336791 - N2509990127 / IVC: 3346433R1 / MRT: 68191930 / DNNS: 61385917  
BMC: 9P901234 / FRD: 9C462C200AA / RVI: 5006 018 450



**8525 / Pinion Gear - Right ( OLD MODEL )  
Z-CAM Type**



**8526 / Pinion Gear - Left ( OLD MODEL )  
Z-CAM Type**



**8527 / Caliper Repair Kit Complete**

<p><b>8500</b> Adjusting Mechanism- Left</p> 	<p><b>8501</b> Adjusting Mechanism - Right</p> 	<p><b>8515</b> Adjusting Pin</p> 	<p><b>8521</b> Reverse Lock - Right</p> 
<p><b>8520 / Return Spring</b></p> 	<p><b>8517 / Adjusting Dust Cover Gasket Set</b></p> 	<p><b>8525 / Adjusting Pinion - Right</b></p> 	
<p><b>8504 / Mechanism Cross Shaft</b></p> 	<p><b>8519 / Brake Adjusting Dust Seal</b></p> 	<p><b>8511 / Adjusting Pin Set</b></p> 	

**8528 / Caliper Repair Kit Complete**

<p><b>8500</b> Adjusting Mechanism- Left</p> 	<p><b>8501</b> Adjusting Mechanism - Right</p> 	<p><b>8515</b> Adjusting Pin</p> 	<p><b>8522</b> Reverse Lock - Left</p> 
<p><b>8520 / Return Spring</b></p> 	<p><b>8517 / Adjusting Dust Cover Gasket Set</b></p> 	<p><b>8526 / Adjusting Pinion - Left</b></p> 	
<p><b>8504 / Mechanism Cross Shaft</b></p> 	<p><b>8519 / Brake Adjusting Dust Seal</b></p> 	<p><b>8511 / Adjusting Pin Set</b></p> 	



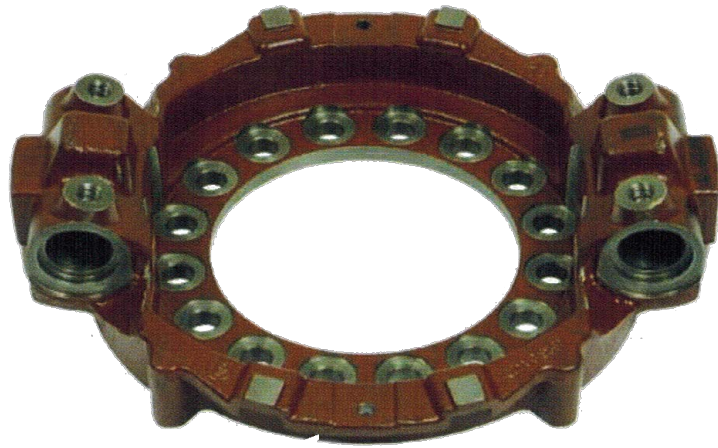

---

# IVECO BRAKE REPAIR KITS



*You can follow our new products from our website.*



**8600 / Wedge For Brake  
IVECO Type**

OEM NO: RBSK1255.M - RBSK2051.M - RBSK1573.M / ASTRA: 93161621  
IVECO: 93116121 - 42536194 / A2247L1000



**8601 / Wedge For Brake  
IVECO Type**

OEM NO: 12.999.410VT / DAF: 1505883 / KÖGEL: 8009190 / IVECO: 93161768  
NATO: 2530123431916



**8602 / Wedge For Brake  
IVECO Type**

OEM NO: RBSK0250B.M - A2247U47 / VANHOOL: 634321231 / VOLVO: 1695493  
ASTRA: 7980407 - 42480062 / AYATS: 32001375 / MOWAG: 0735050 / IVECO: 42480062  
BREDAMENARINIBUS: 0192756 / MAN: A4022499 / ZF: 0501 298 159



**8603 / Wedge For Brake  
IVECO Type**



**8604 / Return Spring  
IVECO Type**

OEM NO: RBSK2128.M / ASTRA: 93161627 / IVECO: 93162113



8405 / Return Spring

8605 / Return Spring

**8605 / Return Spring  
IVECO Type**

OEM NO: 2258D1122 / IVECO: 93161260



**8606 / Brake Repair Kit  
IVECO Type**

OEM NO: RBSK0502B.M / ASTRA 42491950 - AYATS 32001160 - FODEN FBU6782 BREDAMENARINIBUS 192753 - RENAULT 5021 203 245



8404 / Return Spring



8609 / Dust Cover



8608 / Adjusting Nut



8610 / Dust Cover



8613 / Adjusting Latc



8612 / Brake Holder



8607  
Adjusting Screw



**8607 / Adjusting Screw  
IVECO Type**

A2297L3158 IVECO 42480059 - FODEN Y07088205 - MOWAG 0734610  
NISSAN 069028770 VANHOOL 634321222 - VOLVO 1696537



**8608 / Adjusting Nut  
IVECO Type**

RBSK0549B.M IVECO 42491974 - VANHOOL - 634321204  
BREDAMENARINIBUS 0192752



**8609 / Dust Cover  
IVECO Type**

1205C1667 IVECO 42488737 - VANHOOL - 634321228 - VOLVO 1696219  
MOWAG 0734609



**8610 / Dust Cover  
IVECO Type**

1205B1666 IVECO 42488736 - 3351848R1 - VANHOOL - 634321223 - VOLVO 1696218  
FODEN Y03018404 - FORD 82DB2B009AA - NISSAN 069028780 - MOWAG 0734612



**8611 / Dust Cover  
IVECO Type**

RBSK0251B.M IVECO 7980408 - BREDAMENARINIBUS 192757 - ZF 0501 298 164



8609 / Dust Cover

8610 / Dust Cover

**8612 / Brake Holder  
IVECO Type**



**8613 / Adjusting Latc  
IVECO Type**







**8620 / Brake Repair Kit  
IVECO Type**



**8621 / Brake Holder Upper  
IVECO Type**



**8622 / Brake Holder Lower  
IVECO Type**



**8623 / Brake Holder Lower  
IVECO Type**

12.999.135VT - 12.999.411VT IVECO 8124815 - DENNIS 65325114 - MAN N1011013158  
SOLARIS 0701590020 - ZF 0501 129 805 - NEOPLAN 070159002 - 10113158



**8624 / Dust Cover  
IVECO Type**

12.999.404VT IVECO 93161257 - KÖGEL 336677 - DENNIS 65481218  
NATO 2530123431914 ZF 0501 129 817 - LEYLAND FBU7502



**8625 / Brake Holder  
IVECO Type**

12.999.402VT IVECO 93161267 - DAF 1518475 - DENNIS 65481215 FREIGHTLINER  
TBBD65481215 - SOLARIS 0870040000 LEYLAND FBU9123 - NATO 2530123667596  
ZF 0501 129 817



**8626 / Adjusting Screw  
IVECO Type**



**8627 / Adjusting Latc  
IVECO Type**



**8628 / Brake Holder Set  
IVECO Type  
93161623**



8619 / Adjusting Latc 8618 / Brake Holder 8616 / Adjusting Nut

**8629 / Brake Holder Set  
IVECO Type**

RBSK0549B.M BREDAMENARINIBUS 0192752 IVECO 42491974  
VANHOOL 634321204



8613 / Adjusting Latc 8612 / Brake Holder 8608 / Adjusting Nut

**8630 / Dust Cover Set  
IVECO Type**



8609 / Dust Cover 8610 / Dust Cover

**8631 / Caliper Repair Kit  
KNORR BENDIX**

KNORR: 381.391 / IVECO: 93161189 / ADB: 3700 - 4300



**8632 / Brake Pad Retainer Kit  
KNORR BENDIX**

381.419 / 93161560

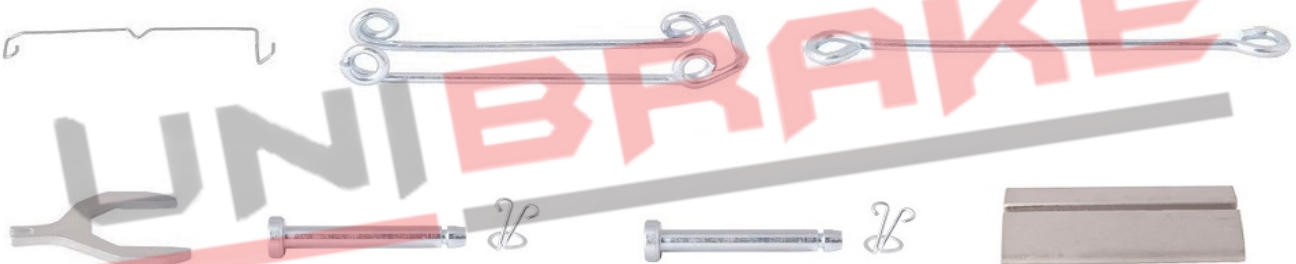



**8633 / Brake Pad Retainer Kit**  
**KNORR BENDIX**  
II33692 / 93161843



**8634 / Brake Repair Kit**  
**IVECO Type**

RBSK2318.M / IVECO 42536197 - 42559513



**8635 / Dust Cover**  
**IVECO Type**

1205E2683 - 6C462B024AB / IVECO 4257841



**8636 / Hold Down Clip**  
**IVECO Type**

13 304 029 / IVECO 8121441 - DAF 1505893 - DENNIS 6548125 - TAM 5577951  
LEYLAND FB9121 - MB 000 654 8125 - D6548125 - ZF 0501 131 497  
NATO 5340121918830 - 5340123088456 - VOLVO 20000217501



**8637 / Adjusting Nut**  
**IVECO Type**

1227K1337 / IVECO 93163852 - 99435121 - ERF 1448479 - MAN N2906850084



**8638 / Adjusting Latc**  
**IVECO Type**

A1779M195 / IVECO 42488739 - MOWAG - 0734619 VANHOOL 634321230  
VOLVO 1695050



**8639 / Hold Down Clip  
IVECO Type**

2257M1001 - 2257D108 IVECO 42488484 - FORD 82DB2B026AA - NISSAN 069028800 VANHOOL 634321233 - VOLVO 6770266 - FODEN Y03018809



**8640 / Brake Anchor Plunger Kit - Right  
IVECO Type**

RBSK1482.M / IVECO 3352053R91 - 93161864 - ERF 2020382



8409  
Brake Anchor Plunger  
Angle 5° - Right

8410  
Brake Anchor Plunger  
Angle 15° - Right

**8641 / Brake Anchor Plunger Kit - Left  
IVECO Type**

RBSK1481.M / IVECO 3352052R91 - 93161863 - ERF 2020376 - MAN N2913016004



8411  
Brake Anchor Plunger  
Angle 5° - Left

8412  
Brake Anchor Plunger  
Angle 15° - L

**8642 / Brake Holder Set - Right  
IVECO Type**

RBSK1606.M - RBSK1599.M / IVECO 42537365 - 42537363



8645 / Brake Holder - Right

8635 / Dust Cover

8644 / Adjusting Latc



**8643 / Brake Holder Set - Left  
IVECO Type**

RBSK1607.M - RBSK1600.M / IVECO 42537366 - 42537364



8646 / Brake Holder - Left



8635 / Dust Cover



8644 / Adjusting Latc

**8644 / Adjusting Latc  
IVECO Type**



**8645 / Brake Holder - Right  
IVECO Type**



**8646 / Brake Holder - Left  
IVECO Type**



**8647 / Hold Down Clip  
IVECO Type**

RBSK1409 / IVECO 93161626



**8648 / Brake Holder Set - Right  
IVECO Type**

RBSK0248B.M / ASTRA 7980405 - BREDAMENARINIBUS 0192754 - ERF A4023357



8650 / Brake Holder - Right



8667 / Brake Dust Cover



8638 / Adjusting Latc

**8649 / Brake Holder Set - Left  
IVECO Type**

RBSK0249B.M / ASTRA 7980406 - BREDAMENARINIBUS 0192755 - VANHOOL 10610921



8651 / Brake Holder - Left



8667 / Brake Dust Cover



8638 / Adjusting Latc

**8650 / Brake Holder - Right  
IVECO Type**



**8651 / Brake Holder - Left  
IVECO Type**



**8652 / Brake Repair Kit  
IVECO Type**

RBSK2318-1 / IVECO 42562830 - 2996557



8617 / Dust Cover



8655 / Adjusting Nut



8653 / Adjusting Screw

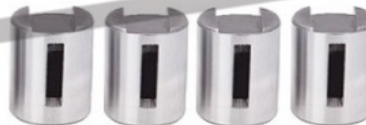

8618 / Brake Holder



8654 / Adjusting Latc

**8653 / Adjusting Screw  
IVECO Type**



**8654 / Adjusting Latc  
IVECO Type**





**8655 / Adjusting Nut  
IVECO Type**



**8656 / Adjusting Nut  
IVECO Type**



**8657 / Adjusting Nut  
IVECO Type**



**8658 / Adjusting Screw  
IVECO Type**



**8659 / Adjusting Screw  
IVECO Type**



**8660 / Wedge For Brake  
IVECO Type**



**8661 / Brake Holder Upper  
IVECO Type**



**8662 / Brake Holder Lower  
IVECO Type**

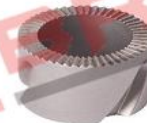

**8663 / Brake Holder  
IVECO Type**



**8664 / Adjusting Latc Set  
IVECO Type**



8662 / Brake Holder Cover



8407 / Washer



8627 / Adjusting Latc



8406 / Spring



8626 / Adjusting Screw



8663 / Brake Holder



8624 / Dust Cover



8661 / Brake Holder Upper

**8665 / Adjusting Latc Set  
IVECO Type**



8627 / Adjusting Latc



8661 / Brake Upper



8662 / Brake Holder Cover

**8666 / Brake Holder Set  
IVECO Type**



8654 / Adjusting Latc



8655 / Adjusting Nut



8618 / Brake Holder

**8667 / Brake Dust Cover  
IVECO Type**







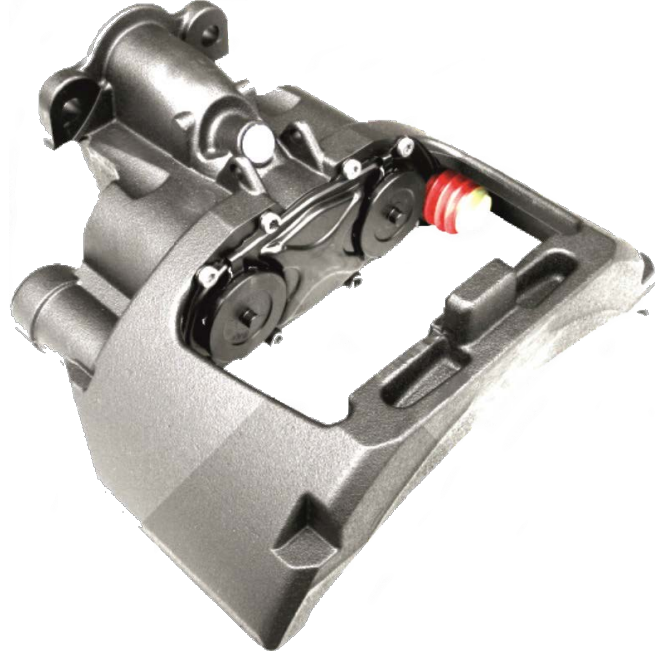

---

## **B BRAKE CALIPER REPAIR KITS**



*You can follow our new products from our website.*



**9001 / Caliper Repair Kit Complete**  
TSB 3709 / 4309 ( 9 TON AXLE ) Type

8340 / Plug



9016

Caliper Adjusting Mechanism Set



9004 / Roller Bearing Set



9003 / Caliper Pin Repair Kit



9018 / Caliper Lever Pin



9032 / Caliper Mechanism , Piston & Cover Set



**9002 / Caliper Boot & Cap Set**  
TSB 3709 / 4309 / 4312 Type

B: 09.801.07.62.0

Ø41xØ37x73 mm



8305 / Pin Bush

Ø41xØ37x30 mm



8306 / Pin Bush



8312 / O-ring



8310 / Plug



8309 / Pin Boot



8330 / Plastic Washer



8321 / Plastic Cap



8331 / O-ring

**9003 / Caliper Pin Repair Kit**  
TSB 3709 / 4309 / 4312 Type

Ø37x123 mm



8303 / Caliper Pin

M16x1,5x100 mm



8308 / Pin Bolt

Ø41xØ37x30 mm



8305 / Pin Bush

Ø41xØ37x30 mm



8306 / Pin Bush



8310 Plug



8312 O-ring



8313 Pin Circlip

Ø36,40x70 mm



8304 / Caliper Pin

M16x1,5x70 mm



0806 / Pin Bolt



8309 / Pin Boot



8330 / Plastic Washer



8321 / Plastic Cap



8331 / O-ring

**9004 / Roller Bearing Set**  
TSB 3709 / 4309 / 4312 Type



8329 / Roller Bearing

**9005 / Roller Bearing Set**  
TSB 3709 / 4309 ( 9 TON AXLE ) Type



8332 / Roller Bearing

**9006 / Caliper Pin Repair Kit**  
TSB 3709 / 4309 / 4312 Type

B: 09.801.07.63.1 - 05.801.50.90.0



8314 / Tappet With Pin

8302 / Clamp

8301 / Tappet Boot

8315 / Locker

**9007 / Caliper Calibration Bolt**  
TSB 3709 / 4309 / 4312 Type



**9008 / Caliper Lever**  
TSB 3709 / 4309 / 4312 Type



**9009 / Caliper Adjusting Mechanism**  
TSB 3709 / 4309 / 4312 Type

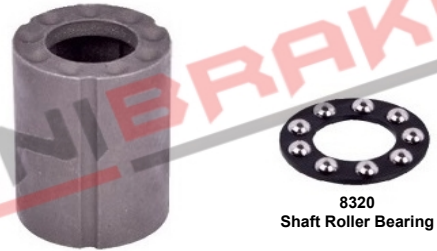

8319  
Caliper Mechanism Bearing House

8320  
Shaft Roller Bearing

**9010 / Caliper Lever Pin**  
TSB 3709 / 4309 / 4312 Type



**9011 / Caliper Cover Set**  
TSB 3709 / 4309 / 4312 Type

B: 05.010.95.31.0



8316 / Mechanism Cover

8318  
Mechanism Washer

M8x16 mm

0120 / Bolt



**9012 / Caliper Washer Set**  
TSB 3709 / 4309 / 4312 Type



8339 / Calibration Bolt Housing

**9013 / Shaft Housing**  
TSB 3709 / 4309 / 4312 Type

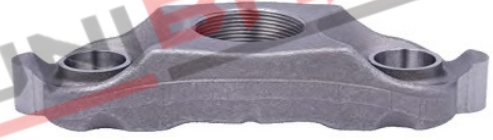

**9014 / Caliper Adjusting Mechanism**  
TSB 3709 / 4309 ( 9 TON AXLE ) Type

B: 01.127.38.02.0



**9016 / Caliper Adjusting Mechanism Set**  
TSB 3709 / 4309 / 4312 Type



**9017 / Shaft Housing**  
TSB 3709 / 4309 ( 9 TON AXLE ) Type



**9018 / Caliper Lever Pin**  
TSB 3709 / 4309 / 4312 Type



**9019 / Caliper Bearing Set**  
TSB 3709 / 4309 / 4312 Type

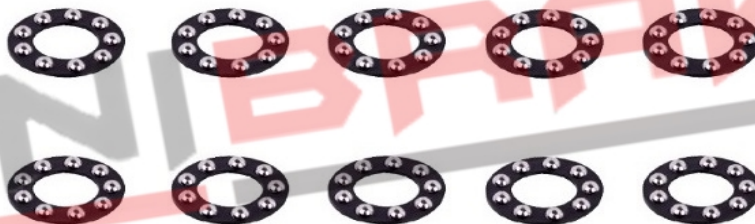

8320 / Shaft Roller Bearing

**9020 / Caliper Pin Repair Kit**  
TSB 3709 / 4309 / 4312 Type

B: 09.801.07.61.0



**9021 / Caliper Boot & Cap Set**  
TSB 3709 / 4309 / 4312 Type



**9022 / Caliper Pin Repair Kit**  
TSB 3709 / 4309 / 4312 Type

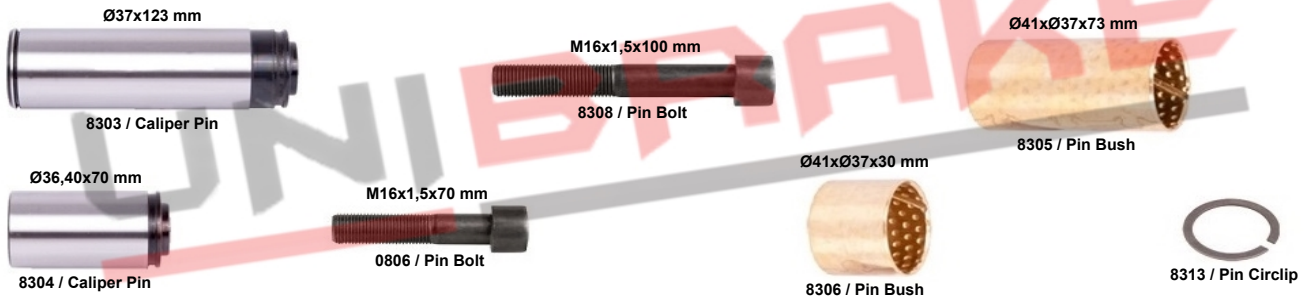

**9023 / Caliper Plug Set**  
TSB 3709 / 4309 / 4312 Type



**9024 / Caliper Pad Retainer Repair Kit**  
TSB 3709 / 4309 / 4312 Type

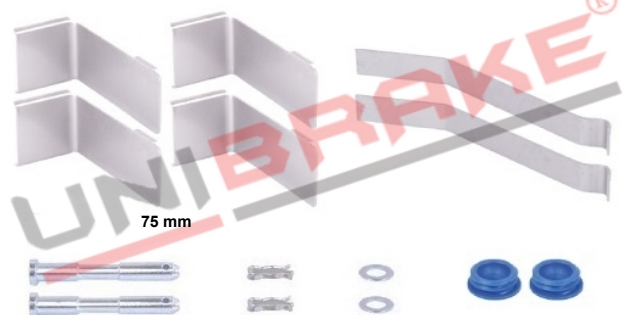



**9025 / Brake Pad Retainer Repair Kit**  
TSB 3709 / 4309 / 4312 Type

B: 09.801.07.68.1

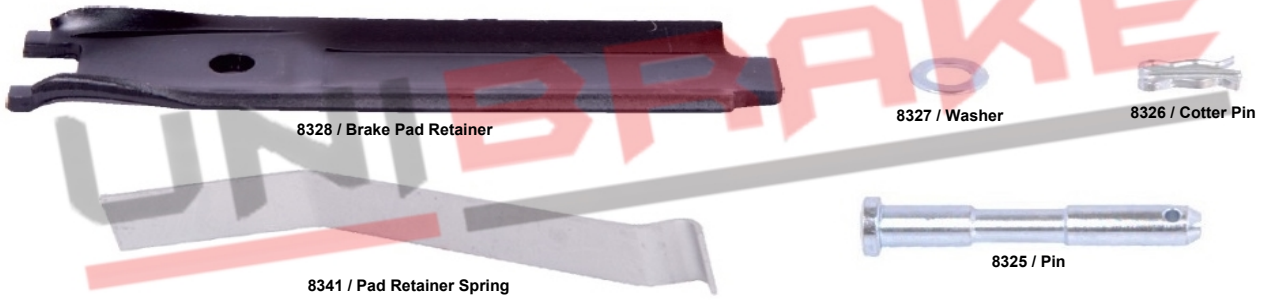

**9026 / Caliper Pin Repair Kit With Pad Retainer**  
TSB 3709 / 4309 / 4312 Type

B: 09.801.05.81.0



**9027 / Caliper Cover Set**  
TSB 3709 / 4309 / 4312 Type



**9028 / Caliper Repair Kit**  
TSB 3709 / 4309 ( 9 TON AXLE ) Type

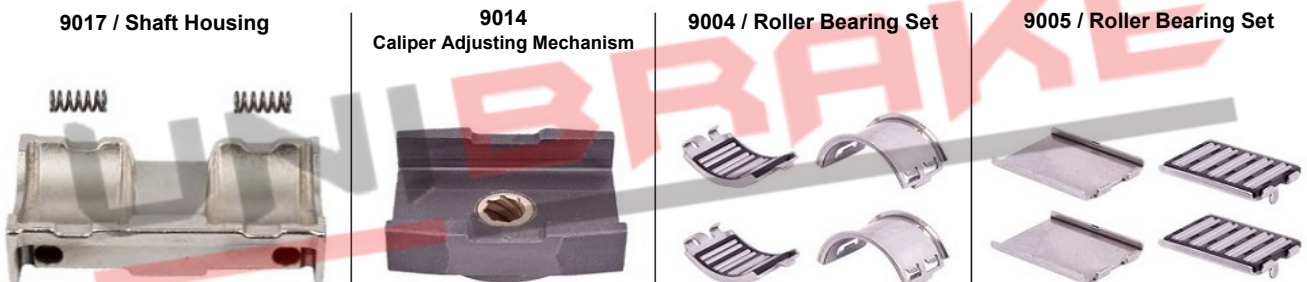





**9037 / Caliper Repair Kit Complete**  
**TSB 4312 ( 12 TON AXLE ) Type**

8340 / Plug



9016  
Caliper Adjusting Mechanism Set



9004 / Roller Bearing Set



9003 / Caliper Pin Repair Kit



9018 / Caliper Lever Pin



9035 / Caliper Mechanism , Piston & Cover Set



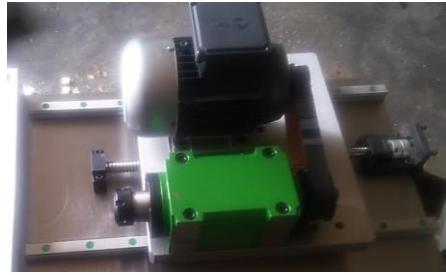



# UNI BRAKE®

## Brake Caliper Repair Kit PRODUCT CATALOGUE

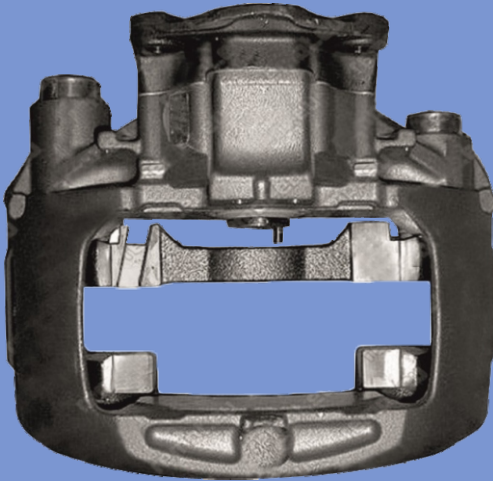
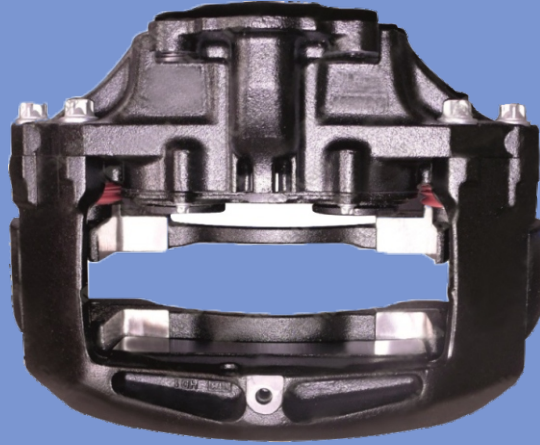

+90 332 249 19 30

necmikaratas@unibrake.com.tr

unibrake.caliper

Fevzi Çakmak Mah. 10736.Sokak No:4 Karatay/ KONYA/ TURKEY

info@unibrake.com.tr

unibrake@mail.ru

unibrake

Foreign Trade Manager

+90 555 895 29 75

[www.unibrake.com.tr](http://www.unibrake.com.tr)



TÜRKAK BDS NO  
YS-68E9-9C94



Kalite Yönetim Sistemi  
TS EN ISO/IEC 17021-1  
AB-099-YS



EAC

