

CATALOGUE PRESENTATION

This catalogue is organised by **Vehicle Type in two sections :**

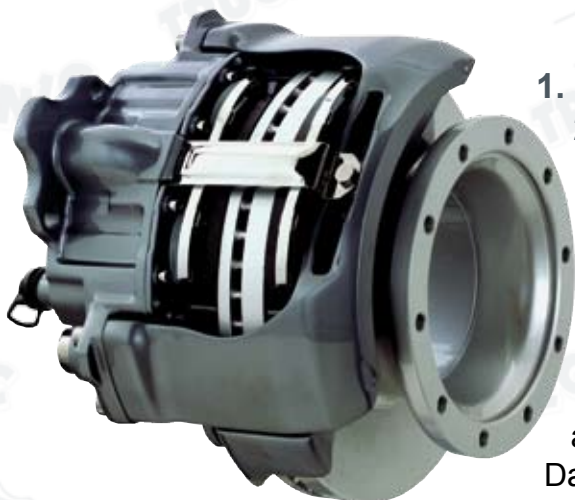

1. LCV (Light Commercial Vehicles)
2. HDV (Heavy Duty Vehicles)

This catalogue also covers most popular calipers on the market today.

Cross-reference information begins on page 6. All possible part numbers are cross referred to TT n° in alpha numerical order. (Knorr, Volvo, Meritor, Scania, Daimler, Wabco etc...)

Typical **exploded views** of most key models are shown in the kit section, to help you choose correct the repair kits.



WARRANTY TERMS



All calipers are covered by a One Year Warranty, valid worldwide.

Most TT Calipers are sold in Europe and are covered by a Pan-European Warranty System whose participants are :

 TRUCKTECHNIC S.A.	_____	BELGIUM
 TRUCKTECHNIC FRANCE	_____	FRANCE
 TRUCKTECHNIC IBERICA	_____	SPAIN
 GGN DI GORGOGLIONE NICOLA	_____	ITALY
 LEUVEN BEDRUF SWAGENONDERDELEN	_____	THE NETHERLANDS
 TROND HORG ELLINGSEN A/S	_____	NORWAY
 PRO TECH LKW SRL	_____	ROMANIA
 TIS ZAO TECHNICAL	_____	RUSSIA
 POLMOZBYT JELCZ	_____	POLAND
 POVILASKAS A. ENTERPRISE	_____	LITHUANIA

Should TT rebuilt caliper, sold by any of the above companies, break down in any of these territories, calipers will be replaced "No questions Asked", pending our Warranty Report. Replacement calipers are invoiced, and credited should the warranty be accepted.

Introduction



Ever since the introduction of disc brakes on Heavy Trucks and Buses, Trucktechnic has been investing in rebuilding capacity.

Today, a specialised 400 m² workshop is fully operational, with a high rebuilding capacity and independent engineering support.

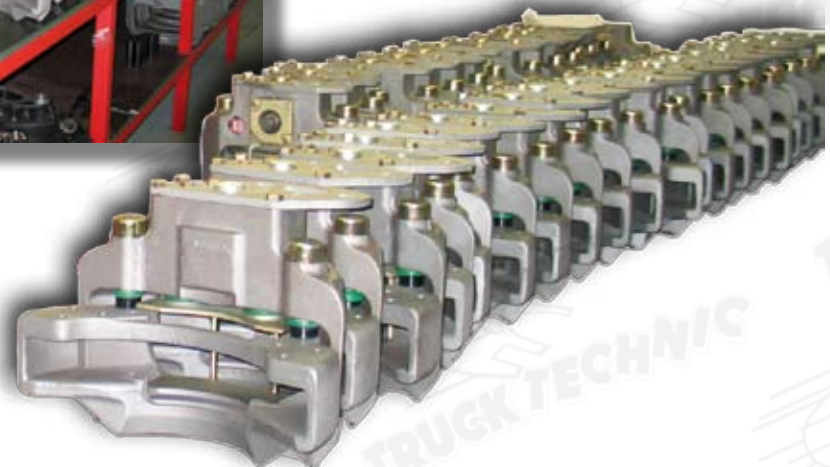



Degreasing machines



Blasting machines

Degreasing and blasting machines, conceived especially for the job, can handle more than 200 units daily.

Temperature resistant paint (400 C°) is applied to all caliper bodies after blasting.



By investing extensively in our own spare parts and repair kits, as well as consuming high quantities of essential ORIGINAL spare parts from market leaders Knorr-Bremse, Arvin Meritor and Brembo, we achieve **high production efficiency**. Consequently, apart from main body components, very **few old parts are re-used**, and then only after careful **quality control**.

Assembly is carried out using **the specialised tools** recommended by the manufacturer, with scrupulous regard to the original specification.



Caliper testing and adjustment is carried out strictly according to manufacturer's instructions, using their own specified electronic equipment.





General CATALOGUE CALIPERS

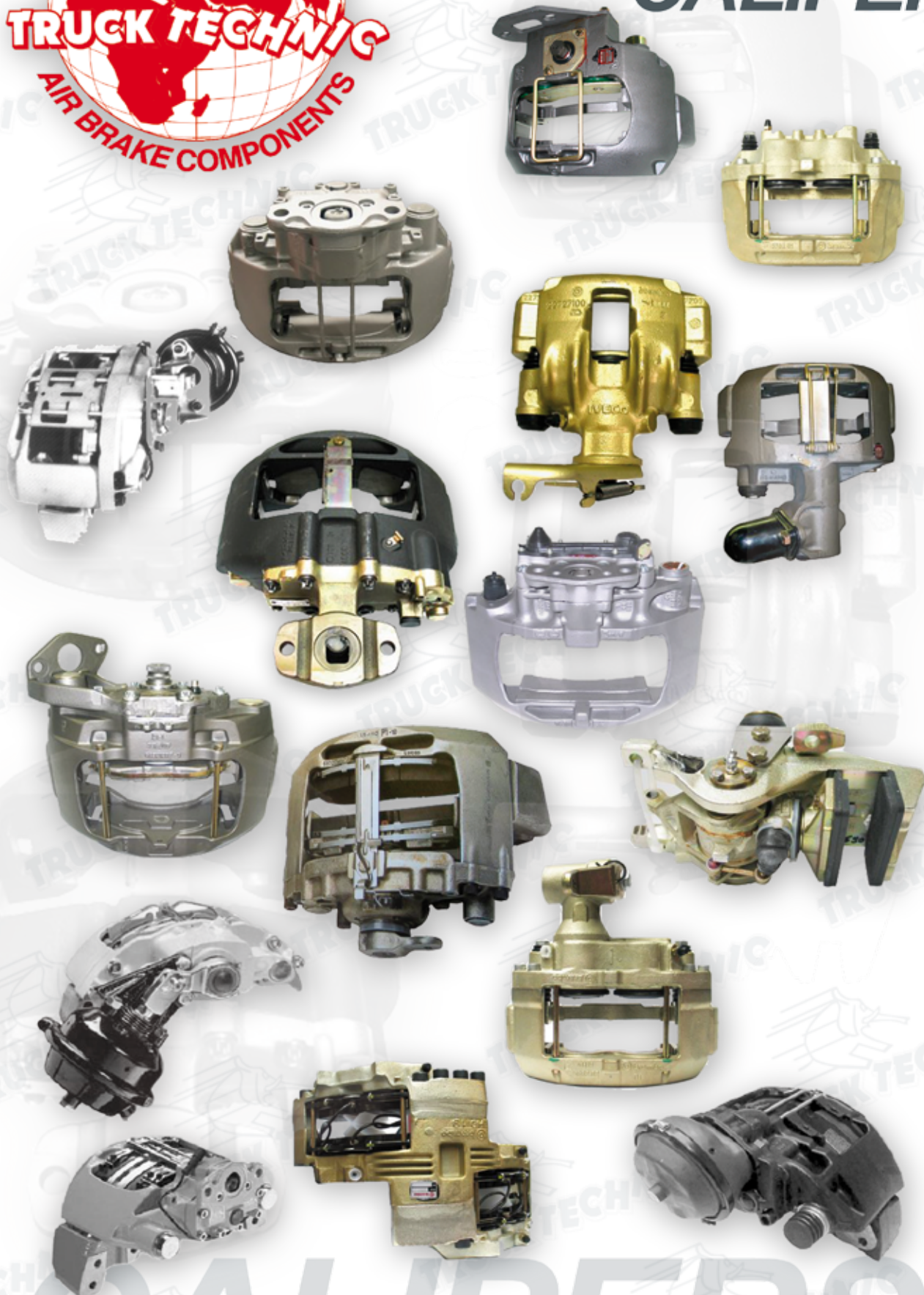

<http://www.trucktechnic.com>

TABLE OF CONTENTS

CALIPERS CROSS-REFERENCE LIST

PAGE
6

CALIPERS AND REPAIR KITS BY CONSTRUCTORS/MODELS



LCV (LIGHT COMMERCIAL VEHICLE)

DAIMLER CHRYSLER MERCEDES	22
IVECO	32
NISSAN	41
RVI	42



HEAVY DUTY VEHICLES

BOVA	46
BPW	47
CZEPEL	48
DAF LEYLAND	49
DAIMLER - CHRYSLER - MERCEDES	55
DENNIS	65
EVO BUS	71
FORD	79
GIGANT SAE	81
IKARUS	82
IRISBUS	83
IVECO	89
KAROSA	100
KASSBOHRER	101
LECINENA	102
MAN	103
MCI	117
NEOPLAN	118
NISSAN	129
ORION IND	130
RABA	131
ROR	132
RVI	135
SAE	150
SAF	151
SCANIA	154
SMB	159
VAN HOOL	162
VOLVO	166



REPAIR KITS DETAILS

WEAR SENSORS	184
CALIPER TOOL CASES	186
KNORR calipers exploded views & repair kits	182
MERITOR calipers exploded views & repair kits	192
WABCO calipers exploded views & repair kits	212
HALDEX caliper exploded view & repair kits	218
BREMBO caliper exploded view & repair kits	226
PONT A MOUSSON caliper exploded view & repair kits	228

Calipers cross-reference list

OEM ref	TT reference	Brand
131774	91.04.003	BENDIX
131776	91.04.003	BENDIX
131777	91.04.004	BENDIX
1137392	91.03.023	BENDIX
1137393	91.03.024	BENDIX
0204102918	96.05.001	BOSCH
0204102919	96.05.002	BOSCH
0536270272	91.02.002	BPW
0536270272	91.02.020	BPW
0536270120	91.03.003	BPW
0536270130	91.03.004	BPW
0536270160	91.02.019	BPW
053627017	91.02.020	BPW
0536270220	91.02.003	BPW
0536270232	91.02.004	BPW
0536270240	91.03.004	BPW
0536270250	91.03.003	BPW
0536270260	91.02.001	BPW
0536270260	91.02.019	BPW
0536270261	91.02.019	BPW
0536270262	91.02.019	BPW
0536270270	91.02.002	BPW
0536270270	91.02.019	BPW
0536270270	91.02.020	BPW
0536270271	91.02.020	BPW
0536270360	91.02.019	BPW
0536270361	91.02.019	BPW
0536270362	91.02.019	BPW
0536270370	91.02.020	BPW
0536270371	91.02.020	BPW
0536270372	91.02.020	BPW
0536270380	91.03.004	BPW
0536270390	91.03.003	BPW
0536270400	91.02.003	BPW
0536270410	91.02.004	BPW
0536270420	91.03.003	BPW
0536270430	91.03.004	BPW
0536270600	91.02.020	BPW
0536270610	91.02.019	BPW
0536270640	91.03.006	BPW
0536270650	91.03.005	BPW
120.5310.10	95.03.001	BREMBO
120.5310.20	95.03.002	BREMBO
122727028	95.08.005	BREMBO
122727029	95.08.006	BREMBO
122730128	95.08.001	BREMBO
122730129	95.08.002	BREMBO
122777573	95.06.007	BREMBO
122777583	95.06.008	BREMBO
20532012	95.02.001	BREMBO
20532022	95.02.002	BREMBO
20532032	95.02.003	BREMBO
20532042	95.02.004	BREMBO
22540030	95.11.001	BREMBO
42536632	95.08.001	BREMBO
42536633	95.08.002	BREMBO
1364759	91.03.004	DAF
1364760	91.03.003	DAF
1388273	91.03.004	DAF
1388274	91.03.003	DAF
1393558	91.03.020	DAF
1393558	91.03.038	DAF
1393559	91.03.019	DAF
1393559	91.03.037	DAF
1399063	91.03.020	DAF
1399064	91.03.019	DAF
1403632	92.01.007	DAF
1403633	92.01.008	DAF
1449167	91.03.020	DAF
1449168	91.03.019	DAF
1627240	91.03.019	DAF
1627241	91.03.020	DAF
1627244	91.03.021	DAF
1627245	91.03.022	DAF
1627246	91.03.019	DAF
1627247	91.03.020	DAF

OEM ref	TT reference	Brand
0014200501	91.03.009	MERCEDES
0014200601	91.03.010	MERCEDES
0014200701	91.03.009	MERCEDES
0014200801	91.03.010	MERCEDES
0014201401	91.02.018	MERCEDES
0014201501	91.02.017	MERCEDES
0014205001	91.03.053	MERCEDES
0014205101	91.03.054	MERCEDES
0014205701	91.02.015	MERCEDES
0014205801	91.02.016	MERCEDES
0014205901	91.02.015	MERCEDES
0014206001	91.02.016	MERCEDES
0014206101	91.02.020	MERCEDES
0014206201	91.02.019	MERCEDES
0014206301	91.01.003	MERCEDES
0014206401	91.01.004	MERCEDES
0014206783	96.05.001	MERCEDES
0014206883	96.05.002	MERCEDES
0014206901	91.03.013	MERCEDES
0014207001	91.03.014	MERCEDES
0024201483	91.03.013	MERCEDES
0024201583	91.03.014	MERCEDES
0024204983	91.03.001	MERCEDES
0024205083	91.03.002	MERCEDES
3564202501	93.04.007	MERCEDES
3564202601	93.04.008	MERCEDES
3564202801	93.04.011	MERCEDES
3564202901	93.04.012	MERCEDES
6274300490	91.03.052	MERCEDES
6274300590	91.03.051	MERCEDES
6284200101	91.03.013	MERCEDES
6284200201	91.03.014	MERCEDES
6294200101	91.03.045	MERCEDES
6294200201	91.03.046	MERCEDES
6294200601	91.03.045	MERCEDES
6294200701	91.03.046	MERCEDES
6664300090	91.03.023	MERCEDES
6664300190	91.03.024	MERCEDES
6694203001	93.01.007	MERCEDES
6694203101	93.01.008	MERCEDES
6704203001	93.01.017	MERCEDES
6704203101	93.01.018	MERCEDES
6704204901	93.02.007	MERCEDES
6704205301	93.02.008	MERCEDES
6704206301	93.02.009	MERCEDES
6704206401	93.02.010	MERCEDES
6704206901	93.02.009	MERCEDES
6704207001	93.02.010	MERCEDES
6704207201	93.01.015	MERCEDES
6704208201	93.01.016	MERCEDES
6884204501	92.01.011	MERCEDES
6884204601	92.01.012	MERCEDES
6884204801	92.01.009	MERCEDES
6884204901	92.01.010	MERCEDES
6884207401	92.01.009	MERCEDES
6884207501	92.01.010	MERCEDES
6884207601	92.01.011	MERCEDES
6884207701	92.01.012	MERCEDES
6964203701	91.03.020	MERCEDES
6964203801	91.03.019	MERCEDES
6964203901	91.03.023	MERCEDES
6964203901	91.03.003	MERCEDES
6964204001	91.03.024	MERCEDES
6964204001	91.03.004	MERCEDES
6964204301	91.03.019	MERCEDES
6964204401	91.03.020	MERCEDES
6964204501	91.03.023	MERCEDES
6964204501	91.03.003	MERCEDES
6964204601	91.03.024	MERCEDES
6964204601	91.03.004	MERCEDES
6964205301	91.03.023	MERCEDES
6964205401	91.03.024	MERCEDES
6964205501	91.03.023	MERCEDES
6964205601	91.03.024	MERCEDES
6964205701	91.03.013	MERCEDES
6964205801	91.03.014	MERCEDES

Calipers cross-reference list

OEM ref	TT reference	Brand	OEM ref	TT reference	Brand
6964205901	91.03.013	MERCEDES	9704203301	91.02.017	MERCEDES
6964206001	91.03.014	MERCEDES	9704203401	91.02.018	MERCEDES
6964206201	91.03.013	MERCEDES	9704203501	91.02.017	MERCEDES
6964206301	91.03.014	MERCEDES	9704203601	91.02.018	MERCEDES
9024201101	92.07.001	MERCEDES	9724206701	91.03.001	MERCEDES
9024201201	92.07.002	MERCEDES	9724206801	91.03.002	MERCEDES
9424200601	91.03.013	MERCEDES	9754200401	91.02.016	MERCEDES
9424200701	91.03.014	MERCEDES	9754200501	91.02.015	MERCEDES
9424201001	91.03.013	MERCEDES	9754201001	91.02.015	MERCEDES
9424201101	91.03.014	MERCEDES	9754201101	91.02.017	MERCEDES
9424201201	91.03.013	MERCEDES	9754201201	91.02.018	MERCEDES
9424201301	91.03.014	MERCEDES	9754201301	91.02.016	MERCEDES
9424201601	91.03.013	MERCEDES	9754201401	91.02.015	MERCEDES
9424201701	91.03.014	MERCEDES	9754201501	91.02.017	MERCEDES
9424201901	91.03.013	MERCEDES	9754201801	91.02.016	MERCEDES
9424202001	91.03.014	MERCEDES	9754201901	91.02.015	MERCEDES
9424202101	91.03.013	MERCEDES	9754202001	91.02.016	MERCEDES
9424202201	91.03.014	MERCEDES	9754202101	91.02.015	MERCEDES
9424202301	91.03.013	MERCEDES	9754202201	91.02.016	MERCEDES
9424202401	91.03.014	MERCEDES	9754202301	91.02.015	MERCEDES
9424202501	91.03.001	MERCEDES	9754202401	91.02.016	MERCEDES
9424202601	91.03.002	MERCEDES	9754202501	91.02.015	MERCEDES
9424202701	91.03.013	MERCEDES	9754202601	91.02.020	MERCEDES
9424202801	91.03.014	MERCEDES	9754202701	91.02.019	MERCEDES
9424203101	91.03.013	MERCEDES	9754202801	91.02.020	MERCEDES
9424203201	91.03.014	MERCEDES	9754202901	91.02.019	MERCEDES
9424203301	91.03.013	MERCEDES	9754203301	91.03.013	MERCEDES
9424203401	91.03.014	MERCEDES	9754203401	91.03.014	MERCEDES
9424203701	91.03.013	MERCEDES	9754204801	91.02.016	MERCEDES
9424203801	91.03.014	MERCEDES	9754204901	91.02.015	MERCEDES
9424204301	91.03.001	MERCEDES	9754205001	91.02.016	MERCEDES
9424204401	91.03.002	MERCEDES	9754205101	91.02.015	MERCEDES
9424204501	91.03.001	MERCEDES	9754205201	91.02.018	MERCEDES
9424204601	91.03.002	MERCEDES	9754205301	91.02.017	MERCEDES
9424204701	91.03.013	MERCEDES	9754205401	91.02.018	MERCEDES
9424204801	91.03.014	MERCEDES	9754205501	91.02.017	MERCEDES
9424204901	91.03.013	MERCEDES	9757201601	91.02.018	MERCEDES
9424205001	91.03.014	MERCEDES	A0014200501	91.03.009	MERCEDES
9424205601	91.03.013	MERCEDES	A0014200601	91.03.010	MERCEDES
9424205701	91.03.014	MERCEDES	A0014200701	91.03.009	MERCEDES
9424205801	91.03.013	MERCEDES	A0014200801	91.03.010	MERCEDES
9424205901	91.03.014	MERCEDES	A6284200101	91.03.013	MERCEDES
9424206001	91.03.013	MERCEDES	A6284200201	91.03.014	MERCEDES
9424206101	91.03.014	MERCEDES	A6294200101	91.03.045	MERCEDES
9424206201	91.03.013	MERCEDES	A6294200201	91.03.046	MERCEDES
9424206301	91.03.014	MERCEDES	A6294200601	91.03.045	MERCEDES
9444201201	91.03.013	MERCEDES	A6294200701	91.03.046	MERCEDES
9444201601	91.03.001	MERCEDES	A6694203001	93.01.007	MERCEDES
9444201701	91.03.002	MERCEDES	A6694203101	93.01.008	MERCEDES
9464200201	91.02.014	MERCEDES	A6704203001	93.01.017	MERCEDES
9464200301	91.02.013	MERCEDES	A6704203101	93.01.018	MERCEDES
9464200401	91.02.014	MERCEDES	A9424200601	91.03.013	MERCEDES
9464200601	91.02.014	MERCEDES	A9424200701	91.03.014	MERCEDES
9464201101	91.02.014	MERCEDES	A9424201001	91.03.013	MERCEDES
9464201501	91.02.019	MERCEDES	A9424201101	91.03.014	MERCEDES
9464201601	91.02.020	MERCEDES	A9424201201	91.03.013	MERCEDES
9494202201	91.03.014	MERCEDES	A9424201301	91.03.014	MERCEDES
9494202401	91.03.014	MERCEDES	A9424201601	91.03.013	MERCEDES
9494203301	91.03.013	MERCEDES	A9424201701	91.03.014	MERCEDES
9494203401	91.03.014	MERCEDES	A9424201901	91.03.013	MERCEDES
9494203701	91.03.013	MERCEDES	A9424202001	91.03.014	MERCEDES
9494203801	91.03.014	MERCEDES	A9424202101	91.03.013	MERCEDES
9704201101	91.01.003	MERCEDES	A9424202201	91.03.014	MERCEDES
9704201201	91.01.004	MERCEDES	A9424202301	91.03.013	MERCEDES
9704201301	91.01.004	MERCEDES	A9424202401	91.03.014	MERCEDES
9704201401	91.01.001	MERCEDES	A9424202501	91.03.001	MERCEDES
9704201501	91.01.002	MERCEDES	A9424202601	91.03.002	MERCEDES
9704201601	91.01.003	MERCEDES	A9424202701	91.03.013	MERCEDES
9704201701	91.01.004	MERCEDES	A9424202801	91.03.014	MERCEDES
9704201801	91.01.001	MERCEDES	A9424203101	91.03.013	MERCEDES
9704201901	91.01.002	MERCEDES	A9424203201	91.03.014	MERCEDES
9704202001	91.01.003	MERCEDES	A9424203301	91.03.013	MERCEDES
9704202101	91.01.004	MERCEDES	A9424203401	91.03.014	MERCEDES
9704202201	91.01.003	MERCEDES	A9424203701	91.03.013	MERCEDES
9704202301	91.01.004	MERCEDES	A9424203801	91.03.014	MERCEDES
9704202401	91.01.003	MERCEDES	A9424204301	91.03.001	MERCEDES

Calipers cross-reference list

OEM ref	TT reference	Brand	OEM ref	TT reference	Brand
A9424204401	91.03.002	MERCEDES	65851735	91.03.051	DENNIS
A9424204501	91.03.001	MERCEDES	65851736	91.03.052	DENNIS
A9424204601	91.03.002	MERCEDES	0014200701	91.03.009	EVOBUS
A9424204701	91.03.013	MERCEDES	0014200801	91.03.010	EVOBUS
A9424204801	91.03.014	MERCEDES	0501005573	91.03.055	EVOBUS
A9424204901	91.03.013	MERCEDES	0501005574	91.03.056	EVOBUS
A9424205001	91.03.014	MERCEDES	0501006007	91.03.053	EVOBUS
A9424205601	91.03.013	MERCEDES	0501006008	91.03.054	EVOBUS
A9424205701	91.03.014	MERCEDES	0501006016	91.03.018	EVOBUS
A9424205801	91.03.013	MERCEDES	0501006017	91.03.017	EVOBUS
A9424205901	91.03.014	MERCEDES	0501006195	91.03.051	EVOBUS
A9424206001	91.03.013	MERCEDES	0501006196	91.03.052	EVOBUS
A9424206101	91.03.014	MERCEDES	0501006293	91.03.013	EVOBUS
A9424206201	91.03.013	MERCEDES	0501006294	91.03.014	EVOBUS
A9424206301	91.03.014	MERCEDES	0501006296	91.03.023	EVOBUS
A9444201601	91.03.001	MERCEDES	0501006297	91.03.024	EVOBUS
A9444201701	91.03.002	MERCEDES	0501006320	91.03.013	EVOBUS
A9464200201	91.02.014	MERCEDES	0501006321	91.03.014	EVOBUS
A9464200401	91.02.014	MERCEDES	0501006591	91.03.051	EVOBUS
A9464200601	91.02.014	MERCEDES	0501006592	91.03.052	EVOBUS
A9464201101	91.02.014	MERCEDES	0501006599	91.03.053	EVOBUS
A9464201501	91.02.019	MERCEDES	0501006600	91.03.054	EVOBUS
A9464201601	91.02.020	MERCEDES	0501006850	91.03.053	EVOBUS
A9494202201	91.03.014	MERCEDES	0501006851	91.03.054	EVOBUS
A9494202401	91.03.014	MERCEDES	0501007172	91.03.053	EVOBUS
A9494203301	91.03.013	MERCEDES	0501007173	91.03.054	EVOBUS
A9494203401	91.03.014	MERCEDES	A6664300090	91.03.023	EVOBUS
A9494203701	91.03.013	MERCEDES	A6664300190	91.03.024	EVOBUS
A9494203801	91.03.014	MERCEDES	Q8285515000	91.03.010	EVOBUS
A9704201101	91.01.003	MERCEDES	Q8285516000	91.03.009	EVOBUS
A9704201201	91.01.004	MERCEDES	R87DB2552AA	93.02.016	FORD
A9704201301	91.01.004	MERCEDES	R87DB2552BA	93.02.012	FORD
A9704201401	91.01.001	MERCEDES	R87DB2553AA	93.02.015	FORD
A9704201501	91.01.002	MERCEDES	R87DB2553BA	93.02.011	FORD
A9704201601	91.01.003	MERCEDES	R87DB2L321AA	93.01.024	FORD
A9704201701	91.01.004	MERCEDES	R87DB2L322AA	93.01.023	FORD
A9704201801	91.01.001	MERCEDES	2100090	91.03.002	GIGANT
A9704201901	91.01.002	MERCEDES	2100091	91.03.001	GIGANT
A9704202001	91.01.003	MERCEDES	2100192	91.03.002	GIGANT
A9704202101	91.01.004	MERCEDES	2100193	91.03.001	GIGANT
A9704202201	91.01.003	MERCEDES	9265165	91.02.020	GIGANT
A9704202301	91.01.004	MERCEDES	9265166	91.02.019	GIGANT
A9704202401	91.01.003	MERCEDES	9285022	91.03.001	GIGANT
A9724206701	91.03.001	MERCEDES	9285023	91.03.002	GIGANT
A9724206801	91.03.002	MERCEDES	9285098	91.02.019	GIGANT
A9754200401	91.02.016	MERCEDES	9285099	91.02.020	GIGANT
A9754200501	91.02.015	MERCEDES	9285157	91.03.002	GIGANT
A9754200901	91.02.016	MERCEDES	9285158	91.03.001	GIGANT
A9754201001	91.02.015	MERCEDES	9285159	91.03.004	GIGANT
A9754201101	91.02.017	MERCEDES	9285160	91.03.003	GIGANT
A9754201201	91.02.018	MERCEDES	90677	94.02.002	HALDEX
A9754201301	91.02.016	MERCEDES	92503	94.02.002	HALDEX
A9754201401	91.02.015	MERCEDES	S268231L	91.03.004	HENDRIKSON
A9754201501	91.02.017	MERCEDES	S268231R	91.03.003	HENDRIKSON
A9754201601	91.02.018	MERCEDES	S269231L	91.03.004	HENDRIKSON
A9754201801	91.02.016	MERCEDES	S269231R	91.03.003	HENDRIKSON
A9754201901	91.02.015	MERCEDES	4830626	93.01.003	IVECO
A9754202001	91.02.016	MERCEDES	4830627	93.01.004	IVECO
A9754202101	91.02.015	MERCEDES	41033392	91.03.033	IVECO
A9754202201	91.02.016	MERCEDES	41033393	91.03.034	IVECO
A9754202301	91.02.015	MERCEDES	41033394	91.03.033	IVECO
A9754202401	91.02.016	MERCEDES	41033395	91.03.034	IVECO
A9754202501	91.02.015	MERCEDES	42470837	95.05.001	IVECO
A9754202601	91.02.020	MERCEDES	42470838	95.05.002	IVECO
A9754202701	91.02.019	MERCEDES	42470847	95.06.001	IVECO
A9754202801	91.02.020	MERCEDES	42470848	95.06.002	IVECO
A9754202901	91.02.019	MERCEDES	42530362	95.06.005	IVECO
A9754203301	91.03.013	MERCEDES	42530363	95.06.006	IVECO
A9754203401	91.03.014	MERCEDES	42534115	95.10.001	IVECO
SM48635K	91.03.017	DANBUS	42534116	95.10.002	IVECO
SM48636K	91.03.018	DANBUS	42534117	95.10.003	IVECO
5000807464	96.01.002	DBA	42534118	95.10.004	IVECO
B327059	96.01.001	DBA	42534119	95.09.001	IVECO
B327060	96.01.002	DBA	42534120	95.09.002	IVECO
65847042	91.03.018	DENNIS	42534121	95.09.003	IVECO
65847043	91.03.017	DENNIS	42534122	95.09.004	IVECO

Calipers cross-reference list

OEM ref	TT reference	Brand	OEM ref	TT reference	Brand
42536172	95.06.001	IVECO	I133982	91.03.032	KNORR
42536173	95.06.002	IVECO	I134161	91.02.019	KNORR
42536174	95.06.005	IVECO	I134162	91.02.020	KNORR
42536175	95.06.006	IVECO	I134323	91.03.010	KNORR
42536624	95.06.001	IVECO	I134324	91.03.009	KNORR
42536625	95.06.002	IVECO	I134325	91.03.010	KNORR
42536628	95.05.001	IVECO	I134326	91.03.009	KNORR
42536629	95.05.002	IVECO	I134456	91.03.017	KNORR
42536630	95.08.005	IVECO	I134457	91.03.018	KNORR
42536631	95.08.006	IVECO	I134458	91.03.017	KNORR
42548181	95.08.005	IVECO	I134459	91.03.018	KNORR
42548182	95.08.006	IVECO	I134475	91.03.013	KNORR
42548185	95.07.003	IVECO	I134476	91.03.014	KNORR
42548186	95.07.004	IVECO	I134477	91.03.013	KNORR
42548187	95.06.001	IVECO	I134478	91.03.014	KNORR
42548188	95.06.002	IVECO	I134487	91.03.003	KNORR
42548189	95.06.005	IVECO	I134488	91.03.004	KNORR
42548190	95.06.006	IVECO	I134592	91.03.010	KNORR
93163056	95.03.001	IVECO	I134593	91.03.009	KNORR
93163057	95.03.002	IVECO	I134598	91.03.003	KNORR
93190874	95.03.004	IVECO	I134599	91.03.004	KNORR
93190875	95.03.003	IVECO	I134604	91.03.040	KNORR
98417405	91.04.003	IVECO	I134820	91.03.001	KNORR
98417406	91.04.004	IVECO	I134821	91.03.002	KNORR
98447620	91.04.001	IVECO	I134898	91.03.052	KNORR
98447621	91.04.002	IVECO	I134899	91.03.052	KNORR
98479590	91.04.003	IVECO	I135396	91.03.053	KNORR
98479591	91.04.004	IVECO	I135397	91.03.054	KNORR
98479593	91.04.003	IVECO	I135401	91.03.001	KNORR
98479594	91.04.004	IVECO	I135402	91.03.002	KNORR
98479613	91.04.001	IVECO	I135540	91.03.003	KNORR
98479614	91.04.002	IVECO	I135541	91.03.004	KNORR
99458477	91.03.031	IVECO	I135813	91.03.013	KNORR
99458478	91.03.032	IVECO	I135814	91.03.014	KNORR
99464100	95.04.005	IVECO	I135815	91.03.013	KNORR
99464101	95.04.006	IVECO	I135816	91.03.014	KNORR
99483108	91.03.031	IVECO	I136681	91.01.004	KNORR
99483109	91.03.032	IVECO	I136682	91.01.003	KNORR
500328232	92.01.003	IVECO	I136683	91.01.002	KNORR
500328234	92.01.004	IVECO	I136684	91.01.001	KNORR
500363442	91.02.009	IVECO	I136685	91.01.004	KNORR
500363443	91.02.010	IVECO	I136686	91.01.003	KNORR
5000297257	95.11.001	IVECO	I136687	91.01.002	KNORR
5001848129	95.08.003	IVECO	I136688	91.01.001	KNORR
5001848130	95.08.004	IVECO	I136689	91.03.013	KNORR
5001848133	95.07.001	IVECO	I136690	91.03.014	KNORR
5001848134	95.07.002	IVECO	I136691	91.03.013	KNORR
I119723	91.03.010	KNORR	I136692	91.03.014	KNORR
I119724	91.03.009	KNORR	I136693	91.03.013	KNORR
I119725	91.03.010	KNORR	I136694	91.03.014	KNORR
I119726	91.03.009	KNORR	I136699	91.02.018	KNORR
I130175	91.03.017	KNORR	I136700	91.02.017	KNORR
I130400	91.03.018	KNORR	I136701	91.02.015	KNORR
I131022	91.03.039	KNORR	I136702	91.02.016	KNORR
I131023	91.03.040	KNORR	I136703	91.02.018	KNORR
I131026	91.03.039	KNORR	I136704	91.02.017	KNORR
I131027	91.03.040	KNORR	I136705	91.02.015	KNORR
I131030	91.03.039	KNORR	I136706	91.02.016	KNORR
I131031	91.03.040	KNORR	I136802	91.03.071	KNORR
I131984	91.03.059	KNORR	I136803	91.03.072	KNORR
I131985	91.03.060	KNORR	I136804	91.03.019	KNORR
I132203	91.03.001	KNORR	I136805	91.03.020	KNORR
I132204	91.03.002	KNORR	I136999	91.03.013	KNORR
I132798	91.03.013	KNORR	I137000	91.03.014	KNORR
I132799	91.03.014	KNORR	I137001	91.03.023	KNORR
I132800	91.03.013	KNORR	I137002	91.03.024	KNORR
I132801	91.03.014	KNORR	I137006	91.03.041	KNORR
I132802	91.03.013	KNORR	I137007	91.03.042	KNORR
I132803	91.03.014	KNORR	I137025	91.02.015	KNORR
I132812	91.03.055	KNORR	I137026	91.02.016	KNORR
I132813	91.03.056	KNORR	I137029	91.03.003	KNORR
I133430	91.03.017	KNORR	I137030	91.03.004	KNORR
I133431	91.03.018	KNORR	I137072	91.03.045	KNORR
I133432	91.03.023	KNORR	I137073	91.03.046	KNORR
I133433	91.03.024	KNORR	I137077	91.03.013	KNORR
I133981	91.03.031	KNORR	I137078	91.03.014	KNORR

Calipers cross-reference list

OEM ref	TT reference	Brand	OEM ref	TT reference	Brand
I137080	91.03.003	KNORR	I139039F	91.02.020	KNORR
I137081	91.03.004	KNORR	I139044F	91.03.003	KNORR
I137223	91.02.013	KNORR	I139045F	91.03.004	KNORR
I137224	91.02.014	KNORR	I139046F	91.02.019	KNORR
I137225	91.02.013	KNORR	I139047F	91.02.020	KNORR
I137226	91.02.014	KNORR	I139048F	91.02.003	KNORR
I137229	91.03.023	KNORR	I139049F	91.02.004	KNORR
I137230	91.03.024	KNORR	I139258F	91.02.009	KNORR
I137231	91.03.023	KNORR	I139259F	91.02.010	KNORR
I137232	91.03.024	KNORR	I139264F	91.03.001	KNORR
I137380	91.03.023	KNORR	I139265F	91.03.002	KNORR
I137381	91.03.024	KNORR	I139266F	91.02.019	KNORR
I137390	91.03.001	KNORR	I139267F	91.02.020	KNORR
I137391	91.03.002	KNORR	K000007	91.03.003	KNORR
I137392	91.03.023	KNORR	K000008	91.03.004	KNORR
I137393	91.03.024	KNORR	K000043	91.03.017	KNORR
I137398	91.03.033	KNORR	K000044	91.03.018	KNORR
I137399	91.03.034	KNORR	K000115	91.02.019	KNORR
I137419	91.03.003	KNORR	K000116	91.02.020	KNORR
I137420	91.03.004	KNORR	K000136	91.03.003	KNORR
I137421	91.03.003	KNORR	K000137	91.03.004	KNORR
I137422	91.03.004	KNORR	K000138	91.03.001	KNORR
I137424	91.03.058	KNORR	K000139	91.03.002	KNORR
I137686	91.02.019	KNORR	K000211	91.02.014	KNORR
I137687	91.02.020	KNORR	K000213	91.02.014	KNORR
I137690	91.02.003	KNORR	K000215	91.02.014	KNORR
I137691	91.02.004	KNORR	K000217	91.02.014	KNORR
i137696	91.03.071	KNORR	K000258	91.03.057	KNORR
I137697	91.03.072	KNORR	K000259	91.03.058	KNORR
i137698	91.03.019	KNORR	K000260	91.03.033	KNORR
I137699	91.03.020	KNORR	K000261	91.03.034	KNORR
I137702	91.03.071	KNORR	K000262	91.03.055	KNORR
I137703	91.03.072	KNORR	K000263	91.03.056	KNORR
I137791	91.03.039	KNORR	K000300	91.02.019	KNORR
I137792	91.03.040	KNORR	K000301	91.02.020	KNORR
I137797	91.02.015	KNORR	K000310	91.03.013	KNORR
I137798	91.02.016	KNORR	K000311	91.03.014	KNORR
I137799	91.02.015	KNORR	K000312	91.03.013	KNORR
I137800	91.02.016	KNORR	K000313	91.03.014	KNORR
I137801	91.02.015	KNORR	K000314	91.03.013	KNORR
I137802	91.02.016	KNORR	K000315	91.03.014	KNORR
I137803	91.01.004	KNORR	K000316	91.03.013	KNORR
I137804	91.01.003	KNORR	K000317	91.03.014	KNORR
I137805	91.01.004	KNORR	K000320	91.03.003	KNORR
I137806	91.01.003	KNORR	K000321	91.03.004	KNORR
I137808	91.03.001	KNORR	K000412	91.03.031	KNORR
I137809	91.03.002	KNORR	K000413	91.03.032	KNORR
I137810	91.02.001	KNORR	K000433	91.02.001	KNORR
I137811	91.02.002	KNORR	K000434	91.02.002	KNORR
I137812	91.03.051	KNORR	K000435	91.02.001	KNORR
I137813	91.03.052	KNORR	K000436	91.02.002	KNORR
I137814	91.03.053	KNORR	K000437	91.02.001	KNORR
I137815	91.03.054	KNORR	K000438	91.02.002	KNORR
I137818	91.03.015	KNORR	K000445	91.03.001	KNORR
I137819	91.03.016	KNORR	K000446	91.03.002	KNORR
I138350F	91.03.001	KNORR	K000476	91.03.001	KNORR
I138351F	91.03.002	KNORR	K000477	91.03.002	KNORR
I138648F	91.03.051	KNORR	K000485	91.03.051	KNORR
I138649F	91.03.052	KNORR	K000486	91.03.052	KNORR
I138724F	91.03.013	KNORR	K000517	91.03.001	KNORR
I138725F	91.03.014	KNORR	K000518	91.03.002	KNORR
I138726F	91.03.013	KNORR	K000550	91.03.001	KNORR
I138727F	91.03.014	KNORR	K000551	91.03.002	KNORR
I138728F	91.03.013	KNORR	K000552	91.03.017	KNORR
I138729F	91.03.014	KNORR	K000553	91.03.018	KNORR
I138730F	91.03.045	KNORR	K000571	91.03.001	KNORR
I138731F	91.03.046	KNORR	K000572	91.03.002	KNORR
I138816F	91.03.023	KNORR	K000584	91.02.003	KNORR
I138817F	91.03.024	KNORR	K000585	91.02.004	KNORR
I138824F	91.03.047	KNORR	K000719	91.03.003	KNORR
I138825F	91.03.048	KNORR	K000720	91.03.004	KNORR
I139006F	91.03.053	KNORR	K000822	91.03.001	KNORR
I139007F	91.03.054	KNORR	K000823	91.03.002	KNORR
I139036F	91.02.019	KNORR	K000870	91.03.003	KNORR
I139037F	91.02.020	KNORR	K000871	91.03.004	KNORR
I139038F	91.02.019	KNORR	K000872	91.03.003	KNORR

Calipers cross-reference list

OEM ref	TT reference	Brand	OEM ref	TT reference	Brand
K000873	91.03.004	KNORR	K003784	91.03.003	KNORR
K001007	91.03.023	KNORR	K003793	91.02.017	KNORR
K001008	91.03.024	KNORR	K003794	91.02.018	KNORR
K001009	91.03.023	KNORR	K003795	91.03.010	KNORR
K001010	91.03.024	KNORR	K003796	91.03.009	KNORR
K001015	91.03.071	KNORR	K003799	91.03.014	KNORR
K001016	91.03.072	KNORR	K003800	91.03.013	KNORR
K001051	91.03.003	KNORR	K003803	91.03.018	KNORR
K001052	91.03.004	KNORR	K003804	91.03.017	KNORR
K001081	91.02.019	KNORR	K003809	91.03.024	KNORR
K001082	91.02.020	KNORR	K003810	91.03.023	KNORR
K001115	91.03.001	KNORR	K003825	91.02.014	KNORR
K001116	91.03.002	KNORR	K003826	91.02.013	KNORR
K001117	91.02.019	KNORR	K004570	91.01.002	KNORR
K001118	91.02.020	KNORR	K004571	91.01.001	KNORR
K001140	91.03.001	KNORR	K004572	91.01.004	KNORR
K001141	91.03.002	KNORR	K004573	91.01.003	KNORR
K001216	91.03.013	KNORR	K004578	91.03.032	KNORR
K001217	91.03.014	KNORR	K004579	91.03.031	KNORR
K001218	91.03.013	KNORR	K004580	91.03.034	KNORR
K001219	91.03.014	KNORR	K004581	91.03.033	KNORR
K001220	91.03.013	KNORR	Z0010911	91.03.001	KNORR
K001221	91.03.014	KNORR	Z0010912	91.03.002	KNORR
K001222	91.03.013	KNORR	Z0011451	91.02.019	KNORR
K001223	91.03.014	KNORR	Z0011452	91.02.020	KNORR
K001225	91.03.019	KNORR	Z0011471	91.03.003	KNORR
K001226	91.03.020	KNORR	Z0011472	91.03.004	KNORR
K001291	91.03.001	KNORR	Z0011491	91.03.001	KNORR
K001292	91.03.002	KNORR	Z0011492	91.03.002	KNORR
K001338	91.02.019	KNORR	Z0011521	91.03.047	KNORR
K001339	91.02.020	KNORR	Z0011522	91.03.048	KNORR
K001374	91.03.003	KNORR	Z0011541	91.02.019	KNORR
K001375	91.03.004	KNORR	Z0011542	91.02.020	KNORR
K001413	91.03.001	KNORR	Z0011581	91.03.003	KNORR
K001414	91.03.002	KNORR	Z0011582	91.03.004	KNORR
K001442	91.02.019	KNORR	Z0013571	91.03.017	KNORR
K001443	91.02.020	KNORR	Z0013572	91.03.018	KNORR
K001444	91.02.002	KNORR	Z0013591	91.03.023	KNORR
K001445	91.02.001	KNORR	Z0013592	91.03.024	KNORR
K001545	91.02.019	KNORR	Z0014981M1	91.03.056	KNORR
K001546	91.02.020	KNORR	Z0014982M1	91.03.055	KNORR
K001659	91.03.017	KNORR	Z0016511	91.02.019	KNORR
K001660	91.03.018	KNORR	Z0016512	91.02.020	KNORR
K001666	91.03.003	KNORR	Z0016571	91.03.041	KNORR
K001667	91.03.004	KNORR	Z0016572	91.03.042	KNORR
K001753	91.03.004	KNORR	Z0017521	91.03.001	KNORR
K001754	91.03.003	KNORR	Z0017522	91.03.002	KNORR
K002519	91.03.004	KNORR	Z0017523	91.03.001	KNORR
K002520	91.03.003	KNORR	Z0017524	91.03.002	KNORR
K002793	91.03.042	KNORR	Z0017671	91.02.019	KNORR
K002794	91.03.041	KNORR	Z0017672	91.02.020	KNORR
K002797	91.03.046	KNORR	Z0017891	91.02.019	KNORR
K002798	91.03.045	KNORR	Z0017892	91.02.020	KNORR
K002874	91.02.002	KNORR	Z0021001	91.03.017	KNORR
K002875	91.02.001	KNORR	Z0021002	91.03.018	KNORR
K002919	91.02.010	KNORR	Z0021103	91.03.051	KNORR
K002920	91.02.009	KNORR	Z0021104	91.03.052	KNORR
K002923	91.02.003	KNORR	Z0021121	91.03.053	KNORR
K002924	91.02.004	KNORR	Z0021122	91.03.054	KNORR
K002934	91.02.019	KNORR	Z0021141	91.03.051	KNORR
K002935	91.02.020	KNORR	Z0021142	91.03.052	KNORR
K002962	91.03.052	KNORR	Z0021241	91.03.053	KNORR
K002963	91.03.051	KNORR	Z0021242	91.03.054	KNORR
K002964	91.03.054	KNORR	K002363	91.03.013	KNORR
K002965	91.03.053	KNORR	K002364	91.03.014	KNORR
K002966	91.03.056	KNORR	SB5002	91.01.002	KNORR
K002967	91.03.055	KNORR	SB5003	91.01.004	KNORR
K002968	91.03.058	KNORR	SB5006	91.03.004	KNORR
K002969	91.03.057	KNORR	SB5012	91.01.001	KNORR
K003192	91.03.060	KNORR	SB5013	91.01.003	KNORR
K003193	91.03.059	KNORR	SB5016	91.03.003	KNORR
K003779	91.02.020	KNORR	SB6057	91.02.013	KNORR
K003780	91.02.019	KNORR	SB6400	91.02.002	KNORR
K003781	91.03.002	KNORR	SB6401	91.02.003	KNORR
K003782	91.03.001	KNORR	SB6408	91.02.010	KNORR
K003783	91.03.004	KNORR	SB6410	91.02.001	KNORR

Calipers cross-reference list

OEM ref	TT reference	Brand	OEM ref	TT reference	Brand
SB6411	91.02.004	KNORR	SB7200	91.03.057	KNORR
SB6418	91.02.009	KNORR	SB7201	91.03.051	KNORR
SB6503	91.02.013	KNORR	SB7202	91.03.058	KNORR
SB6506	91.02.018	KNORR	SB7210	91.03.058	KNORR
SB6507	91.02.015	KNORR	SB7211	91.03.052	KNORR
SB6508	91.02.013	KNORR	SB7212	91.03.057	KNORR
SB6513	91.02.014	KNORR	SB7420	91.03.042	KNORR
SB6516	91.02.017	KNORR	SB7422	91.03.046	KNORR
SB6517	91.02.016	KNORR	SB7430	91.03.041	KNORR
SB6518	91.02.014	KNORR	SB7432	91.03.045	KNORR
SB6520	91.02.019	KNORR	SB7450	91.03.052	KNORR
SB6521	91.02.001	KNORR	SB7451	91.03.054	KNORR
SB6525	91.02.015	KNORR	SB7452	91.03.056	KNORR
SB6527	91.02.019	KNORR	SB7453	91.03.058	KNORR
SB6528	91.02.003	KNORR	SB7455	91.03.060	KNORR
SB6529	91.02.013	KNORR	SB7460	91.03.051	KNORR
SB6529	91.02.001	KNORR	SB7461	91.03.053	KNORR
SB6530	91.02.020	KNORR	SB7462	91.03.055	KNORR
SB6531	91.02.002	KNORR	SB7463	91.03.057	KNORR
SB6535	91.02.016	KNORR	SB7465	91.03.059	KNORR
SB6537	91.02.020	KNORR	SB7580	91.03.010	KNORR
SB6538	91.02.004	KNORR	SB7586	91.03.023	KNORR
SB6539	91.02.014	KNORR	SB7588	91.03.017	KNORR
SB6539	91.02.002	KNORR	SB7590	91.03.009	KNORR
SB6540	91.02.019	KNORR	SB7596	91.03.024	KNORR
SB6547	91.02.009	KNORR	SB7598	91.03.018	KNORR
SB6548	91.02.019	KNORR	SB7604	91.03.017	KNORR
SB6550	91.02.020	KNORR	SB7614	91.03.018	KNORR
SB6557	91.02.010	KNORR	SB7629	91.03.039	KNORR
SB6558	91.02.020	KNORR	SB7639	91.03.040	KNORR
SB6559	91.02.002	KNORR	SB7640	91.03.039	KNORR
SB6567	91.02.019	KNORR	SB7648	91.03.013	KNORR
SB6569	91.02.001	KNORR	SB7649	91.03.013	KNORR
SB6576	91.02.014	KNORR	SB7650	91.03.040	KNORR
SB6577	91.02.020	KNORR	SB7658	91.03.014	KNORR
SB6579	91.02.002	KNORR	SB7659	91.03.014	KNORR
SB6580	91.02.001	KNORR	SB7660	91.03.013	KNORR
SB6581	91.02.001	KNORR	SB7666	91.03.017	KNORR
SB6582	91.02.003	KNORR	SB7670	91.03.014	KNORR
SB6590	91.02.002	KNORR	SB7676	91.03.018	KNORR
SB6591	91.02.002	KNORR	SB7679	91.03.041	KNORR
SB6592	91.02.004	KNORR	SB7680	91.03.041	KNORR
SB7041	91.03.039	KNORR	SB7681	91.03.001	KNORR
SB7051	91.03.040	KNORR	SB7682	91.03.031	KNORR
SB7102	91.03.059	KNORR	SB7689	91.03.042	KNORR
SB7103	91.03.055	KNORR	SB7690	91.03.042	KNORR
SB7108	91.03.053	KNORR	SB7691	91.03.002	KNORR
SB7112	91.03.060	KNORR	SB7692	91.03.032	KNORR
SB7113	91.03.056	KNORR	SB7698	91.03.040	KNORR
SB7115	91.03.052	KNORR	SB7701	91.03.010	KNORR
SB7118	91.03.054	KNORR	SB7702	91.03.010	KNORR
SB7122	91.03.057	KNORR	SB7705	91.03.017	KNORR
SB7123	91.03.051	KNORR	SB7706	91.03.017	KNORR
SB7124	91.03.053	KNORR	SB7708	91.03.003	KNORR
SB7126	91.03.015	KNORR	SB7711	91.03.009	KNORR
SB7132	91.03.058	KNORR	SB7712	91.03.009	KNORR
SB7133	91.03.052	KNORR	SB7715	91.03.018	KNORR
SB7134	91.03.054	KNORR	SB7716	91.03.018	KNORR
SB7136	91.03.016	KNORR	SB7718	91.03.004	KNORR
SB7140	91.03.051	KNORR	SB7721	91.03.003	KNORR
SB7146	91.03.053	KNORR	SB7723	91.03.001	KNORR
SB7150	91.03.052	KNORR	SB7724	91.03.001	KNORR
SB7156	91.03.054	KNORR	SB7726	91.03.003	KNORR
SB7167	91.03.055	KNORR	SB7731	91.03.004	KNORR
SB7168	91.03.051	KNORR	SB7733	91.03.002	KNORR
SB7169	91.03.053	KNORR	SB7734	91.03.002	KNORR
SB7177	91.03.056	KNORR	SB7736	91.03.004	KNORR
SB7178	91.03.052	KNORR	SB7746	91.03.071	KNORR
SB7179	91.03.054	KNORR	SB7747	91.03.019	KNORR
SB7180	91.03.053	KNORR	SB7749	91.03.071	KNORR
SB7181	91.03.051	KNORR	SB7756	91.03.072	KNORR
SB7185	91.03.051	KNORR	SB7757	91.03.020	KNORR
SB7189	91.03.055	KNORR	SB7759	91.03.072	KNORR
SB7190	91.03.054	KNORR	SB7760	91.03.013	KNORR
SB7191	91.03.052	KNORR	SB7761	91.03.023	KNORR
SB7199	91.03.056	KNORR	SB7762	91.03.003	KNORR

Calipers cross-reference list

OEM ref	TT reference	Brand	OEM ref	TT reference	Brand
SB7766	91.03.045	KNORR	SN6514	91.02.016	KNORR
SB7767	91.03.003	KNORR	SN6527	91.02.019	KNORR
SB7770	91.03.014	KNORR	SN6529	91.02.019	KNORR
SB7771	91.03.024	KNORR	SN6537	91.02.020	KNORR
SB7772	91.03.004	KNORR	SN6539	91.02.020	KNORR
SB7776	91.03.046	KNORR	SN6541	91.02.017	KNORR
SB7777	91.03.004	KNORR	SN6542	91.02.019	KNORR
SB7780	91.03.023	KNORR	SN6546	91.02.019	KNORR
SB7783	91.03.023	KNORR	SN6550	91.02.017	KNORR
SB7784	91.03.001	KNORR	SN6551	91.02.018	KNORR
SB7785	91.03.023	KNORR	SN6552	91.02.020	KNORR
SB7787	91.03.033	KNORR	SN6555	91.02.014	KNORR
SB7789	91.03.039	KNORR	SN6556	91.02.020	KNORR
SB7790	91.03.024	KNORR	SN6557-K00379	91.02.016	KNORR
SB7793	91.03.024	KNORR	SN6558	91.02.017	KNORR
SB7794	91.03.002	KNORR	SN6560	91.02.018	KNORR
SB7795	91.03.024	KNORR	SN6563	91.02.019	KNORR
SB7797	91.03.034	KNORR	SN6565	91.02.013	KNORR
SB7799	91.03.040	KNORR	SN6567-K00379	91.02.015	KNORR
SB7800	91.03.001	KNORR	SN6568	91.02.018	KNORR
SB7801	91.03.001	KNORR	SN6573	91.02.020	KNORR
SB7810	91.03.002	KNORR	SN7020	91.03.013	KNORR
SB7811	91.03.002	KNORR	SN7022	91.03.013	KNORR
SB7820	91.03.023	KNORR	SN7028	91.03.001	KNORR
SB7821	91.03.047	KNORR	SN7030	91.03.014	KNORR
SB7829	91.03.003	KNORR	SN7038	91.03.002	KNORR
SB7830	91.03.024	KNORR	SN7040	91.03.017	KNORR
SB7831	91.03.048	KNORR	SN7049	91.03.014	KNORR
SB7839	91.03.004	KNORR	SN7050	91.03.018	KNORR
SB7861	91.03.003	KNORR	SN7059	91.03.013	KNORR
SB7862	91.03.037	KNORR	SN7067	91.03.001	KNORR
SB7871	91.03.004	KNORR	SN7077	91.03.002	KNORR
SB7872	91.03.038	KNORR	SN7085	91.03.003	KNORR
SB7880	91.03.019	KNORR	SN7088	91.03.023	KNORR
SB7883	91.03.017	KNORR	SN7095	91.03.004	KNORR
SB7888	91.03.017	KNORR	SN7098	91.03.024	KNORR
SB7889	91.03.023	KNORR	SN7100-K001015	91.03.071	KNORR
SB7890	91.03.020	KNORR	SN7105	91.03.001	KNORR
SB7893	91.03.018	KNORR	SN7106	91.03.001	KNORR
SB7898	91.03.018	KNORR	SN7109	91.03.013	KNORR
SB7899	91.03.024	KNORR	SN7110	91.03.013	KNORR
SB7900	91.03.003	KNORR	SN7110-K001016	91.03.072	KNORR
SB7901	91.03.001	KNORR	SN7110-K001222	91.03.013	KNORR
SB7902	91.03.033	KNORR	SN7115	91.03.002	KNORR
SB7903	91.03.001	KNORR	SN7116	91.03.002	KNORR
SB7904	91.03.003	KNORR	SN7119	91.03.014	KNORR
SB7906	91.03.031	KNORR	SN7120	91.03.014	KNORR
SB7909	91.03.017	KNORR	SN7120-K001223	91.03.014	KNORR
SB7910	91.03.004	KNORR	SN7121	91.03.019	KNORR
SB7911	91.03.002	KNORR	SN7124	91.03.001	KNORR
SB7912	91.03.034	KNORR	SN7128	91.03.019	KNORR
SB7913	91.03.002	KNORR	SN7131	91.03.020	KNORR
SB7914	91.03.004	KNORR	SN7134	91.03.002	KNORR
SB7916	91.03.032	KNORR	SN7138	91.03.020	KNORR
SB7919	91.03.018	KNORR	SN7141	91.03.003	KNORR
SB7929	91.03.001	KNORR	SN7142	91.03.001	KNORR
SB7939	91.03.002	KNORR	SN7151	91.03.004	KNORR
SB7960	91.03.067	KNORR	SN7152	91.03.002	KNORR
SB7961	91.03.003	KNORR	SN7164	91.03.005	KNORR
SB7970	91.03.068	KNORR	SN7167	91.03.021	KNORR
SB7971	91.03.004	KNORR	SN7168	91.03.019	KNORR
SJ1204	93.02.001	KNORR	SN7174	91.03.006	KNORR
SJ1205	93.02.002	KNORR	SN7177	91.03.022	KNORR
SJ4039	93.08.019	KNORR	SN7178	91.03.020	KNORR
SJ4040	93.08.020	KNORR	SN7185	91.03.002	KNORR
SJ4049	93.04.003	KNORR	SN7186	91.03.004	KNORR
SJ4050	93.04.004	KNORR	SN7187	91.03.006	KNORR
SJ4081	93.05.005	KNORR	SN7189	91.03.010	KNORR
SJ4082	93.05.006	KNORR	SN7195	91.03.001	KNORR
SN5003	91.03.004	KNORR	SN7196	91.03.003	KNORR
SN5005	91.01.002	KNORR	SN7197	91.03.005	KNORR
SN5006	91.01.004	KNORR	SN7199	91.03.009	KNORR
SN5013	91.03.003	KNORR	SN7201	91.03.014	KNORR
SN5015	91.01.001	KNORR	SN7203	91.03.018	KNORR
SN5016	91.01.003	KNORR	SN7204	91.03.020	KNORR
SN6504	91.02.015	KNORR	SN7205	91.03.022	KNORR

Calipers cross-reference list

OEM ref	TT reference	Brand	OEM ref	TT reference	Brand
SN7206	91.03.024	KNORR	81508046195	93.08.009	MAN
SN7211	91.03.013	KNORR	81508046197	93.08.015	MAN
SN7213	91.03.017	KNORR	81508046198	93.08.016	MAN
SN7214	91.03.019	KNORR	81508046199	93.08.001	MAN
SN7215	91.03.021	KNORR	81508046200	93.08.002	MAN
SN7216	91.03.023	KNORR	81508046201	93.08.001	MAN
SN7241	91.03.032	KNORR	81508046202	93.08.002	MAN
SN7242	91.03.034	KNORR	81508046217	93.08.015	MAN
SN7251	91.03.031	KNORR	81508046218	93.08.016	MAN
SN7252	91.03.033	KNORR	81508046256	93.08.014	MAN
SP8996	93.03.001	KNORR	81508046257	93.08.013	MAN
SP8997	93.03.001	KNORR	81508046259	93.08.005	MAN
Z000723	91.03.013	KNORR	81508046260	93.08.006	MAN
Z000724	91.03.014	KNORR	81508046265	93.08.001	MAN
412017	91.02.001	LECINENA	81508046266	93.08.002	MAN
412018	91.02.002	LECINENA	81508046270	93.08.018	MAN
412023	91.03.003	LECINENA	81508046271	93.08.017	MAN
412024	91.03.004	LECINENA	81508046280	93.08.006	MAN
412027	91.03.004	LECINENA	81508046281	93.08.005	MAN
412028	91.03.003	LECINENA	81508046282	93.08.001	MAN
815046158	93.08.006	MAN	81508046283	93.08.002	MAN
81508046011	93.04.001	MAN	81508046290	93.08.004	MAN
81508046012	93.04.002	MAN	81508046291	93.08.003	MAN
81508046017	92.04.001	MAN	81508046297	93.08.011	MAN
81508046018	92.04.002	MAN	81508046298	93.08.012	MAN
81508046021	93.08.001	MAN	81508046299	93.08.003	MAN
81508046022	93.08.002	MAN	81508046300	93.08.004	MAN
81508046040	93.08.004	MAN	81508046305	93.08.001	MAN
81508046041	93.08.003	MAN	81508046306	93.08.002	MAN
81508046042	93.08.004	MAN	81508046307	93.08.017	MAN
81508046043	93.08.003	MAN	81508046308	93.08.018	MAN
81508046048	92.04.002	MAN	81508046311	93.09.001	MAN
81508046049	92.04.001	MAN	81508046312	93.09.002	MAN
81508046053	91.02.013	MAN	81508046313	93.09.006	MAN
81508046054	91.02.014	MAN	81508046319	93.09.001	MAN
81508046056	91.02.014	MAN	81508046320	93.09.002	MAN
81508046057	91.02.013	MAN	81508046321	93.09.005	MAN
81508046061	93.04.001	MAN	81508046322	93.09.006	MAN
81508046062	93.04.002	MAN	81508046340	93.09.008	MAN
81508046063	93.04.001	MAN	81508046341	93.09.007	MAN
81508046064	93.04.002	MAN	81508046367	91.02.001	MAN
81508046065	93.08.001	MAN	81508046368	91.02.002	MAN
81508046066	93.08.002	MAN	81508046369	91.02.001	MAN
81508046067	93.08.005	MAN	81508046370	91.02.002	MAN
81508046068	93.08.006	MAN	81508046371	91.02.001	MAN
81508046070	92.01.002	MAN	81508046372	91.02.002	MAN
81508046071	92.01.001	MAN	81508046389	93.09.009	MAN
81508046072	92.01.002	MAN	81508046390	93.09.010	MAN
81508046073	92.01.001	MAN	81508046405	93.08.027	MAN
81508046081	93.08.001	MAN	81508046406	93.08.028	MAN
81508046082	93.08.002	MAN	81508049017	92.04.001	MAN
81508046087	92.01.001	MAN	81508049018	92.04.002	MAN
81508046088	92.01.002	MAN	81508049070	92.01.002	MAN
81508046089	92.01.001	MAN	81508049071	92.01.001	MAN
81508046090	92.01.002	MAN	81508049087	92.01.001	MAN
81508046091	91.02.013	MAN	81508049088	92.01.002	MAN
81508046092	91.02.014	MAN	15224836SR	93.07.001	MERITOR
81508046093	91.02.013	MAN	15224834SR	93.07.002	MERITOR
81508046094	91.02.014	MAN	31932082	93.04.005	MERITOR
81508046099	93.08.001	MAN	31932083	93.04.006	MERITOR
81508046100	93.08.002	MAN	68032206	93.02.013	MERITOR
81508046116	93.08.016	MAN	68032207	93.02.014	MERITOR
81508046117	93.08.015	MAN	68032397	93.04.009	MERITOR
81508046125	93.08.001	MAN	68032398	93.04.010	MERITOR
81508046126	93.08.002	MAN	68032883	93.05.009	MERITOR
81508046156	91.02.014	MAN	68032884	93.05.010	MERITOR
81508046157	91.02.013	MAN	68032917	93.05.009	MERITOR
81508046158	93.08.006	MAN	68032918	93.05.010	MERITOR
81508046159	93.08.005	MAN	68033077	93.06.009	MERITOR
81508046165	93.08.001	MAN	68033078	93.06.010	MERITOR
81508046166	93.08.002	MAN	68033109	93.06.013	MERITOR
81508046187	93.08.011	MAN	68033110	93.06.014	MERITOR
81508046188	93.08.012	MAN	68033158	93.06.003	MERITOR
81508046189	93.08.011	MAN	68033159	93.06.006	MERITOR
81508046190	93.08.012	MAN	68033214	93.06.005	MERITOR
81508046194	93.08.010	MAN	68033215	93.06.006	MERITOR

Calipers cross-reference list

OEM ref	TT reference	Brand	OEM ref	TT reference	Brand
68033321	93.02.023	MERITOR	68032829	93.08.006	MERITOR
68033322	93.02.024	MERITOR	68032830	93.08.013	MERITOR
68033327	93.02.011	MERITOR	68032831	93.08.014	MERITOR
68033328	93.02.012	MERITOR	68032846	93.09.004	MERITOR
68033353	93.08.023	MERITOR	68032847	93.09.003	MERITOR
68033354	93.08.024	MERITOR	68032856	93.08.001	MERITOR
68033363	93.06.019	MERITOR	68032857	93.08.002	MERITOR
68033364	93.06.020	MERITOR	68032858	93.06.017	MERITOR
68320913	93.02.005	MERITOR	68032859	93.06.018	MERITOR
68320914	93.02.006	MERITOR	68032860	93.06.007	MERITOR
68032174	93.04.007	MERITOR	68032861	93.06.008	MERITOR
68032175	93.04.008	MERITOR	68032901	93.09.003	MERITOR
68032176	93.04.011	MERITOR	68032902	93.09.004	MERITOR
68032177	93.04.012	MERITOR	68032903	93.09.003	MERITOR
68032204	93.02.001	MERITOR	68032904	93.09.004	MERITOR
68032205	93.02.002	MERITOR	68032905	93.09.003	MERITOR
68032270	93.02.001	MERITOR	68032906	93.09.004	MERITOR
68032271	93.02.002	MERITOR	68032910	93.09.004	MERITOR
68032272	93.02.013	MERITOR	68032911	93.09.003	MERITOR
68032273	93.02.014	MERITOR	68032912	93.09.004	MERITOR
68032346	93.04.001	MERITOR	68032921	93.05.007	MERITOR
68032347	93.04.002	MERITOR	68032922	93.05.008	MERITOR
68032348	93.04.001	MERITOR	68032959	93.06.017	MERITOR
68032349	93.04.002	MERITOR	68032960	93.06.018	MERITOR
68032358	93.08.001	MERITOR	68033044	93.09.003	MERITOR
68032359	93.08.002	MERITOR	68033045	93.09.004	MERITOR
68032381	93.05.005	MERITOR	68033046	93.08.025	MERITOR
68032382	93.05.006	MERITOR	68033047	93.08.026	MERITOR
68032401	93.02.007	MERITOR	68033073	93.06.017	MERITOR
68032404	93.02.008	MERITOR	68033074	93.06.018	MERITOR
68032413	93.08.005	MERITOR	68033075	93.06.007	MERITOR
68032414	93.08.006	MERITOR	68033076	93.06.008	MERITOR
68032523	93.08.001	MERITOR	68033089	93.09.001	MERITOR
68032524	93.08.002	MERITOR	68033090	93.09.002	MERITOR
68032529	93.08.001	MERITOR	68033109	93.06.005	MERITOR
68032530	93.08.002	MERITOR	68033110	93.06.006	MERITOR
68032565	93.04.007	MERITOR	68033116	93.06.017	MERITOR
68032566	93.04.008	MERITOR	68033117	93.06.018	MERITOR
68032567	93.04.011	MERITOR	68033118	93.06.017	MERITOR
68032568	93.04.012	MERITOR	68033119	93.06.018	MERITOR
68032578	93.08.015	MERITOR	68033120	93.06.007	MERITOR
68032579	93.08.016	MERITOR	68033121	93.06.008	MERITOR
68032582	93.06.017	MERITOR	68033122	93.06.009	MERITOR
68032583	93.06.018	MERITOR	68033123	93.06.010	MERITOR
68032584	93.06.007	MERITOR	68033182	93.08.019	MERITOR
68032585	93.06.008	MERITOR	68033183	93.08.020	MERITOR
68032618	93.08.008	MERITOR	68033216	93.06.006	MERITOR
68032619	93.08.007	MERITOR	68033217	93.06.005	MERITOR
68032621	93.08.003	MERITOR	68033231	93.08.003	MERITOR
68032622	93.08.004	MERITOR	68033232	93.08.004	MERITOR
68032640	93.08.001	MERITOR	68033233	93.06.013	MERITOR
68032641	93.08.002	MERITOR	68033234	93.06.014	MERITOR
68032656	93.08.001	MERITOR	68033247	93.08.029	MERITOR
68032657	93.08.002	MERITOR	68033248	93.08.030	MERITOR
68032658	93.08.005	MERITOR	68033280	93.09.006	MERITOR
68032659	93.08.006	MERITOR	68033991	93.06.006	MERITOR
68032724	93.08.001	MERITOR	68033992	93.06.005	MERITOR
68032725	93.08.002	MERITOR	68320494	93.04.001	MERITOR
68032776	93.08.003	MERITOR	68320495	93.04.002	MERITOR
68032792	93.08.001	MERITOR	68321450	93.05.005	MERITOR
68032793	93.08.002	MERITOR	68321451	93.05.006	MERITOR
68032794	93.08.015	MERITOR	68321614	93.08.015	MERITOR
68032795	93.08.016	MERITOR	68321615	93.08.016	MERITOR
68032796	93.08.005	MERITOR	68323007	93.08.003	MERITOR
68032797	93.08.006	MERITOR	68323009	93.08.003	MERITOR
68032814	93.08.011	MERITOR	68323010	93.08.011	MERITOR
68032815	93.08.012	MERITOR	68323713	93.09.012	MERITOR
68032820	93.08.003	MERITOR	68323714	93.09.002	MERITOR
68032821	93.08.004	MERITOR	DX175.37	93.07.007	MERITOR
68032822	93.08.011	MERITOR	DX175.38	93.07.008	MERITOR
68032823	93.08.012	MERITOR	DX195.51	93.07.001	MERITOR
68032824	93.08.009	MERITOR	DX195.52	93.07.002	MERITOR
68032825	93.08.010	MERITOR	LRG500	93.01.023	MERITOR
68032826	93.08.017	MERITOR	LRG501	93.01.024	MERITOR
68032827	93.08.018	MERITOR	LRG502	93.01.019	MERITOR
68032828	93.08.005	MERITOR	LRG503	93.01.020	MERITOR

Calipers cross-reference list

OEM ref	TT reference	Brand	OEM ref	TT reference	Brand
LRG504	93.01.001	MERITOR	LRG617	93.06.020	MERITOR
LRG505	93.01.002	MERITOR	LRG622	93.04.011	MERITOR
LRG506	93.01.003	MERITOR	LRG623	93.04.012	MERITOR
LRG507	93.01.004	MERITOR	LRG624	93.02.007	MERITOR
LRG510	93.01.007	MERITOR	LRG625	93.02.008	MERITOR
LRG511	93.01.008	MERITOR	LRG626	93.02.009	MERITOR
LRG516	93.01.011	MERITOR	LRG627	93.02.010	MERITOR
LRG517	93.01.012	MERITOR	LRG630	93.05.009	MERITOR
LRG518	93.01.013	MERITOR	LRG631	93.05.010	MERITOR
LRG519	93.01.014	MERITOR	LRG632	93.08.005	MERITOR
LRG520	93.01.015	MERITOR	LRG633	93.08.006	MERITOR
LRG521	93.01.016	MERITOR	LRG638	93.09.005	MERITOR
LRG522	93.03.001	MERITOR	LRG639	93.09.006	MERITOR
LRG523	93.03.002	MERITOR	LRG640	93.02.023	MERITOR
LRG524	93.04.001	MERITOR	LRG641	93.02.024	MERITOR
LRG525	93.04.002	MERITOR	LRG642	93.08.007	MERITOR
LRG526	93.04.003	MERITOR	LRG643	93.08.008	MERITOR
LRG527	93.04.004	MERITOR	LRG644	93.07.007	MERITOR
LRG528	93.04.005	MERITOR	LRG645	93.07.008	MERITOR
LRG529	93.04.006	MERITOR	LRG648	93.06.011	MERITOR
LRG532	93.04.007	MERITOR	LRG649	93.06.012	MERITOR
LRG533	93.04.008	MERITOR	LRG650	93.06.013	MERITOR
LRG536	93.06.017	MERITOR	LRG651	93.06.014	MERITOR
LRG537	93.06.018	MERITOR	LRG652	93.06.015	MERITOR
LRG542	93.08.013	MERITOR	LRG653	93.06.016	MERITOR
LRG543	93.08.014	MERITOR	LRG658	93.08.021	MERITOR
LRG544	93.09.001	MERITOR	LRG659	93.08.022	MERITOR
LRG545	93.09.002	MERITOR	LRG662	93.08.027	MERITOR
LRG546	93.09.007	MERITOR	LRG663	93.08.028	MERITOR
LRG547	93.09.008	MERITOR	LRG700	93.08.019	MERITOR
LRG548	93.05.001	MERITOR	LRG701	93.08.020	MERITOR
LRG549	93.05.002	MERITOR	LRG704	93.08.009	MERITOR
LRG550	93.05.003	MERITOR	LRG705	93.08.010	MERITOR
LRG551	93.05.004	MERITOR	LRG722	93.09.009	MERITOR
LRG552	93.06.003	MERITOR	LRG723	93.09.010	MERITOR
LRG554	93.05.005	MERITOR	LRG724	93.08.029	MERITOR
LRG555	93.05.006	MERITOR	LRG725	93.08.030	MERITOR
LRG560	93.06.005	MERITOR	MCK1278	93.06.017	MERITOR
LRG561	93.06.006	MERITOR	MCK1279	93.06.018	MERITOR
LRG562	93.04.009	MERITOR	MCK1280	93.06.007	MERITOR
LRG563	93.04.010	MERITOR	MCK1281	93.06.008	MERITOR
LRG566	93.01.017	MERITOR	MCK1286	93.06.009	MERITOR
LRG567	93.01.018	MERITOR	MCK1287	93.06.010	MERITOR
LRG570	93.08.001	MERITOR	11014064	91.03.018	NEOPLAN
LRG571	93.08.002	MERITOR	11014065	91.03.017	NEOPLAN
LRG572	93.08.023	MERITOR	11014147	91.03.051	NEOPLAN
LRG573	93.08.024	MERITOR	11014148	91.03.052	NEOPLAN
LRG574	93.08.015	MERITOR	11015479	91.03.017	NEOPLAN
LRG575	93.08.016	MERITOR	11015480	91.03.018	NEOPLAN
LRG580	93.09.003	MERITOR	11067687	91.03.023	NEOPLAN
LRG581	93.09.004	MERITOR	11067688	91.03.024	NEOPLAN
LRG582	93.08.025	MERITOR	14000552	91.03.039	NEOPLAN
LRG583	93.08.026	MERITOR	14000553	91.03.040	NEOPLAN
LRG586	93.08.017	MERITOR	82132140	92.04.003	NEOPLAN
LRG587	93.08.018	MERITOR	82132240	92.04.004	NEOPLAN
LRG588	93.08.003	MERITOR	82136000	91.03.039	NEOPLAN
LRG589	93.08.004	MERITOR	82136010	91.03.040	NEOPLAN
LRG590	93.08.011	MERITOR	501005859	91.03.017	NEOPLAN
LRG591	93.08.012	MERITOR	501005860	91.03.018	NEOPLAN
LRG592	93.05.007	MERITOR	309003300	91.03.003	RABA
LRG593	93.05.008	MERITOR	309013300	91.03.004	RABA
LRG596	93.06.007	MERITOR	309203300	91.03.003	RABA
LRG597	93.06.008	MERITOR	309213300	91.03.004	RABA
LRG598	93.06.009	MERITOR	309303300	91.03.003	RABA
LRG599	93.06.010	MERITOR	309313300	91.03.004	RABA
LRG600	93.02.015	MERITOR	309323300	91.03.003	RABA
LRG601	93.02.016	MERITOR	309333300	91.03.004	RABA
LRG602	93.02.011	MERITOR	309853300	91.03.003	RABA
LRG603	93.02.012	MERITOR	309863300	91.03.004	RABA
LRG608	93.02.013	MERITOR	309873300	91.03.003	RABA
LRG609	93.02.014	MERITOR	309883300	91.03.004	RABA
LRG610	93.02.001	MERITOR	309893300	91.03.003	RABA
LRG611	93.02.002	MERITOR	309903300	91.03.004	RABA
LRG614	93.02.005	MERITOR	309913000	91.03.003	RABA
LRG615	93.02.006	MERITOR	309923300	91.03.004	RABA
LRG616	93.06.019	MERITOR	311503300	91.03.003	RABA

Calipers cross-reference list

OEM ref	TT reference	Brand	OEM ref	TT reference	Brand
311513300	91.03.004	RABA	5010098110	93.01.014	RVI
311603300	91.03.003	RABA	5010197252	96.02.001	RVI
311613300	91.03.004	RABA	5010197253	96.02.002	RVI
311623300	91.03.003	RABA	5010207432	95.02.001	RVI
311633300	91.03.004	RABA	5010207433	95.02.002	RVI
311703300	91.03.003	RABA	5010207434	95.02.003	RVI
311713300	91.03.004	RABA	5010207435	95.02.004	RVI
311823300	91.03.003	RABA	5010216587	93.03.001	RVI
311833300	91.03.004	RABA	5010216588	93.03.002	RVI
311853300	91.03.003	RABA	5010216833	93.04.003	RVI
311863300	91.03.003	RABA	5010216834	93.04.004	RVI
672203400	91.03.003	RABA	5010260004	93.05.001	RVI
672303400	91.03.004	RABA	5010260005	93.05.002	RVI
672403400	91.03.003	RABA	5010260214	93.05.005	RVI
672413400	91.03.004	RABA	5010260215	93.05.006	RVI
700533100	91.03.042	RABA	5010260444	93.04.003	RVI
700543100	91.03.041	RABA	5010260445	93.04.004	RVI
700553100	91.03.041	RABA	5010393685	93.05.002	RVI
700563100	91.03.042	RABA	5010393686	93.05.001	RVI
700583100	91.03.041	RABA	5010422260	92.01.005	RVI
700593100	91.03.042	RABA	5010422261	92.01.006	RVI
700603100	91.03.041	RABA	5010422510	93.09.003	RVI
932213100	91.03.001	RABA	5010422511	93.09.004	RVI
932223100	91.03.002	RABA	5010422983	93.09.003	RVI
932233100	91.03.001	RABA	5010422984	93.09.004	RVI
932243100	91.03.002	RABA	5010422985	93.09.003	RVI
932323100	91.03.001	RABA	5010422986	93.09.004	RVI
932343100	91.03.002	RABA	5010422990	93.09.004	RVI
500184335	93.09.003	RVI	5010422991	93.09.003	RVI
500184336	93.09.004	RVI	5010525012	92.02.005	RVI
5000787728	96.02.001	RVI	5010525013	92.02.006	RVI
5000787729	96.02.002	RVI	5010525044	93.09.003	RVI
5000807463	96.01.001	RVI	5010525045	93.09.004	RVI
5000822338	93.03.001	RVI	5010525283	93.05.001	RVI
5000822339	93.03.001	RVI	5010525284	93.05.002	RVI
5000823338	93.04.003	RVI	5010525479	93.08.019	RVI
5000823339	93.04.004	RVI	5010525480	93.08.020	RVI
5001019356	93.08.021	RVI	5010525491	93.08.019	RVI
5001019357	93.08.022	RVI	5010525492	93.08.020	RVI
5001825775	96.01.003	RVI	B327059	96.01.001	RVI
5001825777	96.01.004	RVI	B327060	96.01.002	RVI
5001836663	93.08.019	RVI	308000520	91.03.003	SAF
5001836664	93.08.020	RVI	3080000400	91.03.003	SAF
5001837343	93.04.003	RVI	4050000500	91.03.003	SAF
5001837344	93.04.004	RVI	4080000520	91.03.003	SAF
5001845383	93.05.005	RVI	4080500600	91.03.003	SAF
5001845384	93.05.006	RVI	3080000402	91.03.004	SAF
5001851559	93.08.007	RVI	3080000421	91.03.004	SAF
5001851560	93.08.008	RVI	3080000502	91.03.003	SAF
5001852882	92.01.005	RVI	3080000521	91.03.003	SAF
5001852883	92.01.006	RVI	3080000623	91.02.020	SAF
5001854335	93.09.003	RVI	3080000723	91.02.019	SAF
5001854336	93.09.004	RVI	3080000800	94.02.002	SAF
5001854338	93.08.025	RVI	3080000801	94.02.002	SAF
5001854339	93.08.026	RVI	3080000802	94.02.002	SAF
5001854741	93.05.001	RVI	3080001022	91.03.002	SAF
5001854742	93.05.002	RVI	3080001122	91.03.001	SAF
5001856069	95.06.003	RVI	3080001202	91.03.048	SAF
5001856070	95.06.004	RVI	3080001302	91.03.047	SAF
5001856071	95.06.007	RVI	3080001801	92.02.002	SAF
5001856072	95.06.008	RVI	3080001901	92.02.001	SAF
5001858404	93.08.019	RVI	3080002420	91.02.020	SAF
5001858405	93.08.020	RVI	3080002520	91.02.019	SAF
5001864465	93.04.003	RVI	3080002620	91.03.002	SAF
5001864466	93.04.004	RVI	3080002720	91.03.001	SAF
5001864471	93.05.005	RVI	3080003020	91.03.004	SAF
5001864472	93.05.006	RVI	3080003120	91.03.003	SAF
5001864545	93.08.029	RVI	3080003820	91.02.020	SAF
5001864546	93.08.030	RVI	3080003920	91.02.019	SAF
5001865904	92.02.009	RVI	4080000400	91.03.004	SAF
5001865905	92.02.010	RVI	4080000500	91.03.003	SAF
5001867381	95.06.007	RVI	4080000600	91.02.020	SAF
5001867382	95.06.008	RVI	4080000700	91.02.019	SAF
5010098100	93.01.011	RVI	4080001000	91.03.002	SAF
5010098101	93.01.012	RVI	4080001100	91.03.001	SAF
5010098109	93.01.013	RVI	4080001200	91.03.048	SAF

Calipers cross-reference list

OEM ref	TT reference	Brand	OEM ref	TT reference	Brand
4080001300	91.03.047	SAF	3096766	93.06.009	VOLVO
571158	91.03.051	SCANIA	3096767	93.06.010	VOLVO
571159	91.03.052	SCANIA	6799231	93.01.001	VOLVO
571162	91.03.059	SCANIA	6799232	93.01.002	VOLVO
571163	91.03.060	SCANIA	6799235	93.02.001	VOLVO
571796	91.03.024	SCANIA	6799236	93.02.002	VOLVO
571797	91.03.023	SCANIA	6799239	93.01.019	VOLVO
571798	91.03.058	SCANIA	6799240	93.01.020	VOLVO
571799	91.03.057	SCANIA	8550875	93.05.007	VOLVO
1134898	91.03.051	SCANIA	8550876	93.05.008	VOLVO
1134899	91.03.052	SCANIA	9524029	93.05.007	VOLVO
1363748	91.03.018	SCANIA	9524030	93.05.008	VOLVO
1363749	91.03.017	SCANIA	20390670	93.06.007	VOLVO
1365719	91.03.023	SCANIA	20390671	93.06.008	VOLVO
1365720	91.03.024	SCANIA	20424070	93.06.009	VOLVO
1388610	91.03.055	SCANIA	20424071	93.06.010	VOLVO
1388611	91.03.056	SCANIA	20424072	93.06.017	VOLVO
1395178	91.03.059	SCANIA	20424073	93.06.018	VOLVO
1395179	91.03.060	SCANIA	20424074	93.06.007	VOLVO
1422033	91.03.023	SCANIA	20424075	93.06.008	VOLVO
1422034	91.03.024	SCANIA	20442328	93.06.005	VOLVO
1422035	91.03.057	SCANIA	20442329	93.06.006	VOLVO
1422036	91.03.058	SCANIA	20852527	93.06.009	VOLVO
1426662	91.03.051	SCANIA	20852528	93.06.010	VOLVO
1426663	91.03.052	SCANIA	70306886	93.05.007	VOLVO
1450416	91.03.055	SCANIA	70306887	93.05.008	VOLVO
1450417	91.03.056	SCANIA	85101082	93.06.007	VOLVO
1472419	91.03.024	SCANIA	85101083	93.06.008	VOLVO
1472420	91.03.023	SCANIA	85102227	93.05.007	VOLVO
1473364	91.03.017	SCANIA	85102228	93.05.008	VOLVO
1473365	91.03.018	SCANIA	85103302	93.06.011	VOLVO
1480809	91.03.058	SCANIA	85103303	93.06.012	VOLVO
1480810	91.03.057	SCANIA	85106925	93.06.009	VOLVO
1480811	91.03.056	SCANIA	85106926	93.06.010	VOLVO
1480812	91.03.055	SCANIA	85106927	93.06.007	VOLVO
1483309	91.03.052	SCANIA	85106928	93.06.008	VOLVO
1483310	91.03.051	SCANIA	85106929	93.06.017	VOLVO
1511581	91.03.068	SCANIA	85106930	93.06.018	VOLVO
1511582	91.03.067	SCANIA	85106931	93.06.005	VOLVO
1513592	91.03.016	SCANIA	85106932	93.06.006	VOLVO
1513593	91.03.015	SCANIA	40100001	92.04.001	WABCO
1139264F	91.03.001	SCANIA	40100002	92.04.002	WABCO
1137392	91.03.023	SCANIA	40100005	92.04.001	WABCO
1137393	91.03.024	SCANIA	40100006	92.04.002	WABCO
8285388529	93.04.005	SETRA	40175025	92.01.001	WABCO
8285388530	93.04.006	SETRA	40175026	92.01.002	WABCO
M069999	92.03.001	SMB	40175027	92.01.001	WABCO
M070008	92.03.002	SMB	40175028	92.01.002	WABCO
M076634	91.03.001	SMB	40175049	92.01.001	WABCO
M076642	91.03.002	SMB	40175050	92.01.002	WABCO
M078386	91.02.019	SMB	40175051	92.01.001	WABCO
M078394	91.02.020	SMB	40175052	92.01.002	WABCO
M20012401	91.03.002	SMB	40175070	92.01.007	WABCO
M20012402	91.03.001	SMB	40175071	92.01.008	WABCO
M20012411	91.03.002	SMB	40195009	92.02.005	WABCO
M20012412	91.03.001	SMB	40195010	92.02.006	WABCO
M20012421	91.03.002	SMB	40195041	92.02.009	WABCO
M20012422	91.03.001	SMB	40195042	92.02.010	WABCO
M20012441	91.03.002	SMB	40225003	92.03.001	WABCO
M20012442	91.03.001	SMB	40225004	92.03.002	WABCO
M20016401	91.03.002	SMB	40244001	92.07.001	WABCO
M20016402	91.03.001	SMB	40244002	92.07.002	WABCO
M20016431	91.03.002	SMB	640244001	92.07.001	WABCO
M20016432	91.03.001	SMB	640244002	92.07.002	WABCO
1697450	93.01.019	VOLVO	640175037	92.01.009	WABCO
1697451	93.01.020	VOLVO	640175038	92.01.010	WABCO
3091726	93.02.014	VOLVO	640175039	92.01.011	WABCO
3091728	93.02.002	VOLVO	640175040	92.01.012	WABCO
3090248	93.02.001	VOLVO	640175074	92.01.009	WABCO
3090249	93.02.002	VOLVO	640175075	92.01.010	WABCO
3091725	93.02.013	VOLVO	640175076	92.01.011	WABCO
3091727	93.02.001	VOLVO	640175077	92.01.012	WABCO
3095617	93.06.017	VOLVO	40 100 001	92.04.001	WABCO
3095618	93.06.018	VOLVO	40 100 002	92.04.002	WABCO
3095619	93.06.007	VOLVO	40 100 005	92.04.001	WABCO
3095620	93.06.008	VOLVO	40 100 006	92.04.002	WABCO

Calipers cross-reference list

OEM ref	TT reference	Brand
40 175 025	92.01.001	WABCO
40 175 026	92.01.002	WABCO
40 175 027	92.01.001	WABCO
40 175 028	92.01.002	WABCO
40 175 049	92.01.001	WABCO
40 175 050	92.01.002	WABCO
40 175 051	92.01.001	WABCO
40 175 052	92.01.002	WABCO
40 175 070	92.01.007	WABCO
40 175 071	92.01.008	WABCO
40 195 009	92.02.005	WABCO
40 195 010	92.02.006	WABCO
40 195 041	92.02.009	WABCO
40 195 042	92.02.010	WABCO
40 225 003	92.03.001	WABCO
40 225 004	92.03.002	WABCO
40 244 001	92.07.001	WABCO
40 244 002	92.07.002	WABCO
640 244 001	92.07.001	WABCO
640 244 002	92.07.002	WABCO
640 175 037	92.01.009	WABCO
640 175 038	92.01.010	WABCO
640 175 039	92.01.011	WABCO
640 175 040	92.01.012	WABCO
640 175 074	92.01.009	WABCO
640 175 075	92.01.010	WABCO
640 175 076	92.01.011	WABCO
640 175 077	92.01.012	WABCO
501005573	91.03.055	ZF
501005574	91.03.056	ZF
501005859	91.03.017	ZF
501005860	91.03.018	ZF
501005905	91.03.017	ZF
501005906	91.03.018	ZF
501006007	91.03.053	ZF
501006008	91.03.054	ZF
501006016	91.03.017	ZF
501006017	91.03.018	ZF
501006195	91.03.051	ZF
501006196	91.03.052	ZF
501006296	91.03.023	ZF
501006297	91.03.024	ZF
501006320	91.03.013	ZF
501006321	91.03.014	ZF
501006513	93.08.007	ZF
501006514	93.08.008	ZF
501006591	91.03.051	ZF
501006592	91.03.052	ZF
501006597	91.03.051	ZF
501006598	91.03.052	ZF
501006599	91.03.053	ZF
501006600	91.03.054	ZF
501006850	91.03.053	ZF
501006851	91.03.054	ZF
501007152	91.03.017	ZF
501007153	91.03.018	ZF
501007172	91.03.053	ZF
501007173	91.03.054	ZF
501007244	91.03.024	ZF
501007361	91.03.051	ZF
501007362	91.03.052	ZF
501007462	91.03.017	ZF
501003935	93.04.005	ZF
501003936	93.04.006	ZF
A6664300090	91.03.023	ZF
A6664300190	91.03.024	ZF

LIGHT COMMERCIAL VEHICLES



DAIMLER CHRYSLER MERCEDES

PAGE

22



IVECO

29



NISSAN

38



RVI

39



DAIMLER - CHRYSLER - MERCEDES LCV

Models



308

309



Maker

BREMBO

FRONT

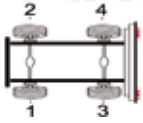

Calipers

Brembo part n°	TT n°	Side
120.7301.50	95.08.001	1
120.7301.60	95.08.002	2

Repair kits

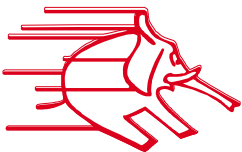

NO PICTURE AVAILABLE

TT KIT n°	U.D.
Maker	BREMBO
OR kit n°	120.5468.10
Description	Seal & ring
Application	120.7301.50 120.7301.60

DAIMLER - CHRYSLER - MERCEDES LCV

Models



VARIO 512D, 514D, 612D, 614D

From 07.1996



Maker	MERITOR
Wheel size	16 " (FRONT)

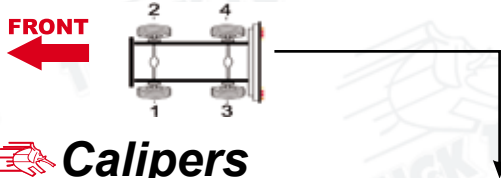

Calipers

N°	Meritor part n°	TT n°	Side
1	LRG510	93.01.007	1
1	LRG511	93.01.008	2
2	LRG624	93.02.007	3
2	LRG625	93.02.008	4



Maker	MERITOR
Wheel size	16 " (REAR)

Repair kits

	TT KIT n°	CMSK.16.1
	Maker	MERITOR
	OR kit n°	SP8597
	Description	Dirt excluder dust cover
	Application	All these calipers

	TT KIT n°	CMSK.17
	Maker	MERITOR
	OR kit n°	SJ1035
	Description	Guide pin
	Application	All these calipers

	TT KIT n°	U.D
	Maker	MERITOR
	OR kit n°	SP8566
	Description	Cover
	Application	All these calipers

	TT KIT n°	U.D
	Maker	MERITOR
	OR kit n°	SP8902
	Description	Guide pin
	Application	All these calipers

DAIMLER - CHRYSLER - MERCEDES LCV

Models



**VARIO 609D, 709D, 711D,
809DA, 809D**

04.86 - 12.96



Maker	MERITOR
Wheel size	16 "

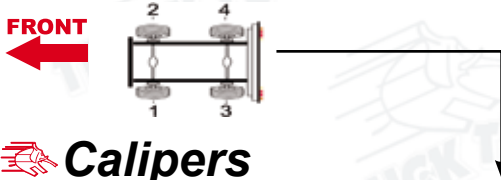

Calipers

MERITOR part n°	TT n°	Side
LRG510	93.01.007	1
LRG511	93.01.008	2

Repair kits

	TT KIT n°	CMSK.16.1
	Maker	MERITOR
	OR kit n°	SP8597
	Description	Dirt excluder dust cover
	Application	LRG510 LRG511

	TT KIT n°	CMSK.17
	Maker	MERITOR
	OR kit n°	SJ1035
	Description	Guide pin
	Application	LRG510 LRG511

DAIMLER - CHRYSLER - MERCEDES LCV

Models



Sprinter (4,61) Dual tyres

2 pistons brake

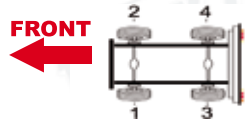

Calipers

Wabco part n°	TT n°	Side
40 244 009	92.07.001	1
40 244 010	92.07.002	2
40 244 017	92.07.003	3
40 244 018	92.07.004	4

Maker	WABCO
Models	Caliper type
408D	244 V-0
410D	244 V-0
412D	244 V-0
414	244 V-0
512D (Vario)	244 V-0

Repair kits

 NO PICTURE AVAILABLE	TT KIT n°	U.D.
	Maker	WABCO
	OR kit n°	12.999.543
	Description	Guide pin, caps
Application	All these calipers	

 NO PICTURE AVAILABLE	TT KIT n°	U.D.
	Maker	WABCO
	OR kit n°	12.999.719
	Description	Gaiters, seals (left)
Application	41 244 009 41 244 010	

 NO PICTURE AVAILABLE	TT KIT n°	U.D.
	Maker	WABCO
	OR kit n°	12.999.720
	Description	Gaiters, seals (right)
Application	41 244 009 41 244 010	

 NO PICTURE AVAILABLE	TT KIT n°	U.D.
	Maker	WABCO
	OR kit n°	12.999.765
	Description	Gaiters, seals (left)
Application	40 244 017 40 244 018	

 NO PICTURE AVAILABLE	TT KIT n°	U.D.
	Maker	WABCO
	OR kit n°	127.999.766
	Description	Gaiters, seals (right)
Application	40 244 017 40 244 018	

DAIMLER - CHRYSLER - MERCEDES LCV

Models



Sprinter 200-300

From 02. 1995



Maker

BOSCH

FRONT

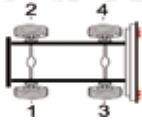

Calipers

Bosch part n°	TT n°	Side
0.204.102.918	96.05.001	1
0.204.102.919	96.05.002	2

Repair kits

	TT KIT n°	CBOSK.1
	Maker	BOSCH
	OR kit n°	-
	Description	seals
	Application	All these calipers

	TT KIT n°	CBOSK.1.P
	Maker	BOSCH
	OR kit n°	-
	Description	Pistons
	Application	All these calipers

	TT KIT n°	CBOSK.2
	Maker	BOSCH
	OR kit n°	-
	Description	Guides & seals
	Application	All these calipers

DAIMLER - CHRYSLER - MERCEDES LCV

Models



SPRINTER 616

From 2002



Maker

MERITOR

FRONT

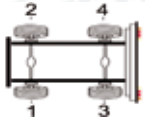

Calipers

Meritor part n°	TT n°	Side
LRG640	93.02.023	3
LRG641	93.02.024	4

DAIMLER - CHRYSLER - MERCEDES LCV

Models



VAN 207 D to 210
(T1 Series)
(4 x 44 mm Ø pistons)

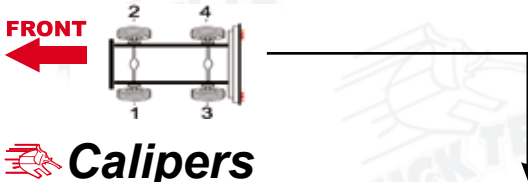
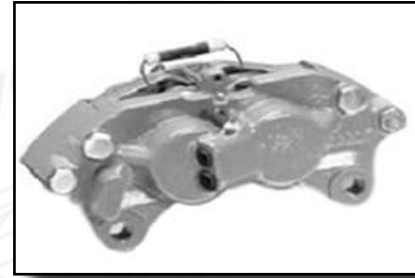

Calipers

Wabco part n°	TT n°	Side
40 444 183	92.08.003	1
40 444 184	92.08.004	2

Maker	WABCO
Models	Caliper type
207D	444 F-0
208	444 F-0
208D	444 F-0
209D	444 F-0
210	444 F-0
210D	444 F-0
307D	444 F-0
308	444 F-0
308D	444 F-0
309D	444 F-0
310	444 F-0
310D	444 F-0

Repair kits

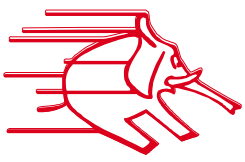
 NO PICTURE AVAILABLE	TT KIT n°	U.D.
	Maker	WABCO
	OR kit n°	12.999.197
	Description	Seals, gaiters
	Application	-

DAIMLER - CHRYSLER - MERCEDES LCV

Models



VAN 307D to 310
(4 x 44 mm Ø pistons)

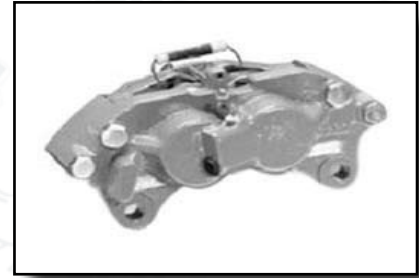

DAIMLER - CHRYSLER - MERCEDES

General catalogue LCV

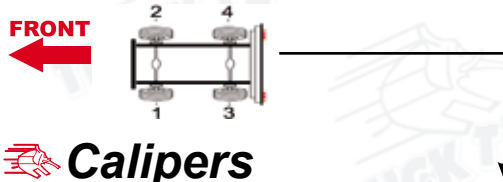

Calipers

Wabco part n°	TT n°	Side
40 444 149	92.08.001	1
40 444 150	92.08.002	2

Maker	WABCO
Models	Caliper type
207D	444 F-0
208	444 F-0
208D	444 F-0
209D	444 F-0
210	444 F-0
210D	444 F-0
307D	444 F-0
308	444 F-0
308D	444 F-0
309D	444 F-0
310	444 F-0
310D	444 F-0

Repair kits

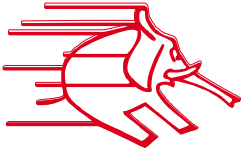
 NO PICTURE AVAILABLE	TT KIT n°	U.D.
	Maker	WABCO
	OR kit n°	12.999.197
	Description	Seals, gaiters
	Application	All these calipers

DAIMLER - CHRYSLER - MERCEDES LCV

Models



VARIO 809D, 811D, 814D

04.1986 - 12.96



Maker	MERITOR
Wheel size	17.5 "

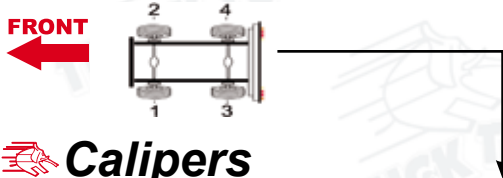

Calipers

MERITOR part n°	TT n°	Side
LRG520	93.01.015	1
LRG521	93.01.016	2

Repair kits

	TT KIT n°	CMSK.16.1
	Maker	MERITOR
	OR kit n°	SP8597
	Description	Dirt excluder dust cover
	Application	LRG510 LRG511

	TT KIT n°	CMSK.17
	Maker	MERITOR
	OR kit n°	SJ1035
	Description	Guide pin
	Application	LRG510 LRG511

DAIMLER - CHRYSLER - MERCEDES LCV

Models



VARIO 812D, 814D, 815D
From 07.1996



Maker	MERITOR
Wheel size	17.5 " (FRONT)

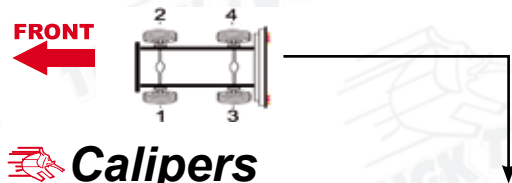

Maker	MERITOR
Wheel size	17.5 " (REAR)

	MERITOR part n°	TT n°	Side
1	LRG520	93.01.015	1
1	LRG521	93.01.016	2
2	LRG626	93.02.009	3
2	LRG627	93.02.010	4

Repair kits

TT KIT n°	CMSK.16.1
Maker	MERITOR
OR kit n°	SP8597
Description	Dirt excluder dust cover
Application	-

TT KIT n°	CMSK.17
Maker	MERITOR
OR kit n°	SJ1035
Description	Guide pin
Application	-

TT KIT n°	CMSK.17.1
Maker	MERITOR
OR kit n°	-
Description	Piston
Application	LRG626 LRG627

TT KIT n°	CMSK.17.2
Maker	MERITOR
OR kit n°	-
Description	Piston
Application	LRG626 LRG627

Models



DAILY II 30.8

To 05.1996

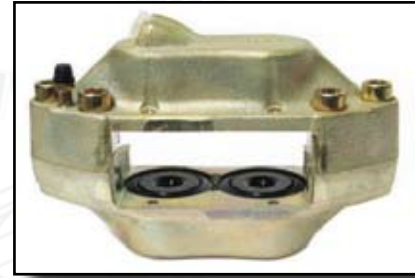

Maker

BREMBO

FRONT

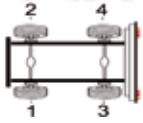

Calipers

Brembo part n°	TT n°	Side
320.4910.84	95.04.003	1
320.4910.85	95.04.004	2

Models



DAILY II 35.10 From 06.1996
 DAILY II 35.12 From 06.1996
 DAILY II 35.8 From 06.1996
 DAILY II 49.12 From 06.1996
 DAILY III 35 From 06.1999
 DAILY III 50 From 06.1999

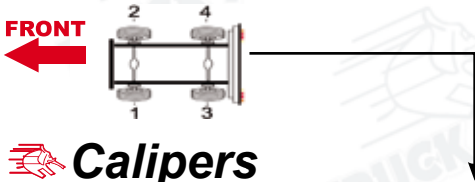

Calipers

N°	Brembo part n°	TT n°	Side
1	122.7773.28	95.06.001	1
1	122.7773.29	95.06.002	2
2	122.7775.28	95.06.005	3
2	122.7775.29	95.06.006	4



Maker	BREMBO
Position	FRONT



Maker	BREMBO
Position	REAR

Models



DAILY III 29L10

From 06.1999

DAILY III 35S9-S11

From 06.1999

DAILY III 35S9 -S13

From 06.1999

DAILY III 35S9-S15

From 06.1999

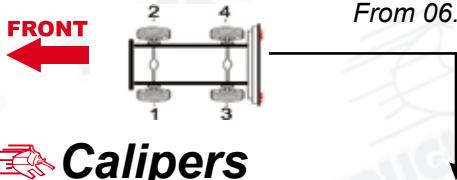

Calipers

N°	Brembo part n°	TT n°	Side
1	122.7220.03	95.05.001	1
1	122.7220.04	95.05.002	2
2	122.7270.28	95.08.005	3
2	122.7270.29	95.08.006	4

1.



Maker	BREMBO
Position	FRONT

2.



Maker	BREMBO
Position	REAR

Models



DAILY III 65C11

From 2000

DAILY III 65C13

From 2000

DAILY III 65C15

From 2000

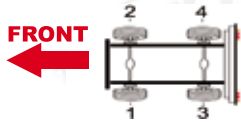

Calipers

N°	Brembo part n°	TT n°	Side
1	122.7301.28	95.08.001	1
1	122.7301.29	95.08.002	2
2	122.7306.28	95.07.001	3
2	122.7306.29	95.07.002	4

1.



Maker	BREMBO
Position	FRONT

2.



Maker	BREMBO
Position	REAR

Models



DAILY/GRINTA 35.10

From 1978 to 05.1996

DAILY/GRINTA 35.8

From 1978 to 05.1996

DAILY/GRINTA 40.10

From 1978 to 05.1996

DAILY/GRINTA 40.8

From 1978 to 05.1996

DAILY/GRINTA 49.10

From 1978 to 05.1996

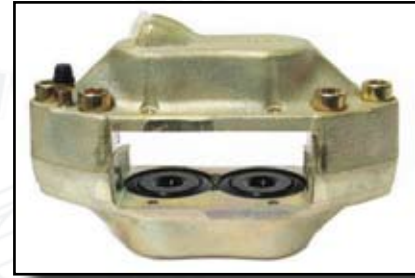

Maker

BREMBO

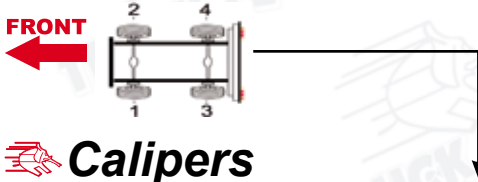

Calipers

Brembo part n°	TT n°	Side
320.4910.82	95.04.001	1
320.4910.83	95.04.002	2

Models



DAILY /GRINTA.30.10

From 06.1996

DAILY /GRINTA.30.8

From 1990 To 05.1996

DAILY /GRINTA.30.9

From 1990 To 05.1996



Maker

BREMBO

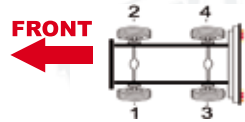

Calipers

Brembo part n°	TT n°	Side
320.4910.84	95.04.003	1
320.4910.85	95.04.004	2

Models



DAILY VAN

Type 35-10 to 49-12
(TurboBasic and Classic)

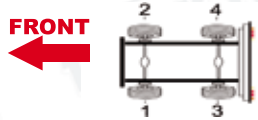

Calipers

Wabco part n°	TT n°	Side
40 444 224	92.08.007	1
40 444 223	92.08.008	2

Maker	WABCO
-------	-------

Models	Caliper type
35-10T	444 F-0
35-12T	444 F-0
40-10TW	444 F-0
49-10T	444 F-0
49-12T	444 F-0

Repair kits

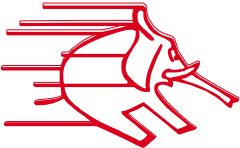
 NO PICTURE AVAILABLE	TT KIT n°	U.D.
	Maker	WABCO
	OR kit n°	12.999.197
	Description	Gaiters, seals
	Application	All these calipers

Models



DAILY VAN

Type 59-12
(Turbo Intercooler)

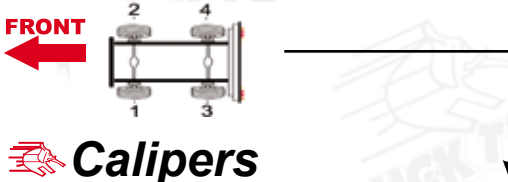

Calipers

Wabco part n°	TT n°	Side
40 450 014	92.08.009	1
40 450 013	92.08.010	2

Maker	WABCO
Models	Caliper type
59-12 T	450 F-0

Repair kits

<p>NO PICTURE AVAILABLE</p>	TT KIT n°	U.D.
	Maker	WABCO
	OR kit n°	12.999.199
	Description	Gaiters, seals
	Application	All these calipers

Models



TURBODAILY 35.12

From 1978 to 05.1996

TURBODAILY 40.12

From 1978 to 05.1996

TURBODAILY 45.10

From 1978 to 05.1996

TURBODAILY 49.10

From 1978 to 05.1996



Maker

BREMBO

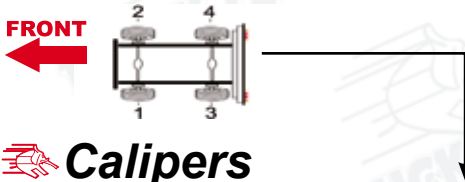

Calipers

Brembo part n°	TT n°	Side
120.5150.11	95.04.005	1
120.5150.21	95.04.006	2

Repair kits

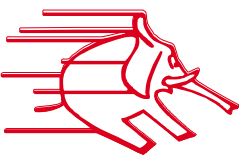
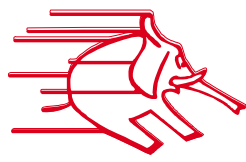
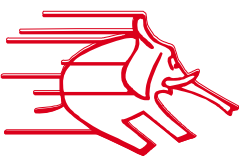
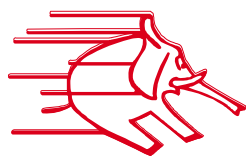
 NO PICTURE AVAILABLE	TT KIT n°	U.D.	 NO PICTURE AVAILABLE	TT KIT n°	U.D.
	Maker	BREMBO		Maker	BREMBO
	OR kit n°	120.3203.19		OR kit n°	120.4909.20
	Description	Boot & Seal		Description	Piston
	Application	-		Application	-
 NO PICTURE AVAILABLE	TT KIT n°	U.D.	 NO PICTURE AVAILABLE	TT KIT n°	U.D.
	Maker	BREMBO		Maker	BREMBO
	OR kit n°	120.5158.10		OR kit n°	122.4839.70
	Description	Spring		Description	Guide
	Application	-		Application	-

Models



EBRO L60

From 01.1992

EBRO L80

From 01.1992

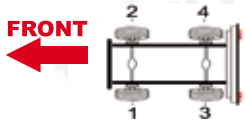

Calipers

N°	Brembo part n°	TT n°	Side
1	LRG512	93.01.009	1
1	LRG513	93.01.010	2
2	LRG603	93.01.012	3
2	LRG602	93.01.011	4

1.



Maker	MERITOR
Wheel size	17.5"(FRONT)

2.

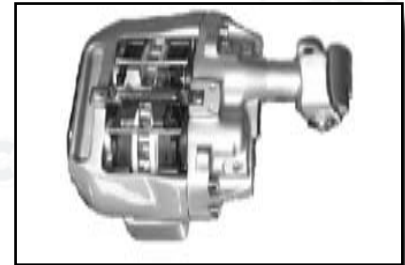

Maker	MERITOR
Wheel size	17.5"(REAR)

Repair kits

 NO PICTURE AVAILABLE	TT KIT n°	U.D.
	Maker	MERITOR
	OR kit n°	SJ1048
	Description	Overhaul seal
	Application	LRG512 LRG513

 NO PICTURE AVAILABLE	TT KIT n°	U.D.
	Maker	MERITOR
	OR kit n°	SJ1092
	Description	Auto adjuster
	Application	LRG602 LRG603

 NO PICTURE AVAILABLE	TT KIT n°	U.D.
	Maker	MERITOR
	OR kit n°	SP8565
	Description	Guide Pin
	Application	All these calipers

 NO PICTURE AVAILABLE	TT KIT n°	U.D.
	Maker	MERITOR
	OR kit n°	SP8566
	Description	Cover
	Application	All these calipers

 NO PICTURE AVAILABLE	TT KIT n°	U.D.
	Maker	MERITOR
	OR kit n°	SP8570
	Description	Hand Brake
	Application	LRG602 LRG603

 NO PICTURE AVAILABLE	TT KIT n°	U.D.
	Maker	MERITOR
	OR kit n°	SP9670
	Description	Overhaul seal
	Application	LRG602 LRG603

Models



MASCOTT 35
44 mm PISTON
MASCOTT 50
44 mm PISTON

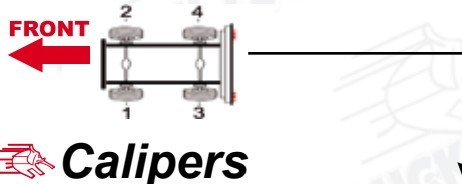

Calipers

N°	Brembo part n°	TT n°	Side
1	122.7773.05	95.06.003	1
1	122.7773.06	95.06.004	2
2	122.7775.73	95.06.007	3
2	122.7775.83	95.06.008	4

Repair kits

<p>NO PICTURE AVAILABLE</p>	TT KIT n°	U.D.
	Maker	BREMBO
	OR kit n°	120.5000.21
	Description	Guide
	Application	122 7773 05 122 7773 06

1.



Maker	BREMBO
Position	FRONT

2.



Maker	BREMBO
Position	REAR

Models



MASCOTT 50
52 mm PISTON
MASCOTT 60
52 mm PISTON

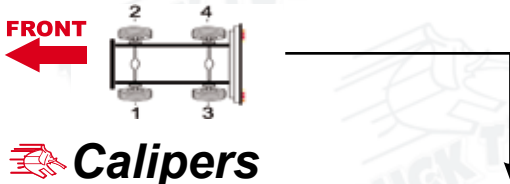

Calipers

N°	Brembo part n°	TT n°	Side
1	122.7301.13	95.08.003	1
1	122.7301.23	95.08.004	2
2	122.7306.01	95.07.001	3
2	122.7306.02	95.07.002	4

Repair kits

 NO PICTURE AVAILABLE	TT KIT n°	U.D.
	Maker	BREMBO
	OR kit n°	120.3203.57
	Description	Boot & Seal
	Application	122 7301 13 122 7301 23

 NO PICTURE AVAILABLE	TT KIT n°	U.D.
	Maker	BREMBO
	OR kit n°	122.5000.23
	Description	Guide
	Application	122 7301 13 122 7301 23

 NO PICTURE AVAILABLE	TT KIT n°	U.D.
	Maker	BREMBO
	OR kit n°	122.7305.10
	Description	Piston
	Application	122 7301 13 122 7301 23

 NO PICTURE AVAILABLE	TT KIT n°	U.D.
	Maker	BREMBO
	OR kit n°	120.7308.10
	Description	Piston
	Application	122 7306 01 122 7306 02

 NO PICTURE AVAILABLE	TT KIT n°	U.D.
	Maker	MERITOR
	OR kit n°	127.6689.10
	Description	Adjuster
	Application	122 7306 01 122 7306 02

 NO PICTURE AVAILABLE	TT KIT n°	U.D.
	Maker	MERITOR
	OR kit n°	127.6690.10
	Description	Boot
	Application	122 7306 01 122 7306 02

1.



Maker	BREMBO
Position	FRONT

2.



Maker	BREMBO
Position	REAR

 **Models**



B70
B80
B90
B120

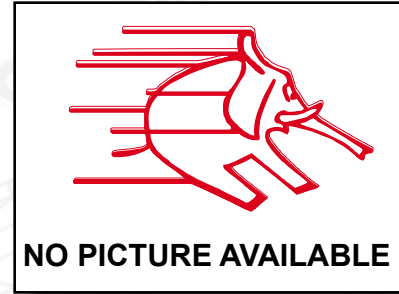

Maker **PONT A MOUSSON**

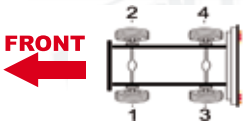

 **Calipers**

Pont A Mousson part n°	TT n°	Side
B.327059	96.01.001	1
B.327060	96.01.002	2

HEAVY DUTY VEHICLES

BOVA	46
BPW	47
CZEPEL	48
DAF LEYLAND	49
DAIMLER - CHRYSLER - MERCEDES	55
DENNIS	65
EVO BUS	71
FORD	79
GIGANT SAE	81
IKARUS	82
IRISBUS	83
IVECO	89
KAROSA	100
KASSBOHRER	101
LECINENA	102
MAN	103
MCI	117
NEOPLAN	118
NISSAN	129
ORION IND	130
RABA	131
ROR	132
RVI	135
SAE	150
SAF	151
SCANIA	154
SMB	159
VAN HOOL	162
VOLVO	166

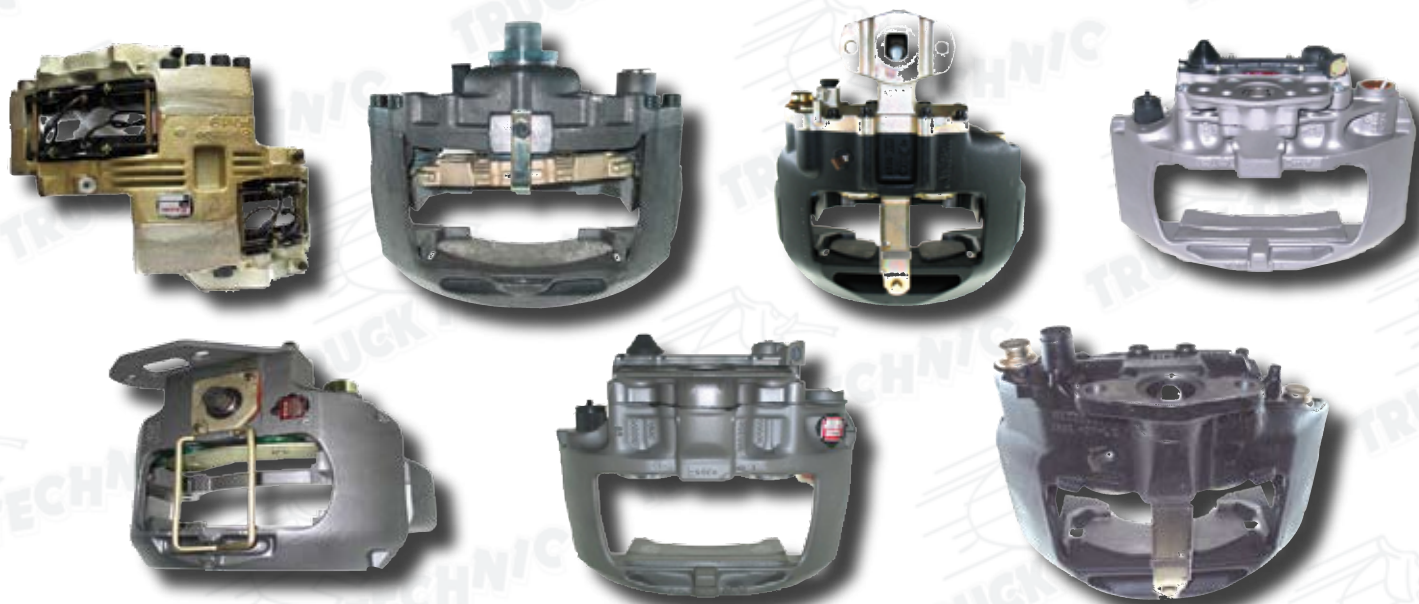

Models



- FHD10** From 11.1992
- FHD12** From 11.1992
- FHD13** From 11.1992
- FHD14** From 01.1994
- FHD15** From 01.1994
- FLD12** From 11.1992
- FLD14** From 01.1997
- FLD15** From 01.1997



Calipers





	TT KIT ref.	WSSK.20.19
	OR kit n°	LL310240062
	Description	Wear Sensor

Maker	KNORR
Wheel size	22.5"
Angle of actuator	0°
Brake type	Axial
Wear sensor	In pad , normally open

Knorr type n°	TT n°	Side	Knorr part n°	Knorr rationalised n°
SB7698	91.03.004	1-3-5	II34604	SN7409
SB7688	91.03.003	2-4-6	II34603	SN7419

Repair kits

MORE KITS : Page 192

	<table border="1"> <tr><td>TT KIT n°</td><td>CKSK.1</td></tr> <tr><td>Maker</td><td>KNORR</td></tr> <tr><td>OR kit n°</td><td>II328090062</td></tr> <tr><td>Description</td><td>Guides & Seals</td></tr> <tr><td>Application</td><td>All SB...</td></tr> </table>	TT KIT n°	CKSK.1	Maker	KNORR	OR kit n°	II328090062	Description	Guides & Seals	Application	All SB...		<table border="1"> <tr><td>TT KIT n°</td><td>CKSK.4 /4.2</td></tr> <tr><td>Maker</td><td>KNORR</td></tr> <tr><td>OR kit n°</td><td>K000944 / K001300</td></tr> <tr><td>Description</td><td>Tappets</td></tr> <tr><td>Application</td><td>All SB... AIISN/NA/SK</td></tr> </table>	TT KIT n°	CKSK.4 /4.2	Maker	KNORR	OR kit n°	K000944 / K001300	Description	Tappets	Application	All SB... AIISN/NA/SK
TT KIT n°	CKSK.1																						
Maker	KNORR																						
OR kit n°	II328090062																						
Description	Guides & Seals																						
Application	All SB...																						
TT KIT n°	CKSK.4 /4.2																						
Maker	KNORR																						
OR kit n°	K000944 / K001300																						
Description	Tappets																						
Application	All SB... AIISN/NA/SK																						
	<table border="1"> <tr><td>TT KIT n°</td><td>CKSK.6</td></tr> <tr><td>Maker</td><td>KNORR</td></tr> <tr><td>OR kit n°</td><td>K001532</td></tr> <tr><td>Description</td><td>Guides & Seals (New)</td></tr> <tr><td>Application</td><td>All SB...</td></tr> </table>	TT KIT n°	CKSK.6	Maker	KNORR	OR kit n°	K001532	Description	Guides & Seals (New)	Application	All SB...		<table border="1"> <tr><td>TT KIT n°</td><td>CKSK.8</td></tr> <tr><td>Maker</td><td>KNORR</td></tr> <tr><td>OR kit n°</td><td>-</td></tr> <tr><td>Description</td><td>Complete overhaul</td></tr> <tr><td>Application</td><td>All SB... All SN...</td></tr> </table>	TT KIT n°	CKSK.8	Maker	KNORR	OR kit n°	-	Description	Complete overhaul	Application	All SB... All SN...
TT KIT n°	CKSK.6																						
Maker	KNORR																						
OR kit n°	K001532																						
Description	Guides & Seals (New)																						
Application	All SB...																						
TT KIT n°	CKSK.8																						
Maker	KNORR																						
OR kit n°	-																						
Description	Complete overhaul																						
Application	All SB... All SN...																						
	<table border="1"> <tr><td>TT KIT n°</td><td>CKSK.8.1</td></tr> <tr><td>Maker</td><td>KNORR</td></tr> <tr><td>OR kit n°</td><td>-</td></tr> <tr><td>Description</td><td>Guides & Seals</td></tr> <tr><td>Application</td><td>All SB... All SN...</td></tr> </table>	TT KIT n°	CKSK.8.1	Maker	KNORR	OR kit n°	-	Description	Guides & Seals	Application	All SB... All SN...		<table border="1"> <tr><td>TT KIT n°</td><td>CKSK.16/16.1</td></tr> <tr><td>Maker</td><td>KNORR</td></tr> <tr><td>OR kit n°</td><td>Only TT</td></tr> <tr><td>Description</td><td>Alu / Plastic cover</td></tr> <tr><td>Application</td><td>All SB... All SN...</td></tr> </table>	TT KIT n°	CKSK.16/16.1	Maker	KNORR	OR kit n°	Only TT	Description	Alu / Plastic cover	Application	All SB... All SN...
TT KIT n°	CKSK.8.1																						
Maker	KNORR																						
OR kit n°	-																						
Description	Guides & Seals																						
Application	All SB... All SN...																						
TT KIT n°	CKSK.16/16.1																						
Maker	KNORR																						
OR kit n°	Only TT																						
Description	Alu / Plastic cover																						
Application	All SB... All SN...																						
	<table border="1"> <tr><td>TT KIT n°</td><td>CKSK.10.3/10.4</td></tr> <tr><td>Maker</td><td>KNORR</td></tr> <tr><td>OR kit n°</td><td>-</td></tr> <tr><td>Description</td><td>Adjusting Mechanism</td></tr> <tr><td>Application</td><td>All SB... All SN...</td></tr> </table>	TT KIT n°	CKSK.10.3/10.4	Maker	KNORR	OR kit n°	-	Description	Adjusting Mechanism	Application	All SB... All SN...		<table border="1"> <tr><td>TT KIT n°</td><td>CKSK.3.2</td></tr> <tr><td>Maker</td><td>KNORR</td></tr> <tr><td>OR kit n°</td><td>K000472</td></tr> <tr><td>Description</td><td>Guide & Seals</td></tr> <tr><td>Application</td><td>All SN...</td></tr> </table>	TT KIT n°	CKSK.3.2	Maker	KNORR	OR kit n°	K000472	Description	Guide & Seals	Application	All SN...
TT KIT n°	CKSK.10.3/10.4																						
Maker	KNORR																						
OR kit n°	-																						
Description	Adjusting Mechanism																						
Application	All SB... All SN...																						
TT KIT n°	CKSK.3.2																						
Maker	KNORR																						
OR kit n°	K000472																						
Description	Guide & Seals																						
Application	All SN...																						

Models



∅ 19.5", (+15° head of caliper)

From 1998

∅ 19.5", (+5° head of caliper)

From 01.1991

∅ 22.5", (0° head of caliper)

From 2000

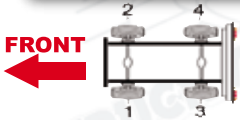

Calipers

	TT KIT n°	WSSK.20.28
	OR kit n°	Z0008241
	Description	Wear Sensor

Maker	KNORR
Brake type	Axial

Knorr type n°	TT n°	Side	Knorr part n°	Knorr rationalised n°
SB6548 (19.5"/+ 5 °)	91.02.001	1	II39266	SN6563
SB6558 (19.5"/+ 5 °)	91.02.002	2	II39267	SN6573
SB6582 (19.5"/+ 15 °)	91.02.003	1	K000584	SB6401
SB6592 (19.5"/+ 15 °)	91.02.004	2	K000585	SB6411
SB7900 (22.5"/+ 0 °)	91.03.003	1	K000136	SN7196
SB7910 (22.5"/+ 0 °)	91.03.004	2	K000137	SN7186

Repair kits

MORE KITS : Page 192

<p>145mm 34x80mm 150mm 85mm</p>	TT KIT n°	CKSK.1		TT KIT n°	CKSK.4 / 4.2
	Maker	KNORR		Maker	KNORR
	OR kit n°	II328090062		OR kit n°	K000944 / K001300
	Description	Guides & Seals		Description	Tappets
Application	All SB...		Application	All SB... All SN/NA/SK	
<p>114mm 85mm 32x80mm 80mm</p>	TT KIT n°	CKSK.6		TT KIT n°	CKSK.8
	Maker	KNORR		Maker	KNORR
	OR kit n°	K001532		OR kit n°	-
	Description	Guides & Seals (New)		Description	Complete overhaul
Application	All SB...		Application	All SB... All SN...	
<p>32x80mm 80mm 114mm 85mm</p>	TT KIT n°	CKSK.8.1		TT KIT n°	CKSK.16/16.1
	Maker	KNORR		Maker	KNORR
	OR kit n°	-		OR kit n°	Only TT
	Description	Guides & Seals		Description	Alu / Plastic cover
Application	All SB... All SN...		Application	All SB... All SN...	
	TT KIT n°	CKSK.10.3/10.4	<p>114mm 85mm 32x80mm 80mm</p>	TT KIT n°	CKSK.3.2
	Maker	KNORR		Maker	KNORR
	OR kit n°	-		OR kit n°	K000472
	Description	Adjusting Mechanism		Description	Guide & Seals
Application	All SB... All SN...		Application	All SN...	

Models



RABA AXLE

From 1993



Maker	MERITOR
Wheel size	22.5"

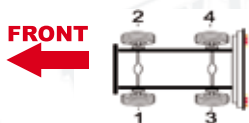

Calipers

Meritor part n°	TT n°	Side
LRG562	93.04.009	1
LRG563	93.04.010	2

Repair kits

MORE KITS : [Page 214](#)

	TT KIT n°	CMSK.1
	Maker	MERITOR
	OR kit n°	SJ4001
	Description	Guides & Seals
	Application	LRG562 / LRG563

	TT KIT n°	CMSK.6
	Maker	MERITOR
	OR kit n°	SJ1212
	Description	Cover & Boots
	Application	LRG562 / LRG563

	TT KIT n°	CMSK.24.3/25.3
	Maker	MERITOR
	OR kit n°	-
	Description	Clutch mechanism
	Application	LRG562 / LRG563

	TT KIT n°	CMSK.24.4/25.4
	Maker	MERITOR
	OR kit n°	-
	Description	Adjuster tappet
	Application	LRG562 / LRG563

	TT KIT n°	CMSK.28/29
	Maker	MERITOR
	OR kit n°	-
	Description	Shaft
	Application	LRG562 / LRG563

	TT KIT n°	CMSK.24.1/25.1
	Maker	MERITOR
	OR kit n°	-
	Description	Support - spiral
	Application	LRG562 / LRG563

	TT KIT n°	CMSK.24.2
	Maker	MERITOR
	OR kit n°	-
	Description	Roller
	Application	LRG562 / LRG563

	TT KIT n°	CMSK.24.7
	Maker	MERITOR
	OR kit n°	-
	Description	Shaft Roller Bearing
	Application	LRG562 / LRG563

Models



SB 120



FRONT

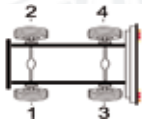

	TT KIT ref.	WSSK.20.15
	OR kit n°	1903651
	Description	Wear Sensor

Maker	KNORR
Wheel size	19.5"
Angle of actuator	+ 5°
Brake type	Axial
Wear sensor	In pad , normally closed

Calipers

Knorr type n°	TT n°	Side	Knorr part n°	Knorr rationalised n°
SB6556	91.02.002	1 - 4	II39252	SN6555
SB6546	91.02.001	2 - 3	II39251	SN6565

Repair kits

MORE KITS : Page 192

	TT KIT n°	CKSK.1
	Maker	KNORR
	OR kit n°	II328090062
	Description	Guides & Seals
Application		All SB...

	TT KIT n°	CKSK.4 /4.2
	Maker	KNORR
	OR kit n°	K000944 / K001300
	Description	Tappets
Application		All SB... All SN/NA/SK

	TT KIT n°	CKSK.6
	Maker	KNORR
	OR kit n°	K001532
	Description	Guides & Seals (New)
Application		All SB...

	TT KIT n°	CKSK.8
	Maker	KNORR
	OR kit n°	-
	Description	Complete overhaul
Application		All SB... All SN...

	TT KIT n°	CKSK.8.1
	Maker	KNORR
	OR kit n°	-
	Description	Guides & Seals
Application		All SB... All SN...

	TT KIT n°	CKSK.16/16.1
	Maker	KNORR
	OR kit n°	Only TT
	Description	Alu / Plastic cover
Application		All SB... All SN...

	TT KIT n°	CKSK.10.3/10.4
	Maker	KNORR
	OR kit n°	-
	Description	Adjusting Mechanism
Application		All SB... All SN...

	TT KIT n°	CKSK.3.2
	Maker	KNORR
	OR kit n°	K000472
	Description	Guide & Seals
Application		All SN...

Models



45 SERIES

Roadrunner Range (6-8 t)

45 SERIES

Roadrunner Range (8-11t)

55 SERIES

Roadrunner Range (11-15 t)

FA 55

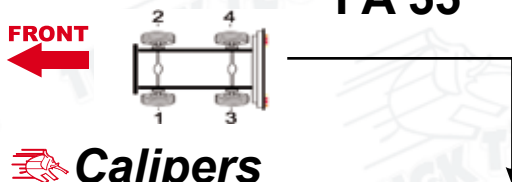

Calipers

	Wabco part n°	TT n°	Side
1	40 456 033	92.09.003	1
1	40 456 034	92.09.004	2
2	40 456 019	92.09.001	1
2	40 456 020	92.09.002	2
3	40 160 015	92.05.001	1
3	40 160 016	92.05.002	2

1 & 2



Maker	WABCO
Maker	Caliper type
All	456 F-0

3



Maker	WABCO
Wheel Size	16"
Models	Caliper type
All	1600 V-G

Repair kits

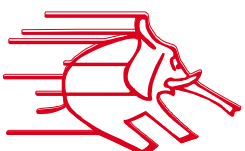
 NO PICTURE AVAILABLE	TT KIT n°	u.d.
	Maker	WABCO
	OR kit n°	12.991.116
	Description	1 piston
	Application	40 456 033 40 456 034

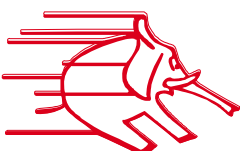
 NO PICTURE AVAILABLE	TT KIT n°	u.d.
	Maker	WABCO
	OR kit n°	12.991.141
	Description	Gaiter, Seals
	Application	40 456 019 40 456 020

 NO PICTURE AVAILABLE	TT KIT n°	u.d.
	Maker	WABCO
	OR kit n°	12.999.551
	Description	Guide, pin, bush
	Application	40 160 015 40 160 016

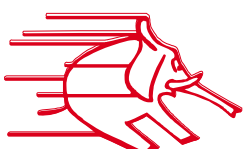
 NO PICTURE AVAILABLE	TT KIT n°	u.d.
	Maker	WABCO
	OR kit n°	12.999.552
	Description	Gaiters, seals
	Application	40 160 015 40 160 016

Models



LF 45
(6,2 -12 t) From 11.2000

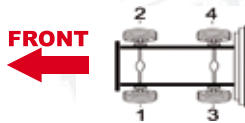

	TT KIT n°	WSSK.20.24
	OR kit n°	-
	Description	Wear Sensor

Maker	WABCO
Wheel Size	17.5"
Models	Caliper type
All	PAN 17

Calipers

Wabco part n°	TT n°	Side
40 175 070	92.01.007	1-3
40 175 071	92.01.008	2-4

Repair kits

MORE KITS : [Page 224](#)

	TT KIT n°	CWSK.2
	Maker	WABCO
	OR kit n°	12.999.699
	Description	Guides & seals
	Application	40 175 070 40 175 071

	TT KIT n°	CWSK.8
	Maker	WABCO
	OR kit n°	12.999.580
	Description	Seals, boots & screws
	Application	40 175 070 40 175 071

	TT KIT n°	CWSK.7
	Maker	WABCO
	OR kit n°	12.999.704
	Description	Seals, boots & screws
	Application	40 175 070 40 175 071

	TT KIT n°	CWSK.12
	Maker	WABCO
	OR kit n°	-
	Description	Roller bearing
	Application	40 175 070 40 175 071

	TT KIT n°	CWSK.17.1
	Maker	WABCO
	OR kit n°	-
	Description	Seals & boots
	Application	40 175 070 40 175 071

	TT KIT n°	CWSK.17.2
	Maker	WABCO
	OR kit n°	-
	Description	Guides & screws
	Application	40 175 070 40 175 071

	TT KIT n°	CWSK.12.4
	Maker	WABCO
	OR kit n°	-
	Description	Plugs & joint
	Application	40 175 070 40 175 071

	TT KIT n°	CWSK.12.1
	Maker	WABCO
	OR kit n°	-
	Description	Adjusting mechanism
	Application	40 175 070 40 175 071

Models



LF 55
(12- 15 t) From 09.2000 To 01.2003

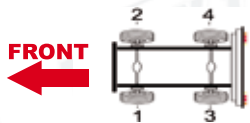

	TT KIT n°	WSSK.20.25
	OR kit n°	-
	Description	Wear Sensor

Maker	WABCO
Wheel Size	19.5"

Models	Caliper type
All	PAN19-2

Calipers

Wabco part n°	TT n°	Side
40 195 007	92.02.003	1-3
40 195 008	92.02.004	2-4

Repair kits

	TT KIT n°	CWSK.5
	Maker	WABCO
	OR kit n°	12.999.746
	Description	Guide & seals
	Application	All these calipers

MORE KITS : [Page 226](#)

Models



LF 55

(12-15 t) From 02.2003

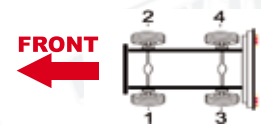

	TT KIT n°	WSSK.20.25
	OR kit n°	-
	Description	Wear Sensor

Maker	WABCO
Wheel size	19.5"
Models	Caliper type
All	PAN19-1 plus

Calipers

Wabco part n°	TT n°	Side
40 195 043	92.02.007	2-4
40 195 044	92.02.008	2-4

Repair kits

MORE KITS : [Page 226](#)

	TT KIT n°	CWSK.6
	Maker	WABCO
	OR kit n°	12.999.776
	Description	Guides & Seals
	Application	40 195 043 40 195 044

	TT KIT n°	CWSK.12.4
	Maker	WABCO
	OR kit n°	-
	Description	Plugs & joint
	Application	40 195 043 40 195 044

	TT KIT n°	CWSK.12
	Maker	WABCO
	OR kit n°	-
	Description	Roller bearing
	Application	40 195 043 40 195 044

Models



CF 65
CF 75
CF 85
F 65
LF 55 (Ø22.5")from 05.2001
XF 95



Calipers

Maker	KNORR
Wheel size	22.5"
Angle of actuator	0°
Brake type	Axial
Potentiometer	On/Off

Knorr type n°	TT n°	Side	Knorr part n°	Knorr rationalised n°
SB7880	91.03.019	1 - 3	K000002	SN7214
SB7890	91.03.020	2 - 4	K000003	SN7204

Repair kits

MORE KITS : Page 192

	<table border="1"> <tr> <td>TT KIT n°</td> <td>CKSK.1</td> </tr> <tr> <td>Maker</td> <td>KNORR</td> </tr> <tr> <td>OR kit n°</td> <td>II328090062</td> </tr> <tr> <td>Description</td> <td>Guides & Seals</td> </tr> <tr> <td>Application</td> <td>All SB...</td> </tr> </table>	TT KIT n°	CKSK.1	Maker	KNORR	OR kit n°	II328090062	Description	Guides & Seals	Application	All SB...		<table border="1"> <tr> <td>TT KIT n°</td> <td>CKSK.4 /4.2</td> </tr> <tr> <td>Maker</td> <td>KNORR</td> </tr> <tr> <td>OR kit n°</td> <td>K000944 / K001300</td> </tr> <tr> <td>Description</td> <td>Tappets</td> </tr> <tr> <td>Application</td> <td>All SB... All SN/NA/SK</td> </tr> </table>	TT KIT n°	CKSK.4 /4.2	Maker	KNORR	OR kit n°	K000944 / K001300	Description	Tappets	Application	All SB... All SN/NA/SK
TT KIT n°	CKSK.1																						
Maker	KNORR																						
OR kit n°	II328090062																						
Description	Guides & Seals																						
Application	All SB...																						
TT KIT n°	CKSK.4 /4.2																						
Maker	KNORR																						
OR kit n°	K000944 / K001300																						
Description	Tappets																						
Application	All SB... All SN/NA/SK																						
	<table border="1"> <tr> <td>TT KIT n°</td> <td>CKSK.6</td> </tr> <tr> <td>Maker</td> <td>KNORR</td> </tr> <tr> <td>OR kit n°</td> <td>K001532</td> </tr> <tr> <td>Description</td> <td>Guides & Seals (New)</td> </tr> <tr> <td>Application</td> <td>All SB...</td> </tr> </table>	TT KIT n°	CKSK.6	Maker	KNORR	OR kit n°	K001532	Description	Guides & Seals (New)	Application	All SB...		<table border="1"> <tr> <td>TT KIT n°</td> <td>CKSK.8</td> </tr> <tr> <td>Maker</td> <td>KNORR</td> </tr> <tr> <td>OR kit n°</td> <td>-</td> </tr> <tr> <td>Description</td> <td>Complete overhaul</td> </tr> <tr> <td>Application</td> <td>All SB... All SN...</td> </tr> </table>	TT KIT n°	CKSK.8	Maker	KNORR	OR kit n°	-	Description	Complete overhaul	Application	All SB... All SN...
TT KIT n°	CKSK.6																						
Maker	KNORR																						
OR kit n°	K001532																						
Description	Guides & Seals (New)																						
Application	All SB...																						
TT KIT n°	CKSK.8																						
Maker	KNORR																						
OR kit n°	-																						
Description	Complete overhaul																						
Application	All SB... All SN...																						
	<table border="1"> <tr> <td>TT KIT n°</td> <td>CKSK.8.1</td> </tr> <tr> <td>Maker</td> <td>KNORR</td> </tr> <tr> <td>OR kit n°</td> <td>-</td> </tr> <tr> <td>Description</td> <td>Guides & Seals</td> </tr> <tr> <td>Application</td> <td>All SB... All SN...</td> </tr> </table>	TT KIT n°	CKSK.8.1	Maker	KNORR	OR kit n°	-	Description	Guides & Seals	Application	All SB... All SN...		<table border="1"> <tr> <td>TT KIT n°</td> <td>CKSK.16/16.1</td> </tr> <tr> <td>Maker</td> <td>KNORR</td> </tr> <tr> <td>OR kit n°</td> <td>Only TT</td> </tr> <tr> <td>Description</td> <td>Alu / Plastic cover</td> </tr> <tr> <td>Application</td> <td>All SB... All SN...</td> </tr> </table>	TT KIT n°	CKSK.16/16.1	Maker	KNORR	OR kit n°	Only TT	Description	Alu / Plastic cover	Application	All SB... All SN...
TT KIT n°	CKSK.8.1																						
Maker	KNORR																						
OR kit n°	-																						
Description	Guides & Seals																						
Application	All SB... All SN...																						
TT KIT n°	CKSK.16/16.1																						
Maker	KNORR																						
OR kit n°	Only TT																						
Description	Alu / Plastic cover																						
Application	All SB... All SN...																						
	<table border="1"> <tr> <td>TT KIT n°</td> <td>CKSK.103/104</td> </tr> <tr> <td>Maker</td> <td>KNORR</td> </tr> <tr> <td>OR kit n°</td> <td>-</td> </tr> <tr> <td>Description</td> <td>Adjusting Mechanism</td> </tr> <tr> <td>Application</td> <td>All SB... All SN...</td> </tr> </table>	TT KIT n°	CKSK.103/104	Maker	KNORR	OR kit n°	-	Description	Adjusting Mechanism	Application	All SB... All SN...		<table border="1"> <tr> <td>TT KIT n°</td> <td>CKSK.3.2</td> </tr> <tr> <td>Maker</td> <td>KNORR</td> </tr> <tr> <td>OR kit n°</td> <td>K000472</td> </tr> <tr> <td>Description</td> <td>Guide & Seals</td> </tr> <tr> <td>Application</td> <td>All SN...</td> </tr> </table>	TT KIT n°	CKSK.3.2	Maker	KNORR	OR kit n°	K000472	Description	Guide & Seals	Application	All SN...
TT KIT n°	CKSK.103/104																						
Maker	KNORR																						
OR kit n°	-																						
Description	Adjusting Mechanism																						
Application	All SB... All SN...																						
TT KIT n°	CKSK.3.2																						
Maker	KNORR																						
OR kit n°	K000472																						
Description	Guide & Seals																						
Application	All SN...																						

DAIMLER - CHRYSLER - MERCEDES TRUCK

Models



ATEGO / 1023

Ø 17.5", (caliper fitted with a on/off Potentiometer)

ATEGO / 1528

Ø 17.5", (caliper fitted with a on/off Potentiometer)

ATEGO / 712

Ø 17.5", (caliper fitted with a on/off Potentiometer)

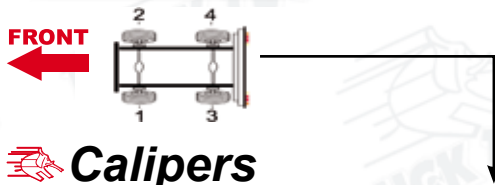

Calipers

Maker	KNORR
Wheel size	17.5"
Angle of actuator	+12°
brake type	Axial
POffotentiometer	On/Off

Knorr type n°	TT n°	Side	Knorr part n°	Knorr rationalised n°
SB5013	91.01.003	1-3	II31035	SN5016
SB5003	91.01.004	2-4	II31034	SN5006

Repair kits

MORE KITS : [Page 188](#)

	TT KIT n°	CKSK.4 /4.2		TT KIT n°	CKSK.6
	Maker	KNORR		Maker	KNORR
	OR kit n°	K000944 / K001300		OR kit n°	K001532
	Description	Tappets		Description	Guides & seals (New)
Application	All SB... All SN/NA/SK		Application	All SB... All SN...	
	TT KIT n°	CKSK.8		TT KIT n°	CKSK.8.1
	Maker	KNORR		Maker	KNORR
	Description	Complete overhaul		Description	Guides & seals
	Application	All SB... All SN...		Application	All SB... All SN...
	TT KIT n°	CKSK.5		TT KIT n°	CKSK.12
	Maker	KNORR		Maker	KNORR
	OR kit n°	K001301		OR kit n°	-
	Description	Outer boots and steelcaps		Description	Chain
Application	All SB... All SN...		Application	All SB... All SN...	
	TT KIT n°	CKSK.10.1		TT KIT n°	CKSK.14/14.1
	Maker	KNORR		Maker	KNORR
	OR kit n°	-		OR kit n°	Only tt
	Description	Pignon-shaft		Description	Roller Bearings
Application	All SB... All SN...		Application	All SB... All SN...	

DAIMLER - CHRYSLER - MERCEDES AXLE

Models



Powersystems

Ø 19.5" wheel size. From 01.1997

Powersystems

Ø 22.5" wheel size. From 01.1997

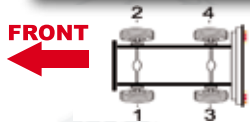









Calipers

Maker	KNORR
Brake type	Axial

Knorr type n°	TT n°	Side	Knorr part n°	Knorr rationalised n°
SB6540 (19.5"/+5°)	91.02.001	1	II39036	SN6563
SB6550 (19.5"/+5°)	91.02.002	2	II39037	SN6573
SB7800 (22.5"/-12°)	91.03.001	1	II37793	SN7199
SB7810 (22.5"/-12°)	91.03.002	2	II37794	SN7189

Repair kits

MORE KITS : Page 192

	<table border="1"> <tr> <td>TT KIT n°</td> <td>CKSK.1</td> </tr> <tr> <td>Maker</td> <td>KNORR</td> </tr> <tr> <td>OR kit n°</td> <td>II328090062</td> </tr> <tr> <td>Description</td> <td>Guides & Seals</td> </tr> <tr> <td>Application</td> <td>All SB...</td> </tr> </table>	TT KIT n°	CKSK.1	Maker	KNORR	OR kit n°	II328090062	Description	Guides & Seals	Application	All SB...		<table border="1"> <tr> <td>TT KIT n°</td> <td>CKSK.4 /4.2</td> </tr> <tr> <td>Maker</td> <td>KNORR</td> </tr> <tr> <td>OR kit n°</td> <td>K000944 / K001300</td> </tr> <tr> <td>Description</td> <td>Tappets</td> </tr> <tr> <td>Application</td> <td>All SB... All SN/NA/SK</td> </tr> </table>	TT KIT n°	CKSK.4 /4.2	Maker	KNORR	OR kit n°	K000944 / K001300	Description	Tappets	Application	All SB... All SN/NA/SK
TT KIT n°	CKSK.1																						
Maker	KNORR																						
OR kit n°	II328090062																						
Description	Guides & Seals																						
Application	All SB...																						
TT KIT n°	CKSK.4 /4.2																						
Maker	KNORR																						
OR kit n°	K000944 / K001300																						
Description	Tappets																						
Application	All SB... All SN/NA/SK																						
	<table border="1"> <tr> <td>TT KIT n°</td> <td>CKSK.6</td> </tr> <tr> <td>Maker</td> <td>KNORR</td> </tr> <tr> <td>OR kit n°</td> <td>K001532</td> </tr> <tr> <td>Description</td> <td>Guides & Seals (New)</td> </tr> <tr> <td>Application</td> <td>All SB...</td> </tr> </table>	TT KIT n°	CKSK.6	Maker	KNORR	OR kit n°	K001532	Description	Guides & Seals (New)	Application	All SB...		<table border="1"> <tr> <td>TT KIT n°</td> <td>CKSK.8</td> </tr> <tr> <td>Maker</td> <td>KNORR</td> </tr> <tr> <td>OR kit n°</td> <td>-</td> </tr> <tr> <td>Description</td> <td>Complete overhaul</td> </tr> <tr> <td>Application</td> <td>All SB... All SN...</td> </tr> </table>	TT KIT n°	CKSK.8	Maker	KNORR	OR kit n°	-	Description	Complete overhaul	Application	All SB... All SN...
TT KIT n°	CKSK.6																						
Maker	KNORR																						
OR kit n°	K001532																						
Description	Guides & Seals (New)																						
Application	All SB...																						
TT KIT n°	CKSK.8																						
Maker	KNORR																						
OR kit n°	-																						
Description	Complete overhaul																						
Application	All SB... All SN...																						
	<table border="1"> <tr> <td>TT KIT n°</td> <td>CKSK.8.1</td> </tr> <tr> <td>Maker</td> <td>KNORR</td> </tr> <tr> <td>OR kit n°</td> <td>-</td> </tr> <tr> <td>Description</td> <td>Guides & Seals</td> </tr> <tr> <td>Application</td> <td>All SB... All SN...</td> </tr> </table>	TT KIT n°	CKSK.8.1	Maker	KNORR	OR kit n°	-	Description	Guides & Seals	Application	All SB... All SN...		<table border="1"> <tr> <td>TT KIT n°</td> <td>CKSK.16/16.1</td> </tr> <tr> <td>Maker</td> <td>KNORR</td> </tr> <tr> <td>OR kit n°</td> <td>Only TT</td> </tr> <tr> <td>Description</td> <td>Alu / Plastic cover</td> </tr> <tr> <td>Application</td> <td>All SB... All SN...</td> </tr> </table>	TT KIT n°	CKSK.16/16.1	Maker	KNORR	OR kit n°	Only TT	Description	Alu / Plastic cover	Application	All SB... All SN...
TT KIT n°	CKSK.8.1																						
Maker	KNORR																						
OR kit n°	-																						
Description	Guides & Seals																						
Application	All SB... All SN...																						
TT KIT n°	CKSK.16/16.1																						
Maker	KNORR																						
OR kit n°	Only TT																						
Description	Alu / Plastic cover																						
Application	All SB... All SN...																						
	<table border="1"> <tr> <td>TT KIT n°</td> <td>CKSK.10.3/10.4</td> </tr> <tr> <td>Maker</td> <td>KNORR</td> </tr> <tr> <td>OR kit n°</td> <td>-</td> </tr> <tr> <td>Description</td> <td>Adjusting Mechanism</td> </tr> <tr> <td>Application</td> <td>All SB... All SN...</td> </tr> </table>	TT KIT n°	CKSK.10.3/10.4	Maker	KNORR	OR kit n°	-	Description	Adjusting Mechanism	Application	All SB... All SN...		<table border="1"> <tr> <td>TT KIT n°</td> <td>CKSK.3.2</td> </tr> <tr> <td>Maker</td> <td>KNORR</td> </tr> <tr> <td>OR kit n°</td> <td>K000472</td> </tr> <tr> <td>Description</td> <td>Guide & Seals</td> </tr> <tr> <td>Application</td> <td>All SN...</td> </tr> </table>	TT KIT n°	CKSK.3.2	Maker	KNORR	OR kit n°	K000472	Description	Guide & Seals	Application	All SN...
TT KIT n°	CKSK.10.3/10.4																						
Maker	KNORR																						
OR kit n°	-																						
Description	Adjusting Mechanism																						
Application	All SB... All SN...																						
TT KIT n°	CKSK.3.2																						
Maker	KNORR																						
OR kit n°	K000472																						
Description	Guide & Seals																						
Application	All SN...																						

DAIMLER - CHRYSLER - MERCEDES BUS

Models



MICROBUS 712C

From 1998

MICROBUS 914C

From 1998

MICROBUS LO914



FRONT

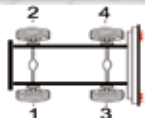

Calipers

	TT KIT ref.	WSSK.20.13
	OR kit n°	9015400117
	Description	Wear Sensor

Maker	WABCO
Wheel size	17.5"

Wabco part n°	TT n°	Side
640 175 074	92.01.009	1
640 175 075	92.01.010	2
640 175 076	92.01.011	3
640 175 077	92.01.012	4

Repair kits

MORE KITS : [Page 224](#)

	TT KIT n°	CWSK.10
	Maker	WABCO
	OR kit n°	844 503.024.2
	Description	Guides & Seals
	Application	All these calipers

	TT KIT n°	CWSK.11
	Maker	WABCO
	OR kit n°	844 503.503.2
	Description	Seals & Caps
	Application	All these calipers

DAIMLER - CHRYSLER - MERCEDES BUS

Models



MINIBUS MAGO 1



Maker	MERITOR
Wheel size	17,5" (FRONT)

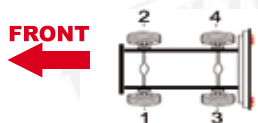

Calipers

N°	Meritor part n°	TT n°	Side
1	LRG520	93.01.015	1
1	LRG521	93.01.016	2
2	LRG626	93.02.009	3
2	LRG627	93.02.010	4



Maker	MERITOR
Wheel size	17,5" (REAR)

Repair kits

	TT KIT n°	CMSK.16.1
	Maker	MERITOR
	OR kit n°	SP8597
	Description	Dirt excluder dust cover
	Application	-

	TT KIT n°	CMSK.17
	Maker	MERITOR
	OR kit n°	SJ1035
	Description	Guide pin
	Application	-

	TT KIT n°	CMSK.17.1
	Maker	MERITOR
	OR kit n°	-
	Description	Piston
	Application	LRG626 LRG627

	TT KIT n°	CMSK.17.2
	Maker	MERITOR
	OR kit n°	-
	Description	Piston
	Application	LRG626 LRG627

DAIMLER - CHRYSLER - MERCEDES BUS

Models



OMNIBUS 0350
OMNIBUS 0403
OMNIBUS 0404

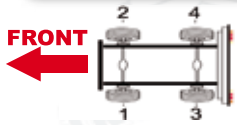

Calipers

N°	Meritor part n°	TT n°	Side
1	LRG532	93.04.007	1
1	LRG533	93.04.008	2
2	LRG622	93.04.011	3
2	LRG623	93.04.012	4



Maker	MERITOR
Wheel size	22,5"

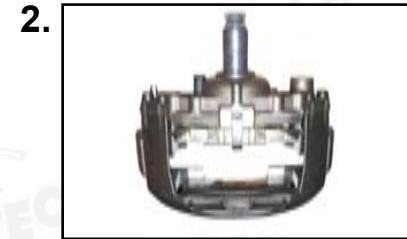

Maker	MERITOR
Wheel size	22,5"

Repair kits

MORE KITS : Page 204

TT KIT n°	CMSK.1
Maker	MERITOR
OR kit n°	SJ4001
Description	Guides & Seals
Application	LRG532/33 LRG622/23

TT KIT n°	CMSK.6
Maker	MERITOR
OR kit n°	SJ1212
Description	Cover & Boots
Application	LRG532/33 LRG622/23

TT KIT n°	CMSK.24.3/25.3
Maker	MERITOR
OR kit n°	-
Description	Clutch mechanism
Application	LRG532/33 LRG622/23

TT KIT n°	CMSK.24.4/25.4
Maker	MERITOR
OR kit n°	-
Description	Adjuster tappet
Application	LRG532/33 LRG622/23

TT KIT n°	CMSK.28/29
Maker	MERITOR
OR kit n°	-
Description	Shaft
Application	LRG532 LRG533

TT KIT n°	CMSK.24.1/25.1
Maker	MERITOR
OR kit n°	-
Description	Support - spiral
Application	LRG532/33 LRG622/23

TT KIT n°	CMSK.24.2
Maker	MERITOR
OR kit n°	-
Description	Roller
Application	LRG532/33 LRG622/23

TT KIT n°	CMSK.24.7
Maker	MERITOR
OR kit n°	-
Description	Shaft Roller Bearing
Application	LRG532/33 LRG622/23

DAIMLER - CHRYSLER - MERCEDES TRUCK

Models



ATEGO / 1023

Ø 17.5", (caliper fitted with a continuous Potentiometer)

ATEGO /712

Ø 17.5", (caliper fitted with a continuous Potentiometer)

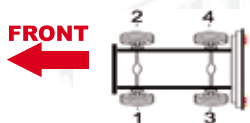

Calipers

Maker	KNORR
Wheel size	17.5"
Angle of actuator	+12°
brake type	Axial
Potentiometer	Continuous

Knorr type n°	TT n°	Side	Knorr part n°	Knorr rationalised n°
SB5012	91.01.001	1-3	1136684	SN5015
SB5002	91.01.002	2-4	1136683	SN5005

Repair kits

MORE KITS : Page 188

	<table border="1"> <tr> <td>TT KIT n°</td> <td>CKSK.4 /4.2</td> </tr> <tr> <td>Maker</td> <td>KNORR</td> </tr> <tr> <td>OR kit n°</td> <td>K000944 / K001300</td> </tr> <tr> <td>Description</td> <td>Tappets</td> </tr> <tr> <td>Application</td> <td>All SB... All SN/NA/SK</td> </tr> </table>	TT KIT n°	CKSK.4 /4.2	Maker	KNORR	OR kit n°	K000944 / K001300	Description	Tappets	Application	All SB... All SN/NA/SK		<table border="1"> <tr> <td>TT KIT n°</td> <td>CKSK.6</td> </tr> <tr> <td>Maker</td> <td>KNORR</td> </tr> <tr> <td>OR kit n°</td> <td>K001532</td> </tr> <tr> <td>Description</td> <td>Guides & seals (New)</td> </tr> <tr> <td>Application</td> <td>All SB... All SN...</td> </tr> </table>	TT KIT n°	CKSK.6	Maker	KNORR	OR kit n°	K001532	Description	Guides & seals (New)	Application	All SB... All SN...
TT KIT n°	CKSK.4 /4.2																						
Maker	KNORR																						
OR kit n°	K000944 / K001300																						
Description	Tappets																						
Application	All SB... All SN/NA/SK																						
TT KIT n°	CKSK.6																						
Maker	KNORR																						
OR kit n°	K001532																						
Description	Guides & seals (New)																						
Application	All SB... All SN...																						
	<table border="1"> <tr> <td>TT KIT n°</td> <td>CKSK.8</td> </tr> <tr> <td>Maker</td> <td>KNORR</td> </tr> <tr> <td>OR kit n°</td> <td>Only tt</td> </tr> <tr> <td>Description</td> <td>Complete overhaul</td> </tr> <tr> <td>Application</td> <td>All SB... All SN...</td> </tr> </table>	TT KIT n°	CKSK.8	Maker	KNORR	OR kit n°	Only tt	Description	Complete overhaul	Application	All SB... All SN...		<table border="1"> <tr> <td>TT KIT n°</td> <td>CKSK.8.1</td> </tr> <tr> <td>Maker</td> <td>KNORR</td> </tr> <tr> <td>OR kit n°</td> <td>Only tt</td> </tr> <tr> <td>Description</td> <td>Guides & seals</td> </tr> <tr> <td>Application</td> <td>All SB... All SN...</td> </tr> </table>	TT KIT n°	CKSK.8.1	Maker	KNORR	OR kit n°	Only tt	Description	Guides & seals	Application	All SB... All SN...
TT KIT n°	CKSK.8																						
Maker	KNORR																						
OR kit n°	Only tt																						
Description	Complete overhaul																						
Application	All SB... All SN...																						
TT KIT n°	CKSK.8.1																						
Maker	KNORR																						
OR kit n°	Only tt																						
Description	Guides & seals																						
Application	All SB... All SN...																						
	<table border="1"> <tr> <td>TT KIT n°</td> <td>CKSK.5</td> </tr> <tr> <td>Maker</td> <td>KNORR</td> </tr> <tr> <td>OR kit n°</td> <td>K001301</td> </tr> <tr> <td>Description</td> <td>Outer boots and steel caps</td> </tr> <tr> <td>Application</td> <td>All SB... All SN...</td> </tr> </table>	TT KIT n°	CKSK.5	Maker	KNORR	OR kit n°	K001301	Description	Outer boots and steel caps	Application	All SB... All SN...		<table border="1"> <tr> <td>TT KIT n°</td> <td>CKSK.12</td> </tr> <tr> <td>Maker</td> <td>KNORR</td> </tr> <tr> <td>OR kit n°</td> <td>Only tt</td> </tr> <tr> <td>Description</td> <td></td> </tr> <tr> <td>Application</td> <td>All SB... All SN...</td> </tr> </table>	TT KIT n°	CKSK.12	Maker	KNORR	OR kit n°	Only tt	Description		Application	All SB... All SN...
TT KIT n°	CKSK.5																						
Maker	KNORR																						
OR kit n°	K001301																						
Description	Outer boots and steel caps																						
Application	All SB... All SN...																						
TT KIT n°	CKSK.12																						
Maker	KNORR																						
OR kit n°	Only tt																						
Description																							
Application	All SB... All SN...																						
	<table border="1"> <tr> <td>TT KIT n°</td> <td>CKSK.10.1</td> </tr> <tr> <td>Maker</td> <td>KNORR</td> </tr> <tr> <td>OR kit n°</td> <td>Only tt</td> </tr> <tr> <td>Description</td> <td>Pignon-shaft</td> </tr> <tr> <td>Application</td> <td>All SB... All SN...</td> </tr> </table>	TT KIT n°	CKSK.10.1	Maker	KNORR	OR kit n°	Only tt	Description	Pignon-shaft	Application	All SB... All SN...		<table border="1"> <tr> <td>TT KIT n°</td> <td>CKSK.14/14.1</td> </tr> <tr> <td>Maker</td> <td>KNORR</td> </tr> <tr> <td>OR kit n°</td> <td>Only tt</td> </tr> <tr> <td>Description</td> <td>Roller Bearings</td> </tr> <tr> <td>Application</td> <td>All SB... All SN...</td> </tr> </table>	TT KIT n°	CKSK.14/14.1	Maker	KNORR	OR kit n°	Only tt	Description	Roller Bearings	Application	All SB... All SN...
TT KIT n°	CKSK.10.1																						
Maker	KNORR																						
OR kit n°	Only tt																						
Description	Pignon-shaft																						
Application	All SB... All SN...																						
TT KIT n°	CKSK.14/14.1																						
Maker	KNORR																						
OR kit n°	Only tt																						
Description	Roller Bearings																						
Application	All SB... All SN...																						

DAIMLER - CHRYSLER - MERCEDES TRUCK

Models



ATEGO / 1220

Ø 19.5", (Caliper fitted with a On/Off Potentiometer)

ATEGO / 1528

Ø 19.5", (Caliper fitted with a On/Off Potentiometer)

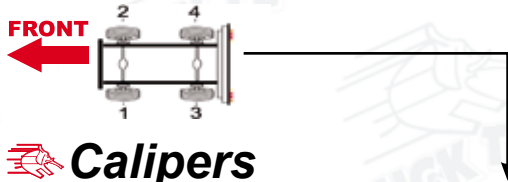

Calipers

Maker	KNORR
Wheel size	19.5"
Angle of actuator	+5°
Brake type	Axial
Potentiometer	On/Off

Knorr type n°	TT n°	Side	Knorr part n°	Knorr rationalised n°
SB6535	91.02.016	1-3	II37026	SN6514
SB6525	91.02.015	2-4	II37025	SN6504

Repair kits

MORE KITS : Page 192

	<table border="1"> <tr> <td>TT KIT n°</td> <td>CKSK.1</td> </tr> <tr> <td>Maker</td> <td>KNORR</td> </tr> <tr> <td>OR kit n°</td> <td>II328090062</td> </tr> <tr> <td>Description</td> <td>Guides & Seals</td> </tr> <tr> <td>Application</td> <td>All SB...</td> </tr> </table>	TT KIT n°	CKSK.1	Maker	KNORR	OR kit n°	II328090062	Description	Guides & Seals	Application	All SB...		<table border="1"> <tr> <td>TT KIT n°</td> <td>CKSK.4 /4.2</td> </tr> <tr> <td>Maker</td> <td>KNORR</td> </tr> <tr> <td>OR kit n°</td> <td>K000944 / K001300</td> </tr> <tr> <td>Description</td> <td>Tappets</td> </tr> <tr> <td>Application</td> <td>All SB... All SN/NA/SK</td> </tr> </table>	TT KIT n°	CKSK.4 /4.2	Maker	KNORR	OR kit n°	K000944 / K001300	Description	Tappets	Application	All SB... All SN/NA/SK
TT KIT n°	CKSK.1																						
Maker	KNORR																						
OR kit n°	II328090062																						
Description	Guides & Seals																						
Application	All SB...																						
TT KIT n°	CKSK.4 /4.2																						
Maker	KNORR																						
OR kit n°	K000944 / K001300																						
Description	Tappets																						
Application	All SB... All SN/NA/SK																						
	<table border="1"> <tr> <td>TT KIT n°</td> <td>CKSK.6</td> </tr> <tr> <td>Maker</td> <td>KNORR</td> </tr> <tr> <td>OR kit n°</td> <td>K001532</td> </tr> <tr> <td>Description</td> <td>Guides & Seals (New)</td> </tr> <tr> <td>Application</td> <td>All SB...</td> </tr> </table>	TT KIT n°	CKSK.6	Maker	KNORR	OR kit n°	K001532	Description	Guides & Seals (New)	Application	All SB...		<table border="1"> <tr> <td>TT KIT n°</td> <td>CKSK.8</td> </tr> <tr> <td>Maker</td> <td>KNORR</td> </tr> <tr> <td>OR kit n°</td> <td>-</td> </tr> <tr> <td>Description</td> <td>Complete overhaul</td> </tr> <tr> <td>Application</td> <td>All SB... All SN...</td> </tr> </table>	TT KIT n°	CKSK.8	Maker	KNORR	OR kit n°	-	Description	Complete overhaul	Application	All SB... All SN...
TT KIT n°	CKSK.6																						
Maker	KNORR																						
OR kit n°	K001532																						
Description	Guides & Seals (New)																						
Application	All SB...																						
TT KIT n°	CKSK.8																						
Maker	KNORR																						
OR kit n°	-																						
Description	Complete overhaul																						
Application	All SB... All SN...																						
	<table border="1"> <tr> <td>TT KIT n°</td> <td>CKSK.8.1</td> </tr> <tr> <td>Maker</td> <td>KNORR</td> </tr> <tr> <td>OR kit n°</td> <td>-</td> </tr> <tr> <td>Description</td> <td>Guides & Seals</td> </tr> <tr> <td>Application</td> <td>All SB... All SN...</td> </tr> </table>	TT KIT n°	CKSK.8.1	Maker	KNORR	OR kit n°	-	Description	Guides & Seals	Application	All SB... All SN...		<table border="1"> <tr> <td>TT KIT n°</td> <td>CKSK.16/16.1</td> </tr> <tr> <td>Maker</td> <td>KNORR</td> </tr> <tr> <td>OR kit n°</td> <td>Only TT</td> </tr> <tr> <td>Description</td> <td>Alu / Plastic cover</td> </tr> <tr> <td>Application</td> <td>All SB... All SN...</td> </tr> </table>	TT KIT n°	CKSK.16/16.1	Maker	KNORR	OR kit n°	Only TT	Description	Alu / Plastic cover	Application	All SB... All SN...
TT KIT n°	CKSK.8.1																						
Maker	KNORR																						
OR kit n°	-																						
Description	Guides & Seals																						
Application	All SB... All SN...																						
TT KIT n°	CKSK.16/16.1																						
Maker	KNORR																						
OR kit n°	Only TT																						
Description	Alu / Plastic cover																						
Application	All SB... All SN...																						
	<table border="1"> <tr> <td>TT KIT n°</td> <td>CKSK.10.3/10.4</td> </tr> <tr> <td>Maker</td> <td>KNORR</td> </tr> <tr> <td>OR kit n°</td> <td>-</td> </tr> <tr> <td>Description</td> <td>Adjusting Mechanism</td> </tr> <tr> <td>Application</td> <td>All SB... All SN...</td> </tr> </table>	TT KIT n°	CKSK.10.3/10.4	Maker	KNORR	OR kit n°	-	Description	Adjusting Mechanism	Application	All SB... All SN...		<table border="1"> <tr> <td>TT KIT n°</td> <td>CKSK.3.2</td> </tr> <tr> <td>Maker</td> <td>KNORR</td> </tr> <tr> <td>OR kit n°</td> <td>K000472</td> </tr> <tr> <td>Description</td> <td>Guide & Seals</td> </tr> <tr> <td>Application</td> <td>All SN...</td> </tr> </table>	TT KIT n°	CKSK.3.2	Maker	KNORR	OR kit n°	K000472	Description	Guide & Seals	Application	All SN...
TT KIT n°	CKSK.10.3/10.4																						
Maker	KNORR																						
OR kit n°	-																						
Description	Adjusting Mechanism																						
Application	All SB... All SN...																						
TT KIT n°	CKSK.3.2																						
Maker	KNORR																						
OR kit n°	K000472																						
Description	Guide & Seals																						
Application	All SN...																						

DAIMLER - CHRYSLER - MERCEDES AXLE

Models



ATEGO / 1220

Ø 19.5", (Caliper fitted with a Continuous Potentiometer)

ATEGO / 1528

Ø 19.5", (Caliper fitted with a Continuous Potentiometer)

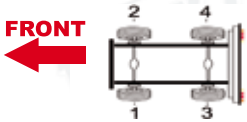

Calipers

Maker	KNORR
Wheel size	19.5"
Angle of actuator	+5°
Brake type	Axial
Potentiometer	Continuous

Knorr type n°	TT n°	Side	Knorr part n°	Knorr rationalised n°
SB6516	91.02.017	1-3	II32805	SN6558
SB6506	91.02.018	2-4	II32804	SN6568

Repair kits

MORE KITS : [Page 192](#)

	<table border="1"> <tr> <td>TT KIT n°</td> <td>CKSK.1</td> </tr> <tr> <td>Maker</td> <td>KNORR</td> </tr> <tr> <td>OR kit n°</td> <td>II328090062</td> </tr> <tr> <td>Description</td> <td>Guides & Seals</td> </tr> <tr> <td>Application</td> <td>All SB...</td> </tr> </table>	TT KIT n°	CKSK.1	Maker	KNORR	OR kit n°	II328090062	Description	Guides & Seals	Application	All SB...		<table border="1"> <tr> <td>TT KIT n°</td> <td>CKSK.4 / 4.2</td> </tr> <tr> <td>Maker</td> <td>KNORR</td> </tr> <tr> <td>OR kit n°</td> <td>K000944 / K001300</td> </tr> <tr> <td>Description</td> <td>Tappets</td> </tr> <tr> <td>Application</td> <td>All SB... All SN/NA/SK</td> </tr> </table>	TT KIT n°	CKSK.4 / 4.2	Maker	KNORR	OR kit n°	K000944 / K001300	Description	Tappets	Application	All SB... All SN/NA/SK
TT KIT n°	CKSK.1																						
Maker	KNORR																						
OR kit n°	II328090062																						
Description	Guides & Seals																						
Application	All SB...																						
TT KIT n°	CKSK.4 / 4.2																						
Maker	KNORR																						
OR kit n°	K000944 / K001300																						
Description	Tappets																						
Application	All SB... All SN/NA/SK																						
	<table border="1"> <tr> <td>TT KIT n°</td> <td>CKSK.6</td> </tr> <tr> <td>Maker</td> <td>KNORR</td> </tr> <tr> <td>OR kit n°</td> <td>K001532</td> </tr> <tr> <td>Description</td> <td>Guides & Seals (New)</td> </tr> <tr> <td>Application</td> <td>All SB...</td> </tr> </table>	TT KIT n°	CKSK.6	Maker	KNORR	OR kit n°	K001532	Description	Guides & Seals (New)	Application	All SB...		<table border="1"> <tr> <td>TT KIT n°</td> <td>CKSK.8</td> </tr> <tr> <td>Maker</td> <td>KNORR</td> </tr> <tr> <td>OR kit n°</td> <td>-</td> </tr> <tr> <td>Description</td> <td>Complete overhaul</td> </tr> <tr> <td>Application</td> <td>All SB... All SN...</td> </tr> </table>	TT KIT n°	CKSK.8	Maker	KNORR	OR kit n°	-	Description	Complete overhaul	Application	All SB... All SN...
TT KIT n°	CKSK.6																						
Maker	KNORR																						
OR kit n°	K001532																						
Description	Guides & Seals (New)																						
Application	All SB...																						
TT KIT n°	CKSK.8																						
Maker	KNORR																						
OR kit n°	-																						
Description	Complete overhaul																						
Application	All SB... All SN...																						
	<table border="1"> <tr> <td>TT KIT n°</td> <td>CKSK.8.1</td> </tr> <tr> <td>Maker</td> <td>KNORR</td> </tr> <tr> <td>OR kit n°</td> <td>-</td> </tr> <tr> <td>Description</td> <td>Guides & Seals</td> </tr> <tr> <td>Application</td> <td>All SB... All SN...</td> </tr> </table>	TT KIT n°	CKSK.8.1	Maker	KNORR	OR kit n°	-	Description	Guides & Seals	Application	All SB... All SN...		<table border="1"> <tr> <td>TT KIT n°</td> <td>CKSK.16/16.1</td> </tr> <tr> <td>Maker</td> <td>KNORR</td> </tr> <tr> <td>OR kit n°</td> <td>Only TT</td> </tr> <tr> <td>Description</td> <td>Alu / Plastic cover</td> </tr> <tr> <td>Application</td> <td>All SB... All SN...</td> </tr> </table>	TT KIT n°	CKSK.16/16.1	Maker	KNORR	OR kit n°	Only TT	Description	Alu / Plastic cover	Application	All SB... All SN...
TT KIT n°	CKSK.8.1																						
Maker	KNORR																						
OR kit n°	-																						
Description	Guides & Seals																						
Application	All SB... All SN...																						
TT KIT n°	CKSK.16/16.1																						
Maker	KNORR																						
OR kit n°	Only TT																						
Description	Alu / Plastic cover																						
Application	All SB... All SN...																						
	<table border="1"> <tr> <td>TT KIT n°</td> <td>CKSK.103/104</td> </tr> <tr> <td>Maker</td> <td>KNORR</td> </tr> <tr> <td>OR kit n°</td> <td>-</td> </tr> <tr> <td>Description</td> <td>Adjusting Mechanism</td> </tr> <tr> <td>Application</td> <td>All SB... All SN...</td> </tr> </table>	TT KIT n°	CKSK.103/104	Maker	KNORR	OR kit n°	-	Description	Adjusting Mechanism	Application	All SB... All SN...		<table border="1"> <tr> <td>TT KIT n°</td> <td>CKSK.3.2</td> </tr> <tr> <td>Maker</td> <td>KNORR</td> </tr> <tr> <td>OR kit n°</td> <td>K000472</td> </tr> <tr> <td>Description</td> <td>Guide & Seals</td> </tr> <tr> <td>Application</td> <td>All SN...</td> </tr> </table>	TT KIT n°	CKSK.3.2	Maker	KNORR	OR kit n°	K000472	Description	Guide & Seals	Application	All SN...
TT KIT n°	CKSK.103/104																						
Maker	KNORR																						
OR kit n°	-																						
Description	Adjusting Mechanism																						
Application	All SB... All SN...																						
TT KIT n°	CKSK.3.2																						
Maker	KNORR																						
OR kit n°	K000472																						
Description	Guide & Seals																						
Application	All SN...																						

DAIMLER - CHRYSLER - MERCEDES TRUCK

Models



ACTROS

From 1995

ATEGO-S

From 2001

AXOR

From 1998

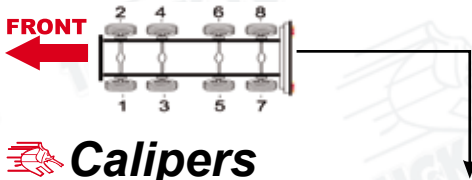

Calipers

Maker	KNORR
Wheel size	22.5"
Angle of actuator	-12°
Brake type	Axial
Potentiometer	Continuous

Knorr type n°	TT n°	Side	Knorr part n°	Knorr rationalised n°
SB7648	91.03.013	1-3-5-7	1132798	SN7211
SB7658	91.03.014	2-4-6-8	1132799	SN7201

Repair kits

MORE KITS : [Page 192](#)

	<table border="1"> <tr> <td>TT KIT n°</td> <td>CKSK.1</td> </tr> <tr> <td>Maker</td> <td>KNORR</td> </tr> <tr> <td>OR kit n°</td> <td>11328090062</td> </tr> <tr> <td>Description</td> <td>Guides & Seals</td> </tr> <tr> <td>Application</td> <td>All SB...</td> </tr> </table>	TT KIT n°	CKSK.1	Maker	KNORR	OR kit n°	11328090062	Description	Guides & Seals	Application	All SB...		<table border="1"> <tr> <td>TT KIT n°</td> <td>CKSK.4 /4.2</td> </tr> <tr> <td>Maker</td> <td>KNORR</td> </tr> <tr> <td>OR kit n°</td> <td>K000944 / K001300</td> </tr> <tr> <td>Description</td> <td>Tappets</td> </tr> <tr> <td>Application</td> <td>All SB... All SN/NA/SK</td> </tr> </table>	TT KIT n°	CKSK.4 /4.2	Maker	KNORR	OR kit n°	K000944 / K001300	Description	Tappets	Application	All SB... All SN/NA/SK
TT KIT n°	CKSK.1																						
Maker	KNORR																						
OR kit n°	11328090062																						
Description	Guides & Seals																						
Application	All SB...																						
TT KIT n°	CKSK.4 /4.2																						
Maker	KNORR																						
OR kit n°	K000944 / K001300																						
Description	Tappets																						
Application	All SB... All SN/NA/SK																						
	<table border="1"> <tr> <td>TT KIT n°</td> <td>CKSK.6</td> </tr> <tr> <td>Maker</td> <td>KNORR</td> </tr> <tr> <td>OR kit n°</td> <td>K001532</td> </tr> <tr> <td>Description</td> <td>Guides & Seals (New)</td> </tr> <tr> <td>Application</td> <td>All SB...</td> </tr> </table>	TT KIT n°	CKSK.6	Maker	KNORR	OR kit n°	K001532	Description	Guides & Seals (New)	Application	All SB...		<table border="1"> <tr> <td>TT KIT n°</td> <td>CKSK.8</td> </tr> <tr> <td>Maker</td> <td>KNORR</td> </tr> <tr> <td>OR kit n°</td> <td>-</td> </tr> <tr> <td>Description</td> <td>Complete overhaul</td> </tr> <tr> <td>Application</td> <td>All SB... All SN...</td> </tr> </table>	TT KIT n°	CKSK.8	Maker	KNORR	OR kit n°	-	Description	Complete overhaul	Application	All SB... All SN...
TT KIT n°	CKSK.6																						
Maker	KNORR																						
OR kit n°	K001532																						
Description	Guides & Seals (New)																						
Application	All SB...																						
TT KIT n°	CKSK.8																						
Maker	KNORR																						
OR kit n°	-																						
Description	Complete overhaul																						
Application	All SB... All SN...																						
	<table border="1"> <tr> <td>TT KIT n°</td> <td>CKSK.8.1</td> </tr> <tr> <td>Maker</td> <td>KNORR</td> </tr> <tr> <td>OR kit n°</td> <td>Only TT</td> </tr> <tr> <td>Description</td> <td>Guides & Seals</td> </tr> <tr> <td>Application</td> <td>All SB... All SN...</td> </tr> </table>	TT KIT n°	CKSK.8.1	Maker	KNORR	OR kit n°	Only TT	Description	Guides & Seals	Application	All SB... All SN...		<table border="1"> <tr> <td>TT KIT n°</td> <td>CKSK.16/16.1</td> </tr> <tr> <td>Maker</td> <td>KNORR</td> </tr> <tr> <td>OR kit n°</td> <td>Only TT</td> </tr> <tr> <td>Description</td> <td>Alu / Plastic cover</td> </tr> <tr> <td>Application</td> <td>All SB... All SN...</td> </tr> </table>	TT KIT n°	CKSK.16/16.1	Maker	KNORR	OR kit n°	Only TT	Description	Alu / Plastic cover	Application	All SB... All SN...
TT KIT n°	CKSK.8.1																						
Maker	KNORR																						
OR kit n°	Only TT																						
Description	Guides & Seals																						
Application	All SB... All SN...																						
TT KIT n°	CKSK.16/16.1																						
Maker	KNORR																						
OR kit n°	Only TT																						
Description	Alu / Plastic cover																						
Application	All SB... All SN...																						
	<table border="1"> <tr> <td>TT KIT n°</td> <td>CKSK.10.3/10.4</td> </tr> <tr> <td>Maker</td> <td>KNORR</td> </tr> <tr> <td>OR kit n°</td> <td>-</td> </tr> <tr> <td>Description</td> <td>Adjusting Mechanism</td> </tr> <tr> <td>Application</td> <td>All SB... All SN...</td> </tr> </table>	TT KIT n°	CKSK.10.3/10.4	Maker	KNORR	OR kit n°	-	Description	Adjusting Mechanism	Application	All SB... All SN...		<table border="1"> <tr> <td>TT KIT n°</td> <td>CKSK.3.2</td> </tr> <tr> <td>Maker</td> <td>KNORR</td> </tr> <tr> <td>OR kit n°</td> <td>K000472</td> </tr> <tr> <td>Description</td> <td>Guide & Seals</td> </tr> <tr> <td>Application</td> <td>All SN...</td> </tr> </table>	TT KIT n°	CKSK.3.2	Maker	KNORR	OR kit n°	K000472	Description	Guide & Seals	Application	All SN...
TT KIT n°	CKSK.10.3/10.4																						
Maker	KNORR																						
OR kit n°	-																						
Description	Adjusting Mechanism																						
Application	All SB... All SN...																						
TT KIT n°	CKSK.3.2																						
Maker	KNORR																						
OR kit n°	K000472																						
Description	Guide & Seals																						
Application	All SN...																						

DAIMLER - CHRYSLER - MERCEDES TRUCK

Models



VARIO 812D

From 07.1996

VARIO 814D

From 07.1996



Maker	MERITOR
Wheel size	17,5" (FRONT)

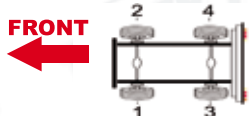

Calipers

N°	Meritor part n°	TT n°	Side
1	LRG520	93.01.015	1
1	LRG521	93.01.016	2
2	LRG626	93.02.009	3
2	LRG627	93.02.010	4



Maker	MERITOR
Wheel size	17,5" (REAR)

Repair kits

	TT KIT n°	CMSK.16.1
	Maker	MERITOR
	OR kit n°	SP8597
	Description	Dirt excluder dust cover
	Application	LRG520

	TT KIT n°	CMSK.17
	Maker	MERITOR
	OR kit n°	SJ1035
	Description	Guide pin
	Application	LRG626 LRG627

	TT KIT n°	CMSK.17.1
	Maker	MERITOR
	OR kit n°	-
	Description	Piston
	Application	LRG626 LRG627

	TT KIT n°	CMSK.17.2
	Maker	MERITOR
	OR kit n°	-
	Description	Piston
	Application	LRG626 LRG627

Models



JAVELIN MK11

FROM 1991 To 1995



Maker	MERITOR
Wheel size	22.5"

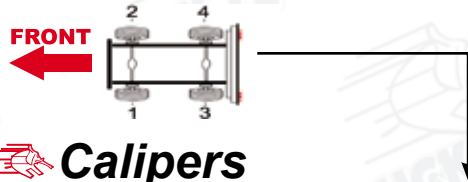

Calipers

Meritor part n°	TT n°	Side
LRG530	93.03.003	1
LRG531	93.03.004	2

Repair kits

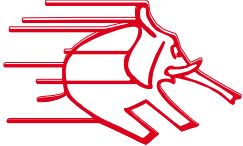
 NO PICTURE AVAILABLE	TT KIT n°	u.d.
	Maker	MERITOR
	OR kit n°	SJ1018
	Description	Auto adjuster
	Application	All these calipers

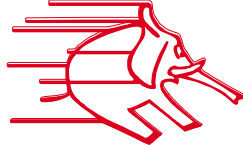
 NO PICTURE AVAILABLE	TT KIT n°	u.d.
	Maker	MERITOR
	OR kit n°	SP8999
	Description	guide pin
	Application	All these calipers

Models



JAVELIN MK111

From 1995



Maker	MERITOR
Wheel size	22.5"

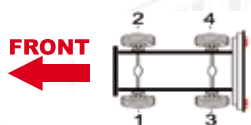

Calipers

Meritor part n°	TT n°	Side	OEM unit available
LRG550	93.05.003	1	YES
LRG551	93.05.004	2	YES

Repair kits

MORE KITS : [Page 214](#)

	<table border="1"> <tr> <td>TT KIT n°</td> <td>CMSK.7</td> </tr> <tr> <td>Maker</td> <td>MERITOR</td> </tr> <tr> <td>OR kit n°</td> <td>SJ4078</td> </tr> <tr> <td>Description</td> <td>Boots & Seals</td> </tr> <tr> <td>Application</td> <td>LRG550 LRG551</td> </tr> </table>	TT KIT n°	CMSK.7	Maker	MERITOR	OR kit n°	SJ4078	Description	Boots & Seals	Application	LRG550 LRG551		<table border="1"> <tr> <td>TT KIT n°</td> <td>CMSK.10/10.2</td> </tr> <tr> <td>Maker</td> <td>MERITOR</td> </tr> <tr> <td>OR kit n°</td> <td>SJ4113/4114</td> </tr> <tr> <td>Description</td> <td>Adjuster(L/R)</td> </tr> <tr> <td>Application</td> <td>LRG550 LRG551</td> </tr> </table>	TT KIT n°	CMSK.10/10.2	Maker	MERITOR	OR kit n°	SJ4113/4114	Description	Adjuster(L/R)	Application	LRG550 LRG551
TT KIT n°	CMSK.7																						
Maker	MERITOR																						
OR kit n°	SJ4078																						
Description	Boots & Seals																						
Application	LRG550 LRG551																						
TT KIT n°	CMSK.10/10.2																						
Maker	MERITOR																						
OR kit n°	SJ4113/4114																						
Description	Adjuster(L/R)																						
Application	LRG550 LRG551																						
	<table border="1"> <tr> <td>TT KIT n°</td> <td>CMSK.13</td> </tr> <tr> <td>Maker</td> <td>MERITOR</td> </tr> <tr> <td>OR kit n°</td> <td>SJ4076</td> </tr> <tr> <td>Description</td> <td>Guides & pins & sleeves</td> </tr> <tr> <td>Application</td> <td>LRG550 LRG551</td> </tr> </table>	TT KIT n°	CMSK.13	Maker	MERITOR	OR kit n°	SJ4076	Description	Guides & pins & sleeves	Application	LRG550 LRG551		<table border="1"> <tr> <td>TT KIT n°</td> <td>CMSK.14</td> </tr> <tr> <td>Maker</td> <td>MERITOR</td> </tr> <tr> <td>OR kit n°</td> <td>SJ4031</td> </tr> <tr> <td>Description</td> <td>Needle & roller bearings</td> </tr> <tr> <td>Application</td> <td>LRG550 LRG551</td> </tr> </table>	TT KIT n°	CMSK.14	Maker	MERITOR	OR kit n°	SJ4031	Description	Needle & roller bearings	Application	LRG550 LRG551
TT KIT n°	CMSK.13																						
Maker	MERITOR																						
OR kit n°	SJ4076																						
Description	Guides & pins & sleeves																						
Application	LRG550 LRG551																						
TT KIT n°	CMSK.14																						
Maker	MERITOR																						
OR kit n°	SJ4031																						
Description	Needle & roller bearings																						
Application	LRG550 LRG551																						
	<table border="1"> <tr> <td>TT KIT n°</td> <td>CMSK.15/15.1</td> </tr> <tr> <td>Maker</td> <td>MERITOR</td> </tr> <tr> <td>OR kit n°</td> <td>SJ4073/4074</td> </tr> <tr> <td>Description</td> <td>Adjuster tappet L/R</td> </tr> <tr> <td>Application</td> <td>LRG550 LRG551</td> </tr> </table>	TT KIT n°	CMSK.15/15.1	Maker	MERITOR	OR kit n°	SJ4073/4074	Description	Adjuster tappet L/R	Application	LRG550 LRG551		<table border="1"> <tr> <td>TT KIT n°</td> <td>CMSK.11.3</td> </tr> <tr> <td>Maker</td> <td>MERITOR</td> </tr> <tr> <td>OR kit n°</td> <td>Only TT</td> </tr> <tr> <td>Description</td> <td>Steel balls</td> </tr> <tr> <td>Application</td> <td>LRG550 LRG551</td> </tr> </table>	TT KIT n°	CMSK.11.3	Maker	MERITOR	OR kit n°	Only TT	Description	Steel balls	Application	LRG550 LRG551
TT KIT n°	CMSK.15/15.1																						
Maker	MERITOR																						
OR kit n°	SJ4073/4074																						
Description	Adjuster tappet L/R																						
Application	LRG550 LRG551																						
TT KIT n°	CMSK.11.3																						
Maker	MERITOR																						
OR kit n°	Only TT																						
Description	Steel balls																						
Application	LRG550 LRG551																						
	<table border="1"> <tr> <td>TT KIT n°</td> <td>CMSK.11.1/12.1</td> </tr> <tr> <td>Maker</td> <td>MERITOR</td> </tr> <tr> <td>OR kit n°</td> <td>Only TT</td> </tr> <tr> <td>Description</td> <td>Shaft</td> </tr> <tr> <td>Application</td> <td>LRG550 LRG551</td> </tr> </table>	TT KIT n°	CMSK.11.1/12.1	Maker	MERITOR	OR kit n°	Only TT	Description	Shaft	Application	LRG550 LRG551		<table border="1"> <tr> <td>TT KIT n°</td> <td>CMSK.11.2/12.2</td> </tr> <tr> <td>Maker</td> <td>MERITOR</td> </tr> <tr> <td>OR kit n°</td> <td>Only TT</td> </tr> <tr> <td>Description</td> <td>Shaft support</td> </tr> <tr> <td>Application</td> <td>LRG550 LRG551</td> </tr> </table>	TT KIT n°	CMSK.11.2/12.2	Maker	MERITOR	OR kit n°	Only TT	Description	Shaft support	Application	LRG550 LRG551
TT KIT n°	CMSK.11.1/12.1																						
Maker	MERITOR																						
OR kit n°	Only TT																						
Description	Shaft																						
Application	LRG550 LRG551																						
TT KIT n°	CMSK.11.2/12.2																						
Maker	MERITOR																						
OR kit n°	Only TT																						
Description	Shaft support																						
Application	LRG550 LRG551																						

Models



LANCE ZF AXLE

From 04.1992



FRONT

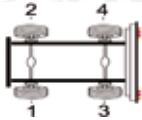

Maker	MERITOR
Wheel size	22.5"

Calipers

Meritor part n°	TT n°	Side	OEM unit available
LRG528	93.04.005	1	YES
LRG529	93.04.006	2	YES

Repair kits

MORE KITS : [Page 204](#)



TT KIT n°	CMSK.1
Maker	MERITOR
OR kit n°	SJ4001
Description	Guides & Seals
Application	LRG528 LRG529



TT KIT n°	CMSK.6
Maker	MERITOR
OR kit n°	SJ1212
Description	Cover & Boots
Application	LRG528 LRG529

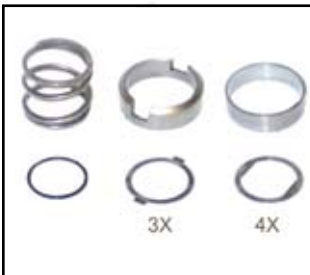

TT KIT n°	CMSK.24.3/25.3
Maker	MERITOR
OR kit n°	-
Description	Clutch mechanism
Application	LRG528 LRG529



TT KIT n°	CMSK.24.4/25.4
Maker	MERITOR
OR kit n°	-
Description	Adjuster tappet
Application	LRG528 LRG529



TT KIT n°	CMSK.28/29
Maker	MERITOR
OR kit n°	-
Description	Shaft
Application	LRG528 LRG529



TT KIT n°	CMSK.24.1/25.1
Maker	MERITOR
OR kit n°	-
Description	Support - spiral
Application	LRG528 LRG529



TT KIT n°	CMSK.24.2
Maker	MERITOR
OR kit n°	-
Description	Roller
Application	LRG528 LRG529



TT KIT n°	CMSK.24.7
Maker	MERITOR
OR kit n°	-
Description	Shaft Roller Bearing
Application	LRG528 LRG529

Models



TRIDENT II

From 2001

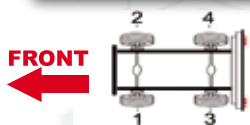

	TT KIT n°	WSSK.20.26
	OR kit n°	-
	Description	Wear Sensor

Maker	KNORR
Wheel size	22.5"
Angle of actuator	0°
Brake type	Axial
Wear sensor	In-pad, normally closed

Calipers

Knorr type n°	TT n°	Side	Knorr part n°	Knorr ration. n°
SB7919	91.03.004	1	K000553	SN7203
SB7909	91.03.005	2	K000552	SN7213
SB7211	91.03.052	3	K000486	SB7450
SB7201	91.03.051	4	K000485	SB7460

Repair kits

MORE KITS : [Page 192](#)



TT KIT n°	CKSK.6
Maker	KNORR
OR kit n°	K001532
Description	Guides & Seals (New)
Application	All SB...



TT KIT n°	CKSK.4 /4.2
Maker	KNORR
OR kit n°	K000944 / K001300
Description	Tappets
Application	All SB... All SN/NA/SK



TT KIT n°	CKSK.3.2
Maker	KNORR
OR kit n°	K000472
Description	Guide & Seals
Application	All SN...



TT KIT n°	CKSK.8
Maker	KNORR
OR kit n°	-
Description	Complete overhaul
Application	All SB... All SN...



TT KIT n°	CKSK.8.1
Maker	KNORR
OR kit n°	Only TT
Description	Guides & Seals
Application	All SB... All SN...



TT KIT n°	CKSK.16/16.1
Maker	KNORR
OR kit n°	Only TT
Description	Alu / Plastic cover
Application	All SB... All SN...



TT KIT n°	CKSK.10.3/10.4
Maker	KNORR
OR kit n°	-
Description	Adjusting Mechanism
Application	All SB... All SN...

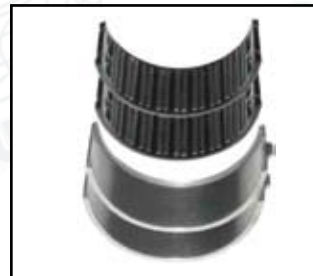

TT KIT n°	CKSK.14/14.1
Maker	KNORR
OR kit n°	-
Description	Roller Bearings
Application	All SB... All SN...

Models



ELITE

From 06.2002



FRONT



Calipers

Meritor part n°	TT n°	Side
LRG630	93.05.009	1-3
LRG631	93.05.010	2-4

Maker	MERITOR
Wheel size	22.5"

Repair kits

MORE KITS : [Page 208](#)

	TT KIT n° CMSK.7
Maker	MERITOR
OR kit n°	SJ4078
Description	Boots & Seals
Application	LRG630 LRG631

	TT KIT n° CMSK.10/10.2
Maker	MERITOR
OR kit n°	SJ4113/4114
Description	Adjuster(L/R)
Application	LRG630 LRG631

	TT KIT n° CMSK.13
Maker	MERITOR
OR kit n°	SJ4076
Description	Guides & pins & sleeves
Application	LRG630 LRG631

	TT KIT n° CMSK.14
Maker	MERITOR
OR kit n°	SJ4031
Description	Needle & roller bearings
Application	LRG630 LRG631

	TT KIT n° CMSK.15/15.1
Maker	MERITOR
OR kit n°	SJ4073/4074
Description	Adjuster tappet L/R
Application	LRG630 LRG631

	TT KIT n° CMSK.11.3
Maker	MERITOR
OR kit n°	Only TT
Description	Steel balls
Application	LRG630 LRG631

	TT KIT n° CMSK.11.1/12.1
Maker	MERITOR
OR kit n°	Only TT
Description	Shaft
Application	LRG630 LRG631

	TT KIT n° CMSK.11.2/12.2
Maker	MERITOR
OR kit n°	Only TT
Description	Shaft support
Application	LRG630 LRG631

Models



SABRE FIRE ENGINE

From 1995



Maker	MERITOR
Wheel size	22.5"

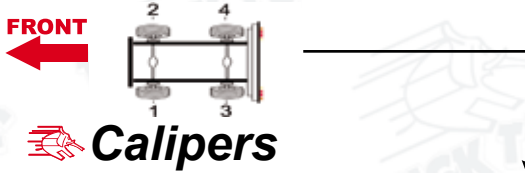

Calipers

Meritor part n°	TT n°	Side
LRG550	93.05.003	1
LRG551	93.05.004	2

Repair kits

MORE KITS : [Page 214](#)

	TT KIT n°	CMSK.7
	Maker	MERITOR
	OR kit n°	SJ4078
	Description	Boots & Seals
Application	LRG550 LRG551	

	TT KIT n°	CMSK.10/10.2
	Maker	MERITOR
	OR kit n°	SJ4113/4114
	Description	Adjuster (L/R)
Application	LRG550 LRG551	

	TT KIT n°	CMSK.13
	Maker	MERITOR
	OR kit n°	SJ4076
	Description	Guides & pins & sleeves
Application	LRG550 LRG551	

	TT KIT n°	CMSK.14
	Maker	MERITOR
	OR kit n°	SJ4031
	Description	Needle & roller bearings
Application	LRG550 LRG551	

	TT KIT n°	CMSK.15/15.1
	Maker	MERITOR
	OR kit n°	SJ4073/4074
	Description	Adjuster tappet L/R
Application	LRG550 LRG551	

	TT KIT n°	CMSK.11.3
	Maker	MERITOR
	OR kit n°	Only TT
	Description	Steel balls
Application	LRG550 LRG551	

	TT KIT n°	CMSK.11.1/12.1
	Maker	MERITOR
	OR kit n°	Only TT
	Description	Shaft
Application	LRG550 LRG551	

	TT KIT n°	CMSK.11.2/12.2
	Maker	MERITOR
	OR kit n°	Only TT
	Description	Shaft support
Application	LRG550 LRG551	

Models



CITARO

(8 wheels)

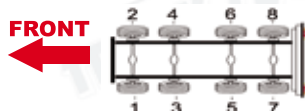

Maker	KNORR
Wheel size	22.5"
Angle of actuator	-12
brake type	Axial
Potentiometer	Continuous

Calipers

Knorr type n°	TT n°	Side	Knorr part n°	Knorr rationalised n°
SB7648	91.03.013	1-3-5-7	II32798	SN7211
SB7658	91.03.014	2-4-6-8	II32799	SN7201

Repair kits

MORE KITS : Page 192

	TT KIT n° CKSK.6 Maker KNORR OR kit n° K001532 Description Guides & Seals (New) Application All SB...		TT KIT n° CKSK.4 /4.2 Maker KNORR OR kit n° K000944 / K001300 Description Tappets Application All SB... All SN/NA/SK
	TT KIT n° CKSK.3.2 Maker KNORR OR kit n° K000472 Description Guide & Seals Application All SN...		TT KIT n° CKSK.8 Maker KNORR OR kit n° - Description Complete overhaul Application All SB... All SN...
	TT KIT n° CKSK.8.1 Maker KNORR OR kit n° Only TT Description Guides & Seals Application All SB... All SN...		TT KIT n° CKSK.16/16.1 Maker KNORR OR kit n° Only TT Description Alu / Plastic cover Application All SB... All SN...
	TT KIT n° CKSK.10.3/10.4 Maker KNORR OR kit n° - Description Adjusting Mechanism Application All SB... All SN...		TT KIT n° CKSK.14/14.1 Maker KNORR OR kit n° - Description Roller Bearings Application All SB... All SN...

Models



CITARO

(6 wheels)



Calipers

	Knorr type n°	TT n°	Side	Knorr part n°	Knorr ratio. n°
1	SB7648	91.03.013	1	II32798	SN7211
1	SB7658	91.03.014	2	II32799	SN7201
2	SB7190	91.03.054	3-5	Z0021122	SB7451
2	SB7180	91.03.053	4-6	Z0021121	SB7461

1.



Front

Wheel size	22.5"
Angle of actuator	-12°
Brake type	Axial
Potentiometer	Continuous

2.



Rear

Wheel size	22.5"
Angle of actuator	+93°
Brake type	Radial
Potentiometer	Continuous

Repair kits

MORE KITS : Page 192

	<p>TT KIT n° CKSK.6</p> <p>Maker KNORR</p> <p>OR kit n° K001532</p> <p>Description Guides & Seals (New)</p> <p>Application All SB...</p>		<p>TT KIT n° CKSK.4 /4.2</p> <p>Maker KNORR</p> <p>OR kit n° K000944 / K001300</p> <p>Description Tappets</p> <p>Application All SB... AIISN/NA/SK</p>
	<p>TT KIT n° CKSK.3.2</p> <p>Maker KNORR</p> <p>OR kit n° K000472</p> <p>Description Guide & Seals</p> <p>Application All SN...</p>		<p>TT KIT n° CKSK.8</p> <p>Maker KNORR</p> <p>OR kit n° -</p> <p>Description Complete overhaul</p> <p>Application All SB... All SN...</p>
	<p>TT KIT n° CKSK.8.1</p> <p>Maker KNORR</p> <p>OR kit n° Only TT</p> <p>Description Guides & Seals</p> <p>Application All SB... All SN...</p>		<p>TT KIT n° CKSK.16/16.1</p> <p>Maker KNORR</p> <p>OR kit n° Only TT</p> <p>Description Alu / Plastic cover</p> <p>Application All SB... All SN...</p>
	<p>TT KIT n° CKSK.10.3/10.4</p> <p>Maker KNORR</p> <p>OR kit n° -</p> <p>Description Adjusting Mechanism</p> <p>Application All SB... All SN...</p>		<p>TT KIT n° CKSK.14/14.1</p> <p>Maker KNORR</p> <p>OR kit n° -</p> <p>Description Roller Bearings</p> <p>Application All SB... All SN...</p>

Models



CITO

From 01.1998



FRONT



Calipers

Maker	KNORR
Wheel size	22.5"
Angle of actuator	0°
Brake type	Axial
Potentiometer	Continuous

Knorr type n°	TT n°	Side	Knorr part n°	Knorr rationalised n°
SB7648	91.03.013	1	II32798	SN7211
SB7658	91.03.014	2	II32799	SN7201
SB7780	91.03.023	3	II37231	SN7216
SB7790	91.03.024	4	II37232	SN7206

Repair kits

MORE KITS : Page 192

	<table border="1"> <tr> <td>TT KIT n°</td> <td>CKSK.6</td> </tr> <tr> <td>Maker</td> <td>KNORR</td> </tr> <tr> <td>OR kit n°</td> <td>K001532</td> </tr> <tr> <td>Description</td> <td>Guides & Seals (New)</td> </tr> <tr> <td>Application</td> <td>All SB...</td> </tr> </table>	TT KIT n°	CKSK.6	Maker	KNORR	OR kit n°	K001532	Description	Guides & Seals (New)	Application	All SB...		<table border="1"> <tr> <td>TT KIT n°</td> <td>CKSK.4 /4.2</td> </tr> <tr> <td>Maker</td> <td>KNORR</td> </tr> <tr> <td>OR kit n°</td> <td>K000944 / K001300</td> </tr> <tr> <td>Description</td> <td>Tappets</td> </tr> <tr> <td>Application</td> <td>All SB... All SN/NA/SK</td> </tr> </table>	TT KIT n°	CKSK.4 /4.2	Maker	KNORR	OR kit n°	K000944 / K001300	Description	Tappets	Application	All SB... All SN/NA/SK
TT KIT n°	CKSK.6																						
Maker	KNORR																						
OR kit n°	K001532																						
Description	Guides & Seals (New)																						
Application	All SB...																						
TT KIT n°	CKSK.4 /4.2																						
Maker	KNORR																						
OR kit n°	K000944 / K001300																						
Description	Tappets																						
Application	All SB... All SN/NA/SK																						
	<table border="1"> <tr> <td>TT KIT n°</td> <td>CKSK.3.2</td> </tr> <tr> <td>Maker</td> <td>KNORR</td> </tr> <tr> <td>OR kit n°</td> <td>K000472</td> </tr> <tr> <td>Description</td> <td>Guide & Seals</td> </tr> <tr> <td>Application</td> <td>All SN...</td> </tr> </table>	TT KIT n°	CKSK.3.2	Maker	KNORR	OR kit n°	K000472	Description	Guide & Seals	Application	All SN...		<table border="1"> <tr> <td>TT KIT n°</td> <td>CKSK.8</td> </tr> <tr> <td>Maker</td> <td>KNORR</td> </tr> <tr> <td>OR kit n°</td> <td>-</td> </tr> <tr> <td>Description</td> <td>Complete overhaul</td> </tr> <tr> <td>Application</td> <td>All SB... All SN...</td> </tr> </table>	TT KIT n°	CKSK.8	Maker	KNORR	OR kit n°	-	Description	Complete overhaul	Application	All SB... All SN...
TT KIT n°	CKSK.3.2																						
Maker	KNORR																						
OR kit n°	K000472																						
Description	Guide & Seals																						
Application	All SN...																						
TT KIT n°	CKSK.8																						
Maker	KNORR																						
OR kit n°	-																						
Description	Complete overhaul																						
Application	All SB... All SN...																						
	<table border="1"> <tr> <td>TT KIT n°</td> <td>CKSK.8.1</td> </tr> <tr> <td>Maker</td> <td>KNORR</td> </tr> <tr> <td>OR kit n°</td> <td>Only TT</td> </tr> <tr> <td>Description</td> <td>Guides & Seals</td> </tr> <tr> <td>Application</td> <td>All SB... All SN...</td> </tr> </table>	TT KIT n°	CKSK.8.1	Maker	KNORR	OR kit n°	Only TT	Description	Guides & Seals	Application	All SB... All SN...		<table border="1"> <tr> <td>TT KIT n°</td> <td>CKSK.16/16.1</td> </tr> <tr> <td>Maker</td> <td>KNORR</td> </tr> <tr> <td>OR kit n°</td> <td>Only TT</td> </tr> <tr> <td>Description</td> <td>Alu / Plastic cover</td> </tr> <tr> <td>Application</td> <td>All SB... All SN...</td> </tr> </table>	TT KIT n°	CKSK.16/16.1	Maker	KNORR	OR kit n°	Only TT	Description	Alu / Plastic cover	Application	All SB... All SN...
TT KIT n°	CKSK.8.1																						
Maker	KNORR																						
OR kit n°	Only TT																						
Description	Guides & Seals																						
Application	All SB... All SN...																						
TT KIT n°	CKSK.16/16.1																						
Maker	KNORR																						
OR kit n°	Only TT																						
Description	Alu / Plastic cover																						
Application	All SB... All SN...																						
	<table border="1"> <tr> <td>TT KIT n°</td> <td>CKSK.10.3/10.4</td> </tr> <tr> <td>Maker</td> <td>KNORR</td> </tr> <tr> <td>OR kit n°</td> <td>-</td> </tr> <tr> <td>Description</td> <td>Adjusting Mechanism</td> </tr> <tr> <td>Application</td> <td>All SB... All SN...</td> </tr> </table>	TT KIT n°	CKSK.10.3/10.4	Maker	KNORR	OR kit n°	-	Description	Adjusting Mechanism	Application	All SB... All SN...		<table border="1"> <tr> <td>TT KIT n°</td> <td>CKSK.14/14.1</td> </tr> <tr> <td>Maker</td> <td>KNORR</td> </tr> <tr> <td>OR kit n°</td> <td>-</td> </tr> <tr> <td>Description</td> <td>Roller Bearings</td> </tr> <tr> <td>Application</td> <td>All SB... All SN...</td> </tr> </table>	TT KIT n°	CKSK.14/14.1	Maker	KNORR	OR kit n°	-	Description	Roller Bearings	Application	All SB... All SN...
TT KIT n°	CKSK.10.3/10.4																						
Maker	KNORR																						
OR kit n°	-																						
Description	Adjusting Mechanism																						
Application	All SB... All SN...																						
TT KIT n°	CKSK.14/14.1																						
Maker	KNORR																						
OR kit n°	-																						
Description	Roller Bearings																						
Application	All SB... All SN...																						

Models



Integro (12M)

Integro M

Integro L



Maker	MERITOR
Wheel size	22.5"



Calipers

Meritor part n°	TT n°	Side
LRG562	93.04.009	1
LRG563	93.04.010	2

Repair kits

MORE KITS : Page 194

	TT KIT n°	CMSK.1
	Maker	MERITOR
	OR kit n°	SJ4001
	Description	Guides & Seals
	Application	LRG.562 LRG.563

	TT KIT n°	CMSK.6
	Maker	MERITOR
	OR kit n°	SJ1212
	Description	Cover & Boots
	Application	LRG.562 LRG.563

	TT KIT n°	CMSK.24.3/25.3
	Maker	MERITOR
	OR kit n°	Only TT
	Description	Clutch mechanism
	Application	LRG.562 LRG.563

	TT KIT n°	CMSK.24.4/25.4
	Maker	MERITOR
	OR kit n°	Only TT
	Description	Adjuster tappet
	Application	LRG.562 LRG.563

	TT KIT n°	CMSK.28/29
	Maker	MERITOR
	OR kit n°	Only TT
	Description	Shaft
	Application	LRG.562 LRG.563

	TT KIT n°	CMSK.24.1/25.1
	Maker	MERITOR
	OR kit n°	Only TT
	Description	Support - spiral
	Application	LRG.562 LRG.563

	TT KIT n°	CMSK.24.2
	Maker	MERITOR
	OR kit n°	-
	Description	Roller
	Application	LRG.562 LRG.563

Models



S3...

From 01.1996 To 06.1996

FRONT



Calipers



TT KIT ref.	WSSK.20.12
OR kit n°	82853884510
Description	Wear Sensor

1.

Front



Wheel size	22.5"
Angle of actuator	0°
Brake type	Axial
Wear sensor	In-Pad

2.

Rear



Wheel size	22.5"
Angle of actuator	+86°
Brake type	Radial
Wear sensor	In-Pad

Repair kits

MORE KITS : Page 192



TT KIT n°	CKSK.6
Maker	KNORR
OR kit n°	K001532
Description	Guides & Seals (New)
Application	All SB...



TT KIT n°	CKSK.4 /4.2
Maker	KNORR
OR kit n°	K000944 / K001300
Description	Tappets
Application	All SB... All SN/NA/SK



TT KIT n°	CKSK.3.2
Maker	KNORR
OR kit n°	K000472
Description	Guide & Seals
Application	All SN...



TT KIT n°	CKSK.8
Maker	KNORR
OR kit n°	-
Description	Complete overhaul
Application	All SB... All SN...



TT KIT n°	CKSK.8.1
Maker	KNORR
OR kit n°	Only TT
Description	Guides & Seals
Application	All SB... All SN...



TT KIT n°	CKSK.16/16.1
Maker	KNORR
OR kit n°	Only TT
Description	Alu / Plastic cover
Application	All SB... All SN...



TT KIT n°	CKSK.10.3/10.4
Maker	KNORR
OR kit n°	-
Description	Adjusting Mechanism
Application	All SB... All SN...

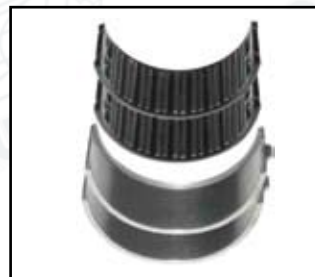

TT KIT n°	CKSK.14/14.1
Maker	KNORR
OR kit n°	-
Description	Roller Bearings
Application	All SB... All SN...

Models



S3...

From 07.1996 To 01.1999

CITYBUS A20 From 1999

FRONT

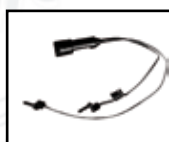

TT KIT ref.	WSSK.20.12
OR kit n°	82853884510
Description	Wear Sensor

Calipers

	Knorr type n°	TT n°	Side	Knorr part n°	Knorr ratio. n°
1	SB7790	91.03.024	1	II37232	SN7213
1	SB7780	91.03.023	2	II37231	SN7203
2	SB7150	91.03.052	3-5	II38649	SB7450
2	SB7140	91.03.051	4-6	II38648	SB7460

1.



Front

Wheel size	22.5"
Angle of actuator	0°
Brake type	Axial
Wear sensor	In-Pad

2.



Rear

Wheel size	22.5"
Angle of actuator	+93°
Brake type	Radial
Wear sensor	In-Pad

Repair kits

MORE KITS : Page 192



TT KIT n°	CKSK.6
Maker	KNORR
OR kit n°	K001532
Description	Guides & Seals (New)
Application	All SB...



TT KIT n°	CKSK.4 / 4.2
Maker	KNORR
OR kit n°	K000944 / K001300
Description	Tappets
Application	All SB... AIISN/NA/SK



TT KIT n°	CKSK.3.2
Maker	KNORR
OR kit n°	K000472
Description	Guide & Seals
Application	All SN...



TT KIT n°	CKSK.8
Maker	KNORR
OR kit n°	-
Description	Complete overhaul
Application	All SB... All SN...



TT KIT n°	CKSK.8.1
Maker	KNORR
OR kit n°	Only TT
Description	Guides & Seals
Application	All SB... All SN...



TT KIT n°	CKSK.16/16.1
Maker	KNORR
OR kit n°	Only TT
Description	Alu / Plastic cover
Application	All SB... All SN...



TT KIT n°	CKSK.10.3/10.4
Maker	KNORR
OR kit n°	-
Description	Adjusting Mechanism
Application	All SB... All SN...



TT KIT n°	CKSK.14/14.1
Maker	KNORR
OR kit n°	-
Description	Roller Bearings
Application	All SB... All SN...

Models



S316HDS

From 01.1995

S328DT

From 01.1995



Maker	KNORR
Wheel size	22.5"
Angle of actuator	-12°
Brake type	Axial
Wear sensor	In-Pad normally closed

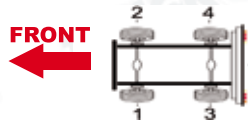

Calipers

TT KIT ref.	WSSK.20.12
OR kit n°	82853884510
Description	Wear Sensor

Knorr type n°	TT n°	Side	Knorr part n°	Knorr rationalised n°
SB7712	91.03.001	1	II34326	SN7199
SB7702	91.03.002	2	II34325	SN7189

Repair kits

MORE KITS : Page 192

<p>145 mm 34x80 mm 150 mm 85 mm</p>	<table border="1"> <tr> <td>TT KIT n°</td> <td>CKSK.1</td> </tr> <tr> <td>Maker</td> <td>KNORR</td> </tr> <tr> <td>OR kit n°</td> <td>II328090062</td> </tr> <tr> <td>Description</td> <td>Guides & Seals</td> </tr> <tr> <td>Application</td> <td>All SB...</td> </tr> </table>	TT KIT n°	CKSK.1	Maker	KNORR	OR kit n°	II328090062	Description	Guides & Seals	Application	All SB...		<table border="1"> <tr> <td>TT KIT n°</td> <td>CKSK.4 /4.2</td> </tr> <tr> <td>Maker</td> <td>KNORR</td> </tr> <tr> <td>OR kit n°</td> <td>K000944 / K001300</td> </tr> <tr> <td>Description</td> <td>Tappets</td> </tr> <tr> <td>Application</td> <td>All SB... All SN/NA/SK</td> </tr> </table>	TT KIT n°	CKSK.4 /4.2	Maker	KNORR	OR kit n°	K000944 / K001300	Description	Tappets	Application	All SB... All SN/NA/SK
TT KIT n°	CKSK.1																						
Maker	KNORR																						
OR kit n°	II328090062																						
Description	Guides & Seals																						
Application	All SB...																						
TT KIT n°	CKSK.4 /4.2																						
Maker	KNORR																						
OR kit n°	K000944 / K001300																						
Description	Tappets																						
Application	All SB... All SN/NA/SK																						
<p>114 mm 85 mm 32x80 mm 80 mm</p>	<table border="1"> <tr> <td>TT KIT n°</td> <td>CKSK.6</td> </tr> <tr> <td>Maker</td> <td>KNORR</td> </tr> <tr> <td>OR kit n°</td> <td>K001532</td> </tr> <tr> <td>Description</td> <td>Guides & Seals (New)</td> </tr> <tr> <td>Application</td> <td>All SB...</td> </tr> </table>	TT KIT n°	CKSK.6	Maker	KNORR	OR kit n°	K001532	Description	Guides & Seals (New)	Application	All SB...		<table border="1"> <tr> <td>TT KIT n°</td> <td>CKSK.8</td> </tr> <tr> <td>Maker</td> <td>KNORR</td> </tr> <tr> <td>OR kit n°</td> <td>-</td> </tr> <tr> <td>Description</td> <td>Complete overhaul</td> </tr> <tr> <td>Application</td> <td>All SB... All SN...</td> </tr> </table>	TT KIT n°	CKSK.8	Maker	KNORR	OR kit n°	-	Description	Complete overhaul	Application	All SB... All SN...
TT KIT n°	CKSK.6																						
Maker	KNORR																						
OR kit n°	K001532																						
Description	Guides & Seals (New)																						
Application	All SB...																						
TT KIT n°	CKSK.8																						
Maker	KNORR																						
OR kit n°	-																						
Description	Complete overhaul																						
Application	All SB... All SN...																						
<p>32x80 mm 80 mm 114 mm 85 mm</p>	<table border="1"> <tr> <td>TT KIT n°</td> <td>CKSK.8.1</td> </tr> <tr> <td>Maker</td> <td>KNORR</td> </tr> <tr> <td>OR kit n°</td> <td>Only TT</td> </tr> <tr> <td>Description</td> <td>Guides & Seals</td> </tr> <tr> <td>Application</td> <td>All SB... All SN...</td> </tr> </table>	TT KIT n°	CKSK.8.1	Maker	KNORR	OR kit n°	Only TT	Description	Guides & Seals	Application	All SB... All SN...		<table border="1"> <tr> <td>TT KIT n°</td> <td>CKSK.16/16.1</td> </tr> <tr> <td>Maker</td> <td>KNORR</td> </tr> <tr> <td>OR kit n°</td> <td>Only TT</td> </tr> <tr> <td>Description</td> <td>Alu / Plastic cover</td> </tr> <tr> <td>Application</td> <td>All SB... All SN...</td> </tr> </table>	TT KIT n°	CKSK.16/16.1	Maker	KNORR	OR kit n°	Only TT	Description	Alu / Plastic cover	Application	All SB... All SN...
TT KIT n°	CKSK.8.1																						
Maker	KNORR																						
OR kit n°	Only TT																						
Description	Guides & Seals																						
Application	All SB... All SN...																						
TT KIT n°	CKSK.16/16.1																						
Maker	KNORR																						
OR kit n°	Only TT																						
Description	Alu / Plastic cover																						
Application	All SB... All SN...																						
	<table border="1"> <tr> <td>TT KIT n°</td> <td>CKSK.10.3/10.4</td> </tr> <tr> <td>Maker</td> <td>KNORR</td> </tr> <tr> <td>OR kit n°</td> <td>-</td> </tr> <tr> <td>Description</td> <td>Adjusting Mechanism</td> </tr> <tr> <td>Application</td> <td>All SB... All SN...</td> </tr> </table>	TT KIT n°	CKSK.10.3/10.4	Maker	KNORR	OR kit n°	-	Description	Adjusting Mechanism	Application	All SB... All SN...	<p>114 mm 85 mm 32 x 80 mm 80 mm</p>	<table border="1"> <tr> <td>TT KIT n°</td> <td>CKSK.3.2</td> </tr> <tr> <td>Maker</td> <td>KNORR</td> </tr> <tr> <td>OR kit n°</td> <td>K000472</td> </tr> <tr> <td>Description</td> <td>Guide & Seals</td> </tr> <tr> <td>Application</td> <td>All SN...</td> </tr> </table>	TT KIT n°	CKSK.3.2	Maker	KNORR	OR kit n°	K000472	Description	Guide & Seals	Application	All SN...
TT KIT n°	CKSK.10.3/10.4																						
Maker	KNORR																						
OR kit n°	-																						
Description	Adjusting Mechanism																						
Application	All SB... All SN...																						
TT KIT n°	CKSK.3.2																						
Maker	KNORR																						
OR kit n°	K000472																						
Description	Guide & Seals																						
Application	All SN...																						

Models



TRAVEGO

From 06.1999

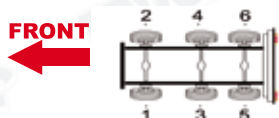

Maker	KNORR
Wheel size	22.5"
1. Angle of actuator	- 12°
2. Angle of actuator	+12°
3. Angle of actuator	0°
Brake type	Axial
Potentiometer	Continuous

Calipers

	Knorr type n°	TT n°	Side	Knorr part n°	Knorr rationalised n°
1	SB7760	91.03.013	1	II36999	SN7211
1	SB7770	91.03.014	2	II37000	SN7201
2	SB7766	91.03.045	3	II37070	SB7432
2	SB7776	91.03.046	4	II37071	SB7422
3	SB7780	91.03.023	5	II37231	SN7216
3	SB7790	91.03.024	6	II37232	SN7206

Repair kits

MORE KITS : Page 192

	TT KIT n° CKSK.6 Maker KNORR OR kit n° K001532 Description Guides & Seals (New) Application All SB...		TT KIT n° CKSK.4 /4.2 Maker KNORR OR kit n° K000944 / K001300 Description Tappets Application All SB... AIISN/NA/SK
	TT KIT n° CKSK.3.2 Maker KNORR OR kit n° K000472 Description Guide & Seals Application All SN...		TT KIT n° CKSK.8 Maker KNORR OR kit n° - Description Complete overhaul Application All SB... All SN...
	TT KIT n° CKSK.8.1 Maker KNORR OR kit n° Only TT Description Guides & Seals Application All SB... All SN...		TT KIT n° CKSK.16/16.1 Maker KNORR OR kit n° Only TT Description Alu / Plastic cover Application All SB... All SN...

Models



CARGO 0608

From 03.1987(Rear Cal. Piston Ø 58mm)

CARGO 0815

From 03.1987(Rear Cal. Piston Ø 58mm)

1.



Maker	MERITOR
Wheel size	17.5"(FRONT)

2.



Maker	MERITOR
Wheel size	17.5"(REAR)

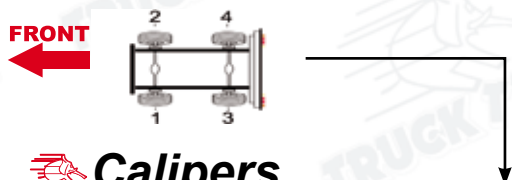

Calipers

	Meritor part n°	TT n°	Side
1	LRG500	93.01.023	1
1	LRG501	93.01.024	2
2	LRG600	93.02.015	3
2	LRG601	93.02.016	4

Repair kits

<p>NO PICTURE AVAILABLE</p>	TT KIT n°	U.D.
	Maker	MERITOR
	OR kit n°	SJ1091
	Description	Auto adjuster
	Application	LRG600 LRG610

<p>NO PICTURE AVAILABLE</p>	TT KIT n°	U.D.
	Maker	MERITOR
	OR kit n°	SP8564
	Description	Overhaul sealing
	Application	LRG500 LRG501

<p>NO PICTURE AVAILABLE</p>	TT KIT n°	U.D.
	Maker	MERITOR
	OR kit n°	SP8565
	Description	Guide pin
	Application	All these calipers

<p>NO PICTURE AVAILABLE</p>	TT KIT n°	U.D.
	Maker	MERITOR
	OR kit n°	SP8570
	Description	Hand brake
	Application	LRG600 LRG601

<p>NO PICTURE AVAILABLE</p>	TT KIT n°	U.D.
	Maker	MERITOR
	OR kit n°	SP9669
	Description	Overhaul sealing
	Application	LRG600 LRG601

Models



CARGO 0608

From 03.1987(Rear Cal. Piston Ø 68mm)

CARGO 0815

From 03.1987(Rear Cal. Piston Ø 68mm)

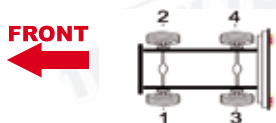

Calipers

	Meritor part n°	TT n°	Side
1	LRG500	93.01.023	1
1	LRG501	93.01.024	2
2	LRG602	93.02.011	3
2	LRG603	93.02.012	4

1.



Maker	MERITOR
Wheel size	17.5"(FRONT)

2.



Maker	MERITOR
Wheel size	17.5"(REAR)

Repair kits

 NO PICTURE AVAILABLE	TT KIT n°	U.D.	 NO PICTURE AVAILABLE	TT KIT n°	U.D.
	Maker	MERITOR		Maker	MERITOR
	OR kit n°	SJ1092		OR kit n°	SP8564
	Description	Auto adjuster		Description	Overhaul sealing
	Application	LRG602 LRG603		Application	LRG500 LRG501
 NO PICTURE AVAILABLE	TT KIT n°	U.D.	 NO PICTURE AVAILABLE	TT KIT n°	U.D.
	Maker	MERITOR		Maker	MERITOR
	OR kit n°	SP8565		OR kit n°	SP8566
	Description	Guide pin		Description	Cover
	Application	All these calipers		Application	LRG602 LRG603
 NO PICTURE AVAILABLE	TT KIT n°	U.D.	 NO PICTURE AVAILABLE	TT KIT n°	U.D.
	Maker	MERITOR		Maker	MERITOR
	OR kit n°	SP8570		OR kit n°	SP9670
	Description	Hand brake		Description	Overhaul sealing
	Application	LRG600 LRG601		Application	LRG602 LRG603

Models



Ø 17.5" wheels

From 1998 to 2000

Ø 19.5" wheels

From 1998

Ø 22.5" wheels

Wheel size	17.5"
Brake type	Axial
Potentiometer	On/Off

1.



Wheel size	19.5"
Brake type	Axial
Wear sensor	In pad

2.



Wheel size	22.5"
Brake type	Axial
Wear sensor	In pad

3.

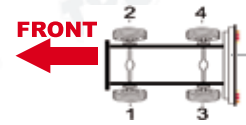

TT KIT n°	WSSK.20.29
OR kit n°	Z0008242
Description	Wear Sensor

Calipers

	Knorr type n°	TT n°	Side	Knorr part n°	Knorr rationalised n°
1	SB5003(17.5"/+12°)	91.01.004	1	II31034	SN5006
1	SB5013(17.5"/+12)	91.01.003	2	II31035	SN5016
2	SB6567(19.5"/+5°)	91.02.001	1	K000300	SN6563
2	SB6577(19.5"/+5°)	91.02.002	2	K000301	SN6573
3	SB7929(22.5"/-12°)	91.03.001	1	K000822	SN7195
3	SB7939(22.5"/-12°)	91.03.002	2	K000823	SN7185

Repair kits

MORE KITS : [Page 188](#)

	TT KIT n°	CKSK.6
	Maker	KNORR
	OR kit n°	K001532
	Description	Guides & Seals (New)
	Application	All SB...

	TT KIT n°	CKSK.4 / 4.2
	Maker	KNORR
	OR kit n°	K000944 / K001300
	Description	Tappets
	Application	All SB... All SN/NA/SK

	TT KIT n°	CKSK.3.2
	Maker	KNORR
	OR kit n°	K000472
	Description	Guide & Seals
	Application	All SN...

	TT KIT n°	CKSK.8
	Maker	KNORR
	OR kit n°	Only TT
	Description	Complete overhaul
	Application	All SB... All SN...

	TT KIT n°	CKSK.8.1
	Maker	KNORR
	OR kit n°	Only TT
	Description	Guides & Seals
	Application	All SB... All SN...

	TT KIT n°	CKSK.16/16.1
	Maker	KNORR
	OR kit n°	Only TT
	Description	Alu / Plastic cover
	Application	All SB... All SN...

Models



BUS (RABA axle)

From 1993



Maker	MERITOR
Wheel size	22.5"

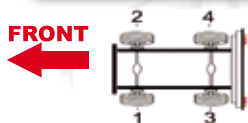

Calipers

Meritor part n°	TT n°	Side
LRG562	93.04.009	1-3
LRG563	93.04.010	2-4

Repair kits

MORE KITS : [Page 214](#)

	TT KIT n°	CMSK.1
	Maker	MERITOR
	OR kit n°	SJ4001
	Description	Guides & Seals
	Application	LRG562 LRG563

	TT KIT n°	CMSK.6
	Maker	MERITOR
	OR kit n°	SJ1212
	Description	Cover & Boots
	Application	LRG562 LRG563

	TT KIT n°	CMSK.24.3/25.3
	Maker	MERITOR
	OR kit n°	Only TT
	Description	Clutch mechanism
	Application	LRG562 LRG563

	TT KIT n°	CMSK.24.4/25.4
	Maker	MERITOR
	OR kit n°	Only TT
	Description	Adjuster tappet
	Application	LRG562 LRG563

	TT KIT n°	CMSK.28/29
	Maker	MERITOR
	OR kit n°	Only TT
	Description	Shaft
	Application	LRG562 LRG563

	TT KIT n°	CMSK.24.1/25.1
	Maker	MERITOR
	OR kit n°	Only TT
	Description	Support - spiral
	Application	LRG562 LRG563

	TT KIT n°	CMSK.24.2
	Maker	MERITOR
	OR kit n°	-
	Description	Roller
	Application	LRG562 LRG563

	TT KIT n°	CMSK.24.7
	Maker	MERITOR
	OR kit n°	-
	Description	Shaft Roller Bearing
	Application	LRG562 LRG563

Models



AGORA

From 11.1997

FRONT



Calipers

	TT KIT n°	WSSK.20.32
	OR kit n°	5001848363
	Description	Wear Sensor

1.



Maker	MERITOR
Wheel size	22.5"

2.



Maker	MERITOR
Wheel size	22.5"

	Meritor part n°	TT n°	Side
1	LRG548	93.05.001	1
1	LRG549	93.05.002	2
2	LRG642	93.08.007	3
2	LRG643	93.08.008	4

Repair kits

MORE KITS : [Page 214](#)

	TT KIT n°	CMSK.5
	Maker	MERITOR
	OR kit n°	MCK1102
	Description	Guides & bushes
	Application	LRG642 LRG643

	TT KIT n°	CMSK.3.3
	Maker	MERITOR
	OR kit n°	SJ4112
	Description	Half bearing
	Application	LRG642 LRG643

	TT KIT n°	CMSK.10/10.2
	Maker	MERITOR
	OR kit n°	SJ4113/ 4114
	Description	Adjuster(L/R)
	Application	LRG548 LRG549

	TT KIT n°	CMSK.13
	Maker	MERITOR
	OR kit n°	SJ4076
	Description	Guides , pins & Sleeves
	Application	LRG548 LRG549

	TT KIT n°	CMSK.14
	Maker	MERITOR
	OR kit n°	SJ4131
	Description	Needle & roller bearings
	Application	LRG548 LRG549

	TT KIT n°	CMSK.15/15.1
	Maker	MERITOR
	OR kit n°	SJ4073/ 4074
	Description	Adjuster tappet L/R
	Application	LRG548 LRG549

	TT KIT n°	CMSK.11.1/12.1
	Maker	MERITOR
	OR kit n°	Only TT
	Description	Shaft
	Application	LRG548 LRG549

	TT KIT n°	CMSK.11.3
	Maker	MERITOR
	OR kit n°	Only TT
	Description	Steel balls
	Application	LRG548 LRG549

Models



ARES



Maker	MERITOR
Wheel size	22.5"

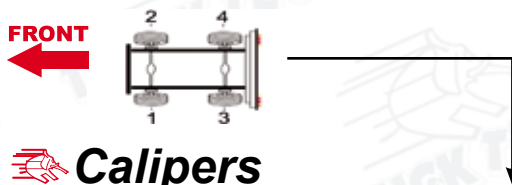

Calipers

Meritor part n°	TT n°	Side
LRG658	93.08.021	1
LRG659	93.08.022	2

Repair kits

	TT KIT n°	CMSK.26
	Maker	MERITOR
	OR kit n°	MCK1243
	Description	Guide & Pin
	Application	LRG658 LRG659

	TT KIT n°	CMSK.8.13
	Maker	MERITOR
	OR kit n°	MCK1240
	Description	Visual Wear Assy
	Application	LRG658 LRG659

Models



CRONUS

FROM 10.1998

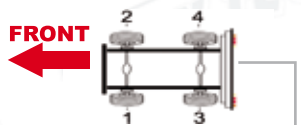

	TT KIT n°	WSSK.20.27
	OR kit n°	68324613
	Description	Wear Sensor

Maker	MERITOR
Wheel size	22.5"

Calipers

Meritor part n°	TT n°	Side
LRG642	93.08.007	3
LRG643	93.08.008	4

Repair kits

MORE KITS : [Page 208](#)

	TT KIT n°	CMSG.5
	Maker	MERITOR
	OR kit n°	MCK1102
	Description	Guides & bushes
Application	LRG642 LRG643	

	TT KIT n°	CMSG.3.3
	Maker	MERITOR
	OR kit n°	SJ4112
	Description	Half bearings
Application	LRG642 LRG643	

	TT KIT n°	CMSG.5.2
	Maker	MERITOR
	OR kit n°	
	Description	Small gear mechanism (left)
Application	LRG642 LRG643	

	TT KIT n°	CMSG.5.3
	Maker	MERITOR
	OR kit n°	
	Description	Small gear mechanism (right)
Application	LRG642 LRG643	

	TT KIT n°	CMSG.5.4
	Maker	MERITOR
	OR kit n°	
	Description	Locking shim
Application	LRG642 LRG643	

Models



CHRONOS CITY BUS

(with ZF axle 4472035965)

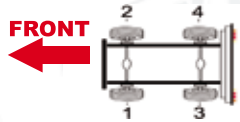
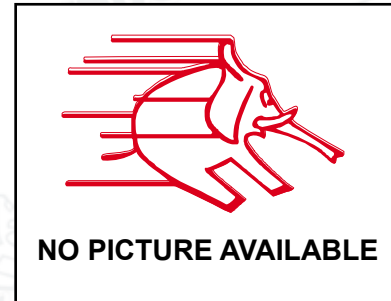

Maker	MERITOR
Wheel size	22.5"

Calipers

Meritor part n°	TT n°	Side
LRG642	93.09.023	1
LRG643	93.09.024	2

Models



CRONUS CITY BUS
(ZF axle 4472035965)



FRONT
←

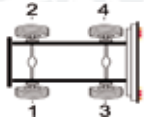

Calipers

Meritor part n°	TT n°	Side
LRG752	93.09.023	1
LRG753	93.09.024	2

Maker	MERITOR
Wheel size	22.5"

IRISBUS

General catalogue HEAVY DUTY VEHICLES

Models



Iliade - Ares
(ZF axle 4472035965)



FRONT

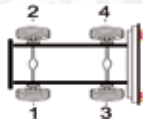

Maker	MERITOR
Wheel size	22.5"

Calipers

Meritor part n°	TT n°	Side
LRG712	93.09.015	1
LRG713	93.09.016	2

Models



R312











Calipers

Maker	BREMBO
Wheel size	19.5"

Brembo part n°	TT n°	Side
20.5320.12	95.02.001	1
20.5320.22	95.02.002	2
20.5320.32	95.02.003	3
20.5320.42	95.02.004	4
22.5400.30	95.11.001	Handbrake

Repair kits

	<table border="1"> <tr> <td>TT KIT n°</td> <td>CBRSK.1</td> </tr> <tr> <td>Maker</td> <td>BREMBO</td> </tr> <tr> <td>OR kit n°</td> <td>-</td> </tr> <tr> <td>Description</td> <td>Pistons</td> </tr> <tr> <td>Application</td> <td>20.5320.12/ 22/32/42</td> </tr> </table>	TT KIT n°	CBRSK.1	Maker	BREMBO	OR kit n°	-	Description	Pistons	Application	20.5320.12/ 22/32/42		<table border="1"> <tr> <td>TT KIT n°</td> <td>CBRSK.2</td> </tr> <tr> <td>Maker</td> <td>BREMBO</td> </tr> <tr> <td>OR kit n°</td> <td>-</td> </tr> <tr> <td>Description</td> <td>Complete overhaul</td> </tr> <tr> <td>Application</td> <td>20.5320.12/ 22/32/42</td> </tr> </table>	TT KIT n°	CBRSK.2	Maker	BREMBO	OR kit n°	-	Description	Complete overhaul	Application	20.5320.12/ 22/32/42
TT KIT n°	CBRSK.1																						
Maker	BREMBO																						
OR kit n°	-																						
Description	Pistons																						
Application	20.5320.12/ 22/32/42																						
TT KIT n°	CBRSK.2																						
Maker	BREMBO																						
OR kit n°	-																						
Description	Complete overhaul																						
Application	20.5320.12/ 22/32/42																						
 <p>OUT Ø : 70mm Thickness : 4mm</p>	<table border="1"> <tr> <td>TT KIT n°</td> <td>CBRSK.3</td> </tr> <tr> <td>Maker</td> <td>BREMBO</td> </tr> <tr> <td>OR kit n°</td> <td>120.4684.28</td> </tr> <tr> <td>Description</td> <td>Piston + Sealing Thick Model</td> </tr> <tr> <td>Application</td> <td>20.5320.12/ 22/32/42</td> </tr> </table>	TT KIT n°	CBRSK.3	Maker	BREMBO	OR kit n°	120.4684.28	Description	Piston + Sealing Thick Model	Application	20.5320.12/ 22/32/42	 <p>OUT Ø : 66mm Thickness : 3mm</p>	<table border="1"> <tr> <td>TT KIT n°</td> <td>CBRSK.4</td> </tr> <tr> <td>Maker</td> <td>BREMBO</td> </tr> <tr> <td>OR kit n°</td> <td>120.4684.27</td> </tr> <tr> <td>Description</td> <td>Piston + Sealing Thin Model</td> </tr> <tr> <td>Application</td> <td>20.5320.12/ 22/32/42</td> </tr> </table>	TT KIT n°	CBRSK.4	Maker	BREMBO	OR kit n°	120.4684.27	Description	Piston + Sealing Thin Model	Application	20.5320.12/ 22/32/42
TT KIT n°	CBRSK.3																						
Maker	BREMBO																						
OR kit n°	120.4684.28																						
Description	Piston + Sealing Thick Model																						
Application	20.5320.12/ 22/32/42																						
TT KIT n°	CBRSK.4																						
Maker	BREMBO																						
OR kit n°	120.4684.27																						
Description	Piston + Sealing Thin Model																						
Application	20.5320.12/ 22/32/42																						
	<table border="1"> <tr> <td>TT KIT n°</td> <td>CBRSK.5</td> </tr> <tr> <td>Maker</td> <td>BREMBO</td> </tr> <tr> <td>OR kit n°</td> <td>120.5468.10</td> </tr> <tr> <td>Description</td> <td>Piston hat Cap & O rings</td> </tr> <tr> <td>Application</td> <td>20.5320.12/ 22/32/42</td> </tr> </table>	TT KIT n°	CBRSK.5	Maker	BREMBO	OR kit n°	120.5468.10	Description	Piston hat Cap & O rings	Application	20.5320.12/ 22/32/42	 <p>OUT Ø : 70 mm Thickness : 4 mm</p>	<table border="1"> <tr> <td>TT KIT n°</td> <td>CBRSK.6</td> </tr> <tr> <td>Maker</td> <td>BREMBO</td> </tr> <tr> <td>OR kit n°</td> <td>120.4684.25</td> </tr> <tr> <td>Description</td> <td>Complete sealing kit (thick model)</td> </tr> <tr> <td>Application</td> <td>20.5320.12/ 22/32/42</td> </tr> </table>	TT KIT n°	CBRSK.6	Maker	BREMBO	OR kit n°	120.4684.25	Description	Complete sealing kit (thick model)	Application	20.5320.12/ 22/32/42
TT KIT n°	CBRSK.5																						
Maker	BREMBO																						
OR kit n°	120.5468.10																						
Description	Piston hat Cap & O rings																						
Application	20.5320.12/ 22/32/42																						
TT KIT n°	CBRSK.6																						
Maker	BREMBO																						
OR kit n°	120.4684.25																						
Description	Complete sealing kit (thick model)																						
Application	20.5320.12/ 22/32/42																						
 <p>OUT Ø : 66 mm Thickness : 3 mm</p>	<table border="1"> <tr> <td>TT KIT n°</td> <td>CBRSK.7</td> </tr> <tr> <td>Maker</td> <td>BREMBO</td> </tr> <tr> <td>OR kit n°</td> <td>120.4684.26</td> </tr> <tr> <td>Description</td> <td>Complete sealing kit (thick model)</td> </tr> <tr> <td>Application</td> <td>20.5320.12/ 22/32/42</td> </tr> </table>	TT KIT n°	CBRSK.7	Maker	BREMBO	OR kit n°	120.4684.26	Description	Complete sealing kit (thick model)	Application	20.5320.12/ 22/32/42		<table border="1"> <tr> <td>TT KIT n°</td> <td>CBRSK.8</td> </tr> <tr> <td>Maker</td> <td>BREMBO</td> </tr> <tr> <td>OR kit n°</td> <td>105.3246.25</td> </tr> <tr> <td>Description</td> <td>Bleeders</td> </tr> <tr> <td>Application</td> <td>20.5320.12/ 22/32/42</td> </tr> </table>	TT KIT n°	CBRSK.8	Maker	BREMBO	OR kit n°	105.3246.25	Description	Bleeders	Application	20.5320.12/ 22/32/42
TT KIT n°	CBRSK.7																						
Maker	BREMBO																						
OR kit n°	120.4684.26																						
Description	Complete sealing kit (thick model)																						
Application	20.5320.12/ 22/32/42																						
TT KIT n°	CBRSK.8																						
Maker	BREMBO																						
OR kit n°	105.3246.25																						
Description	Bleeders																						
Application	20.5320.12/ 22/32/42																						

Models



370.S12-24
370.S12-25
370.S12-27
370.S12-30
370.S12-35



Maker	BREMBO
Wheel size	22.5"

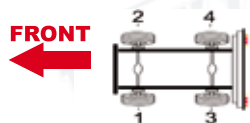

Calipers

Brembo part n°	TT n°	Side
120.5310.10	95.03.001	1
120.5310.20	95.03.002	2

Repair kits

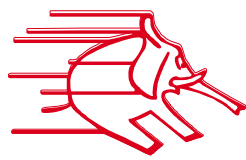
 NO PICTURE AVAILABLE	TT KIT n°	U.D.
	Maker	BREMBO
	OR kit n°	120.3203.20
	Description	Boot & seal
	Application	All these calipers

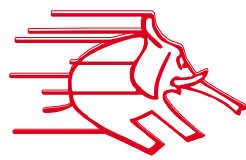
 NO PICTURE AVAILABLE	TT KIT n°	U.D.
	Maker	BREMBO
	OR kit n°	105.3246.19
	Description	Bleeder
	Application	All these calipers

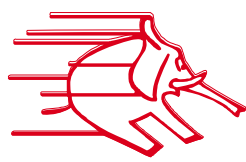
 NO PICTURE AVAILABLE	TT KIT n°	U.D.
	Maker	BREMBO
	OR kit n°	120.3204.31
	Description	Guide
	Application	All these calipers

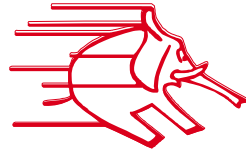
 NO PICTURE AVAILABLE	TT KIT n°	U.D.
	Maker	BREMBO
	OR kit n°	120.4909.31
	Description	Piston
	Application	All these calipers

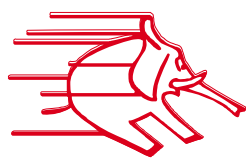
 NO PICTURE AVAILABLE	TT KIT n°	U.D.
	Maker	BREMBO
	OR kit n°	122.4849.43
	Description	Spring
	Application	All these calipers

Models



380EUROCLASS-393.35 MY
 380EUROCLASS-490.18
 380EUROCLASS-490.29
 380EUROCLASS-490.29 EL
 380EUROCLASS-491
 CITYCLASS 22
 CITYCLASS 27
 EURORIDER



Maker	BREMBO
Wheel size	22.5"

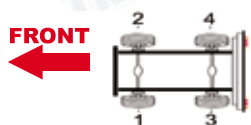

Calipers

Brembo part n°	TT n°	Side
120.5360.12	95.03.003	1
120.5360.22	95.03.004	2

Repair kits

 NO PICTURE AVAILABLE	TT KIT n°	U.D.
	Maker	BREMBO
	OR kit n°	120.3203.23
	Description	Guides & Seals
	Application	All these calipers

 NO PICTURE AVAILABLE	TT KIT n°	U.D.
	Maker	BREMBO
	OR kit n°	105.3246.19
	Description	Guides & Seals
	Application	All these calipers

 NO PICTURE AVAILABLE	TT KIT n°	U.D.
	Maker	BREMBO
	OR kit n°	120.3204.24
	Description	Guides & Seals
	Application	All these calipers

 NO PICTURE AVAILABLE	TT KIT n°	U.D.
	Maker	BREMBO
	OR kit n°	120.4909.42
	Description	Guides & Seals
	Application	All these calipers

 NO PICTURE AVAILABLE	TT KIT n°	U.D.
	Maker	BREMBO
	OR kit n°	122.4849.43
	Description	Guides & Seals
	Application	All these calipers

Models



EUROCARGO 65E / KE
EUROCARGO 75E / KE

1.



Maker	MERITOR
Wheel size	16" (FRONT)

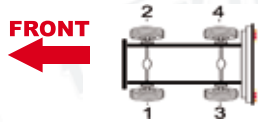

Calipers

	Meritor part n°	TT n°	Side
1	LRG506	93.01.003	1
1	LRG507	93.01.004	2
2	LRG612	93.02.003	3
2	LRG613	93.02.004	4

2.



Maker	MERITOR
Wheel size	16" (REAR)

Repair kits

	TT KIT n°	CMSK.16
	Maker	MERITOR
	OR kit n°	SJ1030
	Description	Complete overhaul
Application	LRG612 LRG613	

	TT KIT n°	CMSK.17
	Maker	MERITOR
	OR kit n°	SJ1035
	Description	Guide pin
Application	All these calipers	

<p>NO PICTURE AVAILABLE</p>	TT KIT n°	U.D.
	Maker	MERITOR
	OR kit n°	SJ1032
	Description	Hand brake
Application	LRG612 LRG613	

<p>NO PICTURE AVAILABLE</p>	TT KIT n°	U.D.
	Maker	MERITOR
	OR kit n°	SJ1034
	Description	Guide pin
Application	LRG612 LRG613	

<p>NO PICTURE AVAILABLE</p>	TT KIT n°	U.D.
	Maker	MERITOR
	OR kit n°	Sj1215
	Description	Auto adjuster
Application	LRG612 LRG613	

<p>NO PICTURE AVAILABLE</p>	TT KIT n°	U.D.
	Maker	MERITOR
	OR kit n°	SP8566
	Description	Cover
Application	All these calipers	

Models



EUROCARGO 100E
EUROCARGO 80E

1.



Maker	MERITOR
Wheel size	17.5" (FRONT)

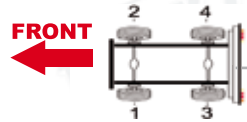

TT KIT ref.	WSSK.20.14
OR kit n°	1907942
Description	Wear Sensor

2.



Maker	MERITOR
Wheel size	17.5" (REAR)

Calipers

	Meritor part n°	TT n°	Side
1	LRG508	93.01.005	1
1	LRG509	93.01.006	2
2	LRG614	93.02.005	3
2	LRG615	93.02.006	4

Repair kits

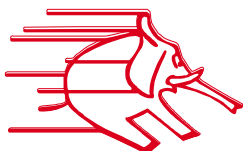
 NO PICTURE AVAILABLE	TT KIT n°	U.D.
	Maker	MERITOR
	OR kit n°	SJ1022
	Description	Guide pin
	Application	LRG614 LRG615

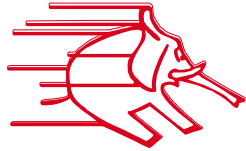
 NO PICTURE AVAILABLE	TT KIT n°	U.D.
	Maker	MERITOR
	OR kit n°	SJ1032
	Description	Hand brake
	Application	LRG614 LRG615

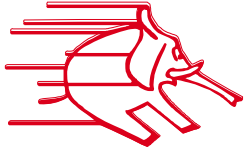
 NO PICTURE AVAILABLE	TT KIT n°	U.D.
	Maker	MERITOR
	OR kit n°	SJ1033
	Description	Overhaul seal
	Application	LRG614 LRG615

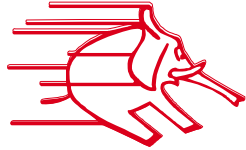
 NO PICTURE AVAILABLE	TT KIT n°	U.D.
	Maker	MERITOR
	OR kit n°	SJ1214
	Description	Auto adjuster
	Application	LRG614 LRG615

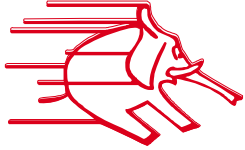
 NO PICTURE AVAILABLE	TT KIT n°	U.D.
	Maker	MERITOR
	OR kit n°	SP8564
	Description	Overhaul seal
	Application	LRG508 LRG509

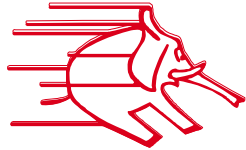
 NO PICTURE AVAILABLE	TT KIT n°	U.D.
	Maker	MERITOR
	OR kit n°	SP8566
	Description	Cover
	Application	LRG508 LRG509

Models



EUROCARGO 60
EUROCARGO 65
EUROCARGO 75

1.



Maker	BREMBO
Wheel size	16" (FRONT)

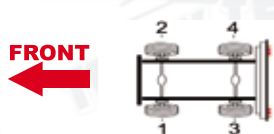

	TT KIT ref.	WSSK.20.14
	OR kit n°	1907942
	Description	Wear Sensor

2.





Maker	BREMBO
Wheel size	16" (REAR)

Calipers

	Brembo part n°	TT n°	Side
1	122.5760.08	95.09.001	1
1	122.5760.09	95.09.002	2
2	122.5770.16	95.09.003	3
2	122.5770.26	95.09.004	4

Repair kits

 NO PICTURE AVAILABLE	TT KIT n°	U.D.
	Maker	BREMBO
	OR kit n°	105.3246.24
	Description	Bleeder
	Application	All these calipers

 NO PICTURE AVAILABLE	TT KIT n°	U.D.
	Maker	BREMBO
	OR kit n°	120.
	Description	Boot & seal
	Application	All these calipers

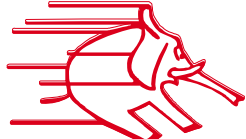
 NO PICTURE AVAILABLE	TT KIT n°	U.D.
	Maker	BREMBO
	OR kit n°	120.
	Description	Guide
	Application	All these calipers

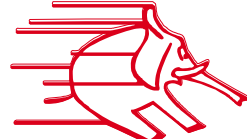
 NO PICTURE AVAILABLE	TT KIT n°	U.D.
	Maker	BREMBO
	OR kit n°	122.
	Description	Guide
	Application	All these calipers

 NO PICTURE AVAILABLE	TT KIT n°	U.D.
	Maker	BREMBO
	OR kit n°	122.
	Description	Piston
	Application	All these calipers

Models



EUROCARGO 100
EUROCARGO 80

1.



Maker	BREMBO
Wheel size	17.5" (FRONT)



	TT KIT ref.	WSSK.20.14
	OR kit n°	1907942
	Description	Wear Sensor

2.



Maker	BREMBO
Wheel size	17.5" (REAR)

Calipers

	Brembo part n°	TT n°	Side
1	122.5660.08	95.10.001	1
1	122.5660.09	95.10.002	2
2	122.5670.08	95.10.003	3
2	122.5670.09	95.10.004	4

Repair kits

	TT KIT n°	U.D.
	Maker	BREMBO
	OR kit n°	105.3246.24
	Description	Bleeder
	Application	All these calipers

	TT KIT n°	U.D.
	Maker	BREMBO
	OR kit n°	120.3203.46
	Description	Boot & seal
	Application	All these calipers

	TT KIT n°	U.D.
	Maker	BREMBO
	OR kit n°	120.3840.50
	Description	Guide
	Application	All these calipers

	TT KIT n°	U.D.
	Maker	BREMBO
	OR kit n°	120.4909.50
	Description	Piston
	Application	All these calipers

	TT KIT n°	U.D.
	Maker	BREMBO
	OR kit n°	122.5000.20
	Description	Guide
	Application	All these calipers

Models



EUROCARGO120

FROM 04.2001

EUROCARGO130

From 04.2001

EUROCARGO150

From 04.2001

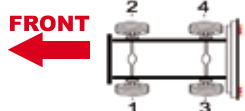

	TT KIT n°	WSSK.20.26
	OR kit n°	-
	Description	Wear Sensor

Maker	KNORR
Wheel size	19.5"
Angle of actuator	+5°
Brake type	Axial
Wear sensor	In-pad normally closed

Calipers

Knorr type n°	TT n°	Side	Knorr part n°	Knorr ration. n°
SB6557	91.02.002	1	II39259	SB6418
SB6547	91.02.001	2	II39258	SB6408

Repair kits

MORE KITS : [Page 192](#)

	<table border="1"> <tr><td>TT KIT n°</td><td>CKSK.6</td></tr> <tr><td>Maker</td><td>KNORR</td></tr> <tr><td>OR kit n°</td><td>K001532</td></tr> <tr><td>Description</td><td>Guides & Seals (New)</td></tr> <tr><td>Application</td><td>All SB...</td></tr> </table>	TT KIT n°	CKSK.6	Maker	KNORR	OR kit n°	K001532	Description	Guides & Seals (New)	Application	All SB...		<table border="1"> <tr><td>TT KIT n°</td><td>CKSK.4 /4.2</td></tr> <tr><td>Maker</td><td>KNORR</td></tr> <tr><td>OR kit n°</td><td>K000944 / K001300</td></tr> <tr><td>Description</td><td>Tappets</td></tr> <tr><td>Application</td><td>All SB... All SN/NA/SK</td></tr> </table>	TT KIT n°	CKSK.4 /4.2	Maker	KNORR	OR kit n°	K000944 / K001300	Description	Tappets	Application	All SB... All SN/NA/SK
TT KIT n°	CKSK.6																						
Maker	KNORR																						
OR kit n°	K001532																						
Description	Guides & Seals (New)																						
Application	All SB...																						
TT KIT n°	CKSK.4 /4.2																						
Maker	KNORR																						
OR kit n°	K000944 / K001300																						
Description	Tappets																						
Application	All SB... All SN/NA/SK																						
	<table border="1"> <tr><td>TT KIT n°</td><td>CKSK.3.2</td></tr> <tr><td>Maker</td><td>KNORR</td></tr> <tr><td>OR kit n°</td><td>K000472</td></tr> <tr><td>Description</td><td>Guide & Seals</td></tr> <tr><td>Application</td><td>All SN...</td></tr> </table>	TT KIT n°	CKSK.3.2	Maker	KNORR	OR kit n°	K000472	Description	Guide & Seals	Application	All SN...		<table border="1"> <tr><td>TT KIT n°</td><td>CKSK.8</td></tr> <tr><td>Maker</td><td>KNORR</td></tr> <tr><td>OR kit n°</td><td>-</td></tr> <tr><td>Description</td><td>Complete overhaul</td></tr> <tr><td>Application</td><td>All SB... All SN...</td></tr> </table>	TT KIT n°	CKSK.8	Maker	KNORR	OR kit n°	-	Description	Complete overhaul	Application	All SB... All SN...
TT KIT n°	CKSK.3.2																						
Maker	KNORR																						
OR kit n°	K000472																						
Description	Guide & Seals																						
Application	All SN...																						
TT KIT n°	CKSK.8																						
Maker	KNORR																						
OR kit n°	-																						
Description	Complete overhaul																						
Application	All SB... All SN...																						
	<table border="1"> <tr><td>TT KIT n°</td><td>CKSK.8.1</td></tr> <tr><td>Maker</td><td>KNORR</td></tr> <tr><td>OR kit n°</td><td>Only TT</td></tr> <tr><td>Description</td><td>Guides & Seals</td></tr> <tr><td>Application</td><td>All SB... All SN...</td></tr> </table>	TT KIT n°	CKSK.8.1	Maker	KNORR	OR kit n°	Only TT	Description	Guides & Seals	Application	All SB... All SN...		<table border="1"> <tr><td>TT KIT n°</td><td>CKSK.16/16.1</td></tr> <tr><td>Maker</td><td>KNORR</td></tr> <tr><td>OR kit n°</td><td>-</td></tr> <tr><td>Description</td><td>Alu / Plastic cover</td></tr> <tr><td>Application</td><td>All SB... All SN...</td></tr> </table>	TT KIT n°	CKSK.16/16.1	Maker	KNORR	OR kit n°	-	Description	Alu / Plastic cover	Application	All SB... All SN...
TT KIT n°	CKSK.8.1																						
Maker	KNORR																						
OR kit n°	Only TT																						
Description	Guides & Seals																						
Application	All SB... All SN...																						
TT KIT n°	CKSK.16/16.1																						
Maker	KNORR																						
OR kit n°	-																						
Description	Alu / Plastic cover																						
Application	All SB... All SN...																						
	<table border="1"> <tr><td>TT KIT n°</td><td>CKSK.10.3/10.4</td></tr> <tr><td>Maker</td><td>KNORR</td></tr> <tr><td>OR kit n°</td><td>-</td></tr> <tr><td>Description</td><td>Adjusting Mechanism</td></tr> <tr><td>Application</td><td>All SB... All SN...</td></tr> </table>	TT KIT n°	CKSK.10.3/10.4	Maker	KNORR	OR kit n°	-	Description	Adjusting Mechanism	Application	All SB... All SN...		<table border="1"> <tr><td>TT KIT n°</td><td>CKSK.14/14.1</td></tr> <tr><td>Maker</td><td>KNORR</td></tr> <tr><td>OR kit n°</td><td>-</td></tr> <tr><td>Description</td><td>Roller Bearings</td></tr> <tr><td>Application</td><td>All SB... All SN...</td></tr> </table>	TT KIT n°	CKSK.14/14.1	Maker	KNORR	OR kit n°	-	Description	Roller Bearings	Application	All SB... All SN...
TT KIT n°	CKSK.10.3/10.4																						
Maker	KNORR																						
OR kit n°	-																						
Description	Adjusting Mechanism																						
Application	All SB... All SN...																						
TT KIT n°	CKSK.14/14.1																						
Maker	KNORR																						
OR kit n°	-																						
Description	Roller Bearings																						
Application	All SB... All SN...																						

Models



EUROCARGO120(19.5")

From 1992 To 03.2001

EUROCARGO130(19.5")

From 1992 To 03.2001

EUROCARGO150(19.5")

From 1992 To 03.2001

EUROCARGO170(22.5")

From 1992 To 1998

EUROTECH(22.5")

From 1992 To 1998



Maker	BENDIX
Brake type	Radial

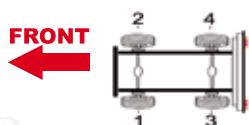

Calipers

Bendix type n°	TT n°	Side
131.790(19.5")	91.04.001	1
131.791(19.5")	91.04.002	2
131.776(22.5")	91.04.003	1
131.777(22.5")	91.04.004	2

Repair kits

	TT KIT n°	CBESK.1
	Maker	BENDIX
	OR kit n°	381.413
	Description	Seals & bushes
Application	131.790 /.791 131.776 /.777	

	TT KIT n°	CBESK.2
	Maker	BENDIX
	OR kit n°	381.419
	Description	Pad retainer kits
Application	131.790 /.791 131.776 /.777	

	TT KIT n°	CBESK.3
	Maker	BENDIX
	OR kit n°	381.427
	Description	Wedge Assy
Application	131.790 /.791 131.776 /.777	

<p>NO PICTURE AVAILABLE</p>	TT KIT n°	CBESK.4
	Maker	BENDIX
	OR kit n°	381.391
	Description	Guides & Seals
Application	131.790 /.791 131.776 /.777	

Models



EUROSTAR

From 03.1997

EUROTECH

From 03.1997



Calipers

TT KIT ref.	WSSK.20.15
OR kit n°	1903651
Description	Wear Sensor

Maker	KNORR
Wheel size	22.5"
Angle of actuator	-12°
Brake type	Axial
Wear sensor	In-pad, normally closed

Knorr type n°	TT n°	Side	Knorr part n°	Knorr ration. n°
SB7906	91.03.001	1	K00412	SN7251
SB7916	91.03.002	2	k000413	SN7241
SB7902	91.03.013	3	K000260	SN7252
SB7912	91.03.014	4	K000261	SN7242

Repair kits

MORE KITS : [Page 192](#)

	TT KIT n°	CKSK.6
	Maker	KNORR
	OR kit n°	K001532
	Description	Guides & Seals (New)
Application		All SB...

	TT KIT n°	CKSK.4 / 4.2
	Maker	KNORR
	OR kit n°	K000944 / K001300
	Description	Tappets
Application		All SB... All SN/NA/SK

	TT KIT n°	CKSK.3.2
	Maker	KNORR
	OR kit n°	K000472
	Description	Guide & Seals
Application		All SN...

	TT KIT n°	CKSK.8
	Maker	KNORR
	OR kit n°	-
	Description	Complete overhaul
Application		All SB... All SN...

	TT KIT n°	CKSK.8.1
	Maker	KNORR
	OR kit n°	Only TT
	Description	Guides & Seals
Application		All SB... All SN...

	TT KIT n°	CKSK.16/16.1
	Maker	KNORR
	OR kit n°	-
	Description	Alu / Plastic cover
Application		All SB... All SN...

	TT KIT n°	CKSK.10.3/10.4
	Maker	KNORR
	OR kit n°	-
	Description	Adjusting Mechanism
Application		All SB... All SN...

	TT KIT n°	CKSK.14/14.1
	Maker	KNORR
	OR kit n°	-
	Description	Roller Bearings
Application		All SB... All SN...

Models



LKW Euro Cargo

Types 120 EL



	TT KIT n°	WSSK.20.23
	OR kit n°	42536956
	Description	Wear Sensor

Maker	Wabco
Wheel size	17.5"

Calipers

Wabco part n°	TT n°	Side
40 175 058	92.01.003	1
40 175 059	92.01.004	2

Repair kits

MORE KITS : [Page 224](#)

	TT KIT n°	CWSK.2
	Maker	WABCO
	OR kit n°	12.999.699
	Description	Guides & seals
	Application	40 175 070 40 175 071

	TT KIT n°	CWSK.8
	Maker	WABCO
	OR kit n°	12.999.580
	Description	Seals, boots & screws
	Application	40 175 070 40 175 071

	TT KIT n°	CWSK.7
	Maker	WABCO
	OR kit n°	12.999.704
	Description	Seals, boots & screws
	Application	40 175 070 40 175 071

	TT KIT n°	CWSK.12
	Maker	WABCO
	OR kit n°	-
	Description	Roller bearing
	Application	40 175 070 40 175 071

	TT KIT n°	CWSK.17.1
	Maker	WABCO
	OR kit n°	-
	Description	Seals & boots
	Application	40 175 070 40 175 071

	TT KIT n°	CWSK.17.2
	Maker	WABCO
	OR kit n°	-
	Description	Guides & screws
	Application	40 175 070 40 175 071

	TT KIT n°	CWSK.12.4
	Maker	WABCO
	OR kit n°	-
	Description	Plugs & joint
	Application	40 175 070 40 175 071

	TT KIT n°	CWSK.12.1
	Maker	WABCO
	OR kit n°	-
	Description	Adjusting mechanism
	Application	40 175 070 40 175 071

Models

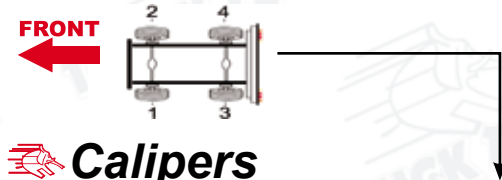

Maker	MERITOR
Wheel size	22.5"

Calipers

Meritor part n°	TT n°	Side
LRG658	93.08.021	3
LRG659	93.06.022	4

Repair kits

MORE KITS : [Page 220](#)

	TT KIT n°	CMSK.26
	Maker	MERITOR
	OR kit n°	MCK1243
	Description	Guide & Pin
	Application	LRG658 LRG659

	TT KIT n°	CMSK.8.13
	Maker	MERITOR
	OR kit n°	MCK1240
	Description	Visual Wear Assy
	Application	LRG658 LRG659

Models



S215HDH
S215NR
S300NC
S315HD
SETRA CITY BUS



Maker	MERITOR
Wheel size	22.5"

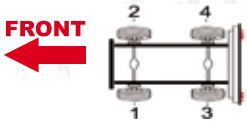

Calipers

Meritor part n°	TT n°	Side
LRG528	93.04.005	1-3
LRG529	93.04.006	2-4

Repair kits

MORE KITS : Page 204

	TT KIT n°	CMSK.1
	Maker	MERITOR
	OR kit n°	SJ4001
	Description	Guides & Seals
	Application	LRG528 LRG529

	TT KIT n°	CMSK.6
	Maker	MERITOR
	OR kit n°	SJ1212
	Description	Cover & Boots
	Application	LRG528 LRG529

	TT KIT n°	CMSK.24.3/25.3
	Maker	MERITOR
	OR kit n°	-
	Description	Clutch mechanism
	Application	LRG528 LRG529

	TT KIT n°	CMSK.24.4/25.4
	Maker	MERITOR
	OR kit n°	-
	Description	Adjuster tappet
	Application	LRG528 LRG529

	TT KIT n°	CMSK.28/29
	Maker	MERITOR
	OR kit n°	-
	Description	Shaft
	Application	LRG528 LRG529

	TT KIT n°	CMSK.24.1/25.1
	Maker	MERITOR
	OR kit n°	-
	Description	Support - spiral
	Application	LRG528 LRG529

	TT KIT n°	CMSK.24.2
	Maker	MERITOR
	OR kit n°	-
	Description	Roller
	Application	LRG528 LRG529

	TT KIT n°	CMSK.24.7
	Maker	MERITOR
	OR kit n°	-
	Description	Shaft Roller Bearing
	Application	LRG528 LRG529

Models



Ø 19.5" wheels

From 01.1998.

Ø 22.5" wheels

From 1998



	TT KIT n°	WSSK.20.28
	OR kit n°	Z0008241
	Description	Wear Sensor



Wheel size	19.5"
Brake type	Axial
Wear sensor	In pad



Wheel size	22.5"
Brake type	Axial
Wear sensor	In pad

Calipers

	Knorr type n°	TT n°	Side	Knorr part n°	Knorr ration.n°
1	SB6521(19.5"/+5°)	91.02.001	1	II34892	SB6413
1	SB6531(19.5"/+5°)	91.02.002	2	II94893	SB6403
2	SB7904(22.5"/0°)	91.03.003	1	K000320	SN7196
2	SB7914(22.5"/0°)	91.03.004	2	K000321	SN7186

Repair kits

MORE KITS : [Page 192](#)

	TT KIT n°	CKSK.6
	Maker	KNORR
	OR kit n°	K001532
	Description	Guides & Seals (New)
Application		All SB...

	TT KIT n°	CKSK.4 /4.2
	Maker	KNORR
	OR kit n°	K000944 / K001300
	Description	Tappets
Application		All SB... All SN/NA/SK

	TT KIT n°	CKSK.3.2
	Maker	KNORR
	OR kit n°	K000472
	Description	Guide & Seals
Application		All SN...

	TT KIT n°	CKSK.8
	Maker	KNORR
	OR kit n°	-
	Description	Complete overhaul
Application		All SB... All SN...

	TT KIT n°	CKSK.8.1
	Maker	KNORR
	OR kit n°	Only TT
	Description	Guides & Seals
Application		All SB... All SN...

	TT KIT n°	CKSK.16/16.1
	Maker	KNORR
	OR kit n°	Only TT
	Description	Alu / Plastic cover
Application		All SB... All SN...

	TT KIT n°	CKSK.103/104
	Maker	KNORR
	OR kit n°	-
	Description	Adjusting Mechanism
Application		All SB... All SN...

	TT KIT n°	CKSK.14/14.1
	Maker	KNORR
	OR kit n°	-
	Description	Roller Bearings
Application		All SB... All SN...

Models



14T HOCL TAP A66

From 1998

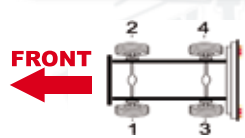

	TT KIT n°	WSSK.20.15
	Maker	MAN
	OR kit n°	1903651
	Description	Wear Sensor

Maker	KNORR
Wheel size	19.5"
Angle of actuator	+5°
Brake type	Axial

Calipers

Knorr type n°	TT n°	Side	Knorr part n°	Knorr rationalised n°
SB6508	91.02.001	1	I133428	SN6565
SB6518	91.02.002	2	I133429	SN6555

Repair kits

MORE KITS : [Page 192](#)

	TT KIT n°	CKSK.1
	Maker	KNORR
	OR kit n°	I1328090062
	Description	Guides & Seals
	Application	All SB...

	TT KIT n°	CKSK.4 /4.2
	Maker	KNORR
	OR kit n°	K000944 / K001300
	Description	Tappets
	Application	All SB... All SN/NA/SK

	TT KIT n°	CKSK.6
	Maker	KNORR
	OR kit n°	K001532
	Description	Guides & Seals (New)
	Application	All SB...

	TT KIT n°	CKSK.8
	Maker	KNORR
	OR kit n°	-
	Description	Complete overhaul
	Application	All SB... All SN...

	TT KIT n°	CKSK.8.1
	Maker	KNORR
	OR kit n°	Only TT
	Description	Guides & Seals
	Application	All SB... All SN...

	TT KIT n°	CKSK.16/16.1
	Maker	KNORR
	OR kit n°	-
	Description	Alu / Plastic cover
	Application	All SB... All SN...

	TT KIT n°	CKSK.10.3/10.4
	Maker	KNORR
	OR kit n°	-
	Description	Adjusting Mechanism
	Application	All SB... All SN...

	TT KIT n°	CKSK.3.2
	Maker	KNORR
	OR kit n°	K000472
	Description	Guide & Seals
	Application	All SN...

Models



- A13** From 1999
- A32** From 1999
- A33** From 1999
- AO1** From 1999
- AO3** From 1999
- A04** From 1999

1.



Maker	MERITOR
Wheel size	22.5"

2.



Maker	MERITOR
Wheel size	22.5"

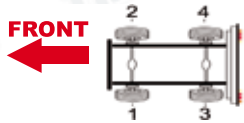

Calipers

	Meritor part n°	TT n°	Side
1	LRG704	93.08.009	1
1	LRG705	93.08.010	2
2	LRG588	93.08.003	3
2	LRG589	93.08.004	4

Repair kits

MORE KITS : [Page 222](#)

	TT KIT n°	CMSK.5
	Maker	MERITOR
	OR kit n°	MCK1102
	Description	Guides & bushes
	Application	LRG589 LRG588

	TT KIT n°	CMSK.3.3
	Maker	MERITOR
	OR kit n°	SJ4112
	Description	Half bearing
	Application	LRG589 LRG588

	TT KIT n°	CMSK.5.2
	Maker	MERITOR
	OR kit n°	
	Description	Small gear mechanism (left)
	Application	LRG588

	TT KIT n°	CMSK.5.3
	Maker	MERITOR
	OR kit n°	
	Description	Small gear mechanism (right)
	Application	LRG589

	TT KIT n°	CMSK.5.4
	Maker	MERITOR
	OR kit n°	
	Description	Locking shim
	Application	LRG589 LRG588

Models



- CITYBUS A20 from 1999
- CITYBUS A21 from 1999
- CITYBUS A22 from 1999
- CITYBUS A23 from 1999
- CITYBUS A24 from 1999
- CITYBUS A28 from 1999
- CITYBUS A31 from 1999
- CITYBUS J14 from 1999
- CITYBUS J21 from 1999
- CITYBUS J22 from 1999

1.



Maker	MERITOR
Wheel size	22.5"

2.



Maker	MERITOR
Wheel size	22.5"

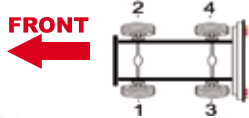

TT KIT ref.	WSSK.20.18
OR kit n°	81508226017
Description	Wear Sensor

Calipers

Meritor part n°	TT n°	Side
LRG574	93.08.015	1
LRG575	93.08.016	2
LRG632	93.08.005	3
LRG633	93.08.006	4

Repair kits

MORE KITS : [Page 208](#)

	TT KIT n°	CMSK.5
	Maker	MERITOR
	OR kit n°	MCK1102
	Description	Guides & bushes
Application		LRG632 LRG633

	TT KIT n°	CMSK.3.3
	Maker	MERITOR
	OR kit n°	SJ4112
	Description	Half bearing
Application		LRG632 LRG633

	TT KIT n°	CMSK.5.2
	Maker	MERITOR
	OR kit n°	
	Description	Small gear mechanism (left)
Application		LRG632

	TT KIT n°	CMSK.5.3
	Maker	MERITOR
	OR kit n°	
	Description	Small gear mechanism (right)
Application		LRG633

	TT KIT n°	CMSK.5.4
	Maker	MERITOR
	OR kit n°	
	Description	Locking shim
Application		LRG632 LRG633

Models



CITYBUS A25

From 05.2001 to 09.2002

CITYBUS A26

From 05.2001 to 09.2002

CITYBUS A30

From 05.2001 to 09.2002

CITYBUS A35

From 05.2001 to 09.2002

1.



Maker	MERITOR
Wheel size	22.5"

2.



Maker	MERITOR
Wheel size	22.5"

FRONT

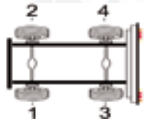

TT KIT ref.	WSSK.20.18
OR kit n°	81508226017
Description	Wear Sensor

Calipers

	Meritor part n°	TT n°	Side
1	LRG704	93.08.009	1
1	LRG705	93.08.010	2
2	LRG542	93.08.013	3
2	LRG543	93.08.014	4

Repair kits

MORE KITS : [Page 222](#)



TT KIT n°	CMSK.5
Maker	MERITOR
OR kit n°	MCK1102
Description	Guides & bushes
Application	LRG542 LRG543



TT KIT n°	CMSK.3.3
Maker	MERITOR
OR kit n°	SJ4112
Description	Half bearing
Application	LRG542 LRG543



TT KIT n°	CMSK.5.2
Maker	MERITOR
OR kit n°	
Description	Small gear mechanism (left)
Application	LRG542



TT KIT n°	CMSK.5.3
Maker	MERITOR
OR kit n°	
Description	Small gear mechanism (right)
Application	LRG543



TT KIT n°	CMSK.5.4
Maker	MERITOR
OR kit n°	
Description	Locking shim
Application	LRG542 LRG543

Models



FRH422

From 05.2001 to 09.2002



Maker	MERITOR
Wheel size	22.5"

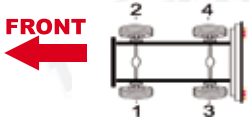

TT KIT ref.	WSSK.20.18
OR kit n°	81508226017
Description	Wear Sensor

Calipers

Meritor part n°	TT n°	Side
LRG524	93.04.001	1
LRG525	93.04.002	2

Repair kits

MORE KITS : Page 204

	TT KIT n°	CMSK.1
	Maker	MERITOR
	OR kit n°	SJ4001
	Description	Guides & Seals
	Application	LRG524 LRG525

	TT KIT n°	CMSK.6
	Maker	MERITOR
	OR kit n°	SJ1212
	Description	Cover & Boots
	Application	LRG524 LRG525

	TT KIT n°	CMSK.24.3/25.3
	Maker	MERITOR
	OR kit n°	-
	Description	Clutch mechanism
	Application	LRG524 LRG525

	TT KIT n°	CMSK.24.4/25.4
	Maker	MERITOR
	OR kit n°	-
	Description	Adjuster tappet
	Application	LRG524 LRG525

	TT KIT n°	CMSK.24/25
	Maker	MERITOR
	OR kit n°	-
	Description	Shaft
	Application	LRG524 LRG525

	TT KIT n°	CMSK.24.1/25.1
	Maker	MERITOR
	OR kit n°	-
	Description	Support - spiral
	Application	LRG524 LRG525

	TT KIT n°	CMSK.24.2
	Maker	MERITOR
	OR kit n°	-
	Description	Roller
	Application	LRG524 LRG525

	TT KIT n°	CMSK.24.7
	Maker	MERITOR
	OR kit n°	-
	Description	Shaft Roller Bearing
	Application	LRG524 LRG525

Models



FH322
From 1995 (Side 1-2)

FH422
From 1995 (Side 1-2)

LIONSTAR
From 1995 (Side 1-2)

NG313
From 1999 (Side 1-2-3-4)

NL223
From 1999 (Side 1-2-3-4)

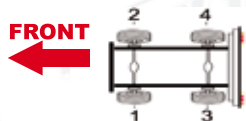

Calipers

	Meritor part n°	TT n°	Side
1	LRG570	93.08.001	1
1	LRG571	93.08.002	2
2	LRG632	93.08.005	3
2	LRG633	93.08.006	4

1.



Maker	MERITOR
Wheel size	22.5"

2.



Maker	MERITOR
Wheel size	22.5"

	TT KIT ref.	WSSK.20.18
	OR kit n°	81508226017
	Description	Wear Sensor

Repair kits

MORE KITS : [Page 208](#)

	TT KIT n°	CMSK.5
	Maker	MERITOR
	OR kit n°	MCK1102
	Description	Guides & bushes
Application		All these calipers

	TT KIT n°	CMSK.3.3
	Maker	MERITOR
	OR kit n°	SJ4112
	Description	Half bearing
Application		All these calipers

	TT KIT n°	CMSK.5.2
	Maker	MERITOR
	OR kit n°	
	Description	Small gear mechanism (left)
Application		LRG570 LRG632

	TT KIT n°	CMSK.5.3
	Maker	MERITOR
	OR kit n°	
	Description	Small gear mechanism (right)
Application		LRG571 LRG633

	TT KIT n°	CMSK.5.4
	Maker	MERITOR
	OR kit n°	
	Description	Locking shim
Application		All these calipers

Models



NG353

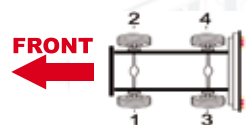

	TT KIT ref.	WSSK.20.18
	OR kit n°	81508226017
	Description	Wear Sensor

Maker	MERITOR
Wheel size	22.5"

Calipers

Meritor part n°	TT n°	Side
LRG632	93.08.005	3
LRG633	93.08.006	4

Repair kits

MORE KITS : Page 204

	TT KIT n°	CMSK.5
	Maker	MERITOR
	OR kit n°	MCK1102
	Description	Guides & bushes
Application	All these calipers	

	TT KIT n°	CMSK.3.3
	Maker	MERITOR
	OR kit n°	SJ4112
	Description	Half bearing
Application	All these calipers	

	TT KIT n°	CMSK.5.2
	Maker	MERITOR
	OR kit n°	
	Description	Small gear mechanism (left)
Application	All these calipers	

	TT KIT n°	CMSK.5.3
	Maker	MERITOR
	OR kit n°	
	Description	Small gear mechanism (right)
Application	All these calipers	

	TT KIT n°	CMSK.5.4
	Maker	MERITOR
	OR kit n°	
	Description	Locking shim
Application	All these calipers	

 **Models**



CITYBUS SENSOR

From 03.2004

PWI

From 03.2004

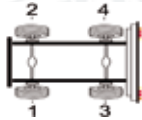

FRONT

	TT KIT ref.	WSSK.20.18
	OR kit n°	81508226017
	Description	Wear Sensor

Maker	MERITOR
Wheel size	22.5"

 **Calipers**

Meritor part n°	TT n°	Side
LRG662	93.08.027	3
LRG663	93.08.028	4

 **Repair kits**

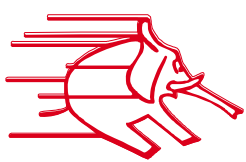
 NO PICTURE AVAILABLE	TT KIT n°	U.D.
	Maker	MERITOR
	OR kit n°	MCK1140
	Description	Guide pin
	Application	All these calipers

Models



L 2000

Types 8.103 to 10.153
From 09/93 To 12/96



FRONT
←

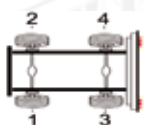

TT KIT ref.	WSSK.20.16
OR kit n°	81508226014
Description	Wear Sensor

Maker	WABCO
-------	-------

Calipers

Wabco part n°	TT n°	Side
40 100 005	92.04.001	1
40 100 006	92.04.002	2

Models	Caliper type
10.153	1000 V-G
10.223	1000 V-G
11.153	1000 V-G
6.153	1000 V-G
8.103	1000 V-G
8.153	1000 V-G
8.223	1000 V-G
9.153	1000 V-G
9.223	1000 V-G

Repair kits

	TT KIT n°	CWSK.3
	Maker	WABCO
	OR kit n°	12.999.729
	Description	Guides & seals
	Application	All these calipers

Models



L 2000
Types 6.153 to 11.153
From 01/97

M2000L
up to 12T

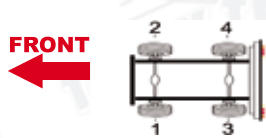

	TT KIT ref.	WSSK.20.16
	OR kit n°	81508226014
	Description	Wear Sensor







Maker	WABCO
Wheel size	17.5"
Models	Caliper type
10.153	PAN 17
10.223	PAN 17
11.153	PAN 17
6.153	PAN 17
8.103	PAN 17
8.153	PAN 17
8.223	PAN 17
9.150	PAN 17

Calipers

Wabco part n°	TT n°	Side
40 175 051	92.01.001	1-3
40 175 052	92.01.002	2-4

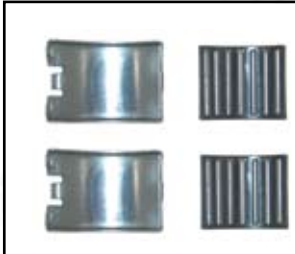
Repair kits

MORE KITS : Page 224

	TT KIT n° CWSK.2 Maker WABCO OR kit n° 12.999.699 Description Guides & seals Application 40 175 051 40 175 052		TT KIT n° CWSK.8 Maker WABCO OR kit n° 12.999.580 Description Seals, boots & screws Application 40 175 051 40 175 052
	TT KIT n° CWSK.7 Maker WABCO OR kit n° 12.999.704 Description Seals, boots & screws Application 40 175 051 40 175 052		TT KIT n° CWSK.12 Maker WABCO OR kit n° - Description Roller bearing Application 40 175 051 40 175 052
	TT KIT n° CWSK.17.1 Maker WABCO OR kit n° - Description Seals & boots Application 40 175 051 40 175 052		TT KIT n° CWSK.17.2 Maker WABCO OR kit n° - Description Guides & screws Application 40 175 051 40 175 052
	TT KIT n° CWSK.12.4 Maker WABCO OR kit n° - Description Plugs & joint Application 40 175 051 40 175 052		TT KIT n° CWSK.12.1 Maker WABCO OR kit n° - Description Adjusting mechanism Application 40 175 051 40 175 052

Models



F 2000

From 1994 to 1996

F 90

From 1993

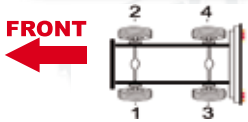

	TT KIT ref.	WSSK.20.12
	OR kit n°	82853884510
	Description	Wear Sensor

Maker	MERITOR
Wheel size	22.5"

Calipers

Meritor part n°	TT n°	Side
LRG524	93.04.001	1
LRG525	93.04.002	2

Repair kits

MORE KITS : [Page 204](#)

	TT KIT n°	CMSK.1
	Maker	MERITOR
	OR kit n°	SJ4001
	Description	Guides & Seals
	Application	LRG524 LRG525

	TT KIT n°	CMSK.6
	Maker	MERITOR
	OR kit n°	SJ1212
	Description	Cover & Boots
	Application	LRG524 LRG525

	TT KIT n°	CMSK.24.3/25.3
	Maker	MERITOR
	OR kit n°	-
	Description	Clutch mechanism
	Application	LRG524 LRG525

	TT KIT n°	CMSK.24.4/25.4
	Maker	MERITOR
	OR kit n°	-
	Description	Adjuster tappet
	Application	LRG524 LRG525

	TT KIT n°	CMSK.24/25
	Maker	MERITOR
	OR kit n°	-
	Description	Shaft
	Application	LRG524 LRG525

	TT KIT n°	CMSK.24.1/25.1
	Maker	MERITOR
	OR kit n°	-
	Description	Support - spiral
	Application	LRG524 LRG525

	TT KIT n°	CMSK.24.2
	Maker	MERITOR
	OR kit n°	-
	Description	Roller
	Application	LRG524 LRG525

	TT KIT n°	CMSK.24.7
	Maker	MERITOR
	OR kit n°	-
	Description	Shaft Roller Bearing
	Application	LRG524 LRG525

Models



F 2000
From 1996

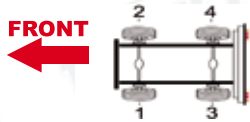

	TT KIT ref.	WSSK.20.12
	OR kit n°	82853884510
	Description	Wear Sensor

Maker	MERITOR
Wheel size	22.5"

Calipers

Meritor part n°	TT n°	Side
LRG570	93.08.001	1
LRG571	93.08.002	2

Repair kits

MORE KITS : [Page 208](#)

	TT KIT n°	CMSK.5
	Maker	MERITOR
	OR kit n°	MCK1102
	Description	Guides & bushes
	Application	All these calipers

	TT KIT n°	CMSK.3.3
	Maker	MERITOR
	OR kit n°	SJ4112
	Description	Half bearing
	Application	All these calipers

	TT KIT n°	CMSK.5.2
	Maker	MERITOR
	OR kit n°	
	Description	Small gear mechanism (left)
	Application	All these calipers

	TT KIT n°	CMSK.5.3
	Maker	MERITOR
	OR kit n°	
	Description	Small gear mechanism (right)
	Application	All these calipers

	TT KIT n°	CMSK.5.4
	Maker	MERITOR
	OR kit n°	
	Description	Locking shim
	Application	All these calipers

Models



TGA H12

From 01.2001

TGA H17

From 01.2001

1.





Maker	MERITOR
Wheel size	22.5"

2.

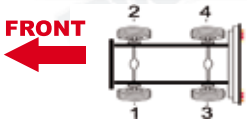

Maker	MERITOR
Wheel size	22.5"



	TT KIT ref.	WSSK.20.18
	OR kit n°	81508226017
	Description	Wear Sensor

Calipers

	Meritor part n°	TT n°	Side
1	LRG544	93.09.001	1
1	LRG545	93.09.002	2
2	LRG638	93.09.005	3
2	LRG639	93.09.006	4

Repair kits

	TT KIT n°	CMSK.18
	Maker	MERITOR
	OR kit n°	MCK1139
	Description	Adjuster tap kit
	Application	All these calipers

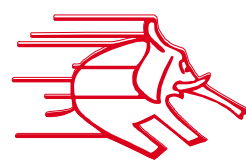
 NO PICTURE AVAILABLE	TT KIT n°	U.D.
	Maker	MERITOR
	OR kit n°	MCK1140
	Description	Guide pin
	Application	All these calipers

Models



M 2000
From 1996



FRONT

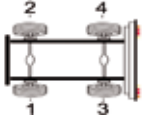

TT KIT n°	WSSK.20.12
Maker	MAN
OR kit n°	82853884510
Description	Wear Sensor

Maker	KNORR
Wheel size	19.5"
Angle of actuator	+5°
Brake type	Axial
Wear sensor	In pad normally closed

Calipers

Knorr type n°	TT n°	Side	Knorr part n°	Knorr rationalised n°
SB6503	91.02.001	1	II31017	SN6565
SB6513	91.02.002	2	II31018	SN6555

Repair kits

MORE KITS : Page 192



TT KIT n°	CKSK.1
Maker	KNORR
OR kit n°	II328090062
Description	Guides & Seals
Application	All SB...



TT KIT n°	CKSK.4 / 4.2
Maker	KNORR
OR kit n°	K000944 / K001300
Description	Tappets
Application	All SB... All SN/NA/SK



TT KIT n°	CKSK.6
Maker	KNORR
OR kit n°	K001532
Description	Guides & Seals (New)
Application	All SB...



TT KIT n°	CKSK.8
Maker	KNORR
OR kit n°	-
Description	Complete overhaul
Application	All SB... All SN...



TT KIT n°	CKSK.8.1
Maker	KNORR
OR kit n°	Only TT
Description	Guides & Seals
Application	All SB... All SN...



TT KIT n°	CKSK.16/16.1
Maker	KNORR
OR kit n°	-
Description	Alu / Plastic cover
Application	All SB... All SN...



TT KIT n°	CKSK.10.3/10.4
Maker	KNORR
OR kit n°	-
Description	Adjusting Mechanism
Application	All SB... All SN...



TT KIT n°	CKSK.3.2
Maker	KNORR
OR kit n°	K000472
Description	Guide & Seals
Application	All SN...

Models



E' SERIES RENAISSANCE



Maker	MERITOR
Wheel size	22.5"

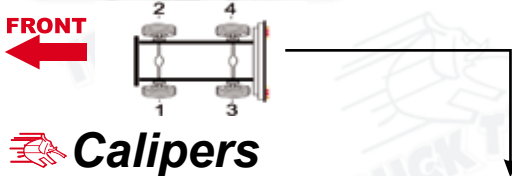

Calipers

Meritor part n°	TT n°	Side
LRG630	93.05.009	1-3
LRG631	93.05.010	2-4

Repair kits

MORE KITS : Page 214

	TT KIT n° CMSK.7
Maker	MERITOR
OR kit n°	SJ4078
Description	Boots & Seals
Application	LRG630 LRG631

	TT KIT n° CMSK.10/10.2
Maker	MERITOR
OR kit n°	SJ4113/4114
Description	Adjuster(L/R)
Application	LRG630 LRG631

	TT KIT n° CMSK.13
Maker	MERITOR
OR kit n°	SJ4076
Description	Guides & pins & sleeves
Application	LRG630 LRG631

	TT KIT n° CMSK.14
Maker	MERITOR
OR kit n°	SJ4031
Description	Needle & roller bearings
Application	LRG630 LRG631

	TT KIT n° CMSK.15/15.1
Maker	MERITOR
OR kit n°	SJ4073/4074
Description	Adjuster tappet L/R
Application	LRG630 LRG631

	TT KIT n° CMSK.11.3
Maker	MERITOR
OR kit n°	Only TT
Description	Steel balls
Application	LRG630 LRG631

	TT KIT n° CMSK.11.1/12.1
Maker	MERITOR
OR kit n°	Only TT
Description	Shaft
Application	LRG630 LRG631

	TT KIT n° CMSK.11.2/12.2
Maker	MERITOR
OR kit n°	Only TT
Description	Shaft support
Application	LRG630 LRG631

Models



REISBUSSE (3 AXLES)
SKYLINER (3 AXLES)
STARLINER (3 AXLES)

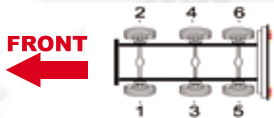

TT KIT ref.	WSSK.20.19
OR kit n°	LL310240062
Description	Wear Sensor

Maker	KNORR
Wheel size	22.5"
Angle of actuator	0°
Brake type	Axial
Wear sensor	In pad normally open

Calipers

Knorr type n°	TT n°	Side	Knorr part n°	Knorr rationalised n°
SB7893	91.03.004	1-3-5	K000044	SN7203
SB7883	91.03.003	2-4-6	K000043	SN7213

Repair kits

MORE KITS : Page 192



TT KIT n°	CKSK.6
Maker	KNORR
OR kit n°	K001532
Description	Guides & Seals (New)
Application	All SB...



TT KIT n°	CKSK.4 /4.2
Maker	KNORR
OR kit n°	K000944 / K001300
Description	Tappets
Application	All SB... All SN/NA/SK



TT KIT n°	CKSK.3.2
Maker	KNORR
OR kit n°	K000472
Description	Guide & Seals
Application	All SN...



TT KIT n°	CKSK.8
Maker	KNORR
OR kit n°	-
Description	Complete overhaul
Application	All SB... All SN...



TT KIT n°	CKSK.8.1
Maker	KNORR
OR kit n°	Only TT
Description	Guides & Seals
Application	All SB... All SN...



TT KIT n°	CKSK.16/16.1
Maker	KNORR
OR kit n°	Only TT
Description	Alu / Plastic cover
Application	All SB... All SN...



TT KIT n°	CKSK.10.3/10.4
Maker	KNORR
OR kit n°	-
Description	Adjusting Mechanism
Application	All SB... All SN...

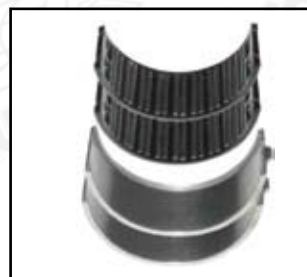

TT KIT n°	CKSK.14/14.1
Maker	KNORR
OR kit n°	-
Description	Roller Bearings
Application	All SB... All SN...

Models



CENTROLINER (3 AXLES)
Caliper fitted with a normally-open wear sensor

FRONT

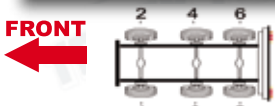

Calipers

	Knorr type n°	TT n°	Side	Knorr part n°	Knorr ration. n°
1	SB7883 (Axial)	91.03.003	1-5	K000043	SN7213
1	SB7893 (Axial)	91.03.004	2-6	K000044	SN7203
2	SB7123 (Radial)	91.03.051	3	II37812	SB7460
2	SB7133 (Radial)	91.03.052	4	II37813	SB7450

TT KIT ref.	WSSK.20.19
OR kit n°	LL310240062
Description	Wear Sensor

1.



Wheel size	22.5"
Brake type	Axial
Wear Sensor	In-pad

2.



Wheel size	22.5"
Brake type	Radial
Wear Sensor	In-pad

Repair kits

MORE KITS : Page 192

	TT KIT n°	CKSK.6
	Maker	KNORR
	OR kit n°	K001532
	Description	Guides & Seals (New)
	Application	All SB...

	TT KIT n°	CKSK.4 /4.2
	Maker	KNORR
	OR kit n°	K000944 / K001300
	Description	Tappets
	Application	All SB... All SN/NA/SK

	TT KIT n°	CKSK.3.2
	Maker	KNORR
	OR kit n°	K000472
	Description	Guide & Seals
	Application	All SN...

	TT KIT n°	CKSK.8
	Maker	KNORR
	OR kit n°	-
	Description	Complete overhaul
	Application	All SB... All SN...

	TT KIT n°	CKSK.8.1
	Maker	KNORR
	OR kit n°	Only TT
	Description	Guides & Seals
	Application	All SB... All SN...

	TT KIT n°	CKSK.16/16.1
	Maker	KNORR
	OR kit n°	-
	Description	Alu / Plastic cover
	Application	All SB... All SN...

	TT KIT n°	CKSK.10.3/10.4
	Maker	KNORR
	OR kit n°	-
	Description	Adjusting Mechanism
	Application	All SB... All SN...

	TT KIT n°	CKSK.14/14.1
	Maker	KNORR
	OR kit n°	-
	Description	Roller Bearings
	Application	All SB... All SN...

Models



CENTROLINER (3 AXLES)
Caliper fitted with a continuous potentiometer



Calipers

	Knorr type n°	TT n°	Side	Knorr part n°	Knorr ration. n°
1	SB7783 (Axial)	91.03.023	1-5	II37380	SN7216
1	SB7793 (Axial)	91.03.024	2-6	II37381	SN7206
2	SB7124 (Radial)	91.03.053	3	II37814	SB7461
2	SB7134 (Radial)	91.03.054	4	II37813	SB7450

1.



Wheel size	22.5"
Brake type	Axial
Potentiometer	Continuous

2.



Wheel size	22.5"
Brake type	Radial
Potentiometer	Continuous

Repair kits

MORE KITS : Page 192



TT KIT n°	CKSK.6
Maker	KNORR
OR kit n°	K001532
Description	Guides & Seals (New)
Application	All SB...



TT KIT n°	CKSK.4 / 4.2
Maker	KNORR
OR kit n°	K000944 / K001300
Description	Tappets
Application	All SB... All SN/NA/SK



TT KIT n°	CKSK.3.2
Maker	KNORR
OR kit n°	K000472
Description	Guide & Seals
Application	All SN...



TT KIT n°	CKSK.8
Maker	KNORR
OR kit n°	-
Description	Complete overhaul
Application	All SB... All SN...



TT KIT n°	CKSK.8.1
Maker	KNORR
OR kit n°	Only TT
Description	Guides & Seals
Application	All SB... All SN...



TT KIT n°	CKSK.16/16.1
Maker	KNORR
OR kit n°	-
Description	Alu / Plastic cover
Application	All SB... All SN...



TT KIT n°	CKSK.10.3/10.4
Maker	KNORR
OR kit n°	-
Description	Adjusting Mechanism
Application	All SB... All SN...

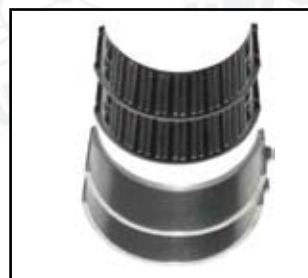

TT KIT n°	CKSK.14/14.1
Maker	KNORR
OR kit n°	-
Description	Roller Bearings
Application	All SB... All SN...

Models



REISBUSSE (3 AXLES)
SKYLINER (3 AXLES)
STARLINER (3 AXLES)

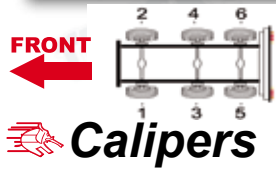

Maker	KNORR
Wheel size	22.5"
Angle of actuator	0°
Brake type	Axial
Potentiometer	Continuous

Knorr type n°	TT n°	Side	Knorr part n°	Knorr rationalised n°
SB7793	91.03.024	1-3-5	II37381	SN7206
SB7783	91.03.023	2-4-6	II37380	SN7216

Repair kits

MORE KITS : Page 192

	TT KIT n°	CKSK.6
	Maker	KNORR
	OR kit n°	K001532
	Description	Guides & Seals (New)
Application	All SB...	

	TT KIT n°	CKSK.4 / 4.2
	Maker	KNORR
	OR kit n°	K000944 / K001300
	Description	Tappets
Application	All SB... All SN/NA/SK	

	TT KIT n°	CKSK.3.2
	Maker	KNORR
	OR kit n°	K000472
	Description	Guide & Seals
Application	All SN...	

	TT KIT n°	CKSK.8
	Maker	KNORR
	OR kit n°	-
	Description	Complete overhaul
Application	All SB... All SN...	

	TT KIT n°	CKSK.8.1
	Maker	KNORR
	OR kit n°	Only TT
	Description	Guides & Seals
Application	All SB... All SN...	

	TT KIT n°	CKSK.16/16.1
	Maker	KNORR
	OR kit n°	-
	Description	Alu / Plastic cover
Application	All SB... All SN...	

	TT KIT n°	CKSK.10.3/10.4
	Maker	KNORR
	OR kit n°	-
	Description	Adjusting Mechanism
Application	All SB... All SN...	

	TT KIT n°	CKSK.14/14.1
	Maker	KNORR
	OR kit n°	-
	Description	Roller Bearings
Application	All SB... All SN...	

Models



- CENTROLINER (2 AXLES)**
Caliper fitted with a wear sensor, in pad
- CITYLINER (2 AXLES)**
Caliper fitted with a wear sensor, in pad
- SKYLINER (2 AXLES)**
Caliper fitted with a wear sensor, in pad
- STARLINER (2 AXLES)**
Caliper fitted with a wear sensor, in pad
- TRANSLINER (2 AXLES)**
Caliper fitted with a wear sensor, in pad

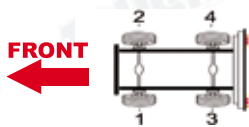

TT KIT ref.	WSSK.20.19
OR kit n°	LL310240062
Description	Wear Sensor

Maker	KNORR
Wheel size	22.5"
Angle of actuator	0°
Brake type	Axial
Wear sensor	In pad normally open

Calipers

Knorr type n°	TT n°	Side	Knorr part n°	Knorr rationalised n°
SB7883	91.03.003	1-3	K000043	SN7213
SB7893	91.03.004	2-4	K000044	SN7203

Repair kits

MORE KITS : Page 192

	<table border="1"> <tr><td>TT KIT n°</td><td>CKSK.6</td></tr> <tr><td>Maker</td><td>KNORR</td></tr> <tr><td>OR kit n°</td><td>K001532</td></tr> <tr><td>Description</td><td>Guides & Seals (New)</td></tr> <tr><td>Application</td><td>All SB...</td></tr> </table>	TT KIT n°	CKSK.6	Maker	KNORR	OR kit n°	K001532	Description	Guides & Seals (New)	Application	All SB...		<table border="1"> <tr><td>TT KIT n°</td><td>CKSK.4 /4.2</td></tr> <tr><td>Maker</td><td>KNORR</td></tr> <tr><td>OR kit n°</td><td>K000944 / K001300</td></tr> <tr><td>Description</td><td>Tappets</td></tr> <tr><td>Application</td><td>All SB... All SN/NA/SK</td></tr> </table>	TT KIT n°	CKSK.4 /4.2	Maker	KNORR	OR kit n°	K000944 / K001300	Description	Tappets	Application	All SB... All SN/NA/SK
TT KIT n°	CKSK.6																						
Maker	KNORR																						
OR kit n°	K001532																						
Description	Guides & Seals (New)																						
Application	All SB...																						
TT KIT n°	CKSK.4 /4.2																						
Maker	KNORR																						
OR kit n°	K000944 / K001300																						
Description	Tappets																						
Application	All SB... All SN/NA/SK																						
	<table border="1"> <tr><td>TT KIT n°</td><td>CKSK.3.2</td></tr> <tr><td>Maker</td><td>KNORR</td></tr> <tr><td>OR kit n°</td><td>K000472</td></tr> <tr><td>Description</td><td>Guide & Seals</td></tr> <tr><td>Application</td><td>All SN...</td></tr> </table>	TT KIT n°	CKSK.3.2	Maker	KNORR	OR kit n°	K000472	Description	Guide & Seals	Application	All SN...		<table border="1"> <tr><td>TT KIT n°</td><td>CKSK.8</td></tr> <tr><td>Maker</td><td>KNORR</td></tr> <tr><td>OR kit n°</td><td>-</td></tr> <tr><td>Description</td><td>Complete overhaul</td></tr> <tr><td>Application</td><td>All SB... All SN...</td></tr> </table>	TT KIT n°	CKSK.8	Maker	KNORR	OR kit n°	-	Description	Complete overhaul	Application	All SB... All SN...
TT KIT n°	CKSK.3.2																						
Maker	KNORR																						
OR kit n°	K000472																						
Description	Guide & Seals																						
Application	All SN...																						
TT KIT n°	CKSK.8																						
Maker	KNORR																						
OR kit n°	-																						
Description	Complete overhaul																						
Application	All SB... All SN...																						
	<table border="1"> <tr><td>TT KIT n°</td><td>CKSK.8.1</td></tr> <tr><td>Maker</td><td>KNORR</td></tr> <tr><td>OR kit n°</td><td>Only TT</td></tr> <tr><td>Description</td><td>Guides & Seals</td></tr> <tr><td>Application</td><td>All SB... All SN...</td></tr> </table>	TT KIT n°	CKSK.8.1	Maker	KNORR	OR kit n°	Only TT	Description	Guides & Seals	Application	All SB... All SN...		<table border="1"> <tr><td>TT KIT n°</td><td>CKSK.16/16.1</td></tr> <tr><td>Maker</td><td>KNORR</td></tr> <tr><td>OR kit n°</td><td>-</td></tr> <tr><td>Description</td><td>Alu / Plastic cover</td></tr> <tr><td>Application</td><td>All SB... All SN...</td></tr> </table>	TT KIT n°	CKSK.16/16.1	Maker	KNORR	OR kit n°	-	Description	Alu / Plastic cover	Application	All SB... All SN...
TT KIT n°	CKSK.8.1																						
Maker	KNORR																						
OR kit n°	Only TT																						
Description	Guides & Seals																						
Application	All SB... All SN...																						
TT KIT n°	CKSK.16/16.1																						
Maker	KNORR																						
OR kit n°	-																						
Description	Alu / Plastic cover																						
Application	All SB... All SN...																						
	<table border="1"> <tr><td>TT KIT n°</td><td>CKSK.10.3/10.4</td></tr> <tr><td>Maker</td><td>KNORR</td></tr> <tr><td>OR kit n°</td><td>-</td></tr> <tr><td>Description</td><td>Adjusting Mechanism</td></tr> <tr><td>Application</td><td>All SB... All SN...</td></tr> </table>	TT KIT n°	CKSK.10.3/10.4	Maker	KNORR	OR kit n°	-	Description	Adjusting Mechanism	Application	All SB... All SN...		<table border="1"> <tr><td>TT KIT n°</td><td>CKSK.14/14.1</td></tr> <tr><td>Maker</td><td>KNORR</td></tr> <tr><td>OR kit n°</td><td>-</td></tr> <tr><td>Description</td><td>Roller Bearings</td></tr> <tr><td>Application</td><td>All SB... All SN...</td></tr> </table>	TT KIT n°	CKSK.14/14.1	Maker	KNORR	OR kit n°	-	Description	Roller Bearings	Application	All SB... All SN...
TT KIT n°	CKSK.10.3/10.4																						
Maker	KNORR																						
OR kit n°	-																						
Description	Adjusting Mechanism																						
Application	All SB... All SN...																						
TT KIT n°	CKSK.14/14.1																						
Maker	KNORR																						
OR kit n°	-																						
Description	Roller Bearings																						
Application	All SB... All SN...																						

Models



CENTROLINER (2 AXLES)

Caliper fitted with a continuous potentiometer

CITYLINER (2 AXLES)

Caliper fitted with a continuous potentiometer

SKYLINER (2 AXLES)

Caliper fitted with a continuous potentiometer

STARLINER (2 AXLES)

Caliper fitted with a continuous potentiometer

TRANSLINER (2 AXLES)

Caliper fitted with a continuous potentiometer



Maker	KNORR
Wheel size	22.5"
Angle of actuator	0°
Brake type	Axial
Potentiometer	Continuous

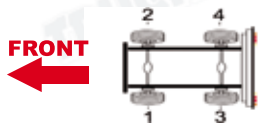

Calipers

Knorr type n°	TT n°	Side	Knorr part n°	Knorr rationalised n°
SB7783	91.03.023	1-3	II37380	SN7216
SB7793	91.03.024	2-4	II37381	SN7206

Repair kits

MORE KITS : Page 192

	TT KIT n°	CKSK.6
	Maker	KNORR
	OR kit n°	K001532
	Description	Guides & Seals (New)
Application	All SB...	

	TT KIT n°	CKSK.4 / 4.2
	Maker	KNORR
	OR kit n°	K000944 / K001300
	Description	Tappets
Application	All SB... All SN/NA/SK	

	TT KIT n°	CKSK.3.2
	Maker	KNORR
	OR kit n°	K000472
	Description	Guide & Seals
Application	All SN...	

	TT KIT n°	CKSK.8
	Maker	KNORR
	OR kit n°	-
	Description	Complete overhaul
Application	All SB... All SN...	

	TT KIT n°	CKSK.8.1
	Maker	KNORR
	OR kit n°	Only TT
	Description	Guides & Seals
Application	All SB... All SN...	

	TT KIT n°	CKSK.16/16.1
	Maker	KNORR
	OR kit n°	-
	Description	Alu / Plastic cover
Application	All SB... All SN...	

	TT KIT n°	CKSK.10.3/10.4
	Maker	KNORR
	OR kit n°	-
	Description	Adjusting Mechanism
Application	All SB... All SN...	

	TT KIT n°	CKSK.14/14.1
	Maker	KNORR
	OR kit n°	-
	Description	Roller Bearings
Application	All SB... All SN...	

Models



LINIENBUS (3 AXLES)
Caliper fitted with a wear sensor, in pad

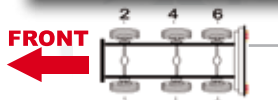

Calipers

TT KIT ref.	WSSK.20.19
OR kit n°	LL310240062
Description	Wear Sensor

1.



Wheel size	22.5"
Brake type	Axial
Wear sensor	In pad

2.



Wheel size	22.5"
Brake type	Radial
Wear sensor	In pad

Repair kits

MORE KITS : Page 192

	TT KIT n°	CKSK.6
	Maker	KNORR
	OR kit n°	K001532
	Description	Guides & Seals (New)
	Application	All SB...

	TT KIT n°	CKSK.4 /4.2
	Maker	KNORR
	OR kit n°	K000944 / K001300
	Description	Tappets
	Application	All SB... All SN/NA/SK

	TT KIT n°	CKSK.3.2
	Maker	KNORR
	OR kit n°	K000472
	Description	Guide & Seals
	Application	All SN...

	TT KIT n°	CKSK.8
	Maker	KNORR
	OR kit n°	-
	Description	Complete overhaul
	Application	All SB... All SN...

	TT KIT n°	CKSK.8.1
	Maker	KNORR
	OR kit n°	Only TT
	Description	Guides & Seals
	Application	All SB... All SN...

	TT KIT n°	CKSK.16/16.1
	Maker	KNORR
	OR kit n°	-
	Description	Alu / Plastic cover
	Application	All SB... All SN...

	TT KIT n°	CKSK.10.3/10.4
	Maker	KNORR
	OR kit n°	-
	Description	Adjusting Mechanism
	Application	All SB... All SN...

	TT KIT n°	CKSK.14/14.1
	Maker	KNORR
	OR kit n°	-
	Description	Roller Bearings
	Application	All SB... All SN...

Models



LINIENBUS (3 AXLES)
Caliper fitted with a continuous potentiometer

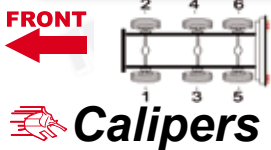

1.



Wheel size	22.5"
Brake type	Axial
Potentiometer	Continuous

2.



Wheel size	22.5"
Brake type	Radial
Potentiometer	Continuous

	Knorr type n°	TT n°	Side	Knorr part n°	Knorr ration. n°
1	SB7783 (Axial)	91.03.023	1-5	II37380	SN7216
1	SB7793 (Axial)	91.03.024	2-6	II37381	SN7206
2	SB7124 (Radial)	91.03.053	3	II37814	SB7461
2	SB7134 (Radial)	91.03.054	4	II37813	SB7450

Repair kits

MORE KITS : Page 192



TT KIT n°	CKSK.6
Maker	KNORR
OR kit n°	K001532
Description	Guides & Seals (New)
Application	All SB...



TT KIT n°	CKSK.4 /4.2
Maker	KNORR
OR kit n°	K000944 / K001300
Description	Tappets
Application	All SB... All SN/NA/SK



TT KIT n°	CKSK.3.2
Maker	KNORR
OR kit n°	K000472
Description	Guide & Seals
Application	All SN...



TT KIT n°	CKSK.8
Maker	KNORR
OR kit n°	-
Description	Complete overhaul
Application	All SB... All SN...



TT KIT n°	CKSK.8.1
Maker	KNORR
OR kit n°	Only TT
Description	Guides & Seals
Application	All SB... All SN...



TT KIT n°	CKSK.16/16.1
Maker	KNORR
OR kit n°	-
Description	Alu / Plastic cover
Application	All SB... All SN...



TT KIT n°	CKSK.10.3/10.4
Maker	KNORR
OR kit n°	-
Description	Adjusting Mechanism
Application	All SB... All SN...



TT KIT n°	CKSK.14/14.1
Maker	KNORR
OR kit n°	-
Description	Roller Bearings
Application	All SB... All SN...

Models



LINIENBUS (2 AXLES)
Caliper fitted with a wear sensor, in pad

FRONT



Calipers

TT KIT ref.	WSSK.20.19
OR kit n°	LL310240062
Description	Wear Sensor

1.



Wheel size	22.5"
Brake type	Axial
Wear sensor	In pad

2.



Wheel size	22.5"
Brake type	Radial
Wear sensor	In pad

	Knorr type n°	TT n°	Side	Knorr part n°	Knorr ration. n°
1	SB7883 (Axial)	91.03.003	1-5	K000043	SN7213
1	SB7893 (Axial)	91.03.004	2-6	K000044	SN7203
2	SB7123 (Radial)	91.03.051	3	II37812	SB7460
2	SB7133 (Radial)	91.03.052	4	II37813	SB7450

Repair kits

MORE KITS : Page 192



TT KIT n°	CKSK.6
Maker	KNORR
OR kit n°	K001532
Description	Guides & Seals (New)
Application	All SB...



TT KIT n°	CKSK.4 /4.2
Maker	KNORR
OR kit n°	K000944 / K001300
Description	Tappets
Application	All SB... All SN/NA/SK



TT KIT n°	CKSK.3.2
Maker	KNORR
OR kit n°	K000472
Description	Guide & Seals
Application	All SN...



TT KIT n°	CKSK.8
Maker	KNORR
OR kit n°	-
Description	Complete overhaul
Application	All SB... All SN...



TT KIT n°	CKSK.8.1
Maker	KNORR
OR kit n°	Only TT
Description	Guides & Seals
Application	All SB... All SN...



TT KIT n°	CKSK.16/16.1
Maker	KNORR
OR kit n°	-
Description	Alu / Plastic cover
Application	All SB... All SN...



TT KIT n°	CKSK.10.3/10.4
Maker	KNORR
OR kit n°	-
Description	Adjusting Mechanism
Application	All SB... All SN...



TT KIT n°	CKSK.14/14.1
Maker	KNORR
OR kit n°	-
Description	Roller Bearings
Application	All SB... All SN...

Models



LINIENBUS (2 AXLES)
Caliper fitted with a continuous potentiometer



Calipers

	Knorr type n°	TT n°	Side	Knorr part n°	Knorr ration. n°
1	SB7783 (Axial)	91.03.023	1-5	II37380	SN7216
1	SB7793 (Axial)	91.03.024	2-6	II37381	SN7206
2	SB7124 (Radial)	91.03.053	3	II37814	SB7461
2	SB7134 (Radial)	91.03.054	4	II37813	SB7450

1.



Wheel size	22.5"
Brake type	Axial
Potentiometer	Continuous

2.



Wheel size	22.5"
Brake type	Radial
Potentiometer	Continuous

Repair kits

MORE KITS : [Page 192](#)



TT KIT n°	CKSK.6
Maker	KNORR
OR kit n°	K001532
Description	Guides & Seals (New)
Application	All SB...



TT KIT n°	CKSK.4 /4.2
Maker	KNORR
OR kit n°	K000944 / K001300
Description	Tappets
Application	All SB... All SN/NA/SK



TT KIT n°	CKSK.3.2
Maker	KNORR
OR kit n°	K000472
Description	Guide & Seals
Application	All SN...



TT KIT n°	CKSK.8
Maker	KNORR
OR kit n°	-
Description	Complete overhaul
Application	All SB... All SN...



TT KIT n°	CKSK.8.1
Maker	KNORR
OR kit n°	Only TT
Description	Guides & Seals
Application	All SB... All SN...



TT KIT n°	CKSK.16/16.1
Maker	KNORR
OR kit n°	-
Description	Alu / Plastic cover
Application	All SB... All SN...



TT KIT n°	CKSK.10.3/10.4
Maker	KNORR
OR kit n°	-
Description	Adjusting Mechanism
Application	All SB... All SN...

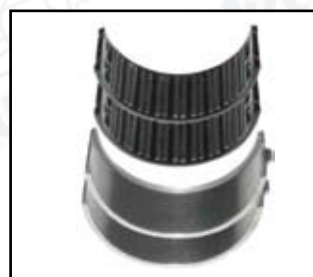

TT KIT n°	CKSK.14/14.1
Maker	KNORR
OR kit n°	-
Description	Roller Bearings
Application	All SB... All SN...

Models



COACHES

Type N8008

METROLINER



Maker	WABCO
-------	-------

Models	Caliper type
All	1000 V-G

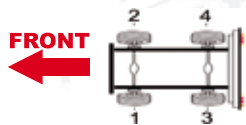

Calipers

Wabco part n°	TT n°	Side
40 100 003	92.04.003	1-4
40 100 004	92.04.004	2-3

Repair kits

	TT KIT n°	CWSK.3
	Maker	WABCO
	OR kit n°	12.999.729
	Description	Guides & seals
	Application	All these calipers

Models



M140 - 15T

From 04.1996



Maker	MERITOR
Wheel size	19.5"

Calipers

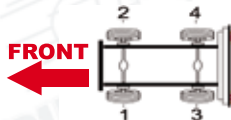

Meritor part n°	TT n°	Side
LRG554	93.05.005	1
LRG555	93.05.006	2

Repair kits

MORE KITS : [Page 218](#)

	TT KIT n°	CMSK.54
	Maker	MERITOR
	OR kit n°	SJ4052
	Description	Guides & Pins
	Application	LRG554 LRG555

	TT KIT n°	CMSK.10/10.2
	Maker	MERITOR
	OR kit n°	SJ4113/4114
	Description	Adjuster(L/R)
	Application	LRG554 LRG555

	TT KIT n°	CMSK.14
	Maker	MERITOR
	OR kit n°	SJ4031
	Description	Needle & roller bearings
	Application	LRG554 LRG555

	TT KIT n°	CMSK.11.3
	Maker	MERITOR
	OR kit n°	Only TT
	Description	Steel balls
	Application	LRG554 LRG555

	TT KIT n°	CMSK.15/15.1
	Maker	MERITOR
	OR kit n°	SJ4073/4074
	Description	Adjuster tappet L/R
	Application	LRG554 LRG555

	TT KIT n°	CMSK.11.2/12.2
	Maker	MERITOR
	OR kit n°	Only TT
	Description	Shaft support
	Application	LRG554 LRG555

	TT KIT n°	CMSK.11.1/12.1
	Maker	MERITOR
	OR kit n°	Only TT
	Description	Shaft
	Application	LRG554 LRG555

Models



TRANSIT BUS (ZF AXLE)

To 1998

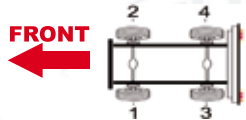

Maker	MERITOR
Wheel size	19.5"

Calipers

Meritor part n°	TT n°	Side
LRG554	93.05.005	1
LRG555	93.05.006	2

Repair kits

MORE KITS : [Page 218](#)

	TT KIT n°	CMSK.54
	Maker	MERITOR
	OR kit n°	SJ4052
	Description	Guides & Pins
Application	LRG554 LRG555	

	TT KIT n°	CMSK.10/10.2
	Maker	MERITOR
	OR kit n°	SJ4113/4114
	Description	Adjuster(L/R)
Application	LRG554 LRG555	

	TT KIT n°	CMSK.14
	Maker	MERITOR
	OR kit n°	SJ4031
	Description	Needle & roller bearings
Application	LRG554 LRG555	

	TT KIT n°	CMSK.11.3
	Maker	MERITOR
	OR kit n°	Only TT
	Description	Steel balls
Application	LRG554 LRG555	

	TT KIT n°	CMSK.15/15.1
	Maker	MERITOR
	OR kit n°	SJ4073/4074
	Description	Adjuster tappet L/R
Application	LRG554 LRG555	

	TT KIT n°	CMSK.11.2/12.2
	Maker	MERITOR
	OR kit n°	Only TT
	Description	Shaft support
Application	LRG554 LRG555	

	TT KIT n°	CMSK.11.1/12.1
	Maker	MERITOR
	OR kit n°	Only TT
	Description	Shaft
Application	LRG554 LRG555	

Models



Ø 22.5" Wheels

(-12° head of caliper)

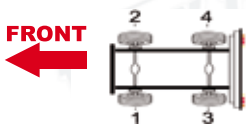

TT KIT n°	WSSK.20.19
OR kit n°	LL310240062
Description	Wear Sensor

Maker	KNORR
Brake type	Axial
Wear sensor	In pad, normally open

Calipers

Knorr type n°	TT n°	Side	Knorr part n°	Knorr rationalised n°
SB7723 (22.5"/-12°)	91.03.001	1	I134820	SN7195
SB7733 (22.5"/-12°)	91.03.002	2	I134821	SN7185

Repair kits

MORE KITS : Page 218

	TT KIT n°	CKSK.1
	Maker	KNORR
	OR kit n°	I1328090062
	Description	Guides & Seals
	Application	All SB...

	TT KIT n°	CKSK.4 /4.2
	Maker	KNORR
	OR kit n°	K000944 / K001300
	Description	Tappets
	Application	All SB... All SN/NA/SK

	TT KIT n°	CKSK.6
	Maker	KNORR
	OR kit n°	K001532
	Description	Guides & Seals (New)
	Application	All SB...

	TT KIT n°	CKSK.8
	Maker	KNORR
	OR kit n°	-
	Description	Complete overhaul
	Application	All SB... All SN...

	TT KIT n°	CKSK.8.1
	Maker	KNORR
	OR kit n°	Only TT
	Description	Guides & Seals
	Application	All SB... All SN...

	TT KIT n°	CKSK.16/16.1
	Maker	KNORR
	OR kit n°	Only TT
	Description	Alu / Plastic cover
	Application	All SB... All SN...

	TT KIT n°	CKSK.10.3/10.4
	Maker	KNORR
	OR kit n°	-
	Description	Adjusting Mechanism
	Application	All SB... All SN...

	TT KIT n°	CKSK.3.2
	Maker	KNORR
	OR kit n°	K000472
	Description	Guide & Seals
	Application	All SN...

Models

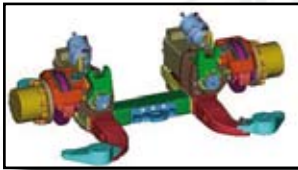

ROR AXLE (Ø19.5" wheels) TRAILER APPLICATIONS

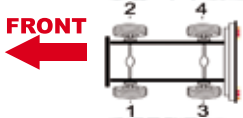

Maker **MERITOR**

Calipers

Meritor part n°	TT n°	Side
15224836SR (19.5") (*1)	93.07.001	1
DX.195.51 (19.5") (*1)	93.07.001	1
15224837SR (19.5") (*1)	93.07.002	2
DX.195.52 (19.5") (*1)	93.07.002	2

DX.195.51 = 15224836SR

DX.195.52 = 15224837SR

Repair kits

MORE KITS : [Page 214](#)

	TT KIT n°	CMSK.2
	Maker	MERITOR
	OR kit n°	MCK1168
	Description	Shaft fittings
	Application	DX195.51 DX195.52

	TT KIT n°	CMSK.2.D
	Maker	MERITOR
	OR kit n°	DSB.3
	Description	Roller bearings (full)
	Application	DX195.51 DX195.52

	TT KIT n°	CMSK.2.E/F
	Maker	MERITOR
	OR kit n°	DSB.5 R/L
	Description	Adjusting mechanism (light)
	Application	DX.195.52 DX.195.51

	TT KIT n°	CMSK.8
	Maker	MERITOR
	OR kit n°	MCK1171
	Description	Complete overhaul
	Application	DX195.51 DX195.52

	TT KIT n°	CMSK.2.1
	Maker	MERITOR
	OR kit n°	MCK1192
	Description	Boot, cap & screws
	Application	DX195.51 DX195.52

	TT KIT n°	CMSK.2.GR
	Maker	MERITOR
	OR kit n°	-
	Description	SHAFT (with grease nipple)
	Application	DX.195.51 DX.195.52

	TT KIT n°	CMSK.9.1/9.2
	Maker	MERITOR
	OR kit n°	Only TT
	Description	Brake pad support (L/R)
	Application	DX.195.51 DX.195.52

	TT KIT n°	CMSK.19/20
	Maker	MERITOR
	OR kit n°	DSB.6 R /L
	Description	Bridge & tubes
	Application	DX.195.52 DX.195.51

Models

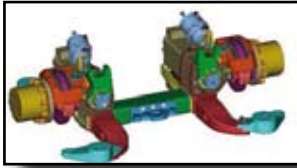

- Ø 22.5" (*1) (LM Model) From 02.2000 to 01.2002
- Ø 22.5" (*1) (TA Model) From 02.2000 to 01.2002
- Ø 22.5" (*2) (LM Model) From 07.2001
- Ø 22.5" (*2) (TA Model) From 07.2001
- Ø 22.5" (*3) (TA Model) From 01.2002
- Ø 22.5" (*3) (TAC Model) From 01.2002

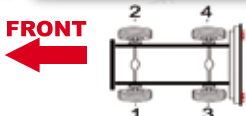

Calipers

Maker **MERITOR**

Meritor part n°	TT n°	Side
LRG536 (22.5")(*1)	93.06.017	1
LRG537 (22.5")(*1)	93.06.018	2
LRG572 (22.5")(*2)	93.08.023	1
LRG573 (22.5")(*2)	93.08.024	2
LRG578 (22.5")(*3)	93.06.001	1
LRG579 (22.5")(*3)	93.06.002	2

Repair kits

MORE KITS : Page 218

	TT KIT n°	CMSK.3.13
	Maker	MERITOR
	OR kit n°	SJ4111
	Description	Visual pad Wear assembly
Application	LRG536/37 LRG578/79	

	TT KIT n°	CMSK.3.3
	Maker	MERITOR
	OR kit n°	SJ4112
	Description	Bearings
Application	LRG536/37 LRG578/79	

	TT KIT n°	CMSK.3.1
	Maker	MERITOR
	OR kit n°	MCK1134
	Description	Guide Pin
Application	LRG536/37 LRG578/79	

	TT KIT n°	CMSK.3.2/4.2
	Maker	MERITOR
	OR kit n°	MCK1236/37
	Description	Adjuster tappet (L/R)
Application	LRG536/37 LRG578/79	

	TT KIT n°	CMSK.3.14
	Maker	MERITOR
	OR kit n°	MCK1299
	Description	Guide Pin Bolt & Dust Cover
Application	LRG536/37 LRG578/79	

	TT KIT n°	CMSK.3.5
	Maker	MERITOR
	OR kit n°	MCK1238
	Description	Tappet Head
Application	LRG536/37 LRG578/79	

	TT KIT n°	CMSK.3.7
	Maker	MERITOR
	OR kit n°	SJ4105
	Description	Cover Plate Seal
Application	LRG536/37 LRG578/79	

	TT KIT n°	CMSK.3.11
	Maker	MERITOR
	OR kit n°	68322900PK10
	Description	Tappet Anti Rotation plate
Application	LRG536/37 LRG578/79	

Models

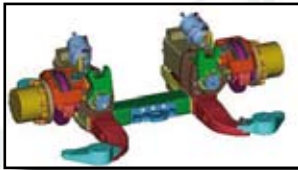

- LM ELSA 195**
From 01.2003 to 06.2004
- TM ELSA 195**
From 06.2004
- TA ELSA 2**
From 07.2001



Maker **MERITOR**

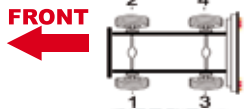

Calipers

Meritor part n°	TT n°	Side
LRG702	93.07.005	2
LRG703	93.07.006	1

Repair kits

	TT KIT n°	CMSK.3.3
	Maker	MERITOR
	OR kit n°	SJ4112
	Description	Bearings
Application	All these calipers	

	TT KIT n°	CMSK.7.7
	Maker	MERITOR
	OR kit n°	
	Description	Tappets
Application	All these calipers	

	TT KIT n°	CMSK.3.12
	Maker	MERITOR
	OR kit n°	MCK.1264
	Description	Pad retainer
Application	All these calipers	

	TT KIT n°	CMSK.7.1
	Maker	MERITOR
	OR kit n°	MCK.1254
	Description	Guide pin seals & screws
Application	All these calipers	

	TT KIT n°	CMSK.7.2
	Maker	MERITOR
	OR kit n°	68323746PK10
	Description	Actuator Seal
Application	All these calipers	

	TT KIT n°	CMSK.7.4
	Maker	MERITOR
	OR kit n°	
	Description	Adjusting mechanism sealing
Application	All these calipers	

	TT KIT n°	CMSK.18
	Maker	MERITOR
	OR kit n°	MCK.1139
	Description	Adjuster Tap Kit
Application	All these calipers	

	TT KIT n°	CMSK.7.4
	Maker	MERITOR
	OR kit n°	
	Description	Adjusting mechanism sealing
Application	All these calipers	

Models



AGORA

From 11.1997

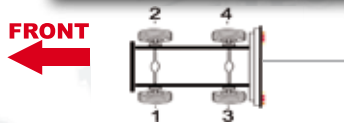

Calipers

	Meritor part n°	TT n°	Side
1	LRG548	91.05.001	1
1	LRG549	93.05.002	2
2	LRG642	93.08.007	3
2	LRG643	93.08.008	4

TT KIT n°	WSSK.20.32
OR kit n°	5001848363
Description	Wear Sensor

1.



Maker	MERITOR
Wheel size	22.5"

2.



Maker	MERITOR
Wheel size	22.5"

Repair kits

MORE KITS : [Page 214](#)

	TT KIT n°	CMSK.5
	Maker	MERITOR
	OR kit n°	MCK1102
	Description	Guides & bushes
	Application	LRG642 LRG643

	TT KIT n°	CMSK.3.3
	Maker	MERITOR
	OR kit n°	SJ4112
	Description	Half bearing
	Application	LRG642 LRG643

	TT KIT n°	CMSK.7
	Maker	MERITOR
	OR kit n°	SJ4078
	Description	Boots & Seals
	Application	LRG548 LRG549

	TT KIT n°	CMSK.10/10.2
	Maker	MERITOR
	OR kit n°	SJ4113/4114
	Description	Adjuster(L/R)
	Application	LRG548 LRG549

	TT KIT n°	CMSK.13
	Maker	MERITOR
	OR kit n°	SJ4076
	Description	Guides & pins & sleeves
	Application	LRG548 LRG549

	TT KIT n°	CMSK.14
	Maker	MERITOR
	OR kit n°	SJ4031
	Description	Needle & roller bearings
	Application	LRG548 LRG549

	TT KIT n°	CMSK.15/15.1
	Maker	MERITOR
	OR kit n°	SJ4073/4074
	Description	Adjuster tappet L/R
	Application	LRG548 LRG549

	TT KIT n°	CMSK.11.1/12.1
	Maker	MERITOR
	OR kit n°	Only TT
	Description	Shaft
	Application	LRG548 LRG549

General catalogue HEAVY DUTY VEHICLES ROR RV

Models



ARES



Maker	MERITOR
Wheel size	22.5"

FRONT

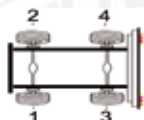

Calipers

Meritor part n°	TT n°	Side
LRG658	93.08.021	1
LRG659	93.08.022	2

Repair kits

	TT KIT n°	CMSK.26
	Maker	MERITOR
	OR kit n°	MCK1243
	Description	Guide & Pin
	Application	LRG658 LRG659

	TT KIT n°	CMSK.8.13
	Maker	MERITOR
	OR kit n°	MCK1240
	Description	Visual Wear Assy
	Application	LRG658 LRG659

Models



FR1



Maker	PONT A MOUSSON
Brake type	6 pistons



Calipers

Pont A Mousson part n°	TT n°	Side
5010197252	96.02.001	1
5010197253	96.02.002	2

Repair kits

	TT KIT n°	CPSK.1
	Maker	Pont AMousson
	OR kit n°	-
	Description	Piston
	Application	5010197252 5010197253

	TT KIT n°	CPSK.2
	Maker	Pont AMousson
	OR kit n°	-
	Description	Seals
	Application	5010197252 5010197253

RM

General catalogue HEAVY DUTY VEHICLES

Models



R312



Maker	BREMBO
Wheel size	19.5"



Calipers

Brembo part n°	TT n°	Side
20.5320.12	95.02.001	1
20.5320.22	95.02.002	2
20.5320.32	95.02.003	3
20.5320.42	95.02.004	4
22.5400.30	95.11.001	Handbrake

Repair kits

	<table border="1"> <tr> <td>TT KIT n°</td> <td>CBRSK.1</td> </tr> <tr> <td>Maker</td> <td>BREMBO</td> </tr> <tr> <td>OR kit n°</td> <td>-</td> </tr> <tr> <td>Description</td> <td>Pistons</td> </tr> <tr> <td>Application</td> <td>20.5320.12/ 22/32/42</td> </tr> </table>	TT KIT n°	CBRSK.1	Maker	BREMBO	OR kit n°	-	Description	Pistons	Application	20.5320.12/ 22/32/42		<table border="1"> <tr> <td>TT KIT n°</td> <td>CBRSK.2</td> </tr> <tr> <td>Maker</td> <td>BREMBO</td> </tr> <tr> <td>OR kit n°</td> <td>-</td> </tr> <tr> <td>Description</td> <td>Complete overhaul</td> </tr> <tr> <td>Application</td> <td>20.5320.12/ 22/32/42</td> </tr> </table>	TT KIT n°	CBRSK.2	Maker	BREMBO	OR kit n°	-	Description	Complete overhaul	Application	20.5320.12/ 22/32/42
TT KIT n°	CBRSK.1																						
Maker	BREMBO																						
OR kit n°	-																						
Description	Pistons																						
Application	20.5320.12/ 22/32/42																						
TT KIT n°	CBRSK.2																						
Maker	BREMBO																						
OR kit n°	-																						
Description	Complete overhaul																						
Application	20.5320.12/ 22/32/42																						
<p>OUT Ø : 70mm Thickness : 4mm</p>	<table border="1"> <tr> <td>TT KIT n°</td> <td>CBRSK.3</td> </tr> <tr> <td>Maker</td> <td>BREMBO</td> </tr> <tr> <td>OR kit n°</td> <td>120.4684.28</td> </tr> <tr> <td>Description</td> <td>Piston + Sealing Thick Model</td> </tr> <tr> <td>Application</td> <td>20.5320.12/ 22/32/42</td> </tr> </table>	TT KIT n°	CBRSK.3	Maker	BREMBO	OR kit n°	120.4684.28	Description	Piston + Sealing Thick Model	Application	20.5320.12/ 22/32/42	<p>OUT Ø : 66mm Thickness : 3mm</p>	<table border="1"> <tr> <td>TT KIT n°</td> <td>CBRSK.4</td> </tr> <tr> <td>Maker</td> <td>BREMBO</td> </tr> <tr> <td>OR kit n°</td> <td>120.4684.27</td> </tr> <tr> <td>Description</td> <td>Piston + Sealing Thin Model</td> </tr> <tr> <td>Application</td> <td>20.5320.12/ 22/32/42</td> </tr> </table>	TT KIT n°	CBRSK.4	Maker	BREMBO	OR kit n°	120.4684.27	Description	Piston + Sealing Thin Model	Application	20.5320.12/ 22/32/42
TT KIT n°	CBRSK.3																						
Maker	BREMBO																						
OR kit n°	120.4684.28																						
Description	Piston + Sealing Thick Model																						
Application	20.5320.12/ 22/32/42																						
TT KIT n°	CBRSK.4																						
Maker	BREMBO																						
OR kit n°	120.4684.27																						
Description	Piston + Sealing Thin Model																						
Application	20.5320.12/ 22/32/42																						
	<table border="1"> <tr> <td>TT KIT n°</td> <td>CBRSK.5</td> </tr> <tr> <td>Maker</td> <td>BREMBO</td> </tr> <tr> <td>OR kit n°</td> <td>120.5468.10</td> </tr> <tr> <td>Description</td> <td>Piston hat Cap & O rings</td> </tr> <tr> <td>Application</td> <td>20.5320.12/ 22/32/42</td> </tr> </table>	TT KIT n°	CBRSK.5	Maker	BREMBO	OR kit n°	120.5468.10	Description	Piston hat Cap & O rings	Application	20.5320.12/ 22/32/42	<p>OUT Ø : 70 mm Thickness : 4 mm</p>	<table border="1"> <tr> <td>TT KIT n°</td> <td>CBRSK.6</td> </tr> <tr> <td>Maker</td> <td>BREMBO</td> </tr> <tr> <td>OR kit n°</td> <td>120.4684.25</td> </tr> <tr> <td>Description</td> <td>Complete sealing kit (thick model)</td> </tr> <tr> <td>Application</td> <td>20.5320.12/ 22/32/42</td> </tr> </table>	TT KIT n°	CBRSK.6	Maker	BREMBO	OR kit n°	120.4684.25	Description	Complete sealing kit (thick model)	Application	20.5320.12/ 22/32/42
TT KIT n°	CBRSK.5																						
Maker	BREMBO																						
OR kit n°	120.5468.10																						
Description	Piston hat Cap & O rings																						
Application	20.5320.12/ 22/32/42																						
TT KIT n°	CBRSK.6																						
Maker	BREMBO																						
OR kit n°	120.4684.25																						
Description	Complete sealing kit (thick model)																						
Application	20.5320.12/ 22/32/42																						
<p>OUT Ø : 66 mm Thickness : 3 mm</p>	<table border="1"> <tr> <td>TT KIT n°</td> <td>CBRSK.7</td> </tr> <tr> <td>Maker</td> <td>BREMBO</td> </tr> <tr> <td>OR kit n°</td> <td>120.4684.26</td> </tr> <tr> <td>Description</td> <td>Complete sealing kit (thick model)</td> </tr> <tr> <td>Application</td> <td>20.5320.12/ 22/32/42</td> </tr> </table>	TT KIT n°	CBRSK.7	Maker	BREMBO	OR kit n°	120.4684.26	Description	Complete sealing kit (thick model)	Application	20.5320.12/ 22/32/42		<table border="1"> <tr> <td>TT KIT n°</td> <td>CBRSK.8</td> </tr> <tr> <td>Maker</td> <td>BREMBO</td> </tr> <tr> <td>OR kit n°</td> <td>105.3246.25</td> </tr> <tr> <td>Description</td> <td>Bleeders</td> </tr> <tr> <td>Application</td> <td>20.5320.12/ 22/32/42</td> </tr> </table>	TT KIT n°	CBRSK.8	Maker	BREMBO	OR kit n°	105.3246.25	Description	Bleeders	Application	20.5320.12/ 22/32/42
TT KIT n°	CBRSK.7																						
Maker	BREMBO																						
OR kit n°	120.4684.26																						
Description	Complete sealing kit (thick model)																						
Application	20.5320.12/ 22/32/42																						
TT KIT n°	CBRSK.8																						
Maker	BREMBO																						
OR kit n°	105.3246.25																						
Description	Bleeders																						
Application	20.5320.12/ 22/32/42																						

Models





MAGNUM AE

From 02.1992 to 03.1997

PREMIUM

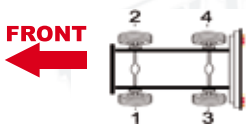
From 06.1996 to 05.1997



	TT KIT ref.	WSSK.20.17
	OR kit n°	5001834075
	Description	Wear Sensor

Maker	MERITOR
Wheel size	22.5"

Calipers

Meritor part n°	TT n°	Side
LRG526	93.04.003	1-3
LRG527	93.04.004	2-4

Repair kits

MORE KITS : [Page 204](#)

	TT KIT n°	CMSK.1
	Maker	MERITOR
	OR kit n°	SJ4001
	Description	Guides & Seals
	Application	LRG526 LRG527

	TT KIT n°	CMSK.6
	Maker	MERITOR
	OR kit n°	SJ1212
	Description	Cover & Boots
	Application	LRG526 LRG527

	TT KIT n°	CMSK.24.3/25.3
	Maker	MERITOR
	OR kit n°	-
	Description	Clutch mechanism
	Application	LRG526 LRG527

	TT KIT n°	CMSK.24.4/25.4
	Maker	MERITOR
	OR kit n°	-
	Description	Adjuster tappet
	Application	LRG526 LRG527

	TT KIT n°	CMSK.24/25
	Maker	MERITOR
	OR kit n°	-
	Description	Shaft
	Application	LRG526 LRG527

	TT KIT n°	CMSK.24.1/25.1
	Maker	MERITOR
	OR kit n°	-
	Description	Support - spiral
	Application	LRG526 LRG527

	TT KIT n°	CMSK.24.2
	Maker	MERITOR
	OR kit n°	-
	Description	Roller
	Application	LRG526 LRG527

	TT KIT n°	CMSK.24.7
	Maker	MERITOR
	OR kit n°	-
	Description	Shaft Roller Bearing
	Application	LRG526 LRG527

Models



MAGNUM AE

From 04.1997

PREMIUM

From 06.1997 to 01.2001



FRONT

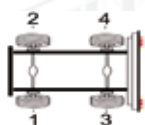

	TT KIT ref.	WSSK.20.17
	OR kit n°	5001834075
	Description	Wear Sensor

Maker	MERITOR
Wheel size	22.5"

Calipers

Meritor part n°	TT n°	Side
LRG548	93.05.001	1-3
LRG549	93.05.002	2-4

Repair kits

MORE KITS : Page 214

	TT KIT n°	CMSK.7
	Maker	MERITOR
	OR kit n°	SJ4078
	Description	Boots & Seals
	Application	LRG548 LRG549

	TT KIT n°	CMSK.10/10.2
	Maker	MERITOR
	OR kit n°	SJ4113/4114
	Description	Adjuster(L/R)
	Application	LRG548 LRG549

	TT KIT n°	CMSK.13
	Maker	MERITOR
	OR kit n°	SJ4076
	Description	Guides & pins & sleeves
	Application	LRG548 LRG549

	TT KIT n°	CMSK.14
	Maker	MERITOR
	OR kit n°	SJ4031
	Description	Needle & roller bearings
	Application	LRG548 LRG549

	TT KIT n°	CMSK.15/15.1
	Maker	MERITOR
	OR kit n°	SJ4073/4074
	Description	Adjuster tappet L/R
	Application	LRG548 LRG549

	TT KIT n°	CMSK.11.3
	Maker	MERITOR
	OR kit n°	Only TT
	Description	Steel balls
	Application	LRG548 LRG549

	TT KIT n°	CMSK.11.1/12.1
	Maker	MERITOR
	OR kit n°	Only TT
	Description	Shaft
	Application	LRG548 LRG549

	TT KIT n°	CMSK.11.2/12.2
	Maker	MERITOR
	OR kit n°	Only TT
	Description	Shaft support
	Application	LRG548 LRG549

 **Models**



MAGNUM AE

From 04.2000 to 02.2002

PREMIUM

From 04.2000 to 02.2002

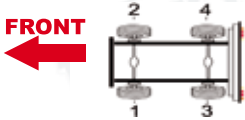

Maker	MERITOR
Wheel size	22.5"

 **Calipers**

Meritor part n°	TT n°	Side
LRG580	93.09.003	1
LRG581	93.09.004	2
LRG582	93.08.025	3
LRG583	93.08.026	4

 **Repair kits**

	TT KIT n°	CMSK.18
	Maker	MERITOR
	OR kit n°	MCK1139
	Description	Adjuster tap kit
	Application	LRG580 LRG581

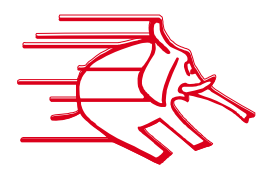
 NO PICTURE AVAILABLE	TT KIT n°	U.D.
	Maker	MERITOR
	OR kit n°	MCK1086
	Description	Guide pin
	Application	All these calipers

 **Models**



MIDLINER S120

From 03.1992

MIDLINER S140

From 03.1992



Maker	MERITOR
Wheel size	16"

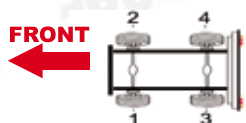

 **Calipers**

Meritor part n°	TT n°	Side
LRG516	93.01.011	1
LRG517	93.01.012	2

 **Repair kits**

	TT KIT n°	CMSK.16.1
	Maker	MERITOR
	OR kit n°	SP8597
	Description	Dirt excluder dust cover
Application		All these calipers

<p>NO PICTURE AVAILABLE</p>	TT KIT n°	U.D.
	Maker	MERITOR
	OR kit n°	SP8566
	Description	Cover
Application		All these calipers

<p>NO PICTURE AVAILABLE</p>	TT KIT n°	U.D.
	Maker	MERITOR
	OR kit n°	SP8902
	Description	Guide pin
Application		All these calipers

 **Models**



MIDLINER S160

From 03.1992

MIDLINER S180

From 03.1992



Maker	MERITOR
Wheel size	17.5"

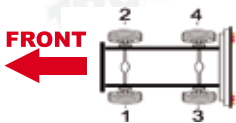

 **Calipers**

Meritor part n°	TT n°	Side
LRG518	93.01.013	1
LRG519	93.01.014	2

 **Repair kits**

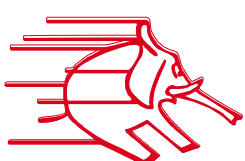
 NO PICTURE AVAILABLE	TT KIT n°	U.D.
	Maker	MERITOR
	OR kit n°	SP8564
	Description	Overhaul seal
	Application	All these calipers

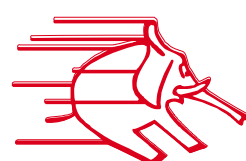
 NO PICTURE AVAILABLE	TT KIT n°	U.D.
	Maker	MERITOR
	OR kit n°	SP8565
	Description	Guide pin
	Application	All these calipers

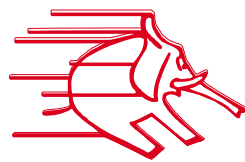
 NO PICTURE AVAILABLE	TT KIT n°	U.D.
	Maker	MERITOR
	OR kit n°	SP8902
	Description	Guide pin
	Application	All these calipers

 **Models**



MAJOR R380-385ti

From 06.1990 to 12.1993

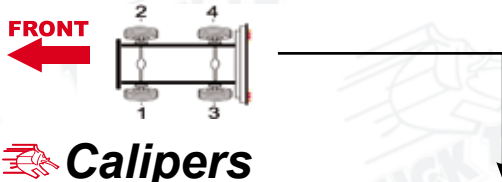

Maker	MERITOR
Wheel size	22.5"

 **Calipers**

Meritor part n°	TT n°	Side
LRG522	93.03.001	1-3
LRG523	93.03.002	2-4

 **Repair kits**

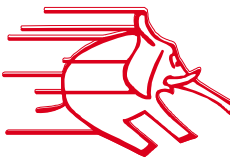
 NO PICTURE AVAILABLE	TT KIT n°	U.D.
	Maker	MERITOR
	OR kit n°	SJ1018
	Description	Auto adjuster
	Application	All these calipers

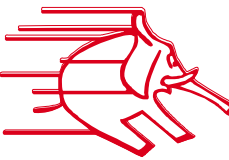
 NO PICTURE AVAILABLE	TT KIT n°	U.D.
	Maker	MERITOR
	OR kit n°	SP8999
	Description	Guide pin
	Application	All these calipers

Models



MIDLINER M250

From 03.1997

MIDLUM

From 2000



Maker	MERITOR
Wheel size	19.5"

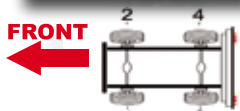

Calipers

Meritor part n°	TT n°	Side
LRG554	93.05.005	1
LRG555	93.05.006	2

Repair kits

MORE KITS : Page212

	TT KIT n°	CMSK.54
	Maker	MERITOR
	OR kit n°	SJ4052
	Description	Guides & Pins
	Application	LRG554 LRG555

	TT KIT n°	CMSK.10/10.2
	Maker	MERITOR
	OR kit n°	SJ4113/4114
	Description	Adjuster(L/R)
	Application	LRG554 LRG555

	TT KIT n°	CMSK.14
	Maker	MERITOR
	OR kit n°	SJ4031
	Description	Needle & roller bearings
	Application	LRG554 LRG555

	TT KIT n°	CMSK.11.3
	Maker	MERITOR
	OR kit n°	Only TT
	Description	Steel balls
	Application	LRG554 LRG555

	TT KIT n°	CMSK.15/15.1
	Maker	MERITOR
	OR kit n°	SJ4073/4074
	Description	Adjuster tappet L/R
	Application	LRG554 LRG555

	TT KIT n°	CMSK.11.2/12.2
	Maker	MERITOR
	OR kit n°	Only TT
	Description	Shaft support
	Application	LRG554 LRG555

	TT KIT n°	CMSK.11.1/12.1
	Maker	MERITOR
	OR kit n°	Only TT
	Description	Shaft
	Application	LRG554 LRG555

RM
General catalogue HEAVY DUTY VEHICLES

 **Models**



PREMIUM

From 2002

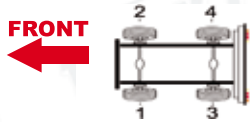

 **Calipers**

	Meritor part n°	TT n°	Side
1	LRG700	93.08.019	1
1	LRG701	93.08.020	2
2	LRG646	93.09.013	3
2	LRG647	93.09.014	4

1.



Maker	MERITOR
Wheel size	22.5" (FRONT)

2.



Maker	MERITOR
Wheel size	22.5" (REAR)

Models



MIDLUM M112
(7,5 - 12 t)

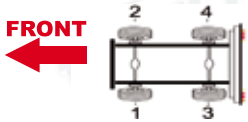

	TT KIT n°	WSSK.20.21
	OR kit n°	-
	Description	Wear Sensor

Maker	WABCO
Wheel size	17.5"
MODELS	WABCO
All	PAN 17

Calipers

Wabco part n°	TT n°	Side
40 175 062	92.01.005	1-3
40 175 063	92.01.006	2-4

Repair kits

MORE KITS : Page 224

	TT KIT n°	CWSK.2
	Maker	WABCO
	OR kit n°	12.999.699
	Description	Guides & seals
	Application	40 175 062 40 175 063

	TT KIT n°	CWSK.8
	Maker	WABCO
	OR kit n°	12.999.580
	Description	Seals, boots & screws
	Application	40 175 062 40 175 063

	TT KIT n°	CWSK.7
	Maker	WABCO
	OR kit n°	12.999.704
	Description	Seals, boots & screws
	Application	40 175 062 40 175 063

	TT KIT n°	CWSK.12
	Maker	WABCO
	OR kit n°	-
	Description	Roller bearing
	Application	40 175 062 40 175 063

	TT KIT n°	CWSK.17.1
	Maker	WABCO
	OR kit n°	-
	Description	Seals & boots
	Application	40 175 062 40 175 063

	TT KIT n°	CWSK.17.2
	Maker	WABCO
	OR kit n°	-
	Description	Guides & screws
	Application	40 175 062 40 175 063

	TT KIT n°	CWSK.12.4
	Maker	WABCO
	OR kit n°	-
	Description	Plugs & joint
	Application	40 175 062 40 175 063

	TT KIT n°	CWSK.12.1
	Maker	WABCO
	OR kit n°	-
	Description	Adjusting mechanism
	Application	40 175 062 40 175 063

Models



MIDLUM M113
(14-16 t)

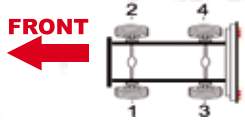

	TT KIT n°	WSSK.20.22
	OR kit n°	-
	Description	Wear Sensor

Maker	WABCO
Wheel size	19.5"
Models	Caliper type
All	PAN 19-2

Calipers

Wabco part n°	TT n°	Side
40 195 009	92.02.005	1-3
40 195 010	92.05.006	2-4

Repair kits

	TT KIT n°	CWSK.5
	Maker	WABCO
	OR kit n°	12.999.746
	Description	Guide & seals
	Application	All these calipers

MORE KITS : [Page 210](#)

 **Models**



MIDLUM

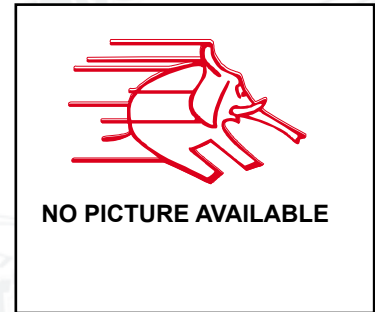

Maker	PONT A MOUSSON
Caliper type	4 pistons

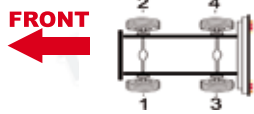

 **Calipers**

Pont A Mousson part n°	TT n°	Side
5001 825 775	96.02.003	1
5001 825 776	96.02.004	2

 **Repair kits**

	TT KIT n°	CPSK.1
	Maker	Pont AMousson
	OR kit n°	-
	Description	Piston
	Application	5001 825 775 5001 825 776

	TT KIT n°	CPSK.2
	Maker	Pont AMousson
	OR kit n°	-
	Description	Seals
	Application	5001 825 775 5001 825 776

Models



Calipers DB22 LD

(carrier holes : 6)
(Modul X)

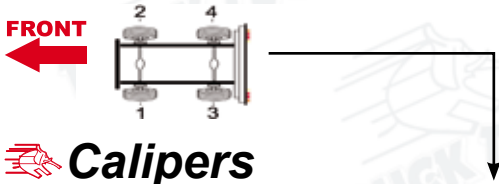

Maker	HALDEX
Wheel size	22.5"

Calipers

Haldex part n°	TT n°	Side	Can use	Type	Version
92777	94.03.008	1-2	92776	DB22 LD	MODUL X

Repair kits

MORE KITS : [Page 230](#)

	TT KIT n°	CHSK.5		TT KIT n°	CHSK.5.1
	Maker	HALDEX		Maker	HALDEX
	OR kit n°	91012		OR kit n°	91013
	Description	Sliding Function incl. slide pins		Description	Sliding Function excl. slide pins
	Application	All MODUL X		Application	All MODUL X
	TT KIT n°	CHSK.5.2		TT KIT n°	CHSK.6
	Maker	HALDEX		Maker	HALDEX
	OR kit n°	91014		OR kit n°	91011
	Description	Sliding Function (light)		Description	Sealing adjustment screw
	Application	All MODUL X		Application	All MODUL X
	TT KIT n°	CHSK.2.1		TT KIT n°	CHSK.2
	Maker	HALDEX		Maker	HALDEX
	OR kit n°	89794		OR kit n°	87405
	Description	Sealing adjustment screw		Description	Adjustment Screw Sealing
	Application	s/n 143 ... →, MkIV		Application	s/n →142 ... / MK II, III
	TT KIT n°	CHSK.1		TT KIT n°	CHSK.1.1
	Maker	HALDEX		Maker	HALDEX
	OR kit n°	89541		OR kit n°	87680
	Description	Sliding Function incl. Slide Pins		Description	Sliding Function excl. Slide Pins
	Application	s/n 090221 →		Application	MKII , III , IV

Models



Ø 19.5" (+5° head of caliper)

From 01.1998

Ø 22.5" (0° head of caliper) (*1)

From 01.1998

Ø 22.5" (0° head of caliper) (*2)

From 01.1998 [with potentiometer]

Ø 22.5" (-12° head of caliper)

From 1998

1.



Wheel size 22.5"

Brake type Axial

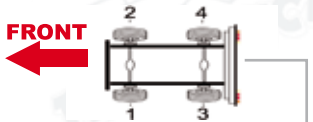

	TT KIT n°	WSSK.20.29
	OR kit n°	Z0008242
	Description	Wear Sensor

2.



Wheel size 22.5"

Brake type Radial

Calipers

	Knorr type n°	TT n°	Side	Knorr part n°	Knorr ration. n°
1	SB6527 (19.5"/+5°)	91.02.001	1	II37252	SN6563
1	SB6537 (19.5"/+5°)	91.02.002	2	II37253	SN6573
2	SB7767 (22.5"/0°)(*1)	91.03.003	1	II37080	SN7196
2	SB7777 (22.5"/0°)(*1)	91.03.004	2	II37081	SN7186
2	SB7801 (22.5"/-12°)	91.03.001	1	II37808	SN7195
2	SB7811 (22.5"/-12°)	91.03.002	2	II37809	SN7185
2	SB7821 (22.5"/0°)(*2)	91.03.023	1	II38824	SB7433
2	SB7831 (22.5"/0°)(*2)	91.03.024	2	II38825	SB7423

Repair kits

MORE KITS : **Page 192**



TT KIT n°	CKSK.1
Maker	KNORR
OR kit n°	II328090062
Description	Guides & Seals
Application	All SB...



TT KIT n°	CKSK.4 / 4.2
Maker	KNORR
OR kit n°	K000944 / K001300
Description	Tappets
Application	All SB... All SN/NA/SK



TT KIT n°	CKSK.6
Maker	KNORR
OR kit n°	K001532
Description	Guides & Seals (New)
Application	All SB...



TT KIT n°	CKSK.8
Maker	KNORR
OR kit n°	-
Description	Complete overhaul
Application	All SB... All SN...



TT KIT n°	CKSK.8.1
Maker	KNORR
OR kit n°	Only TT
Description	Guides & Seals
Application	All SB... All SN...



TT KIT n°	CKSK.16/16.1
Maker	KNORR
OR kit n°	-
Description	Alu / Plastic cover
Application	All SB... All SN...

SAE
SAF

General catalogue HEAVY DUTY VEHICLES

Models



Ø 19.5" Wheels

SKRB 9019 Intradisc plus

Ø 22.5" Wheels, 9t axle:

SKRS 9022W, SKR(L)B 9022W, SKRZ 9022W

Ø 22.5" Wheels, 11t axle:

SKRS 1122W, SKRZ 1122Z



FRONT

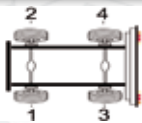

TT KIT n°	WSSK.20.31
OR kit n°	12480036
Description	Wear Sensor

Maker	WABCO
-------	-------

Calipers

Models	Caliper type
All	PAN 22-1
All	PAN19-1plus

Wabco part n°	TT n°	Side
40 195 017 (19.5")	92.02.001	1
40 195 018 (19.5")	92.02.002	2
40 225 007 (22.5")	92.02.003	1
40 225 008 (22.5")	92.02.004	2

Repair kits

MORE KITS : [Page 226](#)

	TT KIT n°	CWSK.4
	Maker	WABCO
	OR kit n°	12.999.738
	Description	Guides & seals
Application	40 195 017 40 195 018	

	TT KIT n°	CWSK.6
	Maker	WABCO
	OR kit n°	12.999.776
	Description	Guides & seals
Application	All	

	TT KIT n°	CWSK.12.4
	Maker	WABCO
	OR kit n°	Only TT
	Description	Joint & seals
Application	40 195 017 40 195 018	

	TT KIT n°	CWSK.12
	Maker	WABCO
	OR kit n°	Only TT
	Description	Half bearings
Application	40 195 017 40 195 018	

	TT KIT n°	CWSK.12.1
	Maker	WABCO
	OR kit n°	Only TT
	Description	Adjusting mechanism
Application	40 195 017 40 195 018	

	TT KIT n°	CWSK.19.2
	Maker	WABCO
	OR kit n°	Only TT
	Description	Guides & screws
Application	40 195 017 40 195 018	

Models



Calipers DB 22 LD
(carrier holes : 6) (Modul X)
Calipers DB 19 HD
(carrier holes : 6) (Modul X)



Maker	HALDEX
Wheel size	22.5"

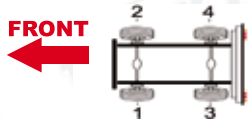

Calipers

Haldex part n°	TT n°	Side	Can use	Type	Version
92503	94.03.004	1-2	92502	DB22 LD	MODUL X
92560	94.02.002	1-2	92559	DB19 HD	MODUL X

Repair kits

MORE KITS : [Page 230-236](#)

	TT KIT n°	CHSK.5		TT KIT n°	CHSK.5.1
	Maker	HALDEX		Maker	HALDEX
	OR kit n°	91012		OR kit n°	91013
	Description	Sliding Function incl. slide pins		Description	Sliding Function excl. slide pins
Application	All MODUL X	Application	All MODUL X		
	TT KIT n°	CHSK.5.2		TT KIT n°	CHSK.6
	Maker	HALDEX		Maker	HALDEX
	OR kit n°	91014		OR kit n°	91011
	Description	Sliding Function (light)		Description	Sealing adjustment screw
Application	All MODUL X	Application	All MODUL X		
	TT KIT n°	CHSK.2.1		TT KIT n°	CHSK.2
	Maker	HALDEX		Maker	HALDEX
	OR kit n°	89794		OR kit n°	87405
	Description	Sealing adjustment screw		Description	Adjustment Screw Sealing
Application	s/n 143 ... →, MkIV	Application	s/n →142 ... / MK II, III		
	TT KIT n°	CHSK.1		TT KIT n°	CHSK.1.1
	Maker	HALDEX		Maker	HALDEX
	OR kit n°	89541		OR kit n°	87680
	Description	Sliding Function incl. Slide Pins		Description	Sliding Function excl. Slide Pins
Application	s/n 090221 →	Application	MKII , III , IV		

Models



114
From 08.1999

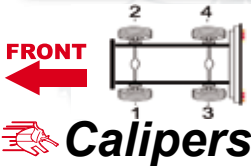

Calipers

	Knorr type n°	TT n°	Side	Knorr part n°	Knorr ration. n°
1	SB7888 (Axial)	91.03.003	1	II37252	SN7213
1	SB7898 (Axial)	91.03.004	2	II37253	SN7203
2	SB7105 (Radial)	91.03.051	1	II37080	SN7196
2	SB7115 (Radial)	91.03.052	2	II37081	SN7186

1.



Wheel size	22.5"
Brake type	Axial

2.



Wheel size	22.5"
Brake type	Radial

Repair kits

MORE KITS : Page 192

	TT KIT n°	CKSK.6
	Maker	KNORR
	OR kit n°	K001532
	Description	Guides & Seals (New)
Application		SB7105 SB7115

	TT KIT n°	CKSK.4 /4.2
	Maker	KNORR
	OR kit n°	K000944 / K001300
	Description	Tappets
Application		All SB... All SN/NA/SK

	TT KIT n°	CKSK.3.2
	Maker	KNORR
	OR kit n°	K000472
	Description	Guide & Seals
Application		All SN...

	TT KIT n°	CKSK.8
	Maker	KNORR
	OR kit n°	-
	Description	Complete overhaul
Application		All SB... All SN...

	TT KIT n°	CKSK.8.1
	Maker	KNORR
	OR kit n°	Only TT
	Description	Guides & Seals
Application		All SB... All SN...

	TT KIT n°	CKSK.16/16.1
	Maker	KNORR
	OR kit n°	-
	Description	Alu / Plastic cover
Application		All SB... All SN...

	TT KIT n°	CKSK.103/104
	Maker	KNORR
	OR kit n°	-
	Description	Adjusting Mechanism
Application		All SB... All SN...

	TT KIT n°	CKSK.14/14.1
	Maker	KNORR
	OR kit n°	-
	Description	Roller Bearings
Application		All SB... All SN...

Models



114
From 05.2001

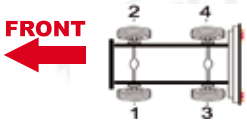

Calipers

Maker	KNORR
Wheel size	22.5"
Angle of actuator	+86°
Wheel size	Radial
Angle of actuator	In-pad

Knorr type n°	TT n°	Side	Knorr part n°	Knorr rationalised n°
SB7199	91.03.016	1-3	K000263	SB7452
SB7189	91.03.015	2-4	K000262	SB7462

Repair kits

MORE KITS : Page 192

<p>114 mm 85 mm</p> <p>32x80 mm 80 mm</p>	TT KIT n°	CKSK.6
	Maker	KNORR
	OR kit n°	K001532
	Description	Guides & Seals (New)
Application	SB7199 SB7189	

	TT KIT n°	CKSK.4 / 4.2
	Maker	KNORR
	OR kit n°	K000944 / K001300
	Description	Tappets
Application	All SB... All SN/NA/SK	

<p>114 mm 85 mm</p> <p>32x80 mm 80 mm</p>	TT KIT n°	CKSK.3.2
	Maker	KNORR
	OR kit n°	K000472
	Description	Guide & Seals
Application	All SN...	

	TT KIT n°	CKSK.8
	Maker	KNORR
	OR kit n°	-
	Description	Complete overhaul
Application	All SB... All SN...	

<p>32x80 mm</p> <p>80 mm</p> <p>114 mm</p> <p>85 mm</p>	TT KIT n°	CKSK.8.1
	Maker	KNORR
	OR kit n°	Only TT
	Description	Guides & Seals
Application	All SB... All SN...	

	TT KIT n°	CKSK.11
	Maker	KNORR
	OR kit n°	Only TT
	Description	Chain
Application	All SB... All SN...	

	TT KIT n°	CKSK.10.3/10.4
	Maker	KNORR
	OR kit n°	-
	Description	Adjusting Mechanism
Application	All SB... All SN...	

	TT KIT n°	CKSK.14/14.1
	Maker	KNORR
	OR kit n°	-
	Description	Roller Bearings
Application	All SB... All SN...	

SCANIA
General catalogue HEAVY DUTY VEHICLES

Models



IRIZAR

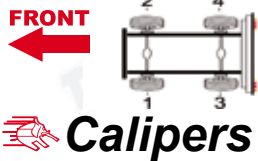

Maker	KNORR
Wheel size	22.5"

Knorr type n°	TT n°	Side	Knorr part n°
SB7746	91.03.071	1	II.36802
SB7756	91.03.072	2	II.36803
SB7747	91.03.019	3	II.36804
SB7757	91.03.020	4	II.36805

Repair kits

MORE KITS : Page 192

	<table border="1"> <tr> <td>TT KIT n°</td> <td>CKSK.6</td> </tr> <tr> <td>Maker</td> <td>KNORR</td> </tr> <tr> <td>OR kit n°</td> <td>K001532</td> </tr> <tr> <td>Description</td> <td>Guides & Seals (New)</td> </tr> <tr> <td>Application</td> <td>All SB...</td> </tr> </table>	TT KIT n°	CKSK.6	Maker	KNORR	OR kit n°	K001532	Description	Guides & Seals (New)	Application	All SB...		<table border="1"> <tr> <td>TT KIT n°</td> <td>CKSK.4 /4.2</td> </tr> <tr> <td>Maker</td> <td>KNORR</td> </tr> <tr> <td>OR kit n°</td> <td>K000944 / K001300</td> </tr> <tr> <td>Description</td> <td>Tappets</td> </tr> <tr> <td>Application</td> <td>All SB... All SN/NA/SK</td> </tr> </table>	TT KIT n°	CKSK.4 /4.2	Maker	KNORR	OR kit n°	K000944 / K001300	Description	Tappets	Application	All SB... All SN/NA/SK
TT KIT n°	CKSK.6																						
Maker	KNORR																						
OR kit n°	K001532																						
Description	Guides & Seals (New)																						
Application	All SB...																						
TT KIT n°	CKSK.4 /4.2																						
Maker	KNORR																						
OR kit n°	K000944 / K001300																						
Description	Tappets																						
Application	All SB... All SN/NA/SK																						
	<table border="1"> <tr> <td>TT KIT n°</td> <td>CKSK.3.2</td> </tr> <tr> <td>Maker</td> <td>KNORR</td> </tr> <tr> <td>OR kit n°</td> <td>K000472</td> </tr> <tr> <td>Description</td> <td>Guide & Seals</td> </tr> <tr> <td>Application</td> <td>All SN...</td> </tr> </table>	TT KIT n°	CKSK.3.2	Maker	KNORR	OR kit n°	K000472	Description	Guide & Seals	Application	All SN...		<table border="1"> <tr> <td>TT KIT n°</td> <td>CKSK.8</td> </tr> <tr> <td>Maker</td> <td>KNORR</td> </tr> <tr> <td>OR kit n°</td> <td>-</td> </tr> <tr> <td>Description</td> <td>Complete overhaul</td> </tr> <tr> <td>Application</td> <td>All SB... All SN...</td> </tr> </table>	TT KIT n°	CKSK.8	Maker	KNORR	OR kit n°	-	Description	Complete overhaul	Application	All SB... All SN...
TT KIT n°	CKSK.3.2																						
Maker	KNORR																						
OR kit n°	K000472																						
Description	Guide & Seals																						
Application	All SN...																						
TT KIT n°	CKSK.8																						
Maker	KNORR																						
OR kit n°	-																						
Description	Complete overhaul																						
Application	All SB... All SN...																						
	<table border="1"> <tr> <td>TT KIT n°</td> <td>CKSK.8.1</td> </tr> <tr> <td>Maker</td> <td>KNORR</td> </tr> <tr> <td>OR kit n°</td> <td>Only TT</td> </tr> <tr> <td>Description</td> <td>Guides & Seals</td> </tr> <tr> <td>Application</td> <td>All SB... All SN...</td> </tr> </table>	TT KIT n°	CKSK.8.1	Maker	KNORR	OR kit n°	Only TT	Description	Guides & Seals	Application	All SB... All SN...		<table border="1"> <tr> <td>TT KIT n°</td> <td>CKSK.16/16.1</td> </tr> <tr> <td>Maker</td> <td>KNORR</td> </tr> <tr> <td>OR kit n°</td> <td>-</td> </tr> <tr> <td>Description</td> <td>Alu / Plastic cover</td> </tr> <tr> <td>Application</td> <td>All SB... All SN...</td> </tr> </table>	TT KIT n°	CKSK.16/16.1	Maker	KNORR	OR kit n°	-	Description	Alu / Plastic cover	Application	All SB... All SN...
TT KIT n°	CKSK.8.1																						
Maker	KNORR																						
OR kit n°	Only TT																						
Description	Guides & Seals																						
Application	All SB... All SN...																						
TT KIT n°	CKSK.16/16.1																						
Maker	KNORR																						
OR kit n°	-																						
Description	Alu / Plastic cover																						
Application	All SB... All SN...																						
	<table border="1"> <tr> <td>TT KIT n°</td> <td>CKSK.103/104</td> </tr> <tr> <td>Maker</td> <td>KNORR</td> </tr> <tr> <td>OR kit n°</td> <td>-</td> </tr> <tr> <td>Description</td> <td>Adjusting Mechanism</td> </tr> <tr> <td>Application</td> <td>All SB... All SN...</td> </tr> </table>	TT KIT n°	CKSK.103/104	Maker	KNORR	OR kit n°	-	Description	Adjusting Mechanism	Application	All SB... All SN...		<table border="1"> <tr> <td>TT KIT n°</td> <td>CKSK.14/14.1</td> </tr> <tr> <td>Maker</td> <td>KNORR</td> </tr> <tr> <td>OR kit n°</td> <td>-</td> </tr> <tr> <td>Description</td> <td>Roller Bearings</td> </tr> <tr> <td>Application</td> <td>All SB... All SN...</td> </tr> </table>	TT KIT n°	CKSK.14/14.1	Maker	KNORR	OR kit n°	-	Description	Roller Bearings	Application	All SB... All SN...
TT KIT n°	CKSK.103/104																						
Maker	KNORR																						
OR kit n°	-																						
Description	Adjusting Mechanism																						
Application	All SB... All SN...																						
TT KIT n°	CKSK.14/14.1																						
Maker	KNORR																						
OR kit n°	-																						
Description	Roller Bearings																						
Application	All SB... All SN...																						

Models



114 (Axial Calipers)

From 08.1996

124 (Axial Calipers)

From 08.1996

144 (Axial Calipers)

From 08.1996



Maker	KNORR
Wheel size	22.5"
Angle of actuator	0°
Wheel size	Axial
Potentiometer	Continuous

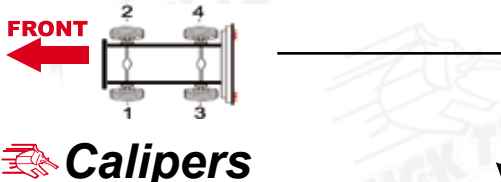

Calipers

Knorr type n°	TT n°	Side	Knorr part n°	Knorr rationalised n°
SB7889	91.03.023	1-3	Z0013591	SN7216
SB7899	91.03.024	2-4	Z0013592	SN7206

Repair kits

MORE KITS : [Page 192](#)

<p>114 mm 85 mm</p> <p>32x80 mm 80 mm</p>	TT KIT n°	CKSK.6
	Maker	KNORR
	OR kit n°	K001532
	Description	Guides & Seals (New)
Application	SB7889 SB7899	

	TT KIT n°	CKSK.4 / 4.2
	Maker	KNORR
	OR kit n°	K000944 / K001300
	Description	Tappets
Application	All SB... All SN/NA/SK	

<p>114 mm 85 mm</p> <p>32x80 mm 80 mm</p>	TT KIT n°	CKSK.3.2
	Maker	KNORR
	OR kit n°	K000472
	Description	Guide & Seals
Application	All SN...	

	TT KIT n°	CKSK.8
	Maker	KNORR
	OR kit n°	-
	Description	Complete overhaul
Application	All SB... All SN...	

<p>32x80 mm</p> <p>80 mm</p> <p>114 mm</p> <p>85 mm</p>	TT KIT n°	CKSK.8.1
	Maker	KNORR
	OR kit n°	Only TT
	Description	Guides & Seals
Application	All SB... All SN...	

	TT KIT n°	CKSK.16/16.1
	Maker	KNORR
	OR kit n°	-
	Description	Alu / Plastic cover
Application	All SB... All SN...	

	TT KIT n°	CKSK.10.3/10.4
	Maker	KNORR
	OR kit n°	-
	Description	Adjusting Mechanism
Application	All SB... All SN...	

	TT KIT n°	CKSK.14/14.1
	Maker	KNORR
	OR kit n°	-
	Description	Roller Bearings
Application	All SB... All SN...	

Models



114 (Axial & Radial Calipers)

From 08.1996

124 (Axial & Radial Calipers)

From 08.1996

144 (Axial & Radial Calipers)

From 08.1996

FRONT

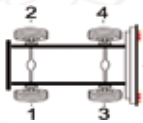

Calipers

TT KIT n°	WSSK.20.15
Maker	MAN
OR kit n°	1903651
Description	Wear Sensor

1.



Wheel size	22.5"
Brake type	Radial

2.



Wheel size	22.5"
Brake type	Axial

	Knorr type n°	TT n°	Side	Knorr part n°	Knorr ration. n°
1	SB7102 (Radial)	91.03.015	1	II31984	SB7465
1	SB7112 (Radial)	91.03.016	2	II31985	SB7455
2	SB7105 (Axial)	91.03.023	3	Z0013591	SN7216
2	SB7115 (Axial)	91.03.024	4	Z0013592	SN7206

Repair kits

MORE KITS : Page 192

	TT KIT n°	CKSK.6
	Maker	KNORR
	OR kit n°	K001532
	Description	Guides & Seals (New)
	Application	SB7102 SB7112

	TT KIT n°	CKSK.4 / 4.2
	Maker	KNORR
	OR kit n°	K000944 / K001300
	Description	Tappets
	Application	All SB... All SN/NA/SK

	TT KIT n°	CKSK.3.2
	Maker	KNORR
	OR kit n°	K000472
	Description	Guide & Seals
	Application	All SN...

	TT KIT n°	CKSK.8
	Maker	KNORR
	OR kit n°	-
	Description	Complete overhaul
	Application	All SB... All SN...

	TT KIT n°	CKSK.8.1
	Maker	KNORR
	OR kit n°	Only TT
	Description	Guides & Seals
	Application	All SB... All SN...

	TT KIT n°	CKSK.16/16.1
	Maker	KNORR
	OR kit n°	Only TT
	Description	Alu / Plastic cover
	Application	All SB... All SN...

	TT KIT n°	CKSK.103/104
	Maker	KNORR
	OR kit n°	-
	Description	Adjusting Mechanism
	Application	All SB... All SN...

	TT KIT n°	CKSK.14/14.1
	Maker	KNORR
	OR kit n°	-
	Description	Roller Bearings
	Application	All SB... All SN...

Models



Ø 19.5" (+5° head of caliper)

From 01.1998

Ø 22.5" (-12° head of caliper) (*1)

From 02.1998 (No potentiometer)

Ø 22.5" (-12° head of caliper) (*2)

From 2000 (With potentiometer)

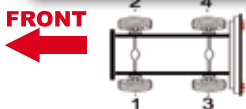

Calipers

	Knorr type n°	TT n°	Side	Knorr part n°	Knorr ration. n°
1	SB6520 (19.5"/+5°)	91.02.001	1	II34161	SN6563
1	SB6530 (19.5"/+5°)	91.02.002	2	II34162	SN6573
2	SB7903 (22.5"/-12°)(*1)	91.03.001	1	K000517	SN7195
2	SB7913 (22.5"/-12°)(*1)	91.03.002	2	K000518	SN7185
2	SB7649 (22.5"/-12°)(*2)	91.03.013	1	II32800	SN7211
2	SB7659 (22.5"/-12°)(*2)	91.03.014	2	II32801	SN7201

1.



Wheel size	19.5"
Brake type	Radial

2.



Wheel size	22.5"
Brake type	Axial

Repair kits

MORE KITS : Page 192

	TT KIT n°	CKSK.6
	Maker	KNORR
	OR kit n°	K001532
	Description	Guides & Seals (New)
Application		SB6520 SB6530

	TT KIT n°	CKSK.4 /4.2
	Maker	KNORR
	OR kit n°	K000944 / K001300
	Description	Tappets
Application		All SB... All SN/NA/SK

	TT KIT n°	CKSK.3.2
	Maker	KNORR
	OR kit n°	K000472
	Description	Guide & Seals
Application		All SN...

	TT KIT n°	CKSK.8
	Maker	KNORR
	OR kit n°	-
	Description	Complete overhaul
Application		All SB... All SN...

	TT KIT n°	CKSK.8.1
	Maker	KNORR
	OR kit n°	Only TT
	Description	Guides & Seals
Application		All SB... All SN...

	TT KIT n°	CKSK.16/16.1
	Maker	KNORR
	OR kit n°	Only TT
	Description	Alu / Plastic cover
Application		All SB... All SN...

	TT KIT n°	CKSK.10.3/10.4
	Maker	KNORR
	OR kit n°	-
	Description	Adjusting Mechanism
Application		All SB... All SN...

	TT KIT n°	CKSK.14/14.1
	Maker	KNORR
	OR kit n°	-
	Description	Roller Bearings
Application		All SB... All SN...

 **Models**



Ø 22.5" wheels
(Wabco calipers)



Maker	WABCO
-------	-------

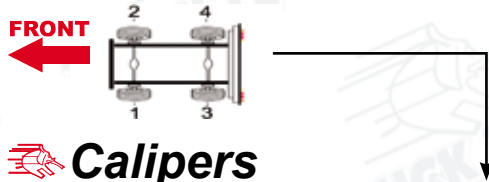

 **Calipers**

Models	Caliper type
All	PAN 22

Wabco part n°	TT n°	Side
40 225 003 (22.5")	92.03.001	1
40 225 004 (22.5")	92.03.002	2

 **Repair kits**

	TT KIT n°	CWSK.1
	Maker	WABCO
	OR kit n°	12.999.678
	Description	Guides & seals
Application	All these calipers	

	TT KIT n°	CWSK.9
	Maker	WABCO
	OR kit n°	12.999.677
	Description	Seals & boots
Application	All these calipers	

 **Models**



Calipers DB22 LD

- 1. carrier holes : 6
- 2. carrier holes : 4

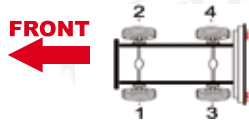

 **Calipers**

Maker	HALDEX
Wheel size	22.5"

	Haldex part n°	TT n°	Side	Can use	Type	Version
1	92779	94.03.002	1-2	91794	DB22 LD	MODUL X
2	92810	94.03.006	1-2	92808	DB22 LD	MODUL X

 **Repair kits**

MORE KITS : Page 230 - 236



TT KIT n°	CHSK.5
Maker	HALDEX
OR kit n°	91012
Description	Sliding Function incl. slide pins
Application	All MODUL X

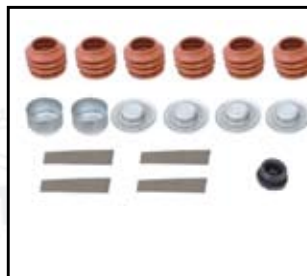

TT KIT n°	CHSK.5.1
Maker	HALDEX
OR kit n°	91013
Description	Sliding Function excl. slide pins
Application	All MODUL X



TT KIT n°	CHSK.5.2
Maker	HALDEX
OR kit n°	91014
Description	Sliding Function (light)
Application	All MODUL X



TT KIT n°	CHSK.6
Maker	HALDEX
OR kit n°	91011
Description	Sealing adjustment screw
Application	All MODUL X



TT KIT n°	CHSK.2.1
Maker	HALDEX
OR kit n°	89794
Description	Sealing adjustment screw
Application	s/n 143 ...→, MK IV



TT KIT n°	CHSK.2
Maker	HALDEX
OR kit n°	87405
Description	Adjustment Screw Sealing
Application	s/n →142 ... / MK II, III



TT KIT n°	CHSK.1
Maker	HALDEX
OR kit n°	89541
Description	Sliding Function incl. Slide Pins
Application	s/n 090221 →



TT KIT n°	CHSK.1.1
Maker	HALDEX
OR kit n°	87680
Description	Sliding Function excl. Slide Pins
Application	MKII , III , IV

Models



COACH & INTERCITY from 07.04
(ZF axle)

913 CL from 07.04

9158 CL from 07.04

915 CL from 07.04

T911/915/916/917/918/924/927
from 07.04

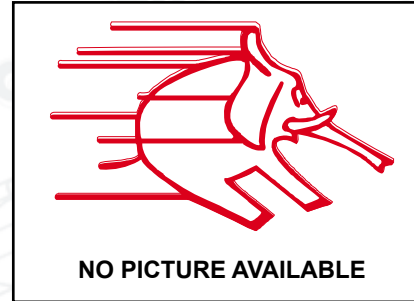

Maker	MERITOR
Wheel size	

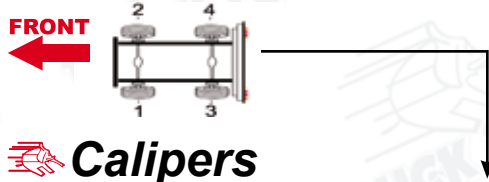

Calipers

Meritor part n°	TT n°	Side
LRG722	93.09.009	1
LRG723	93.09.009	2
LRG748	93.09.027	3
LRG749	93.09.028	4

Repair kits

MORE KITS : Page 230 - 236

	TT KIT n°	CMSK.26
	Maker	MERITOR
	OR kit n°	MCK1243
	Description	Guide & Pin
	Application	LRG748 LRG749

	TT KIT n°	CMSK.18
	Maker	MERITOR
	OR kit n°	MC1139
	Description	Adjuster tap kit
	Application	All These Calipers

	TT KIT n°	CMSK.7.2
	Maker	MERITOR
	OR kit n°	68323746PK10
	Description	Actuator Seal
	Application	All these Calipers

Models



EOS 80-90-100-120-200

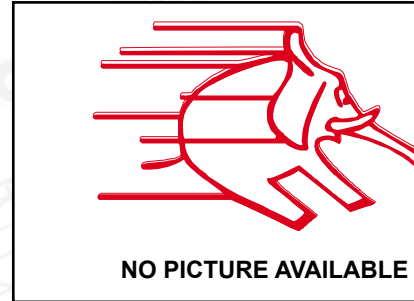

FRONT

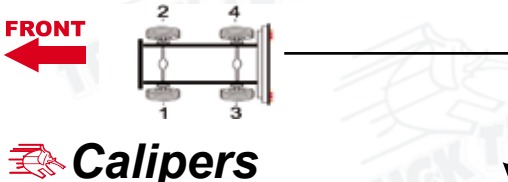

Calipers

Knorr part n°	TT n°	Side
35752	91.05.002	1-2

Maker	KNORR
Wheel size	22.5"

VAN HOOL

General catalogue HEAVY DUTY VEHICLES

Models



ZF AXLE

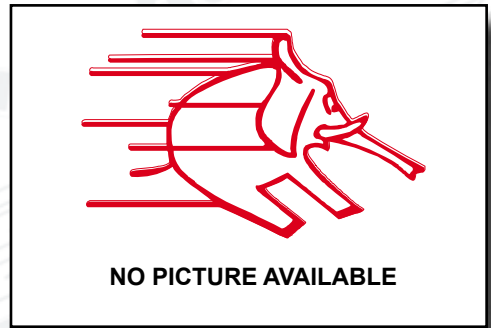

FRONT

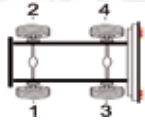

Calipers

Meritor part n°	TT n°	Side
LRG750	93.09.021	1-3
LRG751	93.09.022	2-4

Maker	MERITOR
Wheel size	22.5"

Models



BUS A320



Maker	MERITOR
Wheel size	22.5"

FRONT
←

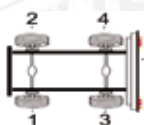

	TT KIT n°	WSSK.20.27
	OR kit n°	68324613
	Description	Wear Sensor

Calipers

Meritor part n°	TT n°	Side
LRG642	93.08.007	3
LRG643	93.08.008	4

Repair kits

MORE KITS : Page 208

	TT KIT n°	CMSG.5
	Maker	MERITOR
	OR kit n°	MCK1102
	Description	Guides & bushes
	Application	LRG642 LRG643

	TT KIT n°	CMSK.3.3
	Maker	MERITOR
	OR kit n°	SJ4112
	Description	Half bearing
	Application	LRG642 LRG643

Models



**B7L
B10B
B10BLE
B10L
B10LE
OLYMPIA**



Maker	MERITOR
Wheel size	22.5"

FRONT

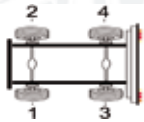

Calipers

Meritor part n°	TT n°	Side
LRG592	93.05.007	1-3
LRG593	93.05.008	2-4

Repair kits

MORE KITS : Page 214

	TT KIT n° CMSK.7
	Maker MERITOR
	OR kit n° SJ4078
	Description Boots & Seals
	Application LRG592 LRG593

	TT KIT n° CMSK.10/10.2
	Maker MERITOR
	OR kit n° SJ4113/4114
	Description Adjuster(L/R)
	Application LRG592 LRG593

	TT KIT n° CMSK.13
	Maker MERITOR
	OR kit n° SJ4076
	Description Guides & pins & sleeves
	Application LRG592 LRG593

	TT KIT n° CMSK.14
	Maker MERITOR
	OR kit n° SJ4031
	Description Needle & roller bearings
	Application LRG592 LRG593

	TT KIT n° CMSK.15/15.1
	Maker MERITOR
	OR kit n° SJ4073/4074
	Description Adjuster tappet L/R
	Application LRG592 LRG593

	TT KIT n° CMSK.11.3
	Maker MERITOR
	OR kit n° Only TT
	Description Steel balls
	Application LRG592 LRG593

	TT KIT n° CMSK.11.1/12.1
	Maker MERITOR
	OR kit n° Only TT
	Description Shaft
	Application LRG592 LRG593

	TT KIT n° CMSK.11.2/12.2
	Maker MERITOR
	OR kit n° Only TT
	Description Shaft support
	Application LRG592 LRG593

Models



B12



Maker	MERITOR
Wheel size	22.5"

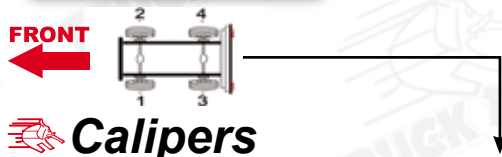

Calipers

Meritor part n°	TT n°	Side
LRG596	93.06.007	3
LRG597	93.06.008	4

Repair kits

MORE KITS : Page 218

	TT KIT n°	CMSK.3.13
	Maker	MERITOR
	OR kit n°	SJ4111
	Description	Visual pad Wear assembly
Application	All these calipers	

	TT KIT n°	CMSK.3.3
	Maker	MERITOR
	OR kit n°	SJ4112
	Description	Bearings
Application	All these calipers	

	TT KIT n°	CMSK.3.1
	Maker	MERITOR
	OR kit n°	MCK1134
	Description	Guide Pin
Application	All these calipers	

	TT KIT n°	CMSK.3.2/4.2
	Maker	MERITOR
	OR kit n°	MCK1236/37
	Description	Adjuster tappet (L/R)
Application	All these calipers	

	TT KIT n°	CMSK.3.14
	Maker	MERITOR
	OR kit n°	MCK1299
	Description	Guide Pin Bolt & Dust Cover
Application	All these calipers	

	TT KIT n°	CMSK.3.5
	Maker	MERITOR
	OR kit n°	MCK1238
	Description	Tappet Head
Application	All these calipers	

	TT KIT n°	CMSK.3.7
	Maker	MERITOR
	OR kit n°	SJ4105
	Description	Cover Plate Seal
Application	All these calipers	

	TT KIT n°	CMSK.3.11
	Maker	MERITOR
	OR kit n°	68322900PK10
	Description	Tappet Anti Rotation plate
Application	All these calipers	

Models



CITY BUS 5010

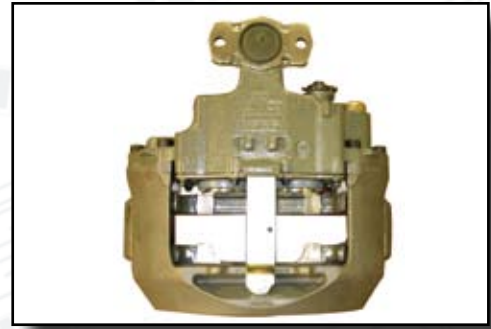

FRONT

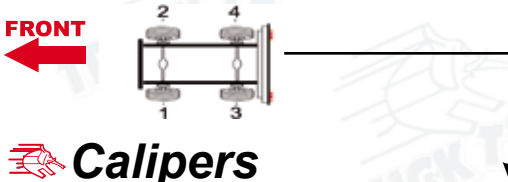

Calipers

Meritor part n°	TT n°	Side
LRG669	93.09.019	1-3
LRG670	93.09.020	2-4

Maker	MERITOR
Wheel size	22.5"

Repair kits

	TT KIT n°	CMSK.26
	Maker	MERITOR
	OR kit n°	MCK1243
	Description	Guide & Pin
	Application	LRG669 LRG670

	TT KIT n°	CMSK.18
	Maker	MERITOR
	OR kit n°	MC1139
	Description	Adjuster tap kit
	Application	LRG669 LRG670

	TT KIT n°	CMSK.7.2
	Maker	MERITOR
	OR kit n°	68323746PK10
	Description	Actuator Seal
	Application	LRG669 LRG670

Models



FL4 (Ø 17.5")

From 01.1987

FL6 (Ø 17.5")

From 01.1987

1.



Maker	MERITOR
Wheel size	17.5" (Front)

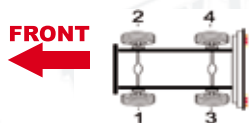

Calipers

	Meritor part n°	TT n°	Side
1	LRG504	93.01.001	1
1	LRG505	93.01.002	2
2	LRG610	93.02.001	3
2	LRG611	93.02.002	4

2.



Maker	MERITOR
Wheel size	17.5" (Rear)

VOLVO

General catalogue HEAVY DUTY VEHICLES

Repair kits

	TT KIT n°	U.D.
	Maker	MERITOR
	OR kit n°	SJ1092
	Description	Auto Adjuster
NO PICTURE AVAILABLE	Application	LRG610 LRG611

	TT KIT n°	U.D.
	Maker	MERITOR
	OR kit n°	SP8565
	Description	Guide pin
NO PICTURE AVAILABLE	Application	All these calipers

	TT KIT n°	U.D.
	Maker	MERITOR
	OR kit n°	SP8566
	Description	Cover
NO PICTURE AVAILABLE	Application	All these calipers

	TT KIT n°	U.D.
	Maker	MERITOR
	OR kit n°	SP8567
	Description	Overhaul seal
NO PICTURE AVAILABLE	Application	LRG504 LRG505

	TT KIT n°	U.D.
	Maker	MERITOR
	OR kit n°	SP8570
	Description	Hand Brake
NO PICTURE AVAILABLE	Application	LRG610 LRG611

	TT KIT n°	U.D.
	Maker	MERITOR
	OR kit n°	SP9670
	Description	Overhaul seal
NO PICTURE AVAILABLE	Application	LRG610 LRG611

Models



FL4 (Ø 16")

From 01.1987

FL6 (Ø 16")

From 01.1987

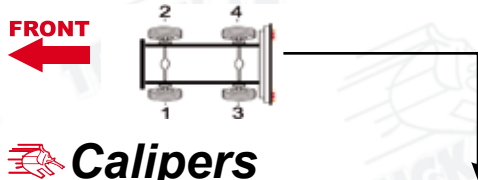

Calipers

	Meritor part n°	TT n°	Side
1	LRG502	93.01.019	1
1	LRG503	93.01.020	2
2	LRG608	93.02.013	3
2	LRG609	93.02.014	4

1.



Maker	MERITOR
Wheel size	16" (Front)

2.



Maker	MERITOR
Wheel size	16" (Rear)

Repair kits

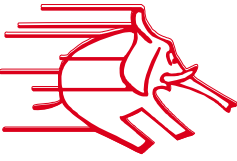
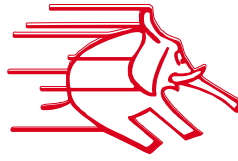
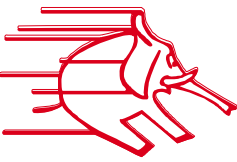
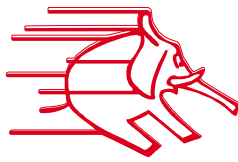
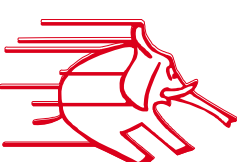
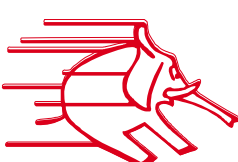
 NO PICTURE AVAILABLE	TT KIT n°	U.D.	 NO PICTURE AVAILABLE	TT KIT n°	U.D.
	Maker	MERITOR		Maker	MERITOR
	OR kit n°	SJ1091		OR kit n°	SP8564
	Description	Auto adjuster		Description	Overhaul seal
	Application	LRG608 LRG609		Application	LRG502 LRG503
 NO PICTURE AVAILABLE	TT KIT n°	U.D.	 NO PICTURE AVAILABLE	TT KIT n°	U.D.
	Maker	MERITOR		Maker	MERITOR
	OR kit n°	SP8565		OR kit n°	SP8566
	Description	Guide pin		Description	Cover
	Application	All these calipers		Application	All these calipers
 NO PICTURE AVAILABLE	TT KIT n°	U.D.	 NO PICTURE AVAILABLE	TT KIT n°	U.D.
	Maker	MERITOR		Maker	MERITOR
	OR kit n°	SP8570		OR kit n°	SP9669
	Description	Hand brake		Description	Overhaul seal
	Application	LRG608 LRG609		Application	LRG608 LRG609

Models



FL6 L MEDIUM

To 06.2001

FL6

To 06.2001

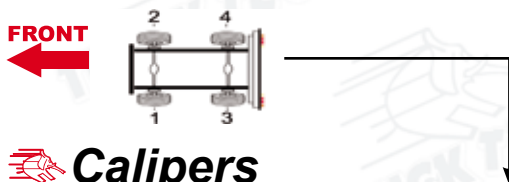

Calipers

Meritor part n°	TT n°	Side
LRG552	93.06.003	1-3
LRG553	93.06.004	2-4

Maker	MERITOR
Wheel size	22.5"

Repair kits

MORE KITS : [Page 218](#)

	TT KIT n°	CMSK.3.13
	Maker	MERITOR
	OR kit n°	SJ4111
	Description	Visual pad Wear assembly
Application	All these calipers	

	TT KIT n°	CMSK.3.3
	Maker	MERITOR
	OR kit n°	SJ4112
	Description	Bearings
Application	All these calipers	

	TT KIT n°	CMSK.3.1
	Maker	MERITOR
	OR kit n°	MCK1134
	Description	Guide Pin
Application	All these calipers	

	TT KIT n°	CMSK.18
	Maker	MERITOR
	OR kit n°	68324854PK10
	Description	Tappet Dust Cover
Application	All these calipers	

	TT KIT n°	CMSK.3.14
	Maker	MERITOR
	OR kit n°	MCK1299
	Description	Guide Pin Bolt & Dust Cover
Application	All these calipers	

	TT KIT n°	CMSK.3.5
	Maker	MERITOR
	OR kit n°	MCK1238
	Description	Tappet Head
Application	All these calipers	

	TT KIT n°	CMSK.3.7
	Maker	MERITOR
	OR kit n°	SJ4105
	Description	Cover Plate Seal
Application	All these calipers	

	TT KIT n°	CMSK.3.11
	Maker	MERITOR
	OR kit n°	68322900PK10
	Description	Tappet Anti Rotation plate
Application	All these calipers	

Models



EUROPA FL

To 06.2001

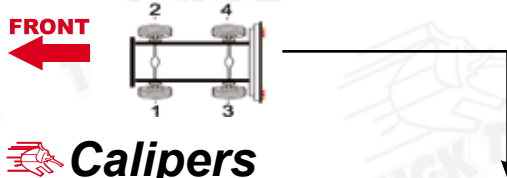

Maker	MERITOR
Wheel size	22.5"

Calipers

Meritor part n°	TT n°	Side
LRG561	93.06.006	1-3
LRG560	93.06.005	2-4

Repair kits

MORE KITS : Page 218

	TT KIT n°	CMSK.3.13
	Maker	MERITOR
	OR kit n°	SJ4111
	Description	Visual pad Wear assembly
	Application	All these calipers

	TT KIT n°	CMSK.3.3
	Maker	MERITOR
	OR kit n°	SJ4112
	Description	Bearings
	Application	All these calipers

	TT KIT n°	CMSK.3.1
	Maker	MERITOR
	OR kit n°	MCK1134
	Description	Guide Pin
	Application	All these calipers

	TT KIT n°	CMSK.3.2/4.2
	Maker	MERITOR
	OR kit n°	MCK1236/37
	Description	Adjuster tappet (L/R)
	Application	All these calipers

	TT KIT n°	CMSK.3.14
	Maker	MERITOR
	OR kit n°	MCK1299
	Description	Guide Pin Bolt & Dust Cover
	Application	All these calipers

	TT KIT n°	CMSK.3.5
	Maker	MERITOR
	OR kit n°	MCK1238
	Description	Tappet Head
	Application	All these calipers

	TT KIT n°	CMSK.3.7
	Maker	MERITOR
	OR kit n°	SJ4105
	Description	Cover Plate Seal
	Application	All these calipers

	TT KIT n°	CMSK.3.11
	Maker	MERITOR
	OR kit n°	68322900PK10
	Description	Tappet Anti Rotation plate
	Application	All these calipers

Models



FL6 H
To 06.2001

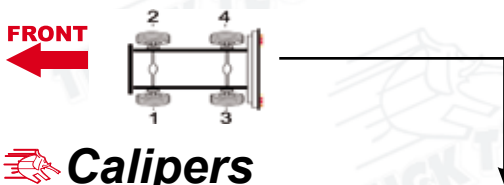

Maker	MERITOR
Wheel size	22.5"

Calipers

Meritor part n°	TT n°	Side
LRG648	93.06.011	1-3
LRG649	93.06.012	2-4

Repair kits

MORE KITS : Page 218

	TT KIT n°	CMSK.3.13
	Maker	MERITOR
	OR kit n°	SJ4111
	Description	Visual pad Wear assembly
Application	All these calipers	

	TT KIT n°	CMSK.3.3
	Maker	MERITOR
	OR kit n°	SJ4112
	Description	Bearings
Application	All these calipers	

	TT KIT n°	CMSK.3.1
	Maker	MERITOR
	OR kit n°	MCK1134
	Description	Guide Pin
Application	All these calipers	

	TT KIT n°	CMSK.3.2/4.2
	Maker	MERITOR
	OR kit n°	MCK1236/37
	Description	Adjuster tappet (L/R)
Application	All these calipers	

	TT KIT n°	CMSK.3.14
	Maker	MERITOR
	OR kit n°	MCK1299
	Description	Guide Pin Bolt & Dust Cover
Application	All these calipers	

	TT KIT n°	CMSK.3.5
	Maker	MERITOR
	OR kit n°	MCK1238
	Description	Tappet Head
Application	All these calipers	

	TT KIT n°	CMSK.3.7
	Maker	MERITOR
	OR kit n°	SJ4105
	Description	Cover Plate Seal
Application	All these calipers	

	TT KIT n°	CMSK.3.11
	Maker	MERITOR
	OR kit n°	68322900PK10
	Description	Tappet Anti Rotation plate
Application	All these calipers	

Models



FH12

From 07.2001

FL6 E MEDIUM 4X2

To 06.2000



Maker	MERITOR
Wheel size	22.5"

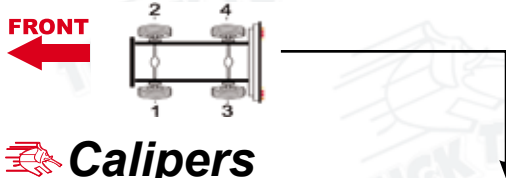

Calipers

Meritor part n°	TT n°	Side
LRG536	93.06.017	1
LRG537	93.06.018	2

Repair kits

MORE KITS : Page 218

	TT KIT n°	CMSK.3.13
	Maker	MERITOR
	OR kit n°	SJ4111
	Description	Visual pad Wear assembly
	Application	All these calipers

	TT KIT n°	CMSK.3.3
	Maker	MERITOR
	OR kit n°	SJ4112
	Description	Bearings
	Application	All these calipers

	TT KIT n°	CMSK.3.1
	Maker	MERITOR
	OR kit n°	MCK1134
	Description	Guide Pin
	Application	All these calipers

	TT KIT n°	CMSK.3.2/4.2
	Maker	MERITOR
	OR kit n°	MCK1236/37
	Description	Adjuster tappet (L/R)
	Application	All these calipers

	TT KIT n°	CMSK.3.14
	Maker	MERITOR
	OR kit n°	MCK1299
	Description	Guide Pin Bolt & Dust Cover
	Application	All these calipers

	TT KIT n°	CMSK.3.5
	Maker	MERITOR
	OR kit n°	MCK1238
	Description	Tappet Head
	Application	All these calipers

	TT KIT n°	CMSK.3.7
	Maker	MERITOR
	OR kit n°	SJ4105
	Description	Cover Plate Seal
	Application	All these calipers

	TT KIT n°	CMSK.3.11
	Maker	MERITOR
	OR kit n°	68322900PK10
	Description	Tappet Anti Rotation plate
	Application	All these calipers

Models



FH12D
From 07.2001

FL6 E MEDIUM 4X2
From 07.2001 to 09.2001

FRONT

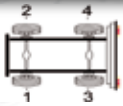

Calipers

	Meritor part n°	TT n°	Side
1	LRG536	93.06.015	1
1	LRG537	93.06.016	2
2	LRG596	93.06.007	3
2	LRG597	93.06.008	4

Repair kits

MORE KITS : [Page 218](#)

	TT KIT n°	CMSK.3.13
	Maker	MERITOR
	OR kit n°	SJ4111
	Description	Visual pad Wear assembly
Application	All these calipers	

	TT KIT n°	CMSK.3.3
	Maker	MERITOR
	OR kit n°	SJ4112
	Description	Bearings
Application	All these calipers	

	TT KIT n°	CMSK.3.1
	Maker	MERITOR
	OR kit n°	MCK1134
	Description	Guide Pin
Application	All these calipers	

	TT KIT n°	CMSK.3.2/4.2
	Maker	MERITOR
	OR kit n°	MCK1236/37
	Description	Adjuster tappet (L/R)
Application	All these calipers	

	TT KIT n°	CMSK.3.14
	Maker	MERITOR
	OR kit n°	MCK1299
	Description	Guide Pin Bolt & Dust Cover
Application	All these calipers	

	TT KIT n°	CMSK.3.5
	Maker	MERITOR
	OR kit n°	MCK1238
	Description	Tappet Head
Application	All these calipers	

	TT KIT n°	CMSK.3.7
	Maker	MERITOR
	OR kit n°	SJ4105
	Description	Cover Plate Seal
Application	All these calipers	

	TT KIT n°	CMSK.3.11
	Maker	MERITOR
	OR kit n°	68322900PK10
	Description	Tappet Anti Rotation plate
Application	All these calipers	

1.



Maker	MERITOR
Wheel size	22.5"

2.



Maker	MERITOR
Wheel size	22.5"

VOLVO

General catalogue HEAVY DUTY VEHICLES

Models



FH12 GENERATION 2-3-4
FH16 GENERATION 2-3-4
FL6 E MEDIUM 6X2 to 06.2000
FM12 GENERATION 2-3-4
FM7 GENERATION 2-3-4
FM9 (FAA 10)

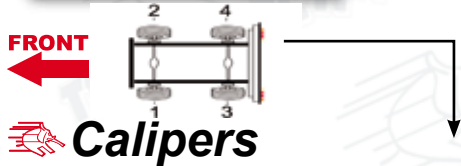

Calipers

	Meritor part n°	TT n°	Side
1	LRG598	93.06.009	1
1	LRG599	93.06.010	2
2	LRG536	93.06.015	3
2	LRG537	93.06.016	4

1.



Maker	MERITOR
Wheel size	22.5"

2.



Maker	MERITOR
Wheel size	22.5"

Repair kits

MORE KITS : Page 218

	TT KIT n°	CMSK.3.13
	Maker	MERITOR
	OR kit n°	SJ4111
	Description	Visual pad Wear assembly
	Application	All these calipers

	TT KIT n°	CMSK.3.3
	Maker	MERITOR
	OR kit n°	SJ4112
	Description	Bearings
	Application	All these calipers

	TT KIT n°	CMSK.3.1
	Maker	MERITOR
	OR kit n°	MCK1134
	Description	Guide Pin
	Application	All these calipers

	TT KIT n°	CMSK.3.2/4.2
	Maker	MERITOR
	OR kit n°	MCK1236/37
	Description	Adjuster tappet (L/R)
	Application	All these calipers

	TT KIT n°	CMSK.3.14
	Maker	MERITOR
	OR kit n°	MCK1299
	Description	Guide Pin Bolt & Dust Cover
	Application	All these calipers

	TT KIT n°	CMSK.3.5
	Maker	MERITOR
	OR kit n°	MCK1238
	Description	Tappet Head
	Application	All these calipers

	TT KIT n°	CMSK.3.7
	Maker	MERITOR
	OR kit n°	SJ4105
	Description	Cover Plate Seal
	Application	All these calipers

	TT KIT n°	CMSK.3.11
	Maker	MERITOR
	OR kit n°	68322900PK10
	Description	Tappet Anti Rotation plate
	Application	All these calipers

Models



FL6 BLF

To 6.2000

FL6 E

From 07.2001



Calipers

N°	Meritor part n°	TT n°	Side
1	LRG536	93.06.015	1-3
1	LRG537	93.06.016	2-4
2	LRG598	93.06.009	1
2	LRG599	93.06.010	2



Maker	MERITOR
Wheel size	22.5"



Maker	MERITOR
Wheel size	22.5"

VOLVO

General catalogue HEAVY DUTY VEHICLES

Repair kits

MORE KITS : Page 218

	TT KIT n°	CMSK.3.13
	Maker	MERITOR
	OR kit n°	SJ4111
	Description	Visual pad Wear assembly
Application	All these calipers	
	TT KIT n°	CMSK.3.3
	Maker	MERITOR
	OR kit n°	SJ4112
	Description	Bearings
Application	All these calipers	
	TT KIT n°	CMSK.3.1
	Maker	MERITOR
	OR kit n°	MCK1134
	Description	Guide Pin
Application	All these calipers	
	TT KIT n°	CMSK.3.2/4.2
	Maker	MERITOR
	OR kit n°	MCK1236/37
	Description	Adjuster tappet (L/R)
Application	All these calipers	
	TT KIT n°	CMSK.3.14
	Maker	MERITOR
	OR kit n°	MCK1299
	Description	Guide Pin Bolt & Dust Cover
Application	All these calipers	
	TT KIT n°	CMSK.3.5
	Maker	MERITOR
	OR kit n°	MCK1238
	Description	Tappet Head
Application	All these calipers	
	TT KIT n°	CMSK.3.7
	Maker	MERITOR
	OR kit n°	SJ4105
	Description	Cover Plate Seal
Application	All these calipers	
	TT KIT n°	CMSK.3.11
	Maker	MERITOR
	OR kit n°	68322900PK10
	Description	Tappet Anti Rotation plate
Application	All these calipers	

Models



FH12 GENERATION 2-3-4
FH16 GENERATION 2-3-4
FM10 GENERATION 2-3-4
FM12 GENERATION 2-3-4
FM7 GENERATION 2-3-4

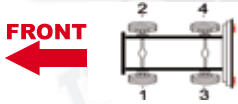

Calipers

	Meritor part n°	TT n°	Side
1	LRG598	93.06.009	1
1	LRG599	93.06.010	2
2	LRG596	93.06.007	3
2	LRG597	93.06.008	4



Maker	MERITOR
Wheel size	22.5"



Maker	MERITOR
Wheel size	22.5"

Repair kits

MORE KITS : [Page 218](#)

	TT KIT n°	CMSK.3.13
	Maker	MERITOR
	OR kit n°	SJ4111
	Description	Visual pad Wear assembly
Application	All these calipers	

	TT KIT n°	CMSK.3.3
	Maker	MERITOR
	OR kit n°	SJ4112
	Description	Bearings
Application	All these calipers	

	TT KIT n°	CMSK.3.1
	Maker	MERITOR
	OR kit n°	MCK1134
	Description	Guide Pin
Application	All these calipers	

	TT KIT n°	CMSK.3.2/4.2
	Maker	MERITOR
	OR kit n°	MCK1236/37
	Description	Adjuster tappet (L/R)
Application	All these calipers	

	TT KIT n°	CMSK.3.14
	Maker	MERITOR
	OR kit n°	MCK1299
	Description	Guide Pin Bolt & Dust Cover
Application	All these calipers	

	TT KIT n°	CMSK.3.5
	Maker	MERITOR
	OR kit n°	MCK1238
	Description	Tappet Head
Application	All these calipers	

	TT KIT n°	CMSK.3.7
	Maker	MERITOR
	OR kit n°	SJ4105
	Description	Cover Plate Seal
Application	All these calipers	

	TT KIT n°	CMSK.3.11
	Maker	MERITOR
	OR kit n°	68322900PK10
	Description	Tappet Anti Rotation plate
Application	All these calipers	

Models



FM9
(FAA 20)



Maker	MERITOR
Wheel size	22.5"

FRONT

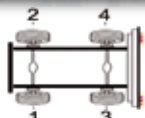

Calipers

Meritor part n°	TT n°	Side
LRG596	93.06.007	1-3
LRG597	93.06.008	2-4

Repair kits

MORE KITS : [Page 218](#)

	TT KIT n°	CMSK.3.13
	Maker	MERITOR
	OR kit n°	SJ4111
	Description	Visual pad Wear assembly
Application	All these calipers	

	TT KIT n°	CMSK.3.3
	Maker	MERITOR
	OR kit n°	SJ4112
	Description	Bearings
Application	All these calipers	

	TT KIT n°	CMSK.3.1
	Maker	MERITOR
	OR kit n°	MCK1134
	Description	Guide Pin
Application	All these calipers	

	TT KIT n°	CMSK.3.2/4.2
	Maker	MERITOR
	OR kit n°	MCK1236/37
	Description	Adjuster tappet (L/R)
Application	All these calipers	

	TT KIT n°	CMSK.3.14
	Maker	MERITOR
	OR kit n°	MCK1299
	Description	Guide Pin Bolt & Dust Cover
Application	All these calipers	

	TT KIT n°	CMSK.3.5
	Maker	MERITOR
	OR kit n°	MCK1238
	Description	Tappet Head
Application	All these calipers	

	TT KIT n°	CMSK.3.7
	Maker	MERITOR
	OR kit n°	SJ4105
	Description	Cover Plate Seal
Application	All these calipers	

	TT KIT n°	CMSK.3.11
	Maker	MERITOR
	OR kit n°	68322900PK10
	Description	Tappet Anti Rotation plate
Application	All these calipers	

Models



FM9 LIFT AXLE

From 05.2001



Maker	MERITOR
Wheel size	22.5"

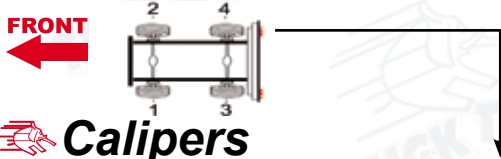

Calipers

Meritor part n°	TT n°	Side
LRG650	93.06.013	1
LRG651	93.06.014	2

Repair kits

MORE KITS : Page 218

	TT KIT n°	CMSK.3.13
	Maker	MERITOR
	OR kit n°	SJ4111
	Description	Visual pad Wear assembly
Application	All these calipers	

	TT KIT n°	CMSK.3.3
	Maker	MERITOR
	OR kit n°	SJ4112
	Description	Bearings
Application	All these calipers	

	TT KIT n°	CMSK.3.1
	Maker	MERITOR
	OR kit n°	MCK1134
	Description	Guide Pin
Application	All these calipers	

	TT KIT n°	CMSK.3.2/4.2
	Maker	MERITOR
	OR kit n°	MCK1236/37
	Description	Adjuster tappet (L/R)
Application	All these calipers	

	TT KIT n°	CMSK.3.14
	Maker	MERITOR
	OR kit n°	MCK1299
	Description	Guide Pin Bolt & Dust Cover
Application	All these calipers	

	TT KIT n°	CMSK.3.5
	Maker	MERITOR
	OR kit n°	MCK1238
	Description	Tappet Head
Application	All these calipers	

	TT KIT n°	CMSK.3.7
	Maker	MERITOR
	OR kit n°	SJ4105
	Description	Cover Plate Seal
Application	All these calipers	

	TT KIT n°	CMSK.3.11
	Maker	MERITOR
	OR kit n°	68322900PK10
	Description	Tappet Anti Rotation plate
Application	All these calipers	



VOLVO

General catalogue HEAVY DUTY VEHICLES





QUALITY IMPROVEMENTS

One of the biggest problems preventing Disc Brakes from operating properly is **RUST**.



Water, salt, heat and dirt make the **GUIDE PINS** on which the caliper slides **RUST NOT OURS !**

TRUCKTECHNIC HAS DEVELOPED GUIDES IN SPECIAL ALLOY WHICH DOES NOT RUST

COMPARATIVE QUALITY TEST

We carried out some salt spray tests on **ORIGINAL PINS** from various makers and our own

OEM guide pin after 2 hours

(+/- 3 months on a truck)

OEM guide pin after 6 hours

(+/- 9 months on a truck)

OEM guide pin after 12 hours

(+/- 18 months on a truck)

TRUCKTEHNIC guide pin after 12 hours



CONDITIONS OF SALT SPRAY TEST

- 1 1.5 % NaCl of the spraying air (NaCl 40 g/l)
- 2 PH value : 6.5
- 3 Pressure in 1 Atm
- 4 Spraying volume (ml/80cm²/h) 1.0 ~2.0
- 5 Temp : 35°
- 6 Humidity: 85 %

WEAR SENSOR

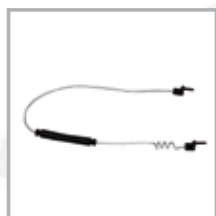

.1



.2



.3



.4



.5



.6



.7



.8

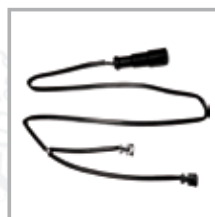

.9

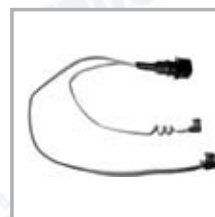

.10

N°	DESTINATION	REFERENCE X	TT REF
1	BOVA - FHD - FLD	LL310240062	WSSK.20.19
2	BPW -	Z0008241	WSSK.20.28
3	DAF LEYLAND - LF 45	-	WSSK.20.24
4	DAF LEYLAND - LF55	-	WSSK.20.25
5	DAF LEYLAND - SB 120 -	1903651	WSSK.20.15
6	DAIML-CHRIS-MERC - Microbus 712C - 914C - LO914	9015400117	WSSK.20.13
7	DENNIS - Trident II from 2001	-	WSSK.20.26
8	EVO BUS - S3 - S316 HDS -S328DT	82853884510	WSSK.20.12
9	GIGANT SAE - Ø 17.5" - Ø 19.5" - Ø 22.5"	Z0008242	WSSK.20.29
10	IRISBUS - Agora from 11.1997	5001848363	WSSK.20.32
7	IVECO - Eurocargo	-	WSSK.20.26
2	LECINENA	Z0008241	WSSK.20.28
5	MAN - 14T Hocl Tap A66 - from 1998	1903651	WSSK.20.15
8	MAN - F 2000 - F 90 - M2000	82853884510	WSSK.20.12
1	NEOPLAN	LL310240062	WSSK.20.19
10	RVI - Agora from 11.1997	5001848363	WSSK.20.32
9	SAF - Ø 19.5" - Ø 22.5"	Z0008242	WSSK.20.29
5	SCANIA - 114 - 124 - 144	1903651	WSSK.20.15

WEAR SENSOR



.11



.12



.13

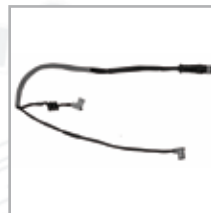

.14



.15



.16



.17



.18



.19



.20

N°	DESTINATION	REFERENCE X	TT REF
11	IRISBUS - Cronus	68324613	WSSK.20.27
12	IVECO - Eurocargo 100E - 80 E - 60 - 65 - 75 - 100 - 80	1907942	WSSK.20.14
13	IVECO - LWK Euro CargoTypes 120 EL	42536956	WSSK.20.23
14	MAN - Citybus - FRH...- FH...- NL...- NG...- PWI...- TGA... - Lionstar	81508226017	WSSK.20.18
15	MAN - L 2000 - M2000L	81508226014	WSSK.20.16
16	RVI - Magnum AE - Premium	5001834075	WSSK.20.17
17	RVI - Midlum M112 (7,5 - 12 t)	-	WSSK.20.21
18	RVI - Midlum M113 (14 - 16 t)	-	WSSK.20.22
19	SAF - 9t axleSKRS 9022W - 11t axleSKRS 1122W, SKRZ 11222	12480036	WSSK.20.31
20	SAF - Ø 19.5" - Ø 22.5"	12480036	WSSK.20.31
20	SAF - SKRB 9019 Intradisc plus	12480036	WSSK.20.31
21	SAF - Radial calipers	Z0063601	WSSK.20.30

CALIPER TOOL CASES



Additional tools

1|



2|



TT KIT n°	CKSK.21
Maker	KNORR
OR kit n°	ZB9032
Description	Caliper tool case
Application	All SB ... / All SN ...

TT KIT n°	1 CKSK.21.1 - 2 CKSK.21.2
Maker	KNORR
OR kit n°	1 Z003934 - 2 Z003934
Description	Additional tools
Application	All SB ... / All SN ...



TT KIT n°	CWSK.21
Maker	WABCO
OR kit n°	12.851.022
Description	tool case PAN17
Application	40.175...



TT KIT n°	CWSK.22
Maker	WABCO
OR kit n°	12.851.021
Description	tool case PAN 19/22/25
Application	40.195... / 40.225...



TT KIT n°	CMSK.22
Maker	MERITOR
OR kit n°	MBT.1000 / MST.1000
Description	tool kit MERITOR
Application	-

REPAIR KITS

KNORR

- SB5000 types	188
- SB6000 /7000 types	192
- SN6000 /7000 types	196

MERITOR

- DX.195.51 /52	200
- D3 LRG524 /25 /26 /27 /28 /29 /32 /33 /622 /623 types	204
- ELSA1 LRG542 /43 /70 /71 /90 /91 /632 /633 /642 /643 types	208
- C LISA LRG554	212
- D LISA LRG548 /49 /50 /51 /64 /65 /92 /93 /630 /631 176 types	214
- D LUCO LRG536 /537 /552 /553 /560 /561 /596 /597 /598 /599 /648 /649 types	218
- ELSA 1 LRG586 /587/588 /589 types	220
- LM ELSA LRG702 /703 types	222

WABCO

- 17,5' types	224
- 19,5' types	226
- 22,5' types	228

HALDEX

- MARK II types	230
- MARK III types	232
- MARK IV DB 22 types	234
- MODUL X types	236

BREMBO





- R312 - 20.5320.12-22-32-42	238
------------------------------	-----

PONT A MOUSSON

- 5001825777 (4 pistons)	240
- 5010197252 (6 pistons)	242

KNORR CALIPERS

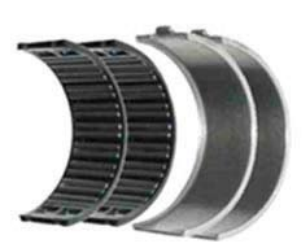
SB5000 Type

	<table border="1"> <tr><td>TT KIT n°</td><td>CKSK.1</td></tr> <tr><td>Maker</td><td>KNORR</td></tr> <tr><td>OR kit n°</td><td>I1328090062</td></tr> <tr><td>Description</td><td>Guides & Seals</td></tr> <tr><td>Application</td><td>All SB...</td></tr> </table>	TT KIT n°	CKSK.1	Maker	KNORR	OR kit n°	I1328090062	Description	Guides & Seals	Application	All SB...		<table border="1"> <tr><td>TT KIT n°</td><td>CKSK.4</td></tr> <tr><td>Maker</td><td>KNORR</td></tr> <tr><td>OR kit n°</td><td>K000944</td></tr> <tr><td>Description</td><td>Tappets</td></tr> <tr><td>Application</td><td>All SB...</td></tr> </table>	TT KIT n°	CKSK.4	Maker	KNORR	OR kit n°	K000944	Description	Tappets	Application	All SB...
TT KIT n°	CKSK.1																						
Maker	KNORR																						
OR kit n°	I1328090062																						
Description	Guides & Seals																						
Application	All SB...																						
TT KIT n°	CKSK.4																						
Maker	KNORR																						
OR kit n°	K000944																						
Description	Tappets																						
Application	All SB...																						
	<table border="1"> <tr><td>TT KIT n°</td><td>CKSK.6</td></tr> <tr><td>Maker</td><td>KNORR</td></tr> <tr><td>OR kit n°</td><td>K001532</td></tr> <tr><td>Description</td><td>Guides & Seals (New)</td></tr> <tr><td>Application</td><td>All SB... All SN...</td></tr> </table>	TT KIT n°	CKSK.6	Maker	KNORR	OR kit n°	K001532	Description	Guides & Seals (New)	Application	All SB... All SN...		<table border="1"> <tr><td>TT KIT n°</td><td>CKSK.8</td></tr> <tr><td>Maker</td><td>KNORR</td></tr> <tr><td>OR kit n°</td><td>-</td></tr> <tr><td>Description</td><td>Complete overhaul</td></tr> <tr><td>Application</td><td>All SB...</td></tr> </table>	TT KIT n°	CKSK.8	Maker	KNORR	OR kit n°	-	Description	Complete overhaul	Application	All SB...
TT KIT n°	CKSK.6																						
Maker	KNORR																						
OR kit n°	K001532																						
Description	Guides & Seals (New)																						
Application	All SB... All SN...																						
TT KIT n°	CKSK.8																						
Maker	KNORR																						
OR kit n°	-																						
Description	Complete overhaul																						
Application	All SB...																						
	<table border="1"> <tr><td>TT KIT n°</td><td>CKSK.8.1</td></tr> <tr><td>Maker</td><td>KNORR</td></tr> <tr><td>OR kit n°</td><td>-</td></tr> <tr><td>Description</td><td>Guides & Seals</td></tr> <tr><td>Application</td><td>All SB... All SN...</td></tr> </table>	TT KIT n°	CKSK.8.1	Maker	KNORR	OR kit n°	-	Description	Guides & Seals	Application	All SB... All SN...		<table border="1"> <tr><td>TT KIT n°</td><td>CKSK.12</td></tr> <tr><td>Maker</td><td>KNORR</td></tr> <tr><td>OR kit n°</td><td>-</td></tr> <tr><td>Description</td><td>Chain</td></tr> <tr><td>Application</td><td>All SB5 All SN5</td></tr> </table>	TT KIT n°	CKSK.12	Maker	KNORR	OR kit n°	-	Description	Chain	Application	All SB5 All SN5
TT KIT n°	CKSK.8.1																						
Maker	KNORR																						
OR kit n°	-																						
Description	Guides & Seals																						
Application	All SB... All SN...																						
TT KIT n°	CKSK.12																						
Maker	KNORR																						
OR kit n°	-																						
Description	Chain																						
Application	All SB5 All SN5																						
	<table border="1"> <tr><td>TT KIT n°</td><td>CKSK.5</td></tr> <tr><td>Maker</td><td>KNORR</td></tr> <tr><td>OR kit n°</td><td>-</td></tr> <tr><td>Description</td><td>Outer boot & steelcap</td></tr> <tr><td>Application</td><td>All SB... All SN...</td></tr> </table>	TT KIT n°	CKSK.5	Maker	KNORR	OR kit n°	-	Description	Outer boot & steelcap	Application	All SB... All SN...		<table border="1"> <tr><td>TT KIT n°</td><td>CKSK.15</td></tr> <tr><td>Maker</td><td>KNORR</td></tr> <tr><td>OR kit n°</td><td>-</td></tr> <tr><td>Description</td><td>Lever bearing</td></tr> <tr><td>Application</td><td>All SB... All SN...</td></tr> </table>	TT KIT n°	CKSK.15	Maker	KNORR	OR kit n°	-	Description	Lever bearing	Application	All SB... All SN...
TT KIT n°	CKSK.5																						
Maker	KNORR																						
OR kit n°	-																						
Description	Outer boot & steelcap																						
Application	All SB... All SN...																						
TT KIT n°	CKSK.15																						
Maker	KNORR																						
OR kit n°	-																						
Description	Lever bearing																						
Application	All SB... All SN...																						
	<table border="1"> <tr><td>TT KIT n°</td><td>CKSK.14</td></tr> <tr><td>Maker</td><td>KNORR</td></tr> <tr><td>OR kit n°</td><td>-</td></tr> <tr><td>Description</td><td>Roller Bearings</td></tr> <tr><td>Application</td><td>All SB...</td></tr> </table>	TT KIT n°	CKSK.14	Maker	KNORR	OR kit n°	-	Description	Roller Bearings	Application	All SB...		<table border="1"> <tr><td>TT KIT n°</td><td>CKSK.11.1</td></tr> <tr><td>Maker</td><td>KNORR</td></tr> <tr><td>OR kit n°</td><td>-</td></tr> <tr><td>Description</td><td>Gear Wheel Adj. Mechanism</td></tr> <tr><td>Application</td><td>All SB... All SN...</td></tr> </table>	TT KIT n°	CKSK.11.1	Maker	KNORR	OR kit n°	-	Description	Gear Wheel Adj. Mechanism	Application	All SB... All SN...
TT KIT n°	CKSK.14																						
Maker	KNORR																						
OR kit n°	-																						
Description	Roller Bearings																						
Application	All SB...																						
TT KIT n°	CKSK.11.1																						
Maker	KNORR																						
OR kit n°	-																						
Description	Gear Wheel Adj. Mechanism																						
Application	All SB... All SN...																						
	<table border="1"> <tr><td>TT KIT n°</td><td>CKSK.18.5</td></tr> <tr><td>Maker</td><td>KNORR</td></tr> <tr><td>OR kit n°</td><td>-</td></tr> <tr><td>Description</td><td>R/KIT SCREWS</td></tr> <tr><td>Application</td><td>All SB...</td></tr> </table>	TT KIT n°	CKSK.18.5	Maker	KNORR	OR kit n°	-	Description	R/KIT SCREWS	Application	All SB...		<table border="1"> <tr><td>TT KIT n°</td><td>CKSK.13.3</td></tr> <tr><td>Maker</td><td>KNORR</td></tr> <tr><td>OR kit n°</td><td>-</td></tr> <tr><td>Description</td><td>Guide & Bush</td></tr> <tr><td>Application</td><td>SB5/6/7</td></tr> </table>	TT KIT n°	CKSK.13.3	Maker	KNORR	OR kit n°	-	Description	Guide & Bush	Application	SB5/6/7
TT KIT n°	CKSK.18.5																						
Maker	KNORR																						
OR kit n°	-																						
Description	R/KIT SCREWS																						
Application	All SB...																						
TT KIT n°	CKSK.13.3																						
Maker	KNORR																						
OR kit n°	-																						
Description	Guide & Bush																						
Application	SB5/6/7																						

MORE KITS NEXT PAGE

KNORR CALIPERS

SB5000 Type

	TT KIT n°	CKSK.13.3B
	Maker	KNORR
	OR kit n°	II368470064
	Description	Guide, bush & 1 Screw
	Application	SB5/6/7 SN5/6/7

	TT KIT n°	CKSK.10.5
	Maker	KNORR
	OR kit n°	
	Description	Adjusting Mechanism
	Application	SB5 SN5

	TT KIT n°	CKSK.10.8
	Maker	KNORR
	OR kit n°	
	Description	Pignon Shaft
	Application	SB5 SN5

	TT KIT n°	CKSK.16.5
	Maker	KNORR
	OR kit n°	
	Description	
	Application	SB5 SN5

	TT KIT n°	CKSK.2.7
	Maker	KNORR
	OR kit n°	-
	Description	Caps & pad retainer pins
	Application	All SB... All SN...

KNORR CALIPER repair kits

Repair kits details

KNORR CALIPERS





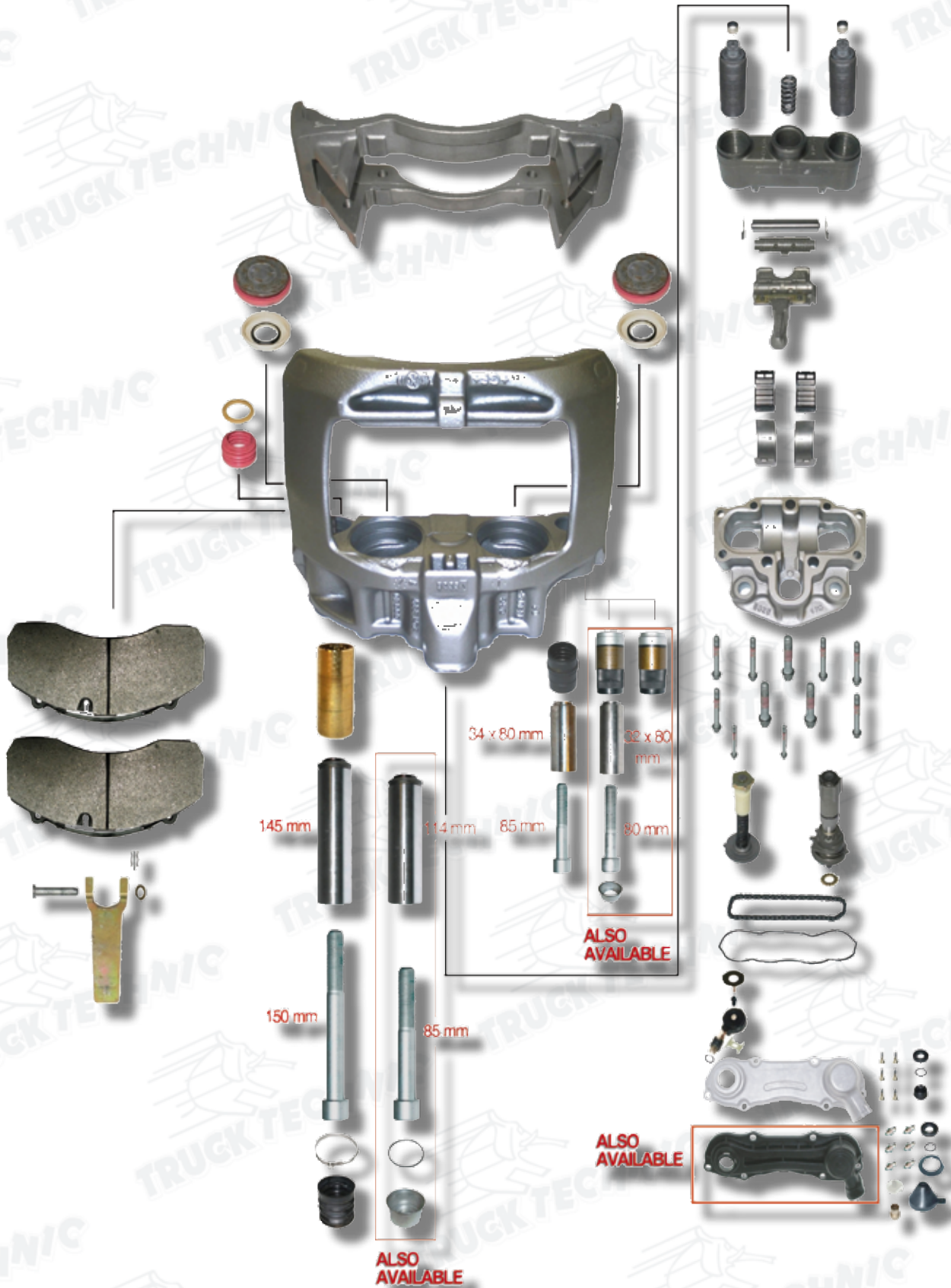









SB6000 / 7000 Types

Typical exploded view of most key models are exposed here, to help you to choose correct repair kits.



KNORR CALIPERS

SB6000 / 7000 Types

	<table border="1"> <tr><td>TT KIT n°</td><td>CKSK.1</td></tr> <tr><td>Maker</td><td>KNORR</td></tr> <tr><td>OR kit n°</td><td>I1328090062</td></tr> <tr><td>Description</td><td>Guides & Seals</td></tr> <tr><td>Application</td><td>All SB...</td></tr> </table>	TT KIT n°	CKSK.1	Maker	KNORR	OR kit n°	I1328090062	Description	Guides & Seals	Application	All SB...		<table border="1"> <tr><td>TT KIT n°</td><td>CKSK.4</td></tr> <tr><td>Maker</td><td>KNORR</td></tr> <tr><td>OR kit n°</td><td>K000944</td></tr> <tr><td>Description</td><td>Tappets</td></tr> <tr><td>Application</td><td>All SB...</td></tr> </table>	TT KIT n°	CKSK.4	Maker	KNORR	OR kit n°	K000944	Description	Tappets	Application	All SB...
TT KIT n°	CKSK.1																						
Maker	KNORR																						
OR kit n°	I1328090062																						
Description	Guides & Seals																						
Application	All SB...																						
TT KIT n°	CKSK.4																						
Maker	KNORR																						
OR kit n°	K000944																						
Description	Tappets																						
Application	All SB...																						
	<table border="1"> <tr><td>TT KIT n°</td><td>CKSK.6</td></tr> <tr><td>Maker</td><td>KNORR</td></tr> <tr><td>OR kit n°</td><td>K001532</td></tr> <tr><td>Description</td><td>Guides & Seals (New)</td></tr> <tr><td>Application</td><td>All SB... All SN...</td></tr> </table>	TT KIT n°	CKSK.6	Maker	KNORR	OR kit n°	K001532	Description	Guides & Seals (New)	Application	All SB... All SN...		<table border="1"> <tr><td>TT KIT n°</td><td>CKSK.8</td></tr> <tr><td>Maker</td><td>KNORR</td></tr> <tr><td>OR kit n°</td><td>-</td></tr> <tr><td>Description</td><td>Complete overhaul</td></tr> <tr><td>Application</td><td>All SB...</td></tr> </table>	TT KIT n°	CKSK.8	Maker	KNORR	OR kit n°	-	Description	Complete overhaul	Application	All SB...
TT KIT n°	CKSK.6																						
Maker	KNORR																						
OR kit n°	K001532																						
Description	Guides & Seals (New)																						
Application	All SB... All SN...																						
TT KIT n°	CKSK.8																						
Maker	KNORR																						
OR kit n°	-																						
Description	Complete overhaul																						
Application	All SB...																						
	<table border="1"> <tr><td>TT KIT n°</td><td>CKSK.8.1</td></tr> <tr><td>Maker</td><td>KNORR</td></tr> <tr><td>OR kit n°</td><td>-</td></tr> <tr><td>Description</td><td>Guides & Seals</td></tr> <tr><td>Application</td><td>All SB... All SN...</td></tr> </table>	TT KIT n°	CKSK.8.1	Maker	KNORR	OR kit n°	-	Description	Guides & Seals	Application	All SB... All SN...		<table border="1"> <tr><td>TT KIT n°</td><td>CKSK.17</td></tr> <tr><td>Maker</td><td>KNORR</td></tr> <tr><td>OR kit n°</td><td>-</td></tr> <tr><td>Description</td><td>Bridge assy - pistons</td></tr> <tr><td>Application</td><td>SB6 /7 series</td></tr> </table>	TT KIT n°	CKSK.17	Maker	KNORR	OR kit n°	-	Description	Bridge assy - pistons	Application	SB6 /7 series
TT KIT n°	CKSK.8.1																						
Maker	KNORR																						
OR kit n°	-																						
Description	Guides & Seals																						
Application	All SB... All SN...																						
TT KIT n°	CKSK.17																						
Maker	KNORR																						
OR kit n°	-																						
Description	Bridge assy - pistons																						
Application	SB6 /7 series																						
	<table border="1"> <tr><td>TT KIT n°</td><td>CKSK.16.1</td></tr> <tr><td>Maker</td><td>KNORR</td></tr> <tr><td>OR kit n°</td><td>Only TT</td></tr> <tr><td>Description</td><td>Plastic cover</td></tr> <tr><td>Application</td><td>SB6 /7 series SN6 /7 series</td></tr> </table>	TT KIT n°	CKSK.16.1	Maker	KNORR	OR kit n°	Only TT	Description	Plastic cover	Application	SB6 /7 series SN6 /7 series		<table border="1"> <tr><td>TT KIT n°</td><td>CKSK.16</td></tr> <tr><td>Maker</td><td>KNORR</td></tr> <tr><td>OR kit n°</td><td>Ony TT</td></tr> <tr><td>Description</td><td>Aluminium cover</td></tr> <tr><td>Application</td><td>SB6 /7 series SN6 /7 series</td></tr> </table>	TT KIT n°	CKSK.16	Maker	KNORR	OR kit n°	Ony TT	Description	Aluminium cover	Application	SB6 /7 series SN6 /7 series
TT KIT n°	CKSK.16.1																						
Maker	KNORR																						
OR kit n°	Only TT																						
Description	Plastic cover																						
Application	SB6 /7 series SN6 /7 series																						
TT KIT n°	CKSK.16																						
Maker	KNORR																						
OR kit n°	Ony TT																						
Description	Aluminium cover																						
Application	SB6 /7 series SN6 /7 series																						
	<table border="1"> <tr><td>TT KIT n°</td><td>CKSK.10.3</td></tr> <tr><td>Maker</td><td>KNORR</td></tr> <tr><td>OR kit n°</td><td>-</td></tr> <tr><td>Description</td><td>Adjusting mechanism</td></tr> <tr><td>Application</td><td>All SB... All SN...</td></tr> </table>	TT KIT n°	CKSK.10.3	Maker	KNORR	OR kit n°	-	Description	Adjusting mechanism	Application	All SB... All SN...		<table border="1"> <tr><td>TT KIT n°</td><td>CKSK.10.4</td></tr> <tr><td>Maker</td><td>KNORR</td></tr> <tr><td>OR kit n°</td><td>-</td></tr> <tr><td>Description</td><td>Adjusting mechanism</td></tr> <tr><td>Application</td><td>All SB...</td></tr> </table>	TT KIT n°	CKSK.10.4	Maker	KNORR	OR kit n°	-	Description	Adjusting mechanism	Application	All SB...
TT KIT n°	CKSK.10.3																						
Maker	KNORR																						
OR kit n°	-																						
Description	Adjusting mechanism																						
Application	All SB... All SN...																						
TT KIT n°	CKSK.10.4																						
Maker	KNORR																						
OR kit n°	-																						
Description	Adjusting mechanism																						
Application	All SB...																						
	<table border="1"> <tr><td>TT KIT n°</td><td>CKSK.14</td></tr> <tr><td>Maker</td><td>KNORR</td></tr> <tr><td>OR kit n°</td><td>-</td></tr> <tr><td>Description</td><td>Roller Bearings</td></tr> <tr><td>Application</td><td>All SB...</td></tr> </table>	TT KIT n°	CKSK.14	Maker	KNORR	OR kit n°	-	Description	Roller Bearings	Application	All SB...		<table border="1"> <tr><td>TT KIT n°</td><td>CKSK.11</td></tr> <tr><td>Maker</td><td>KNORR</td></tr> <tr><td>OR kit n°</td><td>-</td></tr> <tr><td>Description</td><td>Chain</td></tr> <tr><td>Application</td><td>SB6 /7 series SN6 /7 series</td></tr> </table>	TT KIT n°	CKSK.11	Maker	KNORR	OR kit n°	-	Description	Chain	Application	SB6 /7 series SN6 /7 series
TT KIT n°	CKSK.14																						
Maker	KNORR																						
OR kit n°	-																						
Description	Roller Bearings																						
Application	All SB...																						
TT KIT n°	CKSK.11																						
Maker	KNORR																						
OR kit n°	-																						
Description	Chain																						
Application	SB6 /7 series SN6 /7 series																						
	<table border="1"> <tr><td>TT KIT n°</td><td>CKSK.2.7</td></tr> <tr><td>Maker</td><td>KNORR</td></tr> <tr><td>OR kit n°</td><td>-</td></tr> <tr><td>Description</td><td>Caps & pad retainer pins</td></tr> <tr><td>Application</td><td>All SB... All SN...</td></tr> </table>	TT KIT n°	CKSK.2.7	Maker	KNORR	OR kit n°	-	Description	Caps & pad retainer pins	Application	All SB... All SN...	<div style="text-align: center;">  <p>MORE KITS NEXT PAGE</p> </div>											
TT KIT n°	CKSK.2.7																						
Maker	KNORR																						
OR kit n°	-																						
Description	Caps & pad retainer pins																						
Application	All SB... All SN...																						

KNORR CALIPERS

SB6000 / 7000 Types

Typical exploded view of most key models are exposed here, to help you to choose correct repair kits.

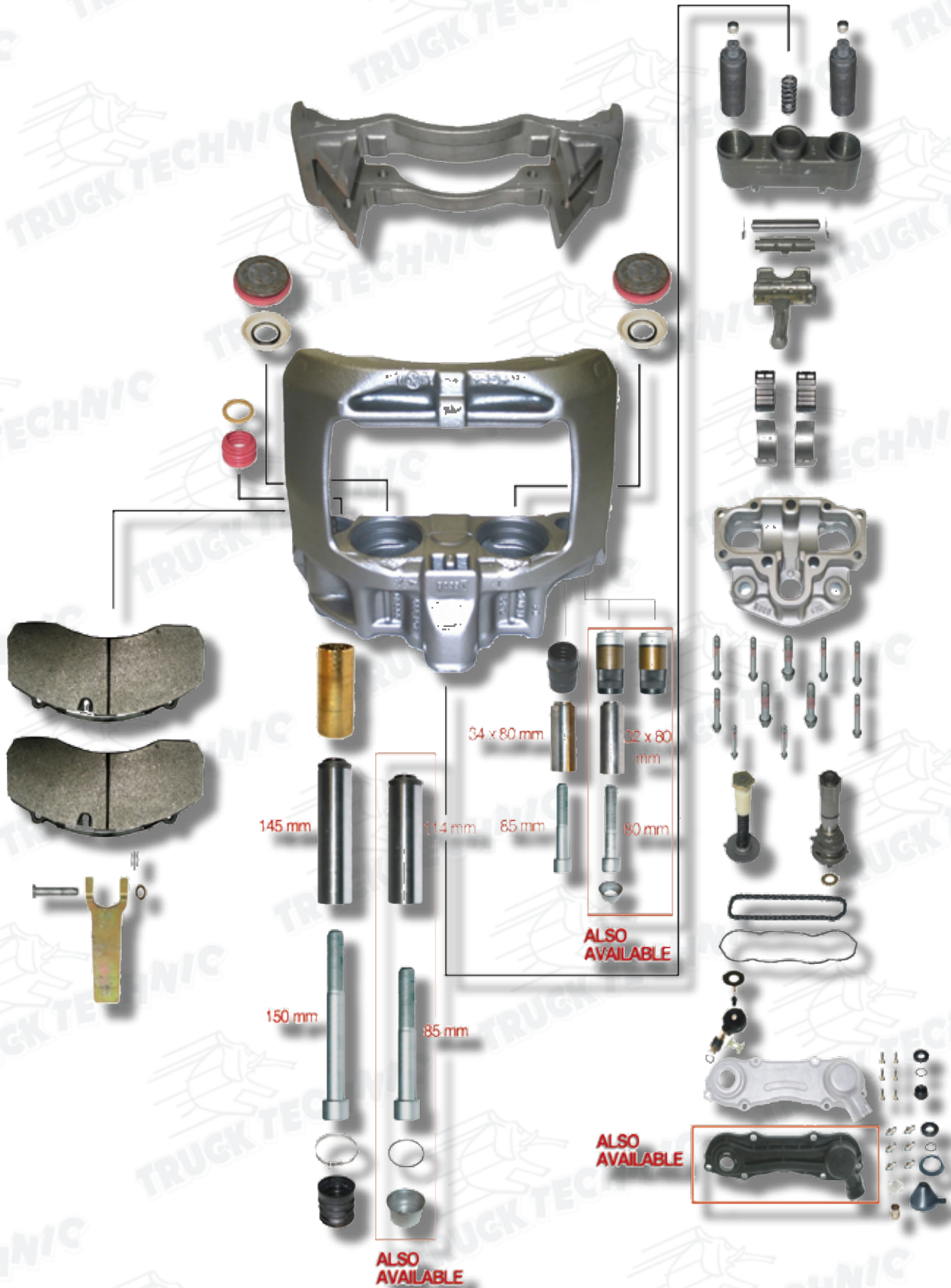













KNORR CALIPERS

SB6000 / 7000 Types

	<table border="1"> <tr><td>TT KIT n°</td><td>CKSK.5</td></tr> <tr><td>Maker</td><td>KNORR</td></tr> <tr><td>OR kit n°</td><td>-</td></tr> <tr><td>Description</td><td>Outer boot & steelcap</td></tr> <tr><td>Application</td><td>All SB... All SN...</td></tr> </table>	TT KIT n°	CKSK.5	Maker	KNORR	OR kit n°	-	Description	Outer boot & steelcap	Application	All SB... All SN...		<table border="1"> <tr><td>TT KIT n°</td><td>CKSK.10.1</td></tr> <tr><td>Maker</td><td>KNORR</td></tr> <tr><td>OR kit n°</td><td>-</td></tr> <tr><td>Description</td><td>Pignon shaft</td></tr> <tr><td>Application</td><td>All SB... All SN...</td></tr> </table>	TT KIT n°	CKSK.10.1	Maker	KNORR	OR kit n°	-	Description	Pignon shaft	Application	All SB... All SN...
TT KIT n°	CKSK.5																						
Maker	KNORR																						
OR kit n°	-																						
Description	Outer boot & steelcap																						
Application	All SB... All SN...																						
TT KIT n°	CKSK.10.1																						
Maker	KNORR																						
OR kit n°	-																						
Description	Pignon shaft																						
Application	All SB... All SN...																						
	<table border="1"> <tr><td>TT KIT n°</td><td>CKSK.2.5</td></tr> <tr><td>Maker</td><td>KNORR</td></tr> <tr><td>OR kit n°</td><td>II19712004</td></tr> <tr><td>Description</td><td>Pad retainer</td></tr> <tr><td>Application</td><td>All SB... All SN...</td></tr> </table>	TT KIT n°	CKSK.2.5	Maker	KNORR	OR kit n°	II19712004	Description	Pad retainer	Application	All SB... All SN...		<table border="1"> <tr><td>TT KIT n°</td><td>CKSK.15</td></tr> <tr><td>Maker</td><td>KNORR</td></tr> <tr><td>OR kit n°</td><td>-</td></tr> <tr><td>Description</td><td>Lever Bearing</td></tr> <tr><td>Application</td><td>All SB... All SN...</td></tr> </table>	TT KIT n°	CKSK.15	Maker	KNORR	OR kit n°	-	Description	Lever Bearing	Application	All SB... All SN...
TT KIT n°	CKSK.2.5																						
Maker	KNORR																						
OR kit n°	II19712004																						
Description	Pad retainer																						
Application	All SB... All SN...																						
TT KIT n°	CKSK.15																						
Maker	KNORR																						
OR kit n°	-																						
Description	Lever Bearing																						
Application	All SB... All SN...																						
	<table border="1"> <tr><td>TT KIT n°</td><td>CKSK.11.1</td></tr> <tr><td>Maker</td><td>KNORR</td></tr> <tr><td>OR kit n°</td><td>-</td></tr> <tr><td>Description</td><td>Gear Wheel Adj. Mechanism</td></tr> <tr><td>Application</td><td>All SB... All SN...</td></tr> </table>	TT KIT n°	CKSK.11.1	Maker	KNORR	OR kit n°	-	Description	Gear Wheel Adj. Mechanism	Application	All SB... All SN...		<table border="1"> <tr><td>TT KIT n°</td><td>CKSK.18.5</td></tr> <tr><td>Maker</td><td>KNORR</td></tr> <tr><td>OR kit n°</td><td>-</td></tr> <tr><td>Description</td><td>R/KIT SCREWS</td></tr> <tr><td>Application</td><td>All SB...</td></tr> </table>	TT KIT n°	CKSK.18.5	Maker	KNORR	OR kit n°	-	Description	R/KIT SCREWS	Application	All SB...
TT KIT n°	CKSK.11.1																						
Maker	KNORR																						
OR kit n°	-																						
Description	Gear Wheel Adj. Mechanism																						
Application	All SB... All SN...																						
TT KIT n°	CKSK.18.5																						
Maker	KNORR																						
OR kit n°	-																						
Description	R/KIT SCREWS																						
Application	All SB...																						
 <p>WVA n° : 29059 / 29087 / 29061</p>	<table border="1"> <tr><td>TT KIT n°</td><td>CBPK.1</td></tr> <tr><td>Maker</td><td>KNORR</td></tr> <tr><td>OR kit n°</td><td>II380280062</td></tr> <tr><td>Description</td><td>Brake pads</td></tr> <tr><td>Application</td><td>SB7 series SN7 series</td></tr> </table>	TT KIT n°	CBPK.1	Maker	KNORR	OR kit n°	II380280062	Description	Brake pads	Application	SB7 series SN7 series	 <p>WVA n° : 29094 / 29095</p>	<table border="1"> <tr><td>TT KIT n°</td><td>CBPK.2</td></tr> <tr><td>Maker</td><td>KNORR</td></tr> <tr><td>OR kit n°</td><td>II319880062</td></tr> <tr><td>Description</td><td>Brake pads</td></tr> <tr><td>Application</td><td>SB6 series SN6 series</td></tr> </table>	TT KIT n°	CBPK.2	Maker	KNORR	OR kit n°	II319880062	Description	Brake pads	Application	SB6 series SN6 series
TT KIT n°	CBPK.1																						
Maker	KNORR																						
OR kit n°	II380280062																						
Description	Brake pads																						
Application	SB7 series SN7 series																						
TT KIT n°	CBPK.2																						
Maker	KNORR																						
OR kit n°	II319880062																						
Description	Brake pads																						
Application	SB6 series SN6 series																						
 <p>-12°</p> <p>SB... actuator -12°</p> <p>FOR SB.7...</p>	<table border="1"> <tr><td>TT KIT n°</td><td>CKSK.18</td></tr> <tr><td>Maker</td><td>KNORR</td></tr> <tr><td>OR kit n°</td><td>-</td></tr> <tr><td>Description</td><td>Lever (angle +12°)</td></tr> <tr><td>Application</td><td>SB.7... series</td></tr> </table>	TT KIT n°	CKSK.18	Maker	KNORR	OR kit n°	-	Description	Lever (angle +12°)	Application	SB.7... series	 <p>0°</p> <p>SB... actuator 0°</p> <p>FOR SB.7...</p>	<table border="1"> <tr><td>TT KIT n°</td><td>CKSK.18.1</td></tr> <tr><td>Maker</td><td>KNORR</td></tr> <tr><td>OR kit n°</td><td>-</td></tr> <tr><td>Description</td><td>Lever (angle +0°)</td></tr> <tr><td>Application</td><td>SB.7... series</td></tr> </table>	TT KIT n°	CKSK.18.1	Maker	KNORR	OR kit n°	-	Description	Lever (angle +0°)	Application	SB.7... series
TT KIT n°	CKSK.18																						
Maker	KNORR																						
OR kit n°	-																						
Description	Lever (angle +12°)																						
Application	SB.7... series																						
TT KIT n°	CKSK.18.1																						
Maker	KNORR																						
OR kit n°	-																						
Description	Lever (angle +0°)																						
Application	SB.7... series																						
	<table border="1"> <tr><td>TT KIT n°</td><td>CKSK.13.1</td></tr> <tr><td>Maker</td><td>KNORR</td></tr> <tr><td>OR kit n°</td><td>-</td></tr> <tr><td>Description</td><td>Guide & Bush Ø 35mm</td></tr> <tr><td>Application</td><td>SB5/6/7 SN5/6/7</td></tr> </table>	TT KIT n°	CKSK.13.1	Maker	KNORR	OR kit n°	-	Description	Guide & Bush Ø 35mm	Application	SB5/6/7 SN5/6/7		<table border="1"> <tr><td>TT KIT n°</td><td>CKSK.13.2</td></tr> <tr><td>Maker</td><td>KNORR</td></tr> <tr><td>OR kit n°</td><td>-</td></tr> <tr><td>Description</td><td>Guide & Bush Ø 39mm</td></tr> <tr><td>Application</td><td>SB5/6/7 SN5/6/7</td></tr> </table>	TT KIT n°	CKSK.13.2	Maker	KNORR	OR kit n°	-	Description	Guide & Bush Ø 39mm	Application	SB5/6/7 SN5/6/7
TT KIT n°	CKSK.13.1																						
Maker	KNORR																						
OR kit n°	-																						
Description	Guide & Bush Ø 35mm																						
Application	SB5/6/7 SN5/6/7																						
TT KIT n°	CKSK.13.2																						
Maker	KNORR																						
OR kit n°	-																						
Description	Guide & Bush Ø 39mm																						
Application	SB5/6/7 SN5/6/7																						
	<table border="1"> <tr><td>TT KIT n°</td><td>CKSK.13.3</td></tr> <tr><td>Maker</td><td>KNORR</td></tr> <tr><td>OR kit n°</td><td>-</td></tr> <tr><td>Description</td><td>Guide & Bush</td></tr> <tr><td>Application</td><td>SB5/6/7 SN5/6/7</td></tr> </table>	TT KIT n°	CKSK.13.3	Maker	KNORR	OR kit n°	-	Description	Guide & Bush	Application	SB5/6/7 SN5/6/7		<table border="1"> <tr><td>TT KIT n°</td><td>CKSK.13.3B</td></tr> <tr><td>Maker</td><td>KNORR</td></tr> <tr><td>OR kit n°</td><td>II368470064</td></tr> <tr><td>Description</td><td>Guide, bush & 1 Screw</td></tr> <tr><td>Application</td><td>SB5/6/7 SN5/6/7</td></tr> </table>	TT KIT n°	CKSK.13.3B	Maker	KNORR	OR kit n°	II368470064	Description	Guide, bush & 1 Screw	Application	SB5/6/7 SN5/6/7
TT KIT n°	CKSK.13.3																						
Maker	KNORR																						
OR kit n°	-																						
Description	Guide & Bush																						
Application	SB5/6/7 SN5/6/7																						
TT KIT n°	CKSK.13.3B																						
Maker	KNORR																						
OR kit n°	II368470064																						
Description	Guide, bush & 1 Screw																						
Application	SB5/6/7 SN5/6/7																						

KNORR CALIPERS

SN6000 / 7000 Types

	<table border="1"> <tr><td>TT KIT n°</td><td>CKSK.3.2</td></tr> <tr><td>Maker</td><td>KNORR</td></tr> <tr><td>OR kit n°</td><td>K000472</td></tr> <tr><td>Description</td><td>Guides & Seals</td></tr> <tr><td>Application</td><td>SN6 /7 series</td></tr> </table>	TT KIT n°	CKSK.3.2	Maker	KNORR	OR kit n°	K000472	Description	Guides & Seals	Application	SN6 /7 series		<table border="1"> <tr><td>TT KIT n°</td><td>CKSK.8.1</td></tr> <tr><td>Maker</td><td>KNORR</td></tr> <tr><td>OR kit n°</td><td>-</td></tr> <tr><td>Description</td><td>Guide & seals</td></tr> <tr><td>Application</td><td>All SB... All SN...</td></tr> </table>	TT KIT n°	CKSK.8.1	Maker	KNORR	OR kit n°	-	Description	Guide & seals	Application	All SB... All SN...
TT KIT n°	CKSK.3.2																						
Maker	KNORR																						
OR kit n°	K000472																						
Description	Guides & Seals																						
Application	SN6 /7 series																						
TT KIT n°	CKSK.8.1																						
Maker	KNORR																						
OR kit n°	-																						
Description	Guide & seals																						
Application	All SB... All SN...																						
	<table border="1"> <tr><td>TT KIT n°</td><td>CKSK.4.2</td></tr> <tr><td>Maker</td><td>KNORR</td></tr> <tr><td>OR kit n°</td><td>K001300</td></tr> <tr><td>Description</td><td>Tappets</td></tr> <tr><td>Application</td><td>All SN/NA/SK</td></tr> </table>	TT KIT n°	CKSK.4.2	Maker	KNORR	OR kit n°	K001300	Description	Tappets	Application	All SN/NA/SK		<table border="1"> <tr><td>TT KIT n°</td><td>CKSK.22</td></tr> <tr><td>Maker</td><td>KNORR</td></tr> <tr><td>OR kit n°</td><td>-</td></tr> <tr><td>Description</td><td>Cover & gasket</td></tr> <tr><td>Application</td><td>SN6 /7 series</td></tr> </table>	TT KIT n°	CKSK.22	Maker	KNORR	OR kit n°	-	Description	Cover & gasket	Application	SN6 /7 series
TT KIT n°	CKSK.4.2																						
Maker	KNORR																						
OR kit n°	K001300																						
Description	Tappets																						
Application	All SN/NA/SK																						
TT KIT n°	CKSK.22																						
Maker	KNORR																						
OR kit n°	-																						
Description	Cover & gasket																						
Application	SN6 /7 series																						
	<table border="1"> <tr><td>TT KIT n°</td><td>CKSK.5</td></tr> <tr><td>Maker</td><td>KNORR</td></tr> <tr><td>OR kit n°</td><td>K001301</td></tr> <tr><td>Description</td><td>Outer boots and steelcaps</td></tr> <tr><td>Application</td><td>All SB... All SN...</td></tr> </table>	TT KIT n°	CKSK.5	Maker	KNORR	OR kit n°	K001301	Description	Outer boots and steelcaps	Application	All SB... All SN...		<table border="1"> <tr><td>TT KIT n°</td><td>CKSK.10.1</td></tr> <tr><td>Maker</td><td>KNORR</td></tr> <tr><td>OR kit n°</td><td>-</td></tr> <tr><td>Description</td><td>Pignon-shaft</td></tr> <tr><td>Application</td><td>All SB... All SN...</td></tr> </table>	TT KIT n°	CKSK.10.1	Maker	KNORR	OR kit n°	-	Description	Pignon-shaft	Application	All SB... All SN...
TT KIT n°	CKSK.5																						
Maker	KNORR																						
OR kit n°	K001301																						
Description	Outer boots and steelcaps																						
Application	All SB... All SN...																						
TT KIT n°	CKSK.10.1																						
Maker	KNORR																						
OR kit n°	-																						
Description	Pignon-shaft																						
Application	All SB... All SN...																						
	<table border="1"> <tr><td>TT KIT n°</td><td>CKSK.2.5</td></tr> <tr><td>Maker</td><td>KNORR</td></tr> <tr><td>OR kit n°</td><td>II19712004</td></tr> <tr><td>Description</td><td>Complete overhaul</td></tr> <tr><td>Application</td><td>SB6 /7 series</td></tr> </table>	TT KIT n°	CKSK.2.5	Maker	KNORR	OR kit n°	II19712004	Description	Complete overhaul	Application	SB6 /7 series		<table border="1"> <tr><td>TT KIT n°</td><td>CKSK.11</td></tr> <tr><td>Maker</td><td>KNORR</td></tr> <tr><td>OR kit n°</td><td>-</td></tr> <tr><td>Description</td><td>Chain</td></tr> <tr><td>Application</td><td>SB6 /7 series SN6 /7 series</td></tr> </table>	TT KIT n°	CKSK.11	Maker	KNORR	OR kit n°	-	Description	Chain	Application	SB6 /7 series SN6 /7 series
TT KIT n°	CKSK.2.5																						
Maker	KNORR																						
OR kit n°	II19712004																						
Description	Complete overhaul																						
Application	SB6 /7 series																						
TT KIT n°	CKSK.11																						
Maker	KNORR																						
OR kit n°	-																						
Description	Chain																						
Application	SB6 /7 series SN6 /7 series																						
	<table border="1"> <tr><td>TT KIT n°</td><td>CKSK.16.1</td></tr> <tr><td>Maker</td><td>KNORR</td></tr> <tr><td>OR kit n°</td><td>K000944</td></tr> <tr><td>Description</td><td>Plastic cover</td></tr> <tr><td>Application</td><td>All SB... All SN...</td></tr> </table>	TT KIT n°	CKSK.16.1	Maker	KNORR	OR kit n°	K000944	Description	Plastic cover	Application	All SB... All SN...		<table border="1"> <tr><td>TT KIT n°</td><td>CKSK.16.1.R</td></tr> <tr><td>Maker</td><td>KNORR</td></tr> <tr><td>OR kit n°</td><td>-</td></tr> <tr><td>Description</td><td>New plastic cover</td></tr> <tr><td>Application</td><td>SN.7041 /51 SN.7208 /18</td></tr> </table>	TT KIT n°	CKSK.16.1.R	Maker	KNORR	OR kit n°	-	Description	New plastic cover	Application	SN.7041 /51 SN.7208 /18
TT KIT n°	CKSK.16.1																						
Maker	KNORR																						
OR kit n°	K000944																						
Description	Plastic cover																						
Application	All SB... All SN...																						
TT KIT n°	CKSK.16.1.R																						
Maker	KNORR																						
OR kit n°	-																						
Description	New plastic cover																						
Application	SN.7041 /51 SN.7208 /18																						
	<table border="1"> <tr><td>TT KIT n°</td><td>CKSK.10.3</td></tr> <tr><td>Maker</td><td>KNORR</td></tr> <tr><td>OR kit n°</td><td>-</td></tr> <tr><td>Description</td><td>Adjusting mechanism</td></tr> <tr><td>Application</td><td>All SB... All SN...</td></tr> </table>	TT KIT n°	CKSK.10.3	Maker	KNORR	OR kit n°	-	Description	Adjusting mechanism	Application	All SB... All SN...		<table border="1"> <tr><td>TT KIT n°</td><td>CKSK.10.4</td></tr> <tr><td>Maker</td><td>KNORR</td></tr> <tr><td>OR kit n°</td><td>-</td></tr> <tr><td>Description</td><td>Adjusting mechanism</td></tr> <tr><td>Application</td><td>All SB...</td></tr> </table>	TT KIT n°	CKSK.10.4	Maker	KNORR	OR kit n°	-	Description	Adjusting mechanism	Application	All SB...
TT KIT n°	CKSK.10.3																						
Maker	KNORR																						
OR kit n°	-																						
Description	Adjusting mechanism																						
Application	All SB... All SN...																						
TT KIT n°	CKSK.10.4																						
Maker	KNORR																						
OR kit n°	-																						
Description	Adjusting mechanism																						
Application	All SB...																						









KNORR CALIPER repair kits

Repair kits details

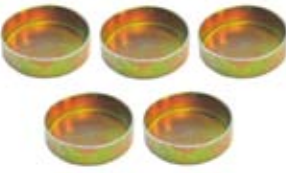
MORE KITS NEXT PAGE

KNORR CALIPERS

SN6000 / 7000 Types

	<table border="1"> <tr><td>TT KIT n°</td><td>CKSK.14.1</td></tr> <tr><td>Maker</td><td>KNORR</td></tr> <tr><td>OR kit n°</td><td>-</td></tr> <tr><td>Description</td><td>Roller bearing</td></tr> <tr><td>Application</td><td>All SN..</td></tr> </table>	TT KIT n°	CKSK.14.1	Maker	KNORR	OR kit n°	-	Description	Roller bearing	Application	All SN..		<table border="1"> <tr><td>TT KIT n°</td><td>CKSK.15</td></tr> <tr><td>Maker</td><td>KNORR</td></tr> <tr><td>OR kit n°</td><td>-</td></tr> <tr><td>Description</td><td>Lever Bearing</td></tr> <tr><td>Application</td><td>All SB.... All SN...</td></tr> </table>	TT KIT n°	CKSK.15	Maker	KNORR	OR kit n°	-	Description	Lever Bearing	Application	All SB.... All SN...
TT KIT n°	CKSK.14.1																						
Maker	KNORR																						
OR kit n°	-																						
Description	Roller bearing																						
Application	All SN..																						
TT KIT n°	CKSK.15																						
Maker	KNORR																						
OR kit n°	-																						
Description	Lever Bearing																						
Application	All SB.... All SN...																						
	<table border="1"> <tr><td>TT KIT n°</td><td>CKSK.11.1</td></tr> <tr><td>Maker</td><td>KNORR</td></tr> <tr><td>OR kit n°</td><td>-</td></tr> <tr><td>Description</td><td>Gear Wheel Adj. Mechanism</td></tr> <tr><td>Application</td><td>All SB... All SN...</td></tr> </table>	TT KIT n°	CKSK.11.1	Maker	KNORR	OR kit n°	-	Description	Gear Wheel Adj. Mechanism	Application	All SB... All SN...		<table border="1"> <tr><td>TT KIT n°</td><td>CKSK.3.3</td></tr> <tr><td>Maker</td><td>KNORR</td></tr> <tr><td>OR kit n°</td><td>-</td></tr> <tr><td>Description</td><td>Caps</td></tr> <tr><td>Application</td><td>All SN...</td></tr> </table>	TT KIT n°	CKSK.3.3	Maker	KNORR	OR kit n°	-	Description	Caps	Application	All SN...
TT KIT n°	CKSK.11.1																						
Maker	KNORR																						
OR kit n°	-																						
Description	Gear Wheel Adj. Mechanism																						
Application	All SB... All SN...																						
TT KIT n°	CKSK.3.3																						
Maker	KNORR																						
OR kit n°	-																						
Description	Caps																						
Application	All SN...																						
	<table border="1"> <tr><td>TT KIT n°</td><td>CKSK.18.2</td></tr> <tr><td>Maker</td><td>KNORR</td></tr> <tr><td>OR kit n°</td><td>-</td></tr> <tr><td>Description</td><td>Lever (angle +12°)</td></tr> <tr><td>Application</td><td>SN.7... series</td></tr> </table>	TT KIT n°	CKSK.18.2	Maker	KNORR	OR kit n°	-	Description	Lever (angle +12°)	Application	SN.7... series		<table border="1"> <tr><td>TT KIT n°</td><td>CKSK.18.3</td></tr> <tr><td>Maker</td><td>KNORR</td></tr> <tr><td>OR kit n°</td><td>-</td></tr> <tr><td>Description</td><td>Lever (angle +0°)</td></tr> <tr><td>Application</td><td>SN.7... series</td></tr> </table>	TT KIT n°	CKSK.18.3	Maker	KNORR	OR kit n°	-	Description	Lever (angle +0°)	Application	SN.7... series
TT KIT n°	CKSK.18.2																						
Maker	KNORR																						
OR kit n°	-																						
Description	Lever (angle +12°)																						
Application	SN.7... series																						
TT KIT n°	CKSK.18.3																						
Maker	KNORR																						
OR kit n°	-																						
Description	Lever (angle +0°)																						
Application	SN.7... series																						
	<table border="1"> <tr><td>TT KIT n°</td><td>CKSK.13.1</td></tr> <tr><td>Maker</td><td>KNORR</td></tr> <tr><td>OR kit n°</td><td>-</td></tr> <tr><td>Description</td><td>Guide & Bush Ø 35mm</td></tr> <tr><td>Application</td><td>SB5/6/7 SN5/6/7</td></tr> </table>	TT KIT n°	CKSK.13.1	Maker	KNORR	OR kit n°	-	Description	Guide & Bush Ø 35mm	Application	SB5/6/7 SN5/6/7		<table border="1"> <tr><td>TT KIT n°</td><td>CKSK.13.2</td></tr> <tr><td>Maker</td><td>KNORR</td></tr> <tr><td>OR kit n°</td><td>-</td></tr> <tr><td>Description</td><td>Guide & Bush Ø 39mm</td></tr> <tr><td>Application</td><td>SB5/6/7 SN5/6/7</td></tr> </table>	TT KIT n°	CKSK.13.2	Maker	KNORR	OR kit n°	-	Description	Guide & Bush Ø 39mm	Application	SB5/6/7 SN5/6/7
TT KIT n°	CKSK.13.1																						
Maker	KNORR																						
OR kit n°	-																						
Description	Guide & Bush Ø 35mm																						
Application	SB5/6/7 SN5/6/7																						
TT KIT n°	CKSK.13.2																						
Maker	KNORR																						
OR kit n°	-																						
Description	Guide & Bush Ø 39mm																						
Application	SB5/6/7 SN5/6/7																						
	<table border="1"> <tr><td>TT KIT n°</td><td>CKSK.3.4</td></tr> <tr><td>Maker</td><td>KNORR</td></tr> <tr><td>OR kit n°</td><td>-</td></tr> <tr><td>Description</td><td>Sealing Plug</td></tr> <tr><td>Application</td><td>SN5/6/7</td></tr> </table>	TT KIT n°	CKSK.3.4	Maker	KNORR	OR kit n°	-	Description	Sealing Plug	Application	SN5/6/7		<table border="1"> <tr><td>TT KIT n°</td><td>CKSK.2.7</td></tr> <tr><td>Maker</td><td>KNORR</td></tr> <tr><td>OR kit n°</td><td>-</td></tr> <tr><td>Description</td><td>Caps & pad retainer pins</td></tr> <tr><td>Application</td><td>All SB... All SN...</td></tr> </table>	TT KIT n°	CKSK.2.7	Maker	KNORR	OR kit n°	-	Description	Caps & pad retainer pins	Application	All SB... All SN...
TT KIT n°	CKSK.3.4																						
Maker	KNORR																						
OR kit n°	-																						
Description	Sealing Plug																						
Application	SN5/6/7																						
TT KIT n°	CKSK.2.7																						
Maker	KNORR																						
OR kit n°	-																						
Description	Caps & pad retainer pins																						
Application	All SB... All SN...																						

KNORR CALIPER repair kits

Repair kits details

MERITOR CALIPERS





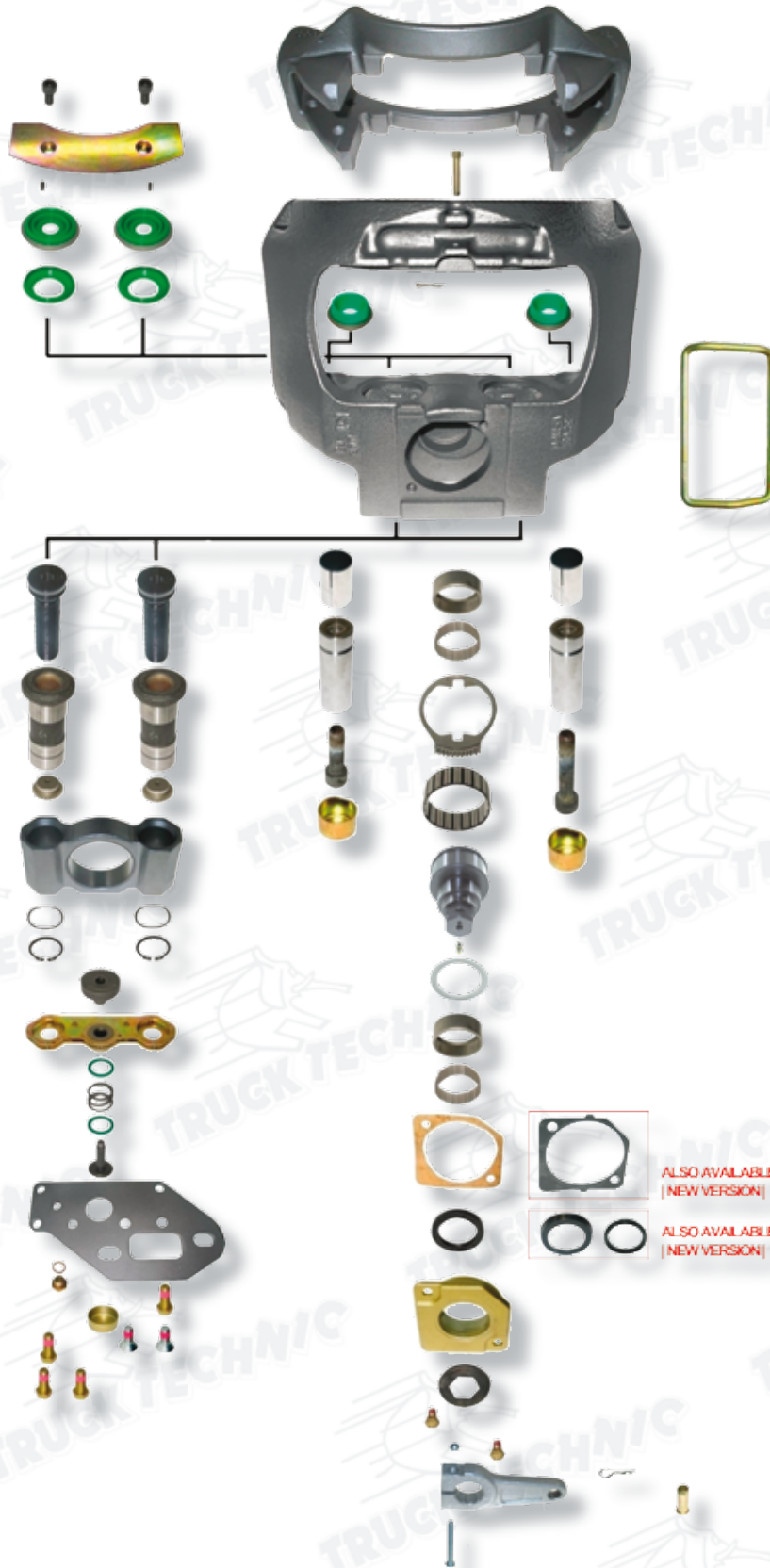







DX.195.51/52 Types

Typical exploded view of most key models are exposed here, to help you to choose correct repair kits.



MERITOR CALIPERS

DX.195.51/52 Types

	<table border="1"> <tr><td>TT KIT n°</td><td>CMSK.2</td></tr> <tr><td>Maker</td><td>MERITOR</td></tr> <tr><td>OR kit n°</td><td>MCK1168</td></tr> <tr><td>Description</td><td>Shaft fittings</td></tr> <tr><td>Application</td><td>DX.195.51 DX.195.52</td></tr> </table>	TT KIT n°	CMSK.2	Maker	MERITOR	OR kit n°	MCK1168	Description	Shaft fittings	Application	DX.195.51 DX.195.52		<table border="1"> <tr><td>TT KIT n°</td><td>CMSK.8</td></tr> <tr><td>Maker</td><td>MERITOR</td></tr> <tr><td>OR kit n°</td><td>MCK1171</td></tr> <tr><td>Description</td><td>Complete overhaul</td></tr> <tr><td>Application</td><td>DX.195.51 DX.195.52</td></tr> </table>	TT KIT n°	CMSK.8	Maker	MERITOR	OR kit n°	MCK1171	Description	Complete overhaul	Application	DX.195.51 DX.195.52
TT KIT n°	CMSK.2																						
Maker	MERITOR																						
OR kit n°	MCK1168																						
Description	Shaft fittings																						
Application	DX.195.51 DX.195.52																						
TT KIT n°	CMSK.8																						
Maker	MERITOR																						
OR kit n°	MCK1171																						
Description	Complete overhaul																						
Application	DX.195.51 DX.195.52																						
	<table border="1"> <tr><td>TT KIT n°</td><td>CMSK.2.D</td></tr> <tr><td>Maker</td><td>MERITOR</td></tr> <tr><td>OR kit n°</td><td>DSB3</td></tr> <tr><td>Description</td><td>Roller bearings (complete)</td></tr> <tr><td>Application</td><td>DX.195.51 DX.195.52</td></tr> </table>	TT KIT n°	CMSK.2.D	Maker	MERITOR	OR kit n°	DSB3	Description	Roller bearings (complete)	Application	DX.195.51 DX.195.52		<table border="1"> <tr><td>TT KIT n°</td><td>CMSK.2.B</td></tr> <tr><td>Maker</td><td>MERITOR</td></tr> <tr><td>OR kit n°</td><td>-</td></tr> <tr><td>Description</td><td>Roller bearings (light)</td></tr> <tr><td>Application</td><td>DX.195.51 DX.195.52</td></tr> </table>	TT KIT n°	CMSK.2.B	Maker	MERITOR	OR kit n°	-	Description	Roller bearings (light)	Application	DX.195.51 DX.195.52
TT KIT n°	CMSK.2.D																						
Maker	MERITOR																						
OR kit n°	DSB3																						
Description	Roller bearings (complete)																						
Application	DX.195.51 DX.195.52																						
TT KIT n°	CMSK.2.B																						
Maker	MERITOR																						
OR kit n°	-																						
Description	Roller bearings (light)																						
Application	DX.195.51 DX.195.52																						
	<table border="1"> <tr><td>TT KIT n°</td><td>CMSK.2.1</td></tr> <tr><td>Maker</td><td>MERITOR</td></tr> <tr><td>OR kit n°</td><td>MCK1192</td></tr> <tr><td>Description</td><td>Boots, caps & screws</td></tr> <tr><td>Application</td><td>DX.195.51 DX.195.52</td></tr> </table>	TT KIT n°	CMSK.2.1	Maker	MERITOR	OR kit n°	MCK1192	Description	Boots, caps & screws	Application	DX.195.51 DX.195.52		<table border="1"> <tr><td>TT KIT n°</td><td>CMSK.2.H</td></tr> <tr><td>Maker</td><td>MERITOR</td></tr> <tr><td>OR kit n°</td><td>-</td></tr> <tr><td>Description</td><td>Stabilizer bar</td></tr> <tr><td>Application</td><td>DX.195.51 DX.195.52</td></tr> </table>	TT KIT n°	CMSK.2.H	Maker	MERITOR	OR kit n°	-	Description	Stabilizer bar	Application	DX.195.51 DX.195.52
TT KIT n°	CMSK.2.1																						
Maker	MERITOR																						
OR kit n°	MCK1192																						
Description	Boots, caps & screws																						
Application	DX.195.51 DX.195.52																						
TT KIT n°	CMSK.2.H																						
Maker	MERITOR																						
OR kit n°	-																						
Description	Stabilizer bar																						
Application	DX.195.51 DX.195.52																						
	<table border="1"> <tr><td>TT KIT n°</td><td>CMSK.2.F</td></tr> <tr><td>Maker</td><td>MERITOR</td></tr> <tr><td>OR kit n°</td><td>DSL5L</td></tr> <tr><td>Description</td><td>Adjusting mechanism (light)</td></tr> <tr><td>Application</td><td>DX.195.51</td></tr> </table>	TT KIT n°	CMSK.2.F	Maker	MERITOR	OR kit n°	DSL5L	Description	Adjusting mechanism (light)	Application	DX.195.51		<table border="1"> <tr><td>TT KIT n°</td><td>CMSK.2.E</td></tr> <tr><td>Maker</td><td>MERITOR</td></tr> <tr><td>OR kit n°</td><td>DSL5R</td></tr> <tr><td>Description</td><td>Adjusting mechanism (light)</td></tr> <tr><td>Application</td><td>DX.195.52</td></tr> </table>	TT KIT n°	CMSK.2.E	Maker	MERITOR	OR kit n°	DSL5R	Description	Adjusting mechanism (light)	Application	DX.195.52
TT KIT n°	CMSK.2.F																						
Maker	MERITOR																						
OR kit n°	DSL5L																						
Description	Adjusting mechanism (light)																						
Application	DX.195.51																						
TT KIT n°	CMSK.2.E																						
Maker	MERITOR																						
OR kit n°	DSL5R																						
Description	Adjusting mechanism (light)																						
Application	DX.195.52																						
	<table border="1"> <tr><td>TT KIT n°</td><td>CMSK.19</td></tr> <tr><td>Maker</td><td>MERITOR</td></tr> <tr><td>OR kit n°</td><td>DSL6R</td></tr> <tr><td>Description</td><td>Bridge & tubes</td></tr> <tr><td>Application</td><td>DX.195.52</td></tr> </table>	TT KIT n°	CMSK.19	Maker	MERITOR	OR kit n°	DSL6R	Description	Bridge & tubes	Application	DX.195.52		<table border="1"> <tr><td>TT KIT n°</td><td>CMSK.20</td></tr> <tr><td>Maker</td><td>MERITOR</td></tr> <tr><td>OR kit n°</td><td>DSL6L</td></tr> <tr><td>Description</td><td>Bridge & tubes</td></tr> <tr><td>Application</td><td>DX.195.51</td></tr> </table>	TT KIT n°	CMSK.20	Maker	MERITOR	OR kit n°	DSL6L	Description	Bridge & tubes	Application	DX.195.51
TT KIT n°	CMSK.19																						
Maker	MERITOR																						
OR kit n°	DSL6R																						
Description	Bridge & tubes																						
Application	DX.195.52																						
TT KIT n°	CMSK.20																						
Maker	MERITOR																						
OR kit n°	DSL6L																						
Description	Bridge & tubes																						
Application	DX.195.51																						
	<table border="1"> <tr><td>TT KIT n°</td><td>CMSK.9.1</td></tr> <tr><td>Maker</td><td>MERITOR</td></tr> <tr><td>OR kit n°</td><td>-</td></tr> <tr><td>Description</td><td>Push plate (left)</td></tr> <tr><td>Application</td><td>DX.195.51</td></tr> </table>	TT KIT n°	CMSK.9.1	Maker	MERITOR	OR kit n°	-	Description	Push plate (left)	Application	DX.195.51		<table border="1"> <tr><td>TT KIT n°</td><td>CMSK.9.2</td></tr> <tr><td>Maker</td><td>MERITOR</td></tr> <tr><td>OR kit n°</td><td>-</td></tr> <tr><td>Description</td><td>Push plate (right)</td></tr> <tr><td>Application</td><td>DX.195.52</td></tr> </table>	TT KIT n°	CMSK.9.2	Maker	MERITOR	OR kit n°	-	Description	Push plate (right)	Application	DX.195.52
TT KIT n°	CMSK.9.1																						
Maker	MERITOR																						
OR kit n°	-																						
Description	Push plate (left)																						
Application	DX.195.51																						
TT KIT n°	CMSK.9.2																						
Maker	MERITOR																						
OR kit n°	-																						
Description	Push plate (right)																						
Application	DX.195.52																						

MERITOR CALIPER repair kits

Repair kits details



MERITOR CALIPERS

DX.195.51/52 Types

Typical exploded view of most key models are exposed here, to help you to choose correct repair kits.

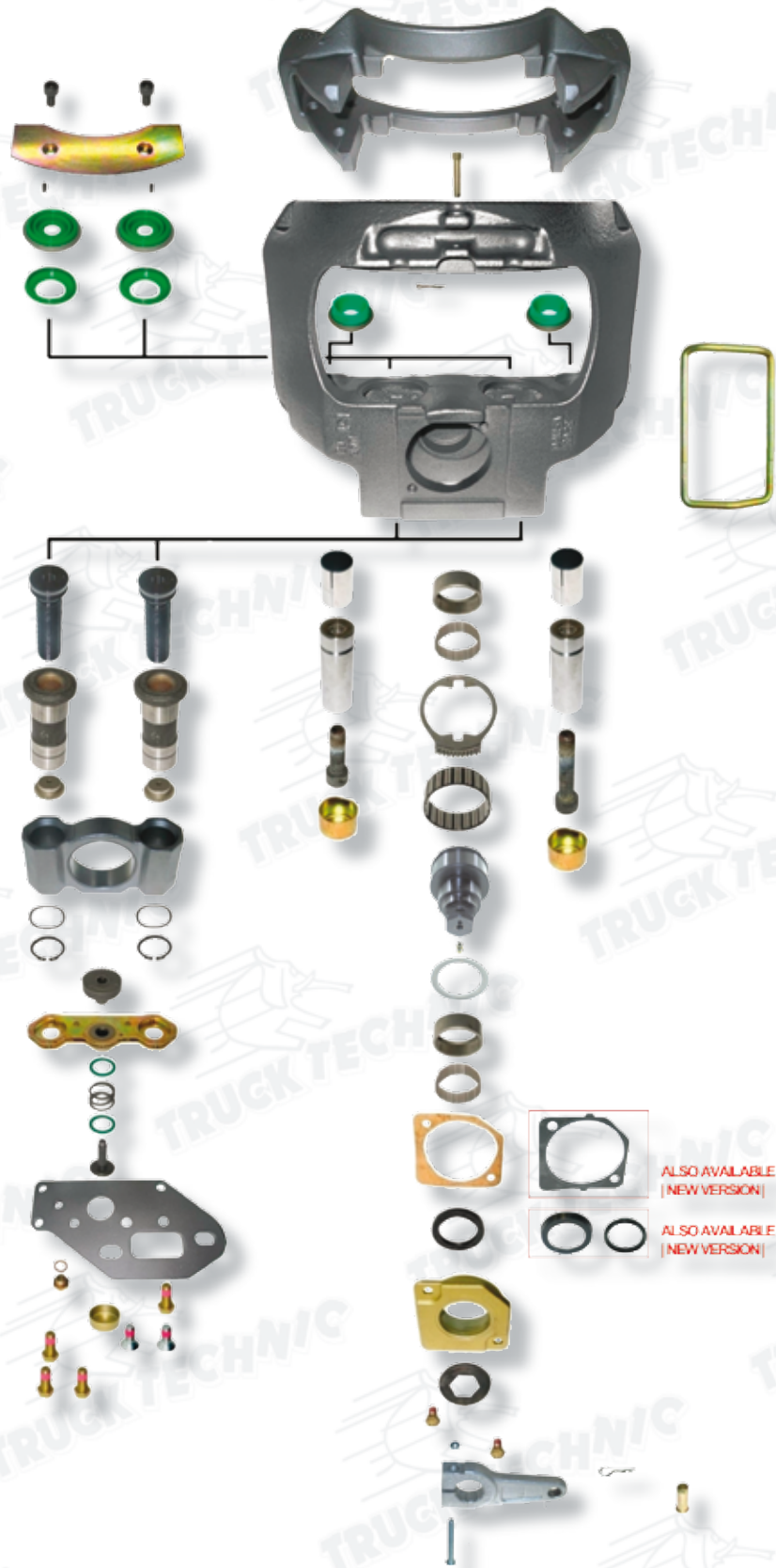

MERITOR CALIPERS

DX.195.51/52 Types

	<table border="1"> <tr><td>TT KIT n°</td><td>CMSK.2.R</td></tr> <tr><td>Maker</td><td>MERITOR</td></tr> <tr><td>OR kit n°</td><td>MCK1294</td></tr> <tr><td>Description</td><td>Shaft fittings (with grease nipple)</td></tr> <tr><td>Application</td><td>DX.195.51 DX.195.52</td></tr> </table>	TT KIT n°	CMSK.2.R	Maker	MERITOR	OR kit n°	MCK1294	Description	Shaft fittings (with grease nipple)	Application	DX.195.51 DX.195.52		<table border="1"> <tr><td>TT KIT n°</td><td>CMSK.2.K</td></tr> <tr><td>Maker</td><td>MERITOR</td></tr> <tr><td>OR kit n°</td><td>MCK1154</td></tr> <tr><td>Description</td><td>Stabilizer bar kit</td></tr> <tr><td>Application</td><td>DX.195.51 DX.195.52</td></tr> </table>	TT KIT n°	CMSK.2.K	Maker	MERITOR	OR kit n°	MCK1154	Description	Stabilizer bar kit	Application	DX.195.51 DX.195.52
TT KIT n°	CMSK.2.R																						
Maker	MERITOR																						
OR kit n°	MCK1294																						
Description	Shaft fittings (with grease nipple)																						
Application	DX.195.51 DX.195.52																						
TT KIT n°	CMSK.2.K																						
Maker	MERITOR																						
OR kit n°	MCK1154																						
Description	Stabilizer bar kit																						
Application	DX.195.51 DX.195.52																						
	<table border="1"> <tr><td>TT KIT n°</td><td>CMSK.2.G</td></tr> <tr><td>Maker</td><td>MERITOR</td></tr> <tr><td>OR kit n°</td><td>-</td></tr> <tr><td>Description</td><td>SHAFT (without grease nipple)</td></tr> <tr><td>Application</td><td>DX.195.51 DX.195.52</td></tr> </table>	TT KIT n°	CMSK.2.G	Maker	MERITOR	OR kit n°	-	Description	SHAFT (without grease nipple)	Application	DX.195.51 DX.195.52		<table border="1"> <tr><td>TT KIT n°</td><td>CMSK.2.GR</td></tr> <tr><td>Maker</td><td>MERITOR</td></tr> <tr><td>OR kit n°</td><td>-</td></tr> <tr><td>Description</td><td>SHAFT (with grease nipple)</td></tr> <tr><td>Application</td><td>DX.195.51 DX.195.52</td></tr> </table>	TT KIT n°	CMSK.2.GR	Maker	MERITOR	OR kit n°	-	Description	SHAFT (with grease nipple)	Application	DX.195.51 DX.195.52
TT KIT n°	CMSK.2.G																						
Maker	MERITOR																						
OR kit n°	-																						
Description	SHAFT (without grease nipple)																						
Application	DX.195.51 DX.195.52																						
TT KIT n°	CMSK.2.GR																						
Maker	MERITOR																						
OR kit n°	-																						
Description	SHAFT (with grease nipple)																						
Application	DX.195.51 DX.195.52																						
	<table border="1"> <tr><td>TT KIT n°</td><td>CMSK.19.1</td></tr> <tr><td>Maker</td><td>MERITOR</td></tr> <tr><td>OR kit n°</td><td>-</td></tr> <tr><td>Description</td><td>Bridge & inner bearing</td></tr> <tr><td>Application</td><td>DX.195.51 DX.195.52</td></tr> </table>	TT KIT n°	CMSK.19.1	Maker	MERITOR	OR kit n°	-	Description	Bridge & inner bearing	Application	DX.195.51 DX.195.52		<table border="1"> <tr><td>TT KIT n°</td><td>CMSK.21</td></tr> <tr><td>Maker</td><td>MERITOR</td></tr> <tr><td>OR kit n°</td><td>MCK1185</td></tr> <tr><td>Description</td><td>Saddle kit (pad carrier)</td></tr> <tr><td>Application</td><td>DX.195.51 DX.195.52</td></tr> </table>	TT KIT n°	CMSK.21	Maker	MERITOR	OR kit n°	MCK1185	Description	Saddle kit (pad carrier)	Application	DX.195.51 DX.195.52
TT KIT n°	CMSK.19.1																						
Maker	MERITOR																						
OR kit n°	-																						
Description	Bridge & inner bearing																						
Application	DX.195.51 DX.195.52																						
TT KIT n°	CMSK.21																						
Maker	MERITOR																						
OR kit n°	MCK1185																						
Description	Saddle kit (pad carrier)																						
Application	DX.195.51 DX.195.52																						
	<table border="1"> <tr><td>TT KIT n°</td><td>CMSK.19.2</td></tr> <tr><td>Maker</td><td>MERITOR</td></tr> <tr><td>OR kit n°</td><td>-</td></tr> <tr><td>Description</td><td>Pistons & pignons</td></tr> <tr><td>Application</td><td>DX.195.52</td></tr> </table>	TT KIT n°	CMSK.19.2	Maker	MERITOR	OR kit n°	-	Description	Pistons & pignons	Application	DX.195.52		<table border="1"> <tr><td>TT KIT n°</td><td>CMSK.20.2</td></tr> <tr><td>Maker</td><td>MERITOR</td></tr> <tr><td>OR kit n°</td><td>-</td></tr> <tr><td>Description</td><td>Pistons & pignons</td></tr> <tr><td>Application</td><td>DX.195.51</td></tr> </table>	TT KIT n°	CMSK.20.2	Maker	MERITOR	OR kit n°	-	Description	Pistons & pignons	Application	DX.195.51
TT KIT n°	CMSK.19.2																						
Maker	MERITOR																						
OR kit n°	-																						
Description	Pistons & pignons																						
Application	DX.195.52																						
TT KIT n°	CMSK.20.2																						
Maker	MERITOR																						
OR kit n°	-																						
Description	Pistons & pignons																						
Application	DX.195.51																						
	<table border="1"> <tr><td>TT KIT n°</td><td>CMSK.19.3</td></tr> <tr><td>Maker</td><td>MERITOR</td></tr> <tr><td>OR kit n°</td><td>-</td></tr> <tr><td>Description</td><td>Central fork & pignon</td></tr> <tr><td>Application</td><td>DX.195.51 DX.195.52</td></tr> </table>	TT KIT n°	CMSK.19.3	Maker	MERITOR	OR kit n°	-	Description	Central fork & pignon	Application	DX.195.51 DX.195.52		<table border="1"> <tr><td>TT KIT n°</td><td>CMSK.2.J</td></tr> <tr><td>Maker</td><td>MERITOR</td></tr> <tr><td>OR kit n°</td><td>-</td></tr> <tr><td>Description</td><td>Bracket seal & pin</td></tr> <tr><td>Application</td><td>DX.195.51 DX.195.52</td></tr> </table>	TT KIT n°	CMSK.2.J	Maker	MERITOR	OR kit n°	-	Description	Bracket seal & pin	Application	DX.195.51 DX.195.52
TT KIT n°	CMSK.19.3																						
Maker	MERITOR																						
OR kit n°	-																						
Description	Central fork & pignon																						
Application	DX.195.51 DX.195.52																						
TT KIT n°	CMSK.2.J																						
Maker	MERITOR																						
OR kit n°	-																						
Description	Bracket seal & pin																						
Application	DX.195.51 DX.195.52																						
	<table border="1"> <tr><td>TT KIT n°</td><td>CMSK.2.M</td></tr> <tr><td>Maker</td><td>MERITOR</td></tr> <tr><td>OR kit n°</td><td>MCK1290</td></tr> <tr><td>Description</td><td>Adjusting mechanism (full)</td></tr> <tr><td>Application</td><td>DX.195.51</td></tr> </table>	TT KIT n°	CMSK.2.M	Maker	MERITOR	OR kit n°	MCK1290	Description	Adjusting mechanism (full)	Application	DX.195.51		<table border="1"> <tr><td>TT KIT n°</td><td>CMSK.2.N</td></tr> <tr><td>Maker</td><td>MERITOR</td></tr> <tr><td>OR kit n°</td><td>MCK1291</td></tr> <tr><td>Description</td><td>Adjusting mechanism (full)</td></tr> <tr><td>Application</td><td>DX.195.52</td></tr> </table>	TT KIT n°	CMSK.2.N	Maker	MERITOR	OR kit n°	MCK1291	Description	Adjusting mechanism (full)	Application	DX.195.52
TT KIT n°	CMSK.2.M																						
Maker	MERITOR																						
OR kit n°	MCK1290																						
Description	Adjusting mechanism (full)																						
Application	DX.195.51																						
TT KIT n°	CMSK.2.N																						
Maker	MERITOR																						
OR kit n°	MCK1291																						
Description	Adjusting mechanism (full)																						
Application	DX.195.52																						
	<table border="1"> <tr><td>TT KIT n°</td><td>CMSK.2.P</td></tr> <tr><td>Maker</td><td>MERITOR</td></tr> <tr><td>OR kit n°</td><td>MCK1292</td></tr> <tr><td>Description</td><td>Adjuster sleeve & thrust plate</td></tr> <tr><td>Application</td><td>DX.195.51</td></tr> </table>	TT KIT n°	CMSK.2.P	Maker	MERITOR	OR kit n°	MCK1292	Description	Adjuster sleeve & thrust plate	Application	DX.195.51		<table border="1"> <tr><td>TT KIT n°</td><td>CMSK.2.Q</td></tr> <tr><td>Maker</td><td>MERITOR</td></tr> <tr><td>OR kit n°</td><td>MCK1293</td></tr> <tr><td>Description</td><td>Adjuster sleeve & thrust plate</td></tr> <tr><td>Application</td><td>DX.195.52</td></tr> </table>	TT KIT n°	CMSK.2.Q	Maker	MERITOR	OR kit n°	MCK1293	Description	Adjuster sleeve & thrust plate	Application	DX.195.52
TT KIT n°	CMSK.2.P																						
Maker	MERITOR																						
OR kit n°	MCK1292																						
Description	Adjuster sleeve & thrust plate																						
Application	DX.195.51																						
TT KIT n°	CMSK.2.Q																						
Maker	MERITOR																						
OR kit n°	MCK1293																						
Description	Adjuster sleeve & thrust plate																						
Application	DX.195.52																						

D3 TYPES OF MERITOR CALIPERS

LRG524 /25 /26 /27 /28 /29 /32 /33 /622 /623 Types

Typical exploded view of most key models are exposed here, to help you to choose correct repair kits.

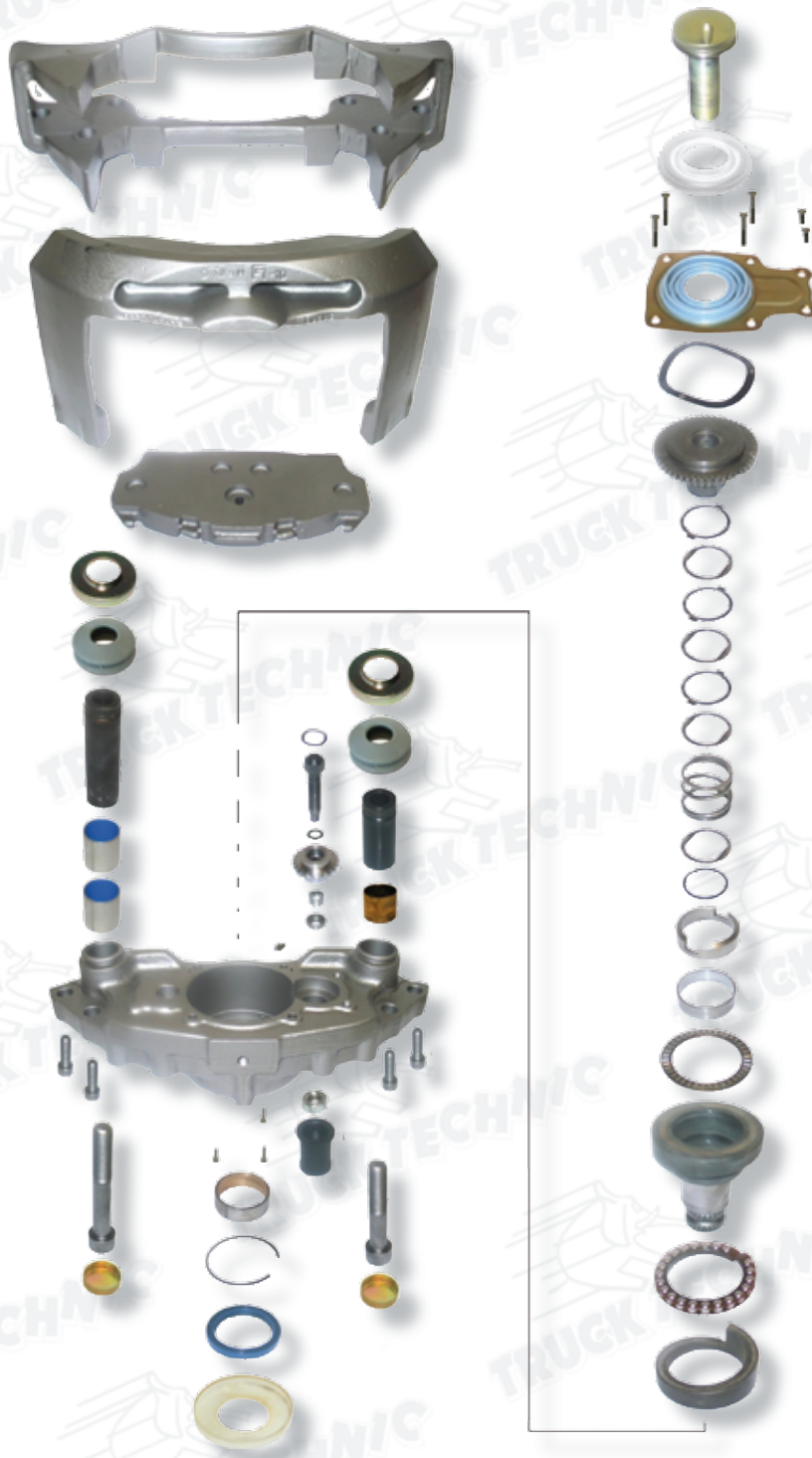

D3 TYPES OF MERITOR CALIPERS

LRG524 /25 /26 /27 /28 /29 /32 /33 /622 /623 Types

	<table border="1"> <tr><td>TT KIT n°</td><td>CMSK.1</td></tr> <tr><td>Maker</td><td>MERITOR</td></tr> <tr><td>OR kit n°</td><td>SJ4001</td></tr> <tr><td>Description</td><td>Guides & seals</td></tr> <tr><td>Application</td><td>LRG524/25/26/27 /28/29/32/33 /622/23</td></tr> </table>	TT KIT n°	CMSK.1	Maker	MERITOR	OR kit n°	SJ4001	Description	Guides & seals	Application	LRG524/25/26/27 /28/29/32/33 /622/23		<table border="1"> <tr><td>TT KIT n°</td><td>CMSK.6</td></tr> <tr><td>Maker</td><td>MERITOR</td></tr> <tr><td>OR kit n°</td><td>SJ1212</td></tr> <tr><td>Description</td><td>Cover & boots</td></tr> <tr><td>Application</td><td>LRG524/25/26/27 /28/29/32/33 /622/23</td></tr> </table>	TT KIT n°	CMSK.6	Maker	MERITOR	OR kit n°	SJ1212	Description	Cover & boots	Application	LRG524/25/26/27 /28/29/32/33 /622/23
TT KIT n°	CMSK.1																						
Maker	MERITOR																						
OR kit n°	SJ4001																						
Description	Guides & seals																						
Application	LRG524/25/26/27 /28/29/32/33 /622/23																						
TT KIT n°	CMSK.6																						
Maker	MERITOR																						
OR kit n°	SJ1212																						
Description	Cover & boots																						
Application	LRG524/25/26/27 /28/29/32/33 /622/23																						
	<table border="1"> <tr><td>TT KIT n°</td><td>CMSK.24</td></tr> <tr><td>Maker</td><td>MERITOR</td></tr> <tr><td>OR kit n°</td><td>-</td></tr> <tr><td>Description</td><td>Shaft (left)</td></tr> <tr><td>Application</td><td>LRG524 LRG526</td></tr> </table>	TT KIT n°	CMSK.24	Maker	MERITOR	OR kit n°	-	Description	Shaft (left)	Application	LRG524 LRG526		<table border="1"> <tr><td>TT KIT n°</td><td>CMSK.25</td></tr> <tr><td>Maker</td><td>MERITOR</td></tr> <tr><td>OR kit n°</td><td>-</td></tr> <tr><td>Description</td><td>Shaft (right)</td></tr> <tr><td>Application</td><td>LRG525 LRG527</td></tr> </table>	TT KIT n°	CMSK.25	Maker	MERITOR	OR kit n°	-	Description	Shaft (right)	Application	LRG525 LRG527
TT KIT n°	CMSK.24																						
Maker	MERITOR																						
OR kit n°	-																						
Description	Shaft (left)																						
Application	LRG524 LRG526																						
TT KIT n°	CMSK.25																						
Maker	MERITOR																						
OR kit n°	-																						
Description	Shaft (right)																						
Application	LRG525 LRG527																						
	<table border="1"> <tr><td>TT KIT n°</td><td>CMSK.28</td></tr> <tr><td>Maker</td><td>MERITOR</td></tr> <tr><td>OR kit n°</td><td>-</td></tr> <tr><td>Description</td><td>Shaft (left)</td></tr> <tr><td>Application</td><td>LRG528</td></tr> </table>	TT KIT n°	CMSK.28	Maker	MERITOR	OR kit n°	-	Description	Shaft (left)	Application	LRG528		<table border="1"> <tr><td>TT KIT n°</td><td>CMSK.29</td></tr> <tr><td>Maker</td><td>MERITOR</td></tr> <tr><td>OR kit n°</td><td>-</td></tr> <tr><td>Description</td><td>Shaft (right)</td></tr> <tr><td>Application</td><td>LRG529</td></tr> </table>	TT KIT n°	CMSK.29	Maker	MERITOR	OR kit n°	-	Description	Shaft (right)	Application	LRG529
TT KIT n°	CMSK.28																						
Maker	MERITOR																						
OR kit n°	-																						
Description	Shaft (left)																						
Application	LRG528																						
TT KIT n°	CMSK.29																						
Maker	MERITOR																						
OR kit n°	-																						
Description	Shaft (right)																						
Application	LRG529																						
	<table border="1"> <tr><td>TT KIT n°</td><td>CMSK.24.1</td></tr> <tr><td>Maker</td><td>MERITOR</td></tr> <tr><td>OR kit n°</td><td>-</td></tr> <tr><td>Description</td><td>Shaft support</td></tr> <tr><td>Application</td><td>LRG524 /26 /28 /32 /622</td></tr> </table>	TT KIT n°	CMSK.24.1	Maker	MERITOR	OR kit n°	-	Description	Shaft support	Application	LRG524 /26 /28 /32 /622		<table border="1"> <tr><td>TT KIT n°</td><td>CMSK.25.1</td></tr> <tr><td>Maker</td><td>MERITOR</td></tr> <tr><td>OR kit n°</td><td>-</td></tr> <tr><td>Description</td><td>Shaft support</td></tr> <tr><td>Application</td><td>LRG525 /27 /29 /33 /623</td></tr> </table>	TT KIT n°	CMSK.25.1	Maker	MERITOR	OR kit n°	-	Description	Shaft support	Application	LRG525 /27 /29 /33 /623
TT KIT n°	CMSK.24.1																						
Maker	MERITOR																						
OR kit n°	-																						
Description	Shaft support																						
Application	LRG524 /26 /28 /32 /622																						
TT KIT n°	CMSK.25.1																						
Maker	MERITOR																						
OR kit n°	-																						
Description	Shaft support																						
Application	LRG525 /27 /29 /33 /623																						
	<table border="1"> <tr><td>TT KIT n°</td><td>CMSK.24.3</td></tr> <tr><td>Maker</td><td>MERITOR</td></tr> <tr><td>OR kit n°</td><td>-</td></tr> <tr><td>Description</td><td>Clutch system (left)</td></tr> <tr><td>Application</td><td>LRG524 /26 /28 /32 /622</td></tr> </table>	TT KIT n°	CMSK.24.3	Maker	MERITOR	OR kit n°	-	Description	Clutch system (left)	Application	LRG524 /26 /28 /32 /622		<table border="1"> <tr><td>TT KIT n°</td><td>CMSK.25.3</td></tr> <tr><td>Maker</td><td>MERITOR</td></tr> <tr><td>OR kit n°</td><td>-</td></tr> <tr><td>Description</td><td>Clutch system (right)</td></tr> <tr><td>Application</td><td>LRG525 /27 /29 /33 /623</td></tr> </table>	TT KIT n°	CMSK.25.3	Maker	MERITOR	OR kit n°	-	Description	Clutch system (right)	Application	LRG525 /27 /29 /33 /623
TT KIT n°	CMSK.24.3																						
Maker	MERITOR																						
OR kit n°	-																						
Description	Clutch system (left)																						
Application	LRG524 /26 /28 /32 /622																						
TT KIT n°	CMSK.25.3																						
Maker	MERITOR																						
OR kit n°	-																						
Description	Clutch system (right)																						
Application	LRG525 /27 /29 /33 /623																						
	<table border="1"> <tr><td>TT KIT n°</td><td>CMSK.24.4</td></tr> <tr><td>Maker</td><td>MERITOR</td></tr> <tr><td>OR kit n°</td><td>-</td></tr> <tr><td>Description</td><td>Adjuster tappet (left)</td></tr> <tr><td>Application</td><td>LRG524 /26 /28 /32 /622</td></tr> </table>	TT KIT n°	CMSK.24.4	Maker	MERITOR	OR kit n°	-	Description	Adjuster tappet (left)	Application	LRG524 /26 /28 /32 /622		<table border="1"> <tr><td>TT KIT n°</td><td>CMSK.25.4</td></tr> <tr><td>Maker</td><td>MERITOR</td></tr> <tr><td>OR kit n°</td><td>-</td></tr> <tr><td>Description</td><td>Adjuster tappet (right)</td></tr> <tr><td>Application</td><td>LRG525 /27 /29</td></tr> </table>	TT KIT n°	CMSK.25.4	Maker	MERITOR	OR kit n°	-	Description	Adjuster tappet (right)	Application	LRG525 /27 /29
TT KIT n°	CMSK.24.4																						
Maker	MERITOR																						
OR kit n°	-																						
Description	Adjuster tappet (left)																						
Application	LRG524 /26 /28 /32 /622																						
TT KIT n°	CMSK.25.4																						
Maker	MERITOR																						
OR kit n°	-																						
Description	Adjuster tappet (right)																						
Application	LRG525 /27 /29																						

MERITOR CALIPER repair kits

Repair kits details



D3 TYPES OF MERITOR CALIPERS

LRG524 /25 /26 /27 /28 /29 /32 /33 /622 /623 Types

Typical exploded view of most key models are exposed here, to help you to choose correct repair kits.

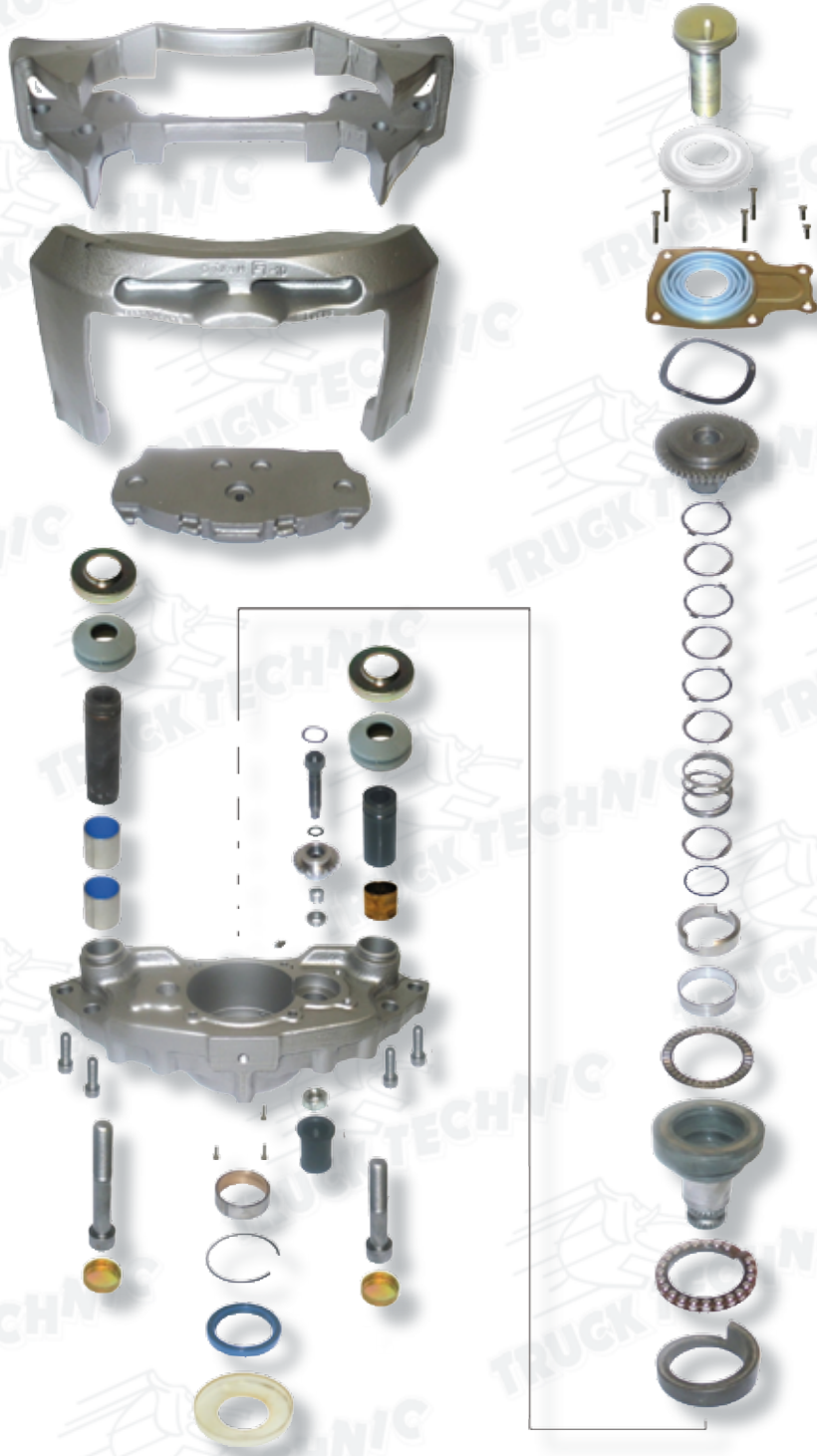





D3 TYPES OF MERITOR CALIPERS

LRG524 /25 /26 /27 /28 /29 /32 /33 /622 /623 Types

	TT KIT n°	CMSK.24.5		TT KIT n°	CMSK.25.5
	Maker	MERITOR		Maker	MERITOR
	OR kit n°	-		OR kit n°	-
	Description	Small clutch system (left)		Description	Small clutch system (right)
	Application	LRG524 /26 /28 /32 /622		Application	LRG525 /27 /29 /33 /623
	TT KIT n°	CMSK.24.6		TT KIT n°	CMSK.24.7
	Maker	MERITOR		Maker	MERITOR
	OR kit n°	-		OR kit n°	-
	Description	Wavy washer		Description	Shaft roller bearing
	Application	LRG524/25/26/27 /28/29/32/33 /622/23		Application	LRG524/25/26/27 /28/29/32/33 /622/23
	TT KIT n°	CMSK.24.2		TT KIT n°	
	Maker	MERITOR		Maker	
	OR kit n°	-		OR kit n°	-
	Description	Thrust ball bearing		Description	
	Application	LRG524/25/26/27 /28/29/32/33 /622/23		Application	

ELSA 1 TYPE OF MERITOR CALIPERS

LRG542 /43 /70 /71 /90 /91 /632 /633 /642 /643 Types

	<table border="1"> <tr><td>TT KIT n°</td><td>CMSK.3.3</td></tr> <tr><td>Maker</td><td>MERITOR</td></tr> <tr><td>OR kit n°</td><td>SJ4112</td></tr> <tr><td>Description</td><td>Half bearing</td></tr> <tr><td>Application</td><td>LRG542 /43 /70 /71/90 /91 /632 /633 /642 /643</td></tr> </table>	TT KIT n°	CMSK.3.3	Maker	MERITOR	OR kit n°	SJ4112	Description	Half bearing	Application	LRG542 /43 /70 /71/90 /91 /632 /633 /642 /643		<table border="1"> <tr><td>TT KIT n°</td><td>CMSK.5</td></tr> <tr><td>Maker</td><td>MERITOR</td></tr> <tr><td>OR kit n°</td><td>MCK1102</td></tr> <tr><td>Description</td><td>Guides & bushes</td></tr> <tr><td>Application</td><td>LRG542 /43 /70 /71/90 /91 /632 /633 /642 /643</td></tr> </table>	TT KIT n°	CMSK.5	Maker	MERITOR	OR kit n°	MCK1102	Description	Guides & bushes	Application	LRG542 /43 /70 /71/90 /91 /632 /633 /642 /643
TT KIT n°	CMSK.3.3																						
Maker	MERITOR																						
OR kit n°	SJ4112																						
Description	Half bearing																						
Application	LRG542 /43 /70 /71/90 /91 /632 /633 /642 /643																						
TT KIT n°	CMSK.5																						
Maker	MERITOR																						
OR kit n°	MCK1102																						
Description	Guides & bushes																						
Application	LRG542 /43 /70 /71/90 /91 /632 /633 /642 /643																						
	<table border="1"> <tr><td>TT KIT n°</td><td>CMSK.5.4</td></tr> <tr><td>Maker</td><td>MERITOR</td></tr> <tr><td>OR kit n°</td><td>68321678PK10</td></tr> <tr><td>Description</td><td>Locking shim</td></tr> <tr><td>Application</td><td>LRG542 /43 /70 /71/90 /91 /632 /633 /642 /643</td></tr> </table>	TT KIT n°	CMSK.5.4	Maker	MERITOR	OR kit n°	68321678PK10	Description	Locking shim	Application	LRG542 /43 /70 /71/90 /91 /632 /633 /642 /643		<table border="1"> <tr><td>TT KIT n°</td><td>CMSK.5.8</td></tr> <tr><td>Maker</td><td>MERITOR</td></tr> <tr><td>OR kit n°</td><td></td></tr> <tr><td>Description</td><td>Adj. Mechanism (side part)</td></tr> <tr><td>Application</td><td>LRG702 LRG703</td></tr> </table>	TT KIT n°	CMSK.5.8	Maker	MERITOR	OR kit n°		Description	Adj. Mechanism (side part)	Application	LRG702 LRG703
TT KIT n°	CMSK.5.4																						
Maker	MERITOR																						
OR kit n°	68321678PK10																						
Description	Locking shim																						
Application	LRG542 /43 /70 /71/90 /91 /632 /633 /642 /643																						
TT KIT n°	CMSK.5.8																						
Maker	MERITOR																						
OR kit n°																							
Description	Adj. Mechanism (side part)																						
Application	LRG702 LRG703																						
	<table border="1"> <tr><td>TT KIT n°</td><td>CMSK.5.6</td></tr> <tr><td>Maker</td><td>MERITOR</td></tr> <tr><td>OR kit n°</td><td></td></tr> <tr><td>Description</td><td>Adj. Mechanism 2 tappers (left)</td></tr> <tr><td>Application</td><td>LRG702</td></tr> </table>	TT KIT n°	CMSK.5.6	Maker	MERITOR	OR kit n°		Description	Adj. Mechanism 2 tappers (left)	Application	LRG702		<table border="1"> <tr><td>TT KIT n°</td><td>CMSK.5.7</td></tr> <tr><td>Maker</td><td>MERITOR</td></tr> <tr><td>OR kit n°</td><td></td></tr> <tr><td>Description</td><td>Adj. Mechanism 2 tappers (right)</td></tr> <tr><td>Application</td><td>LRG703</td></tr> </table>	TT KIT n°	CMSK.5.7	Maker	MERITOR	OR kit n°		Description	Adj. Mechanism 2 tappers (right)	Application	LRG703
TT KIT n°	CMSK.5.6																						
Maker	MERITOR																						
OR kit n°																							
Description	Adj. Mechanism 2 tappers (left)																						
Application	LRG702																						
TT KIT n°	CMSK.5.7																						
Maker	MERITOR																						
OR kit n°																							
Description	Adj. Mechanism 2 tappers (right)																						
Application	LRG703																						
	<table border="1"> <tr><td>TT KIT n°</td><td>CMSK.5.9</td></tr> <tr><td>Maker</td><td>MERITOR</td></tr> <tr><td>OR kit n°</td><td></td></tr> <tr><td>Description</td><td>Adj. Mechanism Clutch Syst. (left)</td></tr> <tr><td>Application</td><td>LRG702</td></tr> </table>	TT KIT n°	CMSK.5.9	Maker	MERITOR	OR kit n°		Description	Adj. Mechanism Clutch Syst. (left)	Application	LRG702		<table border="1"> <tr><td>TT KIT n°</td><td>CMSK.5.10</td></tr> <tr><td>Maker</td><td>MERITOR</td></tr> <tr><td>OR kit n°</td><td></td></tr> <tr><td>Description</td><td>Adj. Mechanism Clutch Syst. (right)</td></tr> <tr><td>Application</td><td>LRG703</td></tr> </table>	TT KIT n°	CMSK.5.10	Maker	MERITOR	OR kit n°		Description	Adj. Mechanism Clutch Syst. (right)	Application	LRG703
TT KIT n°	CMSK.5.9																						
Maker	MERITOR																						
OR kit n°																							
Description	Adj. Mechanism Clutch Syst. (left)																						
Application	LRG702																						
TT KIT n°	CMSK.5.10																						
Maker	MERITOR																						
OR kit n°																							
Description	Adj. Mechanism Clutch Syst. (right)																						
Application	LRG703																						
	<table border="1"> <tr><td>TT KIT n°</td><td>CMSK.5.11</td></tr> <tr><td>Maker</td><td>MERITOR</td></tr> <tr><td>OR kit n°</td><td></td></tr> <tr><td>Description</td><td>Spring retainers Thrust (left)</td></tr> <tr><td>Application</td><td>LRG702</td></tr> </table>	TT KIT n°	CMSK.5.11	Maker	MERITOR	OR kit n°		Description	Spring retainers Thrust (left)	Application	LRG702		<table border="1"> <tr><td>TT KIT n°</td><td>CMSK.5.12</td></tr> <tr><td>Maker</td><td>MERITOR</td></tr> <tr><td>OR kit n°</td><td></td></tr> <tr><td>Description</td><td>Spring retainers Thrust (right)</td></tr> <tr><td>Application</td><td>LRG703</td></tr> </table>	TT KIT n°	CMSK.5.12	Maker	MERITOR	OR kit n°		Description	Spring retainers Thrust (right)	Application	LRG703
TT KIT n°	CMSK.5.11																						
Maker	MERITOR																						
OR kit n°																							
Description	Spring retainers Thrust (left)																						
Application	LRG702																						
TT KIT n°	CMSK.5.12																						
Maker	MERITOR																						
OR kit n°																							
Description	Spring retainers Thrust (right)																						
Application	LRG703																						
	<table border="1"> <tr><td>TT KIT n°</td><td>CMSK.5.13</td></tr> <tr><td>Maker</td><td>MERITOR</td></tr> <tr><td>OR kit n°</td><td></td></tr> <tr><td>Description</td><td>Seals & Caps</td></tr> <tr><td>Application</td><td>LRG702 LRG703</td></tr> </table>	TT KIT n°	CMSK.5.13	Maker	MERITOR	OR kit n°		Description	Seals & Caps	Application	LRG702 LRG703		<table border="1"> <tr><td>TT KIT n°</td><td>CMSK.5.5</td></tr> <tr><td>Maker</td><td>MERITOR</td></tr> <tr><td>OR kit n°</td><td>ST1156</td></tr> <tr><td>Description</td><td>Tappet Cover</td></tr> <tr><td>Application</td><td>LRG542 /43 /70 /71/90 /91 /632 /633 /642 /643</td></tr> </table>	TT KIT n°	CMSK.5.5	Maker	MERITOR	OR kit n°	ST1156	Description	Tappet Cover	Application	LRG542 /43 /70 /71/90 /91 /632 /633 /642 /643
TT KIT n°	CMSK.5.13																						
Maker	MERITOR																						
OR kit n°																							
Description	Seals & Caps																						
Application	LRG702 LRG703																						
TT KIT n°	CMSK.5.5																						
Maker	MERITOR																						
OR kit n°	ST1156																						
Description	Tappet Cover																						
Application	LRG542 /43 /70 /71/90 /91 /632 /633 /642 /643																						

MERITOR CALIPERS

LRG554 Types

Typical exploded view of most key models are exposed here, to help you to choose correct repair kits.



MERITOR CALIPERS

LRG554 Types

	<table border="1"> <tr><td>TT KIT n°</td><td>CMSK.54</td></tr> <tr><td>Maker</td><td>MERITOR</td></tr> <tr><td>OR kit n°</td><td>SJ4052</td></tr> <tr><td>Description</td><td>Guides & Seals</td></tr> <tr><td>Application</td><td>LRG554</td></tr> </table>	TT KIT n°	CMSK.54	Maker	MERITOR	OR kit n°	SJ4052	Description	Guides & Seals	Application	LRG554		<table border="1"> <tr><td>TT KIT n°</td><td>CMSK.10</td></tr> <tr><td>Maker</td><td>MERITOR</td></tr> <tr><td>OR kit n°</td><td>MCK4113</td></tr> <tr><td>Description</td><td>Adjusting mechanism (left)</td></tr> <tr><td>Application</td><td>LRG554</td></tr> </table>	TT KIT n°	CMSK.10	Maker	MERITOR	OR kit n°	MCK4113	Description	Adjusting mechanism (left)	Application	LRG554
TT KIT n°	CMSK.54																						
Maker	MERITOR																						
OR kit n°	SJ4052																						
Description	Guides & Seals																						
Application	LRG554																						
TT KIT n°	CMSK.10																						
Maker	MERITOR																						
OR kit n°	MCK4113																						
Description	Adjusting mechanism (left)																						
Application	LRG554																						
	<table border="1"> <tr><td>TT KIT n°</td><td>CMSK.10.2</td></tr> <tr><td>Maker</td><td>MERITOR</td></tr> <tr><td>OR kit n°</td><td>MCK4114</td></tr> <tr><td>Description</td><td>Adjusting mechanism(right)</td></tr> <tr><td>Application</td><td>LRG554</td></tr> </table>	TT KIT n°	CMSK.10.2	Maker	MERITOR	OR kit n°	MCK4114	Description	Adjusting mechanism(right)	Application	LRG554		<table border="1"> <tr><td>TT KIT n°</td><td>CMSK.15</td></tr> <tr><td>Maker</td><td>MERITOR</td></tr> <tr><td>OR kit n°</td><td>SJ4073</td></tr> <tr><td>Description</td><td>Adjuster tappet (left)</td></tr> <tr><td>Application</td><td>LRG554</td></tr> </table>	TT KIT n°	CMSK.15	Maker	MERITOR	OR kit n°	SJ4073	Description	Adjuster tappet (left)	Application	LRG554
TT KIT n°	CMSK.10.2																						
Maker	MERITOR																						
OR kit n°	MCK4114																						
Description	Adjusting mechanism(right)																						
Application	LRG554																						
TT KIT n°	CMSK.15																						
Maker	MERITOR																						
OR kit n°	SJ4073																						
Description	Adjuster tappet (left)																						
Application	LRG554																						
	<table border="1"> <tr><td>TT KIT n°</td><td>CMSK.15.1</td></tr> <tr><td>Maker</td><td>MERITOR</td></tr> <tr><td>OR kit n°</td><td>SJ4074</td></tr> <tr><td>Description</td><td>Adjuster tappet (right)</td></tr> <tr><td>Application</td><td>LRG554</td></tr> </table>	TT KIT n°	CMSK.15.1	Maker	MERITOR	OR kit n°	SJ4074	Description	Adjuster tappet (right)	Application	LRG554		<table border="1"> <tr><td>TT KIT n°</td><td>CMSK.11.V</td></tr> <tr><td>Maker</td><td>MERITOR</td></tr> <tr><td>OR kit n°</td><td>MCK1021</td></tr> <tr><td>Description</td><td>Operating shaft (left)</td></tr> <tr><td>Application</td><td>LRG554</td></tr> </table>	TT KIT n°	CMSK.11.V	Maker	MERITOR	OR kit n°	MCK1021	Description	Operating shaft (left)	Application	LRG554
TT KIT n°	CMSK.15.1																						
Maker	MERITOR																						
OR kit n°	SJ4074																						
Description	Adjuster tappet (right)																						
Application	LRG554																						
TT KIT n°	CMSK.11.V																						
Maker	MERITOR																						
OR kit n°	MCK1021																						
Description	Operating shaft (left)																						
Application	LRG554																						
	<table border="1"> <tr><td>TT KIT n°</td><td>CMSK.12.V</td></tr> <tr><td>Maker</td><td>MERITOR</td></tr> <tr><td>OR kit n°</td><td>MCK1022</td></tr> <tr><td>Description</td><td>Operating shaft (right)</td></tr> <tr><td>Application</td><td>LRG554</td></tr> </table>	TT KIT n°	CMSK.12.V	Maker	MERITOR	OR kit n°	MCK1022	Description	Operating shaft (right)	Application	LRG554		<table border="1"> <tr><td>TT KIT n°</td><td>CMSK.14</td></tr> <tr><td>Maker</td><td>MERITOR</td></tr> <tr><td>OR kit n°</td><td>SJ4031</td></tr> <tr><td>Description</td><td>Needle & roller bearings</td></tr> <tr><td>Application</td><td>LRG554</td></tr> </table>	TT KIT n°	CMSK.14	Maker	MERITOR	OR kit n°	SJ4031	Description	Needle & roller bearings	Application	LRG554
TT KIT n°	CMSK.12.V																						
Maker	MERITOR																						
OR kit n°	MCK1022																						
Description	Operating shaft (right)																						
Application	LRG554																						
TT KIT n°	CMSK.14																						
Maker	MERITOR																						
OR kit n°	SJ4031																						
Description	Needle & roller bearings																						
Application	LRG554																						

MORE KITS NEXT PAGE

LRG554 Types

Typical exploded view of most key models are exposed here, to help you to choose correct repair kits.



C LISA TYPE OF MERITOR CALIPERS

LRG554 Types

	<table border="1"> <tr><td>TT KIT n°</td><td>CMSK.11.1</td></tr> <tr><td>Maker</td><td>MERITOR</td></tr> <tr><td>OR kit n°</td><td>-</td></tr> <tr><td>Description</td><td>Shaft</td></tr> <tr><td>Application</td><td>LRG548 /50 /54 /64 /92 /630</td></tr> </table>	TT KIT n°	CMSK.11.1	Maker	MERITOR	OR kit n°	-	Description	Shaft	Application	LRG548 /50 /54 /64 /92 /630		<table border="1"> <tr><td>TT KIT n°</td><td>CMSK.12.1</td></tr> <tr><td>Maker</td><td>MERITOR</td></tr> <tr><td>OR kit n°</td><td>-</td></tr> <tr><td>Description</td><td>Shaft</td></tr> <tr><td>Application</td><td>LRG549 /51 /54 /65 /93 /631</td></tr> </table>	TT KIT n°	CMSK.12.1	Maker	MERITOR	OR kit n°	-	Description	Shaft	Application	LRG549 /51 /54 /65 /93 /631
TT KIT n°	CMSK.11.1																						
Maker	MERITOR																						
OR kit n°	-																						
Description	Shaft																						
Application	LRG548 /50 /54 /64 /92 /630																						
TT KIT n°	CMSK.12.1																						
Maker	MERITOR																						
OR kit n°	-																						
Description	Shaft																						
Application	LRG549 /51 /54 /65 /93 /631																						
	<table border="1"> <tr><td>TT KIT n°</td><td>CMSK.11.2</td></tr> <tr><td>Maker</td><td>MERITOR</td></tr> <tr><td>OR kit n°</td><td>-</td></tr> <tr><td>Description</td><td>Shaft base</td></tr> <tr><td>Application</td><td>LRG548 /50 /54 /64 /92 /630</td></tr> </table>	TT KIT n°	CMSK.11.2	Maker	MERITOR	OR kit n°	-	Description	Shaft base	Application	LRG548 /50 /54 /64 /92 /630		<table border="1"> <tr><td>TT KIT n°</td><td>CMSK.12.2</td></tr> <tr><td>Maker</td><td>MERITOR</td></tr> <tr><td>OR kit n°</td><td>-</td></tr> <tr><td>Description</td><td>Shaft base</td></tr> <tr><td>Application</td><td>LRG549 /51 /54 /65 /93 /631</td></tr> </table>	TT KIT n°	CMSK.12.2	Maker	MERITOR	OR kit n°	-	Description	Shaft base	Application	LRG549 /51 /54 /65 /93 /631
TT KIT n°	CMSK.11.2																						
Maker	MERITOR																						
OR kit n°	-																						
Description	Shaft base																						
Application	LRG548 /50 /54 /64 /92 /630																						
TT KIT n°	CMSK.12.2																						
Maker	MERITOR																						
OR kit n°	-																						
Description	Shaft base																						
Application	LRG549 /51 /54 /65 /93 /631																						
	<table border="1"> <tr><td>TT KIT n°</td><td>CMSK.11.3</td></tr> <tr><td>Maker</td><td>MERITOR</td></tr> <tr><td>OR kit n°</td><td>-</td></tr> <tr><td>Description</td><td>Balls</td></tr> <tr><td>Application</td><td>LRG548 /49</td></tr> </table>	TT KIT n°	CMSK.11.3	Maker	MERITOR	OR kit n°	-	Description	Balls	Application	LRG548 /49		<table border="1"> <tr><td>TT KIT n°</td><td>CMSK.11.4</td></tr> <tr><td>Maker</td><td>MERITOR</td></tr> <tr><td>OR kit n°</td><td>-</td></tr> <tr><td>Description</td><td>Spring</td></tr> <tr><td>Application</td><td>LRG548 /49 /50 /51/54/55/64/65</td></tr> </table>	TT KIT n°	CMSK.11.4	Maker	MERITOR	OR kit n°	-	Description	Spring	Application	LRG548 /49 /50 /51/54/55/64/65
TT KIT n°	CMSK.11.3																						
Maker	MERITOR																						
OR kit n°	-																						
Description	Balls																						
Application	LRG548 /49																						
TT KIT n°	CMSK.11.4																						
Maker	MERITOR																						
OR kit n°	-																						
Description	Spring																						
Application	LRG548 /49 /50 /51/54/55/64/65																						

D LISA TYPE OF MERITOR CALIPERS

LRG548 /49 /50 /51 /64 /65 /92 /93 /630 /631 Types

Typical exploded view of most key models are exposed here, to help you to choose correct repair kits.

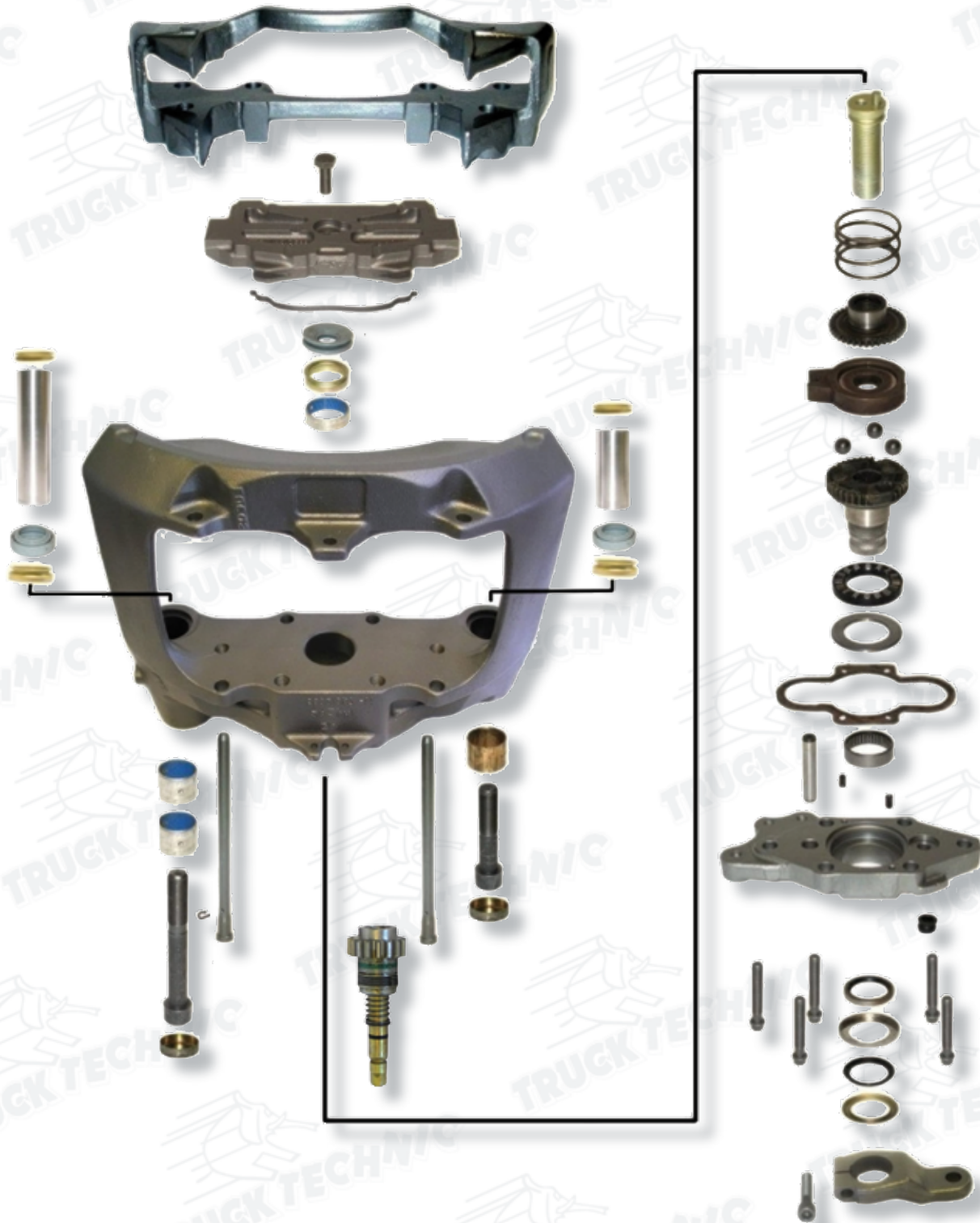

LRG548 /49 /50 /51 /64 /65 /92 /93 /630 /631 Types

	<table border="1"> <tr><td>TT KIT n°</td><td>CMSK.7</td></tr> <tr><td>Maker</td><td>MERITOR</td></tr> <tr><td>OR kit n°</td><td>SJ4078</td></tr> <tr><td>Description</td><td>Boot & seals</td></tr> <tr><td>Application</td><td>LRG548 /49 /50 /51</td></tr> </table>	TT KIT n°	CMSK.7	Maker	MERITOR	OR kit n°	SJ4078	Description	Boot & seals	Application	LRG548 /49 /50 /51		<table border="1"> <tr><td>TT KIT n°</td><td>CMSK.13</td></tr> <tr><td>Maker</td><td>MERITOR</td></tr> <tr><td>OR kit n°</td><td>SJ4076</td></tr> <tr><td>Description</td><td>Guides, pins & sleeves</td></tr> <tr><td>Application</td><td>LRG548 /49 /50 /51 /54 /55</td></tr> </table>	TT KIT n°	CMSK.13	Maker	MERITOR	OR kit n°	SJ4076	Description	Guides, pins & sleeves	Application	LRG548 /49 /50 /51 /54 /55
TT KIT n°	CMSK.7																						
Maker	MERITOR																						
OR kit n°	SJ4078																						
Description	Boot & seals																						
Application	LRG548 /49 /50 /51																						
TT KIT n°	CMSK.13																						
Maker	MERITOR																						
OR kit n°	SJ4076																						
Description	Guides, pins & sleeves																						
Application	LRG548 /49 /50 /51 /54 /55																						
	<table border="1"> <tr><td>TT KIT n°</td><td>CMSK.10</td></tr> <tr><td>Maker</td><td>MERITOR</td></tr> <tr><td>OR kit n°</td><td>MCK4113</td></tr> <tr><td>Description</td><td>Adjusting mechanism (left)</td></tr> <tr><td>Application</td><td>LRG548 /50 /54 /64 /92 /630</td></tr> </table>	TT KIT n°	CMSK.10	Maker	MERITOR	OR kit n°	MCK4113	Description	Adjusting mechanism (left)	Application	LRG548 /50 /54 /64 /92 /630		<table border="1"> <tr><td>TT KIT n°</td><td>CMSK.10.2</td></tr> <tr><td>Maker</td><td>MERITOR</td></tr> <tr><td>OR kit n°</td><td>MCK4114</td></tr> <tr><td>Description</td><td>Adjusting mechanism(right)</td></tr> <tr><td>Application</td><td>LRG549 /51 /54 /65 /93 /631</td></tr> </table>	TT KIT n°	CMSK.10.2	Maker	MERITOR	OR kit n°	MCK4114	Description	Adjusting mechanism(right)	Application	LRG549 /51 /54 /65 /93 /631
TT KIT n°	CMSK.10																						
Maker	MERITOR																						
OR kit n°	MCK4113																						
Description	Adjusting mechanism (left)																						
Application	LRG548 /50 /54 /64 /92 /630																						
TT KIT n°	CMSK.10.2																						
Maker	MERITOR																						
OR kit n°	MCK4114																						
Description	Adjusting mechanism(right)																						
Application	LRG549 /51 /54 /65 /93 /631																						
	<table border="1"> <tr><td>TT KIT n°</td><td>CMSK.15</td></tr> <tr><td>Maker</td><td>MERITOR</td></tr> <tr><td>OR kit n°</td><td>SJ4073</td></tr> <tr><td>Description</td><td>Adjuster tappet (left)</td></tr> <tr><td>Application</td><td>LRG548 /50 /54 /64 /92 /630</td></tr> </table>	TT KIT n°	CMSK.15	Maker	MERITOR	OR kit n°	SJ4073	Description	Adjuster tappet (left)	Application	LRG548 /50 /54 /64 /92 /630		<table border="1"> <tr><td>TT KIT n°</td><td>CMSK.15.1</td></tr> <tr><td>Maker</td><td>MERITOR</td></tr> <tr><td>OR kit n°</td><td>SJ4074</td></tr> <tr><td>Description</td><td>Adjuster tappet (right)</td></tr> <tr><td>Application</td><td>LRG549 /51 /54 /65 /93 /631</td></tr> </table>	TT KIT n°	CMSK.15.1	Maker	MERITOR	OR kit n°	SJ4074	Description	Adjuster tappet (right)	Application	LRG549 /51 /54 /65 /93 /631
TT KIT n°	CMSK.15																						
Maker	MERITOR																						
OR kit n°	SJ4073																						
Description	Adjuster tappet (left)																						
Application	LRG548 /50 /54 /64 /92 /630																						
TT KIT n°	CMSK.15.1																						
Maker	MERITOR																						
OR kit n°	SJ4074																						
Description	Adjuster tappet (right)																						
Application	LRG549 /51 /54 /65 /93 /631																						
	<table border="1"> <tr><td>TT KIT n°</td><td>CMSK.11.V</td></tr> <tr><td>Maker</td><td>MERITOR</td></tr> <tr><td>OR kit n°</td><td>MCK1021</td></tr> <tr><td>Description</td><td>Operating shaft (left)</td></tr> <tr><td>Application</td><td>LRG548 /50 /54 /64 /92 /630</td></tr> </table>	TT KIT n°	CMSK.11.V	Maker	MERITOR	OR kit n°	MCK1021	Description	Operating shaft (left)	Application	LRG548 /50 /54 /64 /92 /630		<table border="1"> <tr><td>TT KIT n°</td><td>CMSK.12.V</td></tr> <tr><td>Maker</td><td>MERITOR</td></tr> <tr><td>OR kit n°</td><td>MCK1022</td></tr> <tr><td>Description</td><td>Operating shaft (right)</td></tr> <tr><td>Application</td><td>LRG549 /51 /54 /65 /93 /631</td></tr> </table>	TT KIT n°	CMSK.12.V	Maker	MERITOR	OR kit n°	MCK1022	Description	Operating shaft (right)	Application	LRG549 /51 /54 /65 /93 /631
TT KIT n°	CMSK.11.V																						
Maker	MERITOR																						
OR kit n°	MCK1021																						
Description	Operating shaft (left)																						
Application	LRG548 /50 /54 /64 /92 /630																						
TT KIT n°	CMSK.12.V																						
Maker	MERITOR																						
OR kit n°	MCK1022																						
Description	Operating shaft (right)																						
Application	LRG549 /51 /54 /65 /93 /631																						
	<table border="1"> <tr><td>TT KIT n°</td><td>CMSK.14</td></tr> <tr><td>Maker</td><td>MERITOR</td></tr> <tr><td>OR kit n°</td><td>SJ4031</td></tr> <tr><td>Description</td><td>Needle & roller bearings</td></tr> <tr><td>Application</td><td>LRG548 /49 /50 /51 /54 /55 /64 /65 /92 /93 /630 /631</td></tr> </table>	TT KIT n°	CMSK.14	Maker	MERITOR	OR kit n°	SJ4031	Description	Needle & roller bearings	Application	LRG548 /49 /50 /51 /54 /55 /64 /65 /92 /93 /630 /631												
TT KIT n°	CMSK.14																						
Maker	MERITOR																						
OR kit n°	SJ4031																						
Description	Needle & roller bearings																						
Application	LRG548 /49 /50 /51 /54 /55 /64 /65 /92 /93 /630 /631																						

MERITOR CALIPER repair kits

MORE KITS NEXT PAGE

Repair kits details

LRG548 /49 /50 /51 /54 /55 /64 /65 /92 /93 /630 /631 Types

	TT KIT n°	CMSK.11.1		TT KIT n°	CMSK.12.1
	Maker	MERITOR		Maker	MERITOR
	OR kit n°	-		OR kit n°	-
	Description	Shaft		Description	Shaft
	Application	LRG548 /50 /54 /64 /92 /630		Application	LRG549 /51 /54 /65 /93 /631
	TT KIT n°	CMSK.11.2		TT KIT n°	CMSK.12.2
	Maker	MERITOR		Maker	MERITOR
	OR kit n°	-		OR kit n°	-
	Description	Shaft base		Description	Shaft base
	Application	LRG548 /50 /54 /64 /92 /630		Application	LRG549 /51 /54 /65 /93 /631
	TT KIT n°	CMSK.11.3		TT KIT n°	CMSK.11.4
	Maker	MERITOR		Maker	MERITOR
	OR kit n°	-		OR kit n°	-
	Description	Balls		Description	Spring
	Application	LRG548 /49		Application	LRG548 /49 /50 /51/54/55/64/65

D LUCO TYPE OF MERITOR CALIPERS







LRG536 /537 /552 /553 /560 /561 /596 /597 /598 /599 /648 /649 Types

Typical exploded view of most key models are exposed here, to help you to choose correct repair kits.



D LUCO TYPE OF MERITOR CALIPERS

LRG536 /537 /552 /553 /560 /561 /596 /597 /598 /599 /648 /649 Types

	<table border="1"> <tr><td>TT KIT n°</td><td>CMSK.3.1</td></tr> <tr><td>Maker</td><td>MERITOR</td></tr> <tr><td>OR kit n°</td><td>MCK1134</td></tr> <tr><td>Description</td><td>Guide Pins</td></tr> <tr><td>Application</td><td>LRG536/537/552 /553/560/561/648 /649</td></tr> </table>	TT KIT n°	CMSK.3.1	Maker	MERITOR	OR kit n°	MCK1134	Description	Guide Pins	Application	LRG536/537/552 /553/560/561/648 /649		<table border="1"> <tr><td>TT KIT n°</td><td>CMSK.3.5</td></tr> <tr><td>Maker</td><td>MERITOR</td></tr> <tr><td>OR kit n°</td><td>MCK1238</td></tr> <tr><td>Description</td><td>Tappet Head</td></tr> <tr><td>Application</td><td>LRG536/537/552 /553/560/561/648 /649</td></tr> </table>	TT KIT n°	CMSK.3.5	Maker	MERITOR	OR kit n°	MCK1238	Description	Tappet Head	Application	LRG536/537/552 /553/560/561/648 /649
TT KIT n°	CMSK.3.1																						
Maker	MERITOR																						
OR kit n°	MCK1134																						
Description	Guide Pins																						
Application	LRG536/537/552 /553/560/561/648 /649																						
TT KIT n°	CMSK.3.5																						
Maker	MERITOR																						
OR kit n°	MCK1238																						
Description	Tappet Head																						
Application	LRG536/537/552 /553/560/561/648 /649																						
	<table border="1"> <tr><td>TT KIT n°</td><td>CMSK.3.4/4.4</td></tr> <tr><td>Maker</td><td>MERITOR</td></tr> <tr><td>OR kit n°</td><td>SJ4096 /97</td></tr> <tr><td>Description</td><td>Operating Shaft (left/right)</td></tr> <tr><td>Application</td><td>LRG536/537/552 /553/560/561/648 /649</td></tr> </table>	TT KIT n°	CMSK.3.4/4.4	Maker	MERITOR	OR kit n°	SJ4096 /97	Description	Operating Shaft (left/right)	Application	LRG536/537/552 /553/560/561/648 /649		<table border="1"> <tr><td>TT KIT n°</td><td>CMSK.3.2/4.2</td></tr> <tr><td>Maker</td><td>MERITOR</td></tr> <tr><td>OR kit n°</td><td>MCK1236 /37</td></tr> <tr><td>Description</td><td>Adjusting Tappet (left/right)</td></tr> <tr><td>Application</td><td>LRG536/537/552/553 /560/561/596/597/648 /649</td></tr> </table>	TT KIT n°	CMSK.3.2/4.2	Maker	MERITOR	OR kit n°	MCK1236 /37	Description	Adjusting Tappet (left/right)	Application	LRG536/537/552/553 /560/561/596/597/648 /649
TT KIT n°	CMSK.3.4/4.4																						
Maker	MERITOR																						
OR kit n°	SJ4096 /97																						
Description	Operating Shaft (left/right)																						
Application	LRG536/537/552 /553/560/561/648 /649																						
TT KIT n°	CMSK.3.2/4.2																						
Maker	MERITOR																						
OR kit n°	MCK1236 /37																						
Description	Adjusting Tappet (left/right)																						
Application	LRG536/537/552/553 /560/561/596/597/648 /649																						
	<table border="1"> <tr><td>TT KIT n°</td><td>CMSK.18</td></tr> <tr><td>Maker</td><td>MERITOR</td></tr> <tr><td>OR kit n°</td><td>68324854PK10</td></tr> <tr><td>Description</td><td>Tappet Dust Cover</td></tr> <tr><td>Application</td><td>LRG536/537/552 /553/560/561/648 /649</td></tr> </table>	TT KIT n°	CMSK.18	Maker	MERITOR	OR kit n°	68324854PK10	Description	Tappet Dust Cover	Application	LRG536/537/552 /553/560/561/648 /649		<table border="1"> <tr><td>TT KIT n°</td><td>CMSK.3.8</td></tr> <tr><td>Maker</td><td>MERITOR</td></tr> <tr><td>OR kit n°</td><td>68322774PK4</td></tr> <tr><td>Description</td><td>Cover Plate Gasket</td></tr> <tr><td>Application</td><td>LRG536/537/552 /553/560/561/648/649</td></tr> </table>	TT KIT n°	CMSK.3.8	Maker	MERITOR	OR kit n°	68322774PK4	Description	Cover Plate Gasket	Application	LRG536/537/552 /553/560/561/648/649
TT KIT n°	CMSK.18																						
Maker	MERITOR																						
OR kit n°	68324854PK10																						
Description	Tappet Dust Cover																						
Application	LRG536/537/552 /553/560/561/648 /649																						
TT KIT n°	CMSK.3.8																						
Maker	MERITOR																						
OR kit n°	68322774PK4																						
Description	Cover Plate Gasket																						
Application	LRG536/537/552 /553/560/561/648/649																						
	<table border="1"> <tr><td>TT KIT n°</td><td>CMSK.3.12</td></tr> <tr><td>Maker</td><td>MERITOR</td></tr> <tr><td>OR kit n°</td><td>MCK1264</td></tr> <tr><td>Description</td><td>Pad Retainer</td></tr> <tr><td>Application</td><td>LRG536/537/552 /553/560/561/648 /649</td></tr> </table>	TT KIT n°	CMSK.3.12	Maker	MERITOR	OR kit n°	MCK1264	Description	Pad Retainer	Application	LRG536/537/552 /553/560/561/648 /649		<table border="1"> <tr><td>TT KIT n°</td><td>CMSK.3.3</td></tr> <tr><td>Maker</td><td>MERITOR</td></tr> <tr><td>OR kit n°</td><td>SJ4112</td></tr> <tr><td>Description</td><td>Bearings</td></tr> <tr><td>Application</td><td>LRG536 /37/52 /53 /60 /61/96 /97/98 /99 LRG648 /49 /52 /53</td></tr> </table>	TT KIT n°	CMSK.3.3	Maker	MERITOR	OR kit n°	SJ4112	Description	Bearings	Application	LRG536 /37/52 /53 /60 /61/96 /97/98 /99 LRG648 /49 /52 /53
TT KIT n°	CMSK.3.12																						
Maker	MERITOR																						
OR kit n°	MCK1264																						
Description	Pad Retainer																						
Application	LRG536/537/552 /553/560/561/648 /649																						
TT KIT n°	CMSK.3.3																						
Maker	MERITOR																						
OR kit n°	SJ4112																						
Description	Bearings																						
Application	LRG536 /37/52 /53 /60 /61/96 /97/98 /99 LRG648 /49 /52 /53																						
	<table border="1"> <tr><td>TT KIT n°</td><td>CMSK.3.13</td></tr> <tr><td>Maker</td><td>MERITOR</td></tr> <tr><td>OR kit n°</td><td>SJ4111</td></tr> <tr><td>Description</td><td>Visual pad Wear assembly</td></tr> <tr><td>Application</td><td>LRG536/537/552 /553/560/561/648 /649</td></tr> </table>	TT KIT n°	CMSK.3.13	Maker	MERITOR	OR kit n°	SJ4111	Description	Visual pad Wear assembly	Application	LRG536/537/552 /553/560/561/648 /649		<table border="1"> <tr><td>TT KIT n°</td><td>CMSK.3.7</td></tr> <tr><td>Maker</td><td>MERITOR</td></tr> <tr><td>OR kit n°</td><td>SJ4105</td></tr> <tr><td>Description</td><td>Cover Plate Seal</td></tr> <tr><td>Application</td><td>LRG536/537/552 /553/560/561/648 /649</td></tr> </table>	TT KIT n°	CMSK.3.7	Maker	MERITOR	OR kit n°	SJ4105	Description	Cover Plate Seal	Application	LRG536/537/552 /553/560/561/648 /649
TT KIT n°	CMSK.3.13																						
Maker	MERITOR																						
OR kit n°	SJ4111																						
Description	Visual pad Wear assembly																						
Application	LRG536/537/552 /553/560/561/648 /649																						
TT KIT n°	CMSK.3.7																						
Maker	MERITOR																						
OR kit n°	SJ4105																						
Description	Cover Plate Seal																						
Application	LRG536/537/552 /553/560/561/648 /649																						
	<table border="1"> <tr><td>TT KIT n°</td><td>CMSK.3.10</td></tr> <tr><td>Maker</td><td>MERITOR</td></tr> <tr><td>OR kit n°</td><td>MCK1067</td></tr> <tr><td>Description</td><td>Intermediate Gear & Spring</td></tr> <tr><td>Application</td><td>LRG536/537/552 /553/560/561/648 /649</td></tr> </table>	TT KIT n°	CMSK.3.10	Maker	MERITOR	OR kit n°	MCK1067	Description	Intermediate Gear & Spring	Application	LRG536/537/552 /553/560/561/648 /649		<table border="1"> <tr><td>TT KIT n°</td><td>CMSK.3.9</td></tr> <tr><td>Maker</td><td>MERITOR</td></tr> <tr><td>OR kit n°</td><td>68322655PK10</td></tr> <tr><td>Description</td><td>Adjuster Stem Dust</td></tr> <tr><td>Application</td><td>LRG536/537/552 /553/560/561/648 /649</td></tr> </table>	TT KIT n°	CMSK.3.9	Maker	MERITOR	OR kit n°	68322655PK10	Description	Adjuster Stem Dust	Application	LRG536/537/552 /553/560/561/648 /649
TT KIT n°	CMSK.3.10																						
Maker	MERITOR																						
OR kit n°	MCK1067																						
Description	Intermediate Gear & Spring																						
Application	LRG536/537/552 /553/560/561/648 /649																						
TT KIT n°	CMSK.3.9																						
Maker	MERITOR																						
OR kit n°	68322655PK10																						
Description	Adjuster Stem Dust																						
Application	LRG536/537/552 /553/560/561/648 /649																						
	<table border="1"> <tr><td>TT KIT n°</td><td>CMSK.3.14</td></tr> <tr><td>Maker</td><td>MERITOR</td></tr> <tr><td>OR kit n°</td><td>MCK1299</td></tr> <tr><td>Description</td><td>Guide Pin Bolt & Dust Cover</td></tr> <tr><td>Application</td><td>LRG536/537/552 /553/560/561/648 /649</td></tr> </table>	TT KIT n°	CMSK.3.14	Maker	MERITOR	OR kit n°	MCK1299	Description	Guide Pin Bolt & Dust Cover	Application	LRG536/537/552 /553/560/561/648 /649		<table border="1"> <tr><td>TT KIT n°</td><td>CMSK.3.11</td></tr> <tr><td>Maker</td><td>MERITOR</td></tr> <tr><td>OR kit n°</td><td>68322900PK10</td></tr> <tr><td>Description</td><td>Tappet Anti Rotation plate</td></tr> <tr><td>Application</td><td>LRG536/537/552 /553/560/561/648 /649</td></tr> </table>	TT KIT n°	CMSK.3.11	Maker	MERITOR	OR kit n°	68322900PK10	Description	Tappet Anti Rotation plate	Application	LRG536/537/552 /553/560/561/648 /649
TT KIT n°	CMSK.3.14																						
Maker	MERITOR																						
OR kit n°	MCK1299																						
Description	Guide Pin Bolt & Dust Cover																						
Application	LRG536/537/552 /553/560/561/648 /649																						
TT KIT n°	CMSK.3.11																						
Maker	MERITOR																						
OR kit n°	68322900PK10																						
Description	Tappet Anti Rotation plate																						
Application	LRG536/537/552 /553/560/561/648 /649																						

MERITOR CALIPER repair kits

Repair kits details

ELSA 1TYPE OF MERITOR CALIPERS

LRG586 /587 /588 /589 Types

	<table border="1"> <tr><td>TT KIT n°</td><td>CMSK.3.3</td></tr> <tr><td>Maker</td><td>MERITOR</td></tr> <tr><td>OR kit n°</td><td>SJ4112</td></tr> <tr><td>Description</td><td>Half bearing</td></tr> <tr><td>Application</td><td>LRG536 /37 /52 /53 /60 /61 /96 /97/98 /99 LRG648 /49 /52 /53</td></tr> </table>	TT KIT n°	CMSK.3.3	Maker	MERITOR	OR kit n°	SJ4112	Description	Half bearing	Application	LRG536 /37 /52 /53 /60 /61 /96 /97/98 /99 LRG648 /49 /52 /53		<table border="1"> <tr><td>TT KIT n°</td><td>CMSK.5</td></tr> <tr><td>Maker</td><td>MERITOR</td></tr> <tr><td>OR kit n°</td><td>MCK1102</td></tr> <tr><td>Description</td><td>Guides & bushes</td></tr> <tr><td>Application</td><td>LRG588 LRG589</td></tr> </table>	TT KIT n°	CMSK.5	Maker	MERITOR	OR kit n°	MCK1102	Description	Guides & bushes	Application	LRG588 LRG589
TT KIT n°	CMSK.3.3																						
Maker	MERITOR																						
OR kit n°	SJ4112																						
Description	Half bearing																						
Application	LRG536 /37 /52 /53 /60 /61 /96 /97/98 /99 LRG648 /49 /52 /53																						
TT KIT n°	CMSK.5																						
Maker	MERITOR																						
OR kit n°	MCK1102																						
Description	Guides & bushes																						
Application	LRG588 LRG589																						
	<table border="1"> <tr><td>TT KIT n°</td><td>CMSK.5.2</td></tr> <tr><td>Maker</td><td>MERITOR</td></tr> <tr><td>OR kit n°</td><td></td></tr> <tr><td>Description</td><td>Small gear mechanism (left)</td></tr> <tr><td>Application</td><td>LRG589</td></tr> </table>	TT KIT n°	CMSK.5.2	Maker	MERITOR	OR kit n°		Description	Small gear mechanism (left)	Application	LRG589		<table border="1"> <tr><td>TT KIT n°</td><td>CMSK.5.3</td></tr> <tr><td>Maker</td><td>MERITOR</td></tr> <tr><td>OR kit n°</td><td></td></tr> <tr><td>Description</td><td>Small gear mechanism (right)</td></tr> <tr><td>Application</td><td>LRG588</td></tr> </table>	TT KIT n°	CMSK.5.3	Maker	MERITOR	OR kit n°		Description	Small gear mechanism (right)	Application	LRG588
TT KIT n°	CMSK.5.2																						
Maker	MERITOR																						
OR kit n°																							
Description	Small gear mechanism (left)																						
Application	LRG589																						
TT KIT n°	CMSK.5.3																						
Maker	MERITOR																						
OR kit n°																							
Description	Small gear mechanism (right)																						
Application	LRG588																						
	<table border="1"> <tr><td>TT KIT n°</td><td>CMSK.5.4</td></tr> <tr><td>Maker</td><td>MERITOR</td></tr> <tr><td>OR kit n°</td><td>68321678PK10</td></tr> <tr><td>Description</td><td>Locking shim</td></tr> <tr><td>Application</td><td>LRG588 LRG589</td></tr> </table>	TT KIT n°	CMSK.5.4	Maker	MERITOR	OR kit n°	68321678PK10	Description	Locking shim	Application	LRG588 LRG589												
TT KIT n°	CMSK.5.4																						
Maker	MERITOR																						
OR kit n°	68321678PK10																						
Description	Locking shim																						
Application	LRG588 LRG589																						

MERITOR CALIPER repair kits

Repair kits details

LM ELSA TYPE OF MERITOR CALIPERS

LRG702 /703 Types

Typical exploded view of most key models are exposed here, to help you to choose correct repair kits.



LM ELSA TYPE OF MERITOR CALIPERS

LRG702 /703 Types















	<table border="1"> <tr> <td>TT KIT n°</td> <td>CMSK.7.1</td> </tr> <tr> <td>Maker</td> <td>MERITOR</td> </tr> <tr> <td>OR kit n°</td> <td>MCK.1254</td> </tr> <tr> <td>Description</td> <td>Guide pin seals & screws</td> </tr> <tr> <td>Application</td> <td>LRG702/03</td> </tr> </table>	TT KIT n°	CMSK.7.1	Maker	MERITOR	OR kit n°	MCK.1254	Description	Guide pin seals & screws	Application	LRG702/03		<table border="1"> <tr> <td>TT KIT n°</td> <td>CMSK.7.6</td> </tr> <tr> <td>Maker</td> <td>MERITOR</td> </tr> <tr> <td>OR kit n°</td> <td></td> </tr> <tr> <td>Description</td> <td>Tappets System</td> </tr> <tr> <td>Application</td> <td>LRG702/03</td> </tr> </table>	TT KIT n°	CMSK.7.6	Maker	MERITOR	OR kit n°		Description	Tappets System	Application	LRG702/03
TT KIT n°	CMSK.7.1																						
Maker	MERITOR																						
OR kit n°	MCK.1254																						
Description	Guide pin seals & screws																						
Application	LRG702/03																						
TT KIT n°	CMSK.7.6																						
Maker	MERITOR																						
OR kit n°																							
Description	Tappets System																						
Application	LRG702/03																						
	<table border="1"> <tr> <td>TT KIT n°</td> <td>CMSK.7.7</td> </tr> <tr> <td>Maker</td> <td>MERITOR</td> </tr> <tr> <td>OR kit n°</td> <td></td> </tr> <tr> <td>Description</td> <td>Tappets</td> </tr> <tr> <td>Application</td> <td>LRG702/03</td> </tr> </table>	TT KIT n°	CMSK.7.7	Maker	MERITOR	OR kit n°		Description	Tappets	Application	LRG702/03		<table border="1"> <tr> <td>TT KIT n°</td> <td>CMSK.3.3</td> </tr> <tr> <td>Maker</td> <td>MERITOR</td> </tr> <tr> <td>OR kit n°</td> <td>SJ4112</td> </tr> <tr> <td>Description</td> <td>Bearings</td> </tr> <tr> <td>Application</td> <td>LRG536/37/52/53/53/96/97/98/99 LRG648/49/52/53 LRG702/03</td> </tr> </table>	TT KIT n°	CMSK.3.3	Maker	MERITOR	OR kit n°	SJ4112	Description	Bearings	Application	LRG536/37/52/53/53/96/97/98/99 LRG648/49/52/53 LRG702/03
TT KIT n°	CMSK.7.7																						
Maker	MERITOR																						
OR kit n°																							
Description	Tappets																						
Application	LRG702/03																						
TT KIT n°	CMSK.3.3																						
Maker	MERITOR																						
OR kit n°	SJ4112																						
Description	Bearings																						
Application	LRG536/37/52/53/53/96/97/98/99 LRG648/49/52/53 LRG702/03																						
	<table border="1"> <tr> <td>TT KIT n°</td> <td>CMSK.7.9</td> </tr> <tr> <td>Maker</td> <td>MERITOR</td> </tr> <tr> <td>OR kit n°</td> <td></td> </tr> <tr> <td>Description</td> <td>Adj. mechanism (central part)</td> </tr> <tr> <td>Application</td> <td>LRG702/03</td> </tr> </table>	TT KIT n°	CMSK.7.9	Maker	MERITOR	OR kit n°		Description	Adj. mechanism (central part)	Application	LRG702/03		<table border="1"> <tr> <td>TT KIT n°</td> <td>CMSK.7.4</td> </tr> <tr> <td>Maker</td> <td>MERITOR</td> </tr> <tr> <td>OR kit n°</td> <td></td> </tr> <tr> <td>Description</td> <td>Adjusting mechanism sealing</td> </tr> <tr> <td>Application</td> <td>LRG702/03</td> </tr> </table>	TT KIT n°	CMSK.7.4	Maker	MERITOR	OR kit n°		Description	Adjusting mechanism sealing	Application	LRG702/03
TT KIT n°	CMSK.7.9																						
Maker	MERITOR																						
OR kit n°																							
Description	Adj. mechanism (central part)																						
Application	LRG702/03																						
TT KIT n°	CMSK.7.4																						
Maker	MERITOR																						
OR kit n°																							
Description	Adjusting mechanism sealing																						
Application	LRG702/03																						
	<table border="1"> <tr> <td>TT KIT n°</td> <td>CMSK.7.11.1/2</td> </tr> <tr> <td>Maker</td> <td>MERITOR</td> </tr> <tr> <td>OR kit n°</td> <td></td> </tr> <tr> <td>Description</td> <td>Adjusting device LEFT / RIGHT</td> </tr> <tr> <td>Application</td> <td>LRG702/03</td> </tr> </table>	TT KIT n°	CMSK.7.11.1/2	Maker	MERITOR	OR kit n°		Description	Adjusting device LEFT / RIGHT	Application	LRG702/03		<table border="1"> <tr> <td>TT KIT n°</td> <td>CMSK.18</td> </tr> <tr> <td>Maker</td> <td>MERITOR</td> </tr> <tr> <td>OR kit n°</td> <td>MCK.1139</td> </tr> <tr> <td>Description</td> <td>Adjuster Tap Kit</td> </tr> <tr> <td>Application</td> <td>LRG536/37/52/53/60/61/96/97/98/99 LRG648/49/52/53 LRG702/03</td> </tr> </table>	TT KIT n°	CMSK.18	Maker	MERITOR	OR kit n°	MCK.1139	Description	Adjuster Tap Kit	Application	LRG536/37/52/53/60/61/96/97/98/99 LRG648/49/52/53 LRG702/03
TT KIT n°	CMSK.7.11.1/2																						
Maker	MERITOR																						
OR kit n°																							
Description	Adjusting device LEFT / RIGHT																						
Application	LRG702/03																						
TT KIT n°	CMSK.18																						
Maker	MERITOR																						
OR kit n°	MCK.1139																						
Description	Adjuster Tap Kit																						
Application	LRG536/37/52/53/60/61/96/97/98/99 LRG648/49/52/53 LRG702/03																						
	<table border="1"> <tr> <td>TT KIT n°</td> <td>CMSK.3.12</td> </tr> <tr> <td>Maker</td> <td>MERITOR</td> </tr> <tr> <td>OR kit n°</td> <td>MCK.1264</td> </tr> <tr> <td>Description</td> <td>Pad retainer</td> </tr> <tr> <td>Application</td> <td>LRG536/37/52/53/60/61/96/97/98/99 LRG648/49/52/53 LRG702/03</td> </tr> </table>	TT KIT n°	CMSK.3.12	Maker	MERITOR	OR kit n°	MCK.1264	Description	Pad retainer	Application	LRG536/37/52/53/60/61/96/97/98/99 LRG648/49/52/53 LRG702/03		<table border="1"> <tr> <td>TT KIT n°</td> <td>CMSK.7.2</td> </tr> <tr> <td>Maker</td> <td>MERITOR</td> </tr> <tr> <td>OR kit n°</td> <td>68323746PK10</td> </tr> <tr> <td>Description</td> <td>Actuator Seal</td> </tr> <tr> <td>Application</td> <td>LRG572/73 LRG703/03</td> </tr> </table>	TT KIT n°	CMSK.7.2	Maker	MERITOR	OR kit n°	68323746PK10	Description	Actuator Seal	Application	LRG572/73 LRG703/03
TT KIT n°	CMSK.3.12																						
Maker	MERITOR																						
OR kit n°	MCK.1264																						
Description	Pad retainer																						
Application	LRG536/37/52/53/60/61/96/97/98/99 LRG648/49/52/53 LRG702/03																						
TT KIT n°	CMSK.7.2																						
Maker	MERITOR																						
OR kit n°	68323746PK10																						
Description	Actuator Seal																						
Application	LRG572/73 LRG703/03																						
	<table border="1"> <tr> <td>TT KIT n°</td> <td>CMSK.3.9</td> </tr> <tr> <td>Maker</td> <td>MERITOR</td> </tr> <tr> <td>OR kit n°</td> <td>68322655PK10</td> </tr> <tr> <td>Description</td> <td>Adjstuter Stem Dust</td> </tr> <tr> <td>Application</td> <td>LRG536/37/52/53/60/61/96/97/98/99 LRG648/49/52/53 LRG702/03</td> </tr> </table>	TT KIT n°	CMSK.3.9	Maker	MERITOR	OR kit n°	68322655PK10	Description	Adjstuter Stem Dust	Application	LRG536/37/52/53/60/61/96/97/98/99 LRG648/49/52/53 LRG702/03												
TT KIT n°	CMSK.3.9																						
Maker	MERITOR																						
OR kit n°	68322655PK10																						
Description	Adjstuter Stem Dust																						
Application	LRG536/37/52/53/60/61/96/97/98/99 LRG648/49/52/53 LRG702/03																						

MERITOR CALIPER repair kits

Repair kits details

WABCO CALIPERS

17.5" Types

	<table border="1"> <tr><td>TT KIT n°</td><td>CWSK.2</td></tr> <tr><td>Maker</td><td>WABCO</td></tr> <tr><td>OR kit n°</td><td>12 999 699</td></tr> <tr><td>Description</td><td>Guide & seals</td></tr> <tr><td>Application</td><td>40 175 058 /59 /60 /61 /70 /71 /72 /73</td></tr> </table>	TT KIT n°	CWSK.2	Maker	WABCO	OR kit n°	12 999 699	Description	Guide & seals	Application	40 175 058 /59 /60 /61 /70 /71 /72 /73		<table border="1"> <tr><td>TT KIT n°</td><td>CWSK.7</td></tr> <tr><td>Maker</td><td>WABCO</td></tr> <tr><td>OR kit n°</td><td>12 999 704</td></tr> <tr><td>Description</td><td>Seals & boots</td></tr> <tr><td>Application</td><td>40 175 062 /063 /064 /065</td></tr> </table>	TT KIT n°	CWSK.7	Maker	WABCO	OR kit n°	12 999 704	Description	Seals & boots	Application	40 175 062 /063 /064 /065
TT KIT n°	CWSK.2																						
Maker	WABCO																						
OR kit n°	12 999 699																						
Description	Guide & seals																						
Application	40 175 058 /59 /60 /61 /70 /71 /72 /73																						
TT KIT n°	CWSK.7																						
Maker	WABCO																						
OR kit n°	12 999 704																						
Description	Seals & boots																						
Application	40 175 062 /063 /064 /065																						
	<table border="1"> <tr><td>TT KIT n°</td><td>CWSK.8</td></tr> <tr><td>Maker</td><td>WABCO</td></tr> <tr><td>OR kit n°</td><td>12 999 580</td></tr> <tr><td>Description</td><td>Seals & boots</td></tr> <tr><td>Application</td><td>40 175 025 /26 /27 /28 /49 /50 /51 /52</td></tr> </table>	TT KIT n°	CWSK.8	Maker	WABCO	OR kit n°	12 999 580	Description	Seals & boots	Application	40 175 025 /26 /27 /28 /49 /50 /51 /52		<table border="1"> <tr><td>TT KIT n°</td><td>CWSK.3</td></tr> <tr><td>Maker</td><td>WABCO</td></tr> <tr><td>OR kit n°</td><td>12 999 729</td></tr> <tr><td>Description</td><td>Guide & seals</td></tr> <tr><td>Application</td><td>40 100 001 /02 /03 /04 /05 /06</td></tr> </table>	TT KIT n°	CWSK.3	Maker	WABCO	OR kit n°	12 999 729	Description	Guide & seals	Application	40 100 001 /02 /03 /04 /05 /06
TT KIT n°	CWSK.8																						
Maker	WABCO																						
OR kit n°	12 999 580																						
Description	Seals & boots																						
Application	40 175 025 /26 /27 /28 /49 /50 /51 /52																						
TT KIT n°	CWSK.3																						
Maker	WABCO																						
OR kit n°	12 999 729																						
Description	Guide & seals																						
Application	40 100 001 /02 /03 /04 /05 /06																						
	<table border="1"> <tr><td>TT KIT n°</td><td>CWSK.11</td></tr> <tr><td>Maker</td><td>WABCO</td></tr> <tr><td>OR kit n°</td><td>844 503 503 2</td></tr> <tr><td>Description</td><td>Boot & caps</td></tr> <tr><td>Application</td><td>640 175 074 /075 /076 /077</td></tr> </table>	TT KIT n°	CWSK.11	Maker	WABCO	OR kit n°	844 503 503 2	Description	Boot & caps	Application	640 175 074 /075 /076 /077		<table border="1"> <tr><td>TT KIT n°</td><td>CWSK.10</td></tr> <tr><td>Maker</td><td>WABCO</td></tr> <tr><td>OR kit n°</td><td>844 503 024 2</td></tr> <tr><td>Description</td><td>Guide, seals & boots</td></tr> <tr><td>Application</td><td>640 175 074 /075 /076 /077</td></tr> </table>	TT KIT n°	CWSK.10	Maker	WABCO	OR kit n°	844 503 024 2	Description	Guide, seals & boots	Application	640 175 074 /075 /076 /077
TT KIT n°	CWSK.11																						
Maker	WABCO																						
OR kit n°	844 503 503 2																						
Description	Boot & caps																						
Application	640 175 074 /075 /076 /077																						
TT KIT n°	CWSK.10																						
Maker	WABCO																						
OR kit n°	844 503 024 2																						
Description	Guide, seals & boots																						
Application	640 175 074 /075 /076 /077																						
	<table border="1"> <tr><td>TT KIT n°</td><td>CWSK.17.1</td></tr> <tr><td>Maker</td><td>WABCO</td></tr> <tr><td>OR kit n°</td><td>-</td></tr> <tr><td>Description</td><td>Boots & seals</td></tr> <tr><td>Application</td><td>40 175 051 /052 /40 175 070 /071</td></tr> </table>	TT KIT n°	CWSK.17.1	Maker	WABCO	OR kit n°	-	Description	Boots & seals	Application	40 175 051 /052 /40 175 070 /071		<table border="1"> <tr><td>TT KIT n°</td><td>CWSK.17.2</td></tr> <tr><td>Maker</td><td>WABCO</td></tr> <tr><td>OR kit n°</td><td>-</td></tr> <tr><td>Description</td><td>Guides & screws</td></tr> <tr><td>Application</td><td>40 175 051 /052 /40 175 070 /071</td></tr> </table>	TT KIT n°	CWSK.17.2	Maker	WABCO	OR kit n°	-	Description	Guides & screws	Application	40 175 051 /052 /40 175 070 /071
TT KIT n°	CWSK.17.1																						
Maker	WABCO																						
OR kit n°	-																						
Description	Boots & seals																						
Application	40 175 051 /052 /40 175 070 /071																						
TT KIT n°	CWSK.17.2																						
Maker	WABCO																						
OR kit n°	-																						
Description	Guides & screws																						
Application	40 175 051 /052 /40 175 070 /071																						
	<table border="1"> <tr><td>TT KIT n°</td><td>CWSK.17.3</td></tr> <tr><td>Maker</td><td>WABCO</td></tr> <tr><td>OR kit n°</td><td>-</td></tr> <tr><td>Description</td><td>Push Plate (left)</td></tr> <tr><td>Application</td><td>40 175 051 /40 175 070</td></tr> </table>	TT KIT n°	CWSK.17.3	Maker	WABCO	OR kit n°	-	Description	Push Plate (left)	Application	40 175 051 /40 175 070		<table border="1"> <tr><td>TT KIT n°</td><td>CWSK.17.5</td></tr> <tr><td>Maker</td><td>WABCO</td></tr> <tr><td>OR kit n°</td><td>-</td></tr> <tr><td>Description</td><td>Push Plate (right)</td></tr> <tr><td>Application</td><td>40 175 052 /40 175 071</td></tr> </table>	TT KIT n°	CWSK.17.5	Maker	WABCO	OR kit n°	-	Description	Push Plate (right)	Application	40 175 052 /40 175 071
TT KIT n°	CWSK.17.3																						
Maker	WABCO																						
OR kit n°	-																						
Description	Push Plate (left)																						
Application	40 175 051 /40 175 070																						
TT KIT n°	CWSK.17.5																						
Maker	WABCO																						
OR kit n°	-																						
Description	Push Plate (right)																						
Application	40 175 052 /40 175 071																						
	<table border="1"> <tr><td>TT KIT n°</td><td>CWSK.12.4</td></tr> <tr><td>Maker</td><td>WABCO</td></tr> <tr><td>OR kit n°</td><td>-</td></tr> <tr><td>Description</td><td>Joint & seals</td></tr> <tr><td>Application</td><td>40 160... /40 175... / 195...</td></tr> </table>	TT KIT n°	CWSK.12.4	Maker	WABCO	OR kit n°	-	Description	Joint & seals	Application	40 160... /40 175... / 195...		<table border="1"> <tr><td>TT KIT n°</td><td>CWSK.12</td></tr> <tr><td>Maker</td><td>WABCO</td></tr> <tr><td>OR kit n°</td><td>-</td></tr> <tr><td>Description</td><td>Half bearings</td></tr> <tr><td>Application</td><td>40 160... /40 175... / 195...</td></tr> </table>	TT KIT n°	CWSK.12	Maker	WABCO	OR kit n°	-	Description	Half bearings	Application	40 160... /40 175... / 195...
TT KIT n°	CWSK.12.4																						
Maker	WABCO																						
OR kit n°	-																						
Description	Joint & seals																						
Application	40 160... /40 175... / 195...																						
TT KIT n°	CWSK.12																						
Maker	WABCO																						
OR kit n°	-																						
Description	Half bearings																						
Application	40 160... /40 175... / 195...																						
	<table border="1"> <tr><td>TT KIT n°</td><td>CWSK.12.3</td></tr> <tr><td>Maker</td><td>WABCO</td></tr> <tr><td>OR kit n°</td><td>-</td></tr> <tr><td>Description</td><td>Lever & pin</td></tr> <tr><td>Application</td><td>40 160... /40 175... / 195...</td></tr> </table>	TT KIT n°	CWSK.12.3	Maker	WABCO	OR kit n°	-	Description	Lever & pin	Application	40 160... /40 175... / 195...		<table border="1"> <tr><td>TT KIT n°</td><td>CWSK.12.1</td></tr> <tr><td>Maker</td><td>WABCO</td></tr> <tr><td>OR kit n°</td><td>-</td></tr> <tr><td>Description</td><td>Adjusting mechanism</td></tr> <tr><td>Application</td><td>-</td></tr> </table>	TT KIT n°	CWSK.12.1	Maker	WABCO	OR kit n°	-	Description	Adjusting mechanism	Application	-
TT KIT n°	CWSK.12.3																						
Maker	WABCO																						
OR kit n°	-																						
Description	Lever & pin																						
Application	40 160... /40 175... / 195...																						
TT KIT n°	CWSK.12.1																						
Maker	WABCO																						
OR kit n°	-																						
Description	Adjusting mechanism																						
Application	-																						

WABCO CALIPER repair kits

Repair kits details

WABCO CALIPERS





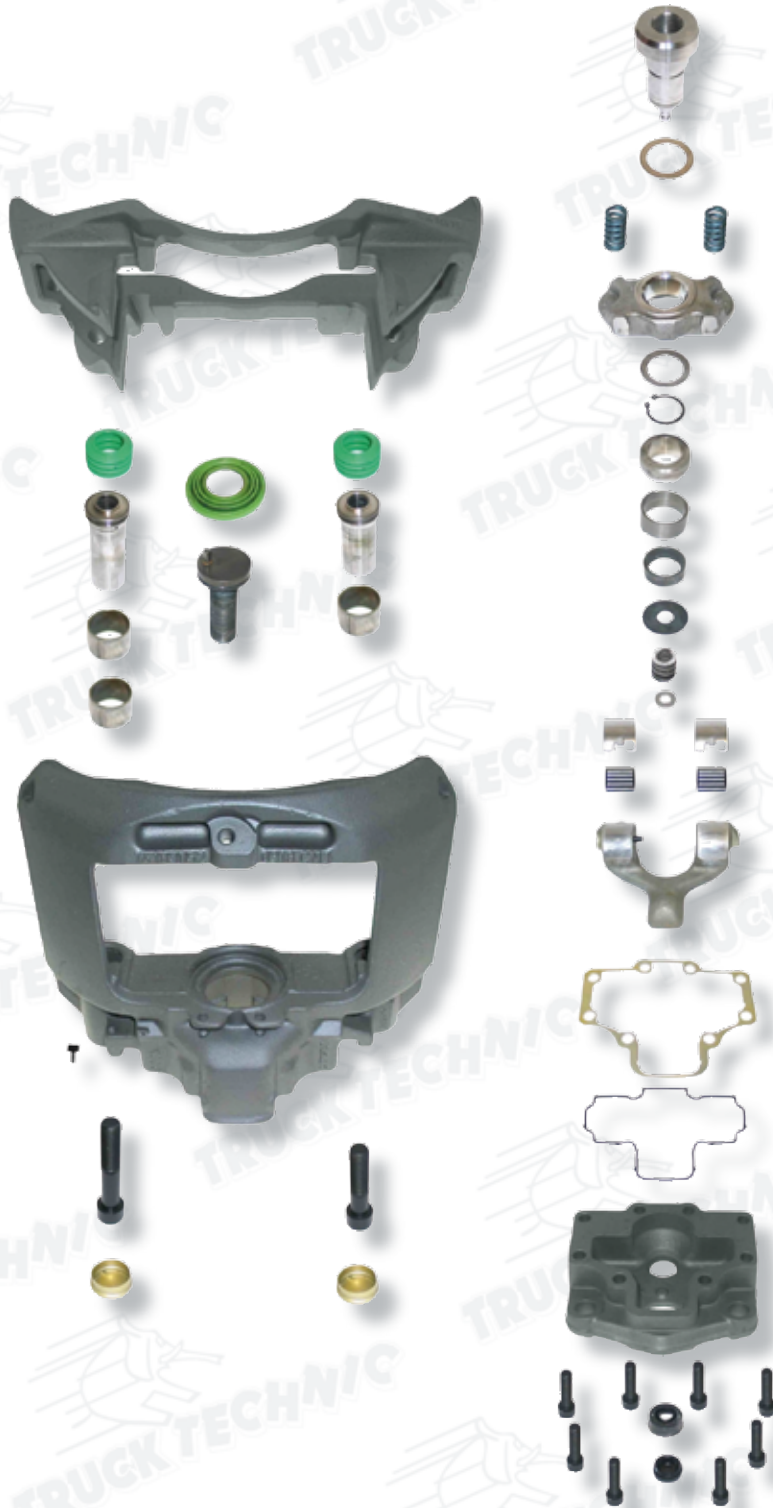



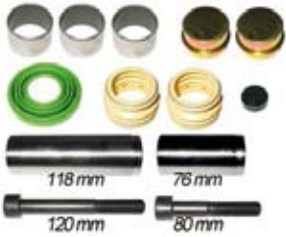

19.5" Types

Typical exploded view of most key models are exposed here, to help you to choose correct repair kits.



WABCO CALIPERS

19.5" Types

	<table border="1"> <tr><td>TT KIT n°</td><td>CWSK.4</td></tr> <tr><td>Maker</td><td>WABCO</td></tr> <tr><td>OR kit n°</td><td>12 999 738</td></tr> <tr><td>Description</td><td>Guides & seals</td></tr> <tr><td>Application</td><td>40 195 001/002 40 195 003 /004</td></tr> </table>	TT KIT n°	CWSK.4	Maker	WABCO	OR kit n°	12 999 738	Description	Guides & seals	Application	40 195 001/002 40 195 003 /004		<table border="1"> <tr><td>TT KIT n°</td><td>CWSK.5</td></tr> <tr><td>Maker</td><td>WABCO</td></tr> <tr><td>OR kit n°</td><td>12 999 746</td></tr> <tr><td>Description</td><td>Guides & seals</td></tr> <tr><td>Application</td><td>40 195 007/008/009 40 195 010/011</td></tr> </table>	TT KIT n°	CWSK.5	Maker	WABCO	OR kit n°	12 999 746	Description	Guides & seals	Application	40 195 007/008/009 40 195 010/011
TT KIT n°	CWSK.4																						
Maker	WABCO																						
OR kit n°	12 999 738																						
Description	Guides & seals																						
Application	40 195 001/002 40 195 003 /004																						
TT KIT n°	CWSK.5																						
Maker	WABCO																						
OR kit n°	12 999 746																						
Description	Guides & seals																						
Application	40 195 007/008/009 40 195 010/011																						
	<table border="1"> <tr><td>TT KIT n°</td><td>CWSK.6</td></tr> <tr><td>Maker</td><td>WABCO</td></tr> <tr><td>OR kit n°</td><td>12 999 776</td></tr> <tr><td>Description</td><td>Guides & seals</td></tr> <tr><td>Application</td><td>40 195 017/018 40 195 037/038/043</td></tr> </table>	TT KIT n°	CWSK.6	Maker	WABCO	OR kit n°	12 999 776	Description	Guides & seals	Application	40 195 017/018 40 195 037/038/043		<table border="1"> <tr><td>TT KIT n°</td><td>CWSK.19.1</td></tr> <tr><td>Maker</td><td>WABCO</td></tr> <tr><td>OR kit n°</td><td>-</td></tr> <tr><td>Description</td><td>Boots, seals & caps</td></tr> <tr><td>Application</td><td>40 195 ...</td></tr> </table>	TT KIT n°	CWSK.19.1	Maker	WABCO	OR kit n°	-	Description	Boots, seals & caps	Application	40 195 ...
TT KIT n°	CWSK.6																						
Maker	WABCO																						
OR kit n°	12 999 776																						
Description	Guides & seals																						
Application	40 195 017/018 40 195 037/038/043																						
TT KIT n°	CWSK.19.1																						
Maker	WABCO																						
OR kit n°	-																						
Description	Boots, seals & caps																						
Application	40 195 ...																						
	<table border="1"> <tr><td>TT KIT n°</td><td>CWSK.19.2</td></tr> <tr><td>Maker</td><td>WABCO</td></tr> <tr><td>OR kit n°</td><td>-</td></tr> <tr><td>Description</td><td>Guides & screws</td></tr> <tr><td>Application</td><td>40 195 ...</td></tr> </table>	TT KIT n°	CWSK.19.2	Maker	WABCO	OR kit n°	-	Description	Guides & screws	Application	40 195 ...		<table border="1"> <tr><td>TT KIT n°</td><td>CWSK.12.1</td></tr> <tr><td>Maker</td><td>WABCO</td></tr> <tr><td>OR kit n°</td><td>-</td></tr> <tr><td>Description</td><td>Adjusting mechanism</td></tr> <tr><td>Application</td><td>-</td></tr> </table>	TT KIT n°	CWSK.12.1	Maker	WABCO	OR kit n°	-	Description	Adjusting mechanism	Application	-
TT KIT n°	CWSK.19.2																						
Maker	WABCO																						
OR kit n°	-																						
Description	Guides & screws																						
Application	40 195 ...																						
TT KIT n°	CWSK.12.1																						
Maker	WABCO																						
OR kit n°	-																						
Description	Adjusting mechanism																						
Application	-																						
	<table border="1"> <tr><td>TT KIT n°</td><td>CWSK.19.3</td></tr> <tr><td>Maker</td><td>WABCO</td></tr> <tr><td>OR kit n°</td><td>-</td></tr> <tr><td>Description</td><td>Push plate (left)</td></tr> <tr><td>Application</td><td>40 195 001 40 195 017</td></tr> </table>	TT KIT n°	CWSK.19.3	Maker	WABCO	OR kit n°	-	Description	Push plate (left)	Application	40 195 001 40 195 017		<table border="1"> <tr><td>TT KIT n°</td><td>CWSK.19.5</td></tr> <tr><td>Maker</td><td>WABCO</td></tr> <tr><td>OR kit n°</td><td>-</td></tr> <tr><td>Description</td><td>Push plate (right)</td></tr> <tr><td>Application</td><td>40 195 002 40 195 018</td></tr> </table>	TT KIT n°	CWSK.19.5	Maker	WABCO	OR kit n°	-	Description	Push plate (right)	Application	40 195 002 40 195 018
TT KIT n°	CWSK.19.3																						
Maker	WABCO																						
OR kit n°	-																						
Description	Push plate (left)																						
Application	40 195 001 40 195 017																						
TT KIT n°	CWSK.19.5																						
Maker	WABCO																						
OR kit n°	-																						
Description	Push plate (right)																						
Application	40 195 002 40 195 018																						
	<table border="1"> <tr><td>TT KIT n°</td><td>CWSK.12</td></tr> <tr><td>Maker</td><td>WABCO</td></tr> <tr><td>OR kit n°</td><td>-</td></tr> <tr><td>Description</td><td>Half bearings</td></tr> <tr><td>Application</td><td>40 195 ...</td></tr> </table>	TT KIT n°	CWSK.12	Maker	WABCO	OR kit n°	-	Description	Half bearings	Application	40 195 ...		<table border="1"> <tr><td>TT KIT n°</td><td>CWSK.12.3</td></tr> <tr><td>Maker</td><td>WABCO</td></tr> <tr><td>OR kit n°</td><td>-</td></tr> <tr><td>Description</td><td>Lever & pin</td></tr> <tr><td>Application</td><td>40 195 ...</td></tr> </table>	TT KIT n°	CWSK.12.3	Maker	WABCO	OR kit n°	-	Description	Lever & pin	Application	40 195 ...
TT KIT n°	CWSK.12																						
Maker	WABCO																						
OR kit n°	-																						
Description	Half bearings																						
Application	40 195 ...																						
TT KIT n°	CWSK.12.3																						
Maker	WABCO																						
OR kit n°	-																						
Description	Lever & pin																						
Application	40 195 ...																						
	<table border="1"> <tr><td>TT KIT n°</td><td>CWSK.12.4</td></tr> <tr><td>Maker</td><td>WABCO</td></tr> <tr><td>OR kit n°</td><td>-</td></tr> <tr><td>Description</td><td>Joint & seals</td></tr> <tr><td>Application</td><td>40 195 ...</td></tr> </table>	TT KIT n°	CWSK.12.4	Maker	WABCO	OR kit n°	-	Description	Joint & seals	Application	40 195 ...												
TT KIT n°	CWSK.12.4																						
Maker	WABCO																						
OR kit n°	-																						
Description	Joint & seals																						
Application	40 195 ...																						

WABCO CALIPERS

22.5" Type

Typical exploded view of most key models are exposed here, to help you to choose correct repair kits.

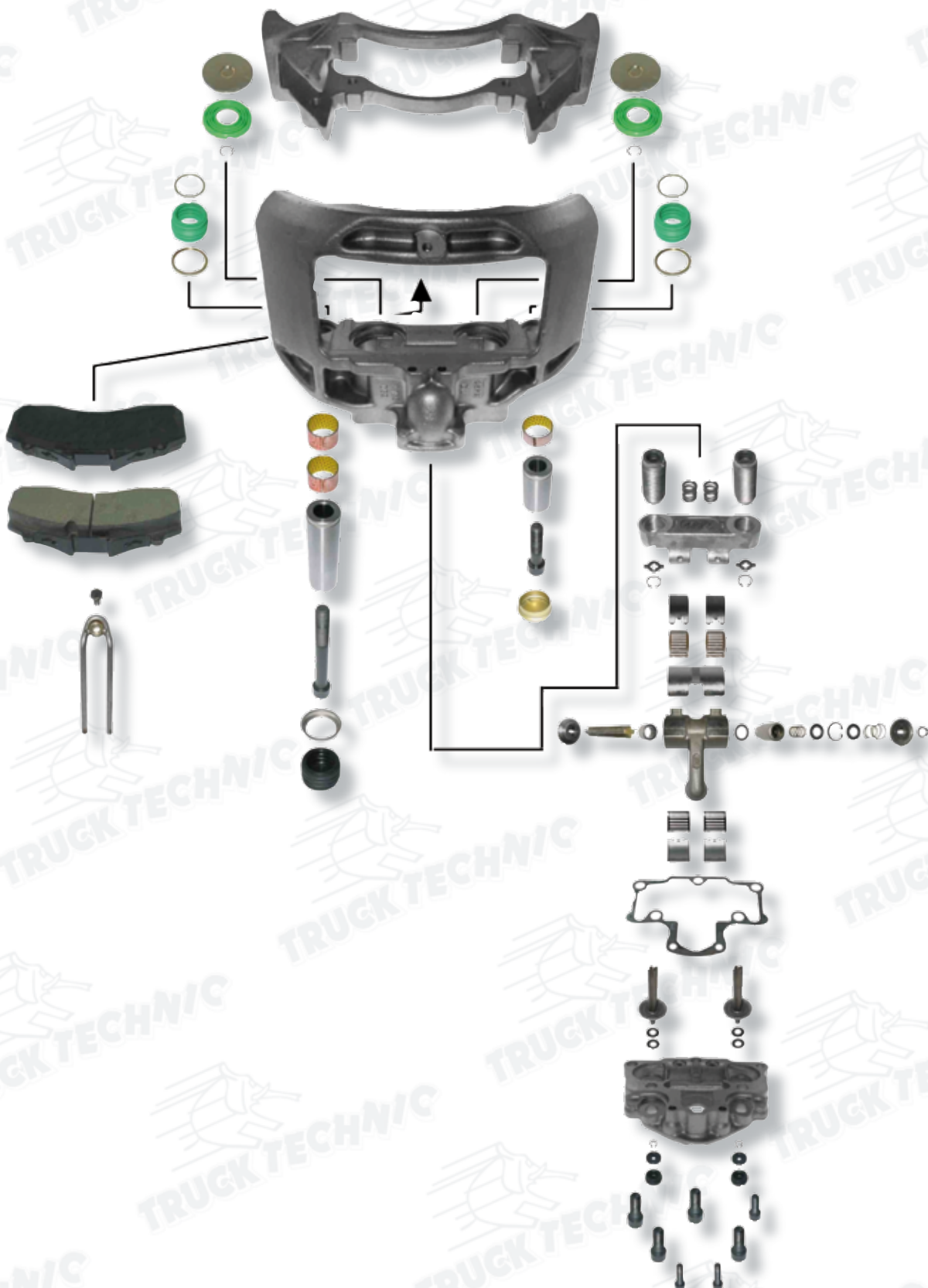

WABCO CALIPERS

22.5" Type

	TT KIT ref.	CWSK.1		TT KIT ref.	CWSK.9
	OR Kit n°	12 999 678		OR Kit n°	12 999 677
	Description	Guide & seals		Description	Seal & boot
	Application	40 225 003 40 225 004		Application	40 225 003 40 225 004

HALDEX CALIPERS

MARK II Types

Typical exploded view of most key models are exposed here, to help you to choose correct repair kits.

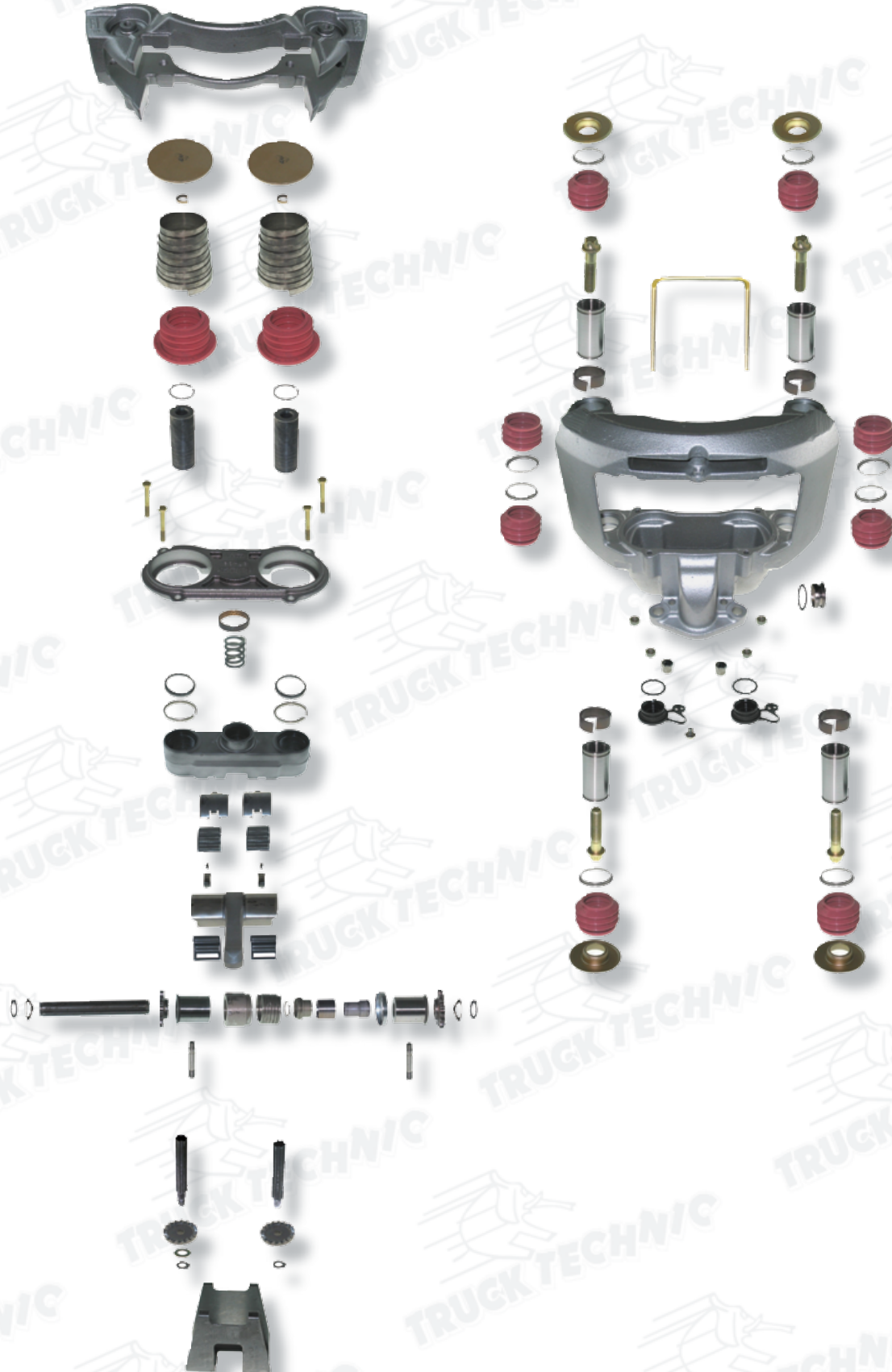

HALDEX CALIPERS





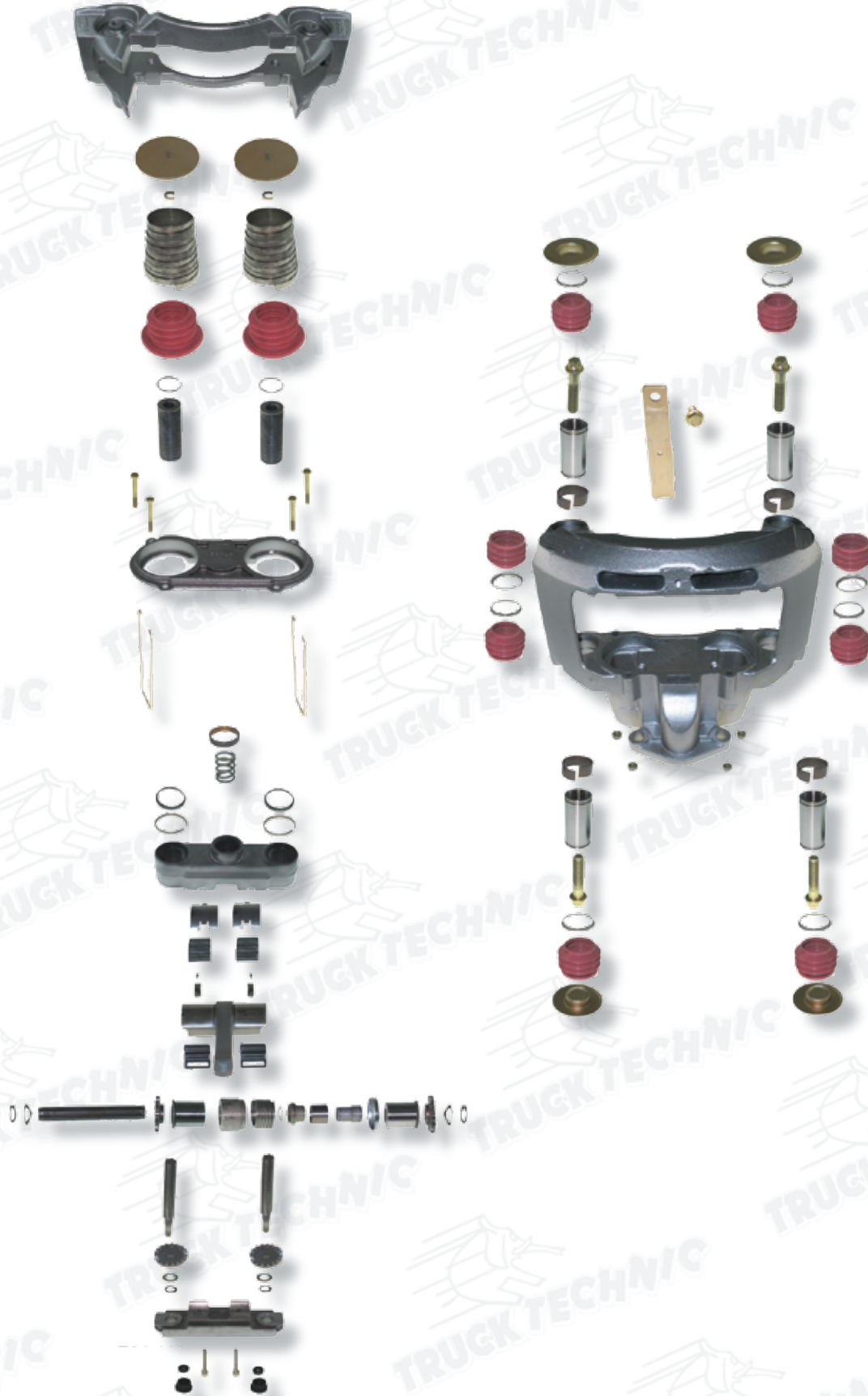







MARK III Types

Typical exploded view of most key models are exposed here, to help you to choose correct repair kits.



HALDEX CALIPERS

MARK IV DB22 Types

	<table border="1"> <tr><td>TT KIT n°</td><td>CHSK.1</td></tr> <tr><td>Maker</td><td>HALDEX</td></tr> <tr><td>OR kit n°</td><td>89541</td></tr> <tr><td>Description</td><td>Sliding Function incl. Slide Pins</td></tr> <tr><td>Application</td><td>s/n 090221 →</td></tr> </table>	TT KIT n°	CHSK.1	Maker	HALDEX	OR kit n°	89541	Description	Sliding Function incl. Slide Pins	Application	s/n 090221 →		<table border="1"> <tr><td>TT KIT n°</td><td>CHSK.1.1</td></tr> <tr><td>Maker</td><td>HALDEX</td></tr> <tr><td>OR kit n°</td><td>87680</td></tr> <tr><td>Description</td><td>Sliding Function excl. Slide Pins</td></tr> <tr><td>Application</td><td>MKII , III , IV</td></tr> </table>	TT KIT n°	CHSK.1.1	Maker	HALDEX	OR kit n°	87680	Description	Sliding Function excl. Slide Pins	Application	MKII , III , IV
TT KIT n°	CHSK.1																						
Maker	HALDEX																						
OR kit n°	89541																						
Description	Sliding Function incl. Slide Pins																						
Application	s/n 090221 →																						
TT KIT n°	CHSK.1.1																						
Maker	HALDEX																						
OR kit n°	87680																						
Description	Sliding Function excl. Slide Pins																						
Application	MKII , III , IV																						
	<table border="1"> <tr><td>TT KIT n°</td><td>CHSK.1.2</td></tr> <tr><td>Maker</td><td>HALDEX</td></tr> <tr><td>OR kit n°</td><td>87406</td></tr> <tr><td>Description</td><td>Sliding Function incl. Slide Pins</td></tr> <tr><td>Application</td><td>MK II, III ,IV</td></tr> </table>	TT KIT n°	CHSK.1.2	Maker	HALDEX	OR kit n°	87406	Description	Sliding Function incl. Slide Pins	Application	MK II, III ,IV		<table border="1"> <tr><td>TT KIT n°</td><td>CHSK.2</td></tr> <tr><td>Maker</td><td>HALDEX</td></tr> <tr><td>OR kit n°</td><td>87405</td></tr> <tr><td>Description</td><td>Adjustment Screw Sealing</td></tr> <tr><td>Application</td><td>s/n →142 ... / MK II, III</td></tr> </table>	TT KIT n°	CHSK.2	Maker	HALDEX	OR kit n°	87405	Description	Adjustment Screw Sealing	Application	s/n →142 ... / MK II, III
TT KIT n°	CHSK.1.2																						
Maker	HALDEX																						
OR kit n°	87406																						
Description	Sliding Function incl. Slide Pins																						
Application	MK II, III ,IV																						
TT KIT n°	CHSK.2																						
Maker	HALDEX																						
OR kit n°	87405																						
Description	Adjustment Screw Sealing																						
Application	s/n →142 ... / MK II, III																						
	<table border="1"> <tr><td>TT KIT n°</td><td>CHSK.2.1</td></tr> <tr><td>Maker</td><td>HALDEX</td></tr> <tr><td>OR kit n°</td><td>89794</td></tr> <tr><td>Description</td><td>Adjustment Screw Sealing</td></tr> <tr><td>Application</td><td>s/n 143 ... → / MK IV</td></tr> </table>	TT KIT n°	CHSK.2.1	Maker	HALDEX	OR kit n°	89794	Description	Adjustment Screw Sealing	Application	s/n 143 ... → / MK IV		<table border="1"> <tr><td>TT KIT n°</td><td>CHSK.3</td></tr> <tr><td>Maker</td><td>HALDEX</td></tr> <tr><td>OR kit n°</td><td>81658</td></tr> <tr><td>Description</td><td>Pad Retainer Brace</td></tr> <tr><td>Application</td><td>s/n → 042 ... / MK II</td></tr> </table>	TT KIT n°	CHSK.3	Maker	HALDEX	OR kit n°	81658	Description	Pad Retainer Brace	Application	s/n → 042 ... / MK II
TT KIT n°	CHSK.2.1																						
Maker	HALDEX																						
OR kit n°	89794																						
Description	Adjustment Screw Sealing																						
Application	s/n 143 ... → / MK IV																						
TT KIT n°	CHSK.3																						
Maker	HALDEX																						
OR kit n°	81658																						
Description	Pad Retainer Brace																						
Application	s/n → 042 ... / MK II																						
	<table border="1"> <tr><td>TT KIT n°</td><td>CHSK.3.1</td></tr> <tr><td>Maker</td><td>HALDEX</td></tr> <tr><td>OR kit n°</td><td>89927</td></tr> <tr><td>Description</td><td>Protection Caps</td></tr> <tr><td>Application</td><td>s/n 143 ... → / MK IV</td></tr> </table>	TT KIT n°	CHSK.3.1	Maker	HALDEX	OR kit n°	89927	Description	Protection Caps	Application	s/n 143 ... → / MK IV		<table border="1"> <tr><td>TT KIT n°</td><td>CHSK.3.2</td></tr> <tr><td>Maker</td><td>HALDEX</td></tr> <tr><td>OR kit n°</td><td>90673</td></tr> <tr><td>Description</td><td>Pad retainer</td></tr> <tr><td>Application</td><td>s/n 043 ... → / MKIII,IV&Modul X</td></tr> </table>	TT KIT n°	CHSK.3.2	Maker	HALDEX	OR kit n°	90673	Description	Pad retainer	Application	s/n 043 ... → / MKIII,IV&Modul X
TT KIT n°	CHSK.3.1																						
Maker	HALDEX																						
OR kit n°	89927																						
Description	Protection Caps																						
Application	s/n 143 ... → / MK IV																						
TT KIT n°	CHSK.3.2																						
Maker	HALDEX																						
OR kit n°	90673																						
Description	Pad retainer																						
Application	s/n 043 ... → / MKIII,IV&Modul X																						
	<table border="1"> <tr><td>TT KIT n°</td><td>CHSK.3.3</td></tr> <tr><td>Maker</td><td>HALDEX</td></tr> <tr><td>OR kit n°</td><td>90693</td></tr> <tr><td>Description</td><td>Adjustment Shaft</td></tr> <tr><td>Application</td><td>s/n 143 ... → / MK IV & Modul X</td></tr> </table>	TT KIT n°	CHSK.3.3	Maker	HALDEX	OR kit n°	90693	Description	Adjustment Shaft	Application	s/n 143 ... → / MK IV & Modul X		<table border="1"> <tr><td>TT KIT n°</td><td>CHSK.3.4</td></tr> <tr><td>Maker</td><td>HALDEX</td></tr> <tr><td>OR kit n°</td><td>87408</td></tr> <tr><td>Description</td><td>Plugs</td></tr> <tr><td>Application</td><td>s/n → 142..., MKII & III</td></tr> </table>	TT KIT n°	CHSK.3.4	Maker	HALDEX	OR kit n°	87408	Description	Plugs	Application	s/n → 142..., MKII & III
TT KIT n°	CHSK.3.3																						
Maker	HALDEX																						
OR kit n°	90693																						
Description	Adjustment Shaft																						
Application	s/n 143 ... → / MK IV & Modul X																						
TT KIT n°	CHSK.3.4																						
Maker	HALDEX																						
OR kit n°	87408																						
Description	Plugs																						
Application	s/n → 142..., MKII & III																						
	<table border="1"> <tr><td>TT KIT n°</td><td>CHSK.4</td></tr> <tr><td>Maker</td><td>HALDEX</td></tr> <tr><td>OR kit n°</td><td>92731</td></tr> <tr><td>Description</td><td>Thrust plate (6 mm)</td></tr> <tr><td>Application</td><td>MK III & MK IV</td></tr> </table>	TT KIT n°	CHSK.4	Maker	HALDEX	OR kit n°	92731	Description	Thrust plate (6 mm)	Application	MK III & MK IV		<table border="1"> <tr><td>TT KIT n°</td><td>CHSK.4.1</td></tr> <tr><td>Maker</td><td>HALDEX</td></tr> <tr><td>OR kit n°</td><td>91236</td></tr> <tr><td>Description</td><td>Thrust plate + 2x Clips</td></tr> <tr><td>Application</td><td>MK IV</td></tr> </table>	TT KIT n°	CHSK.4.1	Maker	HALDEX	OR kit n°	91236	Description	Thrust plate + 2x Clips	Application	MK IV
TT KIT n°	CHSK.4																						
Maker	HALDEX																						
OR kit n°	92731																						
Description	Thrust plate (6 mm)																						
Application	MK III & MK IV																						
TT KIT n°	CHSK.4.1																						
Maker	HALDEX																						
OR kit n°	91236																						
Description	Thrust plate + 2x Clips																						
Application	MK IV																						

HALDEX CALIPERS

MODUL X Types

Typical exploded view of most key models are exposed here, to help you to choose correct repair kits.

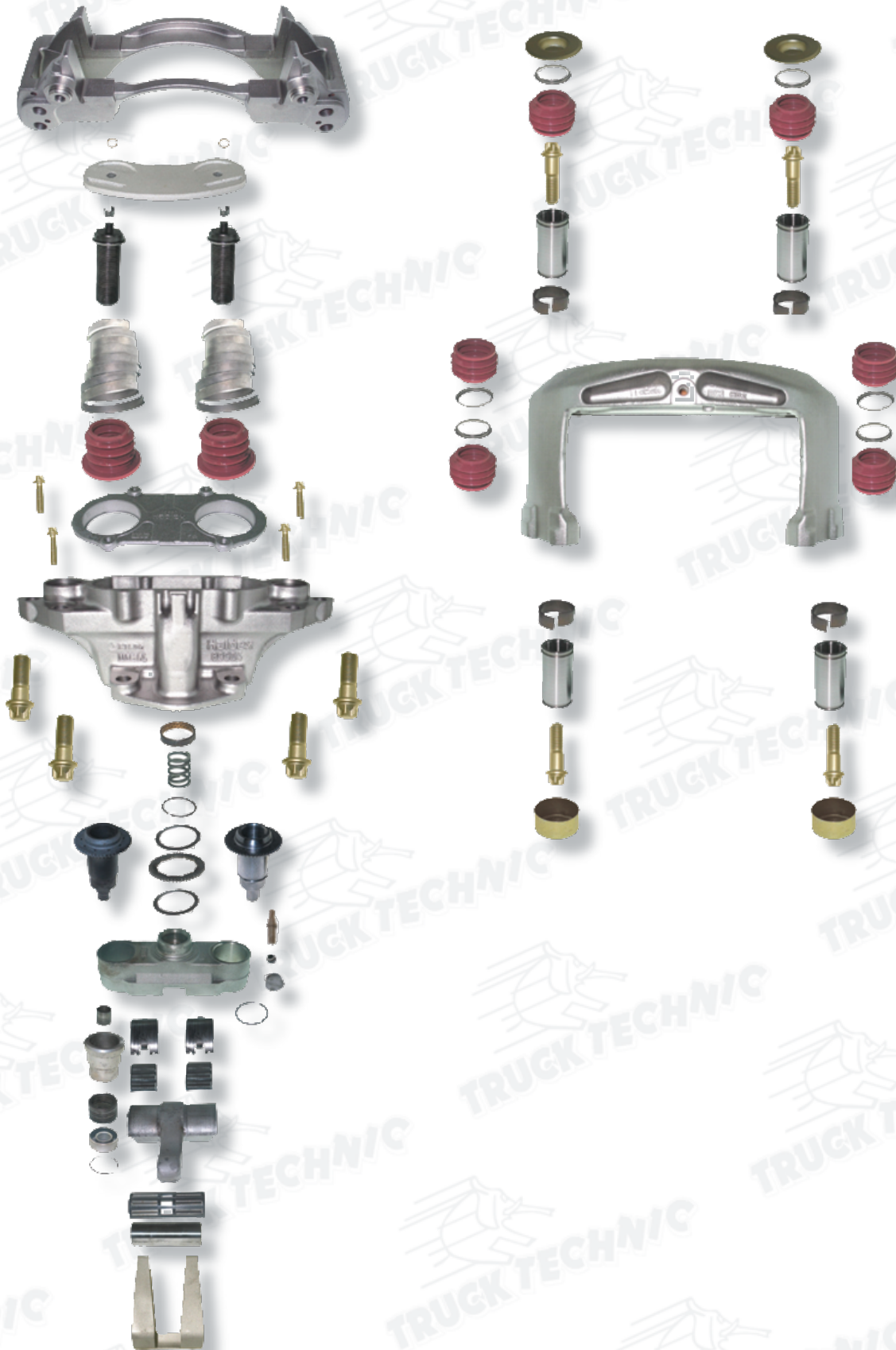

HALDEX CALIPERS

MODUL X Types

	<table border="1"> <tr><td>TT KIT n°</td><td>CHSK.5</td></tr> <tr><td>Maker</td><td>HALDEX</td></tr> <tr><td>OR kit n°</td><td>91012</td></tr> <tr><td>Description</td><td>Sliding Function incl. slide pins</td></tr> <tr><td>Application</td><td>All MODUL X</td></tr> </table>	TT KIT n°	CHSK.5	Maker	HALDEX	OR kit n°	91012	Description	Sliding Function incl. slide pins	Application	All MODUL X		<table border="1"> <tr><td>TT KIT n°</td><td>CHSK.5.1</td></tr> <tr><td>Maker</td><td>HALDEX</td></tr> <tr><td>OR kit n°</td><td>91013</td></tr> <tr><td>Description</td><td>Sliding Function excl. slide pins</td></tr> <tr><td>Application</td><td>All MODUL X</td></tr> </table>	TT KIT n°	CHSK.5.1	Maker	HALDEX	OR kit n°	91013	Description	Sliding Function excl. slide pins	Application	All MODUL X
TT KIT n°	CHSK.5																						
Maker	HALDEX																						
OR kit n°	91012																						
Description	Sliding Function incl. slide pins																						
Application	All MODUL X																						
TT KIT n°	CHSK.5.1																						
Maker	HALDEX																						
OR kit n°	91013																						
Description	Sliding Function excl. slide pins																						
Application	All MODUL X																						
	<table border="1"> <tr><td>TT KIT n°</td><td>CHSK.5.2</td></tr> <tr><td>Maker</td><td>HALDEX</td></tr> <tr><td>OR kit n°</td><td>91014</td></tr> <tr><td>Description</td><td>Sliding Function (light)</td></tr> <tr><td>Application</td><td>All MODUL X</td></tr> </table>	TT KIT n°	CHSK.5.2	Maker	HALDEX	OR kit n°	91014	Description	Sliding Function (light)	Application	All MODUL X		<table border="1"> <tr><td>TT KIT n°</td><td>CHSK.6</td></tr> <tr><td>Maker</td><td>HALDEX</td></tr> <tr><td>OR kit n°</td><td>91011</td></tr> <tr><td>Description</td><td>Sealing adjust- ment screw</td></tr> <tr><td>Application</td><td>All MODUL X</td></tr> </table>	TT KIT n°	CHSK.6	Maker	HALDEX	OR kit n°	91011	Description	Sealing adjust- ment screw	Application	All MODUL X
TT KIT n°	CHSK.5.2																						
Maker	HALDEX																						
OR kit n°	91014																						
Description	Sliding Function (light)																						
Application	All MODUL X																						
TT KIT n°	CHSK.6																						
Maker	HALDEX																						
OR kit n°	91011																						
Description	Sealing adjust- ment screw																						
Application	All MODUL X																						
	<table border="1"> <tr><td>TT KIT n°</td><td>CHSK.2.1</td></tr> <tr><td>Maker</td><td>HALDEX</td></tr> <tr><td>OR kit n°</td><td>89794</td></tr> <tr><td>Description</td><td>Sealing adjust- ment screw</td></tr> <tr><td>Application</td><td>All MODUL X</td></tr> </table>	TT KIT n°	CHSK.2.1	Maker	HALDEX	OR kit n°	89794	Description	Sealing adjust- ment screw	Application	All MODUL X		<table border="1"> <tr><td>TT KIT n°</td><td>CHSK.3.3</td></tr> <tr><td>Maker</td><td>HALDEX</td></tr> <tr><td>OR kit n°</td><td>90693</td></tr> <tr><td>Description</td><td>Adjustment Shaft</td></tr> <tr><td>Application</td><td>s/n 143 ... → / MK IV & Modul X</td></tr> </table>	TT KIT n°	CHSK.3.3	Maker	HALDEX	OR kit n°	90693	Description	Adjustment Shaft	Application	s/n 143 ... → / MK IV & Modul X
TT KIT n°	CHSK.2.1																						
Maker	HALDEX																						
OR kit n°	89794																						
Description	Sealing adjust- ment screw																						
Application	All MODUL X																						
TT KIT n°	CHSK.3.3																						
Maker	HALDEX																						
OR kit n°	90693																						
Description	Adjustment Shaft																						
Application	s/n 143 ... → / MK IV & Modul X																						
	<table border="1"> <tr><td>TT KIT n°</td><td>CHSK.3.4</td></tr> <tr><td>Maker</td><td>HALDEX</td></tr> <tr><td>OR kit n°</td><td>81658</td></tr> <tr><td>Description</td><td>Pad retainer Brace</td></tr> <tr><td>Application</td><td>s/n → 042 ... / MK II</td></tr> </table>	TT KIT n°	CHSK.3.4	Maker	HALDEX	OR kit n°	81658	Description	Pad retainer Brace	Application	s/n → 042 ... / MK II		<table border="1"> <tr><td>TT KIT n°</td><td>CHSK.4</td></tr> <tr><td>Maker</td><td>HALDEX</td></tr> <tr><td>OR kit n°</td><td>92731</td></tr> <tr><td>Description</td><td>Thrust plate</td></tr> <tr><td>Application</td><td>MK III & MK IV</td></tr> </table>	TT KIT n°	CHSK.4	Maker	HALDEX	OR kit n°	92731	Description	Thrust plate	Application	MK III & MK IV
TT KIT n°	CHSK.3.4																						
Maker	HALDEX																						
OR kit n°	81658																						
Description	Pad retainer Brace																						
Application	s/n → 042 ... / MK II																						
TT KIT n°	CHSK.4																						
Maker	HALDEX																						
OR kit n°	92731																						
Description	Thrust plate																						
Application	MK III & MK IV																						
	<table border="1"> <tr><td>TT KIT n°</td><td>CHSK.7</td></tr> <tr><td>Maker</td><td>HALDEX</td></tr> <tr><td>OR kit n°</td><td>87833</td></tr> <tr><td>Description</td><td>Assembly Cup Protect. Bellows</td></tr> <tr><td>Application</td><td>All MODUL X</td></tr> </table>	TT KIT n°	CHSK.7	Maker	HALDEX	OR kit n°	87833	Description	Assembly Cup Protect. Bellows	Application	All MODUL X		<table border="1"> <tr><td>TT KIT n°</td><td>CHSK.7.1</td></tr> <tr><td>Maker</td><td>HALDEX</td></tr> <tr><td>OR kit n°</td><td>81928</td></tr> <tr><td>Description</td><td>Pressure Plug Protect. Bellows</td></tr> <tr><td>Application</td><td>All MODUL X</td></tr> </table>	TT KIT n°	CHSK.7.1	Maker	HALDEX	OR kit n°	81928	Description	Pressure Plug Protect. Bellows	Application	All MODUL X
TT KIT n°	CHSK.7																						
Maker	HALDEX																						
OR kit n°	87833																						
Description	Assembly Cup Protect. Bellows																						
Application	All MODUL X																						
TT KIT n°	CHSK.7.1																						
Maker	HALDEX																						
OR kit n°	81928																						
Description	Pressure Plug Protect. Bellows																						
Application	All MODUL X																						
	<table border="1"> <tr><td>TT KIT n°</td><td>CHSK.7.2</td></tr> <tr><td>Maker</td><td>HALDEX</td></tr> <tr><td>OR kit n°</td><td>81927</td></tr> <tr><td>Description</td><td>Cover Plate Plug</td></tr> <tr><td>Application</td><td>All MODUL X</td></tr> </table>	TT KIT n°	CHSK.7.2	Maker	HALDEX	OR kit n°	81927	Description	Cover Plate Plug	Application	All MODUL X												
TT KIT n°	CHSK.7.2																						
Maker	HALDEX																						
OR kit n°	81927																						
Description	Cover Plate Plug																						
Application	All MODUL X																						

HALDEX CALIPER repair kits

Repair kits details

BREMBO CALIPERS



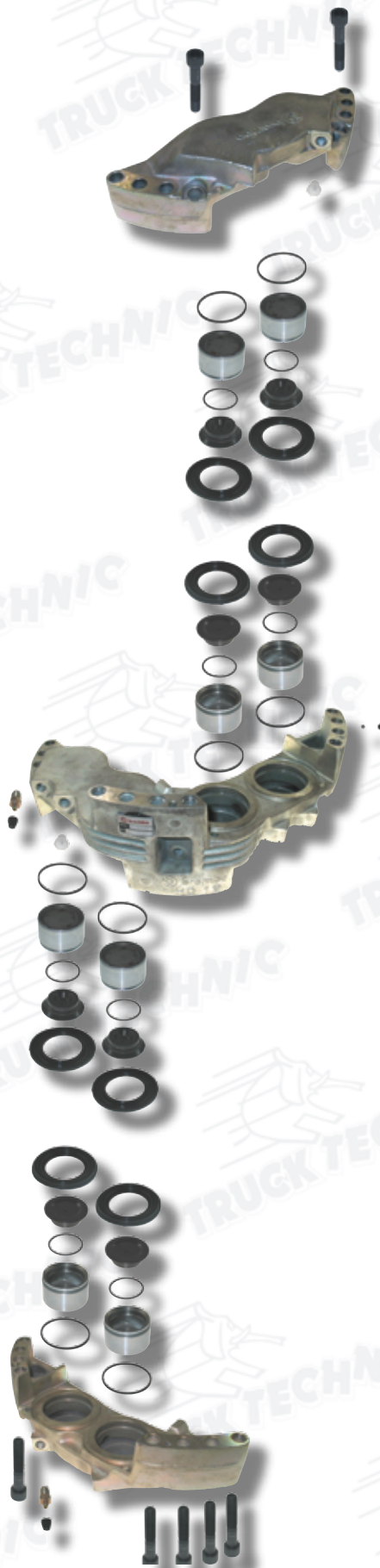

R312 - 20.5320.12-22-32-42

Typical exploded view of most key models are exposed here, to help you to choose correct repair kits.



BREMBO CALIPERS

R312 - 20.5320.12-22-32-42

	<table border="1"> <tr><td>TT KIT n°</td><td>CBRSK.1</td></tr> <tr><td>Maker</td><td>BREMBO</td></tr> <tr><td>OR kit n°</td><td>-</td></tr> <tr><td>Description</td><td>Pistons</td></tr> <tr><td>Application</td><td>20.5320.12/ 22/32/42</td></tr> </table>	TT KIT n°	CBRSK.1	Maker	BREMBO	OR kit n°	-	Description	Pistons	Application	20.5320.12/ 22/32/42		<table border="1"> <tr><td>TT KIT n°</td><td>CBRSK.2</td></tr> <tr><td>Maker</td><td>BREMBO</td></tr> <tr><td>OR kit n°</td><td>-</td></tr> <tr><td>Description</td><td>Complete overhaul</td></tr> <tr><td>Application</td><td>20.5320.12/ 22/32/42</td></tr> </table>	TT KIT n°	CBRSK.2	Maker	BREMBO	OR kit n°	-	Description	Complete overhaul	Application	20.5320.12/ 22/32/42
TT KIT n°	CBRSK.1																						
Maker	BREMBO																						
OR kit n°	-																						
Description	Pistons																						
Application	20.5320.12/ 22/32/42																						
TT KIT n°	CBRSK.2																						
Maker	BREMBO																						
OR kit n°	-																						
Description	Complete overhaul																						
Application	20.5320.12/ 22/32/42																						
 <p>OUT Ø : 70mm Thickness : 4mm</p>	<table border="1"> <tr><td>TT KIT n°</td><td>CBRSK.3</td></tr> <tr><td>Maker</td><td>BREMBO</td></tr> <tr><td>OR kit n°</td><td>120.4684.28</td></tr> <tr><td>Description</td><td>Piston + Sealing Thick Model</td></tr> <tr><td>Application</td><td>20.5320.12/ 22/32/42</td></tr> </table>	TT KIT n°	CBRSK.3	Maker	BREMBO	OR kit n°	120.4684.28	Description	Piston + Sealing Thick Model	Application	20.5320.12/ 22/32/42	 <p>OUT Ø : 66mm Thickness : 3mm</p>	<table border="1"> <tr><td>TT KIT n°</td><td>CBRSK.4</td></tr> <tr><td>Maker</td><td>BREMBO</td></tr> <tr><td>OR kit n°</td><td>120.4684.27</td></tr> <tr><td>Description</td><td>Piston + Sealing Thin Model</td></tr> <tr><td>Application</td><td>20.5320.12/ 22/32/42</td></tr> </table>	TT KIT n°	CBRSK.4	Maker	BREMBO	OR kit n°	120.4684.27	Description	Piston + Sealing Thin Model	Application	20.5320.12/ 22/32/42
TT KIT n°	CBRSK.3																						
Maker	BREMBO																						
OR kit n°	120.4684.28																						
Description	Piston + Sealing Thick Model																						
Application	20.5320.12/ 22/32/42																						
TT KIT n°	CBRSK.4																						
Maker	BREMBO																						
OR kit n°	120.4684.27																						
Description	Piston + Sealing Thin Model																						
Application	20.5320.12/ 22/32/42																						
	<table border="1"> <tr><td>TT KIT n°</td><td>CBRSK.5</td></tr> <tr><td>Maker</td><td>BREMBO</td></tr> <tr><td>OR kit n°</td><td>120.5468.10</td></tr> <tr><td>Description</td><td>Piston hat Cap & O rings</td></tr> <tr><td>Application</td><td>20.5320.12/ 22/32/42</td></tr> </table>	TT KIT n°	CBRSK.5	Maker	BREMBO	OR kit n°	120.5468.10	Description	Piston hat Cap & O rings	Application	20.5320.12/ 22/32/42	 <p>OUT Ø : 70 mm Thickness : 4 mm</p>	<table border="1"> <tr><td>TT KIT n°</td><td>CBRSK.6</td></tr> <tr><td>Maker</td><td>BREMBO</td></tr> <tr><td>OR kit n°</td><td>120.4684.25</td></tr> <tr><td>Description</td><td>Complete sealing kit (thick model)</td></tr> <tr><td>Application</td><td>20.5320.12/ 22/32/42</td></tr> </table>	TT KIT n°	CBRSK.6	Maker	BREMBO	OR kit n°	120.4684.25	Description	Complete sealing kit (thick model)	Application	20.5320.12/ 22/32/42
TT KIT n°	CBRSK.5																						
Maker	BREMBO																						
OR kit n°	120.5468.10																						
Description	Piston hat Cap & O rings																						
Application	20.5320.12/ 22/32/42																						
TT KIT n°	CBRSK.6																						
Maker	BREMBO																						
OR kit n°	120.4684.25																						
Description	Complete sealing kit (thick model)																						
Application	20.5320.12/ 22/32/42																						
 <p>OUT Ø : 66 mm Thickness : 3 mm</p>	<table border="1"> <tr><td>TT KIT n°</td><td>CBRSK.7</td></tr> <tr><td>Maker</td><td>BREMBO</td></tr> <tr><td>OR kit n°</td><td>120.4684.26</td></tr> <tr><td>Description</td><td>Complete sealing kit (thick model)</td></tr> <tr><td>Application</td><td>20.5320.12/ 22/32/42</td></tr> </table>	TT KIT n°	CBRSK.7	Maker	BREMBO	OR kit n°	120.4684.26	Description	Complete sealing kit (thick model)	Application	20.5320.12/ 22/32/42		<table border="1"> <tr><td>TT KIT n°</td><td>CBRSK.8</td></tr> <tr><td>Maker</td><td>BREMBO</td></tr> <tr><td>OR kit n°</td><td>105.3246.25</td></tr> <tr><td>Description</td><td>Bleeders</td></tr> <tr><td>Application</td><td>20.5320.12/ 22/32/42</td></tr> </table>	TT KIT n°	CBRSK.8	Maker	BREMBO	OR kit n°	105.3246.25	Description	Bleeders	Application	20.5320.12/ 22/32/42
TT KIT n°	CBRSK.7																						
Maker	BREMBO																						
OR kit n°	120.4684.26																						
Description	Complete sealing kit (thick model)																						
Application	20.5320.12/ 22/32/42																						
TT KIT n°	CBRSK.8																						
Maker	BREMBO																						
OR kit n°	105.3246.25																						
Description	Bleeders																						
Application	20.5320.12/ 22/32/42																						
	<table border="1"> <tr><td>TT KIT n°</td><td>CBRSK.9</td></tr> <tr><td>Maker</td><td>BREMBO</td></tr> <tr><td>OR kit n°</td><td>122.4849.42</td></tr> <tr><td>Description</td><td>Pad Retainers</td></tr> <tr><td>Application</td><td>20.5320.12/ 22/32/42</td></tr> </table>	TT KIT n°	CBRSK.9	Maker	BREMBO	OR kit n°	122.4849.42	Description	Pad Retainers	Application	20.5320.12/ 22/32/42		<table border="1"> <tr><td>TT KIT n°</td><td>CBRSK.10</td></tr> <tr><td>Maker</td><td>BREMBO</td></tr> <tr><td>OR kit n°</td><td>120.3204.45</td></tr> <tr><td>Description</td><td>Pins & clips</td></tr> <tr><td>Application</td><td>20.5320.12/ 22/32/42</td></tr> </table>	TT KIT n°	CBRSK.10	Maker	BREMBO	OR kit n°	120.3204.45	Description	Pins & clips	Application	20.5320.12/ 22/32/42
TT KIT n°	CBRSK.9																						
Maker	BREMBO																						
OR kit n°	122.4849.42																						
Description	Pad Retainers																						
Application	20.5320.12/ 22/32/42																						
TT KIT n°	CBRSK.10																						
Maker	BREMBO																						
OR kit n°	120.3204.45																						
Description	Pins & clips																						
Application	20.5320.12/ 22/32/42																						

BREMBO CALIPER repair kits

Repair kits details

PONT A MOUSSON CALIPERS



4 PISTONS / 5001825777

Typical exploded view of most key models are exposed here, to help you to choose correct repair kits.



PONT A MOUSSON CALIPERS

4 PISTONS / 5001825777

	TT KIT n°	CPSK.3		TT KIT n°	CPSK.4
	Maker	Pont AMousson		Maker	Pont AMousson
	OR kit n°	-		OR kit n°	-
	Description	Piston		Description	Seals
	Application	5001825777		Application	5001825777

PONT A MOUSSON 4 PISTONS CALIPER repair kits

Repair kits details

PONT A MOUSSON CALIPERS



6 PISTONS / 5010197252

Typical exploded view of most key models are exposed here, to help you to choose correct repair kits.



PONT A MOUSSON CALIPERS

6 PISTONS / 5010197252

	TT KIT n°	CPSK.1		TT KIT n°	CPSK.2
	Maker	Pont AMousson		Maker	Pont AMousson
	OR kit n°	-		OR kit n°	-
	Description	Piston		Description	Seals
	Application	5010197252		Application	5010197252

PONT A MOUSSON 6 PISTONS CALIPER repair kits

Repair kits details

TRUCKTECHNIC CATALOGUES

GENERAL CATALOGUES



> ttc.abunits.001



> ttc.calipers.004



> ttc.repairkits.001



> ttc.compr.003

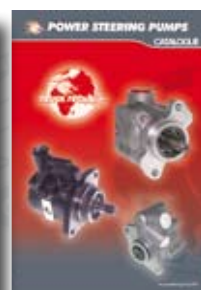

> ttc.psp.001



> ttc.oilseals.001

FAST PARTS CATALOGUES



> ttc.fpdaf.001



> ttc.fpbenz.001



> ttc.fpiveco.001



> ttc.fpman.001



> ttc.fprvi.001

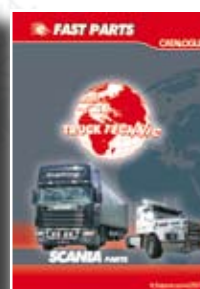

> ttc.fpscania.001



> ttc.fptrailers.001



> ttc.fpvolve.001

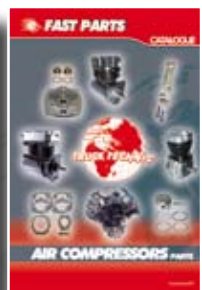

> ttc.fpcmpr.001



> ttc.fpspring.001



> ttc.fpcservo.001

ORDER THESE CATALOGUES BY THEIR PART NUMBER FROM OUR SALES DEPARTMENT

Tel: +32(0) 4 278 79 98

Fax: +32(0) 4 278 10 78

Email : sales@trucktechnic.com