



KATALOG

ZACISKÓW HAMULCOWYCH I ZESTAWÓW NAPRAWCZYCH
DISC BRAKE CALIPERS & REPAIR KITS CATALOGUE

Safe **braking** is our priority

www.sbp-brakes.com

SPIS TREŚCI / CONTENTS

ZACISKI HAMULCOWE / DISC BRAKE CALIPERS

STRONA/
PAGE

BOVA	3
BPW	3
DAF	3
DENNIS	4
ERF	4
EVO BUS	5
GIGANT	6
IKARUS	6
IRISBUS	7
IVECO	8
KAROSA	9
KASBOHRER	9
LECINENA	9
MAN	10-11
MERCEDES	12-13
NEOPLAN	14
ROR	14
RENAULT RVI	15
SAE	16
SAF	16
SCANIA	17
SMB	17
VAN HOOL	18
VOLVO	19
FEBER	19

ZESTAWY NAPRAWCZE ZACISKÓW / REPAIR KITS

KNORR	20
SB5	21 - 24
SN5	25-28
SB6	29-33
SN6	34-38
SB7	39-44
SN7	45-49
MERITOR	50
DX195	51-53
ELSA195/225	54-56
ELSA1	57-59
ELSA2	60-63
DUCO	64-67
LISA	68-70
D3	71-73
WABCO	74
PAN17	75-77
PAN19	78-80
PAN22	81-83
MAXX22	84-86
PAN 19-2, PAN 22-2	87-89
BPW	90
ECO DISC	91-93
SAF	94
SBS2220 MODULT	95-97
HALDEX	98
MODUL X	99-102
MARK III	103-105
MARK IV	106-108



ZACISKI HAMULCOWE BRAKE DISC CALIPERS

BOVA

MODEL	CALIPER TYPE TYP ZACISKU	PADS WVA NO.	X REF	X REF 2	X REF 3	Veh. Manuf. Ref	SIDE STRONA	INDEX	KIT PAGE
BOVA FUTURA FLD 12/14/15 FHD10/12/13/15	KNORR SB/SN7	29108	K002785	SB7419RC	RX91.03.003	501007035	2	TEQ-BC.073	39-49
			K002486	SB7409RC	RX91.03.004	501007036	1	TEQ-BC.074	39-49

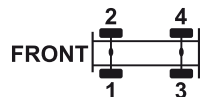

TEQ-BC.073
TEQ-BC.074



BPW

MODEL	CALIPER TYPE TYP ZACISKU	PADS WVA NO.	X REF	X REF 2	X REF 3	VEH MANUF. REF	SIDE STRONA	INDEX	KIT PAGE
SH Series, SB4309T Axial 430 mm Disc	Knorr SK7	29171	K001908	SK7001	RX91.03.073	0536270630	2	TEQ-BC.031	39-49
			K001909	SK7011	RX91.03.074	0536270620	1	TEQ-BC.024	39-49
SH Series, SB4345 Axial 430 mm Disc	Knorr SB/SN7	29108	K003804	SN7196RC	RX91.03.003	0536270391	2	TEQ-BC.073	39-49
			K003803	SN7186RC	RX91.03.004	0536270381	1	TEQ-BC.074	39-49
SKH Series, SB3745 Axial 370 mm Disc	Knorr SB/SN6	29094	K013174	SN6580RC	RX91.02.001	0536270361	2	TEQ-BC.002	29-38
			K013173	SN6570RC	RX91.02.002	0536270371	1	TEQ-BC.001	29-38
SKH Series, SB3745T Tangential 370 mm Disc	Knorr SB/SN6	29094	K013174	SN6580RC	RX91.02.001	0536270613	2	TEQ-BC.002	29-38
			K013173	SN6570RC	RX91.02.002	0536270603	1	TEQ-BC.001	29-38
SKH Series, SB4345T Tangential 430 mm Disc	Knorr SB/SN7	29108	K003804	SN7196RC	RX91.03.003	0536270650	2	TEQ-BC.073	39-49
			K003803	SN7186RC	RX91.03.004	0536270640	1	TEQ-BC.074	39-49
Steering Axle, SB3745 370 mm Disc	Knorr SB/SN6	29094	K002923	SB6401RC	RX91.02.003	0536270401	1	TEQ-BC.073	39-49
			K002924	SB6411RC	RX91.02.004	0536270411	2	TEQ-BC.074	39-49
ECO PLUS 2 TSB 4309 430 mm Disc	BPW	29228	936272010	936272110			1	TEQ-BC.193	91-93
			936272020	936272120			2	TEQ-BC.194	91-93
ECO PLUS 2 TSB 3709 370 mm Disc	BPW	29227	936272030	936272130			1	TEQ-BC.195	91-93
			936272040	936272140			2	TEQ-BC.196	91-93

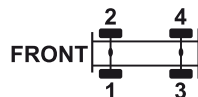

TEQ-BC.073
TEQ-BC.074



TEQ-BC.031
TEQ-BC.024



TEQ-BC.002
TEQ-BC.001

DAF

MODEL	CALIPER TYPE TYP ZACISKU	PADS WVA NO.	X REF	X REF 2	X REF 3	VEH MANUF. REF	SIDE STRONA	INDEX	KIT PAGE
DAF CF65, CF75, CF85, CF95	Knorr SB/SN7	29108	K003806	SN7214RC	RX91.03.019	1449168	1 3	TEQ-BC.020	39-49
			K003805	SN7204RC	RX91.03.020	1449167	2 4	TEQ-BC.016	39-49
DAF CF65, CF75, CF85, CF95, XF95 2001 ->	Knorr SB/SN7	29108	K003806	SN7214RC	RX91.03.019	1658012	1 3	TEQ-BC.020	39-49
			K003805	SN7204RC	RX91.03.020	1658011	2 4	TEQ-BC.016	39-49
DAF45 LF 11/2000 ->	Wabco PAN 17	29088	40175072	40175064		1440500	1 3	TEQ-BC.037	75-77
DAF55 LF 02/2003 ->	Wabco PAN 19-1+	29159	40175073	40175065		1440501	2 4	TEQ-BC.051	75-77
			40195045			1628062	1 3	TEQ-BC.115	78-80
DAF55 LF 09/2000 -> 01/2003	Wabco PAN 19-2	29142	40195046			1628063	2 4	TEQ-BC.116	78-80
			40195011			1440502	1 3	TEQ-BC.117	87-89
SB 3000 BUS Bova (ZF Axles)	Knorr SB/SN7	29108	K003804	SN7196RC	RX91.03.003	0501005905	1 3	TEQ-BC.073	39-49
			K003803	SN7186RC	RX91.03.004	0501005906	2 4	TEQ-BC.074	39-49
SB120	Knorr SB/SN6	29095	K013174	SN6580RC	RX91.02.001	829691	2 4	TEQ-BC.002	29-38
			K013173	SN6570RC	RX91.02.002	829771	1 3	TEQ-BC.001	29-38

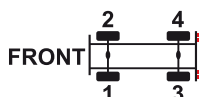

TEQ-BC.020; TEQ-BC.016
TEQ-BC.073; TEQ-BC.074



TEQ-BC.002
TEQ-BC.001



TEQ-BC.037
TEQ-BC.051



TEQ-BC.115
TEQ-BC.116



TEQ-BC.117
TEQ-BC.118

DENNIS

MODEL	CALIPER TYPE TYP ZACISKU	PADS WVA NO.	X REF	X REF 2	X REF 3	VEH MANUF. REF	SIDE STRONA	INDEX	KIT PAGE
Dennis Elite & PHOENIX	Meritor D LISA	29043	LRG630	68032864	RX93.05.009		1 3	TEQ-BC.119	68-70
			LRG631	68032865	RX93.05.010		2 4	TEQ-BC.120	68-70
Dennis Enviro	Wabco PAN 19-1+	29159	40195019				1 3	TEQ-BC.121	78-80
			40195020				2 4	TEQ-BC.122	78-80
Dennis Javelin PCV MK2 10/1991 >	Meritor D2	29043	LRG530	68032172	RX93.03.003	653563	1	TEQ-BC.123	-
			LRG531	68032173	RX93.03.004	653564	2	TEQ-BC.124	-
Dennis Javelin PCV MK3 1995 <	Meritor D LISA	29043	LRG550	LRG592	RX93.05.007	655377	1	TEQ-BC.089	68-70
			LRG551	LRG593	RX93.05.008	655378	2	TEQ-BC.090	68-70
Dennis Lance SLF	Meritor D3	29030	LRG528	LRG562	RX93.04.005		1	TEQ-BC.075	71-73
			LRG529	LRG563	RX93.04.006		2	TEQ-BC.076	71-73
Dennis R Series	Knorr SB/SN7	29108	K003784	SN7196RC	RX91.03.003		2 3	TEQ-BC.073	39-49
			K003783	SN7186RC	RX91.03.004		1 4	TEQ-BC.074	39-49
Dennis Trident PCV 2001 <	Knorr SB/SN7	29108	K003784	SN7196RC	RX91.03.003	65847/46	2	TEQ-BC.073	39-49
			K003783	SN7186RC	RX91.03.004	65847/45	1	TEQ-BC.074	39-49
	Knorr SB/SN7 Radial	29108	K002963	SB7460RC	RX91.03.051	658517/34	3	TEQ-BC.077	39-49
			K002962	SB7450RC	RX91.03.052	658517/33	4	TEQ-BC.078	39-49

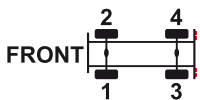

TEQ-BC.073
TEQ-BC.074



TEQ-BC.119
TEQ-BC.120



TEQ-BC.121
TEQ-BC.122



TEQ-BC.123
TEQ-BC.124



TEQ-BC.089
TEQ-BC.090



TEQ-BC.077
TEQ-BC.078



TEQ-BC.075
TEQ-BC.076

ERF

MODEL	CALIPER TYPE TYP ZACISKU	PADS WVA NO.	X REF	X REF 2	X REF 3	VEH MANUF. REF	SIDE STRONA	INDEX	KIT PAGE
ECM, ECS, ECT & ECX	Knorr SB/SN7	29108	K003782	SN7195RC	RX91.03.001	35404210839	1 3	TEQ-BC.015	39-49
			K003781	SN7185RC	RX91.03.002	35404210822	2 4	TEQ-BC.005	39-49
			K003806	SN7214RC	RX91.03.019	35404210851	1 3	TEQ-BC.020	39-49
			K003805	SN7204RC	RX91.03.020	35404210845	2 4	TEQ-BC.016	39-49
ERF	Meritor ELSA 1	29030	LRG616	68032670		68032670	1	TEQ-BC.079	57-59
			LRG617	68032671		68032671	2	TEQ-BC.080	57-59
ERF ECS & ECX 10/2002 >	Meritor ELSA 2	29131	LRG544	68033089		35503120483	1	TEQ-BC.081	60-63
			LRG545	68033090		35503120490	2	TEQ-BC.082	60-63
			LRG638	68033087		35503120460	4	TEQ-BC.083	60-63
			LRG639	68033088		35503120477	3	TEQ-BC.084	60-63

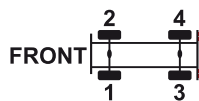

TEQ-BC.015
TEQ-BC.020



TEQ-BC.081
TEQ-BC.083



TEQ-BC.079
TEQ-BC.080

EVO BUS

MODEL	CALIPER TYPE TYP ZACISKU	PADS WVA NO.	X REF	X REF 2	X REF 3	VEH MANUF. REF	SIDE STRONA	INDEX	KIT PAGE
CITARO (6 Wheels)	Knorr SB/SN7	29108	K003800	SN7211RC	RX91.03.013	6284200701	1	TEQ-BC.009	39-49
			K003799	SN7201RC	RX91.03.014	6284200801	2	TEQ-BC.006	39-49
	Knorr SB/SN7 Radial	29108	K002965	SB7461RC	RX91.03.053	0501006007	4	TEQ-BC.039	39-49
			K002964	SB7451RC	RX91.03.054	0501006008	3	TEQ-BC.055	39-49
CITARO (8 Wheels)	Knorr SB/SN7	29108	K003800	SN7211RC	RX91.03.013	6284200701	1 3	TEQ-BC.009	39-49
			K003799	SN7201RC	RX91.03.014	6284200801	2 4	TEQ-BC.006	39-49
CITO -> 01/1998	Knorr SB/SN7	29108	K003800	SN7211RC	RX91.03.013	6284200701	1	TEQ-BC.009	39-49
			K003799	SN7201RC	RX91.03.014	6284200801	2	TEQ-BC.006	39-49
			K003810	SN7198RC	RX91.03.023	0501006296	3	TEQ-BC.004	39-49
			K003809	SN7188RC	RX91.03.024	0501006297	4	TEQ-BC.003	39-49
Integro (12M) M L	Meritor D3	29030	LRG562	LRG528	RX93.04.005	627.000.00.42	1	TEQ-BC.075	71-73
			LRG563	LRG529	RX93.04.006	627.000.01.42	2	TEQ-BC.076	71-73
S3 01/1996 -> 06/1996	Knorr SB/SN7	29108	K003810	SN7198RC	RX91.03.023	0501006297	2	TEQ-BC.004	39-49
			K003809	SN7188RC	RX91.03.024	0501006298	1	TEQ-BC.003	39-49
	Knorr SB/SN7 Radial	29108	K002967	SB7462RC	RX91.03.015	0501005573	4	TEQ-BC.085	39-49
			K002966	SB7452RC	RX91.03.016	0501005574	3	TEQ-BC.086	39-49
S3 07/1996 -> 01/1999, CITIBUS A20 -> 1999	Knorr SB/SN7	29108	K003810	SN7198RC	RX91.03.023	0501006297	2	TEQ-BC.004	39-49
			K003809	SN7188RC	RX91.03.024	0501006298	1	TEQ-BC.003	39-49
	Knorr SB/SN7 Radial	29108	K002963	SB7460RC	RX91.03.051	0501006195	4	TEQ-BC.077	39-49
			K002962	SB7450RC	RX91.03.052	0501006196	3	TEQ-BC.078	39-49
S316HDS, S328DT -> 01/1995	Knorr SB/SN7	29108	K003782	SN7195RC	RX91.03.001	8285516000	1	TEQ-BC.015	39-49
			K003781	SN7185RC	RX91.03.002	8285515000	2	TEQ-BC.005	39-49
TRAVEGO -> 06/1999	Knorr SB/SN7	29108	K003800	SN7211RC	RX91.03.013	6284200701	1	TEQ-BC.009	39-49
			K003799	SN7201RC	RX91.03.014	6284200801	2	TEQ-BC.006	39-49
			K003810	SN7198RC	RX91.03.023	0501006297	3	TEQ-BC.004	39-49
			K003809	SN7188RC	RX91.03.024	0501006298	4	TEQ-BC.003	39-49
0350 Moteur OM402LACH	Meritor D3	29030	LRG532	68032565	RX93.04.007	3564202501	1	TEQ-BC.087	71-73
			LRG533	68032566	RX93.04.008	3564202601	2	TEQ-BC.088	71-73
S315GT GTHD	Meritor D3	29030	LRG562	LRG528	RX93.04.005	8.285.388.529	1	TEQ-BC.075	71-73
			LRG563	LRG529	RX93.04.006	8.285.388.530	2	TEQ-BC.076	71-73

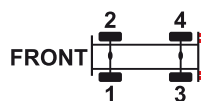

TEQ-BC.003
TEQ-BC.004
TEQ-BC.005



TEQ-BC.009
TEQ-BC.009
TEQ-BC.009



TEQ-BC.075
TEQ-BC.076
TEQ-BC.077
TEQ-BC.078

GIGANT

MODEL	CALIPER TYPE TYP ZACISKU	PADS WVA NO.	X REF	X REF 2	X REF 3	VEH MANUF. REF	SIDE STRONA	INDEX	KIT PAGE
Various Axles 17.5" WHEELS	Knorr SB/SN5	29115	K004573	SN5016RC			1	TEQ-BC.025	21-28
			K004572	SN5006RC			2	TEQ-BC.021	21-28
Various Axles 19.5" WHEELS	Knorr SB/SN6	29094	K013174	SN6580RC	RX91.02.001	9265166	1	TEQ-BC.002	28-39
			K013173	SN6570RC	RX91.02.002	9265165	2	TEQ-BC.001	28-39
	Wabco PAN19-1+	29159	40195003	40195037			1	TEQ-BC.028	78-80
			40195004	40195038			2	TEQ-BC.030	78-80
Various Axles 22.5" WHEELS	Knorr SB/SN7	29108	K003782	SN7195RC	RX91.03.001	9285022	1	TEQ-BC.015	39-49
			K003781	SN7185RC	RX91.03.002	9285023	2	TEQ-BC.005	39-49
			K003804	SN7196RC	RX91.03.003	9285160	1	TEQ-BC.073	39-49
			K003803	SN7186RC	RX91.03.004	9285159	2	TEQ-BC.074	39-49
	Wabco PAN22-1	29162	40225015	40225015			1	TEQ-BC.027	81-83
			40225016	40225016			2	TEQ-BC.023	81-83

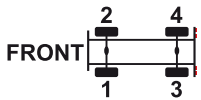

TEQ-BC.005
TEQ-BC.015



TEQ-BC.001
TEQ-BC.002



TEQ-BC.021
TEQ-BC.025



TEQ-BC.028
TEQ-BC.030



TEQ-BC.023
TEQ-BC.027

IKARUS

MODEL	CALIPER TYPE TYP ZACISKU	PADS WVA NO.	X REF	X REF 2	X REF 3	VEH MANUF. REF	SIDE STRONA	INDEX	KIT PAGE
BUS (RABA axle) > 1993	Meritor D3	29030	LRG562	LRG528	RX93.04.005		1	TEQ-BC.075	71-73
			LRG563	LRG529	RX93.04.006		2	TEQ-BC.076	71-73

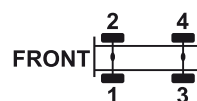

TEQ-BC.075
TEQ-BC.076

IRISBUS

MODEL	CALIPER TYPE TYP ZACISKU	PADS WVA NO.	X REF	X REF 2	X REF 3	VEH MANUF. REF	SIDE STRONA	INDEX	KIT PAGE
AGORA, SCOLER 2, GX117 > 11/1997	Meritor ELSA 1 Radial	29030	LRG642	LRG632	RX93.08.005	LRG752	3	TEQ-BC.091	57-59
			LRG643	LRG633	RX93.08.006	LRG753	4	TEQ-BC.092	57-59
	Meritor D LISA	29043	LRG548	68032310	RX93.05.001		1	TEQ-BC.065	68-70
			LRG549	68032311	RX93.05.002		2	TEQ-BC.048	68-70
AGORA, GX117 from 11/96 to 11/1997 SCOLER AGORA	Meritor D3	29030	LRG526	68033040	RX93.04.003	LRG526	1	TEQ-BC.093	57-59
			LRG527	68033041	RX93.04.004	LRG527	2	TEQ-BC.094	57-59
AGORA, CITELIS, GX327,427,127	Meritor ELSA 2 Radial	29131	LRG745	68033418		LRG745	4	TEQ-BC.106	60-63
			LRG744	68033417		LRG744	3	TEQ-BC.105	60-63
ILIADE ARES RECREO AXER EVADYS, EURO3	Meritor ELSA 2	29131	LRG658	68033192	RX 93.08.021		1	TEQ-BC.095	60-63
			LRG659	68033193	RX93.08.022		2	TEQ-BC.096	60-63
			LRG712	68033252	RX93.09.015		1	TEQ-BC.109	60-63
			LRG713	68033253	RX93.09.016		2	TEQ-BC.110	60-63
CHRONOS CITY BUS (ZF axle 4472035965)	Meritor ELSA 1 Radial	29030	LRG642	LRG632	RX93.08.005	LRG752	1	TEQ-BC.091	57-59
			LRG643	LRG633	RX93.08.006	LRG753	2	TEQ-BC.092	57-59
CRONUS > 10/1998	Meritor ELSA 1 Radial	29030	LRG642	LRG632	RX93.08.005	LRG752	3	TEQ-BC.091	57-59
			LRG643	LRG633	RX93.08.006	LRG753	4	TEQ-BC.092	57-59
CRONUS CITY BUS (ZF axle 4472035965)	Meritor ELSA 1 Radial	29030	LRG752	LRG642	RX93.08.005		1	TEQ-BC.091	57-59
			LRG753	LRG643	RX93.08.006		2	TEQ-BC.092	57-59
	Meritor ELSA 2	29131	LRG712	68033190			1	TEQ-BC.109	60-63
			LRG713	68033191			2	TEQ-BC.110	60-63
IRISBUS	Meritor ELSA 2	29131	LRG664	68033249	68 032 978		1	TEQ-BC.111	60-63
			LRG665	68033250	68032978		2	TEQ-BC.112	60-63
	Meritor ELSA225		LRG756	68033954		504115353	1	TEQ-BC.125	60-63
			LRG757	68033955		504115354	2	TEQ-BC.126	60-63
ARWAY CROSSWAY EVADYS	Meritor ELSA 2	29131	LRG658	68033254	RX 93.08.021	LRG658	1	TEQ-BC.095	60-63
			LRG659	68033255	RX93.08.022	LRG659	2	TEQ-BC.096	60-63
ILIADE ARES >05/0	Meritor ELSA 2	29131	LRG664	68033249	RX93.09.025	LRG664	4	TEQ-BC.111	60-63
			LRG665	68033250	RX93.09.026	LRG665	3	TEQ-BC.112	60-63
RECREO ANCIEN MONTAGE	Meritor ELSA 2	29131	LRG724	68033247	RX93.08.029		1	TEQ-BC.127	60-63
			LRG725	68033248	RX93.08.030		2	TEQ-BC.128	60-63
OREOS	Meritor C LISA	29100	LRG554	68033085	RX93.05.005		1	TEQ-BC.061	68-70
			LRG555	68033086	RX93.05.006		2	TEQ-BC.097	68-70



TEQ-BC.048
TEQ-BC.065



TEQ-BC.091
TEQ-BC.092
TEQ-BC.109
TEQ-BC.110



TEQ-BC.093
TEQ-BC.094



TEQ-BC.105
TEQ-BC.106



TEQ-BC.095
TEQ-BC.096
TEQ-BC.109
TEQ-BC.110



TEQ-BC.112
TEQ-BC.127
TEQ-BC.128

TEQ-BC.061
TEQ-BC.097

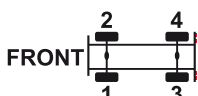

IVECO

MODEL	CALIPER TYPE TYP ZACISKU	PADS WVA NO.	X REF	X REF 2	X REF 3	VEH MANUF. REF	SIDE STRONA	INDEX	KIT PAGE
Eurocargo 110E, 120E 1999 ->	Wabco PAN17	29088	40175058	40175072		500328232	1	TEQ-BC.037	75-77
			40175059	40175073		500328234	2	TEQ-BC.051	75-77
Eurocargo 120E, 130E, 260E -> 2001	Bendix ADB3700	29032	131790			98479613	1	TEQ-BC.129	-
			131791			98479614	2	TEQ-BC.130	-
Eurocargo 130E, 150E Tector	Knorr SB/SN6	29094	K013174	SN6580RC	RX91.02.001	500363442	2 4	TEQ-BC.002	29-38
			K013173	SN6570RC	RX91.02.002	500363443	1 3	TEQ-BC.001	29-38
Eurocargo 150E, 280E, 320E -> 2001	Bendix ADB3700	29032	131776			98479590	1	TEQ-BC.191	-
			131777			98479591	2	TEQ-BC.192	-
Stralis	Knorr SB/SN7	29108	K013160	SN7289RC	RX91.03.113	41211270	1 3	TEQ-BC.133	39-49
			K013161	SN7299RC	RX91.03.114	41211269	2 4	TEQ-BC.134	39-49
Supercargo Eurostar, Eurotech -> 1997	Knorr SB/SN7	29087	K000412	SB7411RC		98479590	1	TEQ-BC.131	39-49
			K000413	SB7401RC		98479591	2	TEQ-BC.132	39-49
			K003782	SN7195RC	RX91.03.001	41211288	1	TEQ-BC.015	39-49
			K003781	SN7185RC	RX91.03.002	41211289	2	TEQ-BC.005	39-49
			K003800	SN7211RC	RX91.03.013	41033392	3	TEQ-BC.009	39-49
Eurocargo 120E, 130E, 150E -> 2001	Knorr SB/SN6	29094	K013174	SN6580RC	RX91.02.001	500363442	2	TEQ-BC.002	29-38
			K013173	SN6570RC	RX91.02.002	500363443	1	TEQ-BC.001	29-38
EUROCARGO 60E, 65E, 75E ->1995	Brembo	29122	122.5760.08			42534119	1	TEQ-BC.046	-
			122.5760.09			42534120	2	TEQ-BC.040	-
			122.5770.16			42534121	3	TEQ-BC.017	-
			122.5770.26			42534122	4	TEQ-BC.014	-
EUROCARGO 80E, 100E, 180E ->1995	Brembo	29067	122.5660.08			42534115	1	TEQ-BC.135	-
			122.5660.09			42534116	2	TEQ-BC.136	-
			122.5670.08			42534117	3	TEQ-BC.011	-
			122.5670.09			42534118	4	TEQ-BC.012	-
EUROCARGO 65C15	Brembo	29160				42548184	2	TEQ-BC.029	-
						42548183	1	TEQ-BC.032	-



TEQ-BC.001
TEQ-BC.002



TEQ-BC.037
TEQ-BC.051



TEQ-BC.040
TEQ-BC.046



TEQ-BC.014
TEQ-BC.017



TEQ-BC.005
TEQ-BC.006
TEQ-BC.009
TEQ-BC.015
TEQ-BC.131



TEQ-BC.129
TEQ-BC.130



TEQ-BC.029
TEQ-BC.032



TEQ-BC.011
TEQ-BC.012

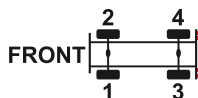

KAROSA

MODEL	CALIPER TYPE TYP ZACISKU	PADS WVA NO.	X REF	X REF 2	X REF 3	VEH MANUF. REF	SIDE STRONA	INDEX	KIT PAGE
KAROSA	Meritor ELSA 2	29131	LRG658	68033192	RX93.08.021		3	TEQ-BC.095	60-63
			LRG659	68033193	RX93.08.022		4	TEQ-BC.096	60-63

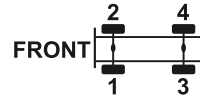

TEQ-BC.095
TEQ-BC.096



KASBOHRER

MODEL	CALIPER TYPE TYP ZACISKU	PADS WVA NO.	X REF	X REF 2	X REF 3	VEH MANUF. REF	SIDE STRONA	INDEX	KIT PAGE
SETRA CITY BUS S215HDH S215NR S300NC S315HD	Meritor D3	29030	LRG528	LRG562	RX93.04.005		1	TEQ-BC.075	71-73
			LRG529	LRG563	RX93.04.006		2	TEQ-BC.076	71-73

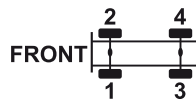

TEQ-BC.075



TEQ-BC.076

LECINENA

MODEL	CALIPER TYPE TYP ZACISKU	PADS WVA NO.	X REF	X REF 2	X REF 3	VEH MANUF. REF	SIDE STRONA	INDEX	KIT PAGE
Lecinena Axle, 19.5" Wheels -> 01/1998	Knorr SB/SN6	29094	K013174	SN6580RC	RX91.02.001	412017	1	TEQ-BC.002	29-38
			K013173	SN6570RC	RX91.02.002	412018	2	TEQ-BC.001	29-38
Lecinena Axle, 22.5" Wheels -> 01/1998	Knorr SB/SN7	29108	K003804	SN7196RC	RX91.03.003	412023	1	TEQ-BC.073	39-49
			K003803	SN7186RC	RX91.03.004	412024	2	TEQ-BC.074	39-49

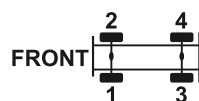

TEQ-BC.001
TEQ-BC.002



TEQ-BC.073
TEQ-BC.074

MAN

MODEL	CALIPER TYPE TYP ZACISKU	PADS WVA NO.	X REF	X REF 2	X REF 3	VEH MANUF. REF	SIDE STRONA	INDEX	KIT PAGE
14T HOCL TAP A66 -> 1998	Knorr SB/SN6	29094	K013174	SN6580RC	RX91.02.001	81508046057	1	TEQ-BC.002	29-38
			K013173	SN6570RC	RX91.02.002	81508046056	2	TEQ-BC.001	29-38
A13, A32, A33, A01, A03, A04 -> 1999	Meritor ELSA 1	29030	LRG704	68032816	RX93.08.009		1	TEQ-BC.098	57-59
			LRG705	68032817	RX93.08.010		2	TEQ-BC.099	57-59
City Bus A91 03/04 ->	Meritor ELSA 2	29131	LRG722	68033427		81508046389	1	TEQ-BC.113	60-63
			LRG723	68033428		81508046390	2	TEQ-BC.114	60-63
City Bus 1995 -> 4 Bolt Fixing	Meritor D3	29030	LRG524	68032144	RX93.04.001	81508046063	1	TEQ-BC.100	71-73
			LRG525	68032145	RX93.04.002	81508046064	2	TEQ-BC.101	71-73
City Bus 1999 ->	Meritor ELSA 1	29030	LRG574	68032578	RX93.08.015	81508046197	1	TEQ-BC.137	68-70
			LRG575	68032579	RX93.08.016	81508046198	2	TEQ-BC.138	68-70
CITYBUS A25, A26, A30, A35 05/2001 - 09/2002	Meritor ELSA 1	29030	LRG704	68032816	RX93.08.009		1	TEQ-BC.098	68-70
			LRG705	68032817	RX93.08.010		2	TEQ-BC.099	68-70
	Meritor ELSA 1 Radial	29030	LRG542	68032830	RX93.08.013	81508046257	3	TEQ-BC.139	68-70
			LRG543	68032831	RX93.08.014	81508046256	4	TEQ-BC.140	68-70
F2000 + F90 1994 -> 1996 4 Bolt Fixing	Meritor D3	29030	LRG524	68032144	RX93.04.001	81508046063	1	TEQ-BC.100	71-73
			LRG525	68032145	RX93.04.002	81508046064	2	TEQ-BC.101	71-73
F2000 1996 > 2002 6 Bolt Fixing/ Lions Range - City Bus 1995 -> 6 Bolt Fixing	Meritor ELSA 1	29030	LRG570	68032358	RX93.08.001	81508046065	1	TEQ-BC.045	57-59
			LRG571	68032359	RX93.08.002	81508046066	2	TEQ-BC.079	57-59
F2000 2002 ->	Meritor ELSA 2	29131	LRG546	68033351		81508046341	1	TEQ-BC.141	60-63
			LRG547	68033352		81508046340	2	TEQ-BC.142	60-63
L2000 Series 1996 ->	Wabco PAN17	29088	40175049			81508049087	1 3	TEQ-BC.008	75-77
			40175050			81508049088	2 4	TEQ-BC.007	75-77



MAN

MODEL	CALIPER TYPE TYP ZACISKU	PADS WVA NO.	X REF	X REF 2	X REF 3	VEH MANUF. REF	SIDE STRONA	INDEX	KIT PAGE
M2000 Series	Knorr SB/SN6	29093	K013174	SN6580RC	RX91.02.001	81508046057	1	TEQ-BC.002	29-38
			K013173	SN6570RC	RX91.02.002	81508046056	2	TEQ-BC.001	29-38
Man truck	Knorr SB/SN7	29108	K003816	SN7219RC	RX91.03.029	81508046409	1	TEQ-BC.054	39-49
			K003815	SN7209RC	RX91.03.030	81508046410	2	TEQ-BC.042	39-49
REISEBUS BVA 04/01 – 09/02 A13 BVA 07/99 - 09/02 A32 BVA -> 1999	Meritor ELSA 1	29030	LRG590	68032822	RX93.08.011		1	TEQ-BC.143	57-59
			LRG591	68032823	RX93.08.012		2	TEQ-BC.144	57-59
TGA - H02,05,09,12,17,20,23 22.5" Wheels 1999 -> 02	Meritor ELSA 1	29030	LRG586	68032780	RX93.08.017	81508046271	1	TEQ-BC.145	57-59
			LRG587	68032781	RX93.08.018	81508046270	2	TEQ-BC.146	57-59
			LRG588	68032621	RX93.08.003	81508046042	3	TEQ-BC.066	57-59
			LRG589	68032622	RX93.08.004	81508046043	4	TEQ-BC.053	57-59
TGA – H12, 17 22.5" Wheels 2001 ->	Meritor ELSA 2	29131	LRG544	68033089		81508046319	1	TEQ-BC.081	60-63
			LRG545	68033090		81508046320	2	TEQ-BC.082	60-63
			LRG638	68033087		81508046321	3	TEQ-BC.083	60-63
			LRG639	68033088		81508046322	4	TEQ-BC.084	60-63
			LRG638	68033087		81508046321	4	TEQ-BC.083	60-63
			LRG639	68033088		81508046322	3	TEQ-BC.084	60-63
TGA 04/2001 <-	Knorr SB/SN7	29108	K003810	SN7198RC	RX91.03.023	81508046441	1 3	TEQ-BC.004	39-49
			K003809	SN7188RC	RX91.03.024	81508046440	2 4	TEQ-BC.003	39-49
FH322, 422,LIONSTAR	Meritor ELSA 1	29030	LRG570	68032792	RX93.08.001	81508046081	1	TEQ-BC.045	57-59
			LRG571	68032793	RX93.08.002	81508046082	2	TEQ-BC.079	57-59
MAN TGX, TGS	Wabco MAXX22	29279				81508046579	1	TEQ-BC.201	84-86
						81508046578	2	TEQ-BC.202	84-86
						81508046583	3	TEQ-BC.203	84-86
						81508046582	4	TEQ-BC.204	84-86

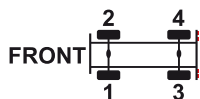
 TEQ-BC.003
 TEQ-BC.004
 TEQ-BC.042
 TEQ-BC.054

 TEQ-BC.001
 TEQ-BC.002

 TEQ-BC.143
 TEQ-BC.144
 TEQ-BC.145
 TEQ-BC.146
 TEQ-BC.053

 TEQ-BC.066
 TEQ-BC.045
 TEQ-BC.079

 TEQ-BC.081
 TEQ-BC.082
 TEQ-BC.083
 TEQ-BC.084

 TEQ-BC.100
 TEQ-BC.101

MERCEDES

MODEL	CALIPER TYPE TYP ZACISKU	PADS WVA NO.	X REF	X REF 2	X REF 3	VEH MANUF. REF	SIDE STRONA	INDEX	KIT PAGE
Mercedes Discos	Knorr SB/SN7	29108	K003782	SN7195RC	RX91.03.001	A9424202501	1	TEQ-BC.015	39-49
			K003781	SN7185RC	RX91.03.002	A9424202601	2	TEQ-BC.005	39-49
0404	Meritor D3	29030	LRG562	LRG528	RX93.04.005		1	TEQ-BC.075	39-49
			LRG563	LRG529	RX93.04.006		2	TEQ-BC.076	39-49
Actros 1995 -> Atego 2001 -> Axor 1998 -> (22.5" Wheels)	Knorr SB/SN7	29108	K003800	SN7211RC	RX91.03.013		1 3	TEQ-BC.009	39-49
			K003799	SN7201RC	RX91.03.014		2 4	TEQ-BC.006	39-49
Atego 712,715,812,817,832, 917, 925, 1017, 1023 (17.5")	Knorr SB/SN5	29115	K004573	SN5016RC		9704200401	1 3	TEQ-BC.025	21-28
			K004572	SN5006RC		9704200501	2 4	TEQ-BC.021	21-28
Atego models 1220 - 1528 (19.5" Wheels) [FRONT WITH EBS]	Knorr SB/SN6	29197	K013174	SN6580RC	RX91.02.001		2 4	TEQ-BC.002	29-38
			K013173	SN6570RC	RX91.02.002		1 3	TEQ-BC.001	29-38
Atego models 1220 - 1528 (19.5")	Knorr SB/SN6	29197	K003794	SN 6567RC			2	TEQ-BC.047	29-38
			K003793	SN 6557RC			1	TEQ-BC.044	29-38
Citaro, Cito	Knorr SB/SN7 Radial	29108	K002965	SB7461RC	RX91.03.053	A0104218898	3	TEQ-BC.039	39-49
			K002964	SB7451RC	RX91.03.054	A0104218998	4	TEQ-BC.055	39-49
Cito	Knorr SB/SN7	29108	K003810	SN7198RC	RX91.03.023	A6664300090	3	TEQ-BC.004	39-49
			K003809	SN7188RC	RX91.03.024	A6664300190	4	TEQ-BC.003	39-49
Citaro 0530	Knorr SB/SN7	29108	K003800	SN7211RC	RX91.03.013	A9424202701	1	TEQ-BC.009	39-49
			K003799	SN7201RC	RX91.03.014	A9424203401	2	TEQ-BC.006	39-49
	Knorr SB/SN7 Radial	29108	K002965	SB7461RC	RX91.03.053	A0501007172	4	TEQ-BC.039	39-49
			K002964	SB7451RC	RX91.03.054	A0501007173	3	TEQ-BC.055	39-49

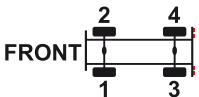

TEQ-BC.003
TEQ-BC.004
TEQ-BC.005
TEQ-BC.006



TEQ-BC.001
TEQ-BC.002



TEQ-BC.039
TEQ-BC.055



TEQ-BC.021
TEQ-BC.025



TEQ-BC.075

MERCEDES

MODEL	CALIPER TYPE TYP ZACISKU	PADS WVA NO.	X REF	X REF 2	X REF 3	VEH MANUF. REF	SIDE STRONA	INDEX	KIT PAGE
Omnibus 0350, 0403, 0404	Meritor D3	29030	LRG532	68032174	RX93.04.007	3564202501	1	TEQ-BC.087	71-73
			LRG533	68032175	RX93.04.008	3564202601	2	TEQ-BC.088	71-73
			LRG622	68032176	RX93.04.011	3564202801	3	TEQ-BC.147	71-73
			LRG623	68032177	RX93.04.012	3564202901	4	TEQ-BC.148	71-73
POWERSYSTEMS AXLE 19.5" Wheels -> 01/1997	Knorr SB/SN6	29094	K013174	SN6580RC	RX91.02.001	9754200801	1	TEQ-BC.002	29-38
			K013173	SN6570RC	RX91.02.002	9754200701	2	TEQ-BC.001	29-38
POWERSYSTEMS AXLE 22.5" Wheels -> 01/1997	Knorr SB/SN7	29108	K003782	SN7195RC	RX91.03.001	9424203301	1	TEQ-BC.015	39-49
			K003781	SN7185RC	RX91.03.002	9444203201	2	TEQ-BC.005	39-49
TOURINO	Knorr SB/SN6	29094	K013175	SN6557	RX91.02.016	A9704203501	1	TEQ-BC.033	29-38
			K013176	SN6567	RX91.02.015	A9704203601	2	TEQ-BC.013	29-38
S315NF, SOLARIS, CITARO	Knorr SB Radial		K002965	SB7461RC	RX91.03.053	8919800521	3	TEQ-BC.039	39-49
			K002964	SB7451RC	RX91.03.054	8919800522	4	TEQ-BC.055	39-49
EURO3,315,0550 TRAVEGO	Knorr SB/SN7	29108	K002798	SB7432	RX91.03.045	A0024207183	3	TEQ-BC.149	39-49
			K002797	SB7422	RX91.03.046	A0024207283	4	TEQ-BC.150	39-49
VARIO 609, 612D, 614D, 709, 809 (16" WHEELS) 1996 ->	MERITOR	29835	LRG510			6694203001	1	TEQ-BC.151	50
			LRG511			6694203101	2	TEQ-BC.152	50
			LRG624			6704206001	3	TEQ-BC.026	50
			LRG625			6704206101	4	TEQ-BC.022	50
VARIO 809, 812D, 814D, 811, 814 (17,5" WHEELS) 1996 ->	MERITOR	29835	LRG520			6704205401	1	TEQ-BC.153	50
			LRG521			6704205501	2	TEQ-BC.064	50
			LRG626			6704206301	3	TEQ-BC.018	50
			LRG627			6704206401	4	TEQ-BC.010	50



TEQ-BC.005
TEQ-BC.015



TEQ-BC.001
TEQ-BC.002



TEQ-BC.151
TEQ-BC.152



TEQ-BC.087
TEQ-BC.088



TEQ-BC.147
TEQ-BC.148

TEQ-BC.039
TEQ-BC.055

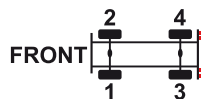

TEQ-BC.022
TEQ-BC.026



TEQ-BC.064
TEQ-BC.153



TEQ-BC.010
TEQ-BC.018

NEOPLAN

MODEL	CALIPER TYPE TYP ZACISKU	PADS WVA NO.	X REF	X REF 2	X REF 3	VEH MANUF. REF	SIDE STRONA	INDEX	KIT PAGE
Centroliner (3 Axles) Axial	Knorr SB/SN7	29108	K003804	SN7196RC	RX91.03.003	0501005859	3	TEQ-BC.073	39-49
			K003803	SN7186RC	RX91.03.004	0501005860	4	TEQ-BC.074	39-49
Centroliner (3 Axles) Radialial	Knorr SB/SN7 Radial	29108	K002963	SB7460RC	RX91.03.051	11014147	3	TEQ-BC.077	39-49
			K002962	SB7450RC	RX91.03.052	11014148	4	TEQ-BC.078	39-49
Centroliner, Cityliner, Skyliner, Starliner, Transliner	Knorr SB/SN7 Radial	29108	K002963	SB7460RC	RX91.03.051	11014147	4	TEQ-BC.077	39-49
			K002962	SB7450RC	RX91.03.052	11014148	3	TEQ-BC.078	39-49
	Knorr SB/SN7	29108	K003810	SN7198RC	RX91.03.023		1	TEQ-BC.004	39-49
			K003809	SN7188RC	RX91.03.024		2	TEQ-BC.003	39-49
			K003804	SN7196RC	RX91.03.003	0501005859	1 3	TEQ-BC.073	39-49
			K003803	SN7186RC	RX91.03.004	0501005860	2 4	TEQ-BC.074	39-49
Clubstar	Knorr SB/SN6	29093	K013175	SN6568RC	RX91.02.016		2	TEQ-BC.033	29-38
			K013176	SN6558RC	RX91.02.015		1	TEQ-BC.013	29-38
Linienbus (3 Axles) Radialial	Knorr SB/SN7 Radial	29108	K002963	SB7460RC	RX91.03.051	11014147	3	TEQ-BC.077	39-49
			K002962	SB7450RC	RX91.03.052	11014148	4	TEQ-BC.078	39-49
Various Axles 22.5" Wheels	Knorr SB/SN7	29108	K003804	SN7196RC	RX91.03.003	0501005859	2 4	TEQ-BC.073	39-49
			K003803	SN7186RC	RX91.03.004	0501005860	1 3	TEQ-BC.074	39-49
	Knorr SB/SN7 Radial	29108	K002967	SB7462RC	RX91.03.015		2	TEQ-BC.085	39-49
			K002966	SB7452RC	RX91.03.016		1	TEQ-BC.086	39-49
	Knorr SB/SN7	29108	K003810	SN7198RC	RX91.03.023		2	TEQ-BC.004	39-49
			K003809	SN7188RC	RX91.03.024		1	TEQ-BC.003	39-49
	Knorr SB/SN7 Radial	29108	K002963	SB7460RC	RX91.03.051	11014147	2	TEQ-BC.077	39-49
			K002962	SB7450RC	RX91.03.052	11014148	1	TEQ-BC.078	39-49
			K002965	SB7461RC	RX91.03.053	A0104218898	1	TEQ-BC.039	39-49
			K002964	SB7451RC	RX91.03.054	A0104218998	2	TEQ-BC.055	39-49

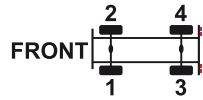

TEQ-BC.003
TEQ-BC.004
TEQ-BC.073



TEQ-BC.013
TEQ-BC.033



TEQ-BC.039
TEQ-BC.055
TEQ-BC.077

TEQ-BC.074
TEQ-BC.077
TEQ-BC.085
TEQ-BC.086

ROR

MODEL	CALIPER TYPE TYP ZACISKU	PADS WVA NO.	X REF	X REF 2	X REF 3	VEH MANUF. REF	SIDE STRONA	INDEX	KIT PAGE
L M Series, T M Series	Meritor DX195	29124	15224836SR	DX195.51	RX93.07.001		1	TEQ-BC.036	51-53
			15224837SR	DX195.52	RX93.07.002		2	TEQ-BC.072	51-53
L M Series T M Series 18 mm 2000 -> 2002	Meritor D DUCO	29125	LRG578	68033331	RX93.06.001	68324553	1	TEQ-BC.154	64-67
			LRG579	68033332	RX93.06.002	68324553	2	TEQ-BC.155	64-67
L M Series T M Series 19.5" Wheels 2003 ->	Meritor ELSA195	29177	LRG702	68033360	RX93.07.005	68033360	1	TEQ-BC.156	54-56
			LRG703	68033359	RX93.07.006	68033359	2	TEQ-BC.157	54-56
L M Series T M Series 20mm 2000 -> 2002	Meritor D DUCO	29125	LRG536	LRG652	RX93.06.017	68033073	1	TEQ-BC.068	64-67
			LRG537	LRG653	RX93.06.018	68033074	2	TEQ-BC.104	64-67
L M Series T M Series 22.5" Wheels	Meritor ELSA 2	29131	LRG572	68033353		68033353	1	TEQ-BC.158	60-63
			LRG573	68033354		68033354	2	TEQ-BC.159	60-63
LM TA 2000 - 2002	Meritor D DUCO	29125	LRG652	LRG536	RX93.06.017	68033073	1	TEQ-BC.068	64-67
			LRG653	LRG537	RX93.06.018	68033074	2	TEQ-BC.104	64-67
ROR	Meritor ELSA225		LRG764	68034032			1	TEQ-BC.067	54-56
			LRG765	68034033			2	TEQ-BC.160	54-56



TEQ-BC.158
TEQ-BC.159



TEQ-BC.036
TEQ-BC.072



TEQ-BC.068
TEQ-BC.104



TEQ-BC.154
TEQ-BC.155



TEQ-BC.067
TEQ-BC.156
TEQ-BC.160

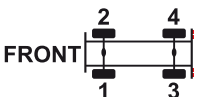

TEQ-BC.068
TEQ-BC.104

RENAULT – R.V.I

MODEL	CALIPER TYPE TYP ZACISKU	PADS WVA NO.	X REF	X REF 2	X REF 3	VEH MANUF. REF	SIDE STRONA	INDEX	KIT PAGE
AGORA -> 11/1997	Meritor D LISA	29090	LRG548	68032310	RX93.05.001	50102600004	1	TEQ-BC.065	
			LRG549	68032311	RX93.05.002	50102600005	2	TEQ-BC.048	
	Meritor ELSA 1 Radial	29030	LRG642	LRG632	RX93.08.005	501007471	3	TEQ-BC.091	
			LRG643	LRG633	RX93.08.006	501007472	4	TEQ-BC.092	
ARES	Meritor ELSA 2	29131	LRG658	68033192		504287479	1	TEQ-BC.095	60-63
			LRG659	68033193		504287480	2	TEQ-BC.096	60-63
Magnum AE520 1997 -> Premium 1997 -> Magnum 1997 -> 2001 Premium 1997 -> 2001	Meritor D LISA	29090	LRG548	68032310	RX93.05.001	50102600004	1	TEQ-BC.065	
			LRG549	68032311	RX93.05.002	50102600005	2	TEQ-BC.048	
Magnum, Premium 2000 -> 2002	Meritor ELSA 2	29131	LRG580	68032901		5010422983	1	TEQ-BC.161	60-63
			LRG581	68032902		5010422984	2	TEQ-BC.162	60-63
Magnum, Premium AE385 AE420, AE520, AE550 1993->	Meritor D3	29030	LRG526	68032146	RX93.04.003	5010260444	1	TEQ-BC.093	71-73
			LRG527	68032147	RX93.04.004	5010260445	2	TEQ-BC.094	71-73
Major R380, R380i	Meritor D2	29043	LRG522	68032046	RX93.03.001	5010216587	1	TEQ-BC.163	-
			LRG523	68032047	RX93.03.002	5010216588	2	TEQ-BC.164	-
Midlum 14T – 16T 2001 ->	Wabco PAN19 - 2	29142	40195021		5010525012		1 3	TEQ-BC.165	87-89
			40195022		5010525013		2 4	TEQ-BC.166	87-89
Midlum 19.5" Wheels 2000 ->	Meritor C LISA	29100	LRG554	68032334	RX93.05.005	5010845383	1	TEQ-BC.061	68-70
			LRG555	68032335	RX93.05.006	5010845384	2	TEQ-BC.097	68-70
Midlum 7.5T – 12T	Wabco PAN17	29088	40175064			5001852882	1 3	TEQ-BC.037	75-77
			40175065			5001852883	2 4	TEQ-BC.051	75-77
Premium 22.5" Wheels 2002 ->	Meritor ELSA 2	29131	LRG646	68033172		68033188	3	TEQ-BC.167	60-63
			LRG647	68033173		68033189	4	TEQ-BC.168	60-63
			LRG700	68033166		5010525479	1	TEQ-BC.169	60-63
			LRG701	68033167		5010525480	2	TEQ-BC.062	60-63
Premium, 22.5" Wheels Magnum AE range 2000 -> 02	Meritor ELSA 2	29131	LRG582	68032907		5010422987	3	TEQ-BC.070	60-63
			LRG583	68032908		5010422988	4	TEQ-BC.069	60-63
R312	Brembo double DISC		20532012			5010207432	1	TEQ-BC.170	-
			20532022			5010207433	2	TEQ-BC.171	-
			20532032			5010207434	3	TEQ-BC.172	-
			20532042			5010207435	4	TEQ-BC.173	-
Midliner S160, S180 17.5" Wheels 1992->	Meritor	29065	LRG518			5010098109	1	TEQ-BC.071	50
			LRG519			5010098110	2	TEQ-BC.174	50



TEQ-BC.091
TEQ-BC.092



TEQ-BC.048
TEQ-BC.065



TEQ-BC.093
TEQ-BC.094



TEQ-BC.095
TEQ-BC.096
TEQ-BC.161



TEQ-BC.162

TEQ-BC.163
TEQ-BC.164



TEQ-BC.165
TEQ-BC.166



TEQ-BC.037
TEQ-BC.051



TEQ-BC.062
TEQ-BC.069
TEQ-BC.070



TEQ-BC.167
TEQ-BC.168
TEQ-BC.169



TEQ-BC.097
TEQ-BC.170
TEQ-BC.171



TEQ-BC.172
TEQ-BC.173
TEQ-BC.071
TEQ-BC.174

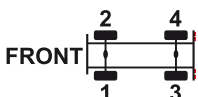

SAE

MODEL	CALIPER TYPE TYP ZACISKU	PADS WVA NO.	X REF	X REF 2	X REF 3	VEH MANUF. REF	SIDE STRONA	INDEX	KIT PAGE
Various Axles 17.5" Wheels	Knorr SB/SN5	29115	K004573	SN5016RC		A9704201101	1	TEQ-BC.025	21-28
			K004572	SN5006RC		A9704201201	2	TEQ-BC.021	21-28
Various Axles 19.5" Wheels	Knorr SB/SN6	29094	K013174	SN6580RC	RX91.02.001		2	TEQ-BC.002	29-38
			K013173	SN6570RC	RX91.02.002		1	TEQ-BC.001	29-38
	Wabco PAN19-1+	29159	40195003	40195037			1	TEQ-BC.028	78-80
			40195004	40195038			2	TEQ-BC.030	78-80
Various Axles 22.5" Wheels	Knorr SB/SN7	29108	K003782	SN7195RC	RX91.03.001		1	TEQ-BC.015	39-49
			K003781	SN7185RC	RX91.03.002		2	TEQ-BC.005	39-49
			K003804	SN7196RC	RX91.03.003		1	TEQ-BC.073	39-49
			K003803	SN7186RC	RX91.03.004		2	TEQ-BC.074	39-49
	Wabco PAN22-1	29162	40225015				1	TEQ-BC.027	81-83
			40225016				2	TEQ-BC.023	81-83

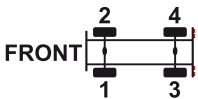

TEQ-BC.005
TEQ-BC.015
TEQ-BC.073



TEQ-BC.001
TEQ-BC.002



TEQ-BC.021
TEQ-BC.025



TEQ-BC.028
TEQ-BC.030



TEQ-BC.023
TEQ-BC.027

SAF

MODEL	CALIPER TYPE TYP ZACISKU	PADS WVA NO.	X REF	X REF 2	X REF 3	VEH MANUF. REF	SIDE STRONA	INDEX	KIT PAGE
SK RB 9019	Wabco PAN19-1+	29159	40195003	40195037		3080001901		TEQ-BC.028	78-80
			40195004	40195038		3080001801		TEQ-BC.030	78-80
SK RB 9022	Knorr SB/SN7	29143	K003782	SN7195RC	RX91.03.001	3080002701	1	TEQ-BC.015	39-49
			K003781	SN7185RC	RX91.03.002	3080002601	2	TEQ-BC.005	39-49
SK RB 9022, SK RS 11222 SK RS 9022, SK RZ 11222	Wabco PAN22-1	29162	40225015			4080005100	1	TEQ-BC.027	81-83
			40225016			4080005000	2	TEQ-BC.023	81-83
SK RS 9019, SK RS 11019 SK RZ 9019, SK RZ 11019	Knorr SB/SN6	29094	K013174	SN6580RC	RX91.02.001	3080000703	1	TEQ-BC.002	29-38
			K013173	SN6570RC	RX91.02.002	3080000603	2	TEQ-BC.001	29-38
SK RS 9022, SK RS 11222 SK RZ 9022, SK RZ 11222	Knorr SB/SN7	29108	K003804	SN7196RC	RX91.03.003	0536270391	1	TEQ-BC.073	39-49
			K003803	SN7186RC	RX91.03.004	0536270381	2	TEQ-BC.074	39-49
SBS2220 DBT22LT	Haldex ModulT	29274	3080008100	94619			1	TEQ-BC.197	95-97
			3080008200	94618			2	TEQ-BC.198	95-97
Various Axles 19,5" Wheels DB19	Haldex ModulX	29143	92559	92560	RX94.02.002		1 2	TEQ-BC.199	99-102

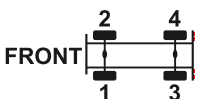

TEQ-BC.005
TEQ-BC.015
TEQ-BC.073



TEQ-BC.001
TEQ-BC.002



TEQ-BC.028
TEQ-BC.030



TEQ-BC.023
TEQ-BC.027

SCANIA

MODEL	CALIPER TYPE TYP ZACISKU	PADS WVA NO.	X REF	X REF 2	X REF 3	VEH MANUF. REF	SIDE STRONA	INDEX	KIT PAGE
Series 4 Bus	Knorr SB/SN7	29108	K003804	SB7888		1473364	2 4	TEQ-BC.073	39-49
			K003803	SB7898		1473365	1 3	TEQ-BC.074	39-49
Series 4 truck & bus (screw sensor)	Knorr SB/SN7	29108	K003810	SB7586		1365719	2 4	TEQ-BC.221	39-49
			K003809	SB7596		1365720	1 3	TEQ-BC.222	39-49
Series 4 Bus	Knorr SB/SN7 Radial	29108	K002963	SB7460RC	RX91.03.051	658517/34	3	TEQ-BC.077	39-49
			K002962	SB7450RC	RX91.03.052	658517/33	4	TEQ-BC.078	39-49
Series 4 truck & bus (clip sensor)	Knorr SB/SN7	29108	K003814	SN7218RC	RX91.03.123	1513588	2	TEQ-BC.038	39-49
			K003813	SN7208RC	RX91.03.124	1513589	1	TEQ-BC.041	39-49

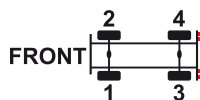

TEQ-BC.003
TEQ-BC.004
TEQ-BC.073



TEQ-BC.074
TEQ-BC.102
TEQ-BC.103

TEQ-BC.077
TEQ-BC.078

SMB

MODEL	CALIPER TYPE TYP ZACISKU	PADS WVA NO.	X REF	X REF 2	X REF 3	VEH MANUF. REF	SIDE STRONA	INDEX	KIT PAGE
SMB Trailer Axle	WABCO PAN19-1+	29159	40195003	40195037		3080003300	1	TEQ-BC.028	78-80
			40195004	40195038		3080003200	2	TEQ-BC.030	78-80
SMB Trailer Axle 19.5" Wheels	Knorr SB/SN6	29094	K013174	SN6580RC	RX91.02.001	20017702	1	TEQ-BC.002	29-38
			K013173	SN6570RC	RX91.02.002	20017701	2	TEQ-BC.001	29-38
SMB Trailer Axle 22.5" Wheels	WABCO PAN22-2	29059	40225003			M070008	2	TEQ-BC.175	87-89
			40225004			M069999	1	TEQ-BC.176	87-89
SMB Trailer Axle No EBS Sensor	Knorr SB/SN7	29108	K003782	SN7195RC	RX91.03.001	M20012402	1	TEQ-BC.015	39-49
			K003781	SN7185RC	RX91.03.002	M20012401	2	TEQ-BC.005	39-49
SMB Trailer Axle With EBS Sensor	Knorr SB/SN7	29108	K003800	SN7211RC	RX91.03.013		1	TEQ-BC.009	39-49
			K003799	SN7201RC	RX91.03.014		2	TEQ-BC.006	39-49
Series 4 truck & bus (clip sensor)	Knorr SB/SN7	29108	K003814	SN7218RC	RX91.03.123	1513588	1	TEQ-BC.102	39-49
			K003813	SN7208RC	RX91.03.124	1513589	2	TEQ-BC.103	39-49
Various Axles 22,5" Wheels DB22	Haldex ModulX	29143	93839	92779			1 2	TEQ-BC.200	99-102

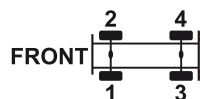

TEQ-BC.005
TEQ-BC.006
TEQ-BC.009
TEQ-BC.015



TEQ-BC.001
TEQ-BC.002



TEQ-BC.028
TEQ-BC.030

VAN HOOL

MODEL	CALIPER TYPE TYP ZACISKU	PADS WVA NO.	X REF	X REF 2	X REF 3	VEH MANUF. REF	SIDE STRONA	INDEX	KIT PAGE
BUS A320	Meritor ELSA 1 Radial	29030	LRG642	LRG632	RX93.08.005	LRG752	3	TEQ-BC.091	57-59
			LRG643	LRG633	RX93.08.006	LRG753	4	TEQ-BC.092	57-59
„COACH & INTERCITY 913CL, 9158CL, 915CL, T911/16/17/18/24/27“	Meritor ELSA 2	29131	LRG722	68033427			1	TEQ-BC.113	60-63
			LRG723	68033428			2	TEQ-BC.114	60-63
	Meritor ELSA195	29177	LRG748	68033722	68033724		3	TEQ-BC.177	54-56
			LRG749	68033723	68033725		4	TEQ-BC.178	54-56
ZF AXLE	Meritor ELSA 2	29131	LRG750	68033421			1 3	TEQ-BC.179	60-63
			LRG751	68033422			2 4	TEQ-BC.180	60-63
	Meritor ELSA 1 Radial	29030	LRG642	68032619	RX93.08.007	0501006513	3	TEQ-BC.091	57-59
			LRG643	68032618	RX93.08.008	0501006514	4	TEQ-BC.092	57-59
COACH ALPANO, ASTRON BUS A300,330+	Meritor ELSA 1 Axial	29030	LRG616	68033363		LRG616	1	TEQ-BC.079	57-59
			LRG617	68033364		LRG617	2	TEQ-BC.080	57-59

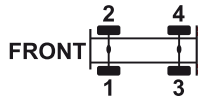

TEQ-BC.079
TEQ-BC.080



TEQ-BC.091
TEQ-BC.092



TEQ-BC.177
TEQ-BC.178



TEQ-BC.113
TEQ-BC.114
TEQ-BC.179

VOLVO

MODEL	CALIPER TYPE TYP ZACISKU	PADS WVA NO.	X REF	X REF 2	X REF 3	VEH MANUF. REF	SIDE STRONA	INDEX	KIT PAGE
B10B, B10BLE & Olympian > 2000 B10B, B10LE 2000 >	Meritor D LISA	29090	LRG592	68032340	RX93.05.007	70301332	1	TEQ-BC.089	68-70
			LRG593	68032341	RX93.05.008	70301333	2	TEQ-BC.090	68-70
City Bus 5010	Meritor ELSA 2 Radial	29131	LRG669	LRG662	LRG744	20535920	3	TEQ-BC.105	60-63
			LRG670	LRG663	LRG745	20535921	4	TEQ-BC.106	60-63
FL Series (17.5" Wheels) 2000 >	Meritor B Duco	29136	LRG552	68032988	RX93.06.003	20400319	1 3	TEQ-BC.181	64-67
			LRG553	68032989	RX93.06.004	20400320	2 4	TEQ-BC.182	64-67
FL Series (19.5" Wheels) 2000 >	Meritor C Duco	29137	LRG560	68033109	RX93.06.005	20442329	1 3	TEQ-BC.183	64-67
			LRG561	68033110	RX93.06.006	20442328	2 4	TEQ-BC.184	64-67
FL, FH, FM Series Axial (22.5" Wheels) 2000 >	Meritor D DUCO	29125	LRG536	68032582	RX93.06.017	20424082	1 3	TEQ-BC.068	64-67
			LRG537	68032583	RX93.06.018	20424083	2 4	TEQ-BC.104	64-67
FL, FH, FM Series Axial Flip (22.5" Wheels) 2000 >	Meritor D DUCO	29125	LRG596	68032584	RX93.06.007	20401810	3	TEQ-BC.185	64-67
			LRG597	68032585	RX93.06.008	20401811	4	TEQ-BC.186	64-67
FL, FH, FM Series Radial (22.5" Wheels) 2000 >	Meritor D DUCO	29125	LRG598	68032580	RX93.06.009	20424070	1	TEQ-BC.187	64-67
			LRG599	68032581	RX93.06.010	20424071	2	TEQ-BC.188	64-67
FL6 H Series (19.5" Wheels) 2000 > 01	Meritor C Duco	29137	LRG648	68032990	RX93.06.011	85103302	1 3	TEQ-BC.107	64-67
			LRG649	68032991	RX93.06.012	85103303	2 4	TEQ-BC.108	64-67
Volvo B7, B9, City Bus 5010 2003 / 04	Meritor ELSA 2 Radial	29131	LRG669	LRG662	LRG744	20535920	1	TEQ-BC.105	60-63
			LRG670	LRG663	LRG745	20535921	2	TEQ-BC.106	60-63
Volvo	MERITOR LE DUCO	29151	LRG650	68033233		20852499	1	TEQ-BC.189	64-67
			LRG651			20852506	2	TEQ-BC.190	64-67
Volvo B7, B9, City Bus 5010 2003 / 04	Meritor ELSA 2 Radial	29131	LRG669	LRG662	LRG744	20535920	1	TEQ-BC.105	60-63
			LRG670	LRG663	LRG745	20535921	2	TEQ-BC.106	60-63

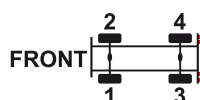

TEQ-BC.089
TEQ-BC.090



TEQ-BC.105
TEQ-BC.106



TEQ-BC.068
TEQ-BC.104
TEQ-BC.107
TEQ-BC.108

TEQ-BC.181
TEQ-BC.182
TEQ-BC.183
TEQ-BC.184

TEQ-BC.185
TEQ-BC.186
TEQ-BC.187
TEQ-BC.188

FEBER

MODEL	CALIPER TYPE TYP ZACISKU	PADS WVA NO.	X REF	X REF 2	X REF 3	VEH MANUF. REF	SIDE STRONA	INDEX	KIT PAGE
Various Axles 19.5" WHEELS	KNORR SN 6		K013174	SN6580RC	RX91.02.001	9754200801		TEQ-BC.002	34-38
			K013173	SN6570RC	RX91.02.002	9754200701		TEQ-BC.001	34-38
Various Axles 22.5" WHEELS	KNORR SN 7	29108	K003800	SN7211RC	RX91.03.013			TEQ-BC.009	45-49
			K003799	SN7201RC	RX91.03.014			TEQ-BC.006	45-49

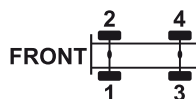

TEQ-BC.001
TEQ-BC.002



TEQ-BC.006
TEQ-BC.009



ZESTAWY NAPRAWCZE ZACISKÓW
BRAKE DISC REPAIR KITS
KNORR

SB 5

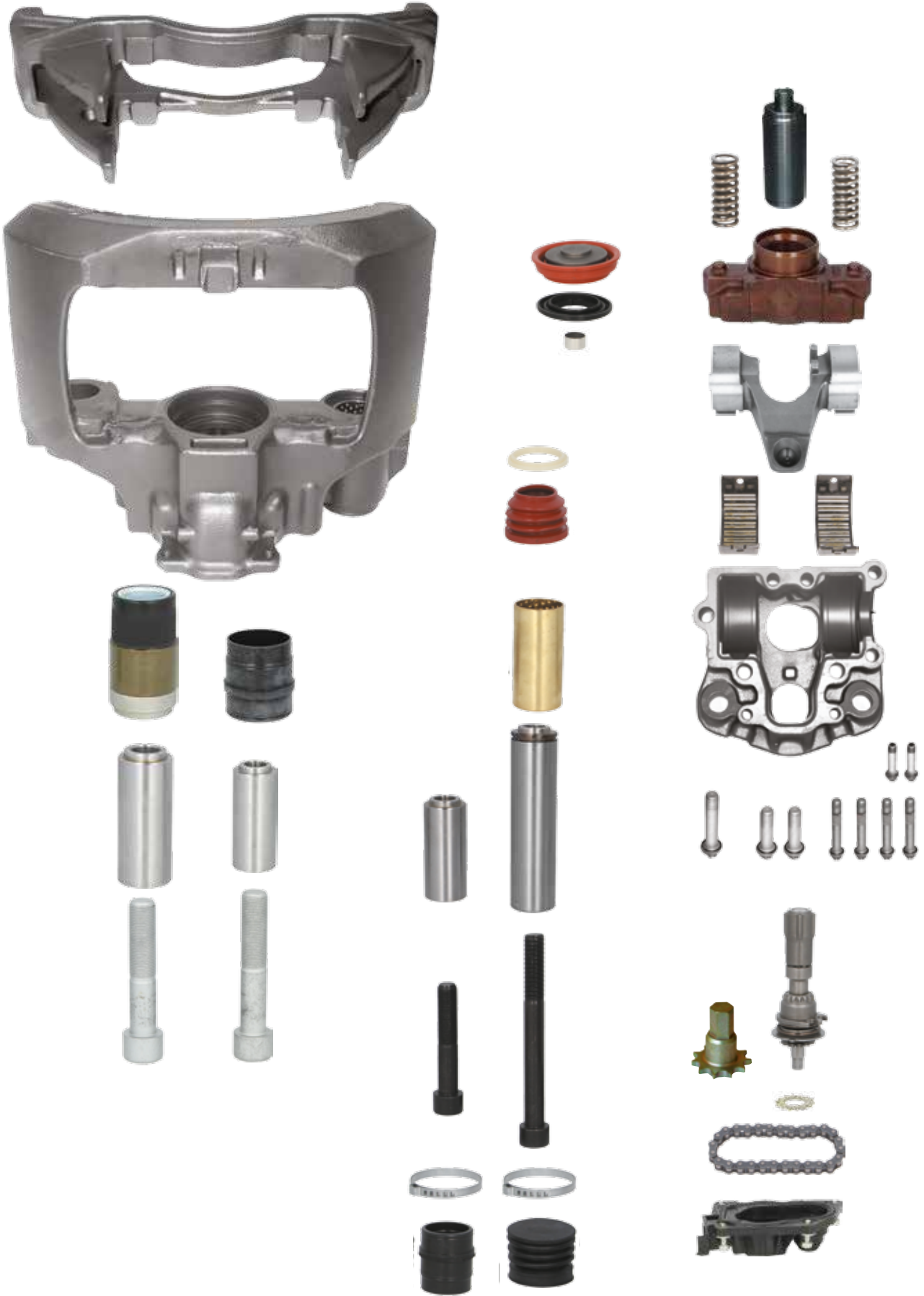

KNORR SB 5



INDEX: CRK-084

ŚRUBY, SWORZNI, OSŁONY, TULEJKI/ PINS AND DUST RUBBERS SET

NR NAZWA CZĘŚCI	INDEX	WYMIARY
1 SWORZEŃ / PIN	CRK-084, CRK-080	Ø36mm x 114mm
2 SWORZEŃ / PIN	CRK-084, CRK-080, CRK-313	Ø32mm x 80mm
3 ŚRUBA / SCREW	CRK-084, CRK-083, CRK-080, CRK-061, CRK-313	M16x1,5 x 87mm
4 ŚRUBA / SCREW	CRK-084, CRK-080, CRK-313	M16x1,5 x 80mm
5 TULEJA BRONZ / BRONZE BUSH	CRK-084, CRK-083, CRK-142	Ø36mm x Ø40mm x 82mm
6 TULEJA GUMOWA / RUBBER BUSH	CRK-084, CRK-313	Ø39mm
7 SWORZEŃ / PIN	CRK-083, CRK-142	Ø36mm x 145mm
8 SWORZEŃ / PIN	CRK-083, CRK-061, CRK-068	Ø34mm x 80mm
9 SWORZEŃ / PIN	CRK-083, CRK-142	M16x1,5 x 150mm
10 TULEJA GUMOWA / RUBBER BUSH	CRK-080,	Ø35mm
11 SWORZEŃ / PIN	CRK-313	Ø36mm x 102mm
12 TULEJA BRONZ / BRONZE BUSH	CRK-313	Ø36mm x Ø40mm x 75mm



INDEX: CRK-083

ŚRUBY, SWORZNI, OSŁONY, TULEJKI/ PINS AND DUST RUBBERS SET



INDEX: CRK-080

SWORZNI, ŚRUBA, PROWADNICA/ PINS AND DUST RUBBERS SET



INDEX: CRK-142

ŚRUBY, SWORZNI, TULEJE, OSŁONY/ PINS AND DUST RUBBERS SET



INDEX: CRK-061

SWORZEŃ, ŚRUBA, TULEJKA/ PINS AND DUST RUBBERS SET



INDEX: CRK-068

SWORZEŃ, TULEJKA/ PINS AND DUST RUBBERS SET



INDEX: CRK-313

TULEJKI I ŚRUBY/ PINS AND DUST RUBBERS SET



INDEX: CRK-166

TŁOCZKI/ TAPPETS 69 mm



INDEX: CRK-004

SAMOREGULATOR/ ADJUSTING MECHANISM



INDEX: CRK-369

ELEMENT MECHANIZMU SAMOREGULATORA/ PINION GEAR



INDEX: CRK-058

ŁAŃCUSZEK/ CHAIN



INDEX: CRK-076

ZĘBATKI REGULATORA/ MECHANISM GEAR

14 LINK



INDEX: CRK-207

MOSTEK/ SHAFT HOUSING



INDEX: CRK-187

ŁAPA WYCISKOWA/ LEVER 0°



INDEX: CRK-078

ŁOŻYSKA IGIEŁKOWE/ ROLLER BEARINGS



INDEX: CRK-010

NAKRĘTKI REGULACYJNE/ ADJUSTING MECHANISM ADAPTERS



INDEX: CRK-052

ZAŚLEPKI/ CAPS



INDEX: CRK-056

ZAŚLEPKI, BOLCE, ZAWLECZKI/ CAPS SET



INDEX: CRK-140

NAKRĘTKI REGULACYJNE, OSŁONY/ ADAPTERS AND CAPS



INDEX: CRK-328

PODSTAWA ŁAPY/ BODY CAP



INDEX: CRK-190

POKRYWA PLASTIKOWA BEZ CZUJNIKA/PLASTIC COVER WITHOUT SENSOR



INDEX: CRK-191

POKRYWA PLASTIKOWA Z CZUJNIKIEM/ PLASTIC COVER WITH SENSOR 2 PIN



INDEX: CRK-192

POKRYWA PLASTIKOWA Z CZUJNIKIEM/ PLASTIC COVER WITH SENSOR 3 PIN

SN 5

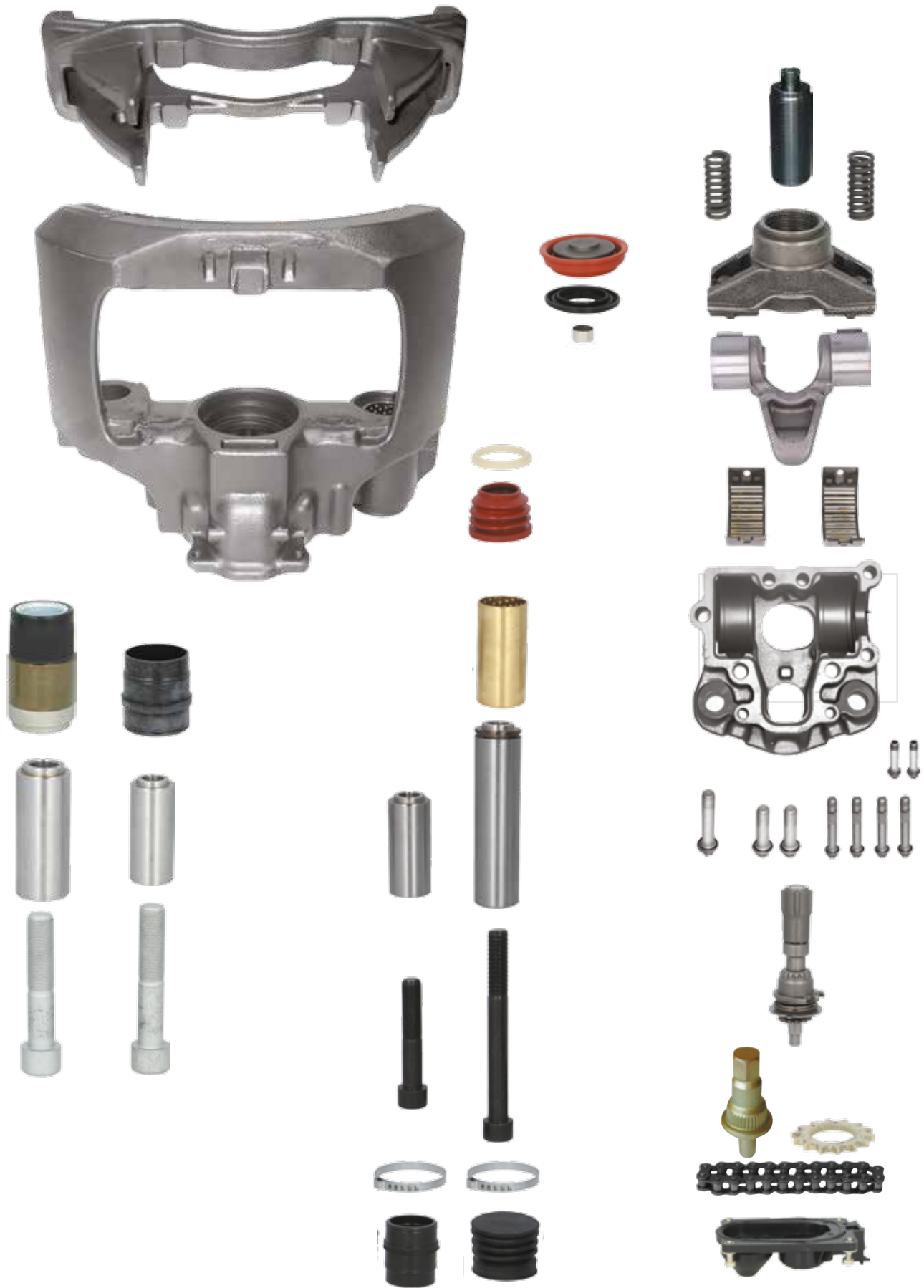

KNORR SN 5



INDEX: CRK-084

ŚRUBY, SWORZNI, OSŁONY, TULEJKI/ PINS AND DUST RUBBERS SET



INDEX: CRK-083

ŚRUBY, SWORZNI, OSŁONY, TULEJKI/ PINS AND DUST RUBBERS SET



INDEX: CRK-080

SWORZNI, ŚRUBY, PROWADNICA/ PINS AND DUST RUBBERS SET



INDEX: CRK-165

ŚRUBY, SWORZNI, TULEJE, OSŁONY/ PINS AND DUST RUBBERS SET



INDEX: CRK-068

SWORZEŃ, TULEJKA/ PINS AND DUST RUBBERS SET

NR	NAZWA CZĘŚCI	INDEX	WYMIARY
1	SWORZEŃ / PIN	CRK-084, CRK-080	Ø36mm x 114mm
2	SWORZEŃ / PIN	CRK-084, CRK-080, CRK-313	Ø32mm x 80mm
3	ŚRUBA / SCREW	CRK-084, CRK-083, CRK-080, CRK-061, CRK-313	M16x1,5 x 87mm
4	ŚRUBA / SCREW	CRK-084, CRK-080, CRK-313	M16x1,5 x 80mm
5	TULEJA BRONZ / BRONZE BUSH	CRK-084, CRK-083, CRK-142	Ø36mm x Ø40mm x 82mm
6	TULEJA GUMOWA / RUBBER BUSH	CRK-084, CRK-313	Ø39mm
7	SWORZEŃ / PIN	CRK-083, CRK-142	Ø36mm x 145mm
8	SWORZEŃ / PIN	CRK-083, CRK-061, CRK-068	Ø34mm x 80mm
9	ŚRUBA / SCREW	CRK-083, CRK-142	M16x1,5 x 150mm
10	TULEJA GUMOWA / RUBBER BUSH	CRK-080,	Ø35mm
11	SWORZEŃ / PIN	CRK-313	Ø36mm x 102mm
12	TULEJA BRONZ / BRONZE BUSH	CRK-313	Ø36mm x Ø40mm x 75mm
13	SWORZEŃ / PIN	CRK-165	Ø30mm x 99mm
14	SWORZEŃ / PIN	CRK-165	Ø30mm x 72mm
15	ŚRUBA / SCREW	CRK-165	M16x1,5 x 105mm
16	ŚRUBA / SCREW	CRK-165	M16x1,5 x 75mm
17	TULEJA BRONZ / BRONZE BUSH	CRK-165	Ø30mm x Ø34mm x 65mm



INDEX: CRK-142

ŚRUBY, SWORZNI, TULEJE, OSŁONY/ PINS AND DUST RUBBERS SET



INDEX: CRK-061

SWORZEŃ, ŚRUBA, TULEJKA/ PINS AND DUST RUBBERS SET



INDEX: CRK-313

TULEJKI I ŚRUBY/ PINS AND DUST RUBBERS SET



INDEX: CRK-166

TŁOCZKI/ TAPPETS 69 mm



INDEX: CRK-004

SAMOREGULATOR/ ADJUSTING MECHANISM



INDEX: CRK-132

SAMOREGULATOR/ ADJUSTING MECHANISM



INDEX: CRK-370

ELEMENT MECHANIZMU SAMOREGULATORA/ PINION GEAR



INDEX: CRK-368

ŁAŃCUSZEK/ CHAIN 12 LINK



INDEX: CRK-076

ZĘBATKI REGULATORA/ MECHANISM GEAR



INDEX: CRK-208

MOSTEK/ SHAFT HOUSING



INDEX: CRK-188

ŁAPA WYCISKOWA/ LEVER 0°



INDEX: CRK-205

ŁOŻYSKA IGIEŁKOWE/ ROLLER BEARINGS



INDEX: CRK-010

NAKRĘTKI REGULACYJNE/ ADJUSTING MECHANISM ADAPTERS



INDEX: CRK-052

ZAŚLEPKI/ CAPS



INDEX: CRK-056

ZAŚLEPKI, BOLCE, ZAWLECZKI/ CAPS SET

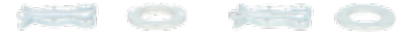

INDEX: CRK-140

NAKRĘTKI REGULACYJNE, OSŁONY/ ADAPTERS AND CAPS



INDEX: CRK-328

PODSTAWA ŁAPY/ BODY CAP



INDEX: CRK-203

POKRYWA TŁOCZKÓW/ TAPPETS COVER



INDEX: CRK-193

POKRYWA PLASTIKOWA BEZ CZUJNIKA/ PLASTIC COVER WITHOUT SENSOR



INDEX: CRK-194

POKRYWA PLASTIKOWA Z CZUJNIKIEM/ PLASTIC COVER WITH SENSOR 2 PIN



INDEX: CRK-195

POKRYWA PLASTIKOWA Z CZUJNIKIEM/ PLASTIC COVER WITH SENSOR 3 PIN

SB 6



KNORR SB 6



INDEX: CRK-083

ŚRUBY, SWORZNI, OSŁONY, TULEJKI/ PINS AND DUST RUBBERS SET



INDEX: CRK-080

SWORZNI, ŚRUBY, PROWADNICA/ PINS AND DUST RUBBERS SET



INDEX: CRK-138

ŚRUBY, SWORZNI, TULEJE, OSŁONY/ PINS AND DUST RUBBERS SET



INDEX: CRK-143

ŚRUBY, SWORZNI, TULEJE, OSŁONY/ PINS AND DUST RUBBERS SET



INDEX: CRK-093

SWORZNI, ŚRUBA, PROWADNICA/ PINS AND DUST RUBBERS SET



INDEX: CRK-106

ŚRUBA, SWORZNI, TULEJA/ PINS AND DUST RUBBERS SET

NR	NAZWA CZĘŚCI	INDEX	WYMIARY
1	SWORZEŃ / PIN	CRK-080, CRK-143,	Ø36mm x 114mm
2	SWORZEŃ / PIN	CRK-080, CRK-093, CRK-106, CRK-067, CRK-069	Ø32mm x 80mm
3	ŚRUBA / SCREW	CRK-080, CRK-083, CRK-143, CRK-329, CRK-061	M16x1,5 x 87mm
4	ŚRUBA / SCREW	CRK-080, CRK-093, CRK-106	M16x1,5 x 80mm
5	TULEJA BRONZ / BRONZE BUSH	CRK-083, CRK-138, CRK-142, CRK-143, CRK-329	Ø36mm x Ø40mm x 82mm
6	TULEJA GUMOWA / RUBBER BUSH	CRK-083, CRK-138, CRK-142, CRK-143, CRK-329, CRK-067	Ø39mm
7	SWORZEŃ / PIN	CRK-083, CRK-138, CRK-142	Ø36mm x 145mm
8	SWORZEŃ / PIN	CRK-083, CRK-329, CRK-068	Ø34mm x 80mm
9	ŚRUBA / SCREW	CRK-083, CRK-138, CRK-142	M16x1,5 x 150mm
10	TULEJA GUMOWA / RUBBER BUSH	CRK-080, CRK-093, CRK-069	Ø35mm
18	SWORZEŃ / PIN	CRK-138	Ø34mm x 120 mm
19	ŚRUBA / SCREW	CRK-138	M16x1,5 x 125mm
20	SWORZEŃ / PIN	CRK-329	Ø36mm x 135 mm
21	ŚRUBA / SCREW	CRK-329	M16x1,5 x 140mm
22	TULEJA / BUSH	CRK-329	Ø34mm x Ø40mm x 50 mm



INDEX: CRK-142

ŚRUBY, SWORZNI, TULEJE, OSŁONY/ PINS AND DUST RUBBERS SET



INDEX: CRK-329

SWORZNI, ŚRUBY, TULEJE/ PINS AND DUST RUBBERS SET



INDEX: CRK-061

SWORZEŃ, ŚRUBA, TULEJKA/ PINS AND DUST RUBBERS SET



INDEX: CRK-067

SWORZEŃ, TULEJKA/ PINS AND DUST RUBBERS SET



INDEX: CRK-068

SWORZEŃ, TULEJKA/ PINS AND DUST RUBBERS SET



INDEX: CRK-069

SWORZEŃ, TULEJKA/ PINS AND DUST RUBBERS SET



INDEX: CRK-053

TŁOCZKI/ TAPPETS 74 mm



INDEX: CRK-005

ŚRUBA REGULACYJNA/ CALIBRATION BOLT



INDEX: CRK-004

SAMOREGULATOR/ ADJUSTING MECHANISM



INDEX: CRK-032

REGULATOR/ ADJUSTING MECHANISM



INDEX: CRK-134

WAŁEK ZĘBATY SAMOREGULATORA/ ADJUSTING MECHANISM



INDEX: CRK-135

WAŁEK ZĘBATY SAMOREGULATORA/ ADJUSTING MECHANISM



INDEX: CRK-077

ŁAŃCUSZEK/ CHAIN 29 LINK



INDEX: CRK-076

ZĘBATKI REGULATORA/ MECHANISM GEAR



INDEX: CRK-074

MOSTEK ZE ŚRUBAMI REGULUJĄCYMI/SHAFT HOUSING WITH CALIBRATION BOLT



INDEX: CRK-091

ŁAPA WYCISKOWA/ LEVER 0°



INDEX: CRK-189

ŁAPA WYCISKOWA/ LEVER 93°



INDEX: CRK-078

ŁOŻYSKA IGIEŁKOWE/ ROLLER BEARINGS



INDEX: CRK-010

NAKRĘTKI REGULACYJNE/ ADJUSTING MECHANISM ADAPTERS

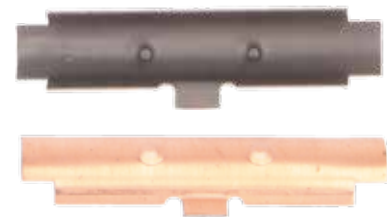

INDEX: CRK-047

PANEWKA DŹWIGNI WYCISKOWEJ/ LEVER BUSH



INDEX: CRK-052

ZAŚLEPKI/ CAPS



INDEX: CRK-056

ZAŚLEPKI, BOLCE, ZAWLECZKI/ CAPS SET



INDEX: CRK-082

ZESTAW ZAŚLPEK CAPS SET



INDEX: CRK-099

OSŁONY/ COVERS



INDEX: CRK-140

NAKRĘTKI REGULACYJNE, OSŁONY/ ADAPTERS AND CAPS

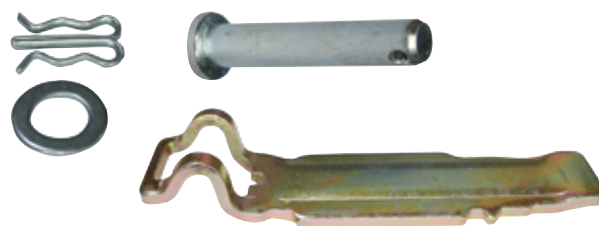

INDEX: CRK-314

MOCOWANIE KLOCKA HAMULCOWEGO/PAD RETAINER KIT



INDEX: CRK-034

POKRYWA ZACISKU BEZ CZUJNIKA/ PLASTIC COVER WITHOUT SENSOR



INDEX: CRK-154

POKRYWA PLASTIKOWA Z CZUJNIKIEM/ PLASTIC COVER WITH SENSOR 2 PIN



INDEX: CRK-155

POKRYWA PLASTIKOWA Z CZUJNIKIEM/ PLASTIC COVER WITH SENSOR 3 PIN



INDEX: CRK-021

POKRYWA ZACISKU BEZ CZUJNIKA/ PLASTIC COVER WITHOUT SENSOR



INDEX: CRK-299

POKRYWA PLASTIKOWA Z CZUJNIKIEM/ PLASTIC COVER WITH SENSOR 2 PIN



INDEX: CRK-300

POKRYWA PLASTIKOWA Z CZUJNIKIEM/ PLASTIC COVER WITH SENSOR 3 PIN

SN 6

KNORR SN 6





INDEX: CRK-084

ŚRUBY, SWORZNIĘ, OSŁONY, TULEJKI/ PINS AND DUST RUBBERS SET



INDEX: CRK-080

SWORZNIĘ, ŚRUBY, PROWADNICA/ PINS AND DUST RUBBERS SET

NR	NAZWA CZĘŚCI	INDEX	WYMIARY
1	SWORZEŃ / PIN	CRK-084, CRK-163, CRK-080	Ø36mm x 114mm
2	SWORZEŃ / PIN	CRK-084, CRK-163, CRK-080	Ø32mm x 80mm
3	ŚRUBA / SCREW	CRK-084, CRK-163, CRK-080	M16x1,5 x 87mm
4	ŚRUBA / SCREW	CRK-084, CRK-163, CRK-080	M16x1,5 x 80mm
5	TULEJA BRONZ / BRONZE BUSH	CRK-084, CRK-163	Ø36mm x Ø40mm x 82mm
6	TULEJA GUMOWA / RUBBER BUSH	CRK-084, CRK-163	Ø39mm
10	TULEJA GUMOWA / RUBBER BUSH	CRK-080	Ø35mm



INDEX: CRK-163

ŚRUBY, SWORZNIĘ, TULEJE, OSŁONY/ PINS AND DUST RUBBERS SET



INDEX: CRK-048

TŁOCZKI/ TAPPETS 69 mm



INDEX: CRK-005

ŚRUBA REGULACYJNA/ CALIBRATION BOLT



INDEX: CRK-004

SAMOREGULATOR/ ADJUSTING MECHANISM



INDEX: CRK-032

REGULATOR/ ADJUSTING MECHANISM

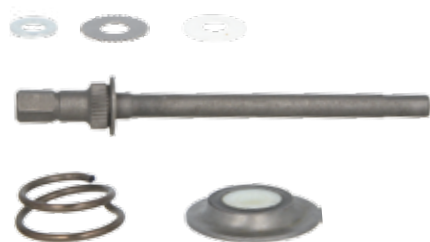

INDEX: CRK-134

WAŁEK ZĘBATY SAMOREGULATORA/ ADJUSTING MECHANISM



INDEX: CRK-135

WAŁEK ZĘBATY SAMOREGULATORA/ ADJUSTING MECHANISM



INDEX: CRK-077

ŁAŃCUSZEK/ CHAIN 29 LINK



INDEX: CRK-076

ZĘBATKI REGULATORA/ MECHANISM GEAR



INDEX: CRK-088

MOSTEK ZE ŚRUBAMI REGULUJĄCYMI/SHAFT HOUSING WITH CALIBRATION BOLT



INDEX: CRK-297

ŁAPA WYCISKOWA/ LEVER 0°



INDEX: CRK-057

ŁOŻYSKA IGIEŁKOWE/ ROLLER BEARINGS



INDEX: CRK-010

NAKRĘTKI REGULACYJNE/ ADJUSTING MECHANISM ADAPTERS



INDEX: CRK-023

ZAŚLEPKI/ CAPS

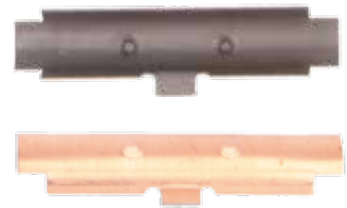

INDEX: CRK-047

PANEWKA DŹWIGNI WYCISKOWEJ/ LEVER BUSH



INDEX: CRK-052

ZAŚLEPKI/ CAPS



INDEX: CRK-056

ZAŚLEPKI, BOLCE, ZAWLECZKI/ CAPS SET



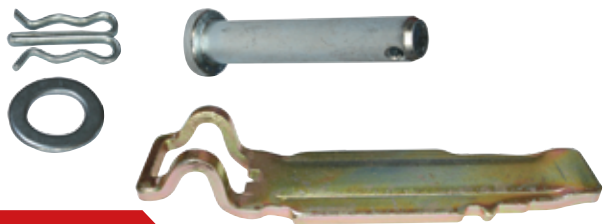

INDEX: CRK-314

MOCOWANIE KLOCKA HAMULCOWEGO/ PAD RETAINER KIT



INDEX: CRK-085

POKRYWA TŁOCZKÓW/ TAPPETS COVER



INDEX: CRK-034

POKRYWA ZACISKU BEZ CZUJNIKA/ PLASTIC COVER WITHOUT SENSOR



INDEX: CRK-154

POKRYWA PLASTIKOWA Z CZUJNIKIEM/ PLASTIC COVER WITH SENSOR 2 PIN



INDEX: CRK-155

POKRYWA PLASTIKOWA Z CZUJNIKIEM/ PLASTIC COVER WITH SENSOR 3 PIN



INDEX: CRK-021

POKRYWA ZACISKU BEZ CZUJNIKA/ PLASTIC COVER WITHOUT SENSOR



INDEX: CRK-299

POKRYWA PLASTIKOWA Z CZUJNIKIEM/ PLASTIC COVER WITH SENSOR 2 PIN



INDEX: CRK-300

POKRYWA PLASTIKOWA Z CZUJNIKIEM/ PLASTIC COVER WITH SENSOR 3 PIN



INDEX: CRK-196

POKRYWA ZACISKU BEZ CZUJNIKA PLASTIC COVER WITHOUT SENSOR



INDEX: CRK-197

POKRYWA PLASTIKOWA Z CZUJNIKIEM/ PLASTIC COVER WITH SENSOR 2 PIN



INDEX: CRK-198

POKRYWA PLASTIKOWA Z CZUJNIKIEM/ PLASTIC COVER WITH SENSOR 3 PIN



INDEX: CRK-326

POKRYWA PLASTIKOWA BEZ CZUJNIKA/ PLASTIC COVER WITHOUT SENSOR



INDEX: CRK-327

POKRYWA PLASTIKOWA Z CZUJNIKIEM/ PLASTIC COVER WITH SENSOR 2 PIN



INDEX: CRK-180

POKRYWA PLASTIKOWA Z CZUJNIKIEM/ PLASTIC COVER WITH SENSOR 3 PIN

SB 7



KNORR SB 7



INDEX: CRK-083

ŚRUBY, SWORZNI, OSŁONY, TULEJKI / PINS AND DUST RUBBERS SET



INDEX: CRK-080

SWORZNI, ŚRUBY, PROWADNICA / PINS AND DUST RUBBERS SET



INDEX: CRK-071

ŚRUBY, SWORZNI, OSŁONY, TULEJKI / PINS AND DUST RUBBERS SET



INDEX: CRK-138

ŚRUBY, SWORZNI, TULEJE, OSŁONY / PINS AND DUST RUBBERS SET



INDEX: CRK-143

ŚRUBY, SWORZNI, TULEJE, OSŁONY / PINS AND DUST RUBBERS SET

NR	NAZWA CZĘŚCI	INDEX	WYMIARY
1	SWORZEŃ / PIN	CRK-080, CRK-071, CRK-143, CRK-144, CRK-161, CRK-164	Ø36mm x 114mm
2	SWORZEŃ / PIN	CRK-080, CRK-071, CRK-137, CRK-144, CRK-161, CRK-093, CRK-106, CRK-067, CRK-069	Ø32mm x 80mm
3	ŚRUBA / SCREW	CRK-083, CRK-080, CRK-071, CRK-143, CRK-144, CRK-161, CRK-164, CRK-329, CRK-061	M16x1,5 x 87mm
4	ŚRUBA / SCREW	CRK-080, CRK-071, CRK-137, CRK-144, CRK-161, CRK-093, CRK-106	M16x1,5 x 80mm
5	TULEJA BRONZ / BRONZE BUSH	CRK-083, CRK-071, CRK-137, CRK-138, CRK-142, CRK-143, CRK-144, CRK-161, CRK-164, CRK-329, CRK-311	Ø36mm x Ø40mm x 82mm
6	TULEJA GUMOWA / RUBBER BUSH	CRK-137, CRK-161, CRK-106, CRK-067	Ø39mm
7	SWORZEŃ / PIN	CRK-083, CRK-137, CRK-138, CRK-142	Ø36mm x 145mm
8	SWORZEŃ / PIN	CRK-083, CRK-164, CRK-329, CRK-061, CRK-068	Ø34mm x 80mm
9	ŚRUBA / SCREW	CRK-083, CRK-137, CRK-138, CRK-142	M16x1,5 x 150mm
10	TULEJA GUMOWA / RUBBER BUSH	CRK-080, CRK-071, CRK-144, CRK-093, CRK-069, CRK-138, CRK-311	Ø35mm
18	SWORZEŃ / PIN	CRK-138, CRK-311	Ø34mm x 120 mm
19	ŚRUBA / SCREW	CRK-138, CRK-311	M16x1,5 x 125mm
20	SWORZEŃ / PIN	CRK-329, CRK-311	Ø36mm x 135 mm
21	ŚRUBA / SCREW	CRK-329, CRK-311	M16x1,5 x 140mm
22	TULEJA / BUSH	CRK-329	Ø34mm x Ø40mm x 50 mm



INDEX: CRK-137

ŚRUBY, SWORZNI, TULEJE, OSŁONY / PINS AND DUST RUBBERS SET



INDEX: CRK-142

ŚRUBY, SWORZNI, TULEJE, OSŁONY / PINS AND DUST RUBBERS SET



INDEX: CRK-144

ŚRUBY, SWORZNI, TULEJE, OSŁONY / PINS AND DUST RUBBERS SET



INDEX: CRK-161

ŚRUBY, SWORZNIĘ, TULEJE, OSŁONY/ PINS AND DUST RUBBERS SET



INDEX: CRK-164

ŚRUBY, SWORZNIĘ, TULEJE, OSŁONY/ PINS AND DUST RUBBERS SET



INDEX: CRK-329

SWORZNIĘ, ŚRUBY, TULEJE/ PINS AND DUST RUBBERS SET



INDEX: CRK-093

SWORZNIĘ, ŚRUBA, PROWADNICA/ PINS AND DUST RUBBERS SET



INDEX: CRK-106

ŚRUBA, SWORZNIĘ, TULEJA/ PINS AND DUST RUBBERS SET



INDEX: CRK-061

SWORZNIĘ, ŚRUBA, TULEJKA/ PINS AND DUST RUBBERS SET



INDEX: CRK-067

SWORZNIĘ, TULEJKA/ PINS AND DUST RUBBERS SET



INDEX: CRK-068

SWORZNIĘ, TULEJKA/ PINS AND DUST RUBBERS SET



INDEX: CRK-069

SWORZNIĘ, TULEJKA/ PINS AND DUST RUBBERS SET



INDEX: CRK-311

TULEJKI I ŚRUBY/ PINS AND DUST RUBBERS SET



INDEX: CRK-312

TULEJKI I ŚRUBY/ PINS AND DUST RUBBERS SET



INDEX: CRK-053

TŁOCZKI/ TAPPETS 74 mm



INDEX: CRK-004

SAMOREGULATOR/ ADJUSTING MECHANISM

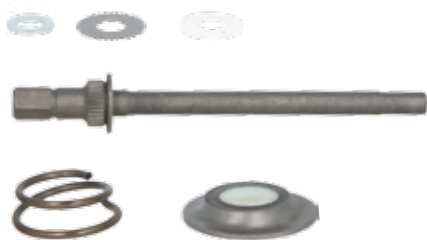

INDEX: CRK-134

WAŁEK ZĘBATY SAMOREGULATORA/ ADJUSTING MECHANISM



INDEX: CRK-077

ŁAŃCUSZEK/ CHAIN 29 LINK

NR	NAZWA CZĘŚCI	INDEX	WYMIARY
3	ŚRUBA / SCREW	CRK-312, CRK-112	M16x1,5 x 87mm
5	TULEJA BRONZ / BRONZE BUSH	CRK-312	Ø36mm x Ø40mm x 82mm
8	SWORZEŃ / PIN	CRK-312	Ø34mm x 80mm
20	SWORZEŃ / PIN	CRK-312	Ø36mm x 135 mm
21	ŚRUBA / SCREW	CRK-312	M16x1,5 x 140mm
22	TULEJA / BUSH	CRK-312	Ø34mm x Ø40mm x 50 mm



INDEX: CRK-005

ŚRUBA REGULACYJNA/ CALIBRATION BOLT



INDEX: CRK-032

REGULATOR/ ADJUSTING MECHANISM

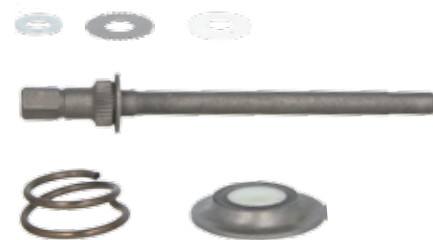

INDEX: CRK-135

WAŁEK ZĘBATY SAMOREGULATORA/ ADJUSTING MECHANISM



INDEX: CRK-076

ZĘBATKI REGULATORA/ MECHANISM GEAR



INDEX: CRK-074

MOSTEK ZE ŚRUBAMI REGULUJĄCYMI/SHAFT HOUSING WITH CALIBRATION BOLT



INDEX: CRK-094

ŁAPA WYCISKOWA/ LEVER 12°



INDEX: CRK-184

ŁAPA WYCISKOWA/ LEVER 0°



INDEX: CRK-189

ŁAPA WYCISKOWA/ LEVER 93°



INDEX: CRK-078

ŁOŻYSKA IGIEŁKOWE/ ROLLER BEARINGS



x 10

INDEX: CRK-010

NAKRĘTKI REGULACYJNE/ ADJUSTING MECHANISM ADAPTERS

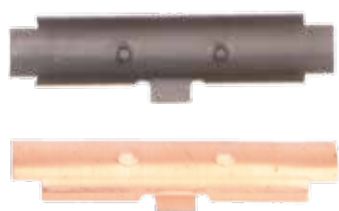

INDEX: CRK-047

PANEWKA DŹWIGNI WYCISKOWEJ/ LEVER BUSH



INDEX: CRK-052

ZAŚLEPKI/ CAPS



INDEX: CRK-056

ZAŚLEPKI, BOLCE, ZAWLECZKI/ CAPS SET



INDEX: CRK-082

ZESTAW ZAŚLPEK CAPS SET



INDEX: CRK-099

OSŁONY/ COVERS



INDEX: CRK-140

NAKRĘTKI REGULACYJNE, OSŁONY/ ADAPTERS AND CAPS



INDEX: CRK-034

POKRYWA ZACISKU BEZ CZUJNIKA/ PLASTIC COVER WITHOUT SENSOR



INDEX: CRK-154

POKRYWA PLASTIKOWA Z CZUJNIKIEM/ PLASTIC COVER WITH SENSOR 2 PIN



INDEX: CRK-155

POKRYWA PLASTIKOWA Z CZUJNIKIEM/ PLASTIC COVER WITH SENSOR 3 PIN



INDEX: CRK-021

POKRYWA ZACISKU BEZ CZUJNIKA/ PLASTIC COVER WITHOUT SENSOR



INDEX: CRK-299

POKRYWA PLASTIKOWA Z CZUJNIKIEM/ PLASTIC COVER WITH SENSOR 2 PIN



INDEX: CRK-300

POKRYWA PLASTIKOWA Z CZUJNIKIEM/ PLASTIC COVER WITH SENSOR 3 PIN

SN 7



KNORR SN 7



INDEX: CRK-084

ŚRUBY, SWORZNIĘ, OSŁONY, TULEJKI/ PINS AND DUST RUBBERS SET

NR	NAZWA CZĘŚCI	INDEX	WYMIARY
1	SWORZEŃ / PIN	CRK-084, CRK-080, CRK-163, CRK-087	Ø36mm x 114mm
2	SWORZEŃ / PIN	CRK-084, CRK-080, CRK-163	Ø32mm x 80mm
3	ŚRUBA / SCREW	CRK-084, CRK-080, CRK-163, CRK-087	M16x1,5 x 87mm
4	ŚRUBA / SCREW	CRK-084, CRK-080, CRK-163	M16x1,5 x 80mm
5	TULEJA BRONZ / BRONZE BUSH	CRK-084, CRK-163, CRK-087	Ø36mm x Ø40mm x 82mm
6	TULEJA GUMOWA / RUBBER BUSH	CRK-084, CRK-163	Ø39mm
10	TULEJA GUMOWA / RUBBER BUSH	CRK-080	Ø35mm
23	SWORZEŃ / PIN	CRK-087	Ø36mm x 64mm
24	ŚRUBA / SCREW	CRK-087	M16x1,5 x 70mm



INDEX: CRK-080

SWORZNIĘ, ŚRUBY, PROWADNICA/ PINS AND DUST RUBBERS SET



INDEX: CRK-163

ŚRUBY, SWORZNIĘ, TULEJE, OSŁONY/ PINS AND DUST RUBBERS SET



INDEX: CRK-087

ŚRUBY, SWORZNIĘ, TULEJE, OSŁONY/ PINS AND DUST RUBBERS SET



INDEX: CRK-048

TŁOCZKI/ TAPPETS 69 mm



INDEX: CRK-005

ŚRUBA REGULACYJNA/ CALIBRATION BOLT



INDEX: CRK-004

SAMOREGULATOR/ ADJUSTING MECHANISM



INDEX: CRK-032

REGULATOR/ ADJUSTING MECHANISM



INDEX: CRK-134

WAŁEK ZĘBATY SAMOREGULATORA/ ADJUSTING MECHANISM

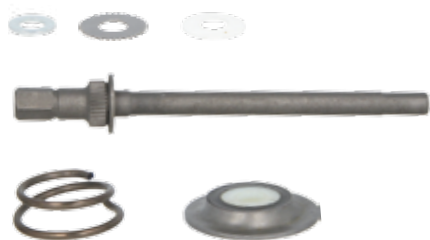

INDEX: CRK-135

WAŁEK ZĘBATY SAMOREGULATORA/ ADJUSTING MECHANISM



INDEX: CRK-077

ŁAŃCUSZEK/ CHAIN 29 LINK



INDEX: CRK-076

ZĘBATKI REGULATORA/ MECHANISM GEAR



INDEX: CRK-088

MOSTEK ZE ŚRUBAMI REGULUJĄCYMI/SHAFT HOUSING WITH CALIBRATION BOLT



INDEX: CRK-089

ŁAPA WYCISKOWA/ LEVER 0°



INDEX: CRK-090

ŁAPA WYCISKOWA/ LEVER 12°



INDEX: CRK-057

ŁOŻYSKA IGIEŁKOWE/ ROLLER BEARINGS



INDEX: CRK-010

NAKRĘTKI REGULACYJNE/ ADJUSTING MECHANISM ADAPTERS



INDEX: CRK-023

ZAŚLEPKI/ CAPS



INDEX: CRK-047

PANEWKA DŹWIGNI WYCISKOWEJ/ LEVER BUSH



INDEX: CRK-052

ZAŚLEPKI/ CAPS



INDEX: CRK-056

ZAŚLEPKI, BOLCE, ZAWLECZKI/ CAPS SET



INDEX: CRK-085

POKRYWA TŁOCZKÓW/ TAPPETS COVER



INDEX: CRK-034

POKRYWA ZACISKU BEZ CZUJNIKA/ PLASTIC COVER WITHOUT SENSOR



INDEX: CRK-154

POKRYWA PLASTIKOWA Z CZUJNIKIEM/ PLASTIC COVER WITH SENSOR 2 PIN



INDEX: CRK-155

POKRYWA PLASTIKOWA Z CZUJNIKIEM/ PLASTIC COVER WITH SENSOR 3 PIN



INDEX: CRK-021

POKRYWA ZACISKU BEZ CZUJNIKA/ PLASTIC COVER WITHOUT SENSOR



INDEX: CRK-299

POKRYWA PLASTIKOWA Z CZUJNIKIEM/ PLASTIC COVER WITH SENSOR 2 PIN



INDEX: CRK-300

POKRYWA PLASTIKOWA Z CZUJNIKIEM/ PLASTIC COVER WITH SENSOR 3 PIN



INDEX: CRK-326

POKRYWA PLASTIKOWA BEZ CZUJNIKA/ PLASTIC COVER WITHOUT SENSOR

**INDEX: CRK-327**

POKRYWA PLASTIKOWA Z CZUJNIKIEM/ PLASTIC COVER WITH
SENSOR 2 PIN

**INDEX: CRK-180**

POKRYWA PLASTIKOWA Z CZUJNIKIEM/ PLASTIC COVER WITH
SENSOR 3 PIN



ZESTAWY NAPRAWCZE ZACISKÓW
BRAKE DISC REPAIR KITS
MERITOR

DX 195



MERITOR DX 195



INDEX: CRK-001

ŁOZYSKA/ BEARINGS



INDEX: CRK-007

ŚRUBY, SWORZNI, OSŁONY, TULEJKI/ PINS AND DUST RUBBERS SET

NR	NAZWA ELEMENTU	INDEX	WYMIARY
1	SWORZEŃ / PIN	CRK-007	Ø32mm x 97mm, depth 62mm
2	SWORZEŃ / PIN	CRK-007	Ø32mm x 97mm, depth 37mm
3	TULEJA / BUSH	CRK-007	Ø32mm x Ø36mm x 55mm
4	ŚRUBA / SCREW	CRK-007	M16x1,5mm x 80mm
5	ŚRUBA / SCREW	CRK-007	M16x1,5mm x 55mm



INDEX: CRK-390

USZCZELKI/ RUBBERS



INDEX: CRK-049

ZESTAW MIMOŚRODU/ ECCENTRIC SHAFT KIT



INDEX: CRK-050

MECHANIZM REGULATORA LEWY/ ADJUSTING MECHANISM LEFT

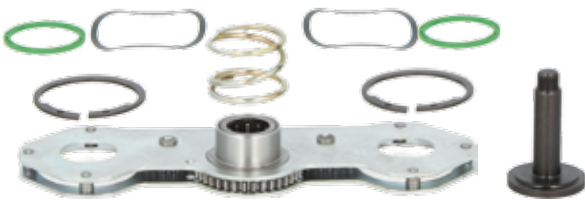

INDEX: CRK-051

MECHANIZM REGULATORA PRAWY/ ADJUSTING MECHANISM RIGHT



INDEX: CRK-109

STRZEMIEŃ KŁOCKA/ PAD RETAINER KIT



INDEX: CRK-110

PŁYTA DOCISKOWA ZE ŚRUBAMI PRAWA/ PUSHING PLATE RIGHT



INDEX: CRK-237

PŁYTA DOCISKOWA LEWA/ PUSHING PLATE LEFT



INDEX: CRK-116

TULEJKI LEWE/ BUSHINGS LEFT



INDEX: CRK-117

TULEJKI PRAWO/ BUSHINGS RIGHT



INDEX: CRK-147

ŚRUBY, OSŁONY/ SCREWS AND SEALS



INDEX: CRK-238

DŹWIGNIA MIMOŚRODU/ ECCENTRIC SHAFT LEVER



INDEX: CRK-239

MOSTEK/ SHAFT HOUSING



INDEX: CRK-240

POKRYWA MIMOŚRODU/ ECCENTRIC SHAFT HOUSING



INDEX: CRK-241

ŚRUBA TŁOCZKA LEWA/ CALIBRATION BOLT LEFT



INDEX: CRK-242

ŚRUBA TŁOCZKA PRAWA/ CALIBRATION BOLT RIGHT



INDEX: CRK-243

ZESTAW ZĘBATEK/ GEAR SET



INDEX: CRK-285

MIMOŚRÓD/ ECCENTRIC SHAFTS

ELSA 195 /225

MERITOR ELSA 195/225



NR	NAZWA ELEMENTU	INDEX	WYMIARY
6	SWORZEŃ / PIN	CRK-008, CRK-159, CRK-152	Ø35mm x 117mm
7	SWORZEŃ / PIN	CRK-008, CRK-152	Ø31mm x 78mm
8	ŚRUBA / SCREW	CRK-008, CRK-159, CRK-152	M18x1,5mm x 120mm
9	ŚRUBA / SCREW	CRK-008, CRK-152	M18x1,5mm x 82mm
10	TULEJA / BUSH	CRK-008, CRK-159, CRK-152	Ø35mm x Ø39mm x 30mm
11	SWORZEŃ / PIN	CRK-159	Ø31mm x 117mm
12	TULEJA / BUSH	CRK-008, CRK-159, CRK-152	Ø31-33mm x Ø42mm x 30mm



INDEX: CRK-008

ŚRUBY, SWORZNI, OSŁONY, TULEJKI/ PINS AND DUST RUBBERS SET



INDEX: CRK-159

ŚRUBY, SWORZNI, TULEJE, OSŁONY/ PINS AND DUST RUBBERS SET



INDEX: CRK-152

ŚRUBY, SWORZNI, TULEJE, OSŁONY/ PINS AND DUST RUBBERS SET



INDEX: CRK-075

MECHANIZM REGULATORA/ ADJUSTING MECHANISM



INDEX: CRK-092

USZCZELNIENIA MECHANIZMU REGULACJI/ ADJUSTING MECHANISM SEALS



INDEX: CRK-098

TŁOCZKI/ TAPPETS



INDEX: CRK-101

ŚRUBY/ SCREWS



INDEX: CRK-114

ZABEZPIECZENIE KŁOCKÓW/ PAD RETAINER KIT



INDEX: CRK-131

MECHANIZM REGULATORA/ ADJUSTING MECHANISM



INDEX: CRK-160

ZAŚLEPKA/ CAP



INDEX: CRK-294

REGULATOR/ ADJUSTING MECHANISM



INDEX: CRK-295

MOSTEK/ SHAFT HOUSING

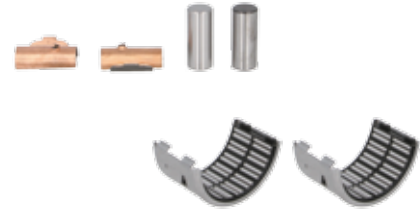

INDEX: CRK-389

ŁOŻYSKA IGIEŁKOWE/ ROLLER BEARINGS



INDEX: CRK-296

ŁAPA WYCISKOWA/ LEVER



INDEX: CRK-304

MOSTEK/ SHAFT HOUSING



INDEX: CRK-310

ŚRUBY, SWORZNIE, OSŁONY, TULEJKI/ PINS AND DUST RUBBERS SET



INDEX: CRK-336

USZCZELKA/ GASKET

ELSA 1



MERITOR ELSA 1



INDEX: CRK-003

ŚRUBY, SWORZNIĘ, OSŁONY, TULEJKI/ PINS AND DUST RUBBERS SET



INDEX: CRK-014

ŚRUBY, SWORZNIĘ, OSŁONY, TULEJKI/ PINS AND DUST RUBBERS SET

NR	NAZWA ELEMENTU	INDEX	WYMIARY
13	SWORZEŃ / PIN	CRK-003, CRK-014	Ø35mm x 135mm
14	SWORZEŃ / PIN	CRK-003	Ø35mm x 73mm
15	ŚRUBA / SCREW	CRK-003, CRK-014	M20x1,5mm x 150mm
16	ŚRUBA / SCREW	CRK-003	M20x1,5mm x 90mm
10	TULEJA / BUSH	CRK-003, CRK-014	Ø35mm x Ø39mm x 30mm
17	TULEJA / BUSH	CRK-003	Ø35-37mm x Ø40mm x 33mm
18	SWORZEŃ / PIN	CRK-014	Ø28,5mm x 110mm
19	TULEJA / BUSH	CRK-014	Ø28,5mm x Ø40mm x 27mm



INDEX: CRK-025

ZESTAW SAMUREGULATORA PRAWY/ ADJUSTING MECHANISM KIT RIGHT



INDEX: CRK-026

ZESTAW SAMUREGULATORA LEWY/ ADJUSTING MECHANISM KIT LEFT



INDEX: CRK-046

USZCZELNIENIA TŁOCZKA/ SEALS



INDEX: CRK-060

SPRĘŻYNA PRAWA/ SPRING RIGHT



INDEX: CRK-290

SPRĘŻYNA LEWA/ SPRING LEFT



INDEX: CRK-096

ELEMENTY REGULATORA PRAWY/ ADJUSTING MECHANISM RIGHT



INDEX: CRK-097

ELEMENTY REGULATORA LEWY/ ADJUSTING MECHANISM LEFT

**INDEX: CRK-104**

MECHANIZM REGULATORA LEWY/ ADJUSTING MECHANISM LEFT

**INDEX: CRK-105**

MECHANIZM REGULATORA PRAWY/ ADJUSTING MECHANISM RIGHT

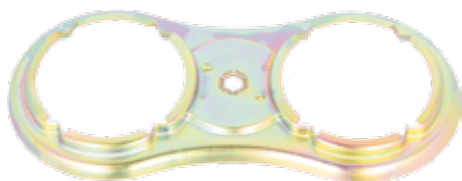
**INDEX: CRK-108**

OKRYWA ZACISKU/ COVER

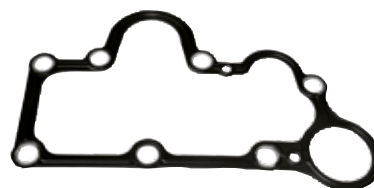
**INDEX: CRK-387**

USZCZELKA/ GASKET

**INDEX: CRK-288**

ŁAPA WYCISKOWA LEWA/ LEVER LEFT

**INDEX: CRK-289**

ŁAPA WYCISKOWA PRAWA/ LEVER RIGHT

**INDEX: CRK-059**

ŁOŻYSKA IGIEŁKOWE/ ROLLER BEARINGS

**INDEX: CRK-070**

ZAŚLPEKA/ CAP

ELSA 2

MERITOR ELSA 2

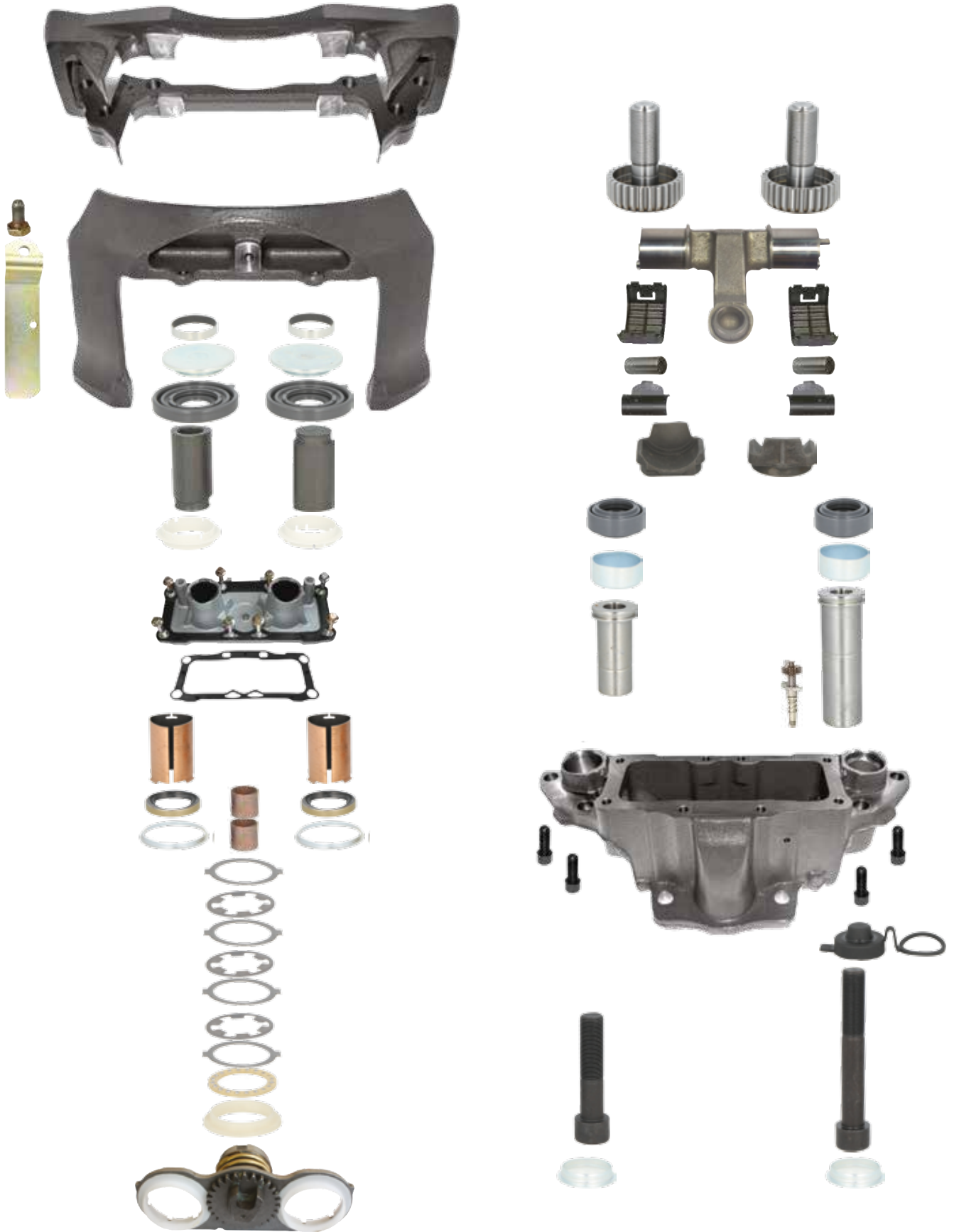



INDEX: CRK-002

ŚRUBY, SWORZNI, OSŁONY, TULEJKI/ PINS AND DUST RUBBERS SET



INDEX: CRK-151

ŚRUBY, SWORZNI, TULEJE, OSŁONY/ PINS AND DUST RUBBERS SET

NR	NAZWA ELEMENTU	INDEX	WYMIARY
20	SWORZEŃ / PIN	CRK-002	Ø35mm x 144mm
21	SWORZEŃ / PIN	CRK-002	Ø31mm x 84mm
22	ŚRUBA / SCREW	CRK-002	M18x1,5mm x 150mm
23	ŚRUBA / SCREW	CRK-002	M18x1,5mm x 90mm
10	TULEJA / BUSH	CRK-002, CRK-151	Ø35mm x Ø39mm x 30mm
12	TULEJA / BUSH	CRK-002	Ø31-33mm x Ø42mm x 30mm
24	SWORZEŃ / PIN	CRK-151	Ø35mm x 126mm
25	SWORZEŃ / PIN	CRK-151	Ø33-35mm x 66mm
15	ŚRUBA / SCREW	CRK-151	M20x1,5mm x 150mm
16	ŚRUBA / SCREW	CRK-151	M20x1,5mm x 90mm
26	TULEJA / BUSH	CRK-151	Ø35mm x Ø41mm x 30mm



INDEX: CRK-011

SAMOREGULATOR PRAWY/ ADJUSTING MECHANISM RIGHT



INDEX: CRK-012

SAMOREGULATOR LEWY/ ADJUSTING MECHANISM LEFT



INDEX: CRK-039

USZCZELNIENIA TŁOCZKA/ SEALS



INDEX: CRK-041

POKRYWA ZACISKU Z USZCZELKĄ/ COVER WITH GASKET



INDEX: CRK-059

ŁOŻYSKA IGIEŁKOWE/ ROLLER BEARINGS



INDEX: CRK-070

ZAŚLPEKA/ CAP

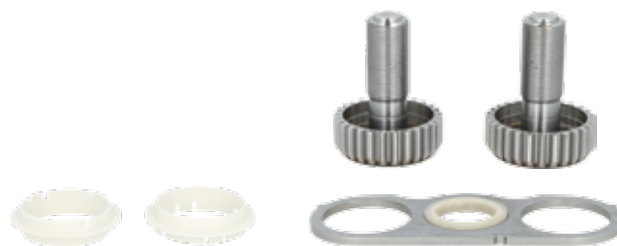

INDEX: CRK-075

MECHANIZM REGULATORA/ ADJUSTING MECHANISM

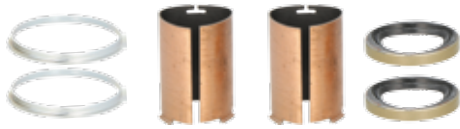

INDEX: CRK-092

USZCZELNIENIA MECHANIZMU REGULACJI/ ADJUSTING MECHANISM SEALS



INDEX: CRK-098

TŁOCZKI/ TAPPETS



INDEX: CRK-101

ŚRUBY/ SCREWS



INDEX: CRK-114

ZABEZPIECZENIE KLOCKÓW/ PAD RETAINER KIT



INDEX: CRK-127

USZCZELNIENIA, ŚRUBY/ PINS AND DUST RUBBERS SET



INDEX: CRK-131

MECHANIZM REGULATORA/ ADJUSTING MECHANISM

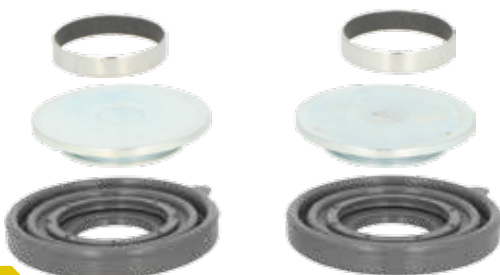

INDEX: CRK-156

TŁOCZKI/ TAPPETS

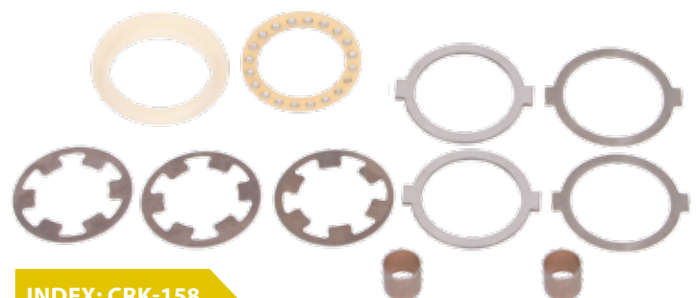

INDEX: CRK-158

ZESTAW MECHANIZMU REGULACJI/ ADJUSTING MECHANISM



INDEX: CRK-160

ZĄŚLEPKA/ CAP



INDEX: CRK-234

ŁAPA WYCISKOWA/ LEVER



INDEX: CRK-235

PODSTAWA ŁOZYSKA/ BEARINGS HOUSING



INDEX: CRK-330

MECHANIZM ZACISKU/ ADJUSTING MECHANISM



INDEX: CRK-331

USZCZELKA ZACISKU/ COVER GASKET

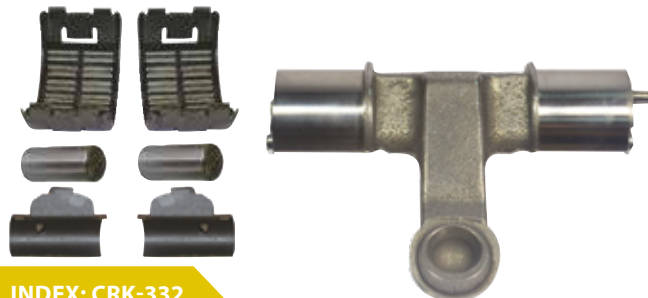

INDEX: CRK-332

ŁAPA WYCISKOWA/ LEVER



INDEX: CRK-333

OBUDOWA SAMOREGULATORA/ ADJUSTING MECHANISM HOUSING

B/ C/ D DUCO

MERITOR B/ C/ D/ DUCO





INDEX: CRK-043

ŚRUBY, SWORZNI, OSŁONY, TULEJKI/ PINS AND DUST RUBBERS SET

NR	NAZWA ELEMENTU	INDEX	WYMIARY
10	TULEJA / BUSH	CRK-043 , CRK-153	Ø35mm x Ø39mm x 30mm
27	SWORZEŃ / PIN	CRK-043 , CRK-153	Ø35mm x 102mm
28	SWORZEŃ / PIN	CRK-043	Ø35mm x 60mm
29	ŚRUBA / SCREW	CRK-043 , CRK-153	M20x2mm x 125mm
30	ŚRUBA / SCREW	CRK-043	M20x2mm x 80mm
31	TULEJA / BUSH	CRK-043	Ø35 x Ø40mm x 77mm
32	TULEJA / BUSH	CRK-153	Ø35mm x Ø40mm x 36mm



INDEX: CRK-153

RUBY, SWORZNI, TULEJE, OSŁONY/ PINS AND DUST RUBBERS SET



INDEX: CRK-148

ŚRUBY, SWORZNI, TULEJE, OSŁONY/ PINS AND DUST RUBBERS SET



INDEX: CRK-320

PROWADNICE I USZCZELNIENIA/ PINS AND DUST RUBBERS SET



INDEX: CRK-054

TŁOCZKI Z OSŁONAMI/ TAPPETS WITH SEALS



INDEX: CRK-031

ZESTAW SAMOREGULATORA Z TŁOCZKAMI LEWY/ ADJUSTING MECHANISM WITH PISTONS LEFT



INDEX: CRK-030

ZESTAW SAMOREGULATORA Z TŁOCZKAMI PRAWY/ ADJUSTING MECHANISM WITH PISTONS RIGHT



INDEX: CRK-039

USZCZELNIENIA TŁOCZKA/ SEALS



INDEX: CRK-027

SAMOREGULATOR LEWY/ ADJUSTING MECHANISM LEFT



INDEX: CRK-149

SAMOREGULATOR PRAWY/ ADJUSTING MECHANISM RIGHT



INDEX: CRK-150

SAMOREGULATOR FRONTALNY/ ADJUSTING MECHANISM FRONT



INDEX: CRK-026

ZESTAW SAMUREGULATORA LEWY/ ADJUSTING MECHANISM LEFT



INDEX: CRK-025

ZESTAW SAMUREGULATORA PRAWY/ ADJUSTING MECHANISM RIGHT



INDEX: CRK-286

WIDŁKI/ FORK



INDEX: CRK-287

ELEMENT REGULATORA/ ADJUSTING MECHANISM



INDEX: CRK-232

ŁAPA WYCISKOWA LEWA/ LEVER LEFT



INDEX: CRK-233

ŁAPA WYCISKOWA PRAWA/ LEVER RIGHT



INDEX: CRK-322

ŁAPA WYCISKOWA/ LEVER



INDEX: CRK-059

ŁOŻYSKA IGIEŁKOWE/ ROLLER BEARINGS

**INDEX: CRK-070**

ZAŚLPEKA/ CAP

**INDEX: CRK-066**

USZCZELKA POKRYWY/ COVER GASKET

**INDEX: CRK-019**

USZCZELKA POKRYWY/ COVER GASKET

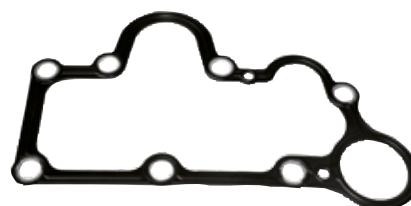
**INDEX: CRK-022**

USZCZELKA POKRYWY/ COVER GASKET

C LISA/ D LISA

MERITOR C LISA/ D LISA



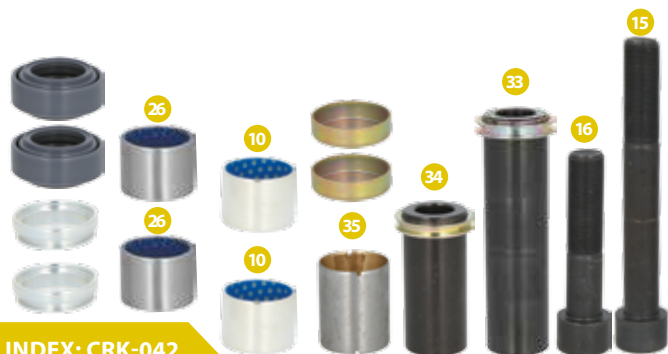

NR	NAZWA ELEMENTU	INDEX	WYMIARY
33	SWORZEŃ / PIN	CRK-042	Ø35mm x 132mm
34	SWORZEŃ / PIN	CRK-042	Ø35mm x 79mm
15	ŚRUBA / SCREW	CRK-042	M20x1,5mm x 150mm
16	ŚRUBA / SCREW	CRK-042	M20x1,5mm x 90mm
26	TULEJA / BUSH	CRK-042	Ø35mm x Ø41mm x 30mm
10	TULEJA / BUSH	CRK-042	Ø35mm x Ø39mm x 30mm
35	TULEJA / BUSH	CRK-042	Ø35-36mm x Ø39mm x 47mm

INDEX: CRK-042

ŚRUBY, SWORZNIĘ, OSŁONY, TULEJKI / PINS AND DUST RUBBERS SET



INDEX: CRK-006

MECHANIZM REGULACJI PRAWY/ ADJUSTING MECHANISM RIGHT



INDEX: CRK-119

MECHANIZM REGULACJI LEWY/ ADJUSTING MECHANISM LEFT



INDEX: CRK-291

TRZON PRAWY/ SPLINE SHAFT RIGHT



INDEX: CRK-130

TRZON LEWY/ SPLINE SHAFT LEFT



INDEX: CRK-037

REGULATOR PRAWY/ ADJUSTING MECHANISM RIGHT



INDEX: CRK-038

REGULATOR LEWY/ ADJUSTING MECHANISM LEFT



INDEX: CRK-072

SAMOREGULATOR PRAWY/ ADJUSTING MECHANISM RIGHT



INDEX: CRK-073

SAMOREGULATOR LEWY/ ADJUSTING MECHANISM LEFT



INDEX: CRK-033

ZESTAW USZCZELEK/ SEALS KIT



INDEX: CRK-062

ŁOŻYSKA/ BEARINGS



INDEX: CRK-065

SPRĘŻYNA/ SPRING



INDEX: CRK-236

ŁAPA WYCISKOWA/ LEVER



INDEX: CRK-292

PŁYTKA DOCISKOWA/ PUSHING PLATE

D3



MERITOR D3



INDEX: CRK-392

SWORZNIĘ, TULEJE, ŚRUBY/ PINS AND DUST RUBBERS SET

NR	NAZWA ELEMENTU	INDEX	WYMIARY
36	SWORZEŃ / PIN	CRK-392	Ø32mm x 117mm
37	SWORZEŃ / PIN	CRK-392	Ø32mm x 73mm
38	ŚRUBA / SCREW	CRK-392	M18x1,5mm x 119mm
39	ŚRUBA / SCREW	CRK-392	M18x1,5mm x 94mm
40	TULEJA / BUSH	CRK-392	Ø32mm x Ø36mm x 40mm
41	TULEJA / BUSH	CRK-392	Ø32mm x Ø36mm x 30mm



INDEX: CRK-013

POKRYWA SAMOREGULATORA/ ADJUSTING MECHANISM HOUSING



INDEX: CRK-017

ZESTAW SAMUREGULATORA PRAWY/ ADJUSTING MECHANISM RIGHT



INDEX: CRK-018

ZESTAW SAMUREGULATORA LEWY/ ADJUSTING MECHANISM LEFT



INDEX: CRK-391

PŁYTA DOCISKOWA/ PUSHING PLATE



INDEX: CRK-044

RUBA PRAWA/ SCREW RIGHT



INDEX: CRK-045

ŚRUBA LEWA/ SCREW LEFT



INDEX: CRK-095

ŁOŻYSKO/ BEARINGS



INDEX: CRK-121

PODKŁADKA PLASTIKOWA/ BOOT



INDEX: CRK-226

TRZON LEWY/ SPLINE SHAFT LEFT

48 ZĘBÓW



INDEX: CRK-227

TRZON PRAWY/ SPLINE SHAFT RIGHT

48 ZĘBÓW



INDEX: CRK-230

TRZON LEWY/ SPLINE SHAFT LEFT

26 ZĘBÓW



INDEX: CRK-231

TRZON PRAWY/ SPLINE SHAFT RIGHT

26 ZĘBÓW



INDEX: CRK-228

TRZON LEWY/ SPLINE SHAFT LEFT



INDEX: CRK-229

TRZON PRAWY/ SPLINE SHAFT RIGHT



INDEX: CRK-393

DZWIGNIA ZACISKU/ LEVER

26 ZĘBÓW



INDEX: CRK-394

DZWIGNIA ZACISKU/ LEVER

48 ZĘBÓW



ZESTAWY NAPRAWCZE ZACISKÓW
BRAKE DISC REPAIR KITS
WABCO

PAN 17

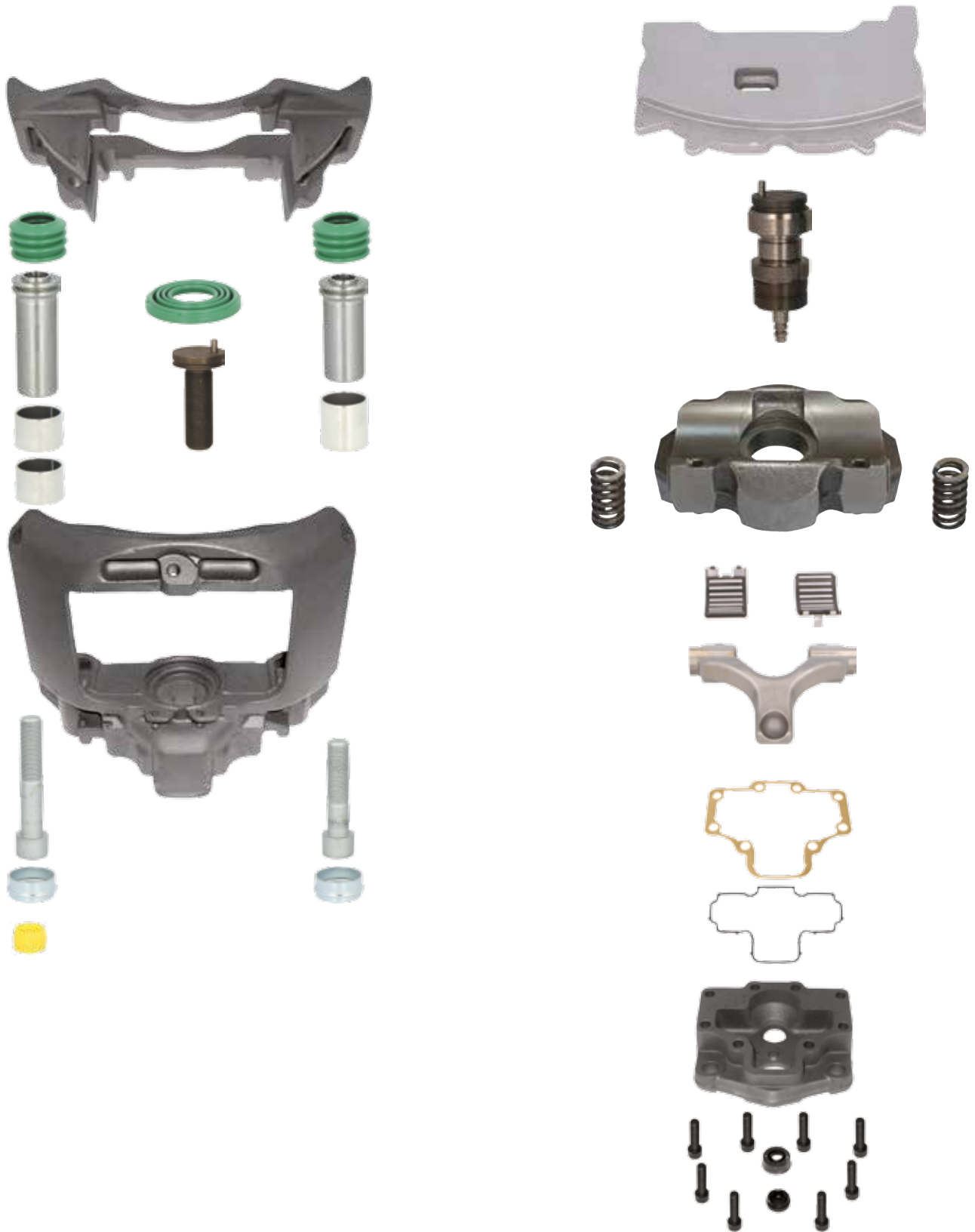

WABCO PAN 17



INDEX: CRK-055

ŚRUBY, SWORZNI, OSŁONY, TULEJKI/ PINS AND DUST RUBBERS SET

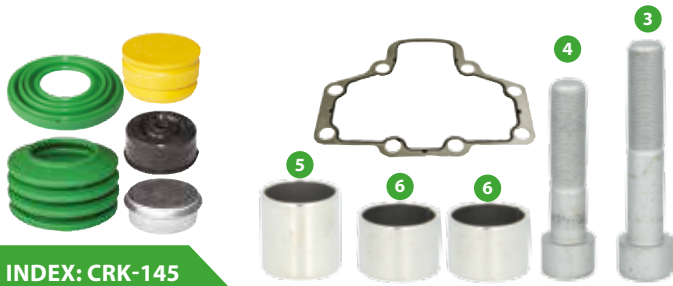

INDEX: CRK-145

USZCZELKI, ŚRUBY, TULEJE/ PINS AND DUST RUBBERS SET



INDEX: CRK-321

USZCZELNIENIA I ŚRUBY/ PINS AND DUST RUBBERS SET



INDEX: CRK-020

OSŁONY, TULEJE, ZAŚLEPKI/ PINS AND DUST RUBBERS SET



INDEX: CRK-122

USZCZELKA/ GASKET

NR	NAZWA ELEMENTU	INDEX	WYMIARY
1	SWORZEŃ / PIN	CRK-055, CRK-103, CRK-316	Ø30mm x 88mm
2	SWORZEŃ / PIN	CRK-055, CRK-103, CRK-316	Ø30mm x 75mm
3	ŚRUBA / SCREW	CRK-055, CRK-103, CRK-145, CRK-316, CRK-321	M16x1,5mm x 87mm
4	ŚRUBA / SCREW	CRK-055, CRK-103, CRK-145, CRK-316, CRK-321	M16x1,5mm x 70mm
5	TULEJA / BUSH	CRK-055, CRK-145, CRK-321, CRK-020, CRK-177	Ø30mm x Ø34mm x 35mm
6	TULEJA / BUSH	CRK-055, CRK-145, CRK-321, CRK-020, CRK-177	Ø30mm x Ø34mm x 25mm



INDEX: CRK-316

PROWADNICE I ŚRUBY/ PINS AND DUST RUBBERS SET



INDEX: CRK-103

ŚRUBY, SWORZNI, OSŁONY, TULEJKI/ PINS AND DUST RUBBERS SET



INDEX: CRK-177

TULEJKI/ BUSHINGS



INDEX: CRK-115

ŁAPA WYCISKOWA/ LEVER



INDEX: CRK-128

PŁYTA DOCISKOWA (PRAWA)/ PUSHING PLATE (RIGHT)



INDEX: CRK-129

PŁYTA DOCISKOWA (LEWA)/ PUSHING PLATE (LEFT)



INDEX: CRK-036

ŁOŻYSKA IGIEŁKOWE/ ROLLER BEARINGS



INDEX: CRK-212

REGULATOR BEZ WSPORNIKA/ ADJUSTING MECHANISM



INDEX: CRK-201

REGULATOR Z WSPORNIKIEM/ ADJUSTING MECHANISM WITH HOUSING



INDEX: CRK-306

PODPORA REGULATORY / SHAFT HOUSING



INDEX: CRK-214

TŁOCZEK REGULATORY/ CALIBRATION BOLT DŁ. TŁOCZKA 87MM

PAN 19

WABCO PAN 19

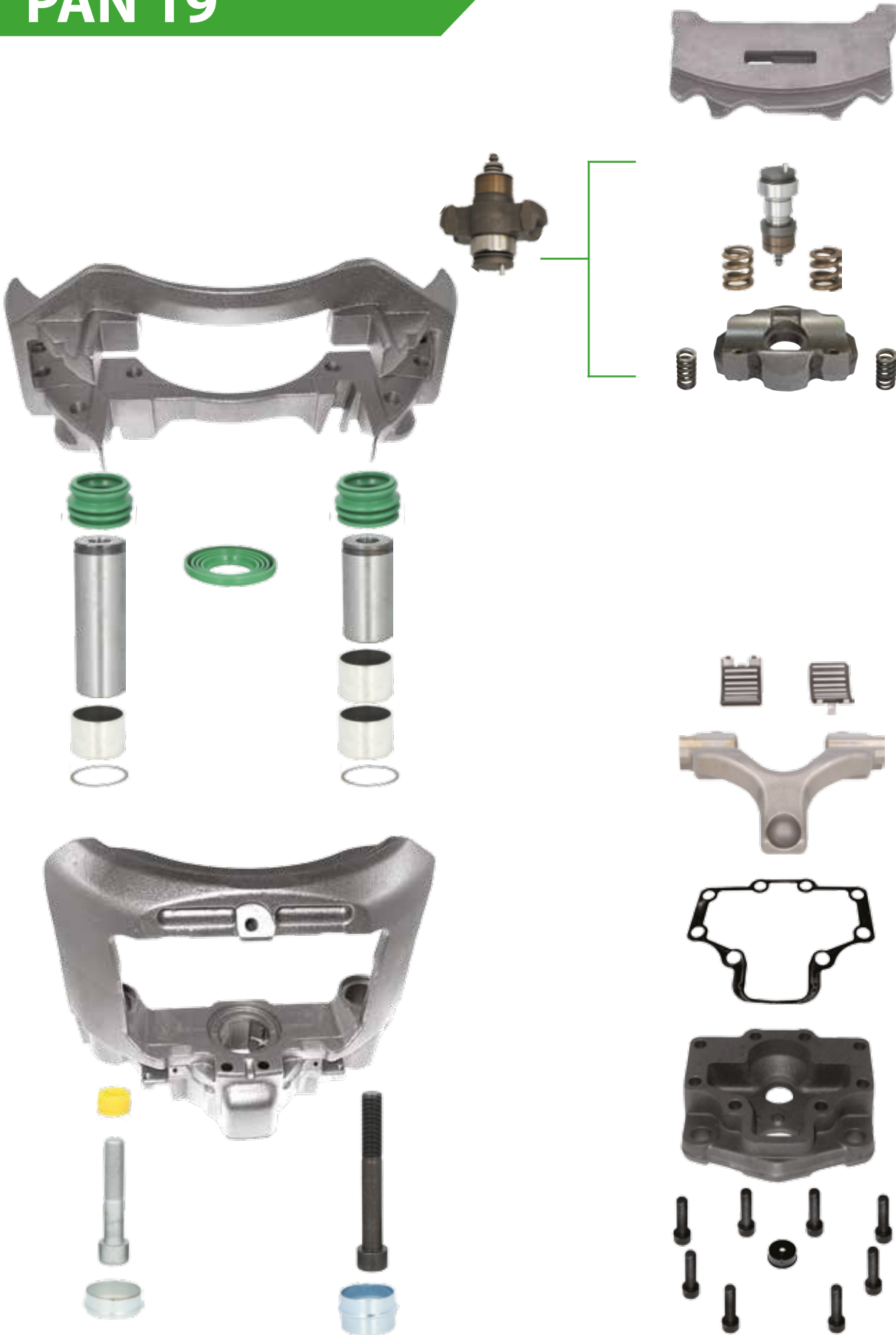

NR	NAZWA ELEMENTU	INDEX	WYMIARY
7	SWORZEŃ / PIN	CRK-146	Ø38mm x 120mm
8	SWORZEŃ / PIN	CRK-146	Ø38mm x 76mm
9	ŚRUBA / SCREW	CRK-146	M16x1,5mm x 120mm
10	ŚRUBA / SCREW	CRK-146	M16x1,5mm x 80mm
11	TULEJA / BUSH	CRK-146, CRK-126	Ø38mm x Ø42mm x 30mm



INDEX: CRK-146

ŚRUBY, SWORZNI, TULEJE, OSŁONY/ PINS AND DUST RUBBERS SET



INDEX: CRK-120

ŚRUBY, SWORZNI, OSŁONY, TULEJKI, TŁOCZKI/ PINS AND DUST RUBBERS SET



INDEX: CRK-126

USZCZELNIENIA, TULEJE/ PINS AND DUST RUBBERS SET

WABCO PAN 19

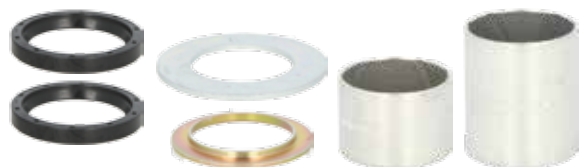

INDEX: CRK-177

TULEJKI/ BUSHINGS



INDEX: CRK-036

ŁOŻYSKA IGIEŁKOWE/ ROLLER BEARINGS



INDEX: CRK-115

ŁAPA WYCISKOWA/ LEVER



INDEX: CRK-124

PŁYTA DOCISKOWA (PRAWA)/ PUSHING PLATE (RIGHT)



INDEX: CRK-125

PŁYTA DOCISKOWA (LEWA)/ PUSHING PLATE (LEFT)



INDEX: CRK-202

EGULATOR Z WSPORNIKIEM/ ADJUSTING MECHANISM WITH HOUSING



INDEX: CRK-122

USZCZELKA/ GASKET



INDEX: CRK-213

REGULATOR BEZ WSPORNIKA/ ADJUSTING MECHANISM



INDEX: CRK-215

TŁOCZEK REGULATORA/ CALIBRATION BOLT DŁ. TŁOCZKA 91MM



INDEX: CRK-307

PODPORA REGULATORA / SHAFT HOUSING



INDEX: CRK-318

USZCZELKA/ GASKET

PAN 22

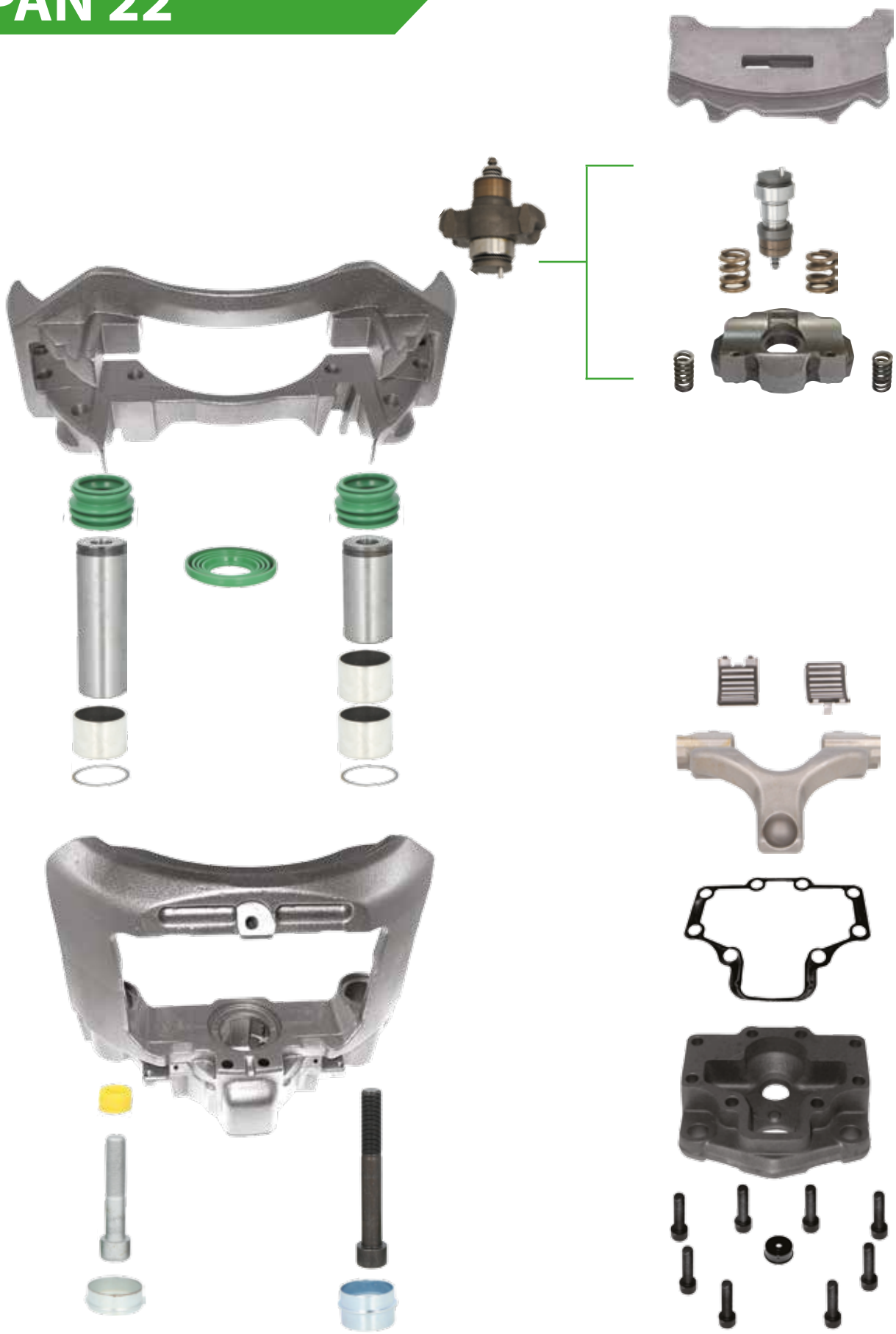

WABCO PAN 22



INDEX: CRK-146

ŚRUBY, SWORZNI, TULEJE, OSŁONY/ PINS AND DUST RUBBERS SET



INDEX: CRK-120

ŚRUBY, SWORZNI, OSŁONY, TULEJKI, TŁOCZKI/ PINS AND DUST RUBBERS SET

NR	NAZWA ELEMENTU	INDEX	WYMIARY
7	SWORZEŃ / PIN	CRK-146	Ø38mm x 120mm
8	SWORZEŃ / PIN	CRK-146	Ø38mm x 76mm
9	ŚRUBA / SCREW	CRK-146	M16x1,5mm x 120mm
10	ŚRUBA / SCREW	CRK-146	M16x1,5mm x 80mm
11	TULEJA / BUSH	CRK-146, CRK-126	Ø38mm x Ø42mm x 30mm



INDEX: CRK-126

USZCZELNIENIA, TULEJE/ PINS AND DUST RUBBERS SET

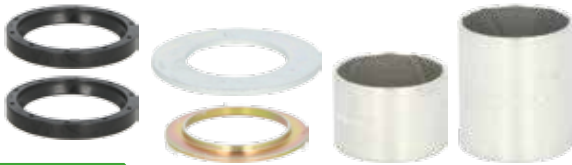

INDEX: CRK-177

TULEJKI/ BUSHINGS



INDEX: CRK-036

ŁOŻYSKA IGIEŁKOWE/ ROLLER BEARINGS



INDEX: CRK-115

ŁAPA WYCISKOWA/ LEVER



INDEX: CRK-181

PŁYTA DOCISKOWA (PRAWA)/ PUSHING PLATE (RIGHT)



INDEX: CRK-182

PŁYTA DOCISKOWA (LEWA)/ PUSHING PLATE (LEFT)



INDEX: CRK-202

EGULATOR Z WSPORNIKIEM/ ADJUSTING MECHANISM WITH HOUSING

**INDEX: CRK-122**

USZCZELKA/ GASKET

**INDEX: CRK-213**

REGULATOR BEZ WSPORNIKA/ ADJUSTING MECHANISM

**INDEX: CRK-215**

TŁOCZEK REGULATORY/ CALIBRATION BOLT DŁ. TŁOCZKA 91MM

**INDEX: CRK-307**

PODPORA REGULATORY / SHAFT HOUSING

**INDEX: CRK-318**

USZCZELKA/ GASKET

MAXX 22

WABCO MAXX 22

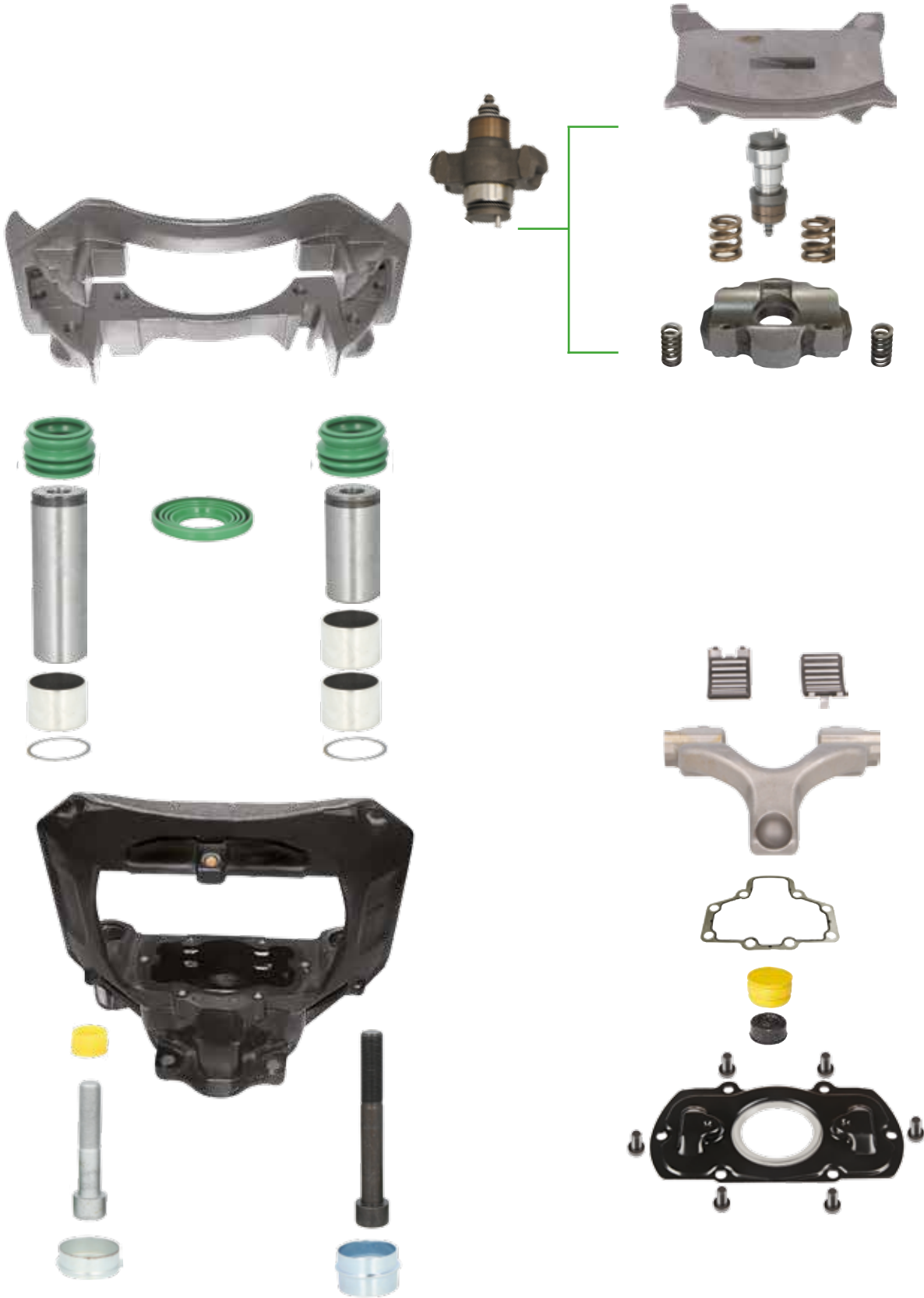

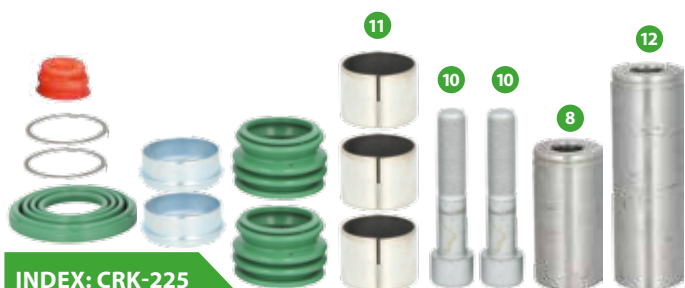

INDEX: CRK-225

ŚRUBY, SWORZNIĘ, OSŁONY, TULEJKI/ PINS AND DUST RUBBERS SET

NR	NAZWA ELEMENTU	INDEX	WYMIARY
12	SWORZEŃ / PIN	CRK-225	Ø38mm x 118mm
8	SWORZEŃ / PIN	CRK-225	Ø38mm x 76mm
10	ŚRUBA / SCREW	CRK-225	M16x1,5mm x 80mm
11	TULEJA / BUSH	CRK-225	Ø38mm x Ø42mm x 30mm



INDEX: CRK-218

ŁAPA WYCISKOWA/ LEVER

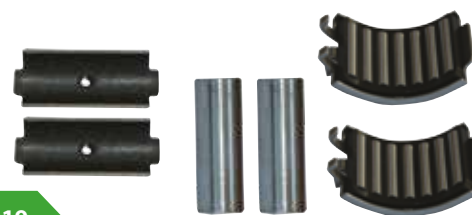

INDEX: CRK-219

ŁOŻYSKA IGIEŁKOWE/ ROLLER BEARINGS



INDEX: CRK-220

PŁYTA DOCISKOWA (PRAWA)/PUSHING PLATE (RIGHT)



INDEX: CRK-221

PŁYTA DOCISKOWA (LEWA)/ PUSHING PLATE (LEFT)



INDEX: CRK-222

REGULATOR BEZ WSPORNIKA/ ADJUSTING MECHANISM



INDEX: CRK-223

REGULATOR Z WSPORNIKIEM/ ADJUSTING MECHANISM WITH HOUSING



INDEX: CRK-224

TŁOCZEK REGULATORY/ CALIBRATION BOLT



INDEX: CRK-308

PODPORA REGULATORY / SHAFT HOUSING



INDEX: CRK-335

ZESTAW MONTAŻOWY KLOCKA/ PAD RETAINER KIT



INDEX: CRK-386

POKRYWA/ COVER

PAN 19-2, 22-2



WABCO PAN 19-2, 22-2



INDEX: CRK-385

TULEJE, SWORZNI/ PINS AND DUST RUBBERS SET

NR	NAZWA ELEMENTU	INDEX	WYMIARY
13	SWORZEŃ / PIN	CRK-385	Ø38mm x 128mm
14	SWORZEŃ / PIN	CRK-385	Ø38mm x 70mm
15	ŚRUBA / SCREW	CRK-385	M16x1,5mm x 130mm
10	ŚRUBA / SCREW	CRK-385	M16x1,5mm x 80mm
11	TULEJA / BUSH	CRK-385	Ø38mm x Ø42mm x 30mm



INDEX: CRK-384

TŁOCZKI/TAPPETS



INDEX: CRK-216

ŚRUBA KALIBRUJĄCA LEWA/ CALIBRATION BOLT LEFT



INDEX: CRK-217

ŚRUBA KALIBRUJĄCA PRAWA/ CALIBRATION BOLT RIGHT



INDEX: CRK-309

MOSTEK/ SHAFT HOUSING



INDEX: CRK-211

ŁOŻYSKA IGIEŁKOWE (WEWNĘTRZNE)/ ROLLER BEARINGS (INNER)

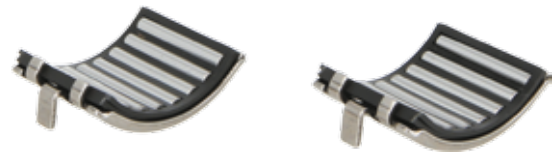

INDEX: CRK-210

ŁOŻYSKA IGIEŁKOWE (ZEWNĘTRZNE)/ ROLLER BEARINGS (OUTER)



INDEX: CRK-367

PODPORA REGULATORA/ SHAFT HOUSING



INDEX: CRK-199

ŁAPA WYCISKOWA/ LEVER

**INDEX: CRK-303**

ELEMENTY ŁAPY WYCISKOWEJ/ LEVER KIT

**INDEX: CRK-388**

USZCZELKA/ GASKET

**INDEX: CRK-302**

ŁAPA WYCISKOWA KOMPLETNA/ LEVER COMPLETE

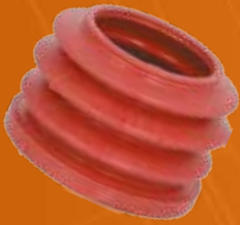

ZESTAWY NAPRAWCZE ZACISKÓW
BRAKE DISC REPAIR KITS
BPW

ECO DISC

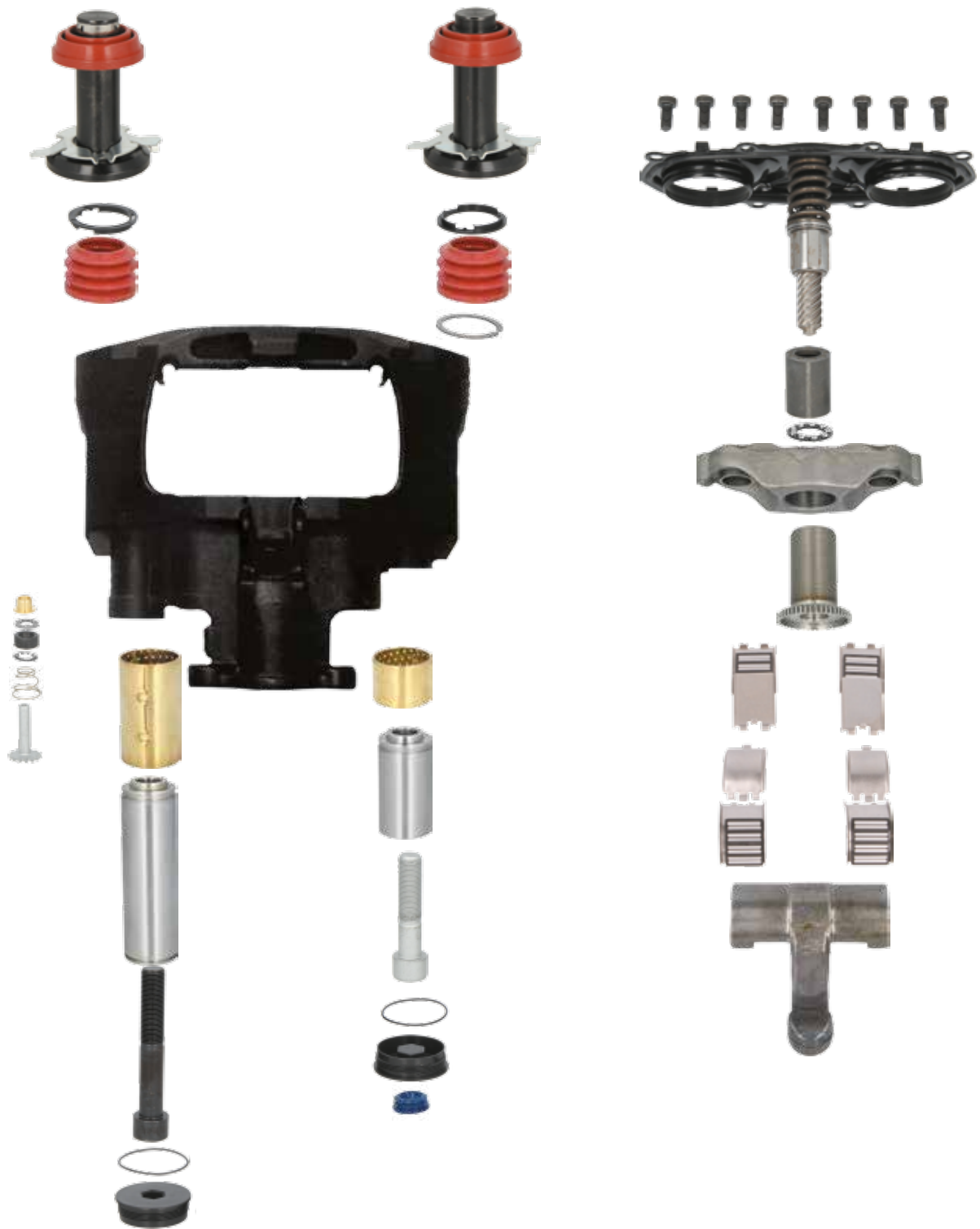

BPW ECO DISC



INDEX: CRK-282

SWORZNIĘ, ŚRUBY, OSŁONY/ PINS AND DUST RUBBERS SET



INDEX: CRK-339

ŚRUBY I SWORZNIĘ/ PINS AND DUST RUBBERS SET

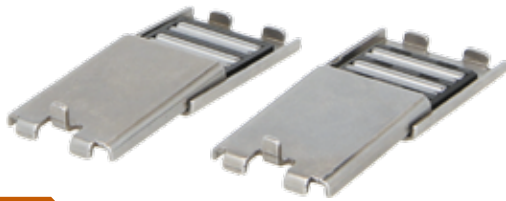

INDEX: CRK-278

ŁOŻYSKA IGIEŁKOWE/ ROLLER BEARINGS



INDEX: CRK-280

ELEMENTY SAMOREGULATORA ZACISKU/ ADJUSTING MECHANISM KIT



INDEX: CRK-275

ŁAPA WYCISKOWA/ LEVER

NR	NAZWA ELEMENTU	INDEX	WYMIARY
1	SWORZEŃ / PIN	CRK-282, CRK-339	Ø37mm x 123mm
2	SWORZEŃ / PIN	CRK-282, CRK-339	Ø36mm x 70mm
3	ŚRUBA / SCREW	CRK-282, CRK-339	M16x1,5mm x 100mm
4	ŚRUBA / SCREW	CRK-282, CRK-339	M16x1,5mm x 70mm
5	TULEJA / BUSH	CRK-282	Ø41mm x Ø37mm x 73mm
6	TULEJA / BUSH	CRK-282	Ø41mm x Ø37mm x 30mm



INDEX: CRK-277

ŁOŻYSKA IGIEŁKOWE/ ROLLER BEARINGS



INDEX: CRK-279

POKRYWA TŁOCZKÓW/ CALIPER COVER



INDEX: CRK-281

ŚRUBA TŁOCZKA/ CALIBRATION BOLT



INDEX: CRK-276

MOSTEK/ SHAFT HOUSING



INDEX: CRK-284

TULEJA TŁOCZKA/ ADJUSTING MECHANISM HOUSING



INDEX: CRK-325

USZCZELNIENIA/ SEALS REPAIR KIT



INDEX: CRK-337

PODSTAWA ŁAPY/ LEVER HOUSING



INDEX: CRK-338

PODSTAWA MECHANIZMU/ MECHANISM HOUSING



INDEX: CRK-283

TŁOCZKI Z OSŁONAMI/ CALIBRATION BOLTS



INDEX: CRK-340

ZESTAW MONTAŻOWY KLOCKA/ PAD RETAINER KIT

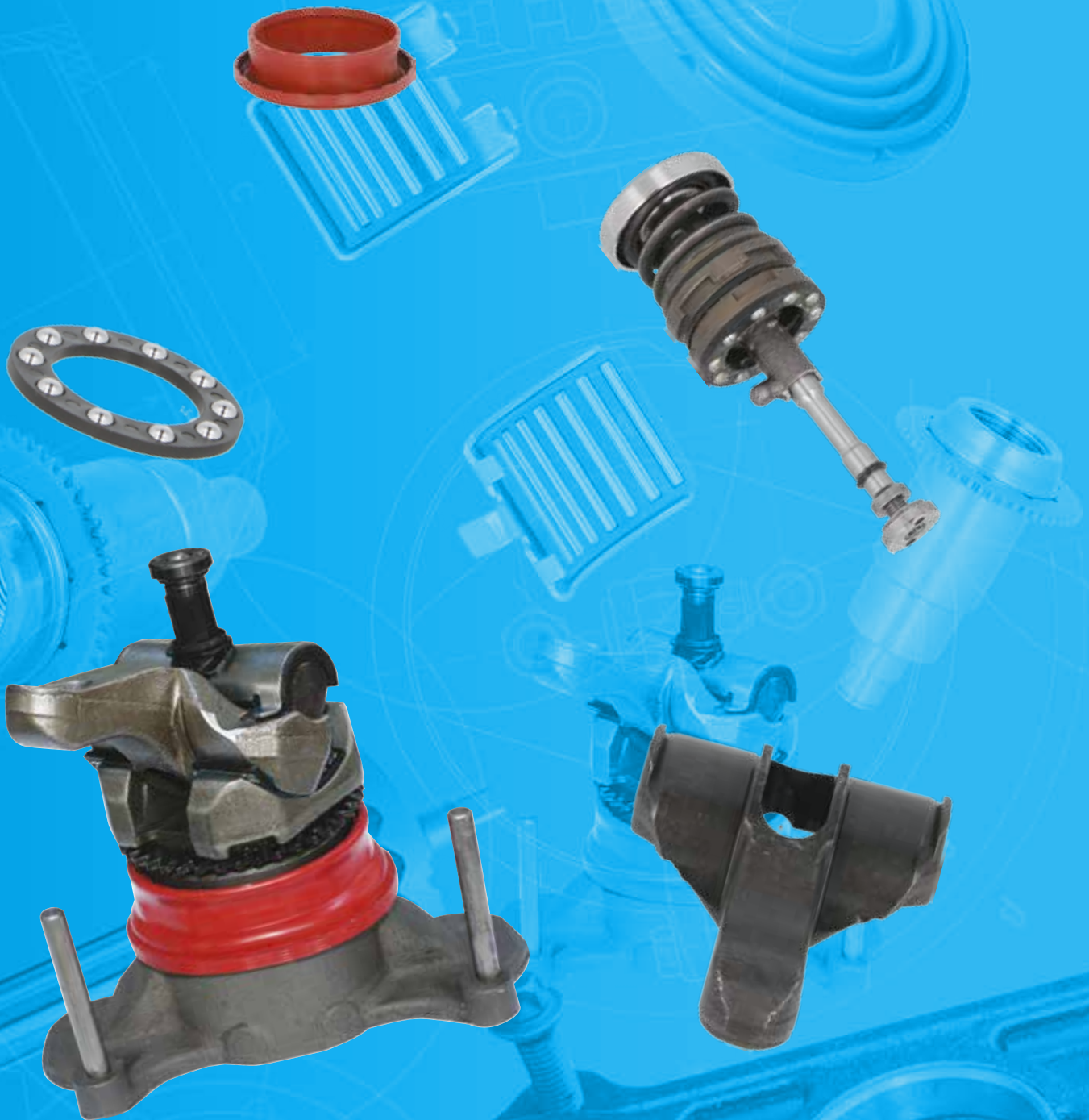

ZESTAWY NAPRAWCZE ZACISKÓW
BRAKE DISC REPAIR KITS
SAF

SBS2220 MODULT



SAF SBS2220 MODULT



INDEX: CRK-265

SWORZNIĘ, ŚRUBY, OSŁONY/ PINS AND DUST RUBBERS SET



INDEX: CRK-268

SWORZEŃ (Ø 35,5mm X 87mm)/ PIN (Ø 35,5X87mm)



INDEX: CRK-271

SAMOREGULATOR ZACISKU/ ADJUSTING MECHANISM



INDEX: CRK-269

ŁAPA WYCISKOWA/ LEVER



INDEX: CRK-273

PODSTAWA ŁOŻYSKA/ BEARINGS HOUSING

NR	NAZWA ELEMENTU	INDEX	WYMIARY
1	SWORZEŃ / PIN	CRK-265	Ø35mm x 120mm
2	SWORZEŃ / PIN	CRK-265, CRK-268	Ø35,5mm x 87mm
3	ŚRUBA / SCREW	CRK-265	M16x1,5mm x 80mm
4	TULEJA / BUSH	CRK-265	Ø35mm x Ø39mm x 30mm



INDEX: CRK-382

PEŁEN MECHANIZM/ COMPLETE MECHANISM



INDEX: CRK-341

ŁOŻYSKA/ ROLLER BEARINGS



INDEX: CRK-342

ŁOŻYSKA/ ROLLER BEARINGS



INDEX: CRK-380

MECHANIZM KALIBRUJĄCY/ CALIBRATION MECHANISM

**INDEX: CRK-267**

USZCZELNIENIE TŁOCZKA/ DUST RUBBER

**INDEX: CRK-381**

MOSTEK/ SHAFT HOUSING

**INDEX: CRK-274**

ŁOŻYSKA SAMOREGULATORA/ BEARINGS SET

**INDEX: CRK-264**

ZĘBATKA REGULATORA/ ADJUSTING GEAR

**INDEX: CRK-266**

ZAŚLEPKA REGULATORA/ SETTING TAPPET

**INDEX: CRK-334**

ZESTAW REGULACJI/ ADJUSTING MECHANISM SET

**INDEX: CRK-272**

ZAŚLEPKA NASTAWNA / ADJUSTING GEAR

**INDEX: CRK-270**

ZABEZPIECZENIE OSI/ LOCKING MECHANISM



ZESTAWY NAPRAWCZE ZACISKÓW
BRAKE DISC REPAIR KITS
HALDEX

MODUL X



HALDEX



INDEX: CRK-263

ŚRUBY, SWORZNIE, OSŁONKI OBIE GEN/ PINS AND DUST RUBBERS SET



INDEX: CRK-249

OBEJMA MECHANIZMU GEN 2/ MECHANISM CLAMP GEN 2



INDEX: CRK-244

MOSTEK GEN 2/ SHAFT HOUSING GEN 2



INDEX: CRK-372

MOSTEK GEN 1/ SHAFT HOUSING GEN 1



INDEX: CRK-245

ŁAPA WYCISKOWA GEN 2/ LEVER GEN 2



INDEX: CRK-371

ŁAPA WYCISKOWA GEN 1/ LEVER GEN 1



INDEX: CRK-246

ŁOŻYSKO IGIEŁKOWE GEN 2/ ROLLER BEARING GEN 2



INDEX: CRK-247

ŁOŻYSKO IGIEŁKOWE GEN 2/ ROLLER BEARING GEN 2



INDEX: CRK-373

ŁOŻYSKO IGIEŁKOWE GEN 1/ ROLLER BEARING GEN 1



INDEX: CRK-374

ŁOŻYSKO IGIEŁKOWE GEN 1/ ROLLER BEARING GEN 1



INDEX: CRK-250

OSŁONA PROWADNICZY OBIE GEN/ PIN RUBBER



INDEX: CRK-253

PŁYTA DOCISKOWA GEN 1/ PUSHING PLATE GEN 1



INDEX: CRK-254

PŁYTA ZACISKU GEN 2/ PUSHING PLATE GEN 2



INDEX: CRK-257

REGULATOR ZACISKU GEN 2/ ADJUSTING MECHANISM GEN 2



INDEX: CRK-258

REGULATOR ZACISKU GEN 2/ ADJUSTING MECHANISM GEN 2



INDEX: CRK-259

REGULATOR ZACISKU GEN 2/ ADJUSTING MECHANISM GEN 2



INDEX: CRK-346

REGULATOR ZACISKU GEN 1/ ADJUSTING MECHANISM GEN 1



INDEX: CRK-347

REGULATOR ZACISKU GEN 1/ ADJUSTING MECHANISM GEN 1



INDEX: CRK-376

REGULATOR ZACISKU GEN 1/ ADJUSTING MECHANISM GEN 1



INDEX: CRK-262

TŁOCZEK GEN 2/ TAPPET GEN 2



INDEX: CRK-377

ŚRUBA KALIBRUJĄCA GEN 1/ CALIBRATION BOLT GEN 1



INDEX: CRK-375

OBEJMA MECHANIZMU GEN 1/ MECHANISM CLAMP GEN 1



INDEX: CRK-343

SPRZĘGIEŁKO OBIE GEN/ GEAR



INDEX: CRK-344

USZCZELNIENIA OBIE GEN/ RUBBERS



INDEX: CRK-345

POKRYWA TŁOCZKÓW OBIE GEN/ TAPPETS COVER



INDEX: CRK-348

SWORZEŃ ŁAPY WYCISKOWEJ GEN 1/ LEVER PIN GEN 1



INDEX: CRK-349

SWORZEŃ ŁAPY WYCISKOWEJ GEN 2/ LEVER PIN GEN 2



INDEX: CRK-378

SWORZNIĘ, ŚRUBY, OSŁONY/ PINS AND DUST RUBBERS SET



INDEX: CRK-379

ZESTAW MONTAŻOWY KLOCKA OBIE GEN/ PAD RETAINER KIT

MARK III

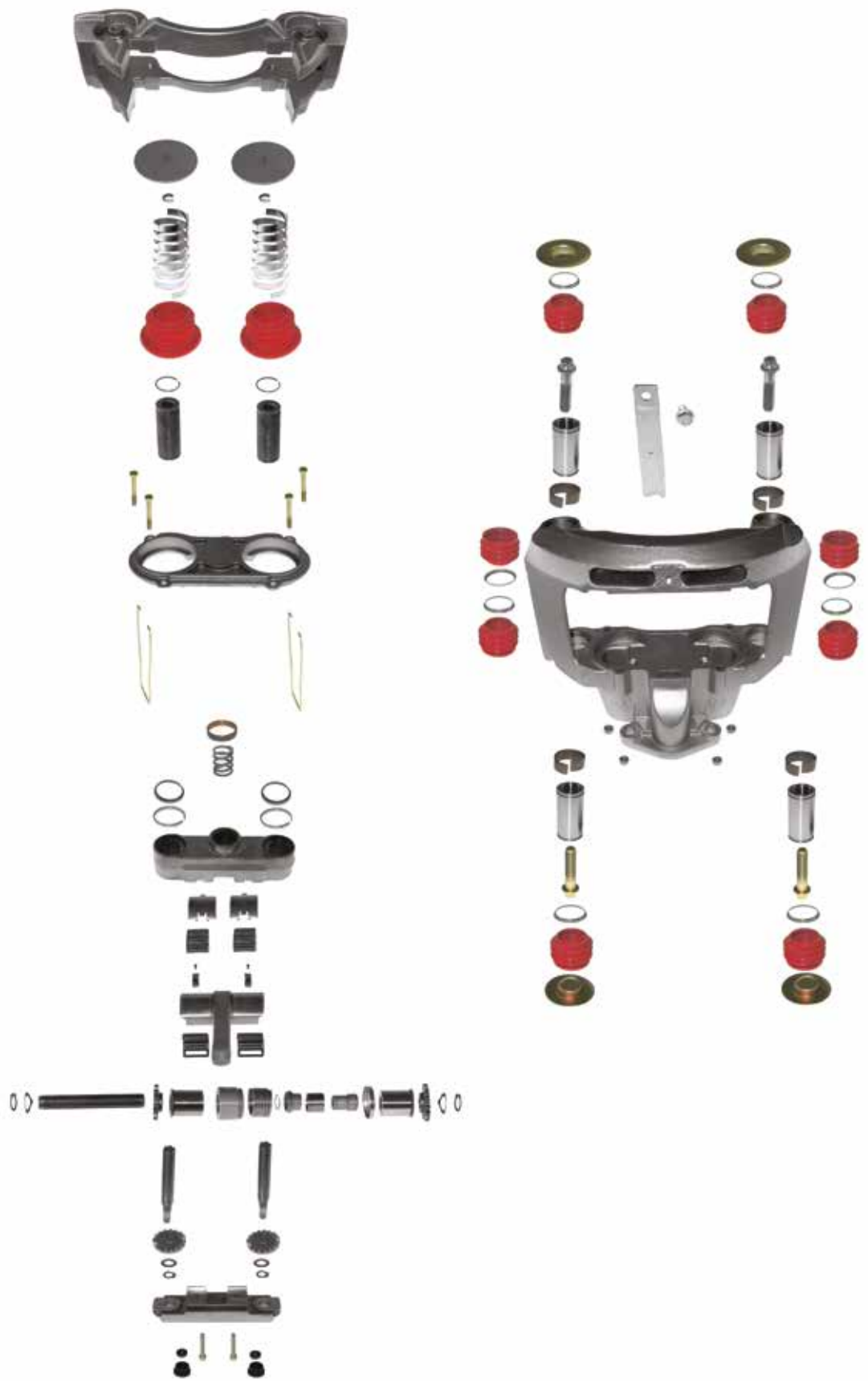

HALDEX MARK III



INDEX: CRK-315

ZESTAW USZCZELNIACZY/ RUBBERS KIT



INDEX: CRK-251

OSŁONA TŁOCZKÓW/ TAPPETS RUBBERS



INDEX: CRK-350

POKRYWA TŁOCZKÓW/ TAPPETS COVER



INDEX: CRK-351

MOSTEK/ SHAFT HOUSING



INDEX: CRK-352

MOSTEK/ SHAFT HOUSING



INDEX: CRK-353

ELEMENT MOCUJĄCY/MOUTING KIT



INDEX: CRK-354

WAŁEK REGULATORA/ SHAFT



INDEX: CRK-355

TŁOCZKI/ TAPPETS



INDEX: CRK-356

ELEMENT WAŁKA REGULATORA PRAWY/ SHAFT KIT



INDEX: CRK-357

ELEMENT WAŁKA REGULATORA LEWY/ SHAFT KIT



INDEX: CRK-358

ŁAPA WYCISKOWA/ LEVER



INDEX: CRK-359

ŁOŻYSKO IGIEŁKOWE/ ROLLER BEARING



INDEX: CRK-360

ŁOŻYSKO IGIEŁKOWE/ROLLER BEARING



INDEX: CRK-315

ZESTAW USZCZELNIACZY/ RUBBERS KIT



INDEX: CRK-251

OSŁONA TŁOCZKÓW/ TAPPETS RUBBERS



INDEX: CRK-252

PŁYTA DOCISKOWA/ PUSHING PLATE



INDEX: CRK-255

REGULATOR ZACISKU/ ADJUSTING MECHANISM



INDEX: CRK-256

REGULATOR ZACISKU/ ADJUSTING MECHANISM



INDEX: CRK-383

REGULATOR ZACISKU/ ADJUSTING MECHANISM



INDEX: CRK-260

KOMPLET ŚRUB REGULATORA/ SCREWS KIT



INDEX: CRK-261

TŁOCZEK/ TAPPETS



INDEX: CRK-248

ŁOŻYSKO IGIEŁKOWE/ ROLLER BEARING



INDEX: CRK-361

POKRYWA TŁOCZKÓW/ TAPPETS COVER



INDEX: CRK-362

MOSTEK/ SHAFT HOUSING



INDEX: CRK-363

MOSTEK/ SHAFT HOUSING

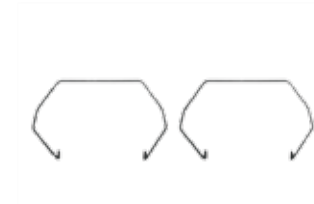

INDEX: CRK-364

ELEMENT MOCUJĄCY/ MOUNTING KIT



INDEX: CRK-365

ŁAPA WYCISKOWA/ LEVER



INDEX: CRK-366

WAŁEK ŁAPY/ LEVER PIN



I C- D7A294

SBP-CAT-CALIPER

Safe **braking** is our priority

www.sbp-brakes.com