

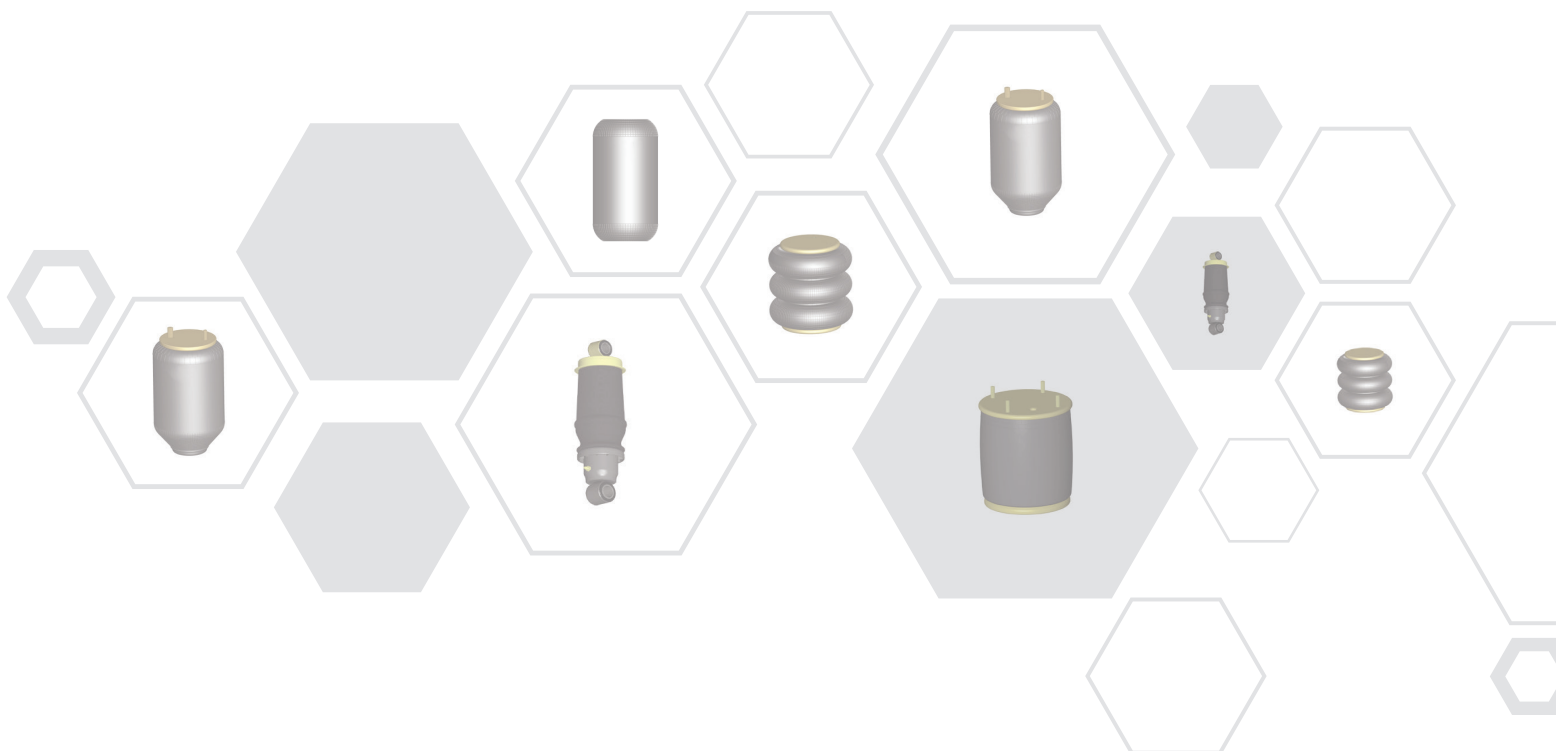

RUN TO THE HIGH TECHNOLOGY



CATALOGUE FOR

AIR SPRINGS



PRODUCT CATALOGUE
ÜRÜN KATALOĐU

REVISION DATE | REVİZYON TARİHİ
JANUARY 2014 | OCAK 2014
1.REVISION | 1.REVİZYON

INDEX



ROLLING LOBE AIR SPRINGS

5-18



COMPLETE TYPE AIR SPRINGS

19-86



SERVICE ASSEMBLY AIR SPRINGS

87-116



CABIN SPRINGS

117-134

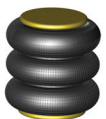

CONVOLUTED AIR SPRINGS

135-144



PRIVILEGE OF SUPPLYING ALL NEEDS FOR COMMERCIAL VEHICLES FROM A SINGLE POINT WITH RANTECH!

RANTECH offers its partners a business model which supplies all of the needs in a single delivery instead of working with different suppliers for each need. Supplying sector specific products for every need with fast delivery, warranty, superior quality and affordable prices, RANTECH minimizes the costs via control from a single center. RANTECH minimizes logistics and operational needs and eliminates quality related problems.

PRIVILEGES OF RANTECH:

Product Variety: Offers a great variety of products which addresses your needs in any category.

Fair Pricing Policy: RANTECH offers solutions to the sector not only with unit prices for sector specific product and service variety but also for minimizing the overall costs with the added value it offers. It develops the best prices and the most affordable cost structure continuously with its powerful procurement infrastructure which follows the market prices and sectoral changes continuously and offers its customers long-term cost minimization opportunities.

Customer Satisfaction: RANTECH adopts a customer-oriented operation principle with a team of experts and after-sales support.

Quality: RANTECH owns a wide network of manufacturers which are specialist in their field for each spare part and perform high quality production.

Quick Delivery: RANTECH supplies the product quickly and delivers them right on time thanks to its powerful logistics infrastructure.

Continuous Development: RANTECH owns a powerful information technologies infrastructure for updating the model numbers and extending the product range.

PRIVILEGE DE FOURNIR TOUS LES BESOINS DES VEHICULES COMMERCIAUX PAR UN SEUL POINT AVEC RANTECH!

RANTECH offre un modèle de travail qui fournit à ses partenaires tous les besoins en une seule fois au lieu de travailler avec de différents fournisseurs pour chaque besoin. RANTECH qui fournit des produits spécifiques au secteur avec une livraison rapide, haute qualité et prix équitable réduit les coûts grâce à sa gestion centralisée. RANTECH élimine les problèmes dû à la qualité en minimalisant les besoins de logistique et d'opération.

LES PRIVILEGES DE RANTECHS

Diversité de Produit : Un éventail de produit pouvant répondre à tous vos besoins dans toutes les catégories.

Politique de Prix équitables: Avec sa diversité de produits et de services RANTECH, offre des solutions qui diminuent non pas seulement le prix unitaire mais aussi le coût global grâce aux valeurs ajoutés.

RANTECH offre à ses clients l'opportunité de diminuer les coûts à long terme en développent une structure de coût et prix pertinents avec sa puissante infrastructure d'achat qui poursuit continuellement les prix du marché et les changements sectoriels.

Satisfaction du Client: RANTECH a adopté le principe de travail orientée vers la clientèle avec notre équipe professionnelle et notre service après-vente.

Qualité: RANTECH possède un large réseau de producteurs professionnels réalisant une production de haute qualité pour toutes sortes de pièces de rechange.

Livraison Rapide: RANTECH fournit très rapidement et ponctuellement les produits grâce à son infrastructure logistique puissante.

Développement Continu: RANTECH possède une infrastructure d'informatique très puissante pour actualiser le nombre de ses modèles et son éventail de produits.

¡RANTECH, LA VENTAJA DE PODER PROVEER DESDE UN SÓLO LUGAR TODAS SUS NECESIDADES EN REPUESTOS PARA LÍNEA PESADA!

RANTECH ofrece a sus clientes un modelo de negocio que provee todas sus necesidades en repuestos para línea pesada desde un solo proveedor en una sola entrega a diferencia de negociar con diferentes proveedores para cada tipo de repuesto. El modelo de negocio de RANTECH reduce los costos operacionales de importación y logística; ofreciendo así productos de alta calidad a precios muy competitivos en un corto plazo de entrega.

LAS VENTAJAS DE RANTECH:

La Amplia Gama de Productos: RANTECH cuenta con una amplia gama de productos para satisfacer sus necesidades de partes, repuestos y accesorios

La Política de Precios Competitivos: RANTECH cuenta con una variedad de productos y servicios específicos de la industria que nos permiten ofrecer soluciones para reducir los costos totales al mínimo; no sólo en los precios unitarios de cada grupo de productos sino también en los valores agregados que brindamos mediante un sólido equipo, el cual constantemente busca las novedades dentro del sector automotriz para así poder ofrecer a sus clientes la oportunidad de reducir sus costos a largo plazo.

La Satisfacción del Cliente: RANTECH brinda sus servicios centrándose en la satisfacción del cliente a través de su equipo especializado y el servicio post venta.

Todos los miembros del equipo de RANTECH cuentan con muchos años de experiencia en el área de repuestos automotrices.

La Mejor Calidad: RANTECH solo ofrece productos de las mejores marcas y fabricas. Todos los productos son aprobados por nuestros personales expertos en control de calidad antes del embarque.

La Rápida Entrega: Gracias a su equipo de logística especializada, RANTECH entrega cualquier tipo de pedido de la forma más rápida disponible.

El Constante Desarrollo: RANTECH aprovecha su moderna infraestructura informática para buscar constantemente los repuestos de los últimos modelos de vehículo disponibles dentro del sector de transporte para así ampliar su gama de productos.

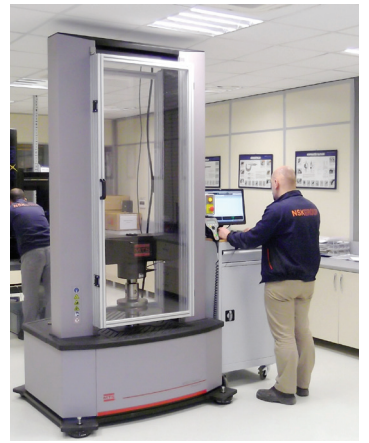

ПРЕИМУЩЕСТВА ПОСТАВКИ ВСЕГО НЕОБХОДИМОГО ДЛЯ ГРУЗОВЫХ АВТОМОБИЛЕЙ ОТ ОДНОГО ПОСТАВЩИКА С RANTECH!

RANTECH предлагает своим партнерам бизнес-модель, которая обеспечивает поставку всего необходимого от одного поставщика, вместо работы с различными поставщиками каждый раз, когда это необходимо. Обеспечивая поставку специфической для сектора продукции, быструю доставку, гарантии, превосходное качество и доступные цены, RANTECH минимизирует расходы, благодаря контролю из одного центра. RANTECH сводит к минимуму расходы на логистику и эксплуатацию, и исключает проблемы, связанные с качеством.

ПРЕИМУЩЕСТВА RANTECH:

Разнообразие продукции: Мы предлагаем большое разнообразие продукции, соответствующей вашим потребностям в любой категории.

Умеренная политика ценообразования: RANTECH предлагает решения для сектора не только по единичным расценкам на специфическую продукцию и услуги, но также предлагает дополнительные преимущества для минимизации общих расходов. Компания предлагает самые лучшие цены и постоянно разрабатывает самые доступные решения, благодаря своей мощной инфраструктуре снабжения, которая отслеживает рыночные цены и изменения в секторе, и предлагает своим заказчикам долгосрочные возможности для сведения к минимуму расходов.

Удовлетворенность клиентов: RANTECH следует принципу работы с ориентацией на клиента вместе с командой экспертов и службой послепродажного обслуживания.

Качество: RANTECH владеет широкой сетью производителей, которые являются специалистами в сфере производства отдельных запасных частей и производят продукцию высокого качества.

Быстрая доставка: RANTECH осуществляет быструю и своевременную поставку продукции, благодаря своей мощной инфраструктуре логистики.

Постоянное развитие: RANTECH владеет мощной инфраструктурой информационных технологий для обновления модельного ряда и расширения ассортимента продукции.

ميزة توريد جميع الاحتياجات للمركبات التجارية من مكان واحد مع رانتيك RANTECH!

رانتيك RANTECH تقدم لشركائها نموذج الأعمال الذي يوفر جميع احتياجات في تسليم واحدة بدلا من العمل مع موردين مختلفين لكل احتياج. إن توريد المنتجات الخاصة بالقطاع لكل احتياج مع سرعة التسليم والضمان والجودة الفائقة والأسعار المعقولة تجعل رانتيك RANTECH تقلل من التكاليف عن طريق التحكم من مركز واحد. رانتيك RANTECH تقلل الأعمال اللوجستية والاحتياجات التشغيلية وتفضي على المشاكل المتعلقة بالجودة.

مميزات رانتيك RANTECH:

تشكيلة المنتجات: تقدم تشكيلة كبيرة ومتنوعة من المنتجات التي تلبى احتياجاتكم في أي فئة.

سياسة التسعير العادلة: رانتيك RANTECH تقدم حلولاً للقطاع ليس فقط في أسعار الوحدات لتشكيلة المنتجات والخدمات الخاصة بالقطاع ولكن أيضا لتقليل التكاليف الإجمالية بالقيمة المضافة التي توفرها. وهي تضع أفضل الأسعار وهيكل التكلفة الأكثر معقولية بشكل مستمر وذلك من خلال بنيتها التحتية القوية للمشتريات والتي تراعي أسعار السوق والتغيرات القطاعية بشكل مستمر وتوفر لعملائها فرص تقليل التكلفة على المدى الطويل **رضا العملاء:** رانتيك RANTECH تتبنى مبدأ التشغيل الموجه لصالح العملاء من خلال فريق من الخبراء وتقديم دعم ما بعد البيع.

الجودة: رانتيك RANTECH تمتلك شبكة واسعة من الشركات المصنعة المتخصصة في مجالها لكل قطعة غيار وتخرج الإنتاج عالي الجودة.

التسليم السريع: رانتيك RANTECH تورد المنتجات بسرعة وتسلمها مباشرة في الوقت المحدد بفضل بنيتها التحتية اللوجستية القوية.

التطوير المستمر: رانتيك RANTECH تمتلك بنية تحتية قوية من تكنولوجيا المعلومات لتحديث أرقام الموديلات وتوسيع نطاق المنتجات.



THE CONSTRUCTION OF A RANTECH AIR SPRING

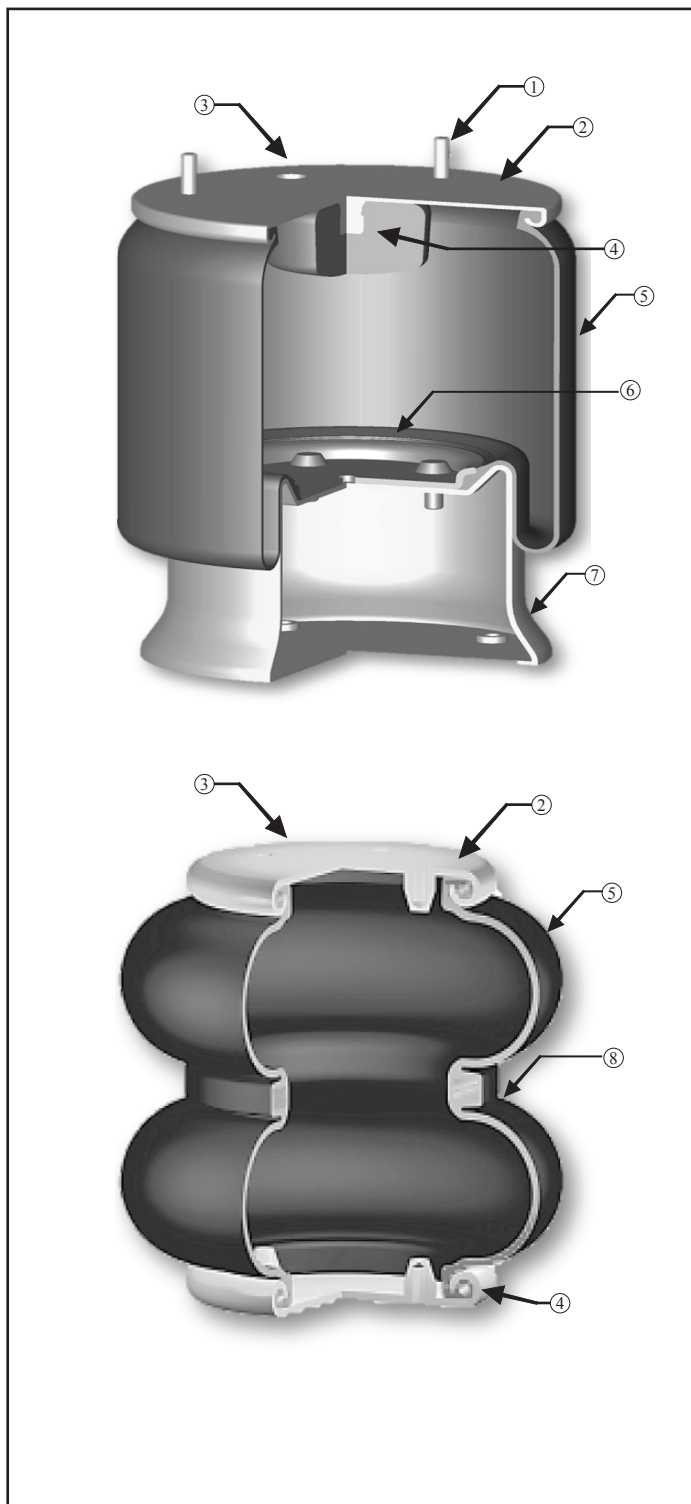

1. Mounting stud

A permanent part of the bead plate assembly fasten the **RANTECH** air spring system to the vehicle's frame.

2. Bead Plate (top plate)

Permanently crimped onto the bellows at the factory allowing complete part leak testing prior to shipment.

3. Air fitting hole

A tapped hole providing air entrance to the **RANTECH** air spring system

4. Internal bumper (optional)

The bumper is a fail-safe device (molded rubber or reinforced plastic) restrict the **RANTECH** air spring system stroke and prevents excessive damage to the vehicle and suspension in the case of sudden air pressure loss.

5. Rubber bellow (Rubber body)

Includes at least four plies or layers, of material, an inner layer, two plies of cord-reinforced fabric and an outer layer

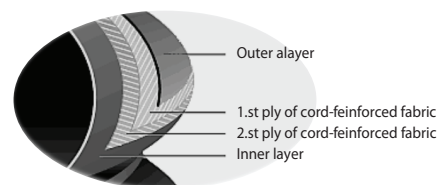

6. Bead plate (bottom plate)

Fasten the correct piston to the service assembly

7. Steel or fibre - reinforced plastic piston

The piston, made form aluminum steel or fiber rein- forced plastic, produces a connection between the **RANTECH** air spring and axle

8. Girdle Hoop

A rubber covered ring between the convoluted types

Installing Rolling Lobe Air Spring without Metal Parts

Warning:

Do not inflate unless properly secured in the suspension system of the vehicle or in some other appropriate structure.

Pressure may not exceed 100 psi / 7 bar. Otherwise there is a danger of injury!

Working temperature: -40°C to 70°C / -40°F to 158°F.

Removing the Old Air Spring:

Jack up the vehicle securely as high as possible. Make sure it cannot fall off its support.

Let the air out of the RANTECH air spring system.

Remove the old air spring.

Please note that for conical rolling lobe RANTECH air spring, the narrow end must be placed on the piston.

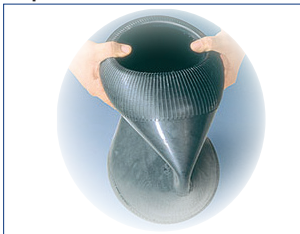

Clean the bead seats on the clamping and springs piston. Check that the mounting hardware is free of burr and is not corroded (replace if necessary). Apply a soap solution or an approved fitting lubricant (not grease) to the bead seat of the piston.



Compress the new RANTECH air spring to a hand's width, while pushing it in below the upper bead.



Place the folded air spring between the piston and the clamping plate.



Fix the lower bead to its seat on the piston and the upper bead to its seat on the clamping plate.



Pressurize the air spring so that its beads fit precisely between the plate and piston. The beads should snap into place. Lower the vehicle and the air spring will automatically roll down the piston. The air spring is now fitted.

Warning

Installation Guidelines:

- Before you start installing an **RANTECH** Air Springs, make sure you have all the necessary tools and equipment to perform the repair safely
- All items are only allowed to be put under pressure in fixtures possessing a lift / stroke limiter

Risk of injury!

- Before installing, check the **RANTECH** Air Spring carefully for any damage it may have suffered from transport or improper storage
- Jack the vehicle as high as possible and secure it against any possible fall
- Control the air entrance and other connections against leaking
- Do not inflate the **RANTECH** Air Spring until it has been secured properly
- The max. operating air pressure is 120 psi (8 bar)
- Operating temperature between -40°C and +70°C
- Fully deflate the **RANTECH** Air Spring before removing
- Provide stroke limitations to prevent the **RANTECH** Air Spring from exceeding the maximum allowable stroke height and minimum compressed height
- Never use the **RANTECH** Air Spring in torsion
- If you are in doubt after fitting the air spring, ask for assistance from a qualified suspension specialist, the suspension manufacturer or the **RANTECH** air spring manufacturer

Warranty Statement

The contents of this publication are the result of many years of research and experience gained in application technology. All information is given in good faith; it does not represent a guarantee with respect to characteristics and does not exempt the user from testing the suitability of products, including checking with respect to industrial property rights of any third parties. No liability whatsoever will be accepted for damage, regardless of its nature and its legal basis, arising from advice given in this publication. Products are subject to technical changes as a result of new developments.

The **RANTECH** Air Spring is assured to be free from defects in material and workmanship by RAN Otomotiv for a period of 18 months from the date on which the first user purchased it. The date of purchase may be proven only by means of a document valid for tax purposes issued by the vendor to the first user which states the details of the retailer in addition to the date. Any user who wishes to make use of the conventional warranty offered by RAN Otomotiv must present aforesaid document, to the **RANTECH** sales staff that will check that they are valid.

RAN Otomotiv declines all responsibility for any damage directly or indirectly caused to persons, objects or directly to the vehicle due to failure to follow what is indicated in this catalogue principally concerning appliance installation, use and maintenance instructions.

ROLLING
LOBE

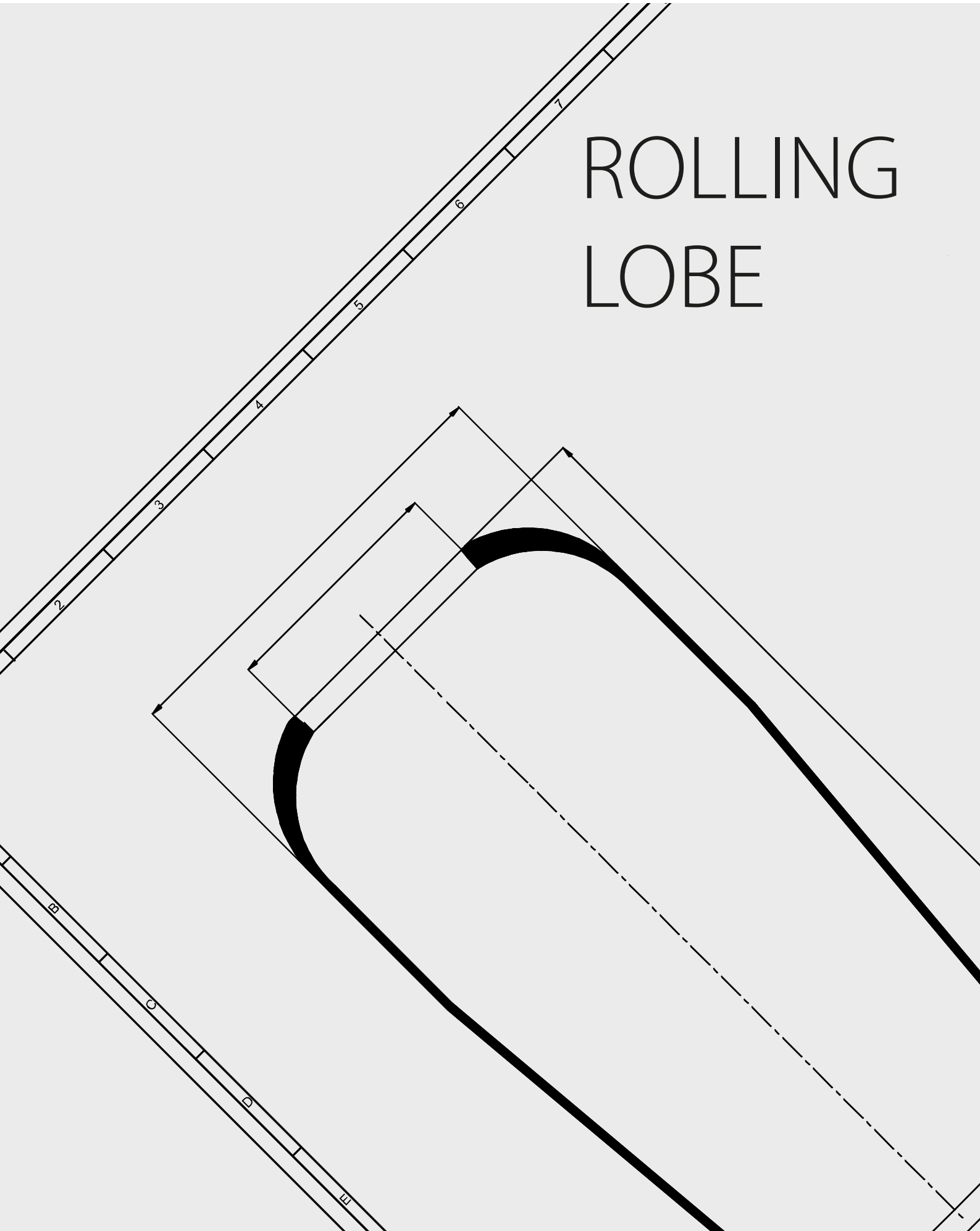

RT1.415.R25

Cross References

Contitech	RZ415 -25
Firestone	1R5P 345 290
	W01095 0381
Good Year	9004
Vibracoustic	V2G20
Phoenix	2 G 20
Springride	D12S08
CF Gomma	1S 280-25 203001

OE Part No

Volvo	3 027 271
-------	-----------

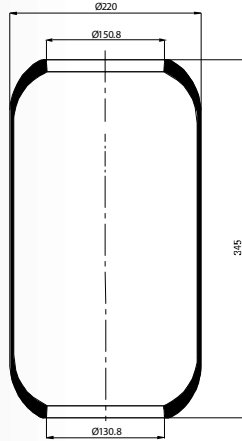

RT1.415.R28

Cross References

Contitech	RZ415 -28
Firestone	W01095 0382
Good Year	9005
Springride	D12S09
CF Gomma	1S 280-28 203000
Vibracoustic	V2G20A
Phoenix	1G 20 A

OE Part No

Volvo	3 027 272
-------	-----------

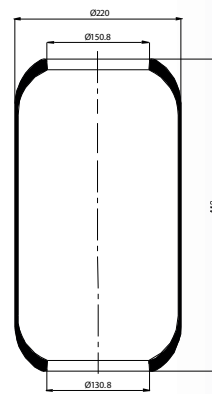

RT1.450.R25

Cross References

Contitech	RZ450 -25
Good Year	9050
Dunlop	D12S 13
CF Gomma	1S 300-27-203386

OE Part No

Evo Bus	A 356 327 0001
Evo Bus	A 356 327 0201
Iveco Bus	93197594
Mb Turk	A 356 327 0001
Mb Turk	A 613 327 0101

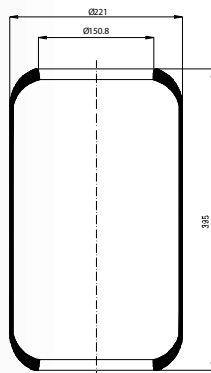

RT1.644.R

Cross References

Contitech	644 N
Firestone	1R 1A 390 295
	W01095 0118
Good Year	8017
Phoenix	1E 21

OE Part No

Breda Menarini	199 196
Daewoo	967 08659
Evo Bus	A 000 327 0101
Evo Bus	A 000 327 0201
Evo Bus	A 307 328 0001
Mercedes (Brazil)	A 364 327 7001
Kassbohrer	4 771 143 000
Kassbohrer	4 771 170 000

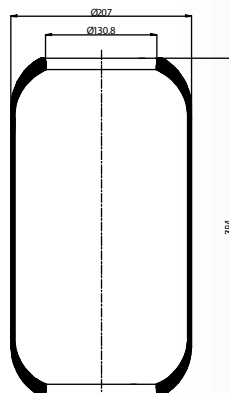

RT1.661.R

Cross References

Contitech	661N
Cf Gomma	89726 1S 310-28
Dunlop	D12S02 RE
Dunlop	PNP 304980 101
Firestone	1R 1C 390 310
Firestone	W01095 0021
Goodyear	8018
Phoenix	1E 25
Taurus	BL 114

OE Part No

Dc	613 327 02 01
Iveco	249 8667
Iveco	418 22247
Iveco	474 6733
Kassbohrer Evo	4.731.012.000
Kassbohrer Evo	4.731.031.000
Kassbohrer Evo	4.731.042.000
Kassbohrer Evo	4.771.427.000

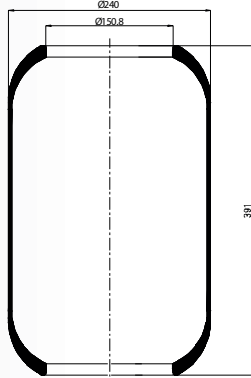

RT1.662.R

Cross References

Contitech	662 N
Firestone	1R 1D 355 355
	W01095 0207
Phoenix	1E 32
Taurus	BI 143
Good Year	9007
Vibracoustic	V1E 32

OE Part No

Bussing	100 110 200
Bussing	100 112 251
Man	81436010018
Man	81436010051
Neoplan	1001 10 200
Neoplan	1001 12 251
Neoplan	AA 10-01-002
Neoplan	AA 10-21-300

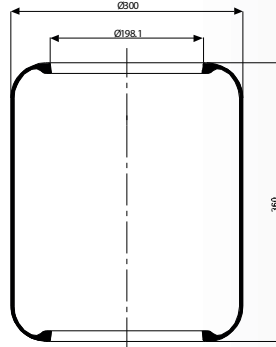

RT1.673.R

Cross References

Contitech	673 N
Firestone	1R1A 370 285
	W01095 0198
Phoenix	1F 21A
Taurus	B 141
Good Year	9051

OE Part No

Breda Menarini	178 623
Breda Menarini	325 993
Evo Bus	A 383 327 0001
Evo Bus	A 621 328 0001
Magirus-deutz	0249 1566
Mercedes	A 383 327 0001
Van Hool	624319-860
Volvo	1611776

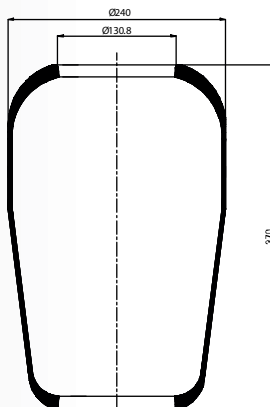

RT1.701.R

Cross References

Contitech	701N
Firestone	1R3M 340 340
	W01095 0205
Phoenix	1E 26-1
Taurus	B 116-1
Good Year	9006

OE Part No

Bova	B 510040
Ikarus	B 510040
Auwarter	B 510040

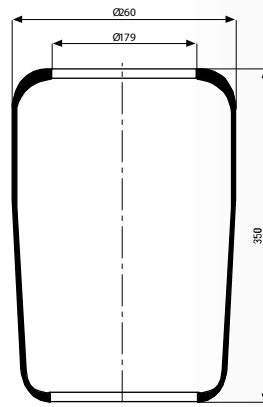

RT1.706.R

Cross References

Contitech	706 N1
Good Year	9067

OE Part No

Man	81436010096
Man	81436010098
Man	81436010101
Man	81436010127
Man	81436010139

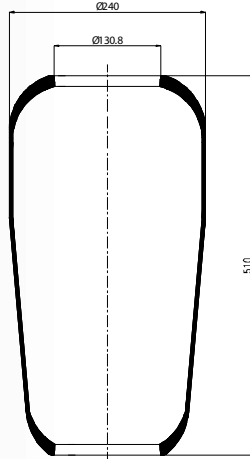

RT1.713.R

Cross References

Contitech	713 N
Phoenix	1F 21D
Good Year	9066

OE Part No

Volvo	1622 116
Volvo	6 797 169

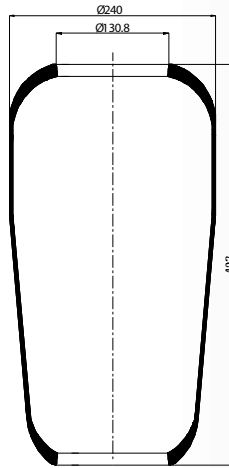

RT1.715.R

Cross References

Contitech	715 N
Firestone	1R1C 355 310
	W01095 0087
Phoenix	1F 25
Taurus	B 144
Good Year	8015

OE Part No

Man	81436010078
Daf	0 659 561
Iveco	4.456.111
Iveco	4.763.473
Renault	5.000.819.517
Volvo	6 885 533
Man	81436010081
Man	81436010060

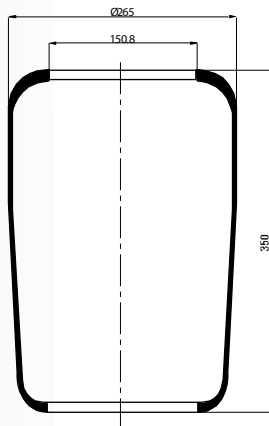

RT1.716.R

Cross References

Contitech	716 N
Firestone	1R2A 450 305
	W01095 0145
Phoenix	1F 26 B-1
Taurus	B 197
Good Year	9073
Cf Gomma	1SC 300-34 92548

OE Part No

Man	81436010039
Man	81436010040
Volvo	1593 842
Volvo	1075 290

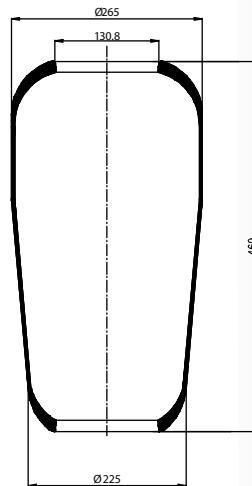

RT1.719.R

Cross References

Contitech	719 N
Firestone	1R2D 530 360
	W01095 0192
Phoenix	1F 32 B
Taurus	B 153
Good Year	8118
Cf Gomma	1SC 360-43 92593

OE Part No

Daf	0 818 225
Bpw	02 200 24 00 0
Evo Bus	4 731 032 000
Gigant	196036
Gigant	166205
Kassbohrer	4 731 032 000
Kassbohrer	4 731 030 000
Kogel	4 731 032 000

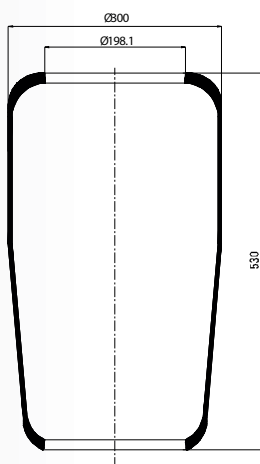

RT1.720.R

Cross References

Contitech	720 N
Firestone	1R2A 460 295
	W01095 0195
Phoenix	1F 21
Taurus	B 152
Good Year	9008
Cf Gomma	1SC 290-30 88802

OE Part No

Man	81436010033
Man	81436010036
Man	81436010037
Mercedes	A 387 328 0101
Volvo	1590 136
Volvo	1622 115
Volvo	1629 193
Bpw	02 200 24 10 0

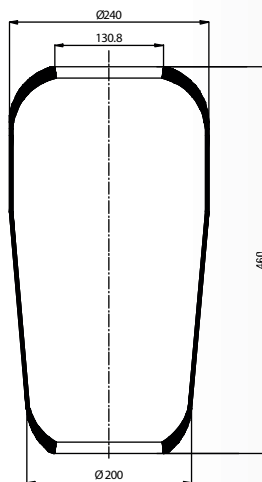

RT1.727.R

Cross References

Contitech	727 N
Firestone	1R2D 460 360
	W01095 0191
Phoenix	1F 32-A
Taurus	B 149
Good Year	8117
Cf Gomma	1SC 360-34 92575

OE Part No

Daf	0 638 148
Daf	0 166 226
Daf	0 196 043
Man	81436010079
Man	81436010082
Man	81436010084
Man	81436010116
Man	81436010056

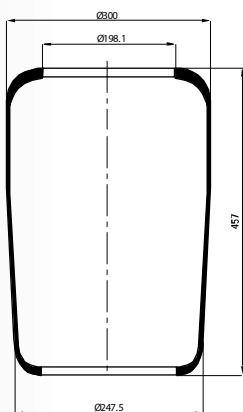

RT1.728.R

Cross References

Contitech	728 N
Firestone	1R2D 470 360
	W01095 0419
Phoenix	1F 32 A
Taurus	B 149
Dunlop Uk	PNP306420100
Good Year	8117
Cf Gomma	1SC 360-34 92575

OE Part No

Schmitz	750 212
---------	---------

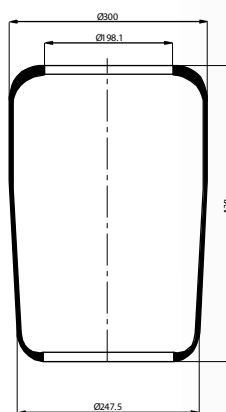

RT1.737.R

Cross References

Contitech	737 N
Firestone	1R1A 480 330
	W01095 0211
Phoenix	1F 26
Taurus	B 127
Good Year	9075
Cf Gomma	1S 323-23 89756

OE Part No

Mercedes	A 393 328 0101
Chereau	VSR U5 00211F
Menarini	178739

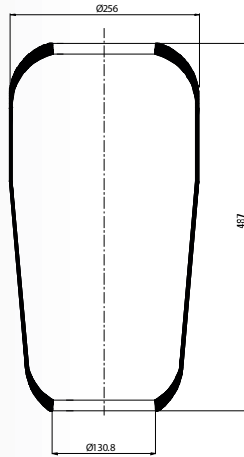

RT1.746.R

Cross References

Contitech	746 N
Good Year	9076

OE Part No

Mercedes	A 318 328 0001
----------	----------------

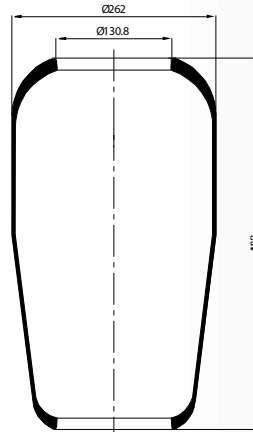

RT1.757.R

Cross References

Contitech	757 N
Firestone	1R2A 380 305
	W01095 0212
Phoenix	1F 26 C
Taurus	B 126
Good Year	9077

OE Part No

Mercedes	A 363 328 0201
----------	----------------

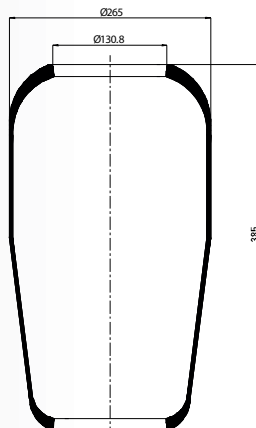

RT1.762.R

Cross References

Contitech	762 N
Firestone	1R2D 390 360
	W01095 0190
Phoenix	1F 32
Taurus	BL 143
Dunlop Uk	PNP307800100
Dunlop Fr	D13S02
Cf Gomma	1SC 360-30 92594
Good Year	9010

OE Part No

Bpw	02 200 24 20 0
Bpw	02.200.24.00.0
Daf	0 644 425
Daf	0 578 361
Evo Bus	4 731013 000
Gigant	161210
Gigant	161209
Gigant	196035

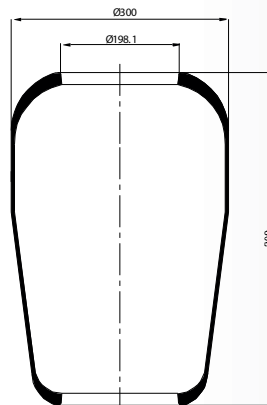

RT1.768.R

Cross References

Contitech	768 N
Firestone	1R2A 380 330
	W01095 0213
Taurus	B 125
Goodyear	9078

OE Part No

Volvo	1612 455
Renault V.I	5 000 954 175

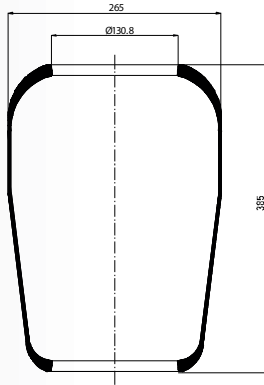

RT1.769.R

Cross References

Contitech	769 N
Firestone	1R 1A 380 260
	W01095 0204
Phoenix	1E 18
Taurus	B 156
Dunlop Uk	PNP 305 140 100
Dunlop Fr	D 10S02
Goodyear	8053
Cf Gomma	1SC240-30 97326

OE Part No

Breda Menarini	252 933
Daewoo	967 08574
Heuliez	5 000 805 284
Irisbus	5 000 786 640
Irisbus	5 000 786 641
Irisbus	5 000 805 284

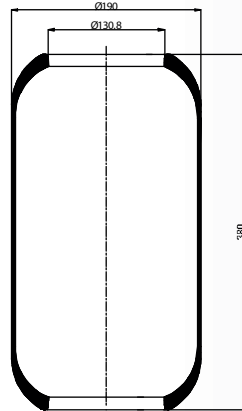

RT1.775.R

Cross References

Contitech	775 N
-----------	-------

OE Part No

Bpw	02 2002 4700
Gigant	196 038
Evo Bus	4.731.040.000
Granning	15.932
Kässbohrer	4 731040 000
Kögel	4 731040 000

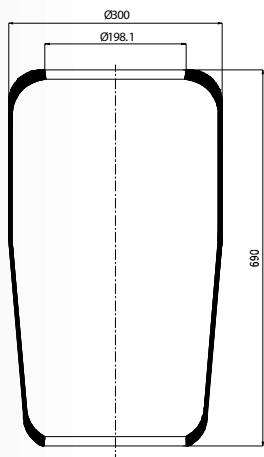

RT1.782.R

Cross References

Contitech	782 N
Firestone	1R1A 415-285
	W01095 0197
Taurus	B 124
Dunlop Fr	D11S02
Goodyear	9013
Cf Gomma	1S 285-25 97555

OE Part No

Irisbus	5 000 954 176
Irisbus	5 000 324 098
Iveco Bus	500 324 098
Iveco	4.703.904
Iveco	4.703.972
Iveco	4.716.989
Mercedes	A 382 327 7201

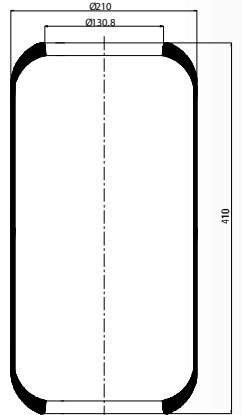

RT1.786.R

Cross References

Contitech	786 N
Firestone	1R2S 355 245
	W01095 0436
Phoenix	1F 14

OE Part No

Man	81436010053
-----	-------------

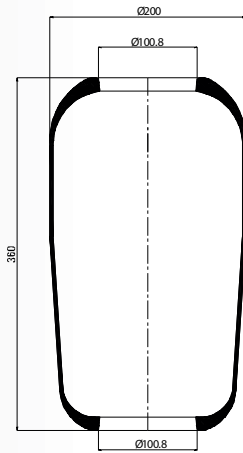

RT1.883.R01

Cross References

Contitech	838 N
Phoenix	1F 26 D
Goodyear	9074

OE Part No

Mercedes	A 674 328 0001
----------	----------------

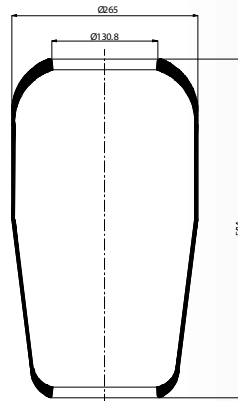

RT1.873.R

Cross References

Contitech	873 N
-----------	-------

OE Part No

Mercedes	A 674 328 0101
----------	----------------

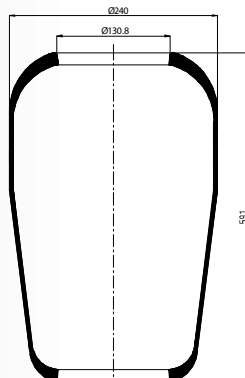

RT1.876.R

Cross References

Contitech	876 N
Goodyear	8314

OE Part No

Iveco	813 9068
Iveco	41.022.620
Renault V.I	5.000.296.816

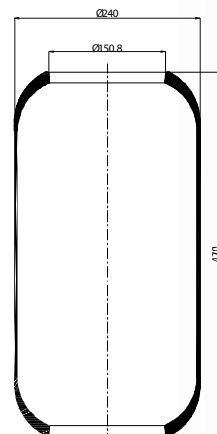

RT1.882.R01

Cross References

Contitech	882 N1
Phoenix	1F 16
Taurus	B 155
Goodyear	9048
Cf Gomma	1SC 250-28 97042

OE Part No

Man	81436010065
Man	81436010067
Man	81436010070
Man	81436010092
Man	81436010099
Man	81436010103
Man	81436010121
Man	81436010132

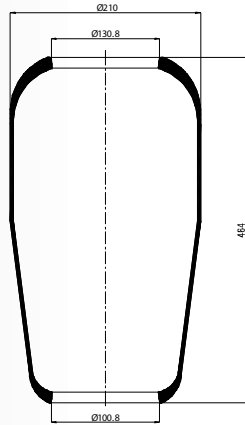

RT1.883.R01

Cross References

Contitech	883 N1
Firestone	1R4R 465 260
	W01095 0435
Phoenix	1F 21C-2
Goodyear	9012
Cf Gomma	1SC 250-29 204250

OE Part No

Man	81436010071
Man	81436010072
Man	81436010110
Man	81436010128
Man	81436010137
Volvo	1082 085
Volvo	1082 130

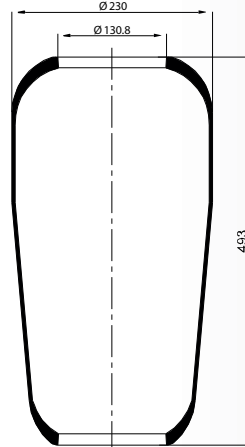

RT1.884.R01

Cross References

Contitech	884 N
Firestone	1R1B 415 270
	W01095 0295
Phoenix	1F 20 A
Taurus	BL 249
Dunlop Fr	D12S06
Good Year	9002
Cf Gomma	1S 270-25C 97608

OE Part No

Irisbus	5 000 301452
Irisbus	5 010 294 385
Iveco	5 010 301452
Iveco	97108363
Iveco	97108363
Pegaso	818 8539
Renault	5010 294 385
Mercedes	A 658 328 0001

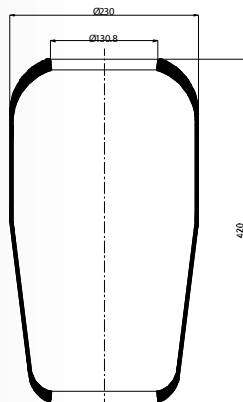

RT1.896.R

Cross References

Contitech	896 N
Firestone	1R1J520 285
	W01095 0245
Phoenix	2 E 18 A
Taurus	B 166
Dunlop Uk	PNP 305140100
Dunlop Fr	SP2191
Goodyear	8040

OE Part No

Dennis	655 606 / 1
Dennis	656 300 / 2
Scania	411627

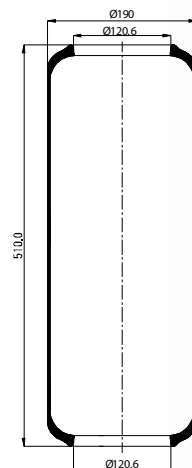

RT1.897.R

Cross References

Contitech	897 N
Firestone	1R 1K 440 320
	W01095 0239
	W01095 0229
Phoenix	1 E 23
Taurus	B 165
Dunlop Uk	PNP305210100
	PNP305210101
Dunlop Fr	SP2192
Goodyear	8028 / 556 03 8028

OE Part No

Dennis	656 289 / 2
Lag	./.
Pegaso	794686
Pegaso	795097
Scania	411622
Scania	411623
Cardi	58050315

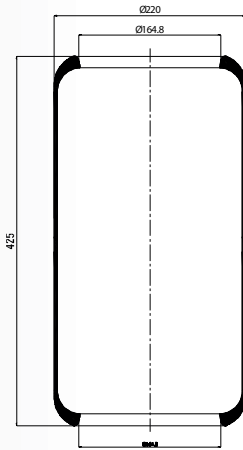

RT1.916.R01

Cross References

Contitech	916 N1
Firestone	2R2A 460-295
	W01095 0555
Goodyear	9015
Phoenix	1F 21C-5
Taurus	B-154
Dunlop Fr	D12S05

OE Part No

Man	81436010095
Man	81436010097
Man	81436010100
Man	81436010102
Man	81436010105
Man	81436010126
Man	81436010138
Optare	L 5820005

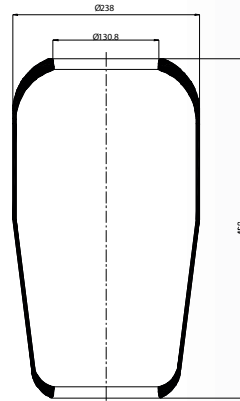

RT1.921.R

Cross References

Contitech	921N
Firestone	1R1A 415-260
	W01095 0226
Phoenix	1E 18
Taurus	B-158
Dunlop Fr	D10S04
Goodyear	8043
Cf Gomma	1S 285-23 202728

OE Part No

Evo Bus	A 000 328 0001
Heuliez	5 000 288 982
Irisbus	5 000 288 982
Irisbus	5 010 151378
Irisbus	5 010 151379
Iveco Bus	994 59166
Neoplan	./.
Renault	5 000 288 982

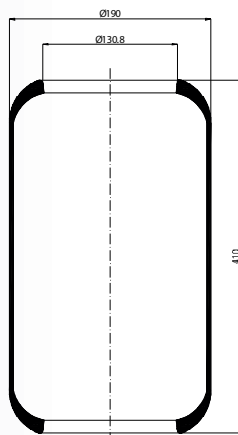

RT1.927.R

Cross References

Contitech	927 N
Firestone	1R1J415 285
	W01095 0244
Goodyear	8037
Phoenix	2 E 18 B
Taurus	B 179
Dunlop Uk	PNP 300080100

OE Part No

Dennis	611896 / 12
Jonckheere	./.
Volvo Leyland	3 116 354
Volvo Leyland	AAU 2542
Scania (Brazil)	434 932

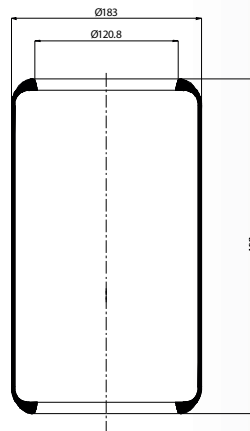

RT1.928.R

Cross References

Contitech	928 N
Firestone	1R 1K 380 320
	W01095 0228
Phoenix	2 E 23 A
Taurus	B 178
Dunlop Uk	IC 3308
Dunlop Fr	D12 503
Goodyear	8042

OE Part No

Dennis	650 292 / 8
Dennis	650 883 / 4
Dennis	650 883 / 7
Iveco Bus	6453741
Mcw X	664 1056
Scania	434932
Volvo	3 116 983
Volvo (Brazil)	2TB 411099 ATE 2001

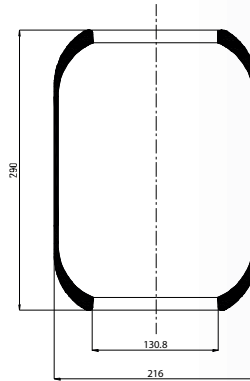
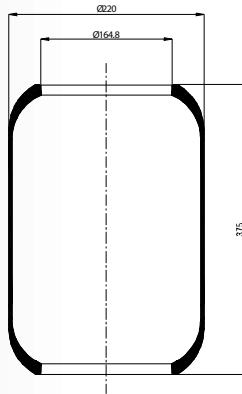

RT1.943.R

Cross References

Contitech	943 N
Firestone	1R 1A 260 285
	W01095 0189
Taurus	B194
Dunlop Uk	PNP 316720100
Dunlop Fr	D11503
Goodyear	9001
Cf Gomma	1S 285-18 88809

OE Part No

Breda Menarini	S 5001051
Inbus	500 1051
Iveco Bus	6144040
Pegaso	./.
Pegaso	199563
Sicca	4890 001

RT1.944.R

Cross References

Contitech	944 N
Firestone	1R 1A 370 285
	W01095 0198
Taurus	B 141
Dunlop Uk	PNP 316 720 100
Dunlop Fr	SP 1217
Goodyear	8012
Cf Gomma	1S 285-22 88786

OE Part No

Inbus	484 0005
Inbus	489 0001
Iveco	471 4025
Bus	472 2525
Iveco	525 4025
Bus	665 7150
Iveco	700 176
Bus	523 229

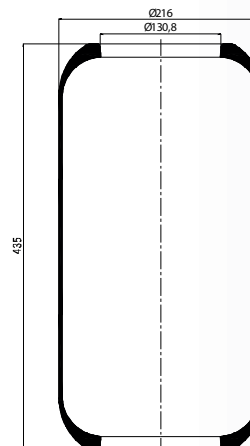
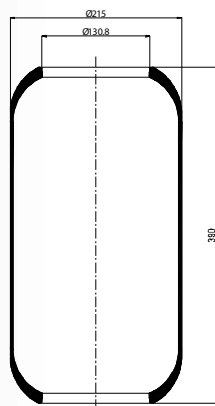

RT1.945.R

Cross References

Contitech	945 N
Firestone	1R 1A 460 290
	W01095 0063
Phoenix	1E21C
Taurus	K 152
Dunlop Uk	PNP 301000101
Goodyear	9014
Cf Gomma	1S 285-25 97555
Dunlop Fr	D11S02

OE Part No

Breda Menarini	178 741
Hyundai	./.
Iveco Bus	471 6989
Pegaso	197145
Pegaso	4716989
Pegaso	769388
Scania Bussar	523229

RT1.975.R

Cross References

Contitech	975 N
Firestone	1R 1T 320 195
	W01095 0437
Phoenix	1E 10

OE Part No

Evo Bus	A 699 328 0101
Optare	R 5800001
Zf Sachs	0501 312 548

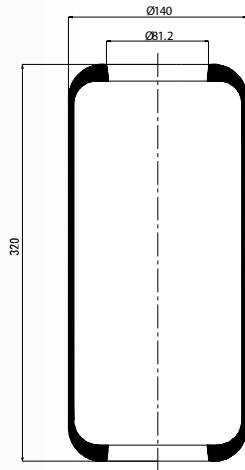

RT1.976.R

Cross References

Contitech	976 N
-----------	-------

OE Part No

Evo Bus	A 699 328 0101
Optare	5800001
Zf Sachs	502 312 548

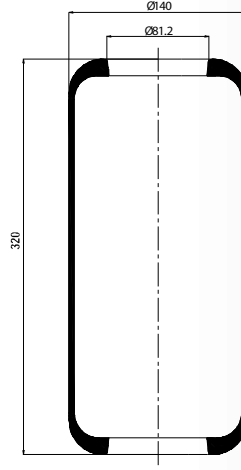

RT1.1415.R

Cross References

Contitech	1415 N
Phoenix	1E 23 A
Vibracoustic	VI E20A
Goodyear	9113

OE Part No

Irisbus	500 10214 14
---------	--------------

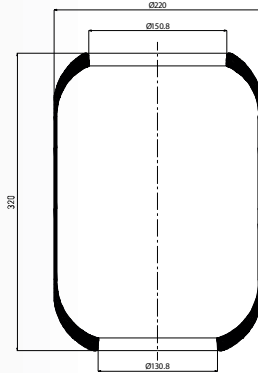

RT1.1421.R

Cross References

Contitech	1421 N
Firestone	1R2A 490 305
	W01095 0472
Goodyear	9072
Springride	D12S18
Gart	C299E 299.0.490

OE Part No

Volvo	1075 290
-------	----------

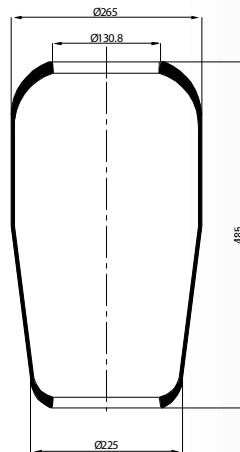

RT1.1774.R

Cross References

Contitech	1774 N
-----------	--------

OE Part No

Bpw	02 200 24 30 0
Gigant	196 039
Kässbohrer	4 731 038 000
Schmitz	750 225

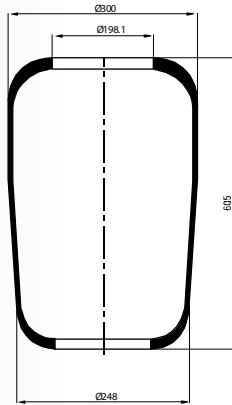

RT1.1885.R01

Cross References

Contitech	1885 N1
Firestone	1R2A445-280
	W01-095-0429
Phoenix	1F 20 B
Vibracoustic	V1F20B
Goodyear	9003
Springride	D12507
Cf Gomma	1SC270-30 202265
Gart	C289C 289.0.450

OE Part No

Man	81436010104
Man	81436010109
Man	81436010111
Man	81436010120
Man	81436010123
Man	81436010125
Man	81436010140
Man	81436010150

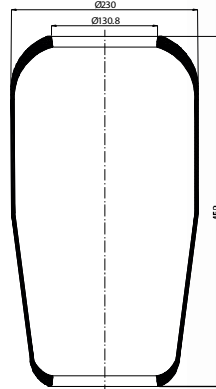

RT1.1888.R

Cross References

Contitech	1888 N
-----------	--------

OE Part No

Man	81.436.010.163
Sachs	00 1748 451 100

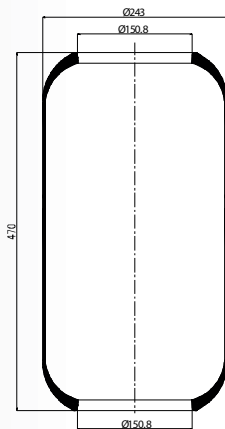

RT1.1924.R

Cross References

Contitech	1924 N1
Phoenix	2 F 18
Gart	C298E 289.0.360

OE Part No

Irisbus	5 001843 640
---------	--------------

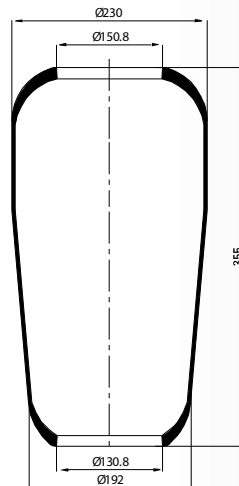

RT1.2620.R

Cross References

Cf Gomma 1S 323-36 203833

OE Part No

Iveco 41022620

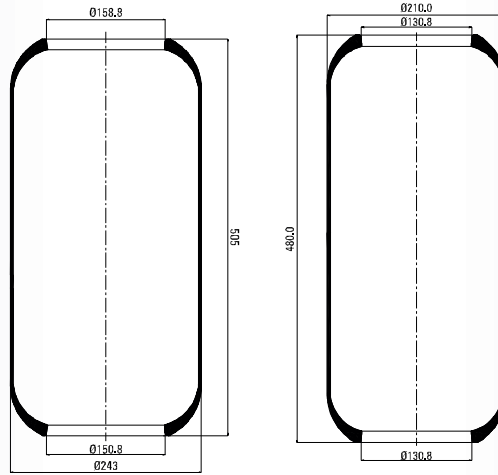

RT1.3698.R

Cross References

Pirelli 203698

OE Part No

Iveco 500 319 479

RT1.4644.R

Cross References

Contitech 4644 N

OE Part No

Evo Bus A 629 327 00 01

Cross References

OE Part No

COMPLETE
TYPE

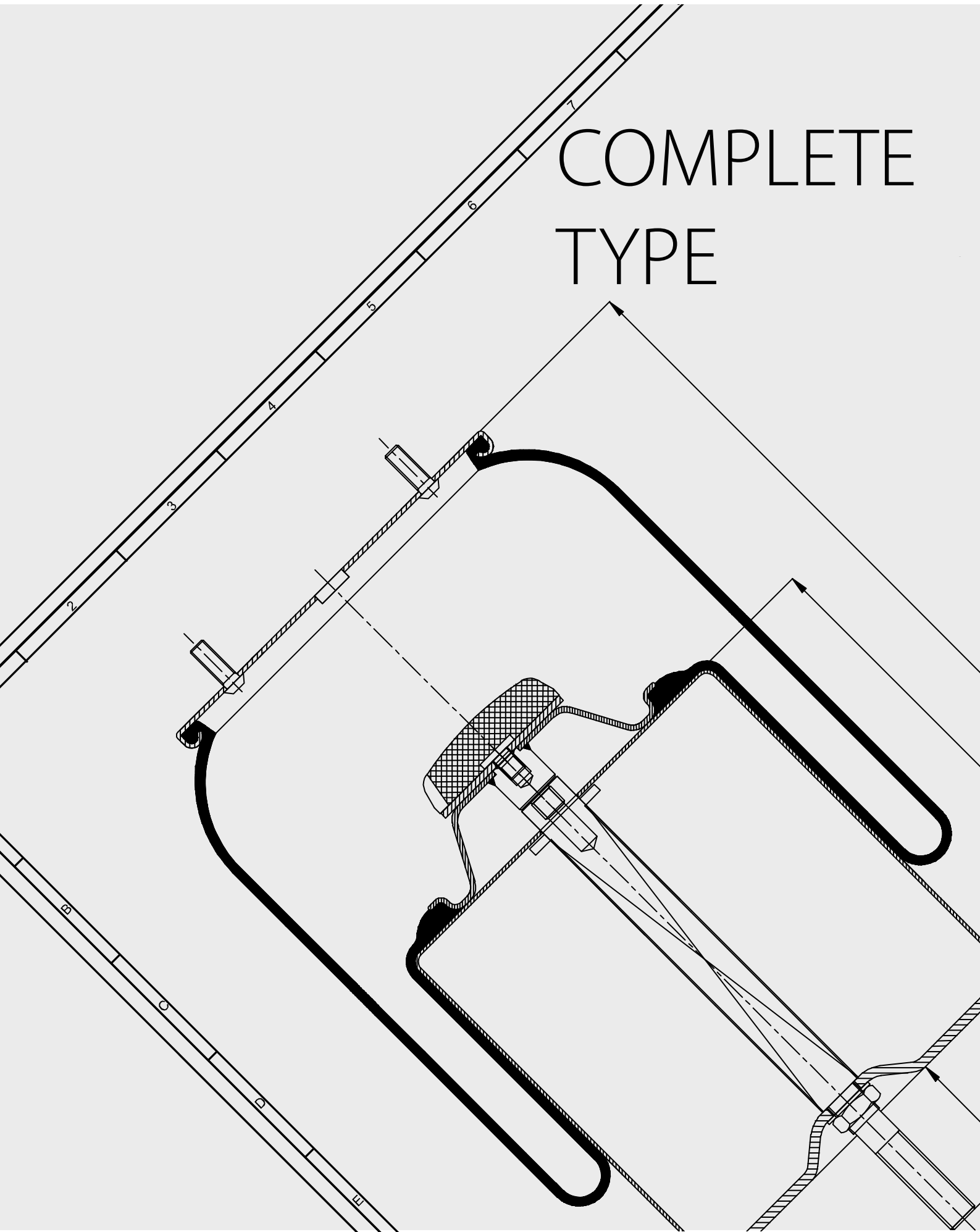

RT1.0081.C

Cross References

Firestone	TT17B-11
	W01M58 8747
Goodyear	1R13-150
Dunlop	D13B42

OE Part No

Discos	946 328 0401
Mercedes	HS 251087
Hendrickson	2500915

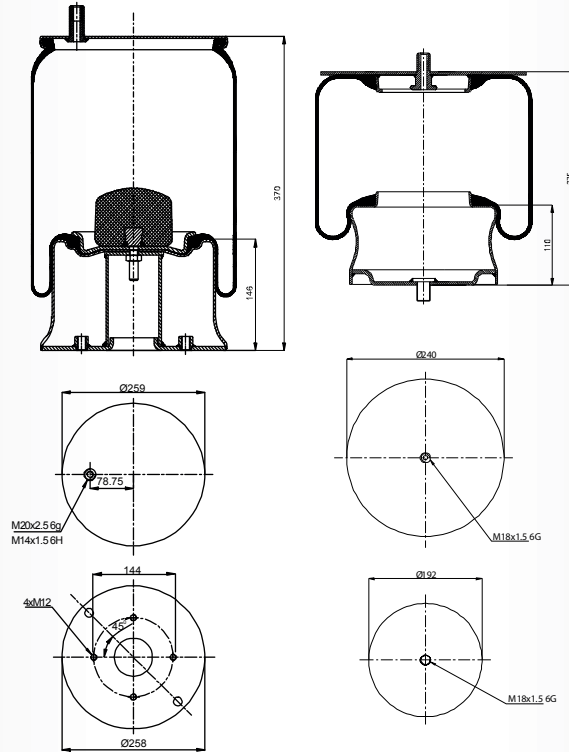

RT1.644.C02

Cross References

Contitech	644 N P02
-----------	-----------

OE Part No

Zf Sachs	0501 209 514
----------	--------------

RT1.644.C04

Cross References

Contitech	644 N P04
-----------	-----------

OE Part No

Autosan	1029-900-970
---------	--------------

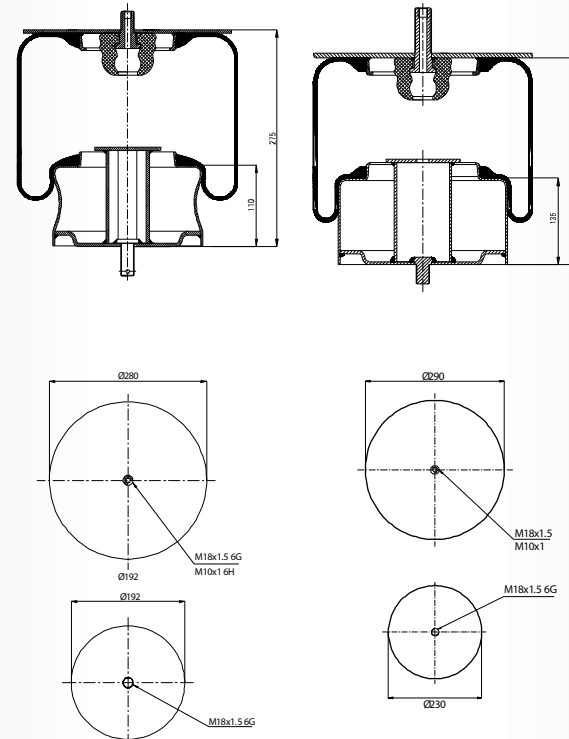

RT1.661.C01

Cross References

Contitech	661N P01
-----------	----------

OE Part No

Ayats	31001569
Irisbus	5010 073 846

RT1.661.C02

RT1.661.C05

Cross References

Contitech 661N P02

Cross References

Contitech 661N P05

OE Part No

Zf Sachs 3 027272

OE Part No

Ayats 30201102

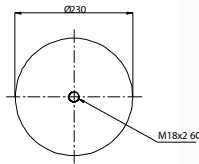
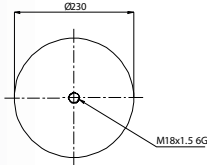
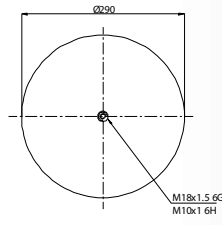
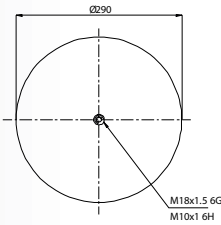
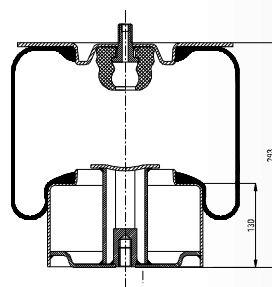
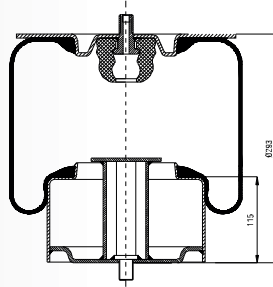

Cross References

Cross References

OE Part No

Bova B 510040

Ikarus B 510040

Contitech 724 N P02

OE Part No

Gigant 166225 3053

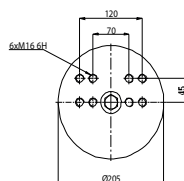
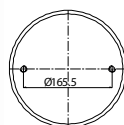
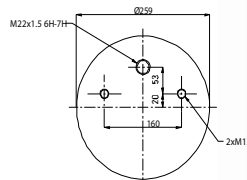
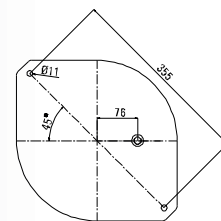
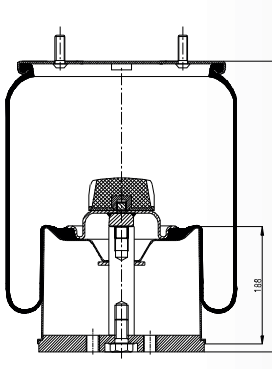
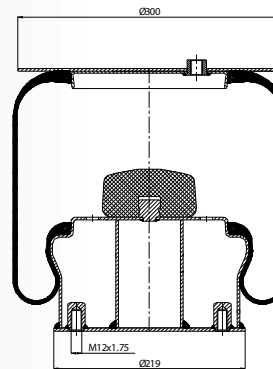

RT1.724.C03

Cross References

Contitech 724 N P03

OE Part No

Gigant 166 259

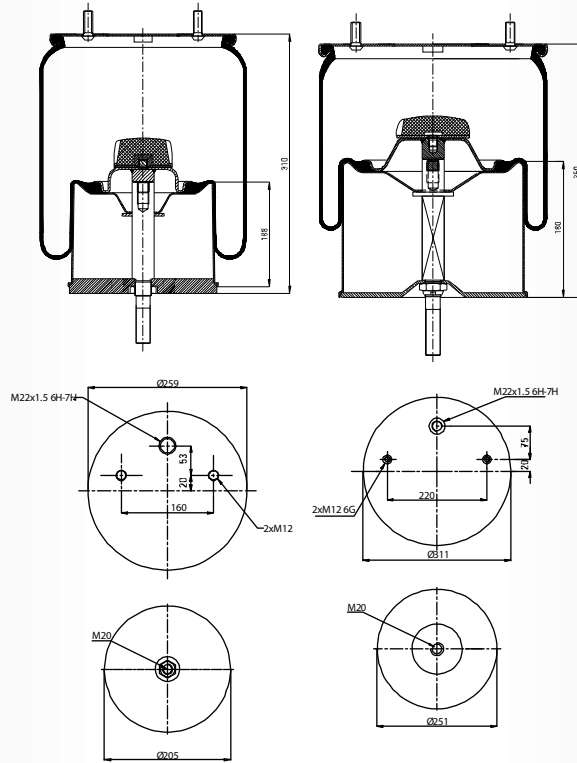

RT1.725.C02

Cross References

Contitech 725 N P02

Firestone IT66F-10.8

W01M58 8969

Phoenix 1 DF 32

Taurus UR 836- 11

Dunlop FR D14U38

Cf Gomma 1TCS 360-45 202964

OE Part No

Gigant 166 217

Gigant 246 149

Gigant 166 252

RT1.725.C03

Cross References

Contitech 725 N P03

Firestone IT66F-10.8

W01M58 8610

OE Part No

Gigant 166 252

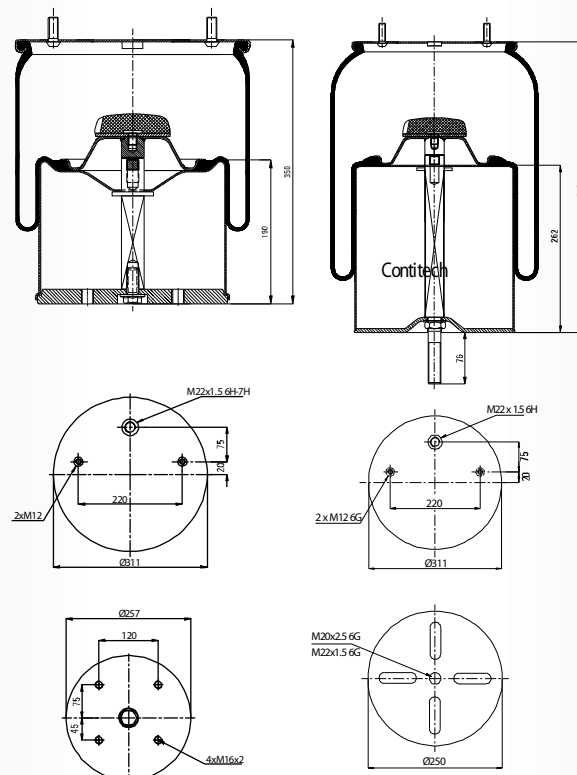

RT1.752.C

Cross References

Contitech 752 N P01

OE Part No

Gigant 247 100

RT1.769.C

Cross References

Contitech 769 MB

OE Part No

Irisbus 5 000 805 999

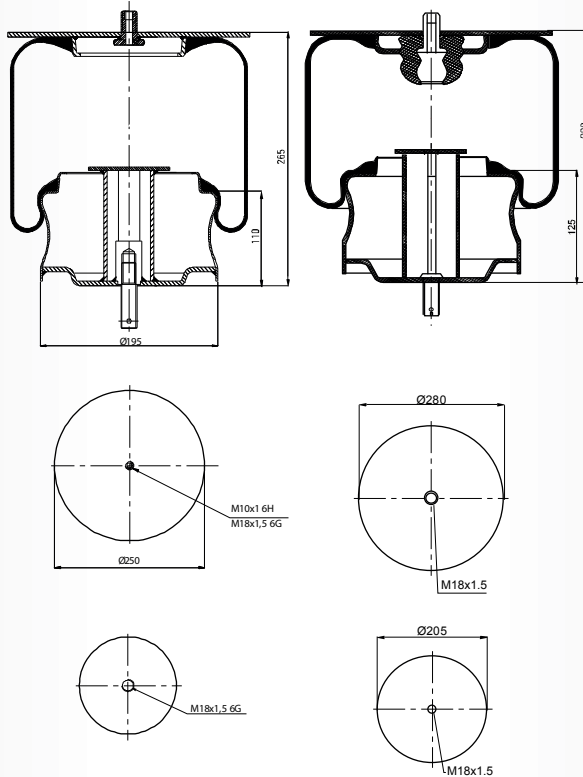

RT1.782.C03

Cross References

Contitech 782 MB-3

OE Part No

Irisbus 5 010 190 888

Jonckheere 26 160 2033 00

Zf Sachs 0501210 851

RT1.782.C04

Cross References

Contitech 782 N P04

OE Part No

Ayats 30201097

Irisbus 5 010 073 847

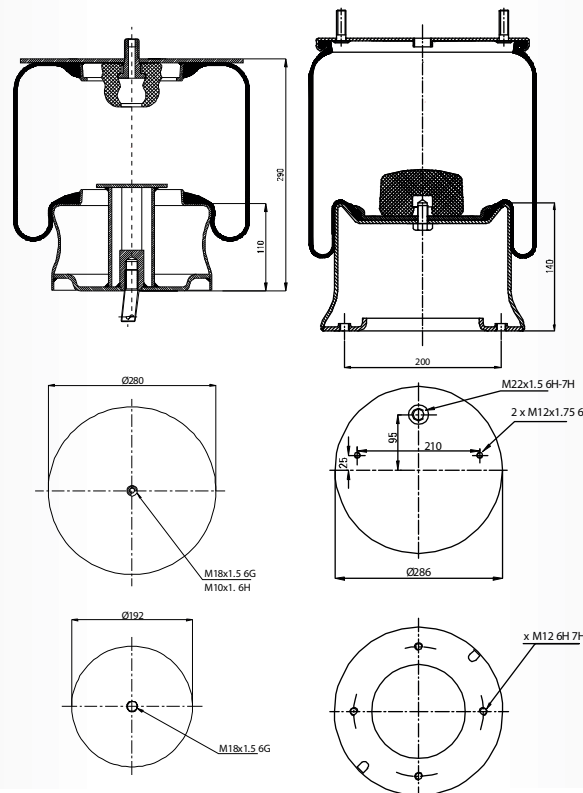

RT1.810.C

Cross References

Contitech 810 MB

Firestone 1T19L-7

W01M58 6345

Phoenix 1D28 A-2

Taurus KR 621-26

Dunlop Uk PNP311780000

Dunlop Fr D13B20

Goodyear 1R 14-716

Cf Gomma 1T 19E-1

OE Part No

Hendrickson 506 243

Hendrickson 785 168

Neway 212 156 32

Ror 2120 8032

Ror 2121 5632

Saf Holland 2 228 0002 00

Weweler US 00622

Weweler US 07337

RT1.810.CP

Cross References

Firestone	1T19L-7
Firestone	W01M58 8775

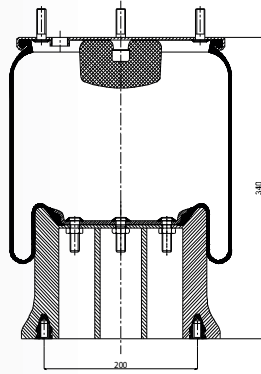

OE Part No

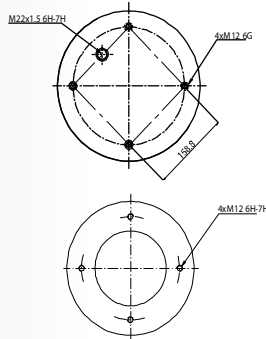

RT1.811.C

Cross References

Contitech	811MB
Firestone	1T19L-11
	W01M58 6359
Dunlop Fr	D13B34
Goodyear	1R14-718
Cf Gomma	1T19-E2 203878

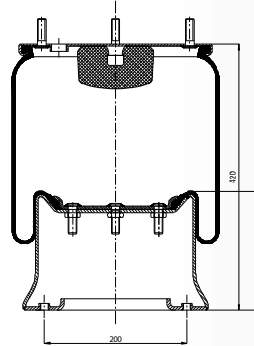

OE Part No

Daf	1384 274
Renault	5 000 745 918

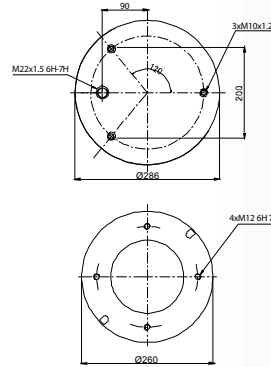

RT1.811.C02

Cross References

Contitech	811MB
-----------	-------

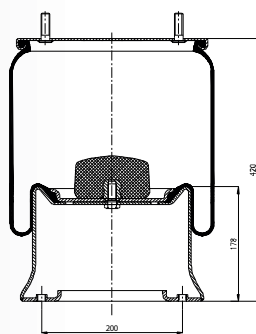

OE Part No

Volvo	1622 116
Volvo	6 797 169

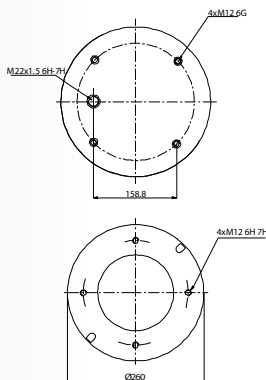

RT1.811.C11

Cross References

Firestone	1T19 L-11
-----------	-----------

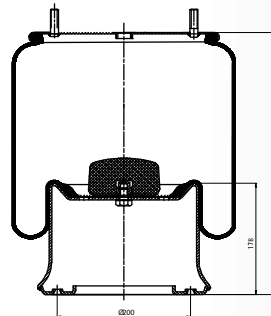

OE Part No

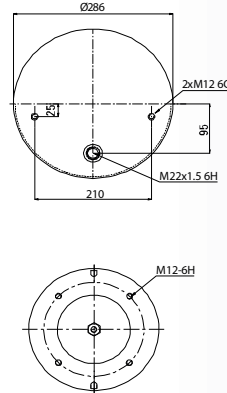

RT1.811.C12

Cross References

Dunlop	D14 B51
Firestone	1T19L-11
Firestone	W01M58 6359
Firestone	W01M58 7370
Good	1R14-721
Year	

OE Part No

R.O.R./Meritor	212 15 633
----------------	------------

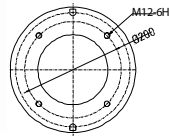
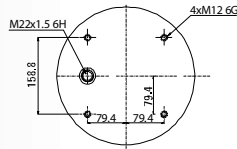
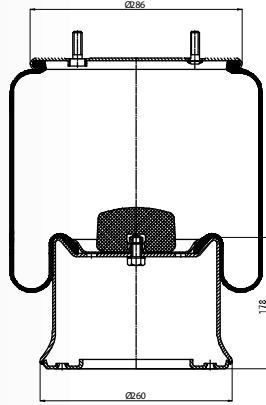

RT1.811.C16

Cross References

Firestone	1T19L-11
-----------	----------

OE Part No

Daf	0 818 225
Bpw	02 200 24 00 0
Evo Bus	4 731032 000
Gigant	196036
Gigant	166205
Kassbohrer	4 731032 000
Kassbohrer	4 731030 000
Kogel	4 731032 000

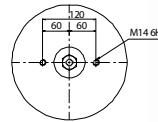
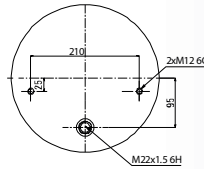
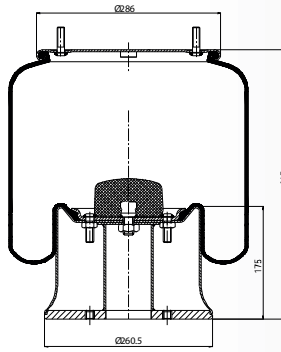

RT1.811.C17

Cross References

Contitech	811M17 K1
Dunlop	D13 B36
Firestone	1T19L-11
Fireston	W01M58 6334
Good Year	1R14-719
Phoenix	1D28 B-7
Taurus	KR 622-31

OE Part No

Daf	0 067 306
-----	-----------

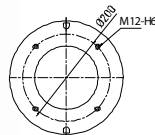
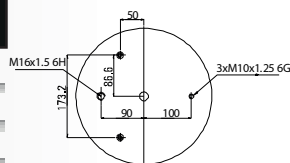
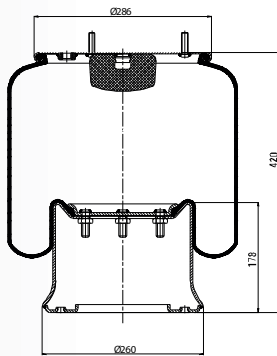

RT1.811.CP2

Cross References

Contitech	811MB\O
-----------	---------

OE Part No

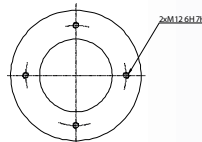
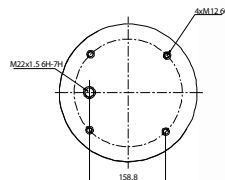
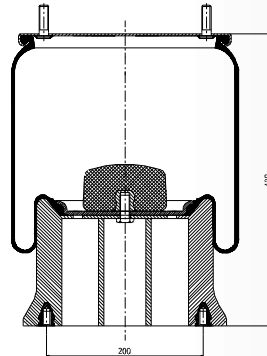

RT1.836.C04

Cross References

Contitech	836 MB K4
Firestone	TT17AR-4.5
	W01M58 8705
Phoenix	1DF 25-14

OE Part No

Vdl Bus	0 377 498
---------	-----------

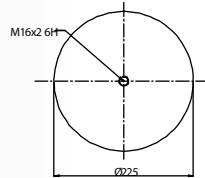
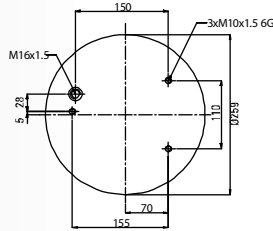
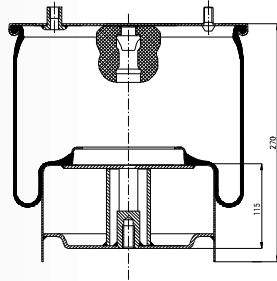

RT1.836.C05

Cross References

Contitech	836 N P05
-----------	-----------

OE Part No

Vdl Bus	1 153 933
---------	-----------

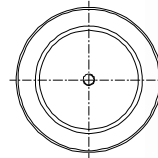
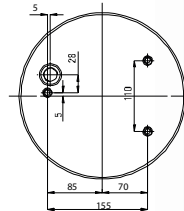
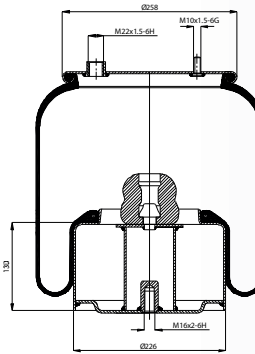

RT1.836.C06

Cross References

Contitech	836 MB K6
Firestone	TT17AR-4.5
	W01M58 8701
Phoenix	1DF 25-15

OE Part No

Daf	0 526 651
Vdl Bus	0 526 651

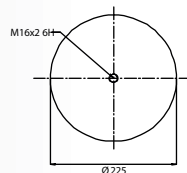
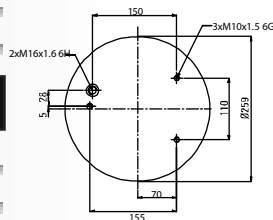
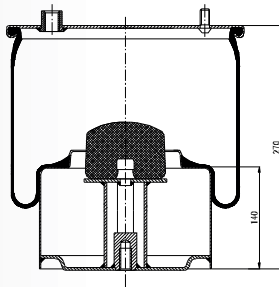

RT1.836.C07

Cross References

Contitech	836 M K7
-----------	----------

OE Part No

Daf	0 297 721
-----	-----------

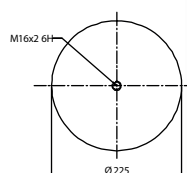
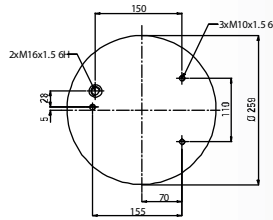
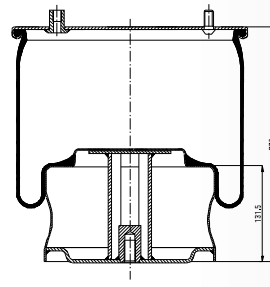

RT1.836.C11

Cross References

Contitech	836 M K11
Firestone	1T17AR-4.5
	W01M58 8714

OE Part No

Daf	1266 381
	1697 679

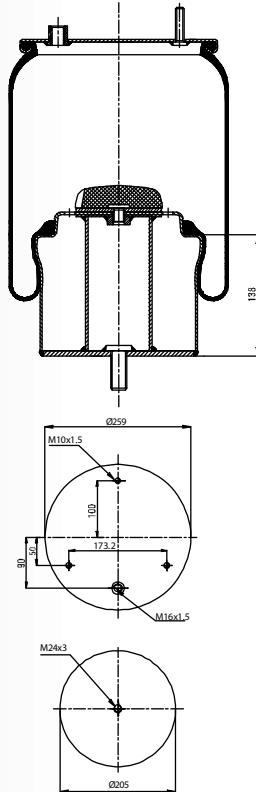

RT1.876.C

Cross References

Contitech	876 MB
-----------	--------

OE Part No

Renault	5 000 640 399
---------	---------------

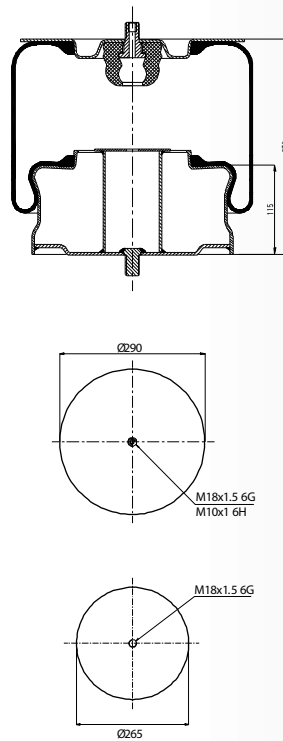

RT1.881.C

Cross References

Contitech	881 MB
Firestone	1T66F-10.8
	W01M58 8966
Phoenix	1DK 32-1
Dunlop Fr	D14B36
Goodyear	1R 14-712
Cf Gomma	TTC 360-45

OE Part No

Bpw	05 429 40 08 1
Bpw	05 429 41 36 1
Bpw	05 429 40 54 0
Bpw	TYPE 36

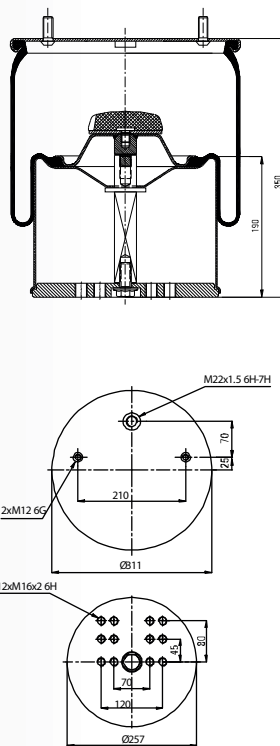

RT1.881.CP

Cross References

Contitech	881 MB
Firestone	1T66F-10.8
	W01M58 8667
Dunlop	D14B41
Goodyear	1R 14-748
Phoenix	1DK 32 1

OE Part No

Bpw	05 429 43 51 0
-----	----------------

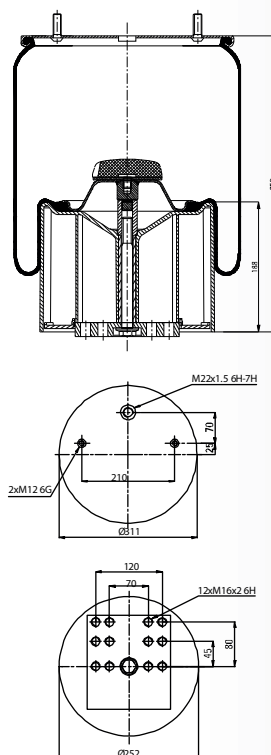

RT1.884.C04

Cross References

Contitech 884 N P04

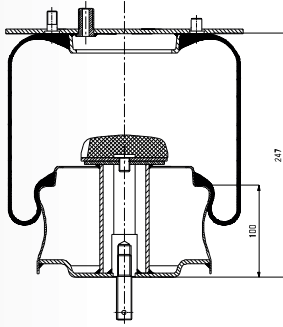

OE Part No

Renault 5010 294 385 B

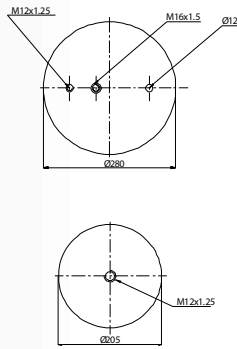

RT1.887.2C1

Cross References

Contitech 887 M2 K1

Firestone TT15LNR-3

W01D08 8684

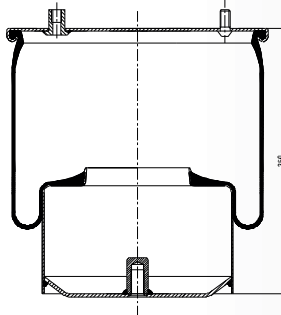

OE Part No

Daf 0 559 483

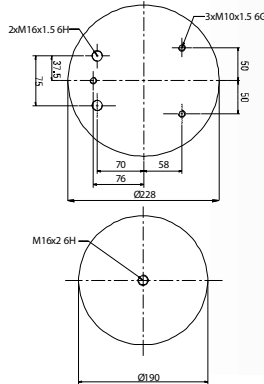

RT1.887.C01

Cross References

Contitech 887 M K1

Firestone TT15LNR-3

W01M58 8683

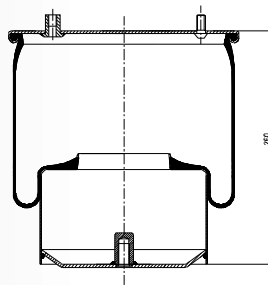

OE Part No

Daf 0 392 022

Daf 1697 684

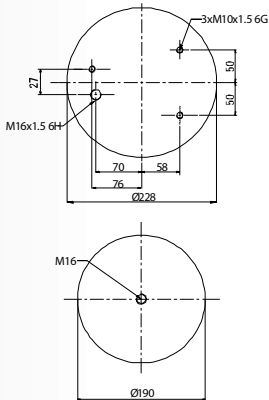

RT1.887.C03

Cross References

Contitech 887 M K3

Firestone TT15LNR-3

W01M58 8682

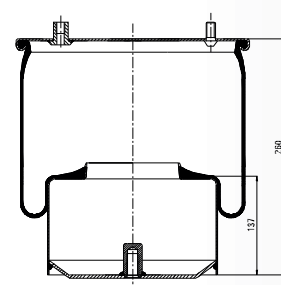

OE Part No

Daf 1266 382

Daf 1697 682

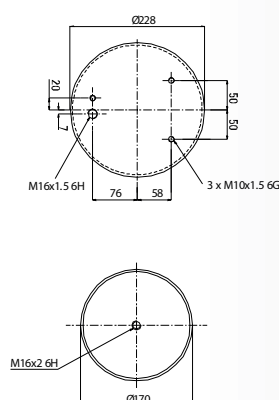

RT1.887.C04

Cross References

Contitech	887 M K4
Firestone	1T15LNR-3
	W01M58 8681

OE Part No

Daf	1286 251
Daf	1697 680

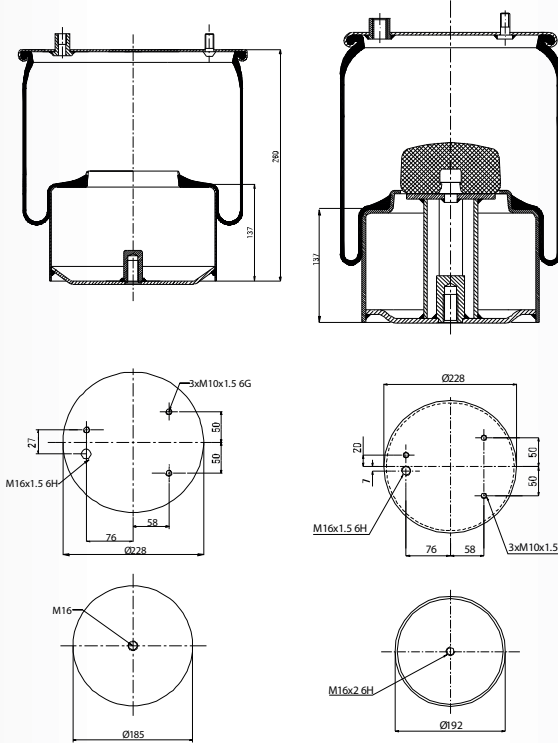

RT1.887.C06

Cross References

Contitech	887 MB K6
Firestone	1T15LNR-3
	W01M58 8683

OE Part No

Vdl Bus	1 141 525
Vdl Bus	1 154 761

RT1.889.C02

Cross References

Contitech	889 M K2
Firestone	1T15LLR-5
	W01M58 0781

OE Part No

Daf	1279 141
Daf	1698 434

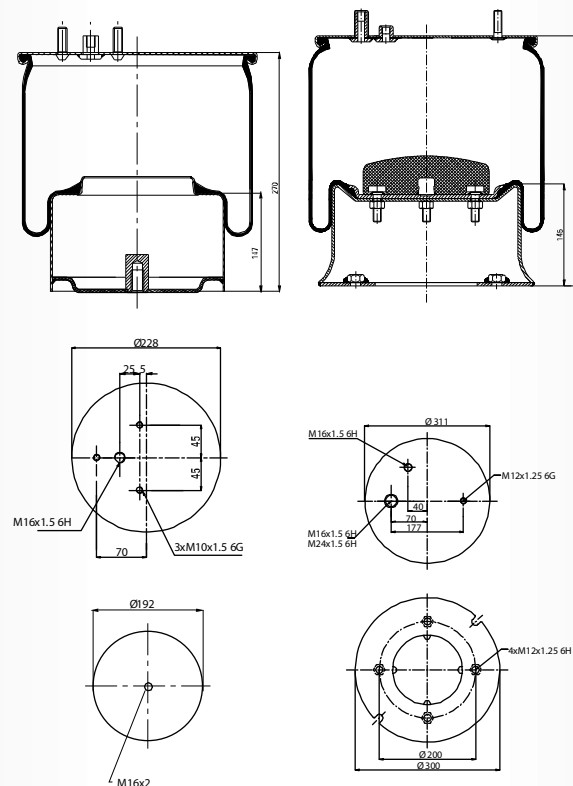

RT1.901.C

Cross References

Contitech	901 MB
Firestone	1T19LE-12
	W01M58 9910

OE Part No

Renault	5010 052 722
Renault	5010 130 683

RT1.940.C01

Cross References

Contitech	940 MB
Firestone	1T17D-4.3
	W01M58 8585
Springride	D11B36
Goodyear	1R 11-752

OE Part No

Bpw	05 429 43 210
-----	---------------

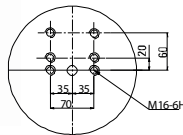
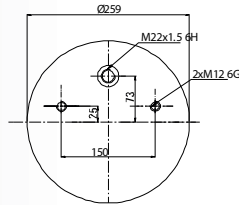
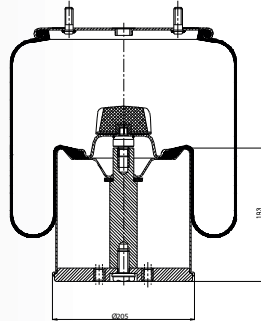

RT1.940.CP

Cross References

Contitech	940 MB
Firestone	1T17D-4.3
	W01M58 8609
Goodyear	1R11-763

OE Part No

Bpw	05 429 41 28 1
-----	----------------

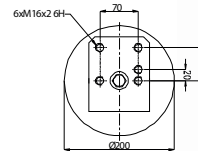
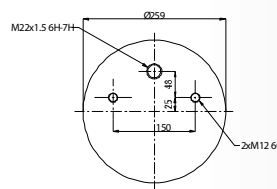
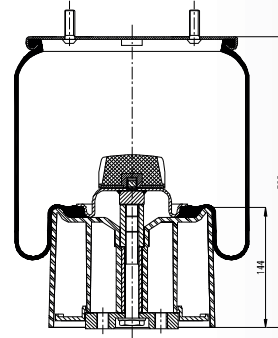

RT1.941.C

Cross References

Contitech	941 MB
Firestone	1T17D-8.3
	W01M58 8619
Phoenix	1 DK 21
Taurus	KR 730-01
Dunlop Fr	D11B38
Goodyear	1R 11-762

OE Part No

Bpw	05 429 40 28 1
Bpw	05 429 41 24 1
Bpw	05 429 40 59 1

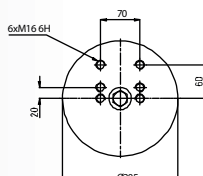
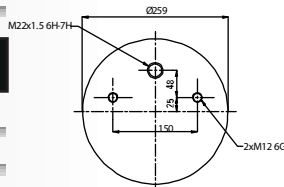
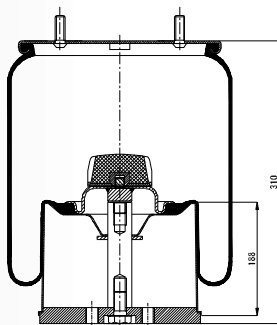

RT1.941.CP

Cross References

Contitech	941 MB
Firestone	1T17D-8.3
	W01M58 8668

OE Part No

Bpw	05 429 43 20 0
-----	----------------

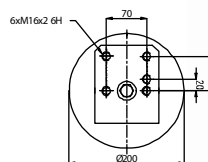
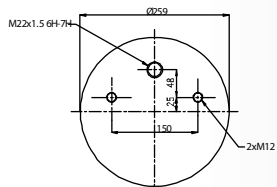
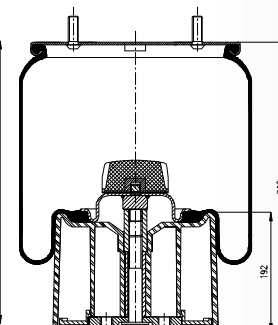

RT1.942.C

Cross References

OE Part No

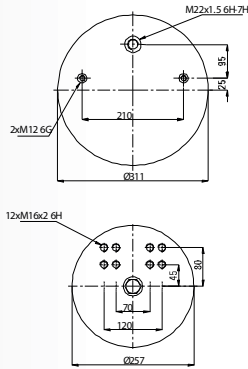
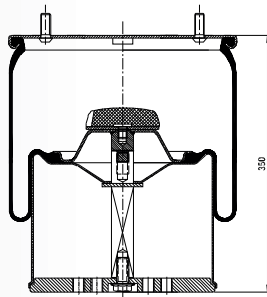

RT1.942.C01

Cross References

Contitech	942 MB
Firestone	TT66F-13.5
	W01M58 8584
Goodyear	1R14-781

OE Part No

Bpw	05 429 4169 0
-----	---------------

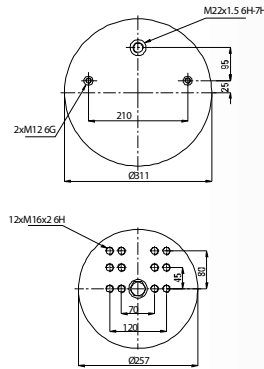
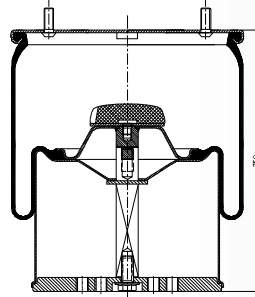

RT1.1210.C

Cross References

Cf Gomma	1T 323-40 96864
----------	-----------------

OE Part No

Viberti	128147109
---------	-----------

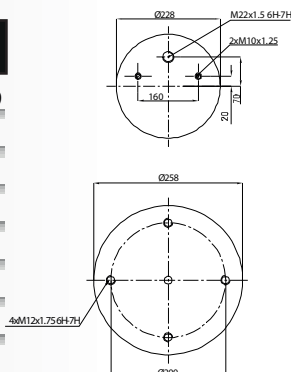
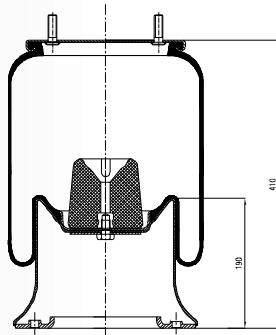

RT1.1285.C

Cross References

Phoenix	1 D 28 F-5
Vibracoustic	V 1 D 28 F-5
Goodyear	1R14-784
Springride	D14B49

OE Part No

Schmitz	017 685
Weweler	US 04031 P

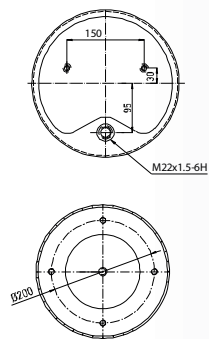
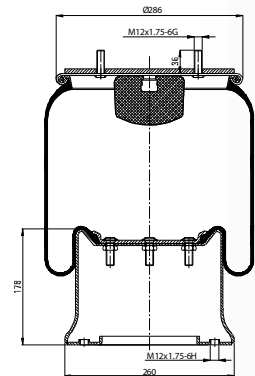

RT1.1318.C

Cross References

Dunlop Fr	D13B 18, D13B 12
Phoenix	1DK28 B-7

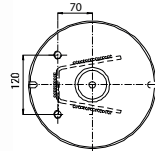
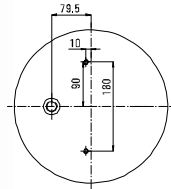
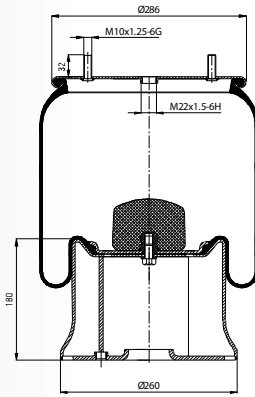

RT1.1847.C

Cross References

Goodyear	1R11-847
	1R11-765

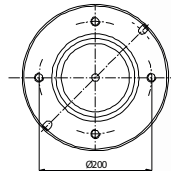
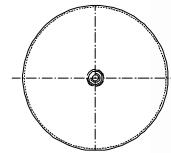
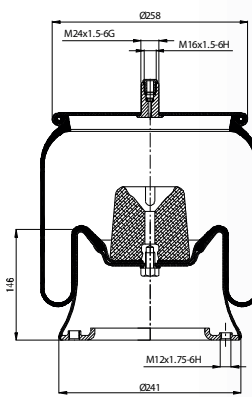

OE Part No

OE Part No

Hendrickson	HS 508263
-------------	-----------

RT1.02618.CP

Cross References

OE Part No

Saf Holland 2618 II	3.229.0040.00
---------------------	---------------

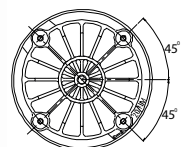
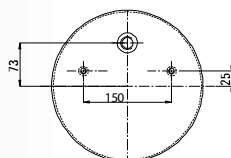
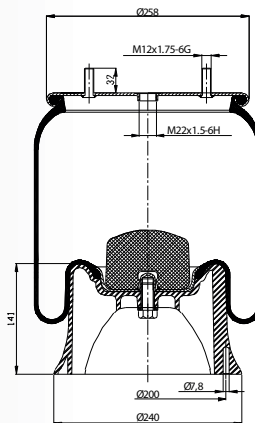

RT1.02619.CP

Cross References

OE Part No

Saf Holland	3.229.0033.00
-------------	---------------

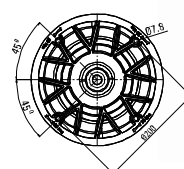
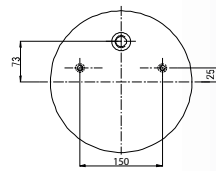
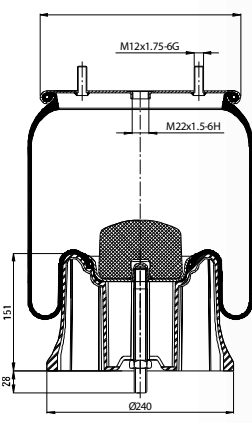

RT1.02619.CP01

Cross References

OE Part No

Daf	0 067 306
Saf Holland 2619 II	3.229.0043.00

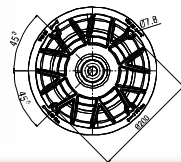
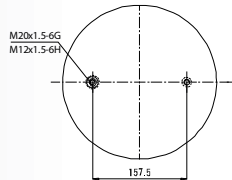
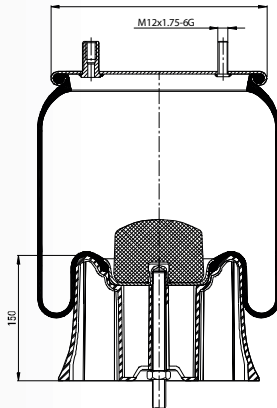

RT1.02621.CP

Cross References

OE Part No

Saf Holland	3 229 0038 00
-------------	---------------

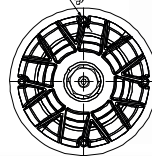
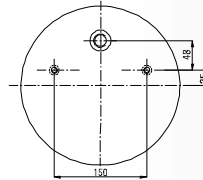
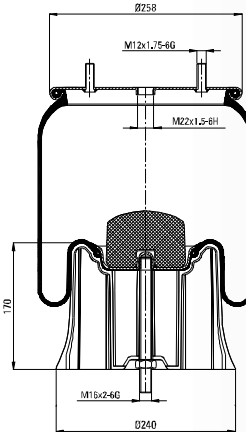

RT1.02626.CP

Cross References

OE Part No

Saf Holland	3 229 0039 00
-------------	---------------

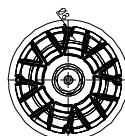
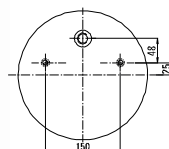
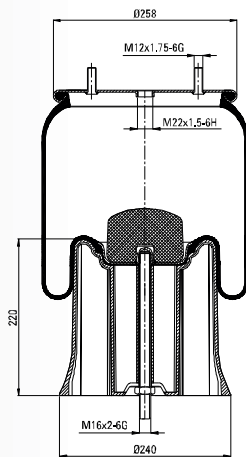

RT1.02725.C

Cross References

Contitech	2725 N
-----------	--------

OE Part No

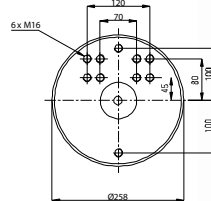
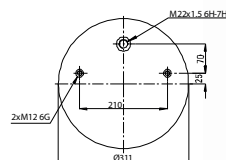
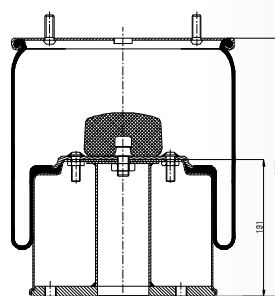

RT1.2725.C01

Cross References

OE Part No

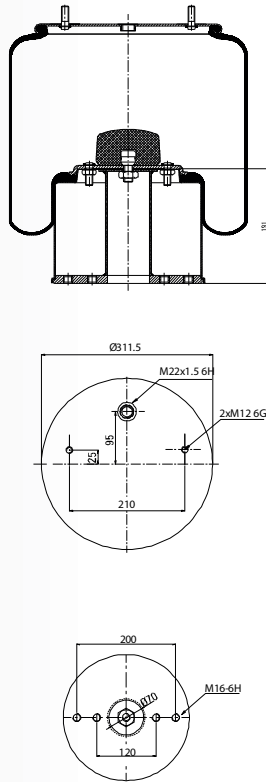

RT1.2813.C

Cross References

Firestone	1T19L-7
	W01M58 6222
Goodyear	1R 14-825
Vibracoustic	V1DK28A-13
Phoenix	1D28 A-13

OE Part No

Daimler Tas	A 946 328 19 01
Leciñena	
Weweler	US 07337RP

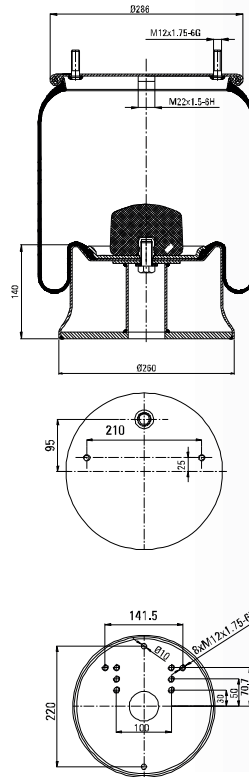

RT1.02923.CP

Cross References

OE Part No

Saf Holland 2923 Vk 3.229.0028.00

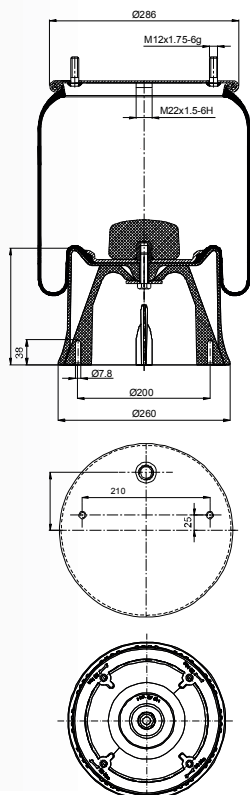

RT1.3042.C

Cross References

Vibracoustic	V 1DF 21A-2 -166294
--------------	---------------------

OE Part No

Gigant	166294
--------	--------

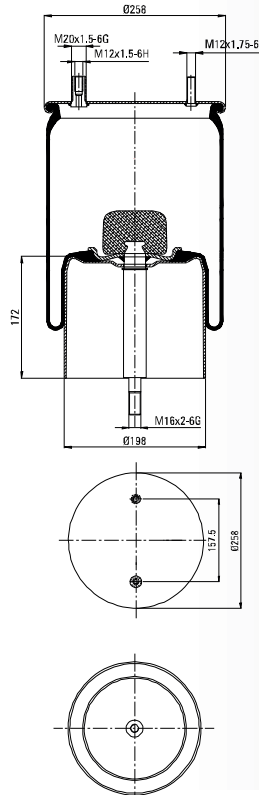

RT1.3708.C

Cross References

Firestone	1T17CL-9.5
Goodyear	W01M58 8643
	1R 13-708

OE Part No

Hendrickson	QE 100004
-------------	-----------

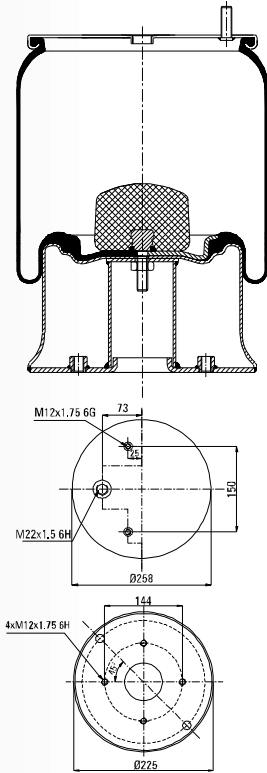

RT1.04004.CP03

Cross References

Contitech	4004 N P03
Firestone	1T17B5-6
	W01M58 6366
Goodyear	1R 11-713 - 1R 11-750
Phoenix	1 DK 22 E-8
Vibracoustic	V1DK22E-8
Springride	D12B13
Springride	D12B34
Gart	D278S 278.4.452
Cf Gomma	1T300-37 203715

OE Part No

Saf Holland	3 229 0007 00
	2618 V AR 416

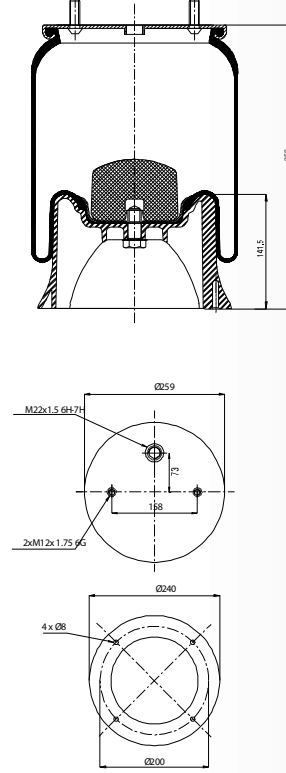

RT1.04004.C05

Cross References

Contitech	4004 N P05
Goodyear	1R 11-706
Phoenix	1DK22E5
Taurus	KR505-27SM
Dunlop	D12B13/B14
Cf Gomma	1T 300 33 97722

OE Part No

Saf Holland	2 229 0007 01
Saf Holland	3 229 0007 00
Saf Holland	3 229 0007 00
Saf Holland	3 229 0007 02
Saf Holland 2618 (E5)	2.229.0007.00

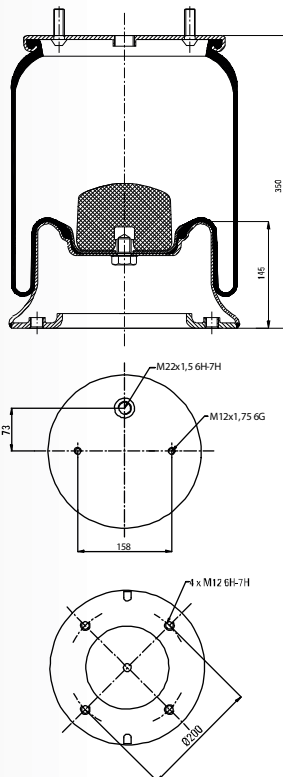

RT1.4008.C01

Cross References

Contitech	4008 N P01
Firestone	1T19F-12
	W01M58 8765
Dunlop Fr	D13B03
Phoenix	1D 28 C-12
Vibracoustic	V 1D 28 C-12

OE Part No

Fruehauf	UJB 0305
Ror / Meritor	21221349
Saf	3.229.0024.00
Weweler	US 07380F

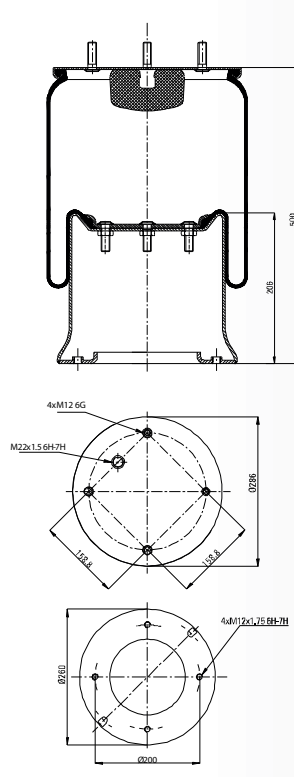

RT1.04022.C02

Cross References

OE Part No

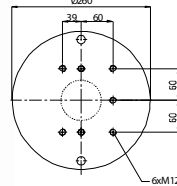
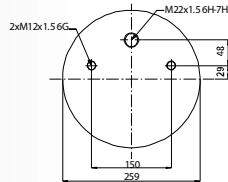
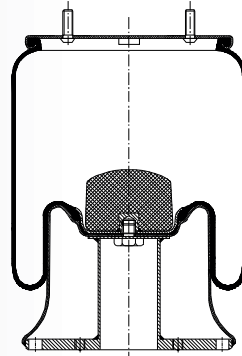

RT1.4022.C03

Cross References

Contitech	4022 N
Dunlop	P03(ST)
Firestone	D12B26
Firestone	1T17BS-6
Good Year	W01M58 6367
Phoenix	1R11-710
Cf	1DK 22 E-9
Gomma	1T 300-37
	204677

OE Part No

Saf	3.229.0029.00
Saf	3.229.2129.00
Saf	3.229.2229.00
Saf	3.229.2429.00
Saf	2618 V

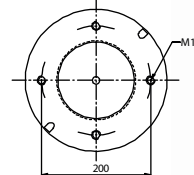
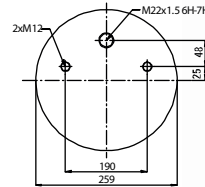
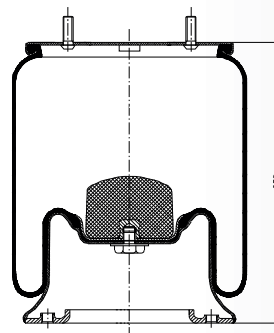

RT1.04022.CP02

Cross References

OE Part No

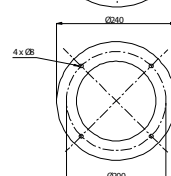
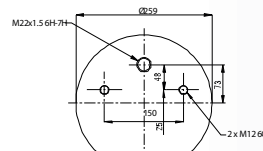
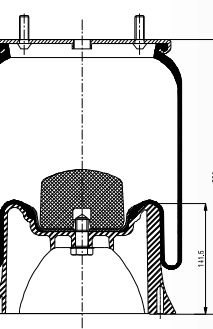
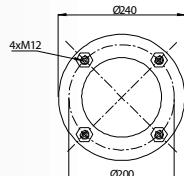
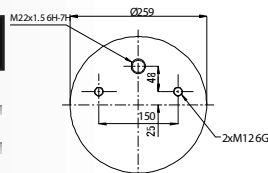
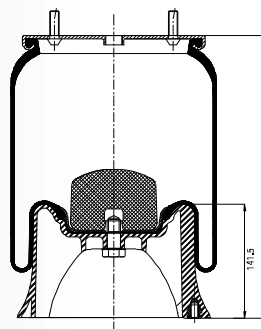

RT1.04022.CP03

Cross References

Contitech	4022 N P03
Firestone	1T17BS-6
	W01M58 6367
Phoenix	1DK 22 E-9
Vibracoustic	V1DK22E-9
Goodyear	1R11-714
Springride	D12B14
Cf Gomma	1T300-37 206340
Gart	D278S 278.4.454

OE Part No

Saf Holland 2618 V	3 229 0029 00
Saf Holland 2618 V	3 229 2129 00
Saf Holland 2618 V	3 229 2229 00
Saf Holland 2618 V	3 229 2429 00

RT1.04022.CP05

Cross References

Contitech	4022 N P05
Firestone	TT17BS-6
	W01M58 8612
Phoenix	1DK 22 E-11
Vibracoustic	V 1DK 22 E-10
Goodyear	1R 11-781
Cf Gomma	TT300-37 206585
Gart	D278S 278.1.455

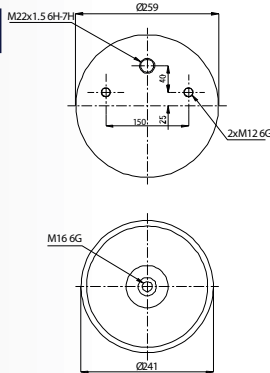
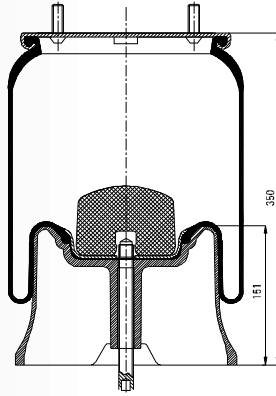

RT1.04022.CP06

Cross References

VIBRACOUSTIC	V 1DK 22 E-13
PHOENIX	1DK 22 E-9 2621V

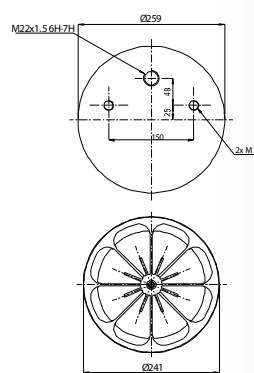
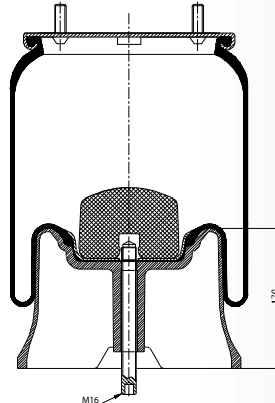

OE Part No

Saf Holland	3 229 0033 00
-------------	---------------

OE Part No

SAF HOLLAND	3.229.0038.00
	2621V

RT1.4023.C03

Cross References

Contitech	4023 N P03
	TT19L-11
	W01-M58-6348
Goodyear	1R 14-729
Springride	D13B26
Cf Gomma	TT 19E-2 204676
Gart	D277 277.4.505
Phoenix	1 D 28 B-10
Vibracoustic	V 1 D 28 B-10

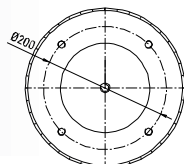
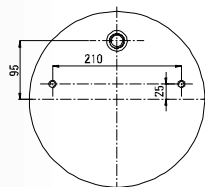
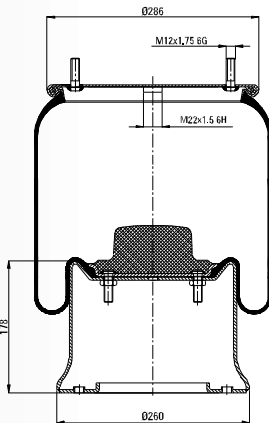

RT1.04023.CP03

Cross References

Contitech	4023 N P03
-----------	------------

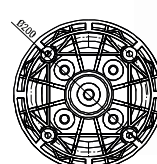
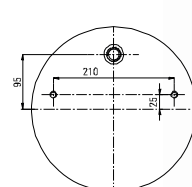
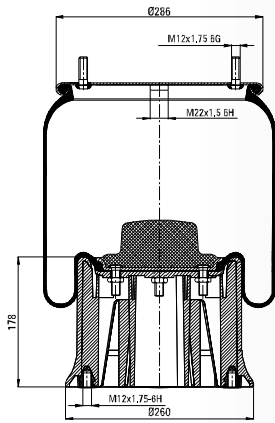

OE Part No

Saf Holland 2923 V	3.229.0031.00
Saf Holland 2923 V	3.229.2131.00
Saf Holland 2923 V	3.229.2231.00
Saf Holland 2923 V	3.229.2431.00

OE Part No

Saf Holland	3.229.0031.00
Saf Holland	3.229.2131.00
Saf Holland	3.229.2231.00
Saf Holland	3.229.2431.00

RT1.4028.C02

Cross References

Contitech	4028 N P02
Firestone	1T19L-12
	W01M58 8106
Goodyear	1R14-782
Springride	D14B47
Phoenix	1D28 F-1
Vibracoustic	V1D28F-1

OE Part No

Schmitz	015 323
Weweler	US 04028

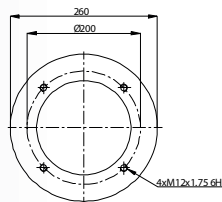
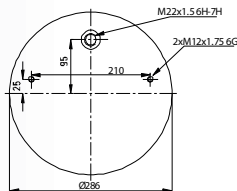
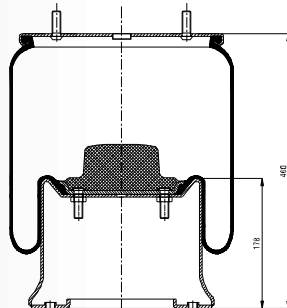

RT1.4028.C05

Cross References

Contitech	4028 N P05
Firestone	1T19L-11
	W01M58 7370
Phoenix	1D28 B-12
Vibracoustic	V1D28F-7
Goodyear	1R14-710
Goodyear	1R14-721
Springride	D14B51
Gart Ref.	D277D 277.4.520

OE Part No

Ror	2122 2239
-----	-----------

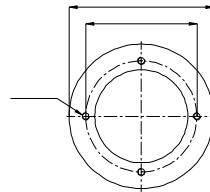
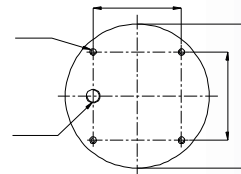
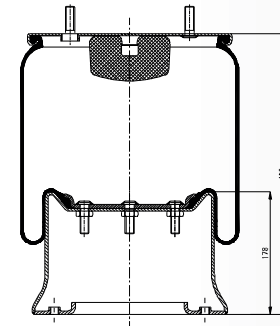

RT1.04120.CP

Cross References

Vibracoustic	V1DK20C-2
--------------	-----------

OE Part No

Fruehauf	M078580
----------	---------

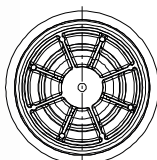
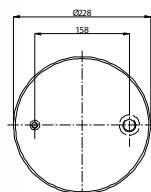
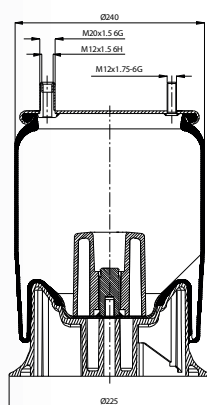

RT1.4154.C

Cross References

Contitech	4154 N P05
Firestone	1T15M-4
	W01M58 7283

OE Part No

Renault	5010 294 252
	132.051

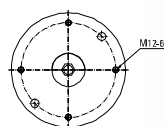
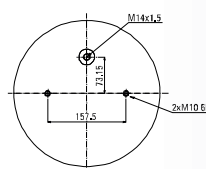
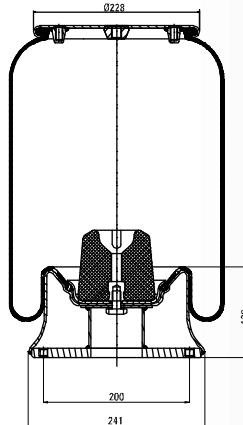

RT1.04154.CP02

Cross References

Firestone	1T15M-4
	W01358 8810
Contitech	9 10-14 A 546
Taurus	6362
Triangle	8546

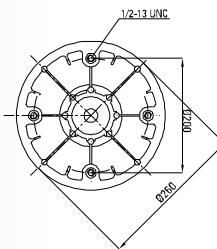
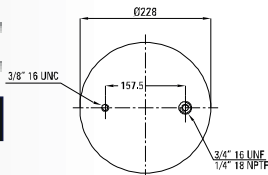
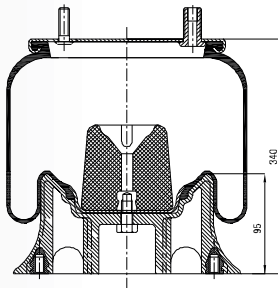

RT1.04154.CP05

Cross References

Contitech	4154 N P05
Firestone	1T15M-3
	W01M58 8172
Phoenix	1 DK 23 F-1
Vibracoustic	V1DK23F-1
Goodyear	1R 12-069

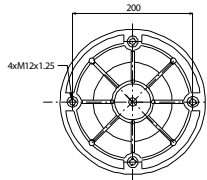
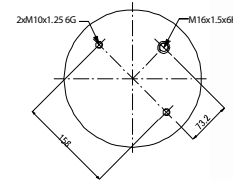
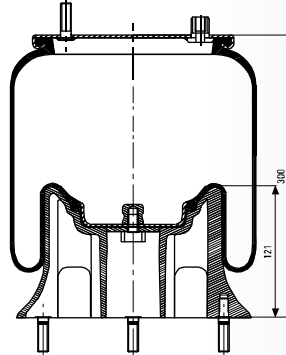

OE Part No

Irisbus	5 000 805 999
---------	---------------

OE Part No

Renault	5010 239 252
Renault	5010 488 071

RT1.4156.C04

Cross References

Contitech	4156 N P04
Goodyear	1R 12-092
Taurus	KR 506-225U
Dunlop	D12B33

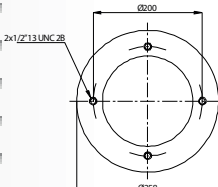
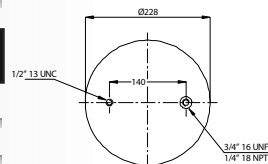
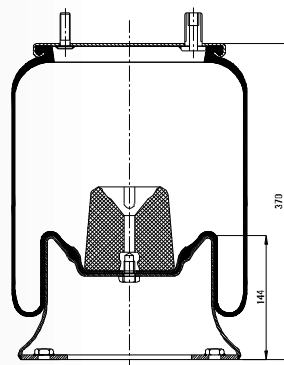

RT1.4156.C06

Cross References

Contitech	4156 N P06
Goodyear	1R 12-719
Phoenix	1 DK 21 A-2
Taurus	KR 506-28
Dunlop	D12B19

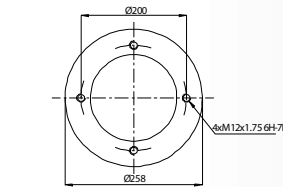
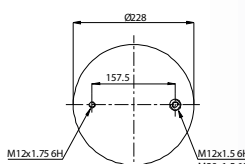
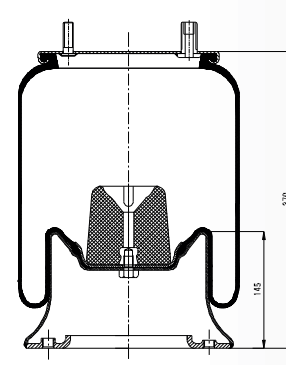

OE Part No

Ror	212 08939
Neway	905 57027
Neway	905 57075
Granning	1359
Granning	1528

OE Part No

Ror	21215761
Ror	21216135
Weweler	US 35864
Neway	905 570 75

RT1.4156.C07

Cross References

Contitech 4156 N P07

OE Part No

Smb ./. .

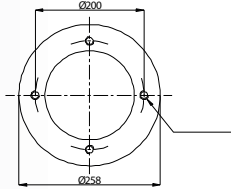
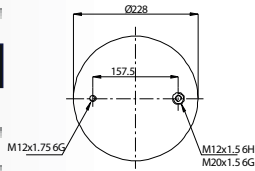
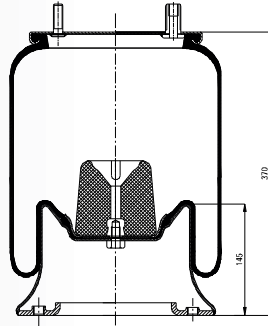

RT1.4156.C09

Cross References

Contitech 4156 N P09

Firestone 1T15M-6

W01M58 9089

Goodyear 1R 12-706

Dunlop D12B 16

OE Part No

Bertoja 454 02004

Fruehauf UJB 0207-001

Smb M00 1472

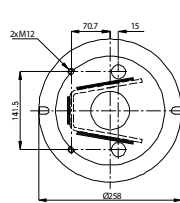
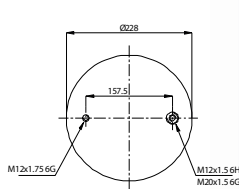
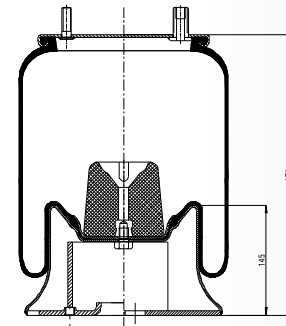

RT1.4156.C11

Cross References

Contitech 4156 N P11

OE Part No

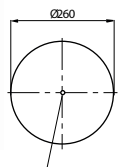
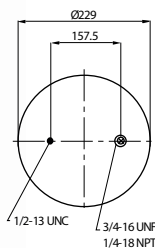
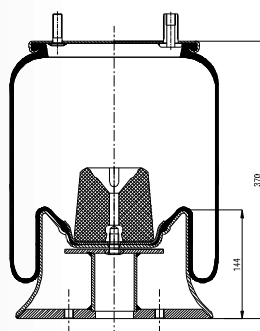

RT1.04156.CP10

Cross References

Contitech 4156 N P10

Firestone 1T15M-6

W01358 8929

Goodyear 1R 12-461

OE Part No

Hendrickson HA 100016

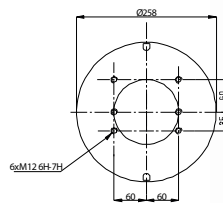
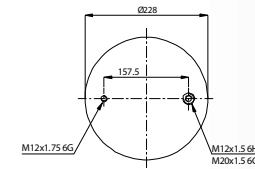
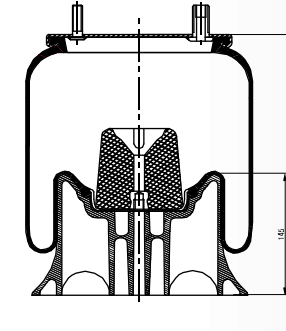

RT1.04156.CP14

Cross References

Cf Gomma	1T 323-32
Contitech	4156 N P14
Dunlop	D12B33
Good Year	1R 12-716
Phoenix	1DK 23 K-9082

OE Part No

Hendrickson	B 2066
Neway	905 570 27
Neway	905 570 75
Ror	2120 8939
Weweler	US 09361F

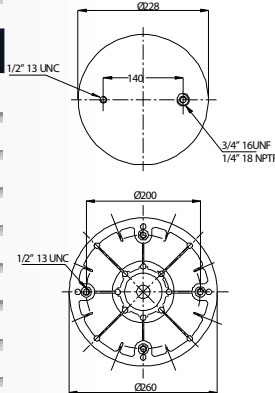
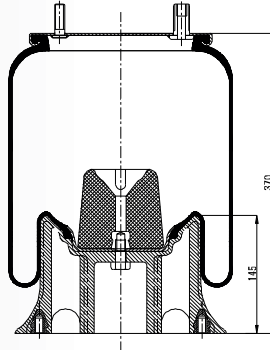

RT1.04156.CP15

Cross References

Contitech	4156 N P15
Firestone	1T15M-6
	W01358 9361
Goodyear	1R 12-716
Phoenix	1DK21A-2
Taurus	KR 506-28
Springride	D12B19

OE Part No

Fruehauf	M00 1472
Hendrickson	HA 100001
Ror	21215761
Smb	UJB 0207
Weweler	US 35864 F

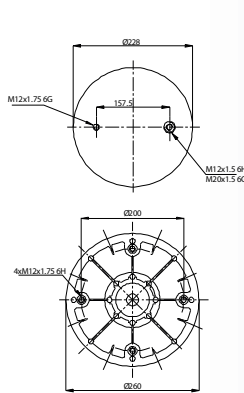
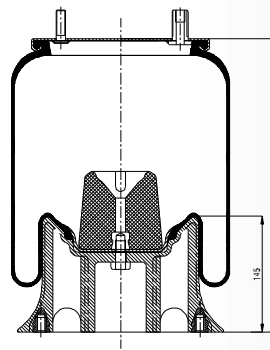

RT1.04156.CP16

Cross References

Contitech	4156 N P16
-----------	------------

OE Part No

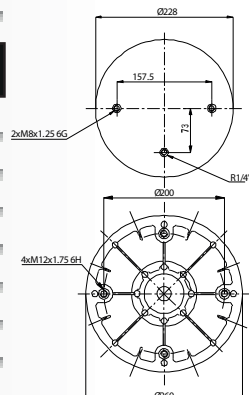
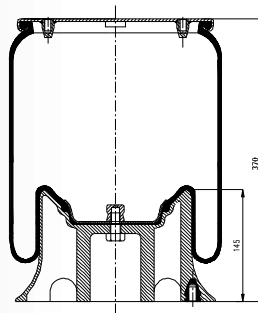

RT1.04157.CP03

Cross References

Contitech	4157 N P03
-----------	------------

OE Part No

Fruehauf	M078 580
Neway	905 572 33
Ror	2122 1307
Smb	M078 580

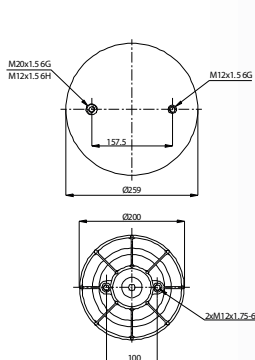
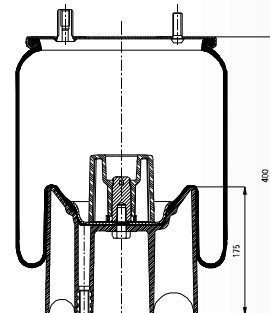

RT1.04157.CP04

Cross References

Contitech	4157 N P04
Firestone	1T15MPW-7
	W01M58 6297
Dunlop	D12B18
Goodyear	1R11-111
Taurus	KR 915-54
Phoenix	1DK 21A-4
	1DK 21A-8

OE Part No

Daimler Tas	A 946 328 1401
Ror	2122 1307
Weweler	US 06287
Weweler	US 07364

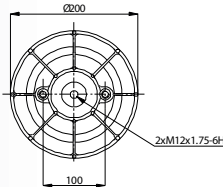
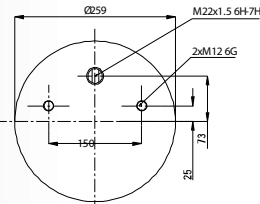
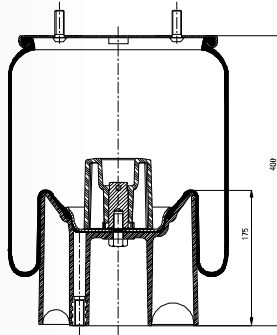

RT1.04157.CP05

Cross References

Contitech	4157 N P05
-----------	------------

OE Part No

Weweler	US 07074 C
Weweler	US 07074 P
Ror	2122 2442

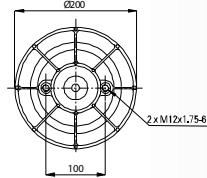
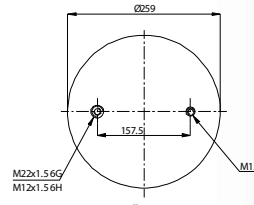
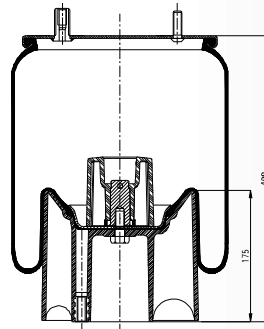

RT1.04157.CP06

Cross References

Contitech	4157 N P06
Firestone	1T15MPW-7
	W01M58 8186
Phoenix	1DK 20 A-1
Goodyear	1R11-764
Dunlop	D11B37

OE Part No

Schmitz	751065
Weweler	US 06316

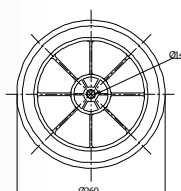
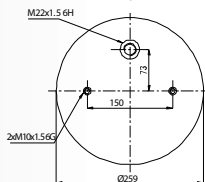
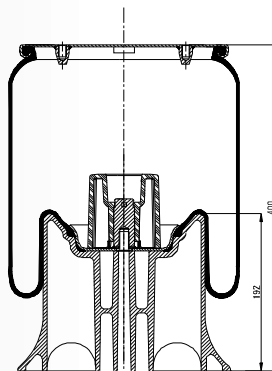

RT1.04157.C08

Cross References

Contitech	4157 N P08
Dunlop	D12B30
Goodyear	1R11-773
Firestone	1T15MPW-7
	W01.M58 6317
Phoenix	1DK 20 C-2

OE Part No

Neway	905 572 33
Samro	H 2501869
Smb	M 078580

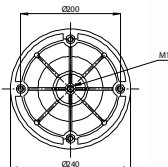
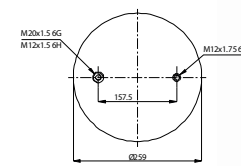
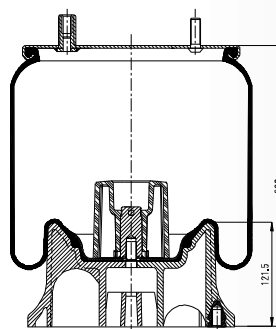

RT1.04157.CP09

Cross References

Contitech	4157 N P09
Firestone	1T15MPW-7
	W01M58 7074
Dunlop	D12B17
Goodyear	1R11-106
Phoenix	1DK 21A-31
Taurus	KR 913-57
Cf Gomma	1T 300-38 205598

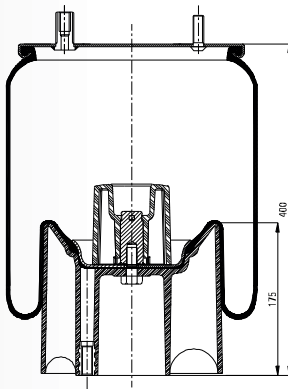

RT1.04157.CP10

Cross References

Contitech	4157 N P10
Firestone	1T15MPW-7
	W01M58 6315
Dunlop	D12B29
Goodyear	1R11-772
Phoenix	1DK 20 A-51
Taurus	KR 915-51

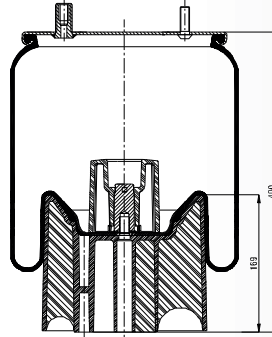

OE Part No

Ror	2122 2442
Weweler	US 07074 F

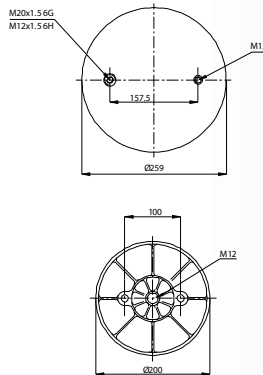
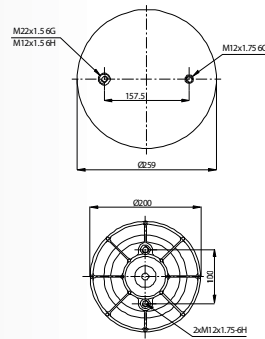

OE Part No

Acerbi	128140028
Acerbi	800449526
Fruehauf	UJ 0975
Smb	M060924

RT1.04158.CP03

Cross References

Contitech	4158 N P03
Firestone	1T15MPW-9
	W01M58 8185
Dunlop	D12B22
Goodyear	1R12-749
Phoenix	1DK 20 B-1

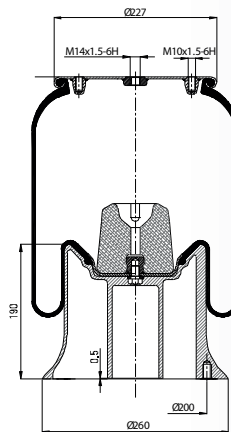
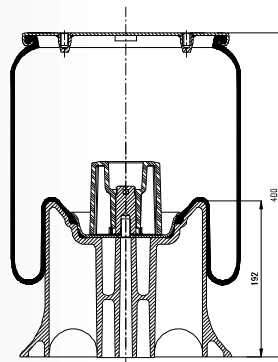

Cross References

Goodyear	1R12-713
Firestone	1T15M-9
	W01-M58-7308

OE Part No

Schmitz	014 892
Schmitz	750 999
Weweler	US 06285

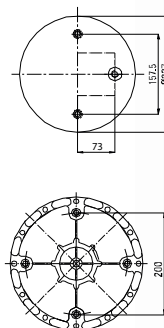
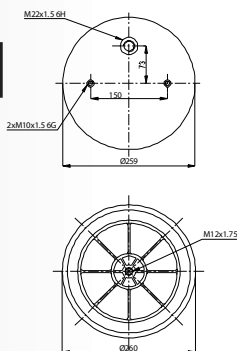

OE Part No

Scania Truck	1314905
--------------	---------

RT1.4159.C03

Cross References

Contitech	4159 N P03
Firestone	1T15M-9
	W01M58 8859
Dunlop	D12B01
Phoenix	1DK 21B-4
Cf Gomma	1T 323-40

OE Part No

Fruehauf	UJA 0894
Fruehauf	UJB 0203

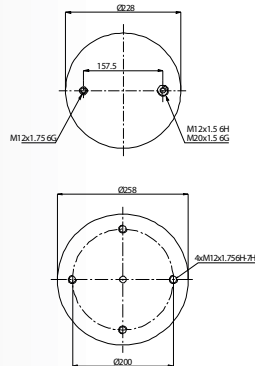
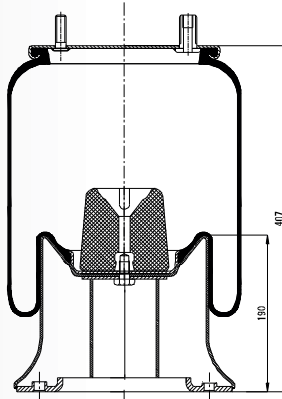

RT1.4159.C04

Cross References

Contitech	4159 N P04
-----------	------------

OE Part No

Neway	905 570 09
-------	------------

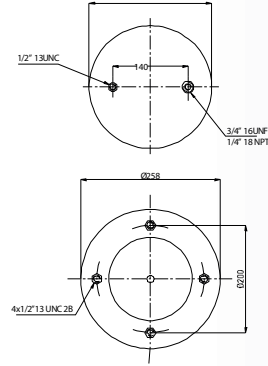
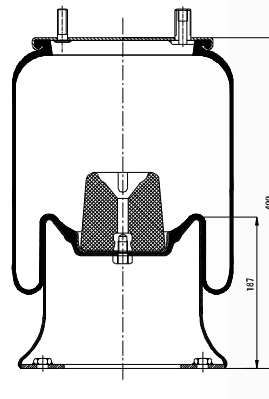

RT1.4159.C06

Cross References

Contitech	4159 N P06
-----------	------------

OE Part No

Neway	M 00557007
Fruehauf	UJA 0894-001
Ror	21215891

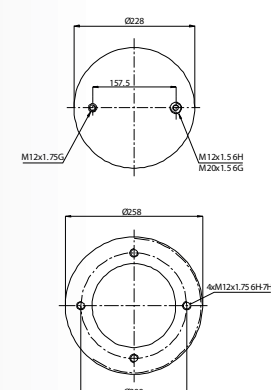
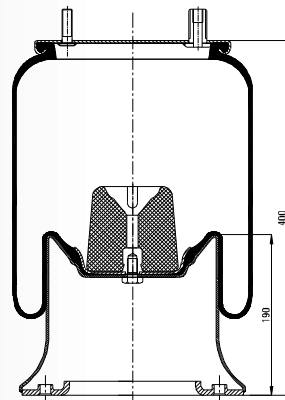

RT1.4159.C07

Cross References

Contitech	4159 N P07
Cf	1T 323-40 202302
Gomma	D12B15
Dunlop	1T15M-9
Firestone	W01M58 8859
Firestone	W01379 9071
Firestone	1R 12-702
Goodyear	1DK 21B-6
Phoenix	KR 509-25

OE Part No

Fruehauf	M001782
Fruehauf	UJB 0203-001
Crane Fruehauf	UJB 0203
Crane Fruehauf	UJB 0203-001
Crane Fruehauf	UJA 0874-1
Ackermann Fruehauf	M001782
Fruehauf-acerbi	202302

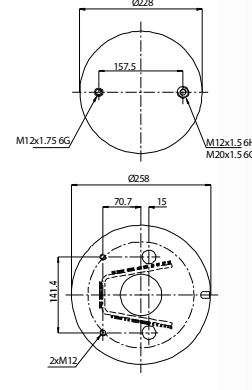
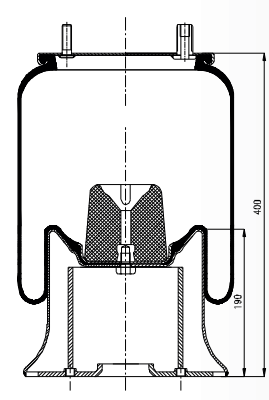

RT1.4159.C08

Cross References

Contitech	4159 N P08
Goodyear	1R12-281

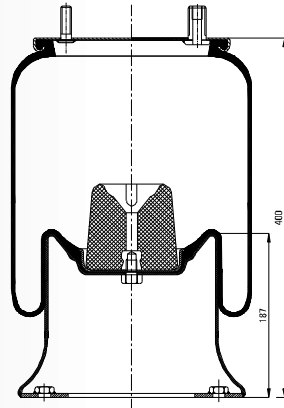

OE Part No

Hendrickson	NA 1817
-------------	---------

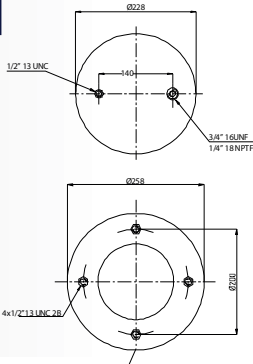

RT1.4159.C10

Cross References

Contitech	4159 N P10
Firestone	TT15M-9
	W01M58 0736

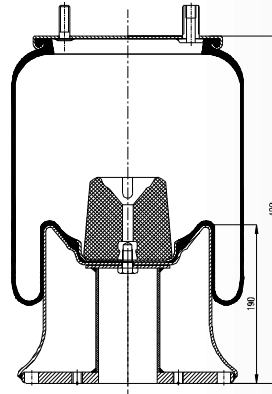

OE Part No

Vdl Bus	1 153 933
---------	-----------

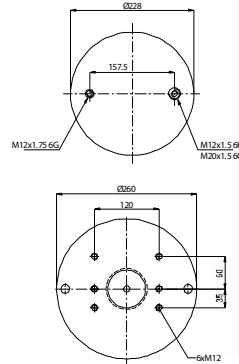

RT1.4159.C15

Cross References

Contitech	4159 N P15
-----------	------------

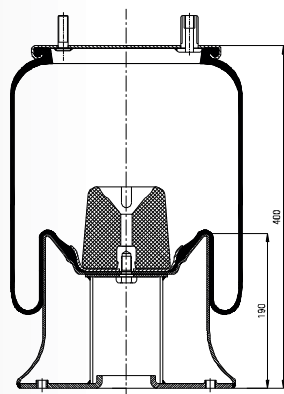

OE Part No

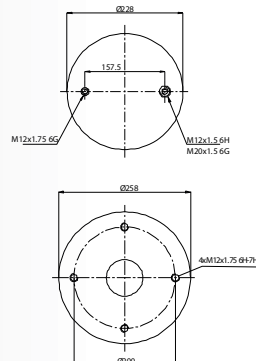

RT1.4159.C19

Cross References

Dunlop	D12 B07
	D12 B09

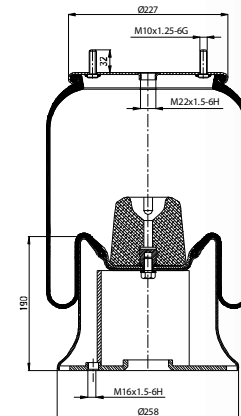

OE Part No

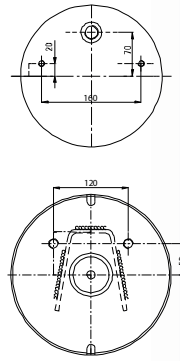

RT1.04159.CP09

Cross References

Contitech	4159 N P09
Firestone	1T15M-9
	W01M58 9131
Goodyear	1R12-721
Springride	D12B04
Phoenix	1DK 21B-8
Cf Gomma	1T 323-40 200751

OE Part No

Cardi	580 51210
Fruehauf	UJB 0358-001
Samro	H 2500324
Smb	152 5199
Smb	M 001774

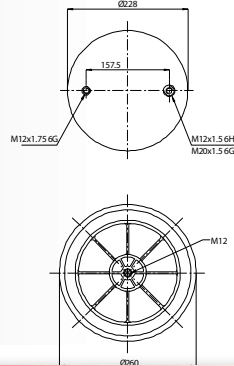
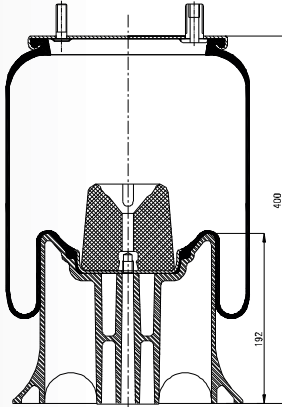

RT1.04159.CP11

Cross References

Contitech	4159 N P11
-----------	------------

OE Part No

Hendrickson	B 3842
-------------	--------

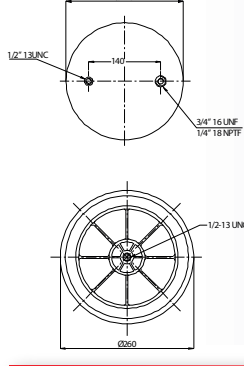
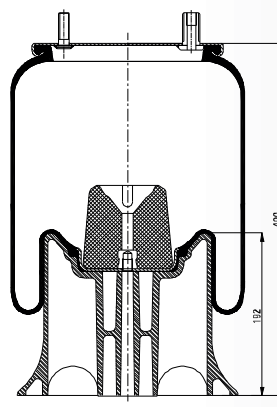

RT1.04159.CP12

Cross References

Contitech	4159 N P12
Contitech	9 10-19 P 315
Firestone	1T15M9
	W01358 9101
Goodyear	1R12-717
Triangle	8315
Taurus	6364

OE Part No

Dayton	352-9101
Hendricks	B 3842
on	SC2038
Loadguard	554768C1
Navistar /	12883-01
Fleetrite	S-5828-C
Reyco	S-740-C
Ridewell	1003589101C

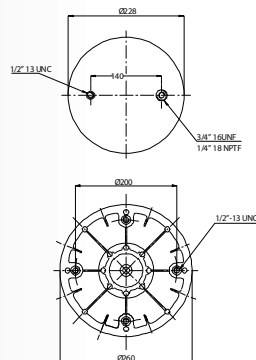
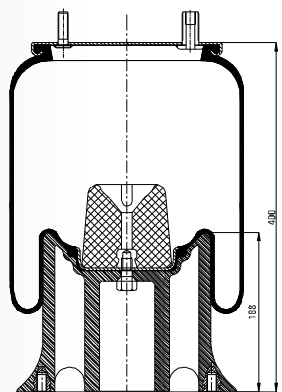

RT1.04159.CP13

Cross References

Contitech	4159 N P13
Contitech	9 10-19 P 326
Firestone	1T15M-9
	W01358 9192
Goodyear	1R12-167
Triangle	8326
Taurus	6364

OE Part No

Hendrickson	NA 1817
Hendrickson	S-6195
Loadguard	SC2120
Navistar / Fleetrite	1681738C1
Navistar / Fleetrite	1681740C1
Saf Holland	90557086
Saf Holland	90557108
Saf Holland	90557135

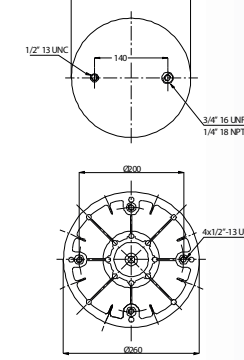
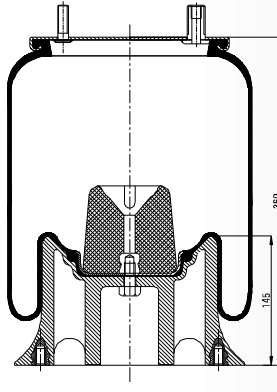

RT1.04159.CP14

Cross References

Contitech	4159 N P14
Firestone	1T15M-9
	W01M58 7548
Cf Gomma	1T 323-40
Phoenix	1DK 21B-4
Vibracoustic	V1DK21B-4
Springride	D12B01
Dunlop Uk	PNP311370000

OE Part No

Fruehauf	UJA 0894-001
	21215891

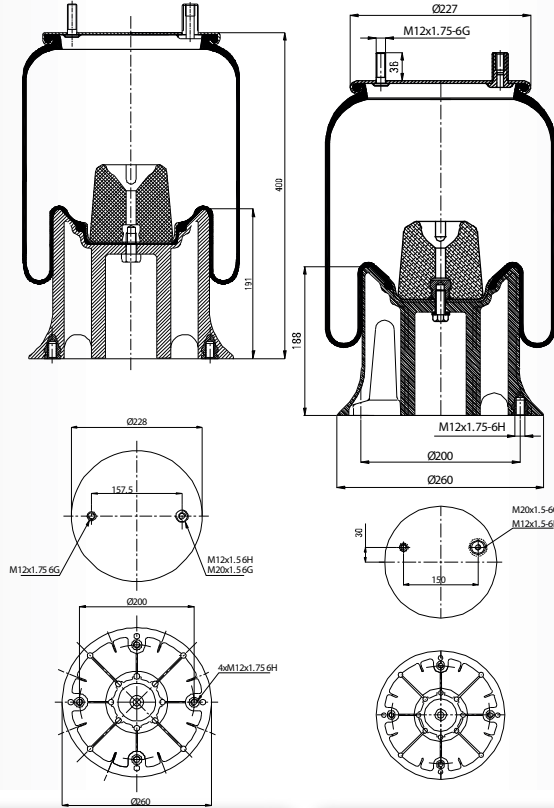

RT1.04159.CP27

Cross References

Firestone	W016819242
-----------	------------

OE Part No

Granning	11382
	15699

RT1.4183.C23

Cross References

Contitech	4183 N P23
-----------	------------

OE Part No

Mercedes	A 942 320 2221
----------	----------------

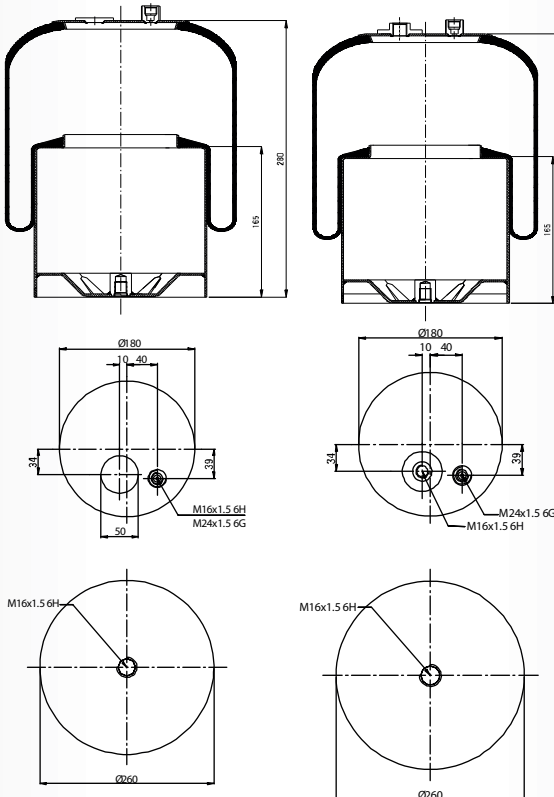

RT1.4183.C24

Cross References

Contitech	4183 N P24
-----------	------------

OE Part No

Mercedes	A 942 320
	2321

RT1.4185.C01

Cross References

Contitech 4185 N P01

OE Part No

Mercedes A 974 320 0021

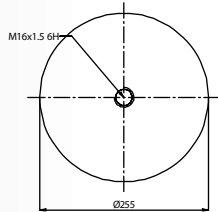
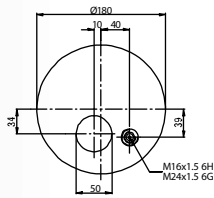
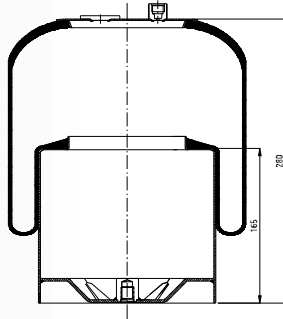

RT1.4185.C21

Cross References

Contitech 4185 N P21

OE Part No

Mercedes A 942 320 3021

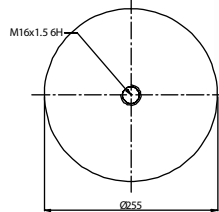
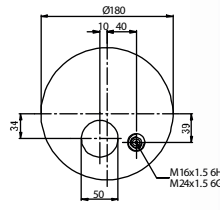
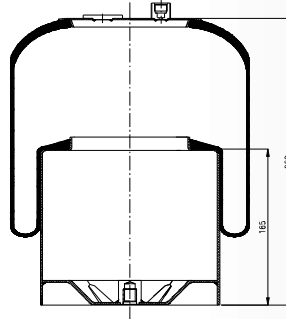

RT1.4187.C01

Cross References

Contitech 4187 N P01

OE Part No

Mercedes A 942 320 1821

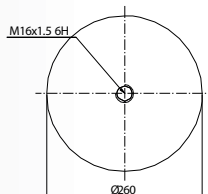
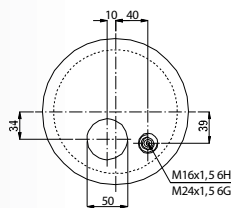
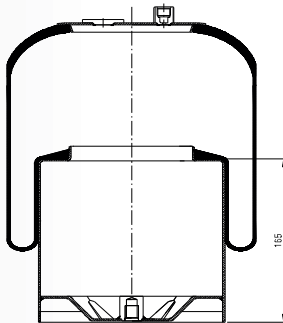

RT1.4187.C21

Cross References

Contitech 4187 N P21

OE Part No

Mercedes A 942 320 2621

Mercedes A 942 320 7221

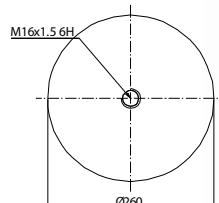
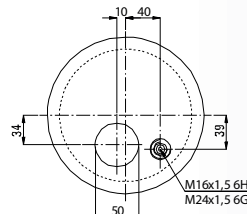
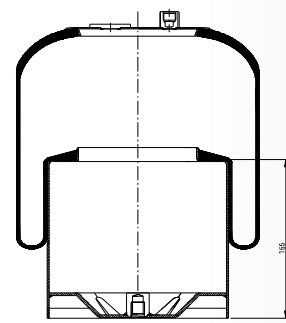

RT1.4390.C01

Cross References

Contitech	4390 N P01
Goodyear	9505
Phoenix	1KF 21-1
Dunlop	D12T10

OE Part No

Mercedes	A 942 320 0121
----------	----------------

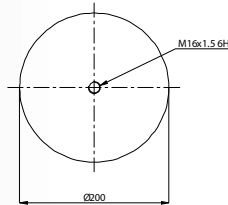
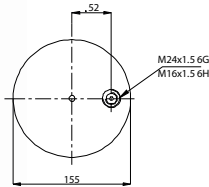
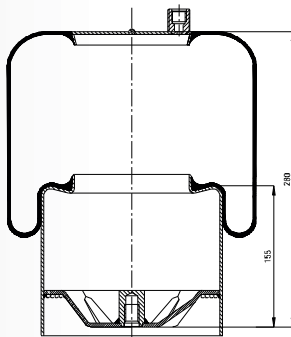

RT1.4390.C02

Cross References

Contitech	4390 N P02
Goodyear	9506
Dunlop	D12T11
Phoenix	1KF 21-2

OE Part No

Mercedes	A 942 320 0221
----------	----------------

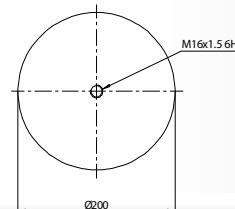
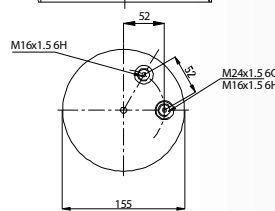
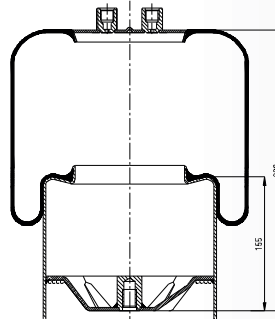

RT1.4390.C03

Cross References

Contitech	4390 N P03
Goodyear	9506
Dunlop	D12T11

OE Part No

Mercedes	A 942 320 0421
----------	----------------

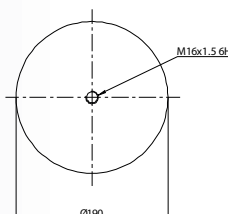
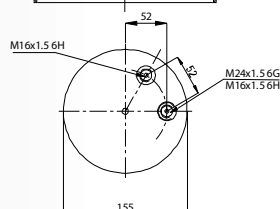
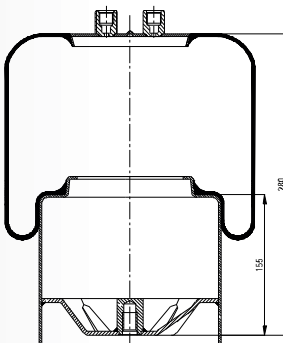

RT1.4390.C04

Cross References

Contitech	4390 N P04
-----------	------------

OE Part No

Mercedes	A 942 320 0321
----------	----------------

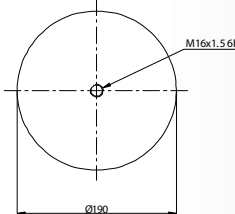
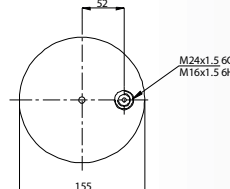
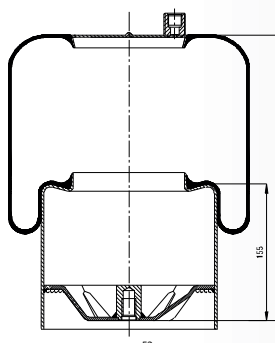

RT1.4390.C21

Cross References

Contitech 4390 N P21

OE Part No

Mercedes A 942 320 2821

Mercedes A 942 320 4921

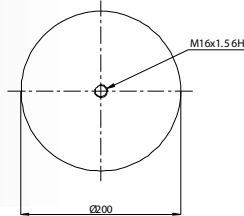
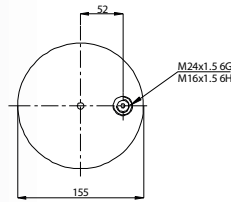
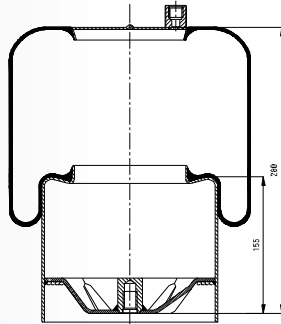

RT1.4390.C22

Cross References

Contitech 4390 N P22

OE Part No

Mercedes A 942 320 2921

Mercedes A 942 320 5021

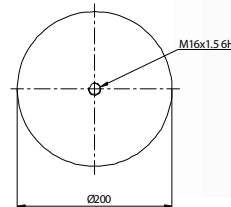
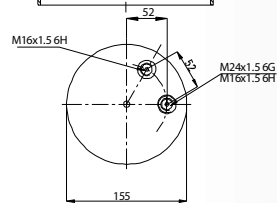
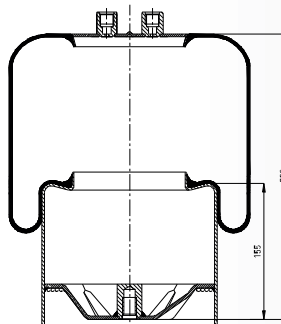

RT1.4390.C23

Cross References

Contitech 4390 N P23

OE Part No

Mercedes A 942 320 5221

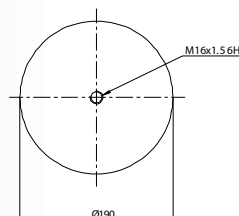
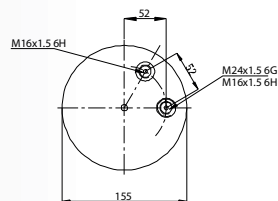
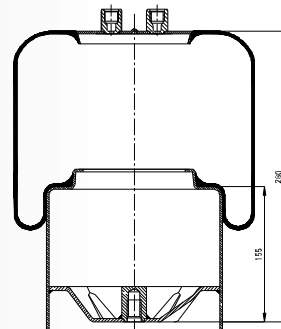

RT1.4390.C24

Cross References

Contitech 4390 N P24

OE Part No

Mercedes A 942 320 5121

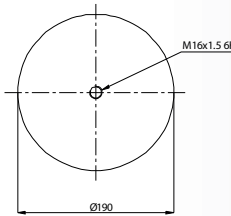
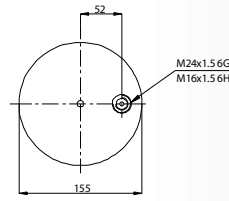
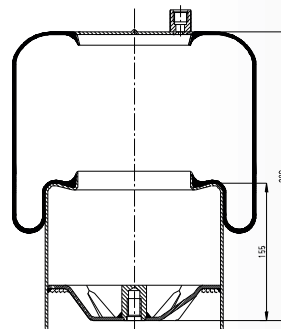

RT1.4391.C01

Cross References

Contitech 4391N P01

OE Part No

Mercedes A 942 320 0621

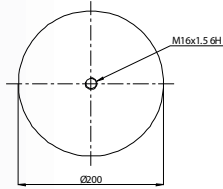
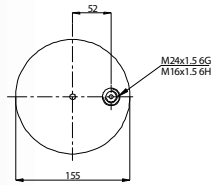
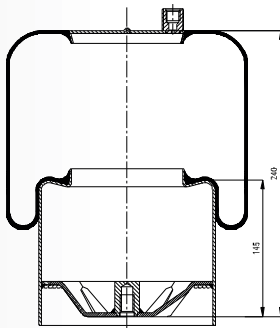

RT1.4391.C02

Cross References

Contitech 4391N P02

OE Part No

Mercedes A 942 320 0721

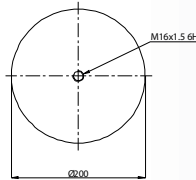
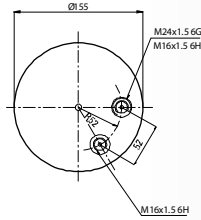
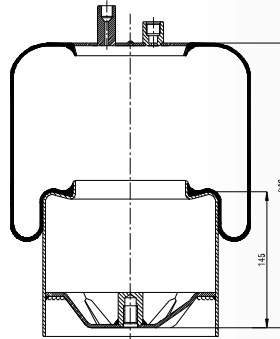

RT1.4391.C21

Cross References

Contitech 4391N P21

OE Part No

Mercedes A 942 320 5321

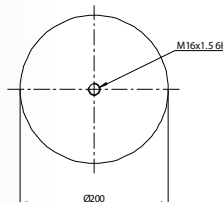
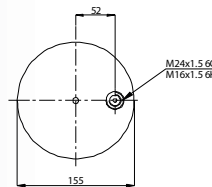
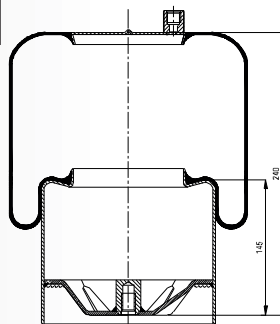

RT1.4391.C22

Cross References

Contitech 4391N P22

OE Part No

Mercedes A 942 320 5421

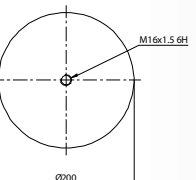
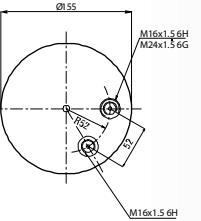
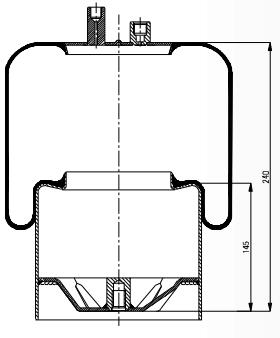

RT1.4420.C01

Cross References

Contitech	4420 N P01
Firestone	TT17SR-6.5
	W01M58 9707

OE Part No

Volvo	1076 075
Volvo	1076 076
Volvo	20 554 756

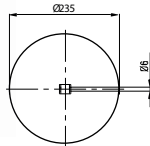
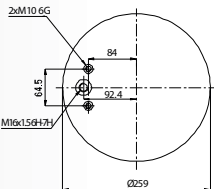
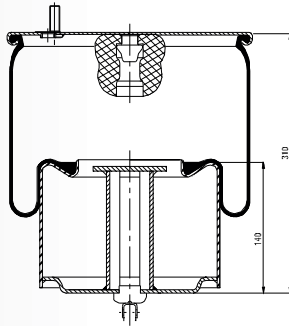

RT1.4506.C

Cross References

Goodyear	1R11-832
----------	----------

OE Part No

Scania - S.Bussar	1434506
Scania - S.Bussar	473868
Scania - S.Bussar	488269

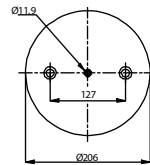
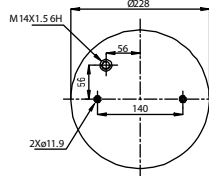
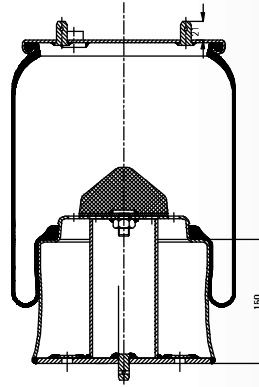

RT1.4506.C01

Cross References

Goodyear	1R11-838
----------	----------

OE Part No

Scania - S.Bussar	1726243
-------------------	---------

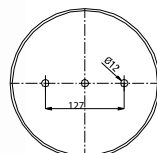
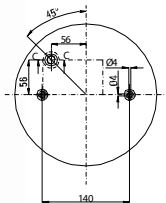
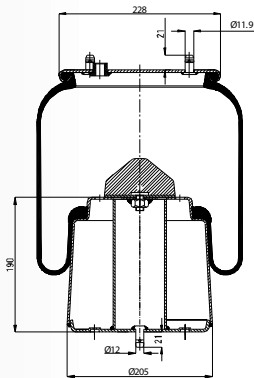

RT1.4644.C02

Cross References

Contitech	4644 N P02
-----------	------------

OE Part No

Evo Bus	A 629 320 0025
---------	----------------

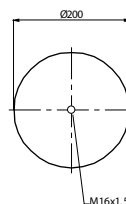
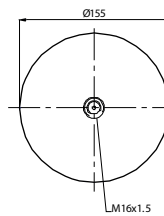
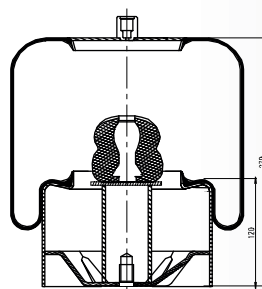

RT1.4705.C03

Cross References

Contitech 4705 N1P03

OE Part No

Man 8143600 6039

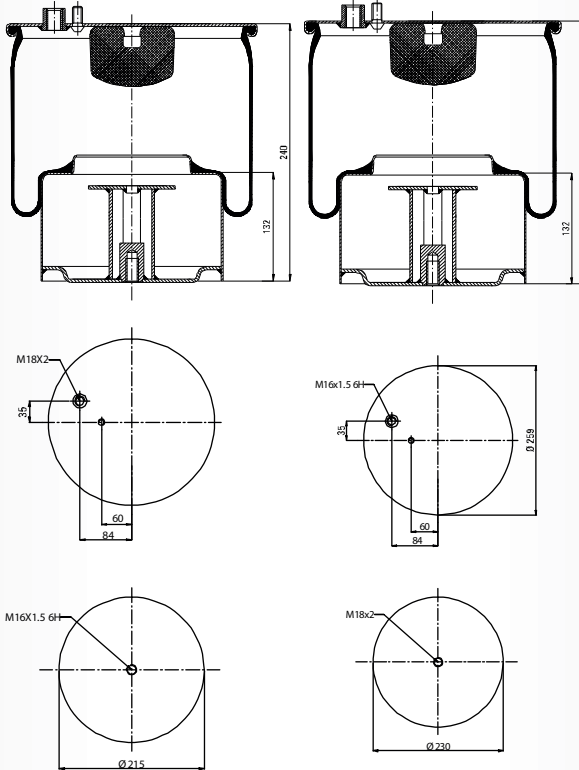

RT1.4705.C04

Cross References

Contitech 4705 N1P04

OE Part No

Man 8143600 6040

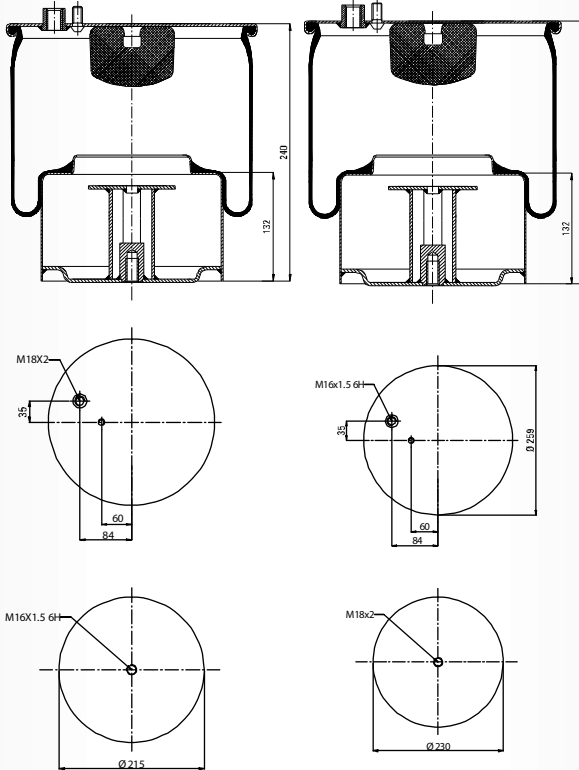

RT1.4713.C02

Cross References

Contitech 4713 N P02

Firestone 1T17 BSR-8

W01 M58 9706

Dunlop D12B24

Goodyear 1R 12-762

Phoenix 1 DF 22 C-1

OE Part No

Volvo 1076 594

Volvo 20 554 755

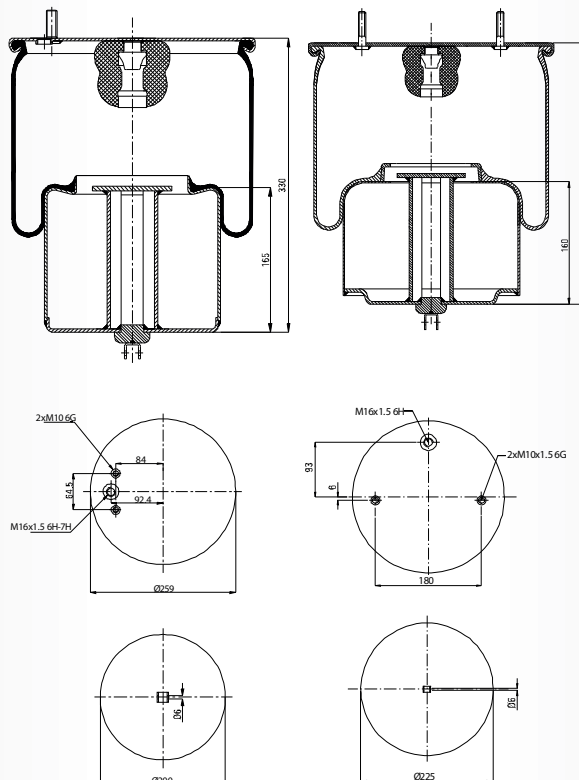

RT1.4718.C01

Cross References

Contitech 4718 N P01

OE Part No

Volvo 1075 363

Volvo 20 452 136

Volvo 20 554 759

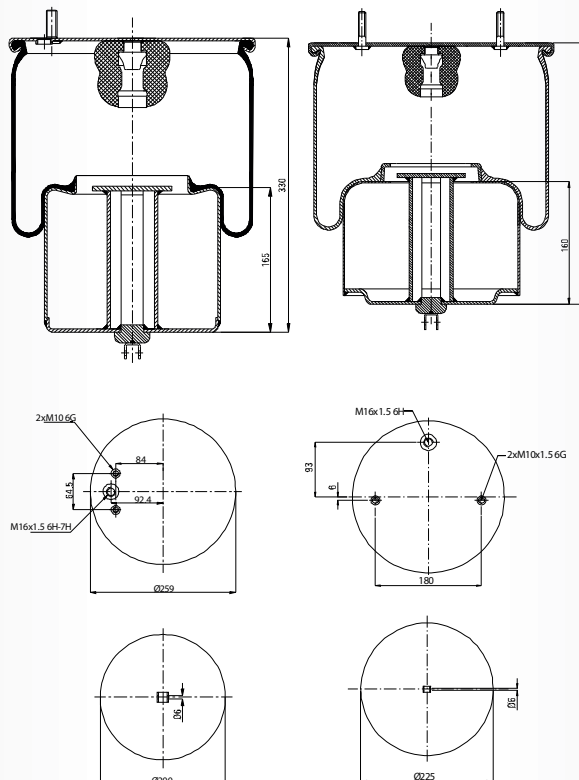

RT1.4737.C01

Cross References

Contitech 4737 N P01

OE Part No

Mercedes A 946 320 0321

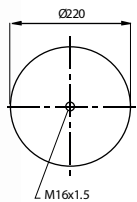
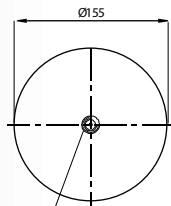
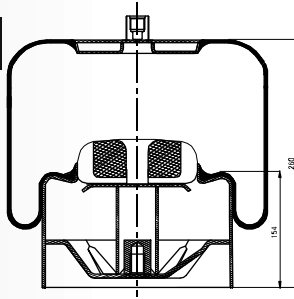

RT1.4737.C02

Cross References

Contitech 4737 N P02

OE Part No

Mercedes A 946 320 0521

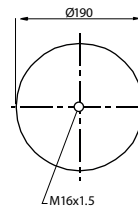
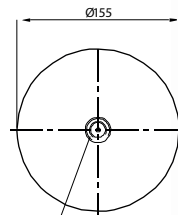
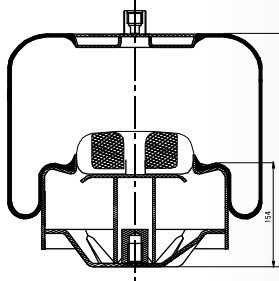

RT1.4737.C05

Cross References

Contitech 4737 N P05

OE Part No

Mercedes A 957 320 0117

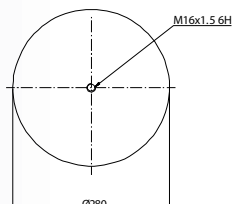
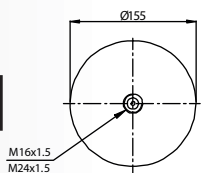
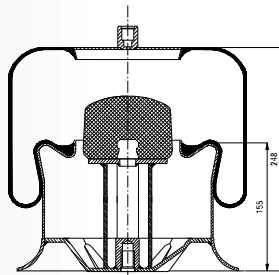

RT1.4737.C21

Cross References

Contitech 4737 N P21

OE Part No

Mercedes A 942 320 3721

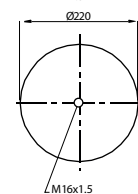
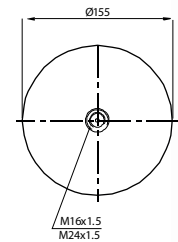
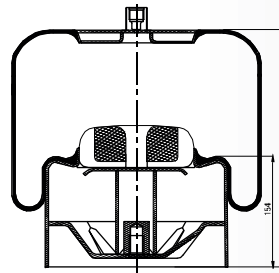

RT1.4737.C22

Cross References

Contitech 4737 N P22

OE Part No

Mercedes A 942 320 3921

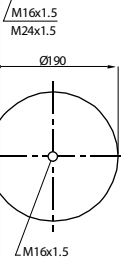
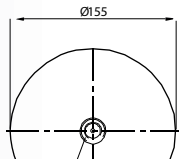
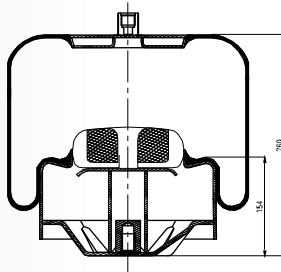

RT1.4737.C25

Cross References

Contitech 4737 N P25

OE Part No

Mercedes A 957 320 0317

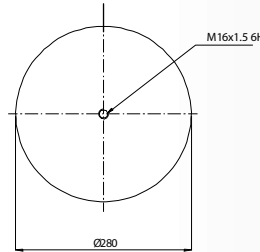
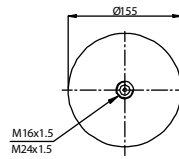
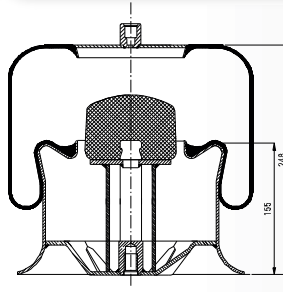

RT1.4757.C01

Cross References

Contitech 4757 N P01

Firestone 1R7Z460305A

W01M58 8521

Goodyear 9519

OE Part No

Mercedes A 942 320 0117

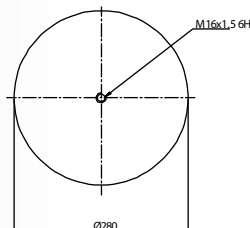
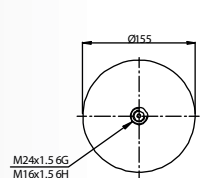
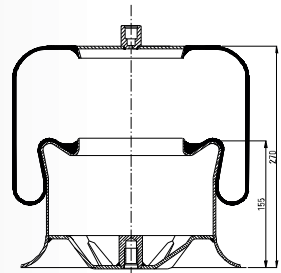

RT1.4757.C09

Cross References

Contitech 4757 N P09

Firestone 1R7Z460305B

W01M58 8522

Goodyear 9520

OE Part No

Mercedes A 974 320 0417

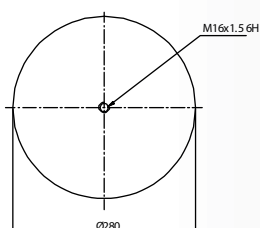
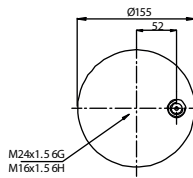
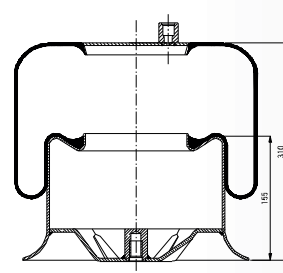

RT1.4757.C21

Cross References

Contitech 4757 N P21

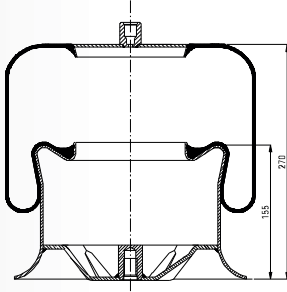

OE Part No

Mercedes A 942 320 4321

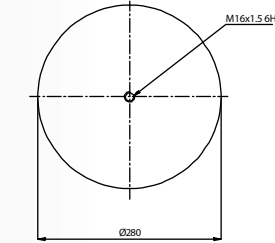
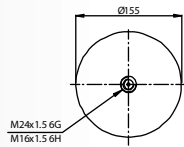

RT1.4757.C29

Cross References

Contitech 4757 N P29

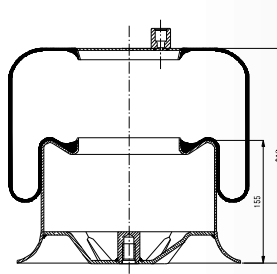

OE Part No

Mercedes A 942 320 3221

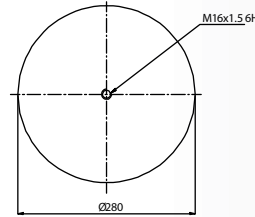
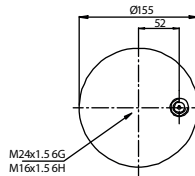

RT1.4758.C01

Cross References

Contitech 4758 N P01

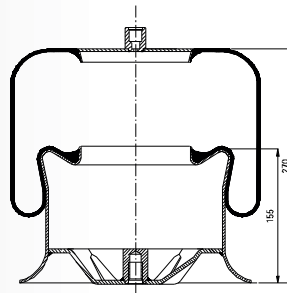

OE Part No

Mercedes A 945 320 0017

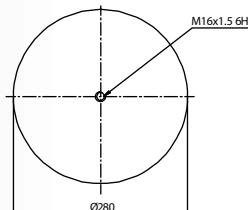
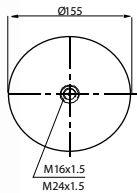

RT1.4758.C21

Cross References

Contitech 4758 N P21

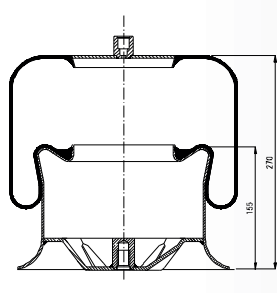

OE Part No

Mercedes A 942 320 4821

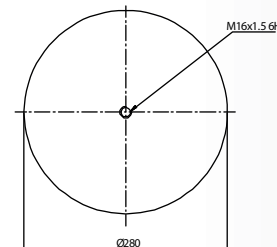
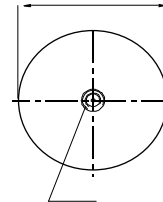

RT1.4759.C01

Cross References

Contitech 4759 N P01

OE Part No

Mercedes A 942 320 0217

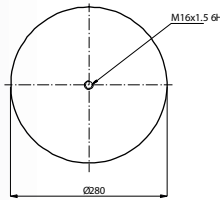
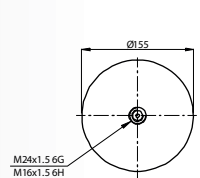
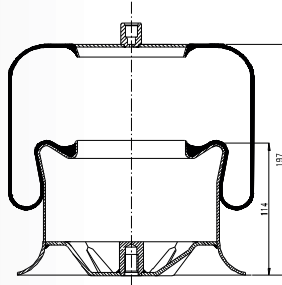

RT1.4759.C21

Cross References

Contitech 4759 N P21

OE Part No

Mercedes A 942 320 4421

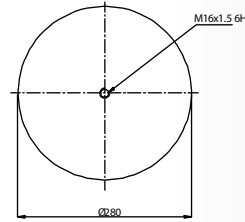
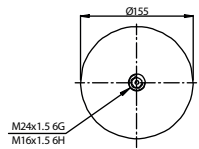
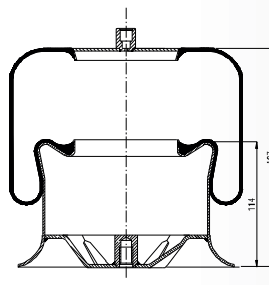

RT1.4760.C

Cross References

Contitech 2136 M

OE Part No

Volvo 20554760

Volvo 20452136

Volvo 20452142

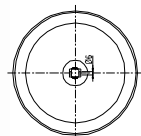
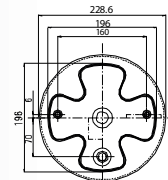
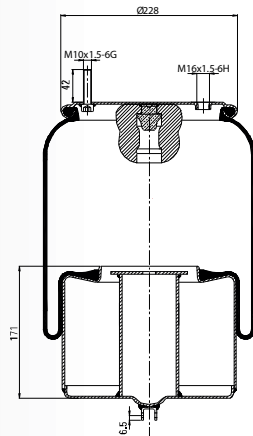

RT1.4762.C

Cross References

Contitech 6613 N P01

OE Part No

Volvo 20 554 762

Volvo 204 798 02

Volvo 204 52138

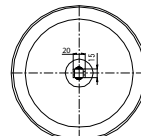
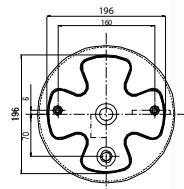
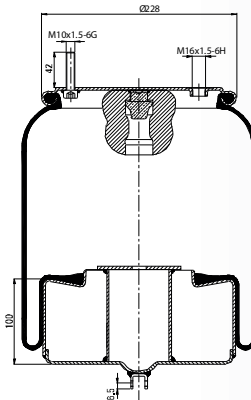

RT1.4786.C21

Cross References

Contitech 4786 N P21

OE Part No

Dc A 942 320 45 21

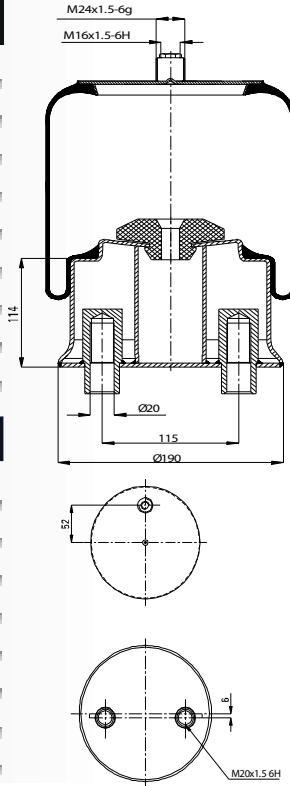

RT1.4810.C05

Cross References

Contitech	4810 N P05
Firestone	1T19L-7
	W01M58 6338
Goodyear	1R14-730
Dunlop	D13B25
Cf Gomma	1T19 E-1205456
Phoenix	1D28 A-10
Taurus	KR 621-18

OE Part No

Saf Holland	3 229 0027 00
Saf Holland	3 229 2127 00
Saf Holland	3 229 2227 00
	2918 V E1,2 BOLTS

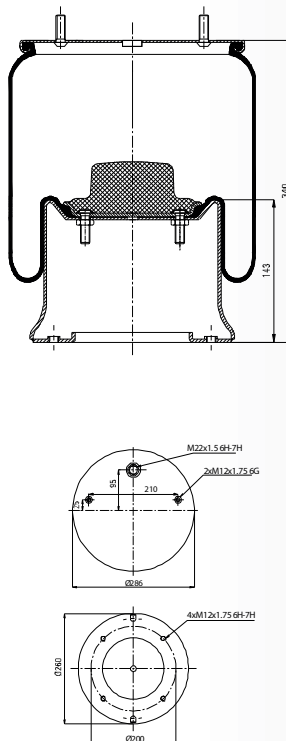

RT1.4813.C07

Cross References

Contitech	4813 N P07
Firestone	1T19L-11
	W01M58 7358
Goodyear	1R14-727
Dunlop	D13B10
Dunlop	D13B22
Phoenix	1D28 B-9

OE Part No

Scania	110764
Scania	1314906
Scania	1865755
Scania	255293
Scania	255295
Scania	298568
Scania	325748

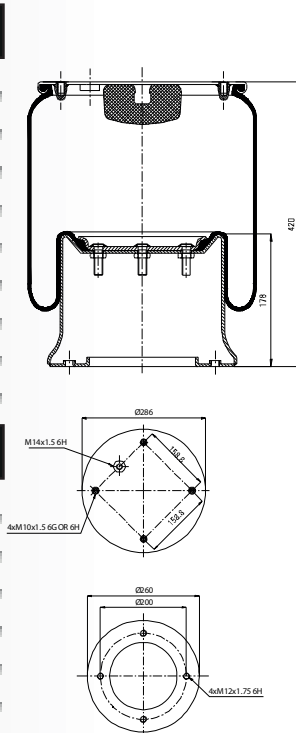

RT1.4823.C

Cross References

Goodyear	1R14-823
Firestone	1T19L-11
	W01M58 6223
Vibracoustic	V1DK28F-3
Phoenix	1DK28F-3

OE Part No

Discos Mercedes	A 946 328 15 01
Weweler	US04030P
Schmitz	S015323

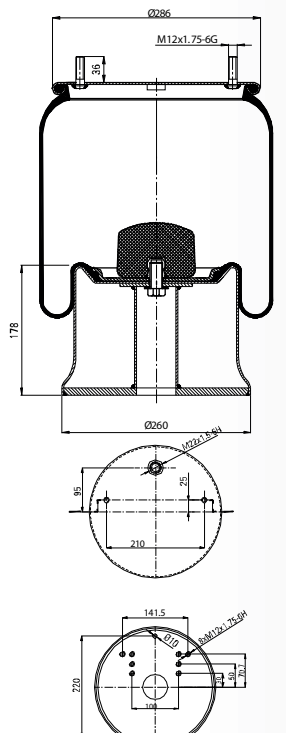

RT1.4838.C01

Cross References

Contitech	4838 N P01
Firestone	1R7Z595330A
	W01M58 8512

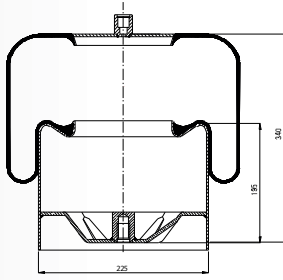

OE Part No

Mercedes	A 946 320 0421
----------	----------------

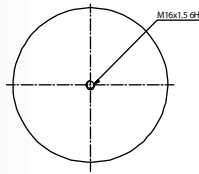
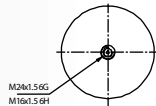

RT1.4838.C02

Cross References

Contitech	4838 N P02
-----------	------------

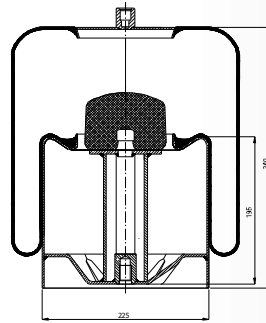

OE Part No

Mercedes	A 946 320 0221
----------	----------------

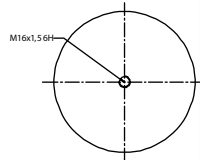
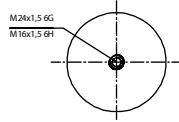

RT1.4838.C03

Cross References

Contitech	4838 N P03
-----------	------------

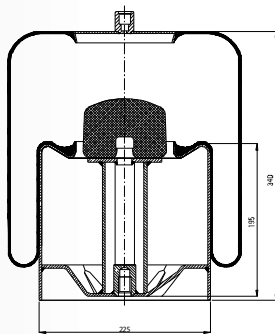

OE Part No

Mercedes	A 946 320 0121
----------	----------------

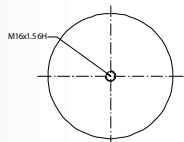

RT1.4838.C21

Cross References

Contitech	4838 N P21
Firestone	1R7Z595330A
	W01M58 8512

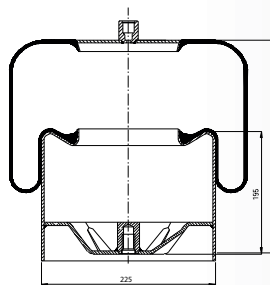

OE Part No

Mercedes	A 942 320 3821
----------	----------------

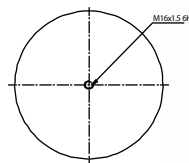
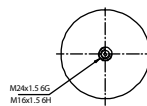

RT1.4838.C22

Cross References

Contitech 4838.N P22

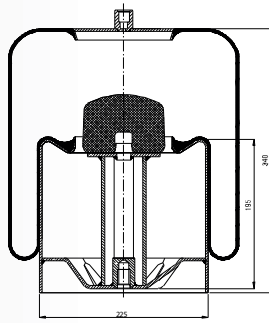

OE Part No

Mercedes A 942 320 3621

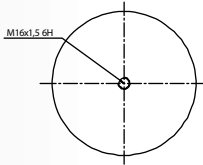
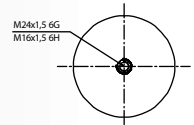

RT1.4838.C23

Cross References

Contitech 4838 N P23

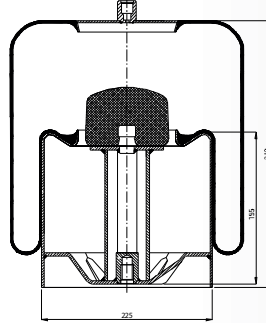

OE Part No

Mercedes A 942 320 3521

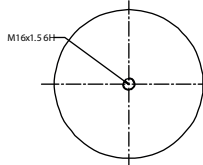
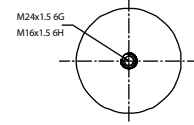

RT1.4881.C

Cross References

Contitech 4881 MB

Firestone 1T66F-7.0

W01M58 8602

Goodyear 1R 14-724

Phoenix 1DK 32 K-1

Dunlop D14B37

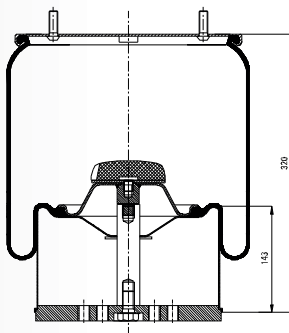

OE Part No

Bpw 05 429 4122 1

36 K

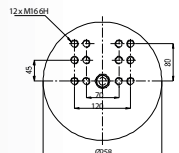
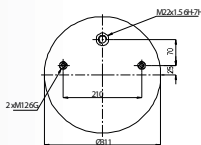

RT1.04881.CP

Cross References

Contitech 4881 MB

Firestone 1T66F-7.0

W01M58 8666

Goodyear 1R 14-748

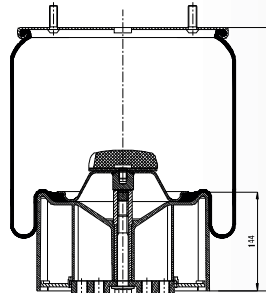

OE Part No

Bpw 05 429 43 510

36

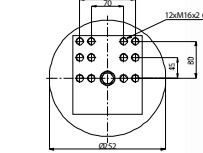
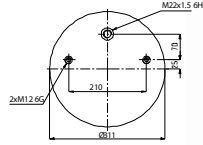

RT1.4882.C05

Cross References

Contitech	4882 N1P05
Firestone	TT17JR7.2
	W01M58 9879

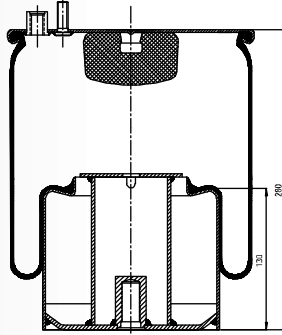

OE Part No

Man	8143600 6036
-----	--------------

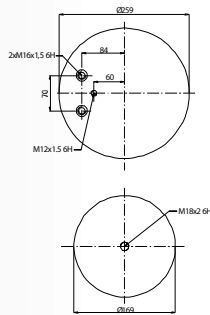

RT1.4883.C05

Cross References

Contitech	4883 N1P05
-----------	------------

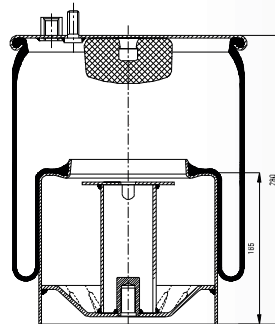

OE Part No

Man	8143600 6037
-----	--------------

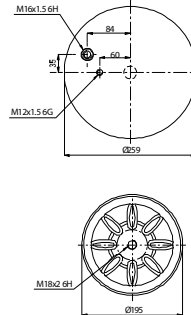

RT1.4884.C06

Cross References

Contitech	4884 N1P06
Firestone	TT17TWR8.0
	W01M58 9880

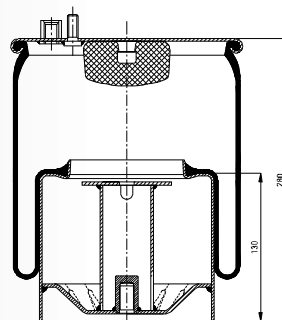

OE Part No

Man	8143600 6035
-----	--------------

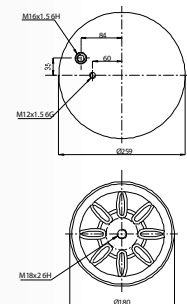

RT1.4885.C02

Cross References

Contitech	4885 N1P02
-----------	------------

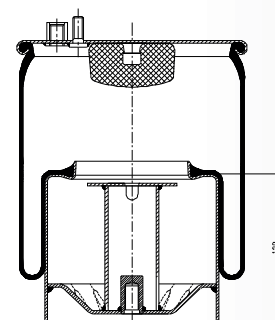

OE Part No

Man	8143600 6044
-----	--------------

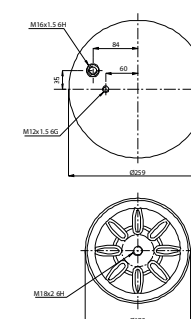

RT1.04920.CP

Cross References

Contitech 4920 N P01

OE Part No

Renault 5010 600 172

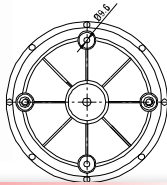
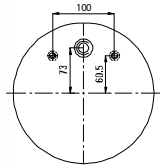
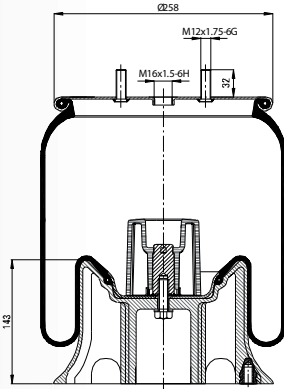

RT1.4929.C

Cross References

Contitech 4929 N P01RT

OE Part No

Renault 7420 767 358

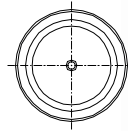
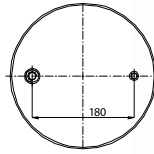
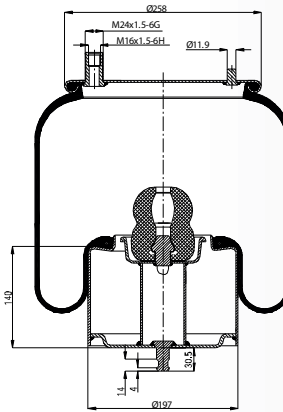

RT1.04930.CP

Cross References

Firestone 1T15UR-9
W01M58 8653

OE Part No

Scania 1434930

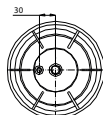
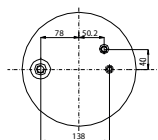
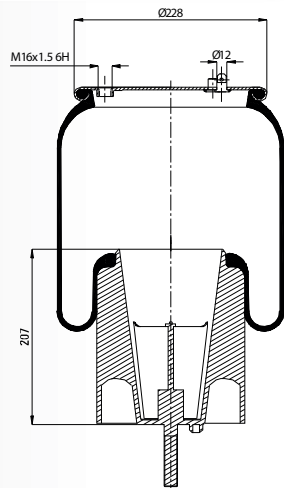

RT1.4933.C

Cross References

Firestone 1T17HR-8
W01M58 8633

OE Part No

Scania 1434933

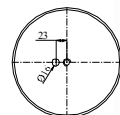
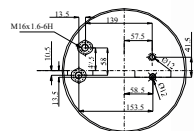
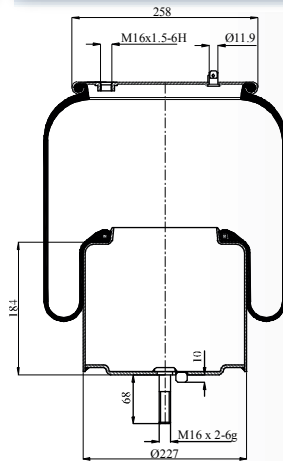

RT1.04963.CP

Cross References

Contitech 4963 N P03

OE Part No

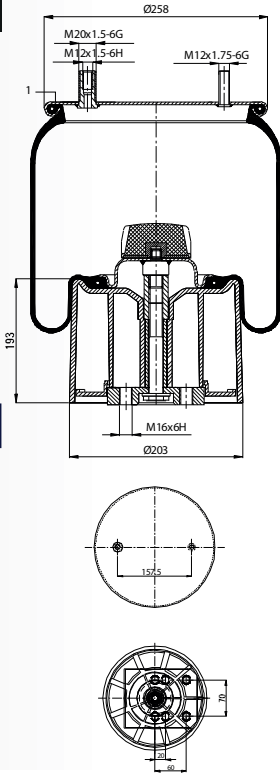

RT1.6199.C

Cross References

Goodyear 1R13-744
Meritor MLF 7146

OE Part No

Scania - S.Bussar 1386199

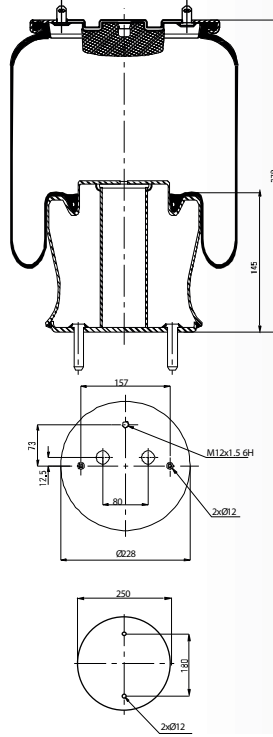

RT1.6200.C

Cross References

Goodyear 1R13-745
Meritor MLF 7167

OE Part No

Scania - S.Bussar 1386200

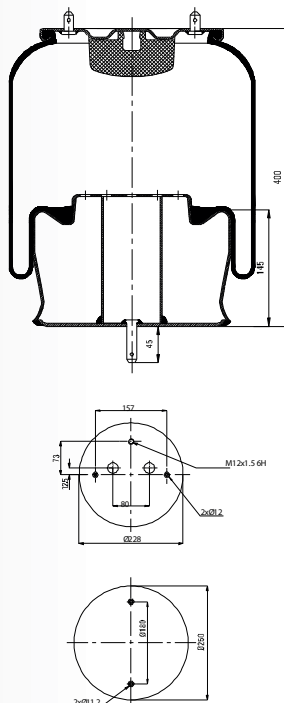

RT1.06251.CP

Cross References

Firestone 1T15LP-3
W01M58 6251

OE Part No

Scania Truck 1314903
Scania Truck 1402423

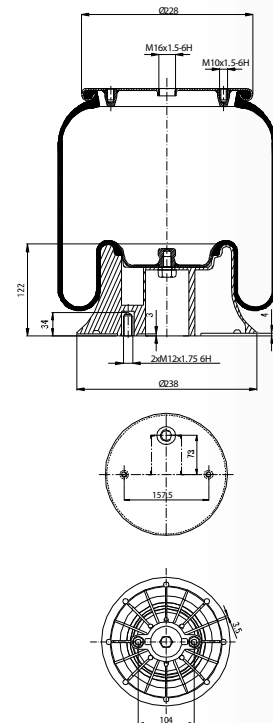

RT1.06253.CP

Cross References

Firestone	1T15LP-3
	W01M58 6253

OE Part No

Granning	15 663
----------	--------

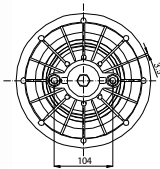
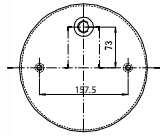
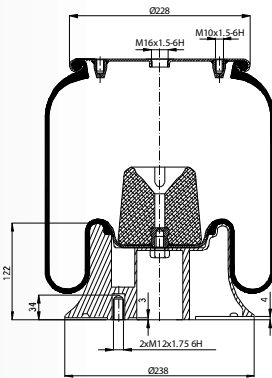

RT1.06260.CP

Cross References

Firestone	1T15MPW-7
	W01M58 6260

OE Part No

Renault	
Hendrickson	59053-2F

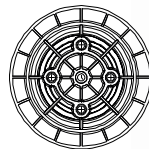
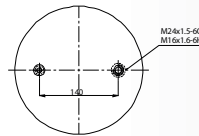
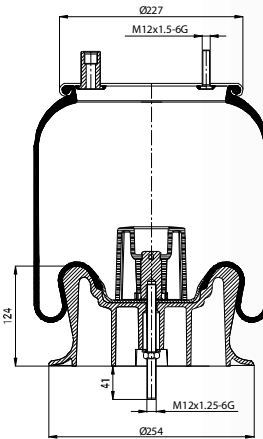

RT1.06318.CP

Cross References

Firestone	1T15MPW-9
	W01M58 6318

OE Part No

Schmitz	016 512
Weweler	US 06318 F

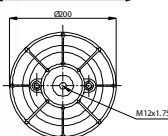
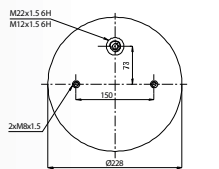
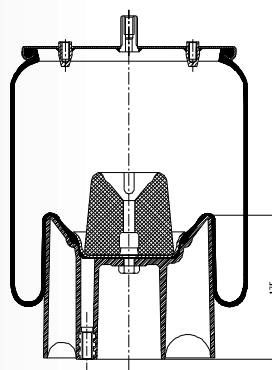

RT1.6416.C

Cross References

Contitech	6608 N P01
Firestone	1T15UR9
	W01M58 8474
Goodyear	1R 10-709
Dunlop	D10B01

OE Part No

Volvo	1076 416
Volvo	20 374 510
Volvo	20 456 152
Volvo	20 531 985
Volvo	20 582 215
Volvo	3 171 693

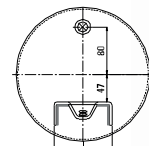
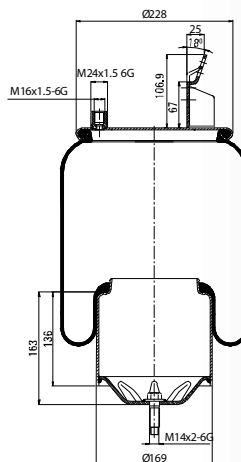

RT1.6418.C

Cross References

Contitech	6607 N P01
Firestone	1T15UR6
	W01M58 8473
Vibracoustic	V1DF16C-1

OE Part No

Volvo	1076 418
Volvo	20 374 511
Volvo	20 456 156
Volvo	20 531 987
Volvo	20 582 214
Volvo	3 171 695

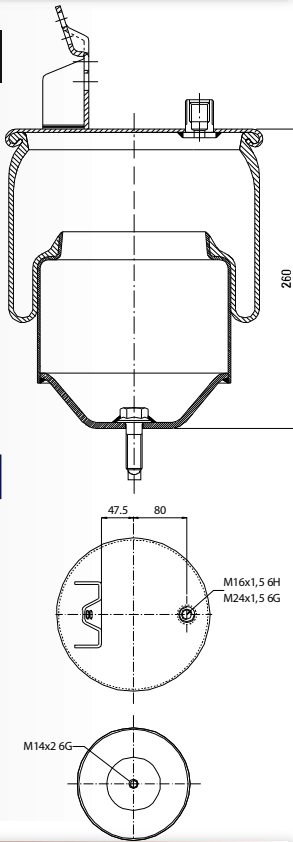

RT1.6420.C

Cross References

Contitech	6420 N
Contitech	82212 M

OE Part No

Volvo	1076 420
Volvo	20 427 802
Volvo	20 456 158
Volvo	20 531 988
	20 582 212

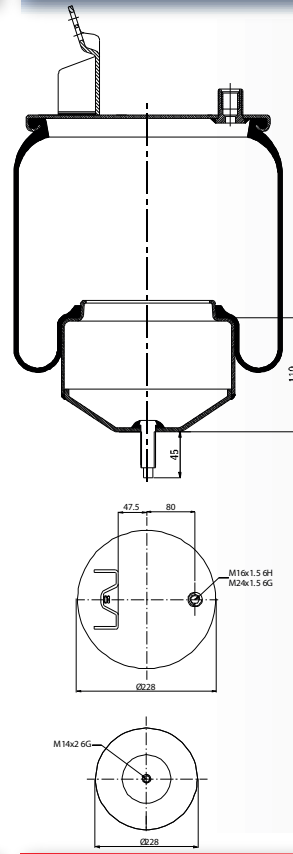

RT1.6602.C

Cross References

Contitech	6602 N P01
-----------	------------

OE Part No

Volvo	20 480 202
Volvo	20 573 113
Volvo	70 313 734

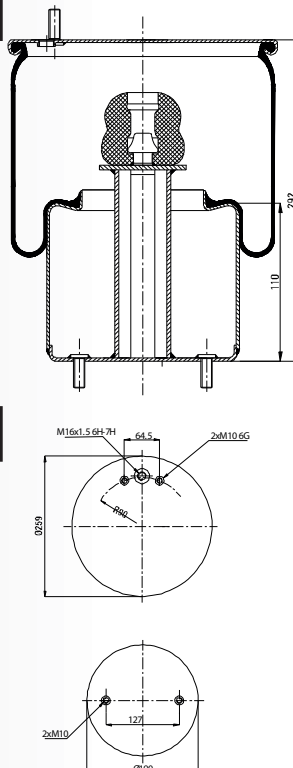

RT1.6603.C

Cross References

Contitech	6603 N P01
-----------	------------

OE Part No

Volvo	20 573 312
-------	------------

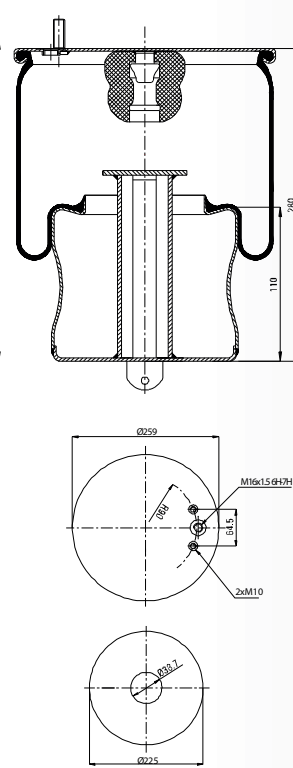

RT1.7805.C

Cross References

Contitech 7802 M

OE Part No

Volvo 20 582 212
 Volvo 20 531 988
 Volvo 20 456 158
 Volvo 20 427 802

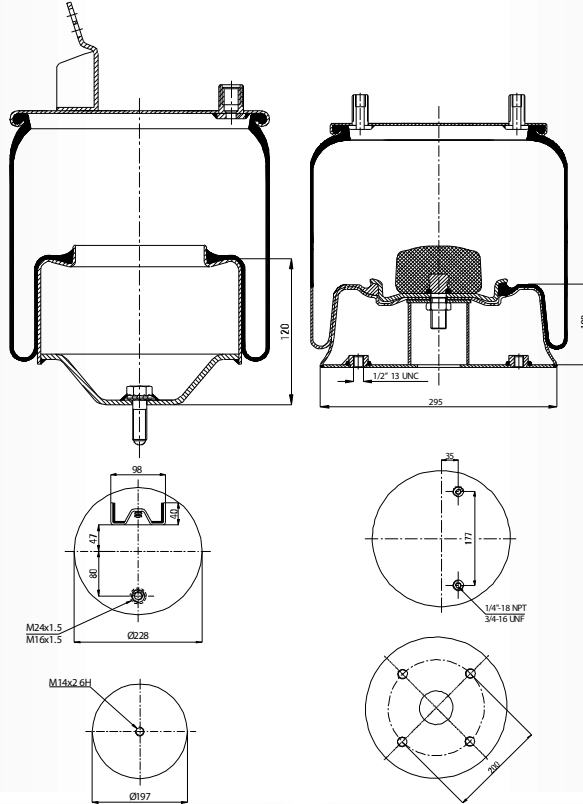

RT1.8050.C

Cross References

Contitech 11 10.5 E-16 A 320
 Firestone 1T192K-5.7
 W01358 8050

OE Part No

Hendrickson Trailer S4771



RT1.08185.CP

Cross References

Firestone 1T15MPW-9
 W01M58 8185

OE Part No

Schmitz 750 999
 Weweler US 06285 F

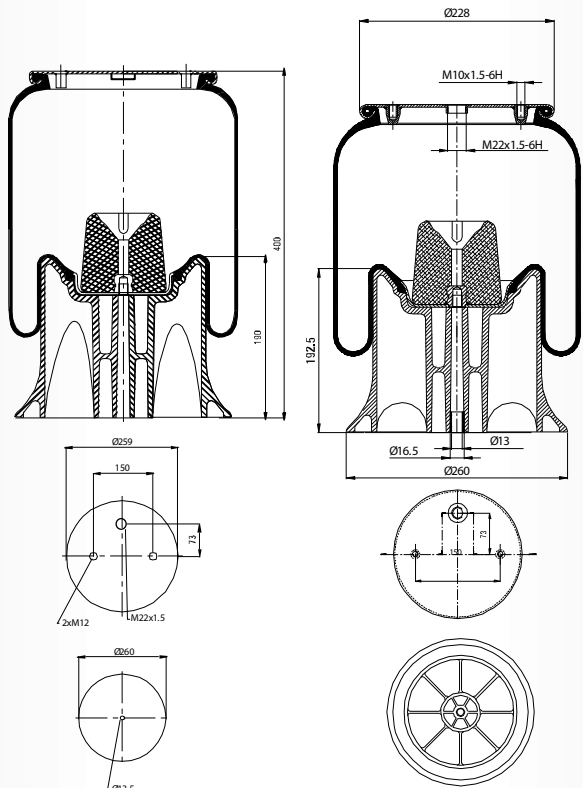

RT1.08186.CP

Cross References

Firestone 1T15MPW-7
 W01M58 8186
 Phoenix 1DK20A1

OE Part No

Weweler US06316F
 Schmitz Trailer 751065



RT1.08608.CP

Cross References

Firestone	1T17DJ-7
	W01M58 8608

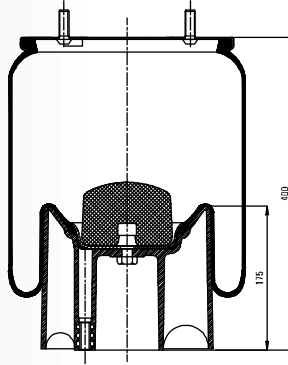

OE Part No

Ror	2122 9214
-----	-----------

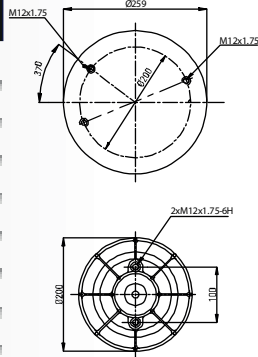

RT1.8753.C

Cross References

Contitech	10 10-15 S 713
Firestone	1T17B-5
	W01 358 8753

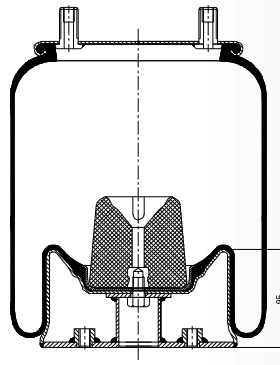

OE Part No

Ridewell	1003588753C
Watson & Chalin	AS-0098
Spring Valley	AS-8713

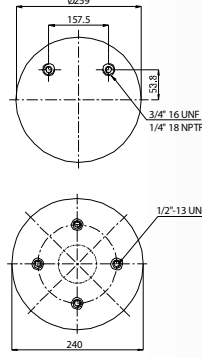

RT1.8762.C

Cross References

Firestone	1T19L-14
	W01M58 8762
Cf Gomma	1T19E-3
Dunlop	D13B04
Good Year	1R13-803
Phoenix	1DK 28 D-3

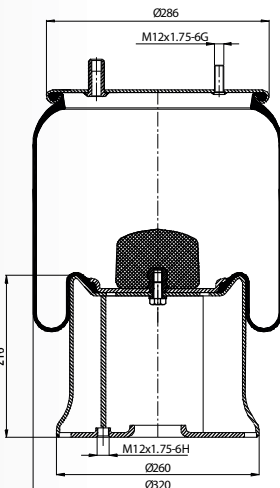

OE Part No

Fruehauf	M001464
Smb	OJB0129001
Zorzi	1006552

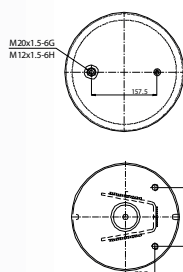

RT1.08829.CP

Cross References

Contitech	9 10-16 P 499
Firestone	1T15M-6
	W01 358 8829
Good Year	1R12-615

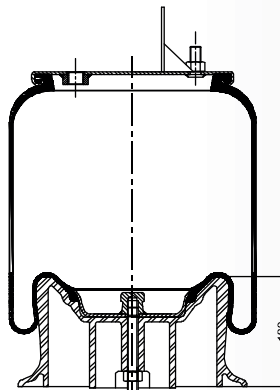

OE Part No

Hendrickson	HA 100016
-------------	-----------

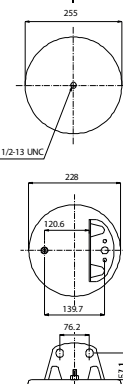

RT1.09002.CPA3

Cross References

Firestone	1T15 MPW-7 W01M58 7074
Cf Gomma	1T300-338 205598
Phoenix	1DK 21A-3

OE Part No

Granning	15732
Ror / Meritor	212 22 442
Weweler	US 07074F

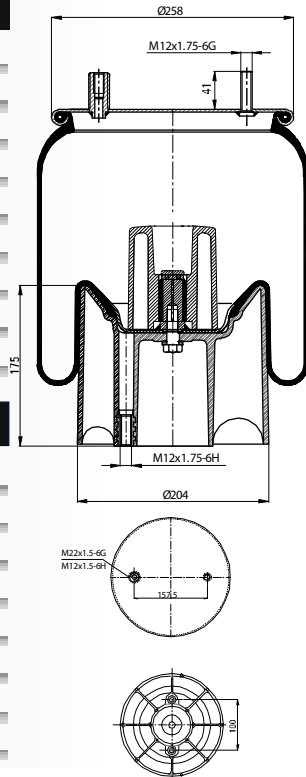

RT1.09002.CPA8

Cross References

Firestone	1T15 MPW-7 W01M58 6297
Goodyear	1R 11-111
Taurus	KR915-54

OE Part No

Mercedes	A 946 328 1401
Discos	A 946 328 1401
Ror / Meritor	212 21307
Weweler	US 87EUROF

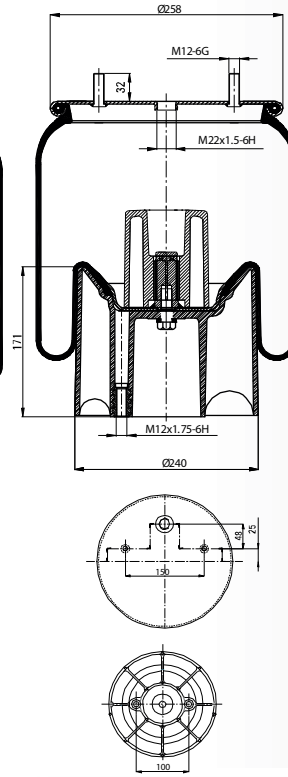

RT1.09069.CP

Cross References

Contitech	9 10-14 P 312
Firestone	1T15M-4 W01358 9069
Goodyear	1R12-069
Taurus	KR504-9069

OE Part No

Foden	1300248000
Peterbilt	03 7112
Netam / Fruehauf	352-9069
Dayton	S13031
Hendrickson	SC2034
Loadguard	03-02456
Peterbilt	03-04759
Watson & Chalin	AS-0077

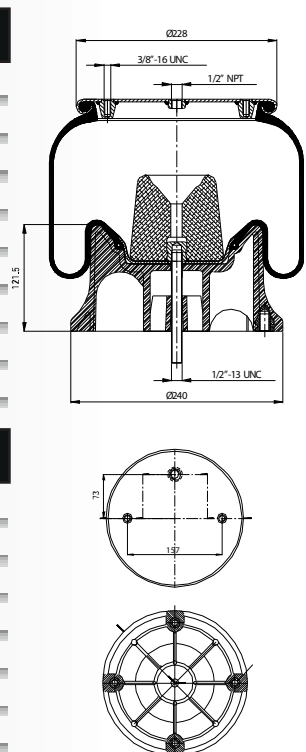

RT1.09070.CP

Cross References

Contitech	9 10-14 A 330
Firestone	1T15M-4 W01358 9070
Taurus	6362
Triangle	8330
Goodyear	1R12-370

OE Part No

Neway	905 57 038
Neway	905 57 090
Silent Drive	AS-9070
Loadguard	SC2775
Watson & Chalin	AS0050
Taurus	AS504-9070

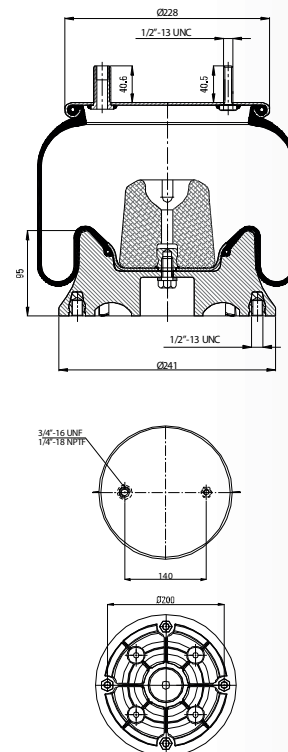

RT1.09084.CP

Cross References

Firestone W01-681-9084

OE Part No

Granning 2692/ 15690

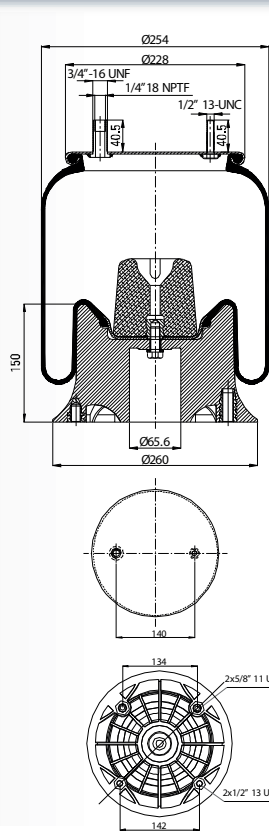

RT1.09122.CP

Cross References

Contitech 4811N03
 Firestone 1T19L-11
 W01358 9122
 Goodyear 1R13-038
 Taurus KR622-9122

OE Part No

Neway 90557 020
 Neway 90557 076
 Neway 90557 077
 Hendrickson S 3830
 Tec 506003

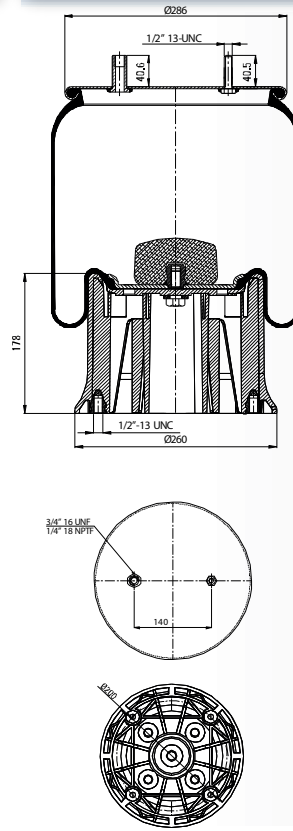

RT1.09156.CP

Cross References

Contitech 11 10.5-21 A 370
 Firestone 1T19L-11
 W01358 9156
 Goodyear 1R14-019
 Triangle 8370

OE Part No

City Welding
 Peerless 0550-00080
 Hendrickson Trailer S 7128

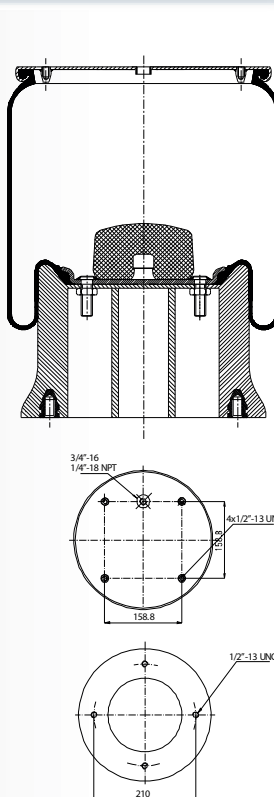

RT1.9265.C

Cross References

Contitech 9 10-19 P 435
 Firestone 1T15MM-9
 W01358 9265
 Goodyear 1R12-375
 Triangle 8435

OE Part No

Hendrickson Trailer S 20124
 Hendrickson Trailer HT-250 T
 Hendrickson Trailer C 20413
 Hendrickson Trailer HT-250 U
 Hendrickson Trailer HT-250 U-Y
 Volvo 85 101155
 Dayton 352-9265
 Ridewell 100 358 9245C

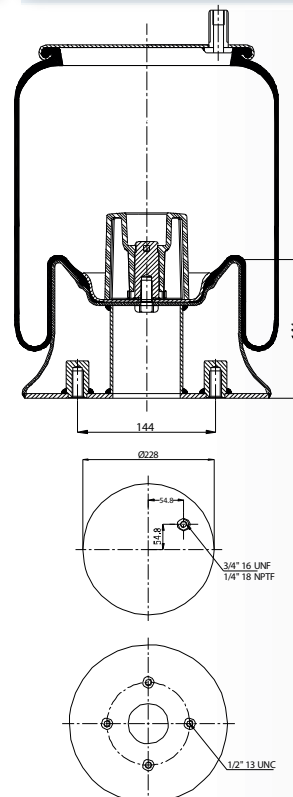

RT1.9270.C

Cross References

Contitech	9 10-13.5 S 433
Firestone	TT15VP-4
	W01358 9270
Goodyear	1R 13-077
Triangle	8433

OE Part No

Hendrickson	C 20010
Hendrickson	C 200108
Hendrickson	C 21208
Hendrickson	C 25559
Triangle	8433
Volvo	85 101 147
Watson & Chalin	AS-0084

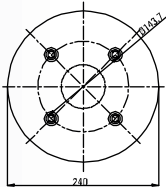
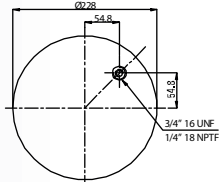
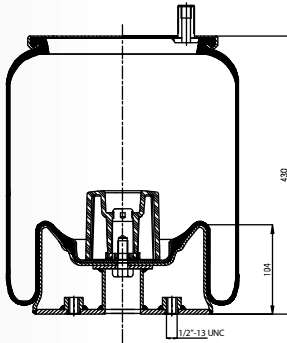

RT1.09270.CP

Cross References

OE Part No

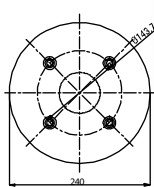
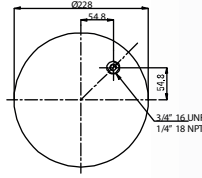
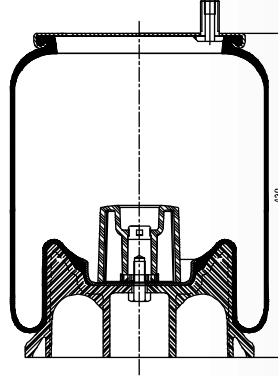

RT1.09320.CP

Cross References

Contitech	9 10-21 P 360
Firestone	TT15M-11
	W01358 9320
Goodyear	1R 12-363
Triangle	8360

OE Part No

Saf Holland (Neway)	90557 099
Silent Drive	AS-9320
Loadguard	SC 2774

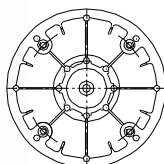
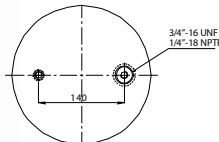
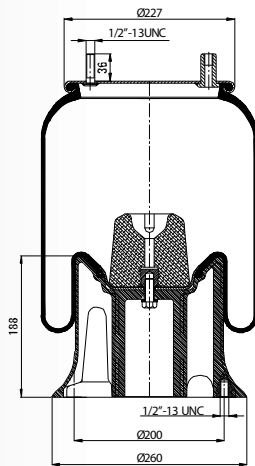

RT1.09335.CP

Cross References

Contitech	9 10-10 P 465
Firestone	TT15M-4
	W01358 9335
Goodyear	1R 12-620
Triangle	8465

OE Part No

Hendrickson	56917-1 & 2
	(Class 6 & 7
	Freightliner) Ref.56916
	(W01-358-9284)
	Superseded

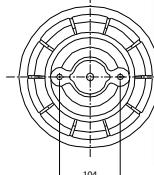
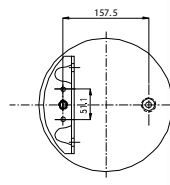
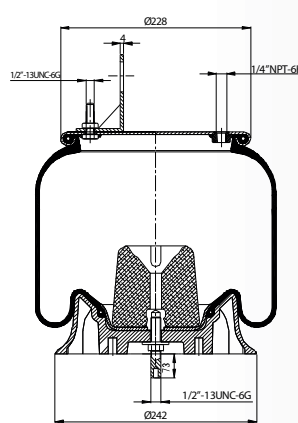

RT1.9367.C

Cross References

Contitech	9 10-21P 505
Firestone	1T15M-11
	W01358 9367
Goodyear	1R12-256
Triangle	8505

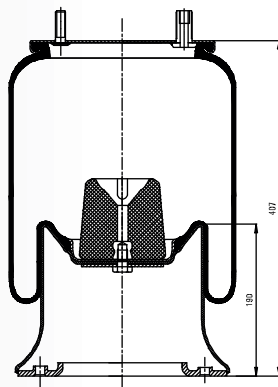

OE Part No

Hendrickson	S 14249
Hendrickson	003319 (METRIC)

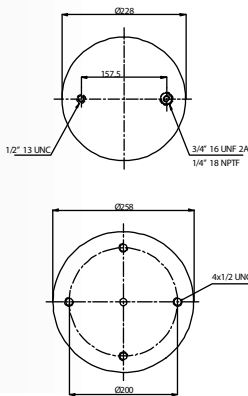

RT1.09373.CP

Cross References

Contitech	9 10-18.5 P 519
Firestone	1T15MT-8
	W01358 9373
Goodyear	1R12-403
Triangle	8519

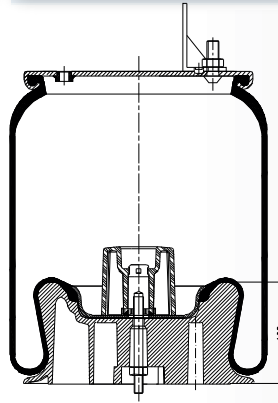

OE Part No

Hendrickson	57122-1
Hendrickson	57122-2

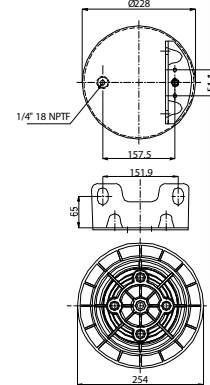

RT1.09375.CP

Cross References

Contitech	9 10.1-75 P 451
Firestone	1T15M-8
	W01358 9375
Goodyear	1R12-404
Goodyear	1R12-488
Triangle	8451

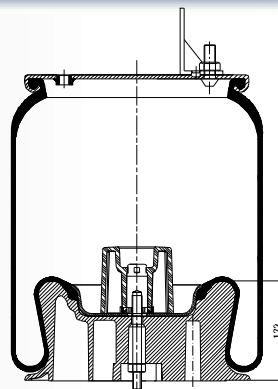

OE Part No

Hendrickson	50899-1
Hendrickson	50899-2
Loadguard	SC2773
Mack	364SQ27
Mack	57QL414M

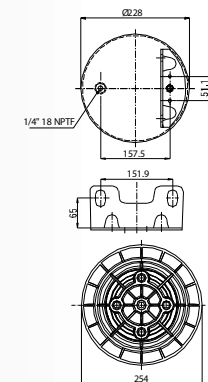

RT1.09463.CP

Cross References

Contitech	9 10-14 A 437
Firestone	1T1M-4
	W01358 9463
Triangle	8437
Taurus	6362

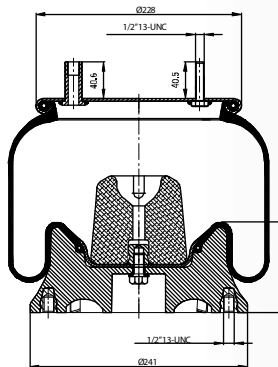

OE Part No

Saf Holland	90557130-RH
Saf Holland	90557131-LH

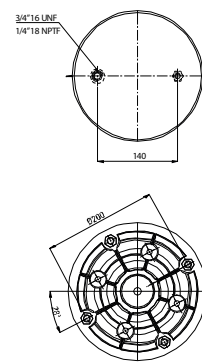

RT1.9579.C

Cross References

Contitech	9 10-13.5 S 881
Firestone	1T15VP-4
	W01358 8800
	W01358 9579
Goodyear	1R 13-119

OE Part No

Hendrickson	S-21208
-------------	---------

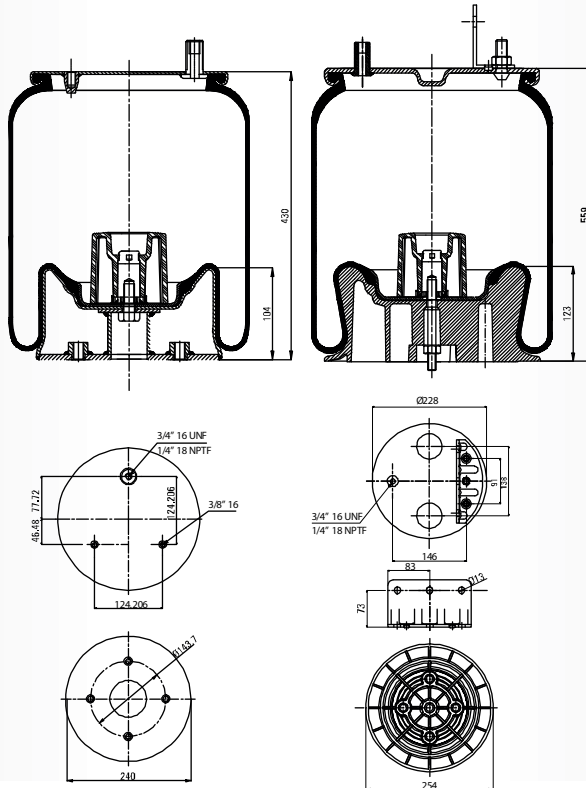

RT1.09648.CP

Cross References

Contitech	9 10-18.5 P 456
Firestone	1T15M-8
	W01358 9648
Taurus	6363
Goodyear	1R 12-398
Triangle	8456

OE Part No

Navistar/Fleetrite	2027911C1
Navistar/Fleetrite	2027911C2
Navistar/Fleetrite	2027911C3

RT1.9780.C

Cross References

Contitech	9 10S-16 P 382
Firestone	1T15ZR6
	W01358 9780
Goodyear	1R 12-303
Triangle	8382P

OE Part No

Freightliner	16-15595-000
Freightliner	16-14004-000
Freightliner	16-13840-000
Freightliner	A16-14004-000
Freightliner	681-320-0017
Freightliner	16-13810-000
Freightliner	16-1673-000
Loadguard	SC2750

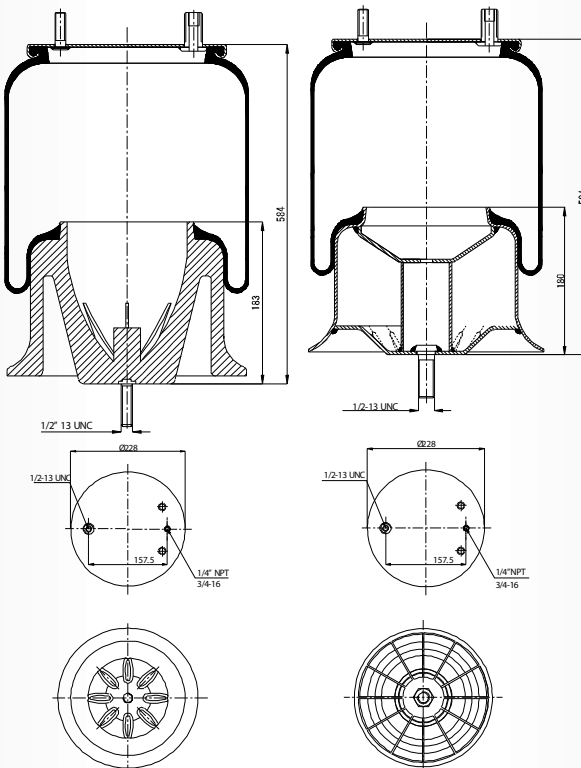

RT1.09780.CP

Cross References

Contitech	9 10 S-16 A 382
Firestone	1T15ZR-6
	W01358 9782

OE Part No

Freightliner	16-16773-000
--------------	--------------

RT1.9935.CP

Cross References

Contitech	9 10-17.5 P 548
Firestone	TT15M-7.5
	W01358 9935
Goodyear	1R 12-532
Taurus	6391
Triangle	8548

OE Part No

Saf Holland	90557157
Saf Holland	90557301

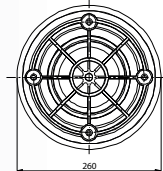
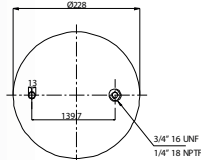
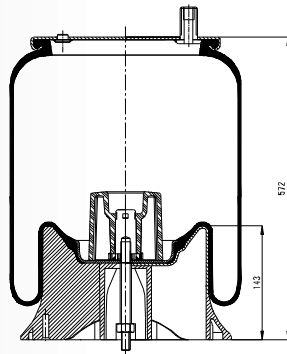

RT1.27023.CP01

Cross References

Cf Gomma	ITS 270 23C 206686
----------	--------------------

OE Part No

Iveco	41270462
-------	----------

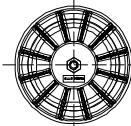
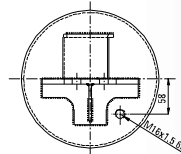
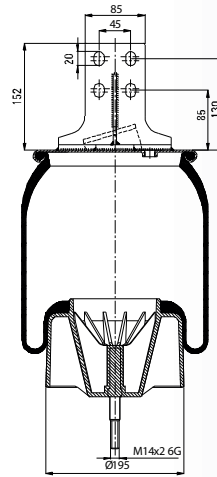

RT1.27023.CP02

Cross References

Cf Gomma	ITS 270 23C 206687
----------	--------------------

OE Part No

Iveco	41270463
-------	----------

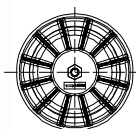
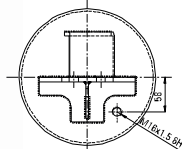
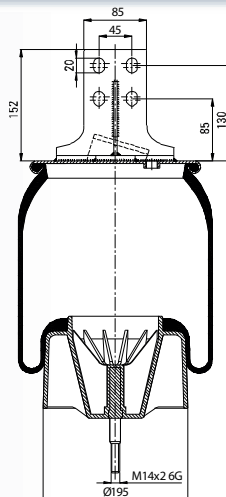

RT1.27023.CP03

Cross References

Cf Gomma	ITS 270 23C 206685
----------	--------------------

OE Part No

Iveco	41270466
-------	----------

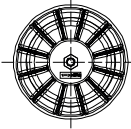
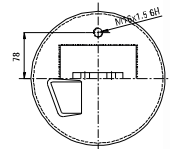
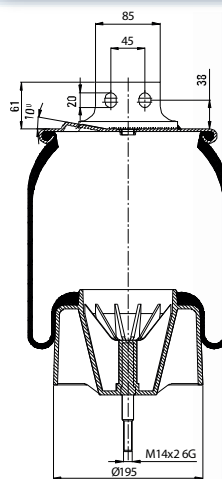

RT1.27023.CP04

Cross References

Cf Gomma 1T5 270 23C 206684

OE Part No

Iveco 41270465

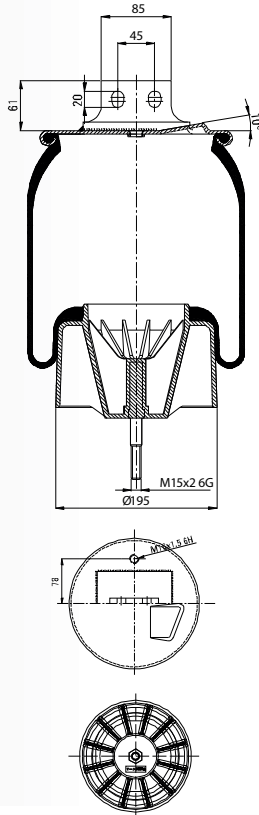

RT1.40301.C

Cross References

Firestone	1T15VR-3
	W01S15 8192
Goodyear	1R 13-746
Phoenix	1DF 23 B-1

OE Part No

Scania - S.Bussar	470920
Scania - S.Bussar	488265
Scania - S.Bussar	1440301

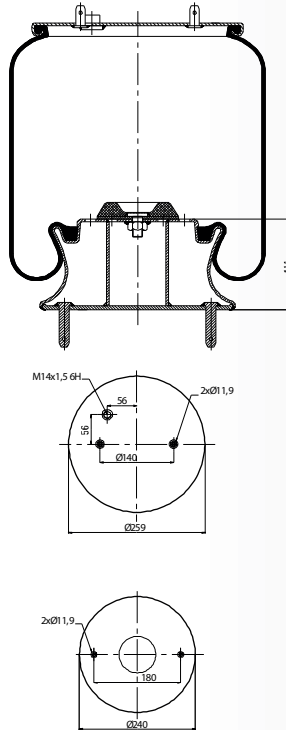

RT1.40301.C03

Cross References

Goodyear 1R 13-750

OE Part No

Scania - S.Bussar 1726237

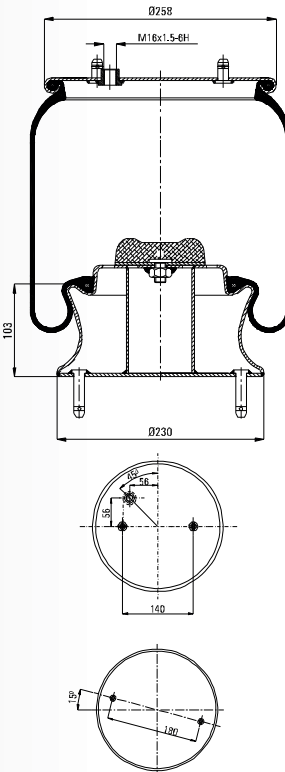

RT1.40302.C

Cross References

Firestone	1T15VPR-3
	W01M58 8193
Goodyear	1R 12-809
Phoenix	1DF 23 A-1

OE Part No

Scania - S.Bussar	1440302
Scania - S.Bussar	470921

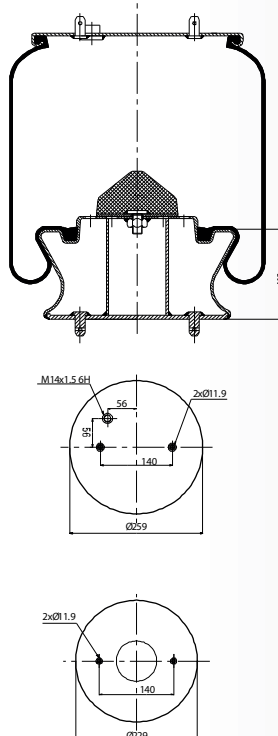

RT1.40304.C01

Cross References

Goodyear 1R 11-834

OE Part No

Scania - S.Bussar 1726240

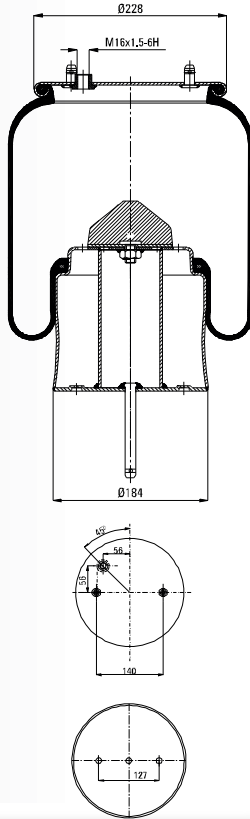

RT1.40305.C

Cross References

Goodyear 1R 11-830
Phoenix 1 DF 20 A-2
Firestone W01095 481

OE Part No

Scania - S.Bussar 1440305

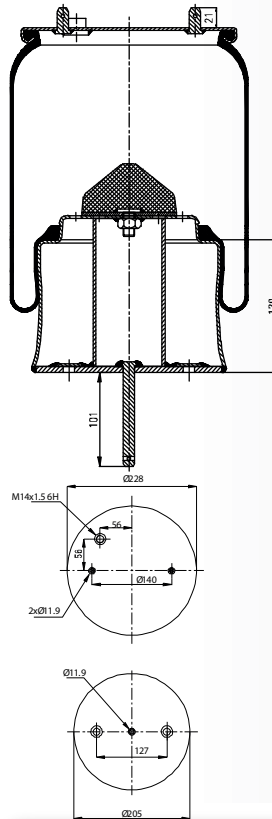

RT1.40305.C01

Cross References

Goodyear 1R 11-840

OE Part No

Scania - S.Bussar 1726241

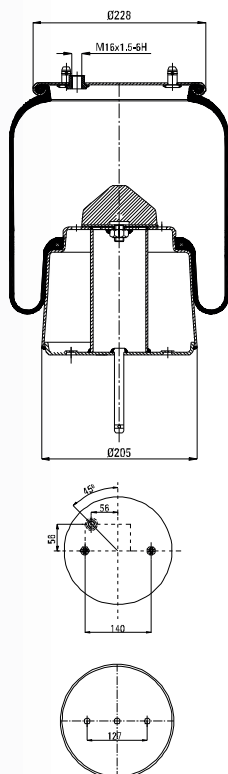

RT1.40306.C

Cross References

Goodyear 1R 11-831
Phoenix 1 DF 20 A-3

OE Part No

Scania - S.Bussar 1440306

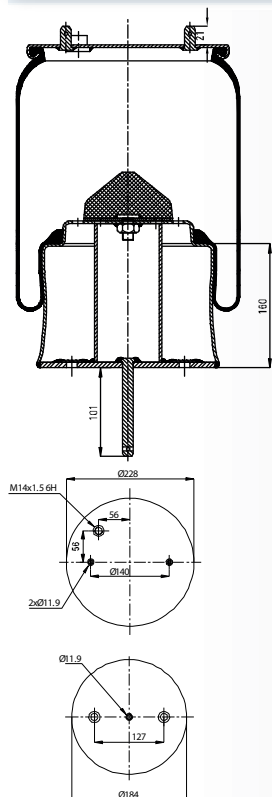

RT1.40306.C01

Cross References

Goodyear 1R 11-839

OE Part No

Scania - S.Bussar 1726242

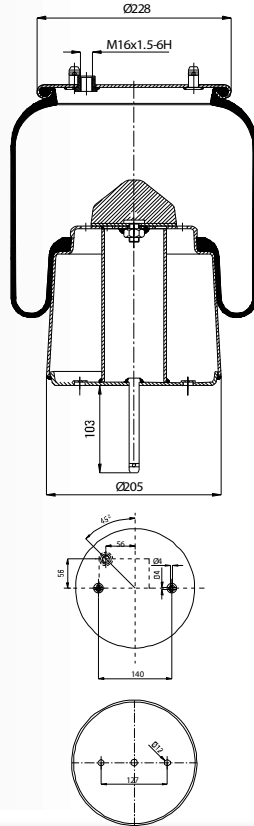

RT1.40307.C

Cross References

Goodyear 1R 11-845
 Phoenix 1 DF 23 B-2
 Firestone 1T 15L-4(3)
 W01-095-0405

OE Part No

Scania - S.Bussar 1440307
 Scania - S.Bussar 1440860
 Scania - S.Bussar 475149
 Scania - S.Bussar 470919

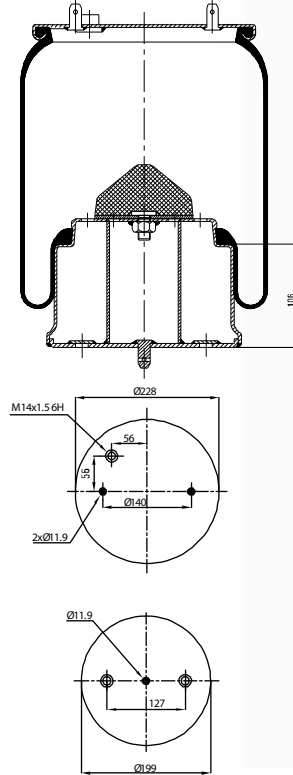

RT1.40307.C01

Cross References

Goodyear 1R 11-841

OE Part No

Scania - S.Bussar 1726246

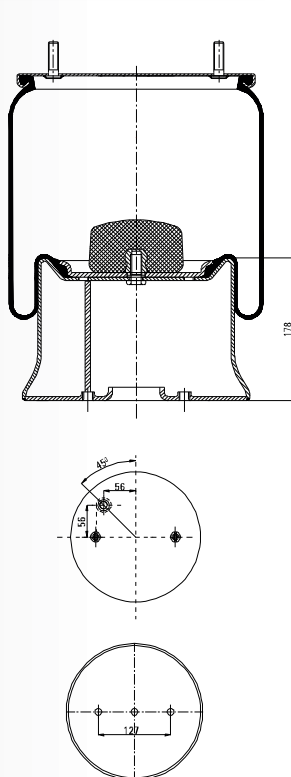

RT1.50700.C

Cross References

Firestone 1T 19L-11
 W01M58 6361
 Dunlop D13B12
 Dunlop D13B18
 Goodyear 1R 14-706
 Phoenix 1 DK 28 B-7

OE Part No

Cardi 58050700
 Bartoletti 91619011
 Omar 11804
 Rolfo 112060
 Viberti 128147102
 Zorzi 1006553

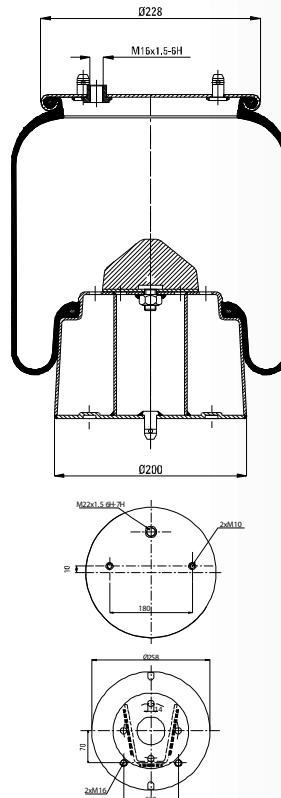

SERVICE ASSEMBLY

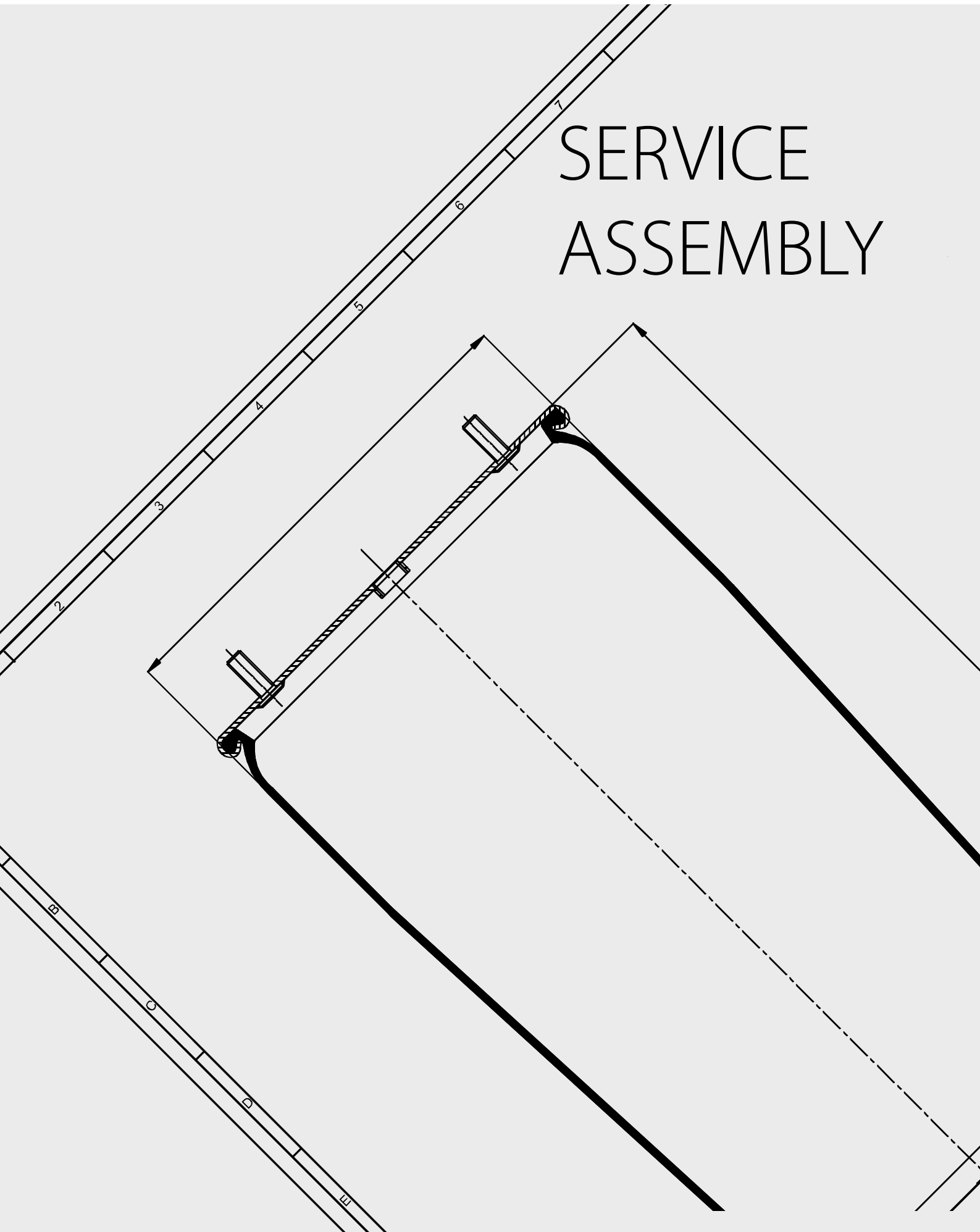

RT1.724.S01

Cross References

Contitech	724 N P01
Good Year	1R11-711



RT1.725.S01

Cross References

Cf Gomma	1TCS 360-45
Contitech	725 N P01
Good Year	1R14-704
Firestone	1T 66F-10.8
Firestone	W01M58 8969
Phoenix	1DF 32
Taurus	UR 836-11
Dunlop	D14 U 38
Cf Gomma	202964

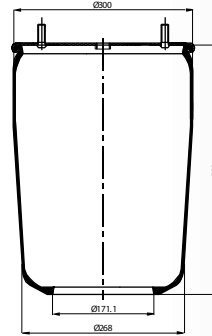

OE Part No

Gigant	246169
Gigant	3053

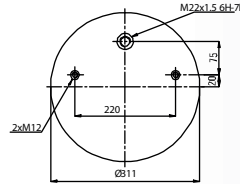
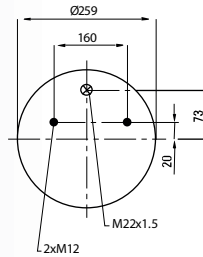

OE Part No

Gigant	246149
Gigant	166217
Gigant	3653

RT1.726.S01

Cross References

Contitech	726 N P01
-----------	-----------

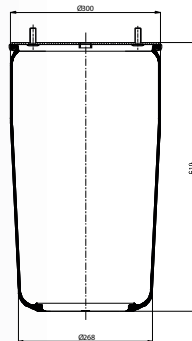

RT1.752.S01

Cross References

Contitech	752 N P01
Vibracoustic	V1DF32-166228

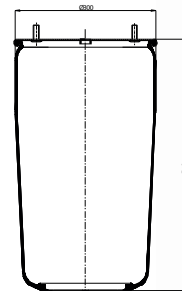

OE Part No

Gigant	246 192
--------	---------

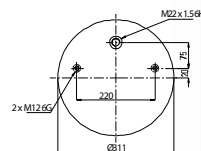
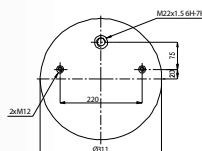

OE Part No

Gigant	247 100
--------	---------

RT1.809.ST

Cross References

Contitech	809 NT
Phoenix	1D23B-2
Cf Gomma	1T320SP
Firestone	1T15L-6
	W01M58 0031

OE Part No

Man	81436010025/50
-----	----------------

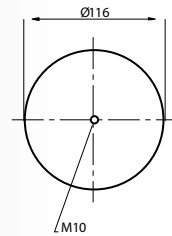
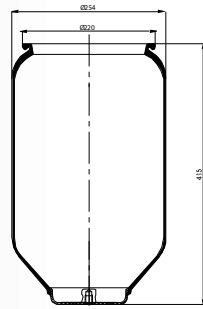

RT1.809.STB

Cross References

Contitech	809 NTB
Firestone	1T15L-6
	W01M58 0687
Goodyear	1R12-709

OE Part No

Pegaso	174932
Man	81436016002

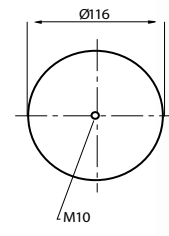
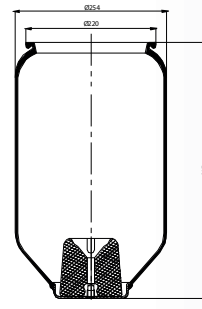

RT1.810.S

Cross References

Contitech	810 MB/0
Firestone	1T19L-7
	W01M58 7237

OE Part No

Ror	./.
Saf Holland	2918

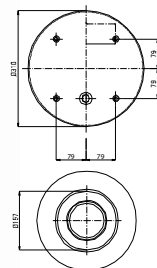
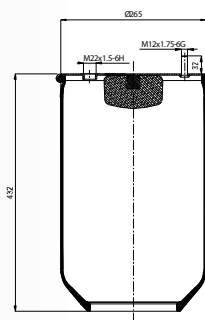

RT1.810.ST

Cross References

Contitech	810 NT
Firestone	1T19L-7
	W01M58 0491

OE Part No

Man	81436010047
-----	-------------

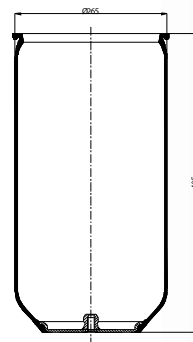

RT1.810.STB

Cross References

Contitech	810 NTB
Firestone	1T19L-7
	W01M58 0749

OE Part No

Man	81436016019
Pegaso	174933

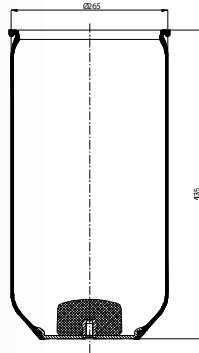

RT1.811.S

Cross References

Cf Gomma	1T 19 E-2
Contitech	811 MB/O
Dunlop	PNP 311670000
Dunlop	SP 2066
Firestone	1T19F-11
Firestone	W01M58 6359
Phoenix	1D 28 B-2
Taurus	K 622-26 SM

OE Part No

Daf	526 823
Daf Bus	0067306
Evom Bus	4731029000

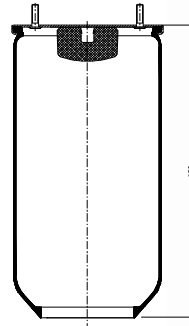

RT1.811.S01

Cross References

Contitech	811M
-----------	------

OE Part No

Daf	0 067 306
Daf	0 676 122
Daf	

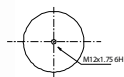
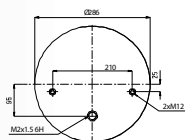
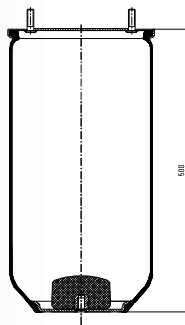

RT1.811.S02

Cross References

OE Part No

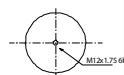
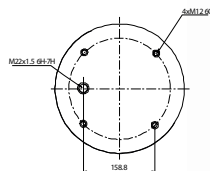
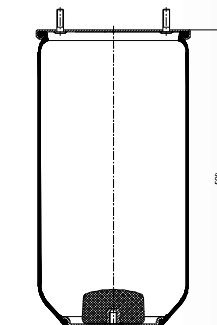

RT1.836.S02

Cross References

Contitech	836 M2
Firestone	1T17AR-4,5
	W01M58 0777
Goodyear	1R 12-710

OE Part No

Daf	0 513 982
-----	-----------

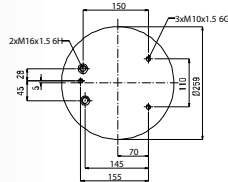
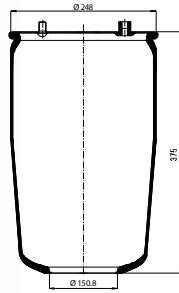

RT1.836.11

Cross References

Contitech	836 N 11
-----------	----------

OE Part No

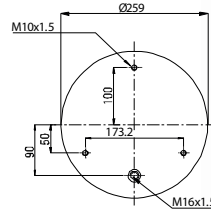
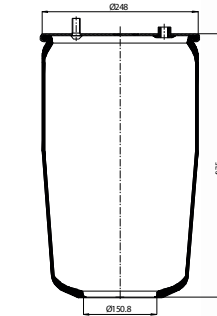

RT1.881.S

Cross References

Contitech	881 MB\0
Firestone	1T66F-10.8
	W01M58 8978
Phoenix	1DK 32-1/36
Goodyear	1R 14-708
Cf Gomma	1TC360-45
Taurus	UR836-01T
Dunlop	D14 U 36

OE Part No

Bpw	05 429 40 010
-----	---------------

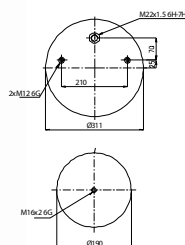
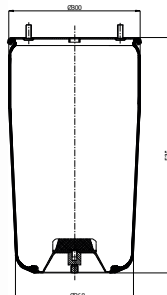

RT1.887.S

Cross References

Contitech	887 M
Firestone	1T15LNR-3
	W01M58 0780
Goodyear	1R11-796
Springride	D11U41

OE Part No

Daf	0 513 983
Vdl Bus	0513 983

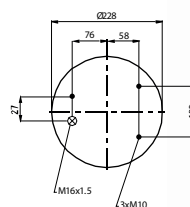
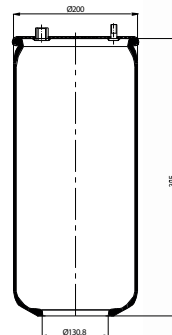

RT1.889.S

Cross References

Contitech 889 M

OE Part No

Daf 1276 846

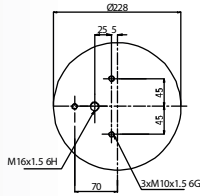
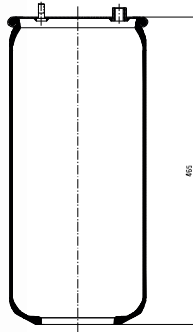

RT1.901.S

Cross References

Contitech 901 MB

OE Part No

Renault 50 10 052 722

Renault 50 10 130 683

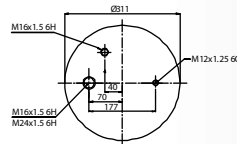
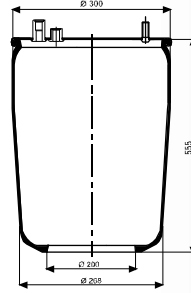

RT1.902.S

Cross References

Contitech 902 MB

OE Part No

Renault 50 10 211 724

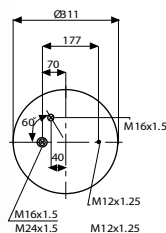
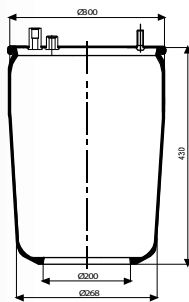

RT1.909.ST

Cross References

Contitech 909 NT

OE Part No

Man 81436010050

Man 81436010054

Man 81436010073

Man 81436016029

Neoplan 102100 500

Neoplan 102121500

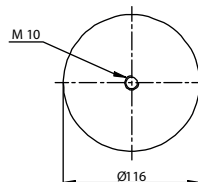
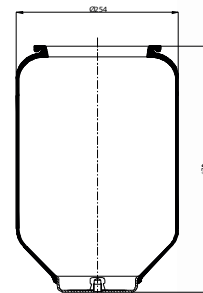

RT1.909.STB

Cross References

Contitech	909 NTB
Firestone	1T15L-6
	W01M58 0687
Goodyear	1R12-709
Phoenix	1D23 C-1
Taurus	B 151
Cf Gomma	1T 320-SP 89753

OE Part No

Breda Menarini	178 739
Man	81436016023

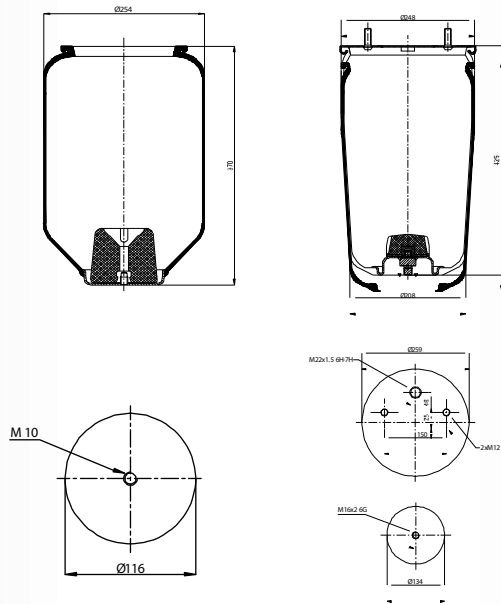

RT1.940.S

Cross References

Contitech	940 MB \0
Firestone	1T17D-4.3
	W01M58 8613
Goodyear	1R11-703
Springride	D11U31
Phoenix	1DK21K
Cf Gomma	1TC 300-30 205536
Taurus	UR 732-01T

OE Part No

Bpw	05.429 40 910
-----	---------------

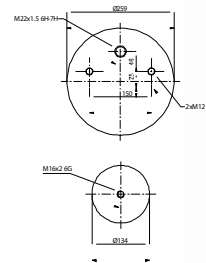

RT1.941.S

Cross References

Contitech	941 MB \0
Firestone	1T17D-8.3
	W01M58 8620
Springride	D11U30
Phoenix	1DK21
Cf Gomma	1TC 300-36 204466
Taurus	UR 730-01T
Goodyear	1R11-700

OE Part No

Bpw	05 429 40 03 0
-----	----------------

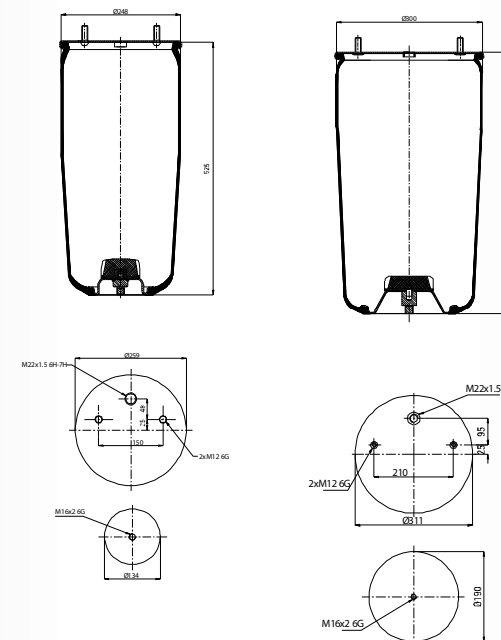

RT1.942.S

Cross References

Contitech	942 MB \0
Firestone	1T66F-13.5
	W01M58 8611
Phoenix	1DK32-1
Taurus	UR 837-01
Goodyear	1R14-700

OE Part No

Bpw	05 429 40 05 0
-----	----------------

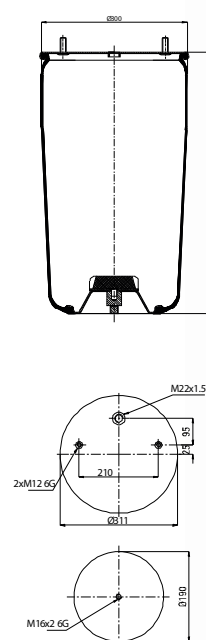

RT1.951.S

Cross References

Contitech 951MB\0

OE Part No

Bpw 05 429 40 72 0

Bpw 05 429 42 72 0

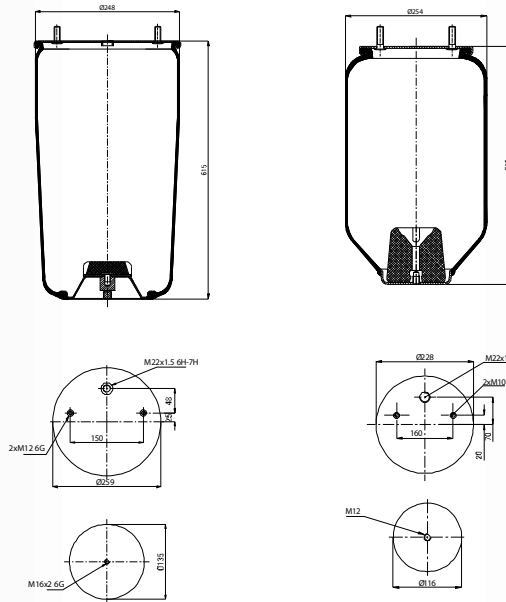

RT1.1210.S

Cross References

Cf Gomma 1T 323-40 96864

OE Part No

Viberti 128 147 109

RT1.04004.02

Cross References

Contitech 4004 N P02

Firestone 1T17BS-6

W01M58 0919

Goodyear 1R 11-705

Springride D12U13

Cf Gomma 1T300-37

Gart D278S 278.4.451

Phoenix 1DK 22 E-8 NP

OE Part No

Saf Holland 4 284 3003 01

2618 AR 416

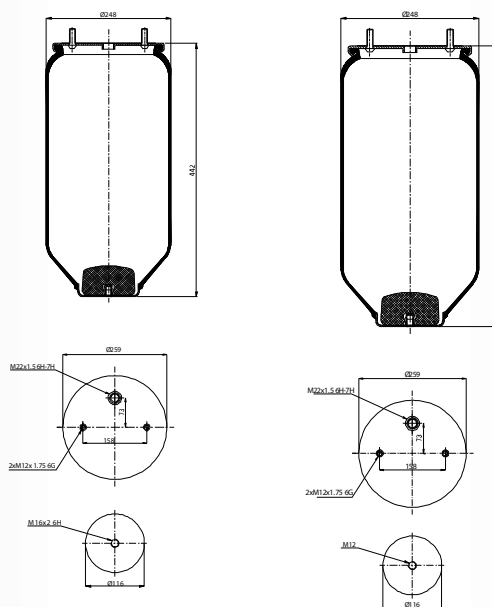

Cross References

OE Part No

RT1.4022.S02

Cross References

Contitech	4022 NP02
Firestone	1T17BS-6
	W01M58 0756
Goodyear	1R 11-709
Springride	D11U40
Gart	D278S 278.0.452
Phoenix	1DK 22 E-9 NP
Vibracoustic	V1DK22E-9 NP

OE Part No

Saf Holland	4 284 3006 00
	2618 V P02
	2619 V P02

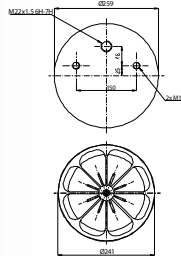
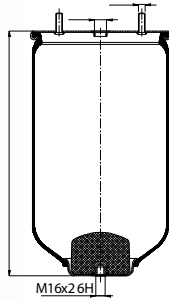

RT1.04022.05

Cross References

Contitech	4022 NP05
-----------	-----------

OE Part No

Saf Holland	4 284 3006 00
	2618 V P02
	2619 V P02

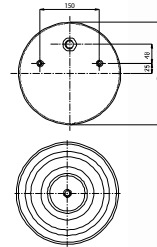
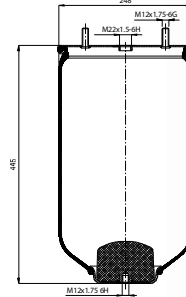

RT1.4023.S

Cross References

Contitech	4023 N/0
Firestone	1T19L-11
	W01M58 6335
Phoenix	1D28 B-10 NP

OE Part No

Inbus	484 0005
Inbus	489 0001
Iveco	471 4025
Bus	472 2525
Iveco	525 4025
Bus	665 7150
Iveco	700 176
Bus	523 229

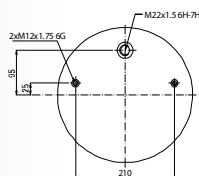
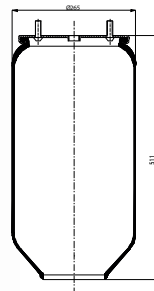

RT1.4028.S

Cross References

Contitech	4028 N
-----------	--------

OE Part No

Schmitz	015 323
Weweler	US 04028

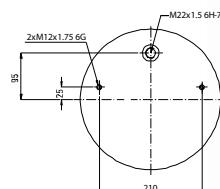
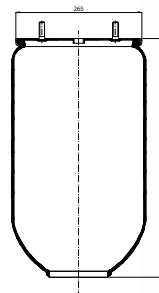

RT1.04154.01

Cross References

Contitech 4154 N P01

OE Part No

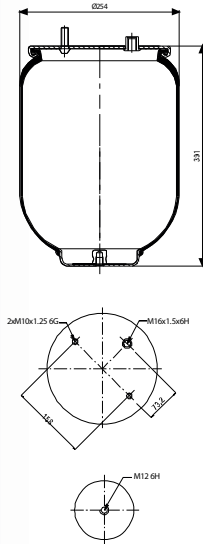

RT1.04156.01

Cross References

Contitech 4156 N P01

OE Part No

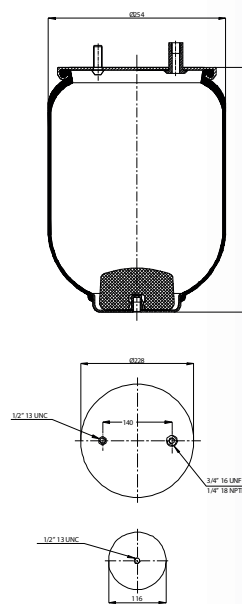

RT1.04156.05

Cross References

Contitech 4156 N P05

OE Part No

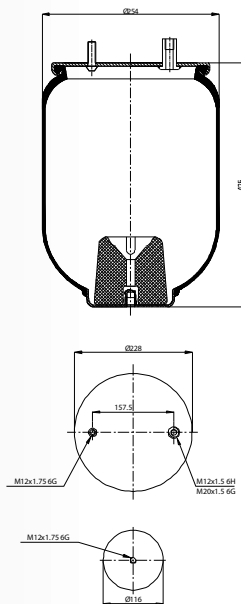

RT1.04156.06

Cross References

Contitech 4156 N P06

OE Part No

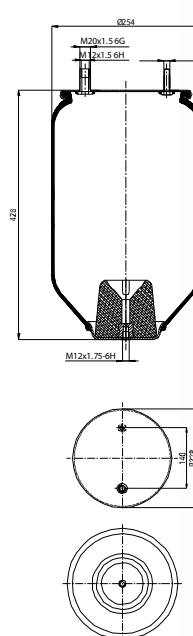

RT1.04156.12

Cross References

Contitech 4156 N P12

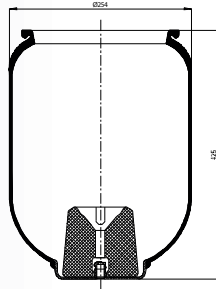

RT1.4157.S

Cross References

Contitech 4156 N\0

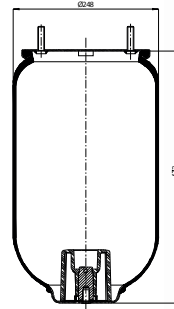

OE Part No

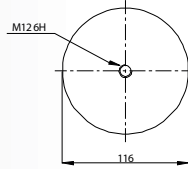

OE Part No

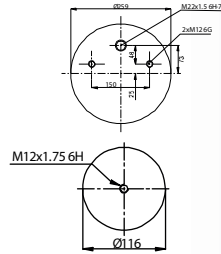

RT1.04157.01

Cross References

Contitech 4156 N P01

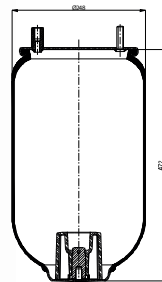

RT1.04158.02

Cross References

Contitech 4158 N P02

Firestone 1T15MPW-9

W01M58 6257

Goodyear 1R 12-748

Dunlop D12B23

Phoenix 1DK 20 B-1NP

OE Part No

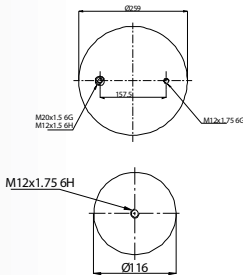

OE Part No

Schmitz 750 999

Weweler US 06285

Weweler US 06287

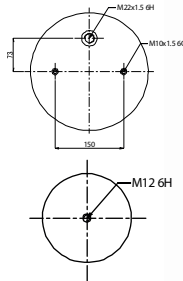
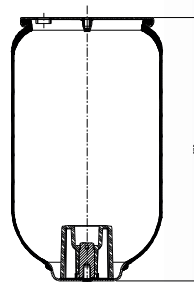

RT1.04159.01

Cross References

Cf Gomma	1T 323-40
Contitech	4159 N P01
Good Year	1R 12-113

OE Part No

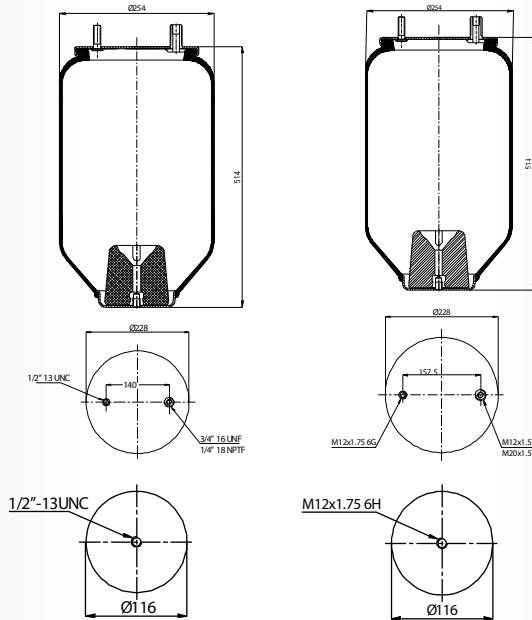

RT1.04159.05

Cross References

Contitech	4159 N P05
Cf Gomma	1T 323-40
Dunlop	D12U04
Firestone	1T15M-9
Firestone	W01M58 0736
Good Year	1R 12-761
Phoenix	1DK 21B-5 NP

OE Part No

RT1.04159.10

Cross References

Contitech	4159 N P10
-----------	------------

OE Part No

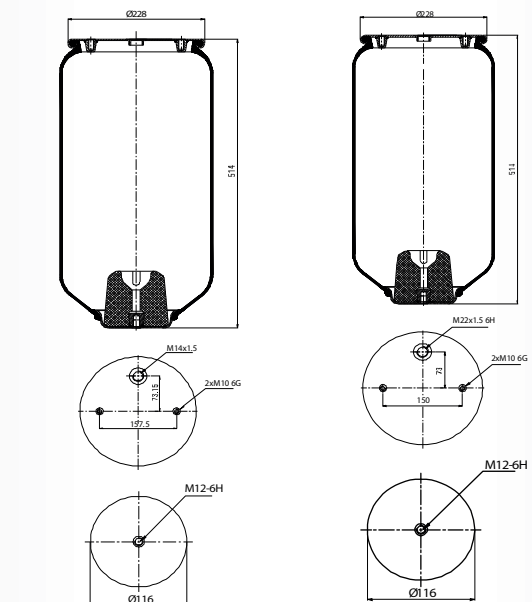

RT1.04159.11

Cross References

Contitech	4159 N P11
-----------	------------

OE Part No

RT1.04159.12

Cross References

Contitech 4159 NP12

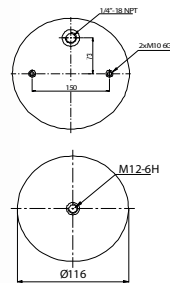
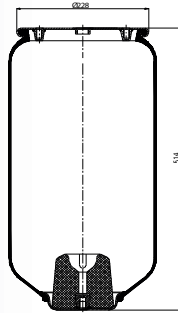

RT1.04183.01

Cross References

Contitech 4183 N1

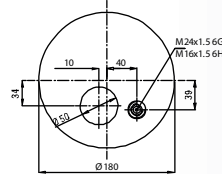
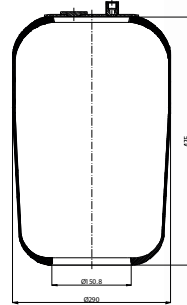

OE Part No

Mercedes

RT1.04183.02

Cross References

Contitech 4183 N2

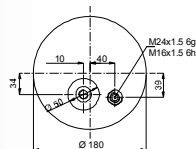
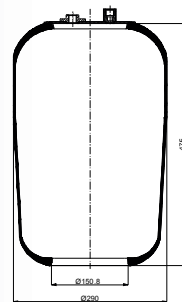

RT1.04390.01

Cross References

Contitech 4390 N1

Goodyear 9507

Dunlop D12U25

Phoenix 1KF 21-1NP

Cf Gomma TVSC285-30 206782

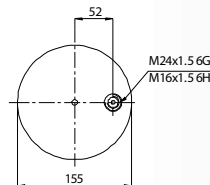
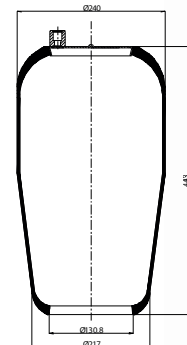

OE Part No

Mercedes A 942 328 0001

RT1.04390.02

Cross References

Contitech	4390 N2
Goodyear	9508
Dunlop	D12U26
Phoenix	1KF 21-2 NP
Cf Gomma	1VSC285-30 206784

OE Part No

Mercedes	A 942 328 0101
----------	----------------

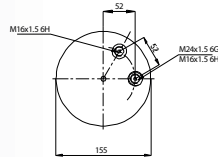
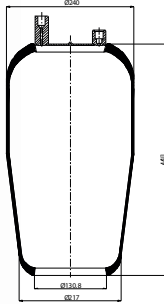

RT1.04391.01

Cross References

Contitech	4391N1
-----------	--------

OE Part No

Mercedes	A 942 328 0601
----------	----------------

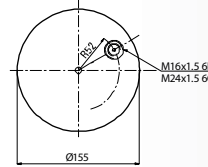
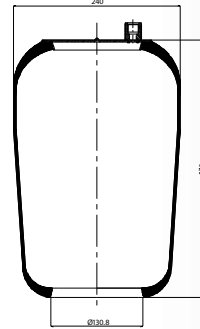

RT1.04391.02

Cross References

Contitech	4391N2
-----------	--------

OE Part No

Mercedes	A 942 328 0701
----------	----------------

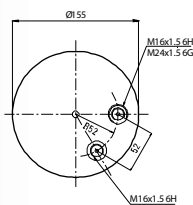
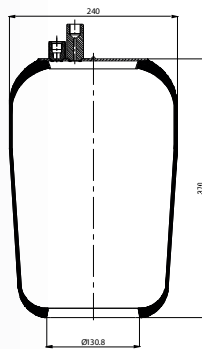

RT1.4420.S

Cross References

Contitech	4420 N
-----------	--------

OE Part No

Fruehauf	431487
Volvo	1076 076

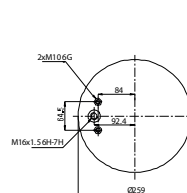
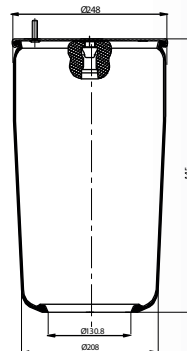

RT1.4506.S

Cross References

Good Year	1R11- 832
Good Year	1R11- 838

OE Part No

Scania - S Bussar	143 4506
Scania - S Bussar	47 3868
Scania - S Bussar	488 269
Scania - S Bussar	172 6243

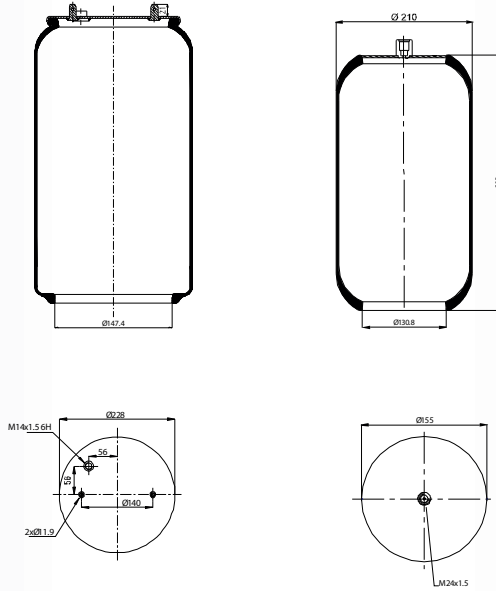

RT1.4644.S

Cross References

Contitech	4644 N
-----------	--------

OE Part No

Evo Bus	A 629 327 00 01
---------	-----------------

RT1.4705.S01

Cross References

Contitech	4705 N1P01
-----------	------------

OE Part No

Man	81436010155
-----	-------------

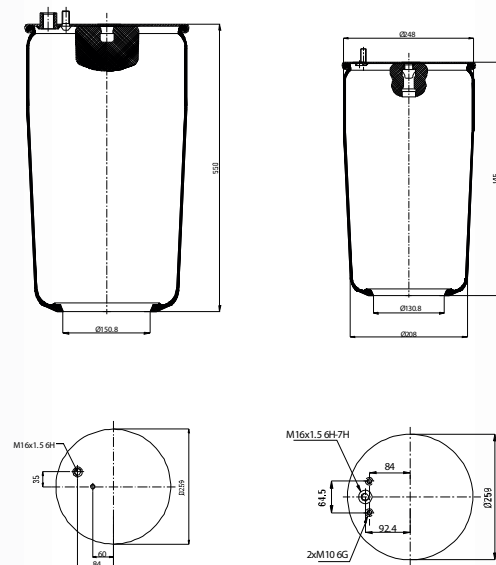

RT1.4713.S

Cross References

Contitech	4713 N P04
Goodyear	1R 12-763

OE Part No

Volvo	1076 595
-------	----------

RT1.4718.S

Cross References

Contitech 4718 N P02

OE Part No

Volvo 1079 718

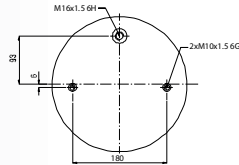
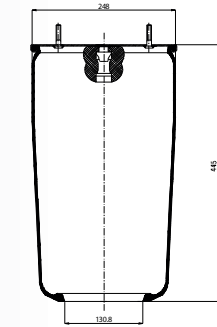

RT1.4725.S

Cross References

Contitech 4725 N P01

OE Part No

Gigant 247 103

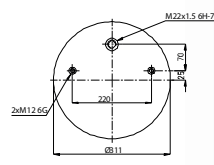
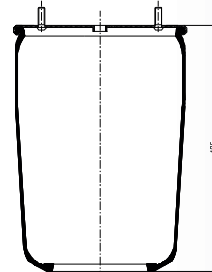

RT1.04737.01

Cross References

Contitech 4737 N

OE Part No

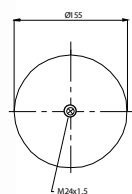
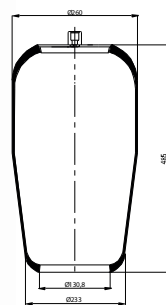

RT1.04757.01

Cross References

Contitech 4757 N1

OE Part No

Mercedes A 942 327 0001

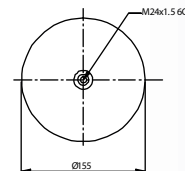
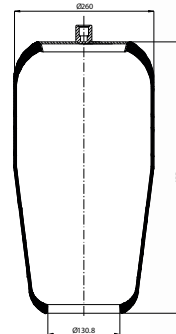

RT1.04757.02

Cross References

Contitech 4757N2

OE Part No

Mercedes A 974 328 0001

Mercedes A 974 328 0101

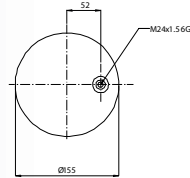
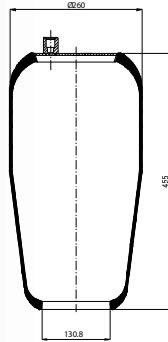

RT1.04758.01

Cross References

Contitech 4758 N

OE Part No

Mercedes A954 320 0017

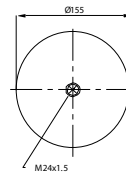
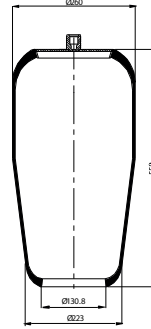

RT1.4810.S

Cross References

Contitech 4810 N\0

OE Part No

Saf Holland

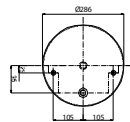
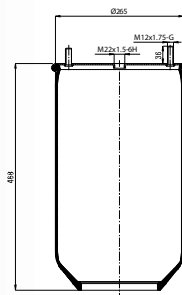

RT1.4813.S

Cross References

Contitech 4813 N\0

OE Part No

Scania

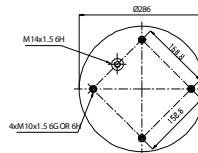
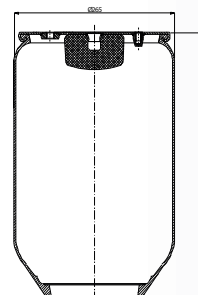

RT1.04838.01

Cross References

Contitech 4838 N1

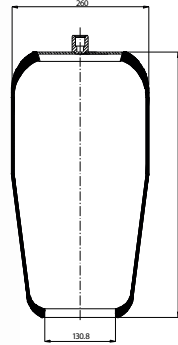

RT1.04881.02

Cross References

Contitech 4881N P02

Firestone TT66F-70

W01M58 8601

Phoenix 1DK 32 K

Dunlop D14U37

Goodyear 1R14-701

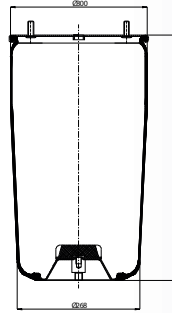

OE Part No

Mercedes A 942 328 0101

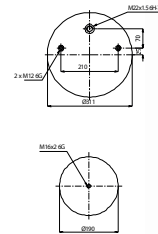
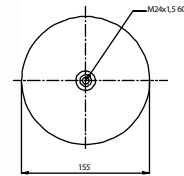

OE Part No

Bpw 05 429 41010

Schmitz 750 570

RT1.04883.02

Cross References

Contitech 4883 N1P01

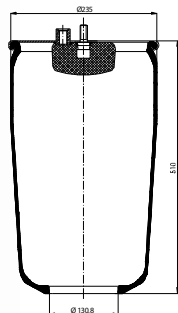

RT1.04884.01

Cross References

Contitech 4884 N1P01

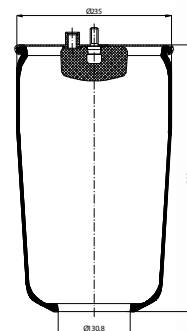

OE Part No

Man 81436010153

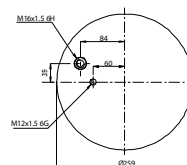
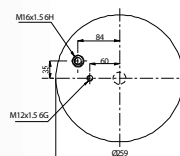

OE Part No

Man 81436010152

Man 81436010174

RT1.04885.01

Cross References

Contitech 4885 N1P01

OE Part No

Man 81436010160

Man 81436016071

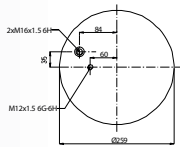
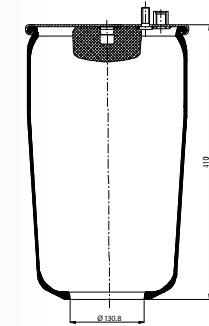

RT1.04886.01

Cross References

Contitech 4886 N P01

OE Part No

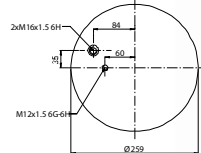
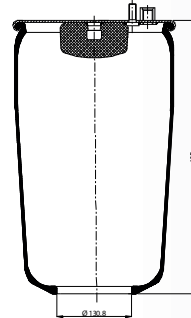

RT1.04911.02

Cross References

Contitech 4911 N P02

Goodyear 1R 13-715

OE Part No

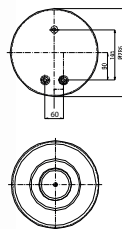
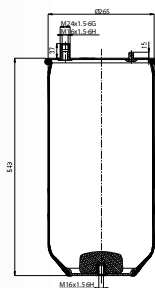

RT1.04912.08

Cross References

Contitech 4912 N P08

Goodyear 1R 13-713

Springride D13U40

Cf Gomma 1T19F-4 206780

OE Part No

Renault 5001832 067

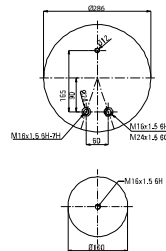
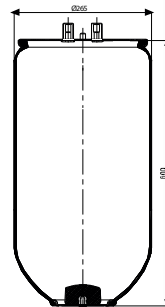

RT1.04912.10

Cross References

Contitech 4912 N P10

OE Part No

Renault

Volvo

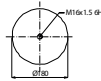
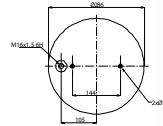
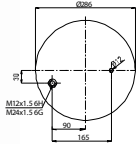
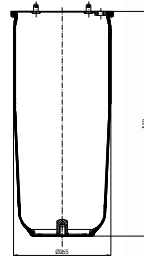
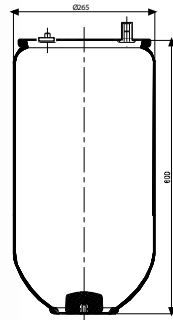

RT1.04913.04

Cross References

Contitech 4913 N P04

Firestone 1T19L-14

W01095 0365

Goodyear 1R14-755

Phoenix 1D28 H-16 NP

Dunlop 1D14U42

OE Part No

Scania 1379393

RT1.04913.10

Cross References

OE Part No

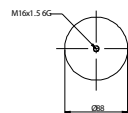
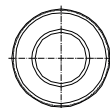
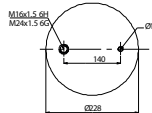
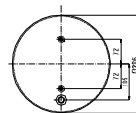
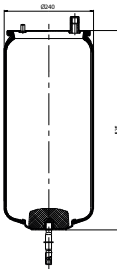
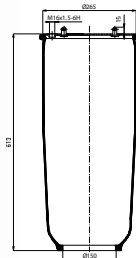

RT1.04915.03

Cross References

Contitech 4915 N P03

OE Part No

Renault 5001855 856

RT1.04961.02

Cross References

Contitech 4961N P02

OE Part No

Bpw 05 429 42 03 0

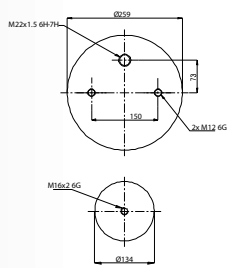
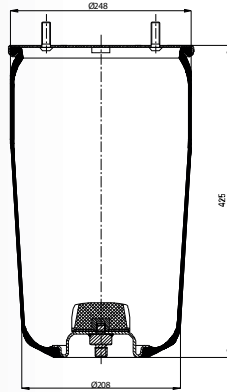

RT1.04962.02

Cross References

Contitech 4962 N P02

OE Part No

Bpw 05 429 42 03 0

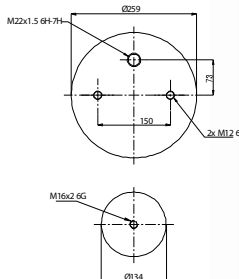
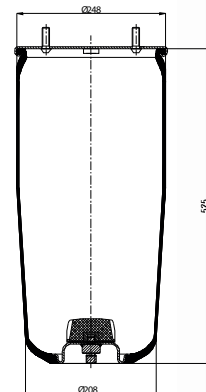

RT1.6050.S

Cross References

Phoenix 1DK 32 E-4

Cf Gomma TTC 360-50

OE Part No

Kassbohrer 4.731.043.000

4.731.043.100.13

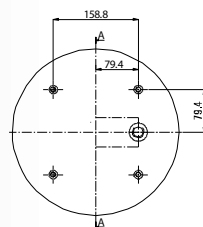
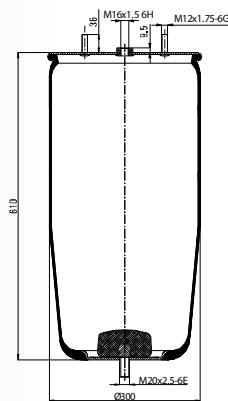

RT1.6055.S

Cross References

Cf Gomma TTC 360-55

OE Part No

Kassbohrer 4.731.044.100

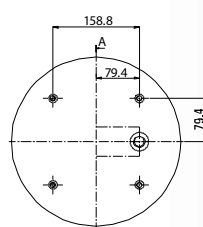
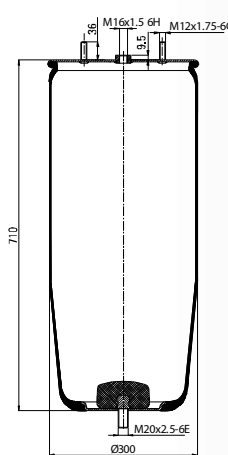

RT1.6199.S

Cross References

OE Part No

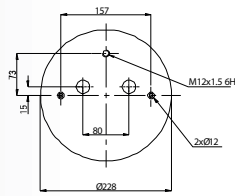
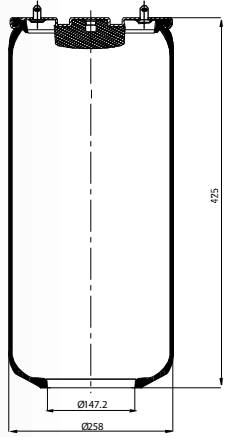

RT1.6200.S

Cross References

OE Part No

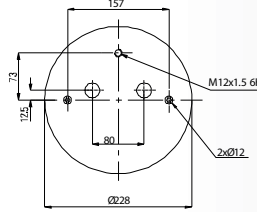
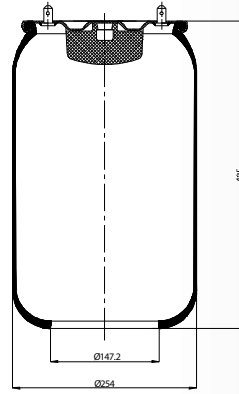

RT1.6318.S

Cross References

OE Part No

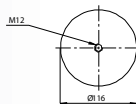
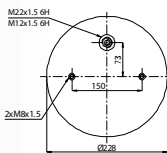
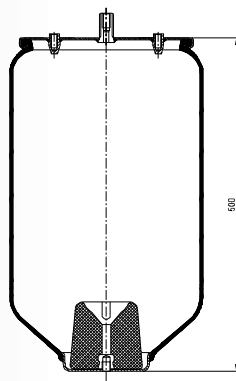

RT1.6416.S

Cross References

OE Part No

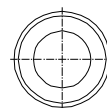
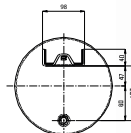
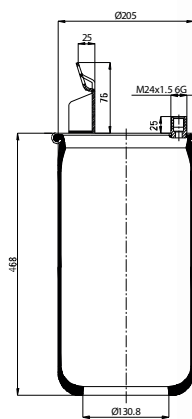

CABIN AIR SPRINGS

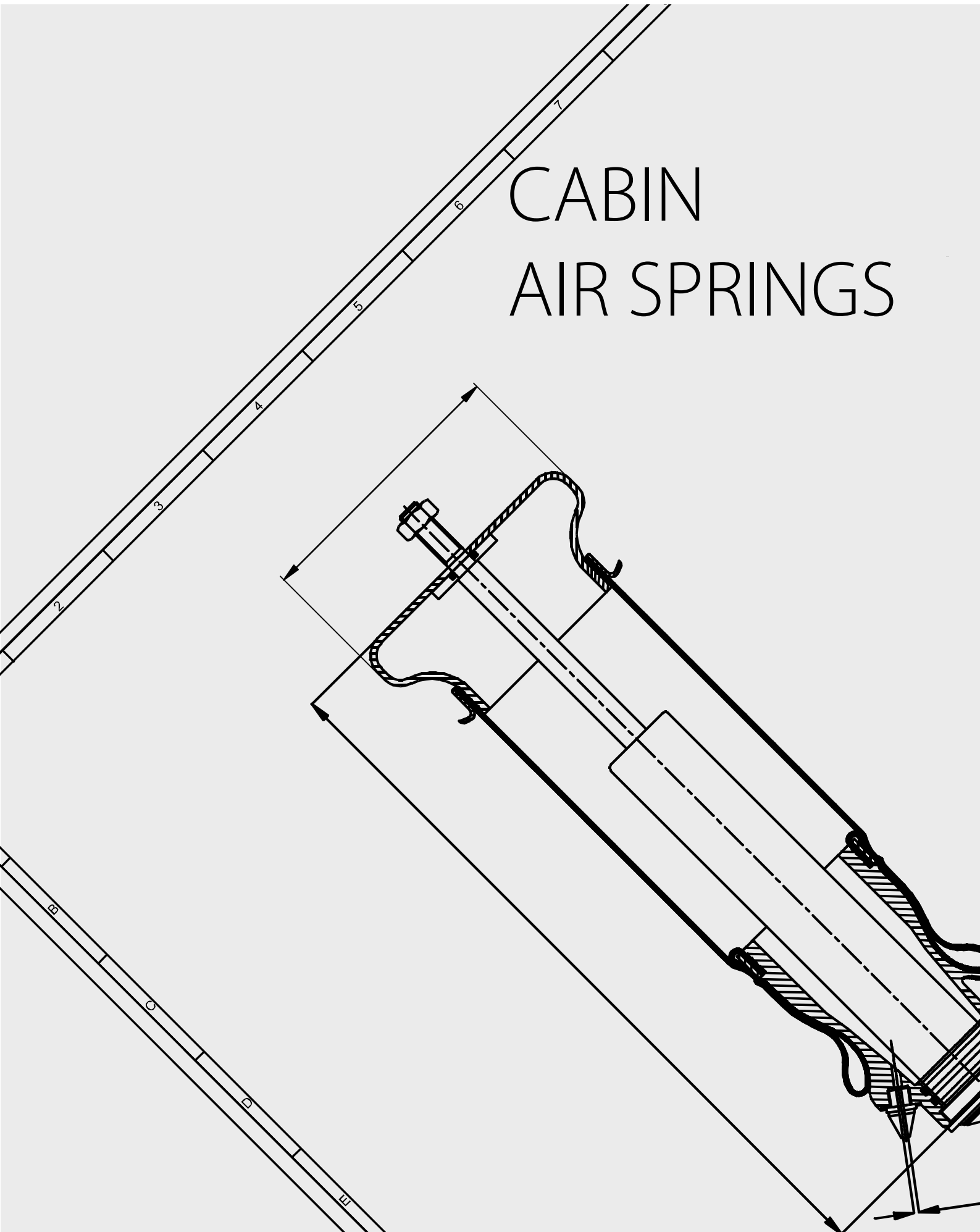

RT2.161101.B0

Cross References

Sachs	481002
Monroe	CB0066

OE Part No

Scania
93- 113- 143- T 113- T 143
1314278

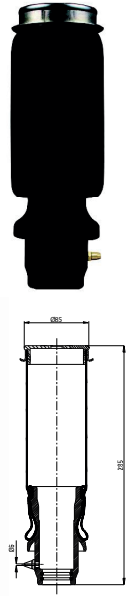

RT2.161101.BS

Cross References

Sachs	112320
Sachs	105845
Sachs	105831
Sachs	105876
Sachs	105875
Monroe	CB0065 / CB0066

OE Part No

Scania
93- 113- 143- T 113- T 143
1331621-1331635
393257, 393208, 393290
1117320-1117334
1331634
370227, 370228
1331620-1116535



RT2.161201.B0

Cross References

Monroe	717262725
Monroe	CB0030

OE Part No

Scania
P & R Serie, 4 Serie
1381919
1476415

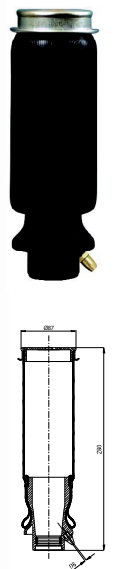

RT2.161201.OA

Cross References

Monroe	CB0010 + CB0030
--------	-----------------

OE Part No

Scania
P & R Serie, 4 Serie
1381903
1381904 / 1381919
1381904 / 1476415
1397395
1397399
1397400 / 1381919

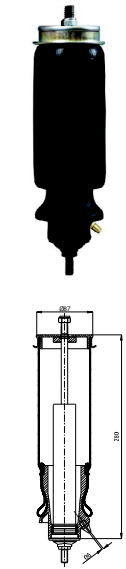

RT2.161201.AA

Cross References

Monroe CB0009 + CB0030

OE Part No

Scania

P & R Serie, 4 Serie

1381905

1381906 / 1381919

1381906 / 1476415

1397393

1397397

1397398 / 1381919

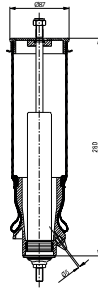

RT2.161202.B0

Cross References

Sachs 557001

Monroe CB0067

OE Part No

Scania 1622116

4 Serie 6797169

94-114-124-144-164

1349840

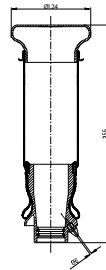

RT2.161202.OA

Cross References

Sachs 105871

Sachs 105872

Sachs 290201

Sachs 290203

Sachs 290988

Sachs 290987

Monroe CB0067 + CB0058

OE Part No

Scania

4 Serie

94-114-124-144-164

1363122

1424228

1424227

1397396

1397400

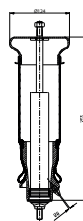

RT2.161202.AA

Cross References

Sachs 105873

Sachs 290989

Monroe CB0067 + CB0059

OE Part No

Scania

4 Serie

94-114-124-144-164

1349844

1382826

1382827

1382829

1424229

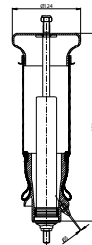

RT2.161301.BS

Cross References

Sachs	310619
Monroe	CB0067

OE Part No

Scania
R Serie
1424231

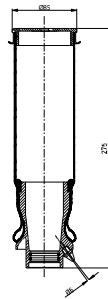

RT2.161301.AA

Cross References

Monroe	CB0067 + CB0134
Sachs	310620

OE Part No

Scania
R Serie
1502473
1505563

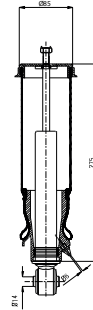

RT2.161302.R0

Cross References

Monroe	CB0074
--------	--------

OE Part No

Scania
R Serie
1502471
1502468

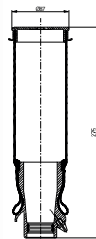

RT2.161302.AA

Cross References

Monroe	CB0074 + CB0078
--------	-----------------

OE Part No

Scania	750 212
R Serie	
1502470	
1502471	
1502474	

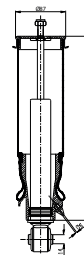

RT2.161304.B0

Cross References

Sachs	312465
Monroe	CB0130

OE Part No

Scania	
R Serie	
1444016	

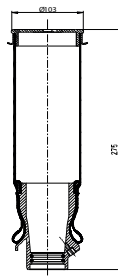

RT2.161304.OA

Cross References

Sachs	312465
Sachs	290987
Monroe	CB0058 + CB0130

OE Part No

Scania	
R Serie	
1363120	
1397396	
1397390	
1397392	

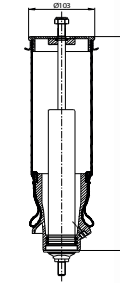

RT2.161304.AA

Cross References

Sachs	312465
Sachs	310620
Monroe	CB0130 + CB0134

OE Part No

Scania	A 363 328 0201
R Serie	
1505563	

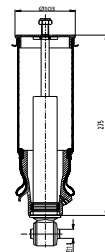

RT2.1620102.S

Cross References

Firestone	W21-760-9931
-----------	--------------

OE Part No

Bpw	02 200 24 20 0
Bpw	02.200.24.00.0
Daf	0 644 425
Daf	0 578 361
Evo Bus	4 731013 000
Gigant	161210
Gigant	161209
Gigant	196035

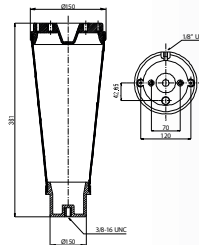

RT2.162102.OA

Cross References

Sachs Old	290 998
Sachs New	311663
Monroe	CB0115

OE Part No

Mercedes
943 890 38 19
943 890 59 19
942 890 53 19

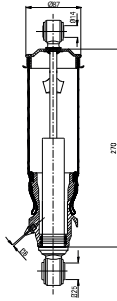

RT2.162102.AA

Cross References

OE Part No

Mercedes

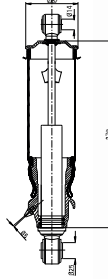

RT2.1630101.S

Cross References

Firestone	W02 358 7207
-----------	--------------

OE Part No

Freightliner
18-40977-000

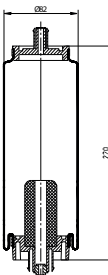

RT2.1630102.S

Cross References

Firestone	W02 358 7093
-----------	--------------

OE Part No

Peterbuilt
29-06016



RT2.163101.F0

Cross References

OE Part No

Man
F2000

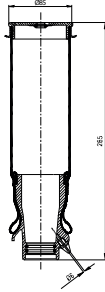

RT2 163101.OA

Cross References

Sachs	105855
Monroe	CB 0092

OE Part No

Man
F2000
81 41722 6048
81 41722 6051

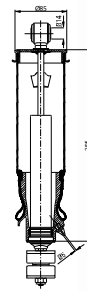

RT2.163101.R0

Cross References

Contitech	883 N1
Firestone	1R4R 465 260 W01095 0435
Phoenix	1F 21C-2
Goodyear	9012
Cf Gomma	1SC 250-29 204250

OE Part No

Man
F2000

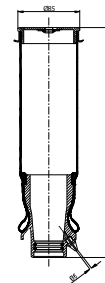

RT2.163101.AA

Cross References

Sachs	105856
Monroe	CB 0091

OE Part No

Man
F2000
Tga
81 41722 6052
81 41722 6049

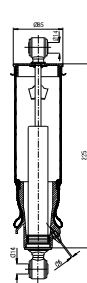

RT2.163102.OA

Cross References

Sachs	135174
Sachs	135196
Sachsa	313 181

OE Part No

Man
Tga
85 41722 6008
8141722 6077
85 41722 6014
85 41722 6022

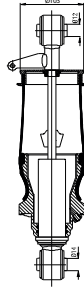

RT2.163103.OA

Cross References

Sachs	135195
Sachs	135197
Sachs	313 182

OE Part No

Man
Tga
85 41722 6009
85 41722 6078
85 41722 6015
85 41722 6023

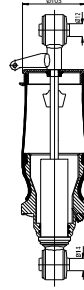

RT2.163104.AA

Cross References

Sachs	135198
Sachs	105378
Sachs	313 183
Wabco	964 006 0050

OE Part No

Man
Tga
8141722 6057
8141722 6075
85 41722 6006
85 41722 6012

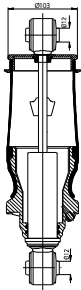

RT2.163105.AA

Cross References

Sachs	135200
Sachs	135199
Sachs	313 184

OE Part No

Man
Tga
8141722 6058
85 41722 6007
85 41722 6013
85 41722 6024

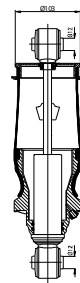

RT2.1635101.S

Cross References

Firestone	W02 358 7206
Contitech	AB SZ70

OE Part No

Freightliner	18-29919-000
--------------	--------------

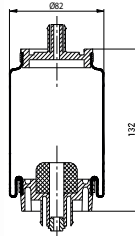

RT2.164101.OA

Cross References

Sachs	310 820
-------	---------

OE Part No

Iveco Stralis	500 357 351
---------------	-------------

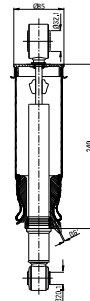

RT2.164101.AA

Cross References

Sachs	310 821
-------	---------

OE Part No

Iveco Stralis	500 357 352
---------------	-------------

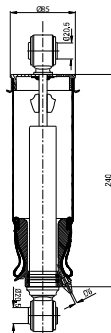

RT2.164102.AA

Cross References

Sachs	73170000277
Sachs	73 1700 002 845
Sachs	311884

OE Part No

Iveco Stralis	504 060 241
---------------	-------------

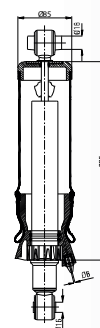

RT2.164103.OA

Cross References

Arvinmeritor 908322985

OE Part No

Iveco Stralis
500 340 705

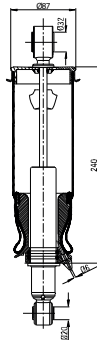

RT2.164103.AA

Cross References

Arvinmeritor 908322986

OE Part No

Iveco Stralis
500 340 706

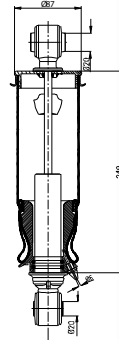

RT2.164104.AA

Cross References

Arvinmeritor 908323140

OE Part No

Iveco Stralis
504 060 233

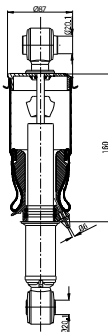

RT2.164201.AA

Cross References

Sachs 115 743

OE Part No

Iveco
Eurotech-eurostar
4102 8764
4102 8763
500377878
500348793

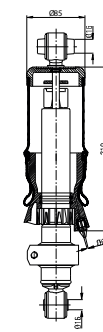

RT2.165103.B0

Cross References

Contitech SZ50-6

OE Part No

Renault
Gamme G
5010 133 079 D

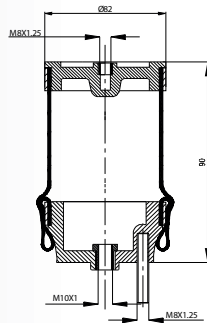

RT2.165201.B0

Cross References

Contitech 816-Z
Monroe CB0076

OE Part No

Renault
Magnum
5010 320 096A

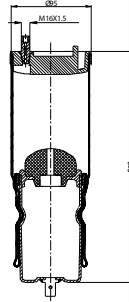

RT2.165202.FO

Cross References

Contitech SK86-10

OE Part No

Renault
Magnum
5010 491 301



RT2.165203.AA

Cross References

Monroe CB 0070

OE Part No

Renault
Magnum E-tech
5010 228 849

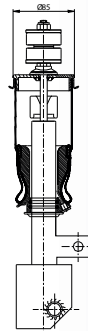
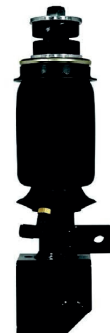

RT2.165204.AA

Cross References

Monroe	CB 0118
--------	---------

OE Part No

Renault
Magnum
2089 8055
5010 629 471
742 089 8055
748 205 2893
820 528 93

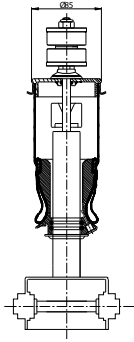

RT2.165301.AA

Cross References

Contitech	SZ36-10
Sachs	131041
Sachs	310957
Monroe	CB 0088

OE Part No

Renault
Premium
5010 228 908
5010 316 783
5010 269 674
5010 269 674

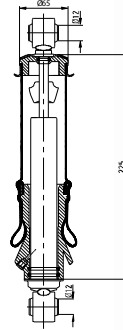

RT2.165302.F0

Cross References

Contitech	SZ50-9
Monroe	CB 0075

OE Part No

Renault
Premium
5010 130 797 G

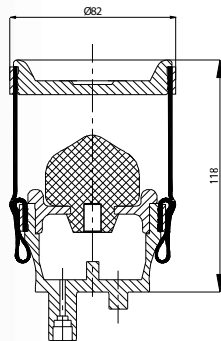

RT2.165302.F01

Cross References

Contitech	SZ50-9 P02
Monroe	CB 0075

OE Part No

Renault
Premium
5010 629 414

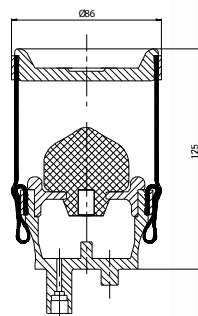

RT2.165303.AA

Cross References

Sachs	25376537
Sachs	78100001622

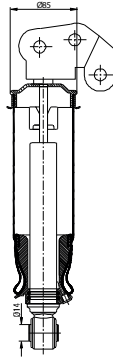

OE Part No

Renault 440
Premium
50 10 615 879

RT2.166101.F0

Cross References

Monroe	CB 0003
--------	---------

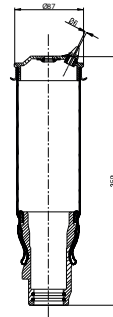

OE Part No

Volvo
Fh12-Fh16A

RT2.166101.FA

Cross References

Monroe	CB 0003
--------	---------

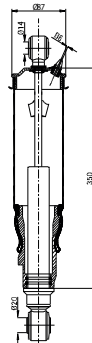

OE Part No

Volvo
Fh12-Fh16
3172984
1629724
1629719

RT2.166102.R0

Cross References

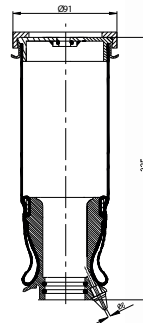

OE Part No

Volvo
Fh12-Fh16

RT2.166102.AA

Cross References

Monroe CB 0006

OE Part No

Volvo
Fh12-Fh16
20427897
20775212
20889134
20721169

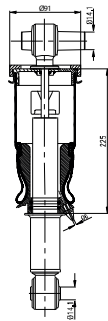

RT2.166103.R0

Cross References

OE Part No

Volvo
Fh12-Fh16

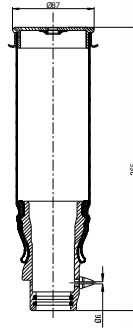

RT2.166103.AA

Cross References

Monroe CB 0002

OE Part No

Volvo
Fh12-Fh16
1075076
1075077

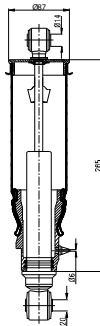

RT2.166104.F0

Cross References

Monroe CB0055

OE Part No

Volvo
Fh12

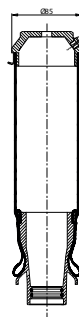

RT2.166104.OA

Cross References

Monroe	CB0055
Monroe	CB0039

OE Part No

Volvo
Fh12
20453256
20889132
21111932
20889132-1

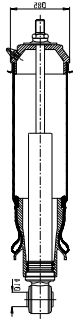
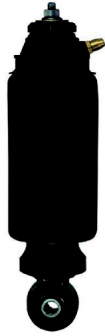

RT2.167101.OA

Cross References

Monroe	CB 0033
--------	---------

OE Part No

Daf
95 - 95Xf
126281
1285393
1321590
1353450
1353453
1371065

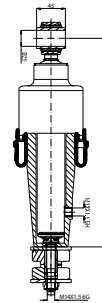

RT2.167101.AA

Cross References

Monroe	CB 0034
--------	---------

OE Part No

Daf
95 - 95Xf
1265282
1285394
1321591
1353451
1353454
1371066

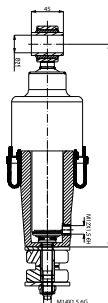

Cross References

OE Part No

CONVOLUTED
TYPE

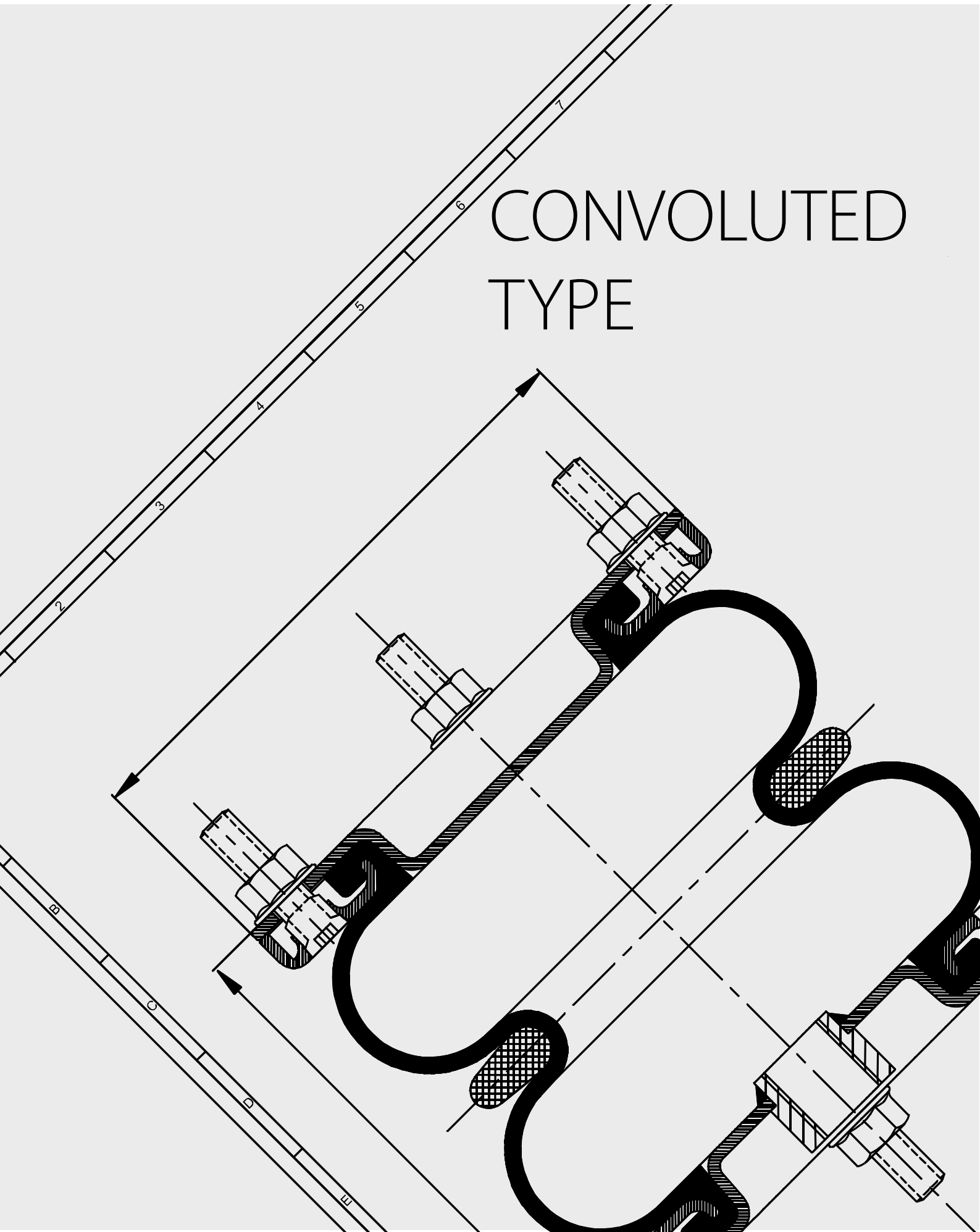

RT3.15101.P01

Cross References

Contitech	FS 70-72681015 000
Phoenix	SP 1B 05

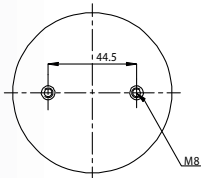
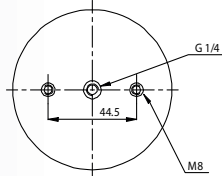
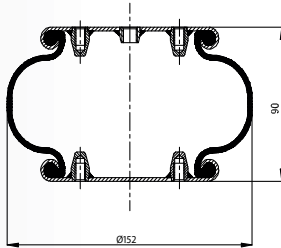

OE Part No

RT3.20102.F01

Cross References

Contitech	FD 138-18 1/2 M10
Dunlop	SP 1490 (8"X2)

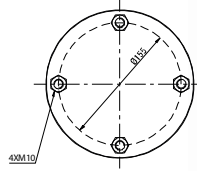
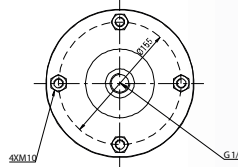
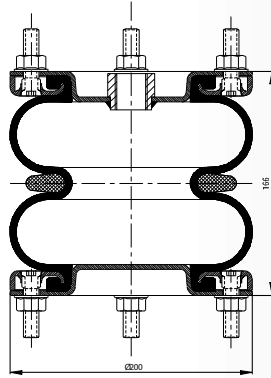

OE Part No

Fruehauf	F48054M80A04
Granning	15803 / A06030604

RT3.20102.M01

Cross References

Contitech	FD 138-18 S
Dunlop	8"X2

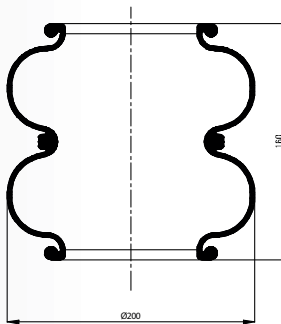

OE Part No

RT3.21101.P01

Cross References

OE Part No

Gart	T291/B (291.1.170)
------	--------------------

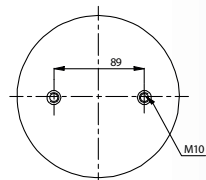
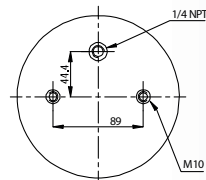
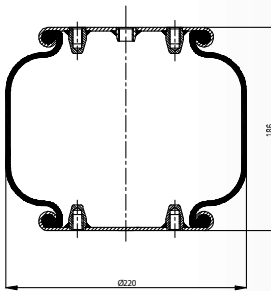

RT3.21102.P01

Cross References

Contitech	FD 200-19 1/4 M10
Dunlop	9" SO 9201
Firestone	W01-M58-6887/6910
Good Year	2B9-201
Phoenix	SP 2B 12R
Pirelli	T20

OE Part No

Gart	T291/2 (291.2.200)
Granning	15603
Meritor	2122 1395 / 2122 2663
Weweler	US 06910 F

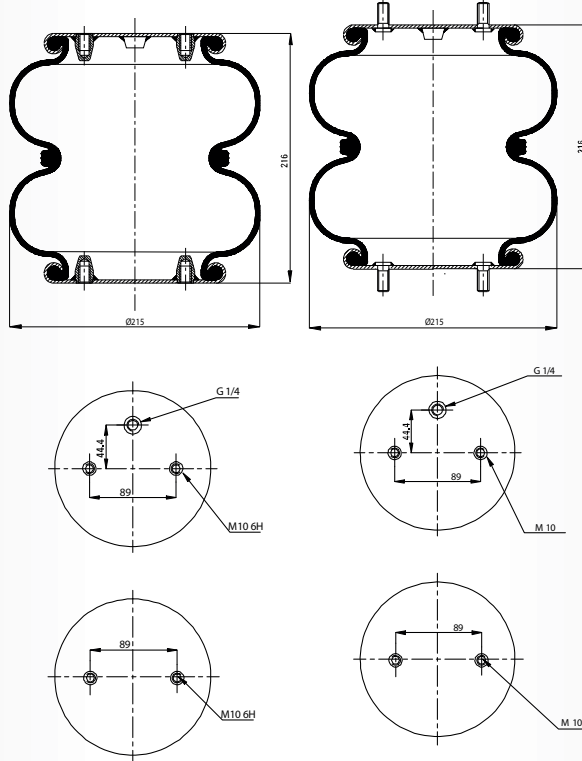

RT3.21102.P02

Cross References

OE Part No

RT3.21102.P04

Cross References

Contitech	FD 200-19 3/4 M8
Dunlop	S09202
Firestone	20
Phoenix	2B 12R-1
Pirelli	T20

OE Part No

Granning	A06030604
Mercedes	A 942 327 0601
Meritor	2122 1395

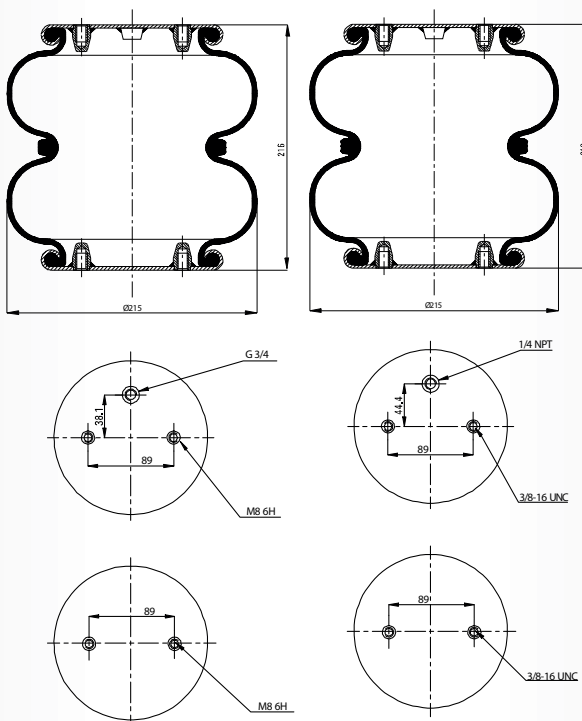

Cross References

Firestone	W01-358-6910
Good Year	2B9-200
Taurus	KF218-6910

OE Part No

Granning	1371
Hendrickson	45843-3 / B-8768

RT3.21102.P08

Cross References

OE Part No

Scania 1387283

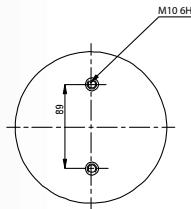
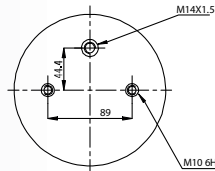
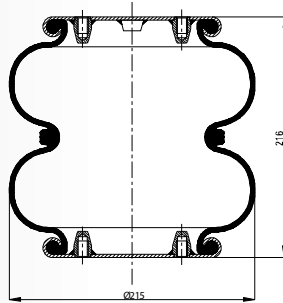

RT3.21102.P11

Cross References

Contitech	FD 200-19 P04
Dunlop	9" S09208
Firestone	W01-M58-7894
Good Year	2B9-287
Phoenix	2B12R-3
Pirelli	T20 86660
Taurus	KF 216

OE Part No

Granning	A06030604
Saf	4.229.1004.00
Scania	1319761-138 7289

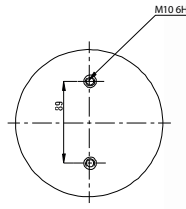
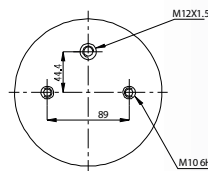
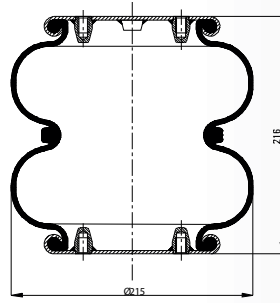

RT3.21102.P12

Cross References

Contitech	FD 200-19 P03
Dunlop	9" S09203
Firestone	20-2
Phoenix	2B12R-3/R-5
Pirelli	T20

OE Part No

Saf 45.98.00.5419.2

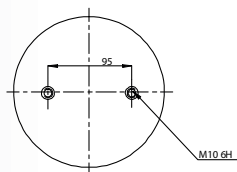
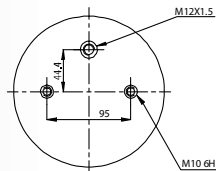
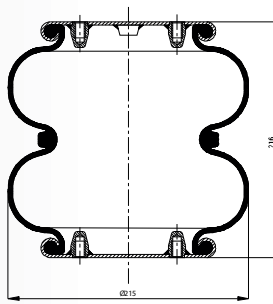

RT3.21102.P14

Cross References

Contitech	FD 200-19 P02
-----------	---------------

OE Part No

Mercedes A 942 327 06 01

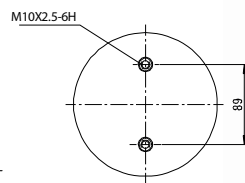
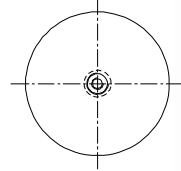
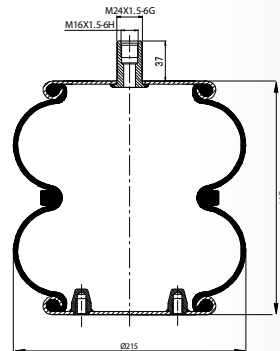

RT3.21102.P16

Cross References

Firestone 20 T3 095.0353

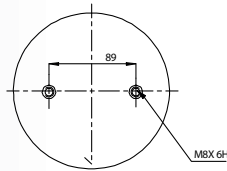
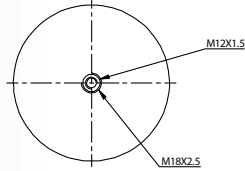
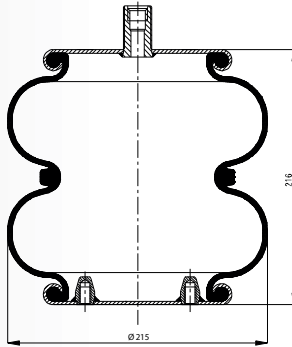

RT3.21102.P21

Cross References

Dunlop S09201

Firestone 20 C

Phoenix SP 2B12R-12

Pirelli T20

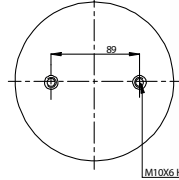
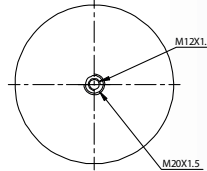
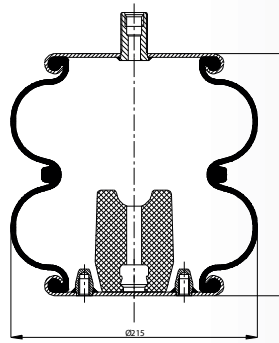

OE Part No

OE Part No

Hendrickson HS507907/P

RT3.28502.M01

Cross References

Contitech 608 N

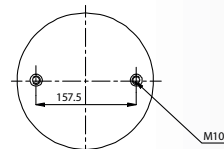
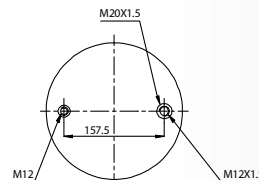
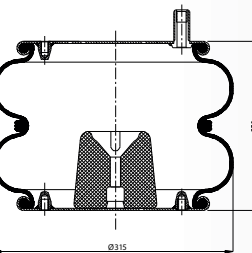
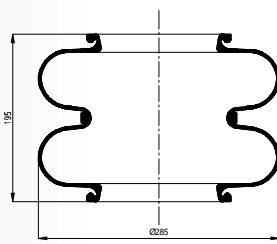

Cross References

Phoenix SP 2B22-RA-2

OE Part No

Bpw 02.200.20.50.0

Granning 15923

Kassbohrer 4 731 003 000

Kassbohrer 4 731 024 000

Man 88 96420 0217

OE Part No

Hendrickson HS 507906/P

RT3.30103.P01

Cross References

Contitech FT 330-29 P01

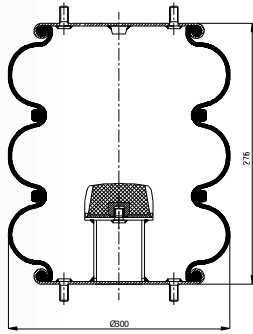

OE Part No

Gart T271/S (271.3.296)

Granning 17017

Saf 3.228.1002.01

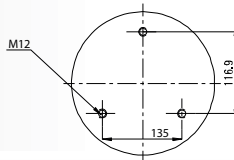
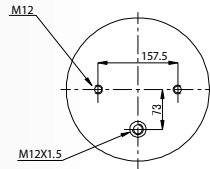

RT3.30202.F01

Cross References

Contitech FD 412-18 1/2 M10

Dunlop SP 1541NB

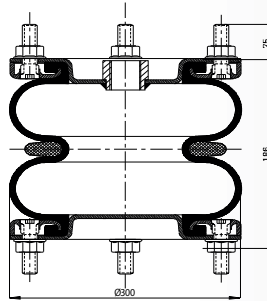

OE Part No

Gigant 881202

Granning 15813

Weweler USN 5100 11KD

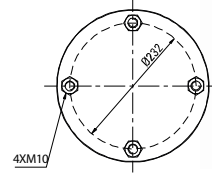
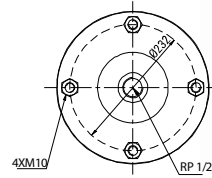

RT3.30202.F02

Cross References

Contitech FD 412-18

Dunlop SP 2665 (12X2)

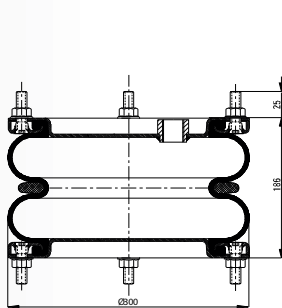

OE Part No

Fruehauf U.B 09 85/A

Granning 15814

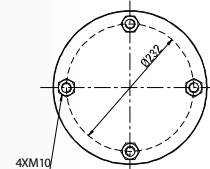
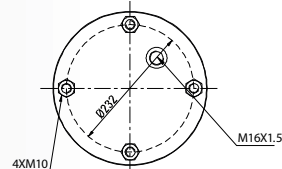

RT3.30303.F02

Cross References

Contitech FT 412-32 S

Dunlop SP 2666

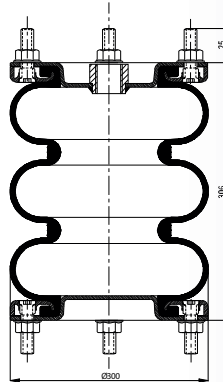

OE Part No

Fruehauf M 002 297

Granning 15897

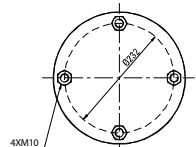
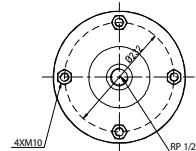

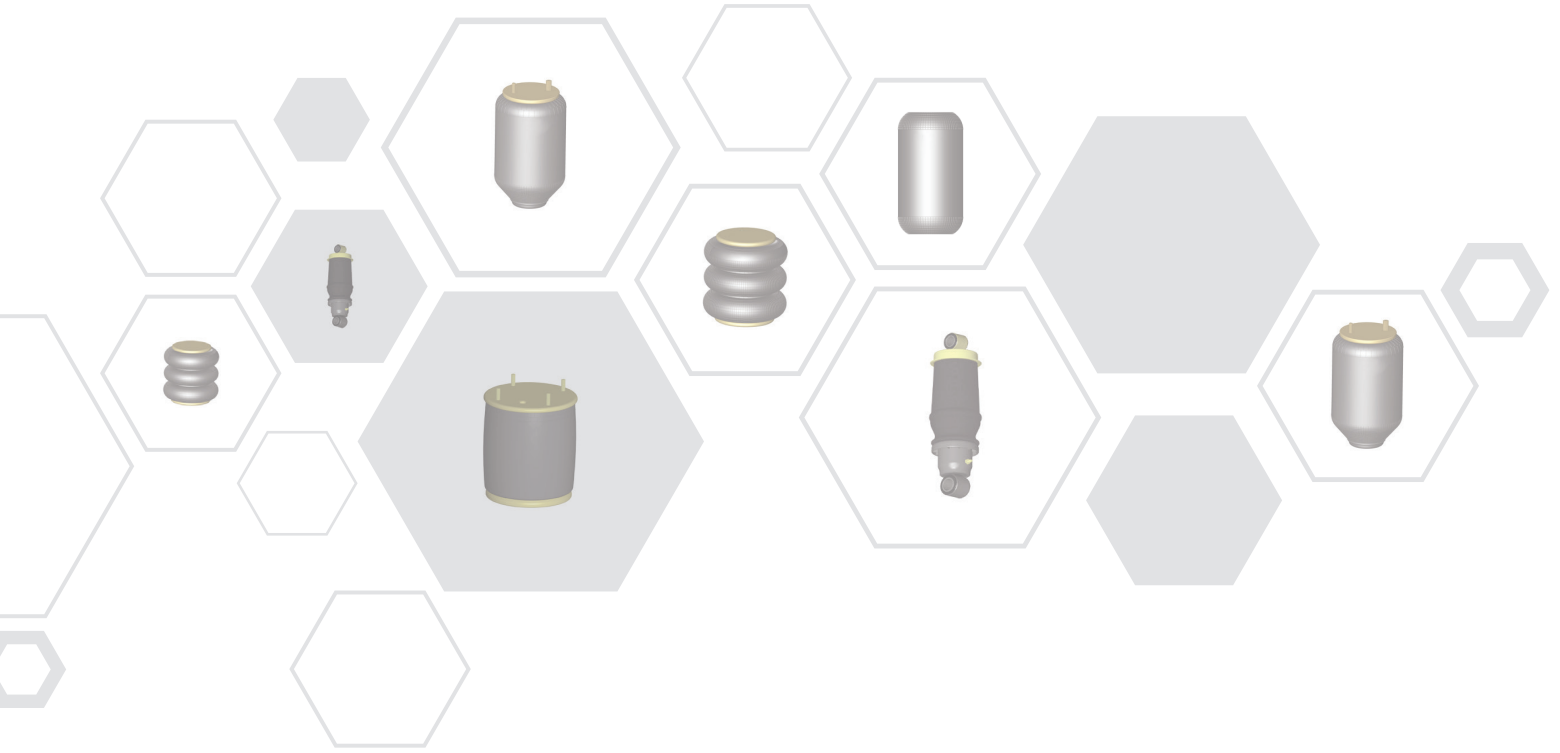

SALES & MARKETING OFFICE

RAN OTOMOTİV YEDEK PARÇA DIŐ TİC. LTD. ŐTİ
GüneŐli Evren Mah. Bahar Cad. Polat İŐ Merkezi
C Blok Kat : 2 No : 5 Bađcılar / İSTANBUL 34212

T: +90 212 489 12 50 (pbx)
F: +90 212 630 24 60

info@rantech.com.tr
www.rantech.com.tr