



**MERITOR®**

## Meritor Slack Adjusters





Levier de Frein Meritor  
Meritor Gestängesteller  
Leve Freno Meritor  
Meritor Remstellers  
Palancas de Freno Meritor  
Dźwignie wałka rozpięra Meritor  
Тормозные рычаги Meritor

**ArvinMeritor™**

<b>Glossary</b> .....	<b>2</b>
Vocabulaire	
Glossar	
Vocabolario	
Verklarende woordenlijst	
Glosario	
Słownictwo	
Глоссарий	
<b>Slack Adjuster Applications</b> .....	<b>3</b>
Applications levier de frein Meritor	
Anwendungen Meritor Gestängesteller	
Applicazioni leve freno Meritor	
Meritor Remstellers applicaties	
Aplicaciones palancas de freno Meritor	
Zastosowania dźwigni wałka rozpieraka	
Применение тормозных рычагов	
<b>Buyers Guide</b> .....	<b>19</b>
Guide Acheteurs	
Teileverwendung	
Guida degli Acquisti	
Kopersgids	
Guía de compras	
Zastosowanie części	
Инструкции для покупателя	
<b>Meritor Slack Adjusters Explanations</b> .....	<b>23</b>
Explications levier de frein Meritor	
Erklärungen Meritor Gestängesteller	
Spiegazioni leve freno Meritor	
Meritor Remsteller uitleg	
Explicaciones palancas de freno Meritor	
Objaśnienia dźwigni wałka rozpieraka	
Пояснения к тормозным рычагам Meritor	
<b>Cross Reference</b> .....	<b>35</b>
Liste d'Equivalences	
Umcodierungen	
Trascodifica	
Kruisverwijzing	
Referencia cruzada	
Zamienniki	
Таблицы соответствия	

**Glossary / Vocabulaire / Glossar / Vocabolario /  
Verklarende woordenlijst / Glosario / Słownictwo / Глоссарий**

	GB	F	D	I	NL	E	PL	RU
	Left Hand	Gauche	Links	Sinistro	Links	Izquierdo	Lewa strona	Левая сторона
	Right Hand	Droite	Rechts	Destro	Rechts	Derecho	Prawa strona	Правая сторона
	Left or Right Handed	Gauche ou Droite	Links oder Rechts	Sinistro o Destro	Links oder rechts	Izquierdo o derecho	Lewa lub prawa strona	Левая или правая сторона
	Truck	Porteur	LKW	Motrice	Vrachtauto	Camion	samochód ciężarowy	Грузовой автомобиль
	Bus	Autobus	Autobus	Bus urbano	Bus	Autobus	Autobus	Автобус
	Trailer	Remorque	Anhänger	Rimorchio	Aanhangwagen	Remorque	naczepa	Прицеп
 1	All Dimensions are in mm	Toutes les dimensions sont en mm	Alle Dimensionen in mm	Tutte le dimensioni sono in mm	Alle afmetingen zijn in mm	las dimensiones están en mm	Wszystkie wymiary w mm	Все размеры в
2	Manufacturers' numbers are for reference only	Les références constructeurs sont indiquées pour information uniquement	Die Fahrzeughersteller-Angaben dienen nur zu Vergleichszwecken	I dati della casa costruttrice servono solo a scopo comparativo	Fabrieksnummers dienen alleen ter informatie	Las referencias de los fabricantes son para consulta únicamente	Podane numery oryginalne służą tylko do celów porównawczych	Номера производителя служат только для сравнения





**Supersessions / Remplacement / Ersetzungen / Sostituzioni  
Vervangendoor / Sostitutos por / Zmiana numerów katalogowych / Замена**

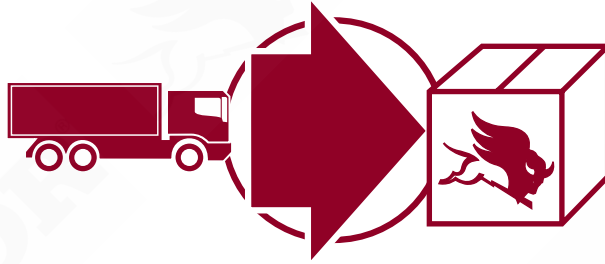

MAS123801 .....	MAS9285
MAS123802 .....	MAS9286
MAS153801 .....	MAS9250
MAS153802 .....	MAS9251
MAS330001 .....	MAS300001

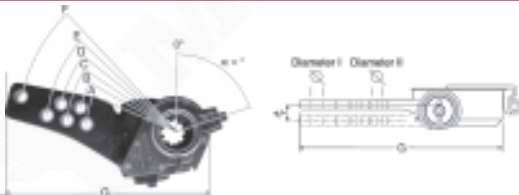

DAF .....	5
FODEN .....	5
HINO .....	5
IVECO .....	5
LEYLAND .....	5
MAN .....	5
MERCEDES .....	6
RENAULT .....	6
SAURER .....	6
SCANIA.....	7

			OEM Ref												Typ	
				ØC	A	B	C	D	E	F	G	ØI	ØII	+/-		

## DAF

TRUCK		MAS143807	0092419	155	165							233	14.2		-38	10 SAE 1-1/2" - 10c	4
		MAS143808	0092420	155	165							233	14.2		+38	10 SAE 1-1/2" - 10c	4
	←	MAS114501	0159589	41	165							211	14.2		-45	10 SAE 1-1/2" - 10c	1
	←	MAS115613	0159563	80	143							207	14.2		-56	10 SAE 1-1/2" - 10c	1
	←	MAS117501	219860	55	165							228	16.2		-75	10 SAE 1-1/2" - 10c	1
	←	MAS141201	1282111	-28	165							197	14.2		11.5	10 SAE 1-1/2" - 10c	4
	←	MAS143803	281090	-22	140							205	14.2		38	10 SAE 1-1/2" - 10c	4
	←	MAS146002	1263486	143	145							226	14.2		+60	10 SAE 1-1/2" - 10c	4
	←	MAS146003	0755616	-22	145							226	14.2		+60	10 SAE 1-1/2" - 10c	4
	←→	MAS113802	361541	0	165							200	14.2		+38	10 SAE 1-1/2" - 10c	1
	↔	MAS113801	361542	0	165							205	14.2		-38	10 SAE 1-1/2" - 10c	1
	↔	MAS143801	0159556	150	140							210	14.2		-38	10 SAE 1-1/2" - 10c	4
	↔	MAS143802	0159557	150	140							201	14.2		+38	10 SAE 1-1/2" - 10c	4
	→	MAS114502	361543	41	165							212	14.2		+45	10 SAE 1-1/2" - 10c	1
	→	MAS115614	0159564	80	143							207	14.2		+56	10 SAE 1-1/2" - 10c	1
	→	MAS117502	219859	55	165							228	16.2		+75	10 SAE 1-1/2" - 10c	1
	→	MAS141202	1282112	-28	165							197	14.2		-11.5	10 SAE 1-1/2" - 10c	4
	→	MAS143804	281091	-22	140							206	14.2		+38	10 SAE 1-1/2" - 10c	4
	→	MAS146001	1263485	143	145							226	14.2		+60	10 SAE 1-1/2" - 10c	4
	→	MAS146004	0755617	-22	145							226	14.2		-60	10 SAE 1-1/2" - 10c	4

## FODEN

TRUCK	←→	MAS130002	2700021000	-6	140							184	12.9			28 ANSI-B92.1-1996	3
	←→	MAS130003	2700020000	-6	127							170	12.9			28 ANSI-B92.1-1996	3
	←→	MAS150013 <sup>1</sup>	7684F	75	140							203	12.9			10 SAE 1-1/2" - 10c	5
	←→	MAS150016 <sup>1</sup>	270048000	-5	140							203	12.9			28 ANSI-B92.1	5
	←→	MAS150017 <sup>1</sup>	2700040000	-5	126							189	12.9			28 ANSI-B92.1	5

<sup>1</sup> = Supplied with Peg Belt

## HINO

TRUCK	←	MAS150012 <sup>1</sup>	474801801	0	150							214	12.9			19 DIN - 5482	5
	←	MAS153806 <sup>1</sup>	474801180	135	150							213	12.9		+38	19 DIN - 5482	5
	→	MAS153805 <sup>1</sup>	474801190	135	150							212	12.9		-38	19 DIN - 5482	5

<sup>1</sup> = Supplied with Peg Belt

## IVECO





TRUCK	←→	MAS110009	4692759	14	160							222	12.9			8 DIN 5363	1
-------	----	-----------	---------	----	-----	--	--	--	--	--	--	-----	------	--	--	------------	---

## LEYLAND

TRUCK	←	MAS132902	ACU8345	-51	133							202	12.9		+28.5	10 SAE 1-1/2" - 10c	3
	←→	MAS110006	ACU8347	80	133							195	12.9			10 SAE 1-1/2" - 10c	1
	→	MAS132901	ACU8344	-51	133							196	12.9		-28.5	10 SAE 1-1/2" - 10c	3

## MAN

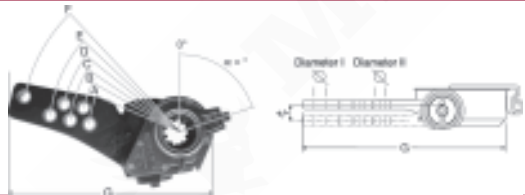
TRUCK	←	MAS115607	81506106176	100	145							202	14.2		+56	26 DIN 5480 N42 x 1.5	1
	←	MAS125601	81506106211	145	145							208	14.2		-56	26 DIN 5480 N42 x 1.5	2
	←	MAS141802	81506106213	-23	145							183	14.2		+18	26 DIN 5480 N42 x 1.5	4
	←→	MAS110011	81506106194	115	145							207	14.2			26 DIN 5480 N42 x 1.5	1
	←→	MAS140001	81506106231	74	145							188	14.2			26 DIN 5480 N42 x 1.5	4
	→	MAS115608	81506106177	100	145							202	14.2		-56	26 DIN 5480 N42 x 1.5	1
	→	MAS125602	81506106210	145	145							210	14.2		+56	26 DIN 5480 N42 x 1.5	2
	→	MAS141801	81506106212	-23	145							182	14.2		-18	26 DIN 5480 N42 x 1.5	4
TRUCK/TGA		MSAS115607	81506106263	-	145							207	14.2		-56	26 DIN 5480 N42 x 1.5	1
		MSAS115608	81506106266	-	145							207	14.2		+56	26 DIN 5480 N42 x 1.5	1
		MSAS115609	81506106261	-	145							206	14.2		-56	26 DIN 5480 N42 x 1.5	1
		MSAS115610	81506106262	-	145							206	14.2		+56	26 DIN 5480 N42 x 1.5	1

			<b>OEM Ref</b>												<b>Typ</b>	
					A	B	C	D	E	F	G	Ø I	Ø II	+/-		

## MERCEDES

TRUCK	←	MAS115602	3874200338	106	145							202	14.2	-56	26 DIN 5480 N42 x 1.5	1
	←	MAS115606	3874200038	145	143							208	14.2	-56	26 DIN 5480 N42 x 1.5	1
	←	MAS116002	6234200638	10	146							180	14.2	-60	26 DIN 5480 N42 x 1.5	1
	←	MAS141804	3894200438	-17	145							182	14.2	-18	26 DIN 5480 N42 x 1.5	4
	←	MAS143702	6524200038	-23	146							182	14.2	+37	26 DIN 5480 N42 x 1.5	4
	←	MAS143704	6194200038	-17	145							182	14.2	+37	26 DIN 5480 N42 x 1.5	4
	↔	MAS140003	3894200738	72	145							188	14.2		26 DIN 5480 N42 x 1.5	4
	→	MAS115601	3874200238	106	145							206	14.2	+56	26 DIN 5480 N42 x 1.5	1
	→	MAS115605	3874200138	145	145							210	14.2	+56	26 DIN 5480 N42 x 1.5	1
	→	MAS116001	6234200738	10	145							181	14.2	+60	26 DIN 5480 N42 x 1.5	1
	→	MAS141803	3894200338	-17	145							182	14.2	+18	26 DIN 5480 N42 x 1.5	
	→	MAS143701	6524200138	-23	145							182	14.2	-37	26 DIN 5480 N42 x 1.5	4
	→	MAS143703	6194200138	-17	145							182	14.2	-37	26 DIN 5480 N42 x 1.5	4
TRUCK/ACTROS	←	MSAS114201	9454200538	-	145							122	14.2	-42	26 DIN 5480 N42 x 1.5	1
	←	MSAS115601	9454200238	-	145							207	14.2	-56	26 DIN 5480 N42 x 1.5	1
	←	MSAS115603	9454200838	-	145							206	14.2	+56	26 DIN 5480 N42 x 1.5	1
	←	MSAS115606	9454200938	-	145							207	14.2	-56	26 DIN 5480 N42 x 1.5	1
	←	MSAS143701	9454200038	-	146							182	14.2	+37	26 DIN 5480 N42 x 1.5	4
	→	MSAS114202	9454200638	-	145							122	14.2	+42	26 DIN 5480 N42 x 1.5	1
	→	MSAS115602	9454200338	-	145							207	14.2	+56	26 DIN 5480 N42 x 1.5	1
	→	MSAS115604	9454200738	-	145							206	14.2	+56	26 DIN 5480 N42 x 1.5	1
	→	MSAS115605	9454200438	-	145							207	14.2	+56	26 DIN 5480 N42 x 1.5	1
	→	MSAS143702	9454200138	-	145							182	14.2	-37	26 DIN 5480 N42 x 1.5	4

## RENAULT

TRUCK	←	MAS113805	5010056686	65	175							228	14.2	-38	27 E22-151 BNA-42 x 1.5	1
	←	MAS113809	5010260027	-8	160							222	14.2	-38	28 ANSI-B92.1-1996	1
	←	MAS113811	5010216843	12	160							221	14.2	-38	27 E22-151 BNA-42 x 1.5 Module	1
	←	MAS113814	5010098832	10	160							221	14.2	-38	28 ANSI-B92.1-1996	1
	←	MAS115609	5010098862	105	160							226	14.2	-56.2	27 E22-151 BNA-42 x 1.5	1
	←	MAS115611	5010098860	35	160							228	14.2	-56.2	27 E22-151 BNA-42 x 1.5	1
	←	MAS125603	5010260117	144	160							226	14.2	-56.2	27 E22-151 BNA-42 x 27 Teeth 1.5 Module	2
	←	MAS125606	5010260115	144	175							226	14.2	-56.2	27 E22-151 BNA-42 x 27 Teeth 1.5 Module	2
	→	MAS113806	5010056685	65	175							229	14.2	+38	27 E22-151 BNA-42 x 1.5	1
	→	MAS113810	5010260028	-8	160							222	38	+38	28 ANSI-B92.1-1996	1
	→	MAS113812	5010216844	12	160							221	14.2	+38	27 E22-151 BNA-42 x 1.5 Module	1
	→	MAS113813 <sup>1</sup>	5010098831	10	160							221	14.2	+12.9	10 SAE 1-1/2" - 10c	5
	→	MAS115610	5010098863	105	160							227	14.2	+56.2	27 E22-151 BNA-42 x 1.5	1
	→	MAS115612	5010098861	35	160							227	14.2	+56.2	27 E22-151 BNA-42 x 1.5	1
	→	MAS125604	5010260118	144	160							226	14.2	+56.2	27 E22-151 BNA-42 x 27 Teeth 1.5 Module	2
	→	MAS125605	5010260116	144	175							226	14.2	+56.2	27 E22-151 BNA-42 x 27 Teeth 1.5 Module	2

<sup>1</sup> = Supplied with Peg Belt

## SAURER

TRUCK		MAS285901		114	148	180						236	14.2	+59	19 DIN - 5482	18
		MAS285902		114	150	180						236	14.2	-59	19 DIN - 5482	18

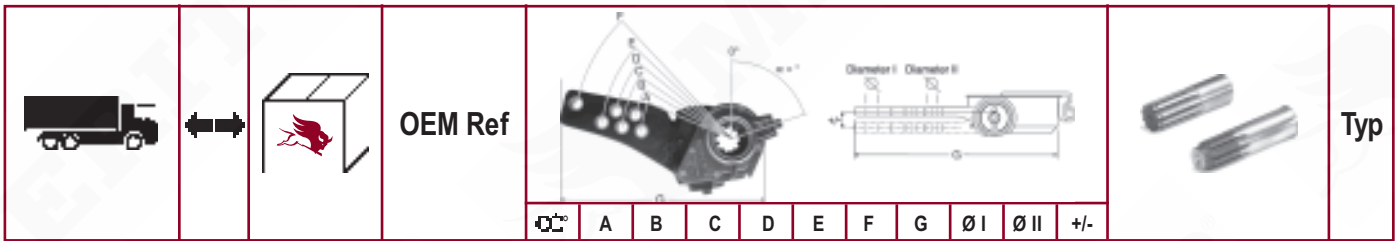

A B C D E F G Ø I Ø II +/-

**SCANIA**

TRUCK	←	MAS116502	1358635	85	165						228	16.2	+65	10 SAE 1-1/2" - 10c	1
	←	MAS132501	082460300	-55	165						195	16.2	+25	10 SAE 1-1/2" - 10c	3
	↔	MAS130004	1112831	-55	165						200	16.2		10 SAE 1-1/2" - 10c	3
	↔	MAS113501	394195	63	130						194	16.2	+35	10 SAE 1-1/2" - 10c	1
	↔	MAS113502	394196	63	130						194	16.2	-35	10 SAE 1-1/2" - 10c	1
	→	MAS116501	1358634	85	165						228	16.2	-65	10 SAE 1-1/2" - 10c	1
	→	MAS132502	1112834	-55	165						195	16.2	-25	10 SAE 1-1/2" - 10c	3





**MERITOR®**



DAEWOO .....	11
DAF .....	11
DENNIS .....	11
IKARUS .....	11
IVECO .....	11
KAROSA .....	11
KÄSSBOHRER .....	11
LEYLAND .....	11
LIAZ .....	12
MAN .....	12
MCW .....	12
MERCEDES .....	12
NEOPLAN .....	12
OPTARE .....	12
RENAULT .....	12
SCANIA .....	13
VAN HOOL .....	13
VOLVO .....	13

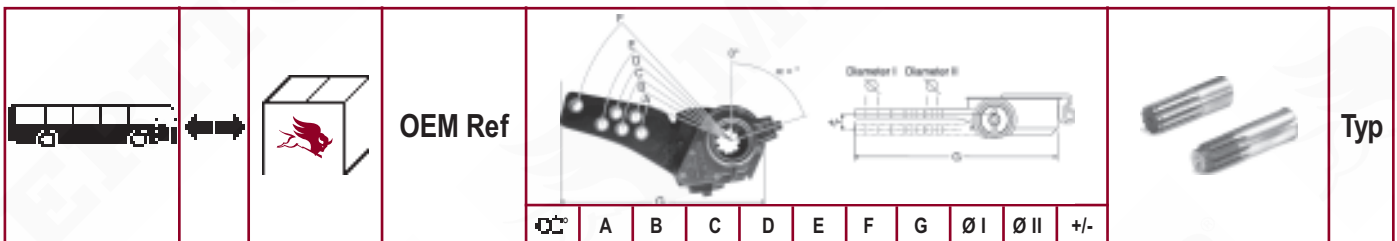

## DAEWOO

BUS	↔	MAS110016		42	150					214	16.2		25 JIS B 1602	1
-----	---	-----------	--	----	-----	--	--	--	--	-----	------	--	---------------	---

## DAF

BUS	←	MAS113803	289691	0	140					187	14.2	+38	10 SAE 1-1/2" - 10c	1
	←	MAS141301	0740321	-22	140					203	14.2	-12.7	10 SAE 1-1/2" - 10c	4
	←	MAS153811 <sup>1</sup>	R9641F	75	140					203	14.2	+38	10 SAE 1-1/2" - 10c	5
	↔	MAS110015	390065	120	140					191	14.2		10 SAE 1-1/2" - 10c	1
	↔	MAS140005	282609	-22	140					204	14.2		10 SAE 1-1/2" - 10c	4
	↔	MAS140006	284860	152	140					180	14.2		10 SAE 1-1/2" - 10c	4
	→	MAS113804	289692	0	141					183	14.2	-38	10 SAE 1-1/2" - 10c	1
	→	MAS141302	0740322	-22	140					202	14.2	+12.7	10 SAE 1-1/2" - 10c	4
	→	MAS153812 <sup>1</sup>	R9640F	75	140					202	14.2	-38	10 SAE 1-1/2" - 10c	5

<sup>1</sup> = Supplied with Peg Belt

## DENNIS

BUS	←	MAS112504	656995-104	50	145					193	14.2	-25	19 DIN - 5482	1
	←	MAS143805	656007-30	152	164					227	12.9	-38	10 SAE 1-1/2" - 10c	4
	↔	MAS140004	611485	157	140					203	12.9		10 SAE 1-1/2" - 10c	4
	↔	MAS140007	651623	-21	127					189	12.9		10 SAE 1-1/2" - 10c	4
	↔	MAS150008 <sup>1</sup>	611484	75	140					205	12.9		10 SAE 1-1/2" - 10c	5
	↔	MAS150010 <sup>1</sup>	651777	15	140					204	12.9		10 SAE 1-1/2" - 10c	5
	↔	MAS150014 <sup>1</sup>	651626	18	127					190	12.9		10 SAE 1-1/2" - 10c	5
	→	MAS112503	656995-105	50	145					194	14.2	+25	19 DIN - 5482	1
	→	MAS143806	656007-29	152	165					183	14.2	+18	10 SAE 1-1/2" - 10c	4

<sup>1</sup> = Supplied with Peg Belt

## IKARUS

		MAS110020		103	145					206	14.2		19 DIN - 5482	1
--	--	-----------	--	-----	-----	--	--	--	--	-----	------	--	---------------	---

## IVECO

BUS	←	MAS112901	3231343	120	152					214	14.2	-28.5	19 DIN - 5482	1
	→	MAS125001	3231273	141	152					219	14.2	+50	19 DIN - 5482	2

## KAROSA

BUS	←	MAS111701		0	240					300	14.2	-15.6	26 DIN 5480 N42 x 1.5	1
	←	MAS152201 <sup>1</sup>		25	170					233	14.2	-22	26 DIN 5480 N42 x 1.5	5
	→	MAS111702		0	240					300	14.2	+15.6	26 DIN 5480 N42 x 1.5	1
	→	MAS152202 <sup>1</sup>		25	170					233	14.2	+22	26 DIN 5480 N42 x 1.5	5

<sup>1</sup> = Supplied with Peg Belt

## KÄSSBOHRER





BUS	←	MAS153808 <sup>1</sup>	82850002140	145	150					213	14.2	+38	19 DIN - 5482	5
	←	MAS153810	82850000900	140	175					237	14.2	-38	19 DIN - 5482	5
	→	MAS153807 <sup>1</sup>	82850002130	145	150					213	14.2	-38	19 DIN - 5482	5
	→	MAS153809 <sup>1</sup>	82850000890	140	175					238	14.2	+38	19 DIN - 5482	5

<sup>1</sup> = Supplied with Peg Belt

## LEYLAND

BUS	←	MAS151601 <sup>1</sup>	BCU5767	145	155					211	12.9	+16	10 SAE 1-1/2" - 10c	5
	←	MAS151604 <sup>1</sup>	ACU3627	130	155					211	12.9	+16	10 SAE 1-1/2" - 10c	5
	←	MAS151605 <sup>1</sup>	10889962	140	165					220	12.9	+16	10 SAE 1-1/2" - 10c	5
	↔	MAS150007 <sup>1</sup>	ACU3629	0	179					241	12.9		10 SAE 1-1/2" - 10c	5
	↔	MAS150009 <sup>1</sup>	10901188	109	180					223	12.9		10 SAE 1-1/2" - 10c	5
	↔	MAS150011 <sup>1</sup>	BCU5769	25	165					221	12.9		10 SAE 1-1/2" - 10c	5
	→	MAS151602 <sup>1</sup>	BCU5768	145	155					211	12.9	-16	10 SAE 1-1/2" - 10c	5
	→	MAS151603 <sup>1</sup>	ACU3628	130	155					211	12.9	-16	10 SAE 1-1/2" - 10c	5
	→	MAS151606 <sup>1</sup>	10889963	140	165					221	12.9	-16	10 SAE 1-1/2" - 10c	5

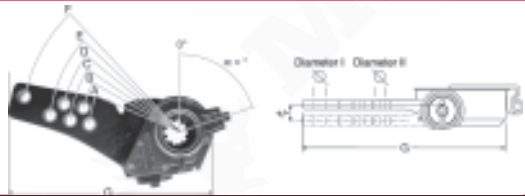
<sup>1</sup> = Supplied with Peg Belt











			<b>OEM Ref</b>												<b>Typ</b>	
				Ø	A	B	C	D	E	F	G	Ø I	Ø II	+/-		

## LIAZ

BUS		MAS150019 <sup>1</sup>		76	175							272	14.2			20 DIN-5482	5
-----	---	------------------------	--	----	-----	--	--	--	--	--	--	-----	------	--	--	-------------	---

<sup>1</sup> = Supplied with Peg Belt

## MAN

















BUS		MAS114503	81506106188	100	216							275	14.2		-45	26 DIN 5480 N42 x 1.5	1
		MAS114504	81506106187	100	215							275	14.2		+45	26 DIN 5480 N42 x 1.5	1
		MAS111803	81506106181	105	130							183	14.2		+18	26 DIN 5480 N42 x 1.5	1
		MAS114001	81506106178	100	130							178	14.2		-40	26 DIN 5480 N42 x 1.5	1
		MAS281502	81506106169	77	130							153	14.2		+15	26 DIN 5480 N42 x 1.5	18
		MAS110012	81506106193	110	145							208	14.2			26 DIN 5480 N42 x 1.5	1
		MAS140001	81506106231	74	145							188	14.2			26 DIN 5480 N42 x 1.5	4
		MAS111804	81506106182	105	130							183	14.2		-18	26 DIN 5480 N42 x 1.5	1
		MAS114002	81506106179	100	130							178	14.2		+40	26 DIN 5480 N42 x 1.5	1
		MAS281501	81506106170	77	131							153	14.2		-15	26 DIN 5480 N42 x 1.5	18

## MCW

BUS		MAS153803 <sup>1</sup>	F4105F	75	141							201	12.9		-38	10 SAE 1-1/2" - 10c	5
		MAS153804 <sup>1</sup>	F4106F	75	140							203	12.9		+38	10 SAE 1-1/2" - 10c	5

<sup>1</sup> = Supplied with Peg Belt

## MERCEDES

BUS		MAS110017	3934200038	114	110							145	14.2			26 DIN 5480 N42 x 1.5	1
		MAS111801	3574201338	105	130							182	14.2		-18	26 DIN 5480 N42 x 1.5	1
		MAS111805	3574201538	55	130							183	14.2		-18	26 DIN 5480 N42 x 1.5	1
		MAS141501	3574201138	-4	130							189	14.2		-15	26 DIN 5480 N42 x 1.5	4
		MAS141503	3074200138	-15	115							168	14.2		-15	26 DIN 5480 N42 x 1.5	4
		MAS110003	3574200538	26	145							177	14.2			26 DIN 5480 N42 x 1.5	1
		MAS110004	6174200238	84	145							190	14.2			26 DIN 5480 N42 x 1.5	1
		MAS110005	3074200338	80	130							154	14.2			26 DIN 5480 N42 x 1.5	1
		MAS110007	6524200238	130	145							177	14.2			26 DIN 5480 N42 x 1.5	1
		MAS110008	3054202638	64	115							163	14.2			26 DIN 5480 N42 x 1.5	1
		MAS115603	3834200438	9	145							206	14.2		+56	26 DIN 5480 N42 x 1.5	1
		MAS115604	3834200538	9	145							206	14.2		-56	26 DIN 5480 N42 x 1.5	4
		MAS140002	3014201138	-25	130							174	14.2			26 DIN 5480 N42 x 1.5	4
		MAS111802	3574201438	105	130							181	14.2		+18	26 DIN 5480 N42 x 1.5	1
		MAS111806	3574201638	55	130							183	14.2		+18	26 DIN 5480 N42 x 1.5	1
		MAS141502	3574201238	-4	130							189	14.2		+15	26 DIN 5480 N42 x 1.5	4
		MAS141504	3074200238	-15	116							168	14.2		+15	26 DIN 5480 N42 x 1.5	4





## NEOPLAN

BUS		MAS112501	B510643	52	145							195	14.2		-25	19 DIN - 5482	1
		MAS110010	080250000	80	130							154	14.2			19 DIN - 5482	1
		MAS112502	B510642	52	145							195	14.2		+25	19 DIN - 5482	1

## OPTARE

BUS		MAS150015	L2220055	30	140							184	12.9			28 ANSI-B92.1 - 1996	
-----	---	-----------	----------	----	-----	--	--	--	--	--	--	-----	------	--	--	----------------------	--

## RENAULT

		MAS110018	5010201995	90	160							254	14.2			28 ANSI-B92.1-1996	1
		MAS110019	5010152965	103	190							283	14.2			27 E22-151 BNA-42 x 27 Teeth 1.5 Module	1
BUS		MAS113807	5000791212	10	175							237	14.2		+38	27 E22-151 BNA-42 x 1.5 Module	1
		MAS123803	5000789894	154	175							228	14.2		+38	27 E22-151 BNA-42 x 1.5 Module	2
		MAS152204 <sup>1</sup>	5000785203	100	183							246	14.2		-22	27 E22-151 BNA-42 x 27 Teeth 1.5 Module	5

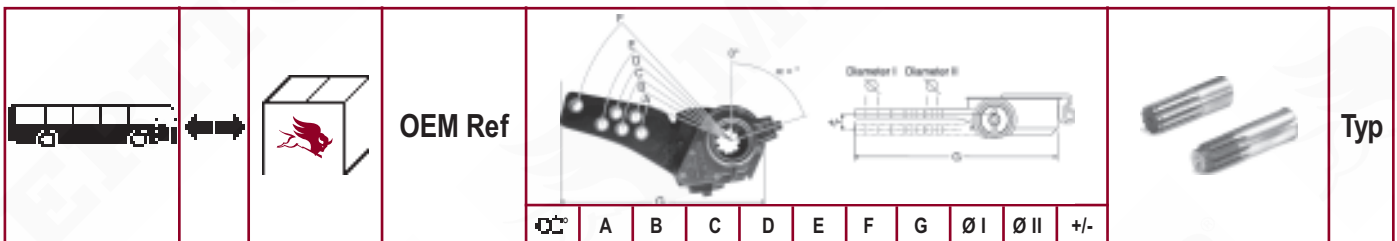

## ... RENAULT

	←	→																	
BUS	←	MAS152302 <sup>1</sup>	5000785205	90	190							258	14.2		+23	27 E22-151 BNA-42 x 27 Teeth 1.5 Module	5		
	→	MAS113808	5000791213	10	175							236	14.2		-38	27 E22-151 BNA-42 x 1.5 Module	1		
	→	MAS123804	5000789895	154	175							230	14.2		-38	27 E22-151 BNA-42 x 1.5 Module	2		
	→	MAS152203 <sup>1</sup>	5000785204	100	183							246	14.2		+22	27 E22-151 BNA-42 x 27 Teeth 1.5 Module	5		
	→	MAS152301 <sup>1</sup>	5000785206	90	190							258	14.2		-23	27 E22-151 BNA-42 x 27 Teeth 1.5 Module	5		

\* = Supplied with Peg Belt

## SCANIA

BUS	←	MAS115002	384417	73	165							230	16.2		+50	10 SAE 1-1/2" - 10c	1
	←	MAS115003	1112839	84	166							219	16.2		+50	10 SAE 1-1/2" - 10c	1
	←	MAS116502	1358635	85	165							228	16.2		+65	10 SAE 1-1/2" - 10c	1
	←	MAS132501	082460300	-55	165							195	16.2		+25	10 SAE 1-1/2" - 10c	3
	←	MAS163802 <sup>1</sup>	218833	-55	165							202	16.2		+38	10 SAE 1-1/2" - 10c	6
	← →	MAS130004	1112831	-55	165							200	16.2			10 SAE 1-1/2" - 10c	3
	→	MAS115001	384418	73	165							228	16.2		-50	10 SAE 1-1/2" - 10c	1
	→	MAS115004	1112840	84	165							219	16.2		-50	10 SAE 1-1/2" - 10c	1
	→	MAS116501	1358634	85	165							228	16.2		-65	10 SAE 1-1/2" - 10c	1
	→	MAS132502	1112834	-55	165							195	16.2		-25	10 SAE 1-1/2" - 10c	3
	→	MAS163801 <sup>1</sup>	218834	-55	165							205	16.2		-38	10 SAE 1-1/2" - 10c	6

\* = Supplied with Peg Belt

## VAN HOOL

BUS	← →	MAS110014	3177673	3	152							213	14.2			19 DIN - 5482	1
-----	-----	-----------	---------	---	-----	--	--	--	--	--	--	-----	------	--	--	---------------	---

## VOLVO

BUS		MAS152905	3136427	90	185							12.9		+28.5	11 SAE 1-1/2" - 10c	
		MAS152906	3136426	90	185							12.9		-28.5	12 SAE 1-1/2" - 10c	
	←	MAS151501 <sup>1</sup>	1195461	6	145							198	12.9	+15	10 SAE 1-1/2" - 10c	5
	←	MAS151504 <sup>1</sup>	1136432	6	134							188	12.9	+15	10 SAE 1-1/2" - 10c	5
	←	MAS151506 <sup>1</sup>	1197965	6	165							215	12.9	+15	10 SAE 1-1/2" - 10c	5
	←	MAS164401 <sup>1</sup>	3193402	-12	145							216	12.9	-44	10 SAE 1-1/2" - 10c	6
	←	MAS165001 <sup>1</sup>	3193400	-24	165							227	12.9	-50	10 SAE 1-1/2" - 10c	6
	← →	MAS150006 <sup>1</sup>	1135004	150	140							204	12.9		10 SAE 1-1/2" - 10c	5
	← →	MAS160001 <sup>1</sup>	1196321	170	140							201	12.9		10 SAE 1-1/2" - 10c	6
	← →	MAS160002 <sup>1</sup>	1196322	170	152							213	12.9		10 SAE 1-1/2" - 10c	6
	→	MAS151502 <sup>1</sup>	1195462	6	145							199	12.9	-15	10 SAE 1-1/2" - 10c	5
	→	MAS151503 <sup>1</sup>	1136433	6	134							183	12.9	-15	10 SAE 1-1/2" - 10c	5
	→	MAS151505 <sup>1</sup>	1197966	6	165							215	12.9	-15	10 SAE 1-1/2" - 10c	5
	→	MAS164402 <sup>1</sup>	3193403	-12	145							216		+44	10 SAE 1-1/2" - 10c	6
	→	MAS165002 <sup>1</sup>	3193401	-24	165							227	12.9	+50	10 SAE 1-1/2" - 10c	6

<sup>1</sup> = Supplied with Peg Belt

--	--	--	--	--	--	--	--	--	--	--	--	--	--	--	--	--	--	--	--





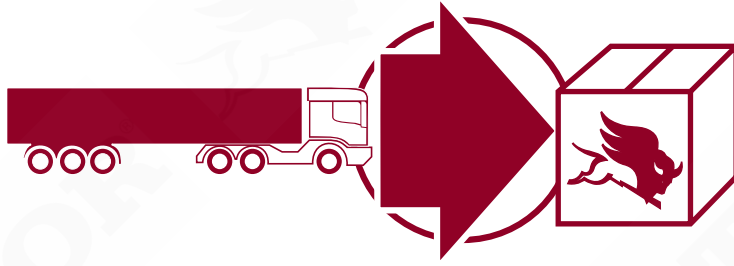

**MERITOR®**



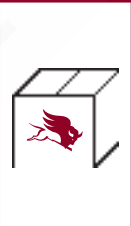
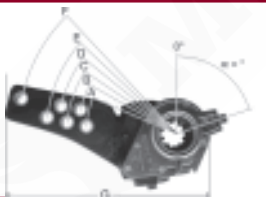
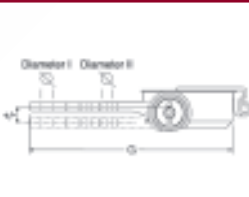

BATTAGLINO .....	17
BPW .....	17
FRUEHAUF .....	17
HENRED TRAILER .....	17
KÄSSBOHRER .....	17
MERITOR/ROR .....	17
PANAV AXLE .....	17
SAE .....	17
SAF .....	18
SMB .....	18
TRAILOR.....	18

			OEM Ref				Typ								
				OC	A	B	C	D	E	F	G	Ø I	Ø II	+/-	

## BATTAGLINO

STEER AXLE	←→	MAS152902 <sup>1</sup>		90	150	180					243	14.2	+28.5	10 SAE 1-1/2" - 10c	5
	←→	MAS152904 <sup>1</sup>		90	150	180					324	14.2	-28.5	10 SAE 1-1/2" - 10c	5

<sup>1</sup> = Supplied with Bracket Kit

## BPW

STEER AXLE	←	MAS152901 <sup>1</sup>	0517454410	110	148	173	198				261	14.2	+28.5	10 SAE 1-1/2" - 10c	5
	→	MAS152903 <sup>1</sup>	0517454420	110	148	173	198				260	14.2	-28.5	10 SAE 1-1/2" - 10c	5
TRAILER	←→	MSAS61000 <sup>2</sup>	0517482212	-	120	135	150	165	180	250	304	14.2		10 SAE 1-1/2" - 10c	51
TRAILER AXLE	←→	MAS110001	40672053000	20	125	150	180	210			271	14.2		10 SAE 1-1/2" - 10c	1
	←→	MAS300001 <sup>2</sup>	0517482212	50	120	135	150	165	180	250	304	14.2		10 SAE 1-1/2" - 10c	8
	←→	MAS310001 <sup>2</sup>	0517482122	110	120	135	150	165	180	250	304	14.2		10 SAE 1-1/2" - 10c	9
	←→	MAS350001 <sup>2</sup>	0557482873	65	-	-	-	-	-	251	319	17.0		10 SAE 1-1/2" - 10c	11

<sup>1</sup> = Supplied with Peg Bolt

<sup>2</sup> = Supplied with Bracket Kit

## FRUEHAUF

TRAILER	←→	MSAS610003 <sup>1</sup>	AJB0743001	-	105	129	153	215			268	16.2	14.2	37 ANSI-B92.1	51
TRAILER AXLE	←→	MAS150005 <sup>2</sup>	CF351148	0	118	142	200				262	14.2		10 SAE 1-1/2" - 10c	5
	←→	MAS170001 <sup>2</sup>	AJB0092001	130	105	129	153	215			268	16.2	14.2	37 ANSI-B92.1	6
	←→	MAS320002 <sup>1</sup>	AJB0743001	130	105	129	153	215			268	16.2	14.2	37 ANSI-B92.1	10

<sup>1</sup> = Supplied with Bracket Kit

<sup>2</sup> = Supplied with Peg Bolt

## HENRED TRAILER

TRAILER	←→	MSAS610007 <sup>1</sup>		-	125	150					213	12.7		37 ANSI-B92.1	51
---------	----	-------------------------	--	---	-----	-----	--	--	--	--	-----	------	--	---------------	----

<sup>1</sup> = Supplied with Bracket Kit

## KÄSSBOHRER

TRAILER	←→	MAS150018 <sup>1</sup>	8238000835	110	120	150	180	250			304	14.2		37 DIN 5481	5
---------	----	------------------------	------------	-----	-----	-----	-----	-----	--	--	-----	------	--	-------------	---

<sup>1</sup> = Supplied with Peg Bolt

## MERITOR/ROR

STEER AXLE	←	MAS9280 <sup>1</sup>	21229280	145	125	150	180				271	14.2	-16	10 SAE 1-1/2" - 10c	2
	←	MAS9286 <sup>1</sup>	21229286	145	151	179	203				272	14.2	+38	10 SAE 1-1/2" - 10c	2
	←→	MAS9287 <sup>1</sup>	21229287	145	105	129	153	181	215		269	14.2		10 SAE 1-1/2" - 10c	2
	←→	MAS9289 <sup>1</sup>	21229289	130	105	125	140	155	180	250	305	14.2		10 SAE 1-1/2" - 10c	6
	→	MAS9281 <sup>1</sup>	21229281	145	125	150	180				272	14.2	+16	10 SAE 1-1/2" - 10c	2
	→	MAS9285 <sup>1</sup>	21229285	145	151	179	203				273	14.2	-38	10 SAE 1-1/2" - 10c	2
	TRAILER	←→	MSAS610002 <sup>2</sup>	21229249	-	115	127	140	153	205		260	14.2		10 SAE 1-1/2" - 10c
TRAILER AXLE	←	MAS9251 <sup>4</sup>	21229251	110	153	181	205				273	14.2	+38	10 SAE 1-1/2" - 10c	5
	←→	MAS9249 <sup>5</sup>	21229249	60	115	127	140	153	205		260	14.2		10 SAE 1-1/2" - 10c	7
	←→	MAS9290 <sup>6</sup>	21229290	130	127	141	153				211	14.2		10 SAE 1-1/2" - 10c	6
	→	MAS9250 <sup>4</sup>	21229250	110	151	179	203				273	14.2	-38	10 SAE 1-1/2" - 10c	5

<sup>1</sup> = Self Steer Axle

<sup>2</sup> = Supplied with Bracket Kit

<sup>3</sup> = Supplied with Peg Bolt

<sup>4</sup> = LM, TM

<sup>5</sup> = LM, TM, TA

<sup>6</sup> = TM

## PANAV AXLE

TRAILER	←→	MAS110013		73	150	175	200	225	250		304	14.2		20 DIN-5482	1
---------	----	-----------	--	----	-----	-----	-----	-----	-----	--	-----	------	--	-------------	---

## SAE

TRAILER AXLE	←→	MAS320005 <sup>1</sup>	4175024000	130	125	150	180	210	250		303	14.2		10 SAE 1-1/2" - 10c	10
--------------	----	------------------------	------------	-----	-----	-----	-----	-----	-----	--	-----	------	--	---------------------	----

<sup>1</sup> = Supplied with Bracket Kit

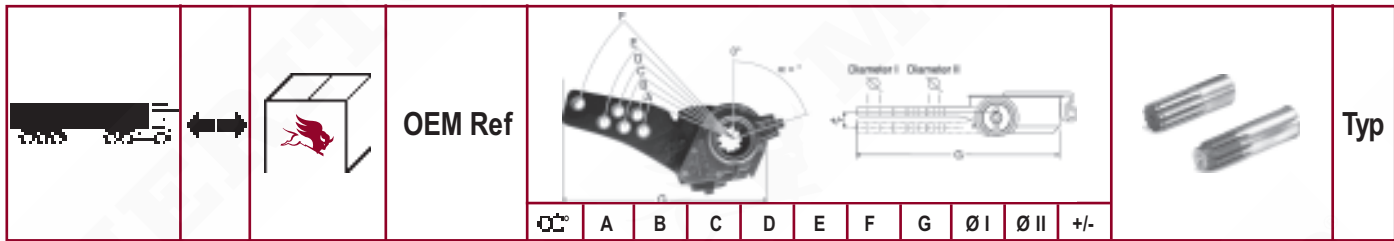

### SAF

STEER AXLE	←	MAS142503	4175014900	90	127	153	179				222	14.2		-25	10 SAE 1-1/2" - 10c	4
	←	MAS142504	4175013900	-2	127	152	178				222	14.2		-25	10 SAE 1-1/2" - 10c	4
	→	MAS142501	4175014000	-2	127	152	178				222	14.2		+25	10 SAE 1-1/2" - 10c	4
	→	MAS142502	4175015000	90	127	152	178				222	14.2		+25	10 SAE 1-1/2" - 10c	4
TRAILER	↔	MAS320006 <sup>1</sup>	4175024800	130	105	129	153	181	215		268	14.2			10 SAE 1-1/2" - 10c	22
	↔	MSAS610004 <sup>1</sup>	4175024900	-	105	125	140	155	180	250	304	14.2			10 SAE 1-1/2" - 10c	51
TRAILER AXLE	↔	MAS130001	4175014100	80	127	152	176	200			230	14.2			10 SAE 1-1/2" - 10c	3
	↔	MAS170002 <sup>2</sup>	4175008501	130	125	150	180	210	250		303	14.2			10 SAE 1-1/2" - 10c	6
	↔	MAS170003 <sup>2</sup>	4175024700	130	105	129	153				203	14.2			10 SAE 1-1/2" - 10c	6
	↔	MAS320004 <sup>1</sup>	4175024900	130	105	125	140	155	180	250	304	14.2			10 SAE 1-1/2" - 10c	10
	↔	MAS320005 <sup>1</sup>	4175024000	130	125	150	180	210	250		303	14.2			10 SAE 1-1/2" - 10c	10

<sup>1</sup> = Supplied with Bracket Kit

<sup>2</sup> = Supplied with Peg Bolt

### SMB

TRAILER	↔	MSAS610005 <sup>1</sup>	MO02416	-	105	129	153	215			268	16.2	14.2		10 SAE 1-1/2" - 10c	51
TRAILER AXLE	↔	MAS320003 <sup>1</sup>	MO02416	130	105	129	153	215			268	16.2	14.2		10 SAE 1-1/2" - 10c	10

<sup>1</sup> = Supplied with Bracket Kit

### TRAILOR

TRAILER	↔	MSAS610006 <sup>1</sup>	TOO17649Z	-	125	150	180	210			268	14.2			10 SAE 1-1/2" - 10c	51
TRAILER AXLE	↔	MAS320001 <sup>1</sup>	9002105	130	125	150	180	210			265	14.2			10 SAE 1-1/2" - 10c	10

<sup>1</sup> = Supplied with Bracket Kit

--	--	--	--	--	--	--	--	--	--	--	--	--	--	--	--	--

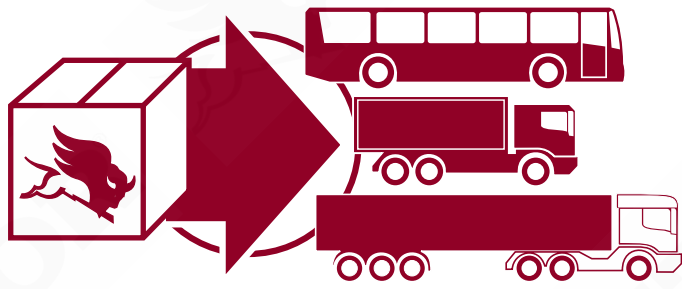



<b>MAS110001</b>	BPW ..... 40672053000 ..... 17
<b>MAS110003</b>	MERCEDES ..... 3574200538 ..... 12
<b>MAS110004</b>	MERCEDES ..... 6174200238 ..... 12
<b>MAS110005</b>	MERCEDES ..... 3074200338 ..... 12
<b>MAS110006</b>	LEYLAND ..... ACU8347 ..... 5
<b>MAS110007</b>	MERCEDES ..... 6524200238 ..... 12
<b>MAS110008</b>	MERCEDES ..... 3054202638 ..... 12
<b>MAS110009</b>	IVECO ..... 4692759 ..... 5
<b>MAS110010</b>	NEOPLAN ..... 080250000 ..... 12
<b>MAS110011</b>	MAN ..... 81506106194 ..... 5
<b>MAS110012</b>	MAN ..... 81506106193 ..... 12
<b>MAS110013</b>	PANAV AXLE ..... 17
<b>MAS110014</b>	VAN HOOL ..... 3177673 ..... 13
<b>MAS110015</b>	DAF ..... 390065 ..... 11
<b>MAS110016</b>	DAEWOO ..... 11
<b>MAS110017</b>	MERCEDES ..... 3934200038 ..... 12
<b>MAS110018</b>	RENAULT ..... 5010201995 ..... 12
<b>MAS110019</b>	RENAULT ..... 5010152965 ..... 12
<b>MAS110020</b>	IKARUS ..... 11
<b>MAS111701</b>	KAROSA ..... 11
<b>MAS111702</b>	KAROSA ..... 11
<b>MAS111801</b>	MERCEDES ..... 3574201338 ..... 12
<b>MAS111802</b>	MERCEDES ..... 3574201438 ..... 12
<b>MAS111803</b>	MAN ..... 81506106181 ..... 12
<b>MAS111804</b>	MAN ..... 81506106182 ..... 12
<b>MAS111805</b>	MERCEDES ..... 3574201538 ..... 12
<b>MAS111806</b>	MERCEDES ..... 3574201638 ..... 12
<b>MAS112501</b>	NEOPLAN ..... B510643 ..... 12
<b>MAS112502</b>	NEOPLAN ..... B510642 ..... 12

<b>MAS112503</b>	DENNIS ..... 656995-105 ..... 11
<b>MAS112504</b>	DENNIS ..... 656995-104 ..... 11
<b>MAS112901</b>	IVECO ..... 3231343 ..... 11
<b>MAS113501</b>	SCANIA ..... 394195 ..... 7
<b>MAS113502</b>	SCANIA ..... 394196 ..... 7
<b>MAS113801</b>	DAF ..... 361542 ..... 5
<b>MAS113802</b>	DAF ..... 361541 ..... 5
<b>MAS113803</b>	DAF ..... 289691 ..... 11
<b>MAS113804</b>	DAF ..... 289692 ..... 11
<b>MAS113805</b>	RENAULT ..... 5010056686 ..... 6
<b>MAS113806</b>	RENAULT ..... 5010056685 ..... 6
<b>MAS113807</b>	RENAULT ..... 5000791212 ..... 12
<b>MAS113808</b>	RENAULT ..... 5000791213 ..... 13
<b>MAS113809</b>	RENAULT ..... 5010260027 ..... 6
<b>MAS113810</b>	RENAULT ..... 5010260028 ..... 6
<b>MAS113811</b>	RENAULT ..... 5010216843 ..... 6
<b>MAS113812</b>	RENAULT ..... 5010216844 ..... 6
<b>MAS113813</b>	RENAULT ..... 5010098831 ..... 6
<b>MAS113814</b>	RENAULT ..... 5010098832 ..... 6
<b>MAS114001</b>	MAN ..... 81506106178 ..... 12
<b>MAS114002</b>	MAN ..... 81506106179 ..... 12
<b>MAS114501</b>	DAF ..... 0159589 ..... 5
<b>MAS114502</b>	DAF ..... 361543 ..... 5
<b>MAS114503</b>	MAN ..... 81506106188 ..... 12
<b>MAS114504</b>	MAN ..... 81506106187 ..... 12
<b>MAS115001</b>	SCANIA ..... 384418 ..... 13
<b>MAS115002</b>	SCANIA ..... 384417 ..... 13
<b>MAS115003</b>	SCANIA ..... 1112839 ..... 13
<b>MAS115004</b>	SCANIA ..... 1112840 ..... 13

<b>MAS115601</b>	MERCEDES ..... 3874200238 ..... 6
<b>MAS115602</b>	MERCEDES ..... 3874200338 ..... 6
<b>MAS115603</b>	MERCEDES ..... 3834200438 ..... 12
<b>MAS115604</b>	MERCEDES ..... 3834200538 ..... 12
<b>MAS115605</b>	MERCEDES ..... 3874200138 ..... 6
<b>MAS115606</b>	MERCEDES ..... 3874200038 ..... 6
<b>MAS115607</b>	MAN ..... 81506106176 ..... 5
<b>MAS115608</b>	MAN ..... 81506106177 ..... 5
<b>MAS115609</b>	RENAULT ..... 5010098862 ..... 6
<b>MAS115610</b>	RENAULT ..... 5010098863 ..... 6
<b>MAS115611</b>	RENAULT ..... 5010098860 ..... 6
<b>MAS115612</b>	RENAULT ..... 5010098861 ..... 6
<b>MAS115613</b>	DAF ..... 0159563 ..... 5
<b>MAS115614</b>	DAF ..... 0159564 ..... 5
<b>MAS116001</b>	MERCEDES ..... 6234200738 ..... 6
<b>MAS116002</b>	MERCEDES ..... 6234200638 ..... 6
<b>MAS116501</b>	SCANIA ..... 1358634 ..... 7 SCANIA ..... 1358634 ..... 13
<b>MAS116502</b>	SCANIA ..... 1358635 ..... 7 SCANIA ..... 1358635 ..... 13
<b>MAS117501</b>	DAF ..... 219860 ..... 5
<b>MAS117502</b>	DAF ..... 219859 ..... 5
<b>MAS123803</b>	RENAULT ..... 5000789894 ..... 12
<b>MAS123804</b>	RENAULT ..... 5000789895 ..... 13
<b>MAS125001</b>	IVECO ..... 3231273 ..... 11
<b>MAS125601</b>	MAN ..... 81506106211 ..... 5
<b>MAS125602</b>	MAN ..... 81506106210 ..... 5
<b>MAS125603</b>	RENAULT ..... 5010260117 ..... 6
<b>MAS125604</b>	RENAULT ..... 5010260118 ..... 6
<b>MAS125605</b>	RENAULT ..... 5010260116 ..... 6

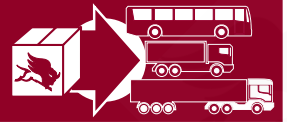

<b>MAS125606</b>
RENAULT ..... 5010260115 ..... 6
<b>MAS130001</b>
SAF ..... 4175014100 ..... 18
<b>MAS130002</b>
FODEN ..... 2700021000 ..... 5
<b>MAS130003</b>
FODEN ..... 2700020000 ..... 5
<b>MAS130004</b>
SCANIA ..... 1112831 ..... 7
SCANIA ..... 1112831 ..... 13
<b>MAS132501</b>
SCANIA ..... 082460300 ..... 7
SCANIA ..... 082460300 ..... 13
<b>MAS132502</b>
SCANIA ..... 1112834 ..... 7
SCANIA ..... 1112834 ..... 13
<b>MAS132901</b>
LEYLAND ..... ACU8344 ..... 5
<b>MAS132902</b>
LEYLAND ..... ACU8345 ..... 5
<b>MAS140001</b>
MAN ..... 81506106231 ..... 5
MAN ..... 81506106231 ..... 12
<b>MAS140002</b>
MERCEDES ..... 3014201138 ..... 12
<b>MAS140003</b>
MERCEDES ..... 3894200738 ..... 6
<b>MAS140004</b>
DENNIS ..... 611485 ..... 11
<b>MAS140005</b>
DAF ..... 282609 ..... 11
<b>MAS140006</b>
DAF ..... 284860 ..... 11
<b>MAS140007</b>
DENNIS ..... 651623 ..... 11
<b>MAS141201</b>
DAF ..... 1282111 ..... 5
<b>MAS141202</b>
DAF ..... 1282112 ..... 5
<b>MAS141301</b>
DAF ..... 0740321 ..... 11
<b>MAS141302</b>
DAF ..... 0740322 ..... 11
<b>MAS141501</b>
MERCEDES ..... 3574201138 ..... 12
<b>MAS141502</b>
MERCEDES ..... 3574201238 ..... 12
<b>MAS141503</b>
MERCEDES ..... 3074200138 ..... 12
<b>MAS141504</b>
MERCEDES ..... 3074200238 ..... 12
<b>MAS141801</b>
MAN ..... 81506106212 ..... 5
<b>MAS141802</b>
MAN ..... 81506106213 ..... 5
<b>MAS141803</b>
MERCEDES ..... 3894200338 ..... 6

<b>MAS141804</b>
MERCEDES ..... 3894200438 ..... 6
<b>MAS142501</b>
SAF ..... 4175014000 ..... 18
<b>MAS142502</b>
SAF ..... 4175015000 ..... 18
<b>MAS142503</b>
SAF ..... 4175014900 ..... 18
<b>MAS142504</b>
SAF ..... 4175013900 ..... 18
<b>MAS143701</b>
MERCEDES ..... 6524200138 ..... 6
<b>MAS143702</b>
MERCEDES ..... 6524200038 ..... 6
<b>MAS143703</b>
MERCEDES ..... 6194200138 ..... 6
<b>MAS143704</b>
MERCEDES ..... 6194200038 ..... 6
<b>MAS143801</b>
DAF ..... 0159556 ..... 5
<b>MAS143802</b>
DAF ..... 0159557 ..... 5
<b>MAS143803</b>
DAF ..... 281090 ..... 5
<b>MAS143804</b>
DAF ..... 281091 ..... 5
<b>MAS143805</b>
DENNIS ..... 656007-30 ..... 11
<b>MAS143806</b>
DENNIS ..... 656007-29 ..... 11
<b>MAS143807</b>
DAF ..... 0092419 ..... 5
<b>MAS143808</b>
DAF ..... 0092420 ..... 5
<b>MAS146001</b>
DAF ..... 1263485 ..... 5
<b>MAS146002</b>
DAF ..... 1263486 ..... 5
<b>MAS146003</b>
DAF ..... 0755616 ..... 5
<b>MAS146004</b>
DAF ..... 0755617 ..... 5
<b>MAS150005</b>
FRUEHAUF ..... CF351148 ..... 17
<b>MAS150006</b>
VOLVO ..... 1135004 ..... 13
<b>MAS150007</b>
LEYLAND ..... ACU3629 ..... 11
<b>MAS150008</b>
DENNIS ..... 611484 ..... 11
<b>MAS150009</b>
LEYLAND ..... 10901188 ..... 11
<b>MAS150010</b>
DENNIS ..... 651777 ..... 11
<b>MAS150011</b>
LEYLAND ..... BCU5769 ..... 11
<b>MAS150012</b>
HINO ..... 474801801 ..... 5

<b>MAS150013</b>
FODEN ..... 7684F ..... 5
<b>MAS150014</b>
DENNIS ..... 651626 ..... 11
<b>MAS150015</b>
OPTARE ..... L2220055 ..... 12
<b>MAS150016</b>
FODEN ..... 270048000 ..... 5
<b>MAS150017</b>
FODEN ..... 2700040000 ..... 5
<b>MAS150018</b>
KÄSSBOHRER ..... 8238000835 ..... 17
<b>MAS150019</b>
LIAZ ..... 1195461 ..... 13
<b>MAS151501</b>
VOLVO ..... 1195461 ..... 13
<b>MAS151502</b>
VOLVO ..... 1195462 ..... 13
<b>MAS151503</b>
VOLVO ..... 1136433 ..... 13
<b>MAS151504</b>
VOLVO ..... 1136432 ..... 13
<b>MAS151505</b>
VOLVO ..... 1197966 ..... 13
<b>MAS151506</b>
VOLVO ..... 1197965 ..... 13
<b>MAS151601</b>
LEYLAND ..... BCU5767 ..... 11
<b>MAS151602</b>
LEYLAND ..... BCU5768 ..... 11
<b>MAS151603</b>
LEYLAND ..... ACU3628 ..... 11
<b>MAS151604</b>
LEYLAND ..... ACU3627 ..... 11
<b>MAS151605</b>
LEYLAND ..... 10889962 ..... 11
<b>MAS151606</b>
LEYLAND ..... 10889963 ..... 11
<b>MAS152201</b>
KAROSA ..... 5000785204 ..... 13
<b>MAS152202</b>
KAROSA ..... 5000785203 ..... 12
<b>MAS152203</b>
RENAULT ..... 5000785204 ..... 13
<b>MAS152204</b>
RENAULT ..... 5000785203 ..... 12
<b>MAS152301</b>
RENAULT ..... 5000785206 ..... 13
<b>MAS152302</b>
RENAULT ..... 5000785205 ..... 13
<b>MAS152901</b>
BPW ..... 0517454410 ..... 17
<b>MAS152902</b>
BATTAGLINO ..... 0517454420 ..... 17
<b>MAS152903</b>
BPW ..... 0517454420 ..... 17
<b>MAS152904</b>
BATTAGLINO ..... 0517454420 ..... 17



<b>MAS152905</b>	VOLVO ..... 3136427 ..... 13
<b>MAS152906</b>	VOLVO ..... 3136426 ..... 13
<b>MAS153803</b>	MCW ..... F4105F ..... 12
<b>MAS153804</b>	MCW ..... F4106F ..... 12
<b>MAS153805</b>	HINO ..... 474801190 ..... 5
<b>MAS153806</b>	HINO ..... 474801180 ..... 5
<b>MAS153807</b>	KÄSSBOHRER ..... 82850002130 ..... 11
<b>MAS153808</b>	KÄSSBOHRER ..... 82850002140 ..... 11
<b>MAS153809</b>	KÄSSBOHRER ..... 82850000890 ..... 11
<b>MAS153810</b>	KÄSSBOHRER ..... 82850000900 ..... 11
<b>MAS153811</b>	DAF ..... R9641F ..... 11
<b>MAS153812</b>	DAF ..... R9640F ..... 11
<b>MAS160001</b>	VOLVO ..... 1196321 ..... 13
<b>MAS160002</b>	VOLVO ..... 1196322 ..... 13
<b>MAS163801</b>	SCANIA ..... 218834 ..... 13
<b>MAS163802</b>	SCANIA ..... 218833 ..... 13
<b>MAS164401</b>	VOLVO ..... 3193402 ..... 13
<b>MAS164402</b>	VOLVO ..... 3193403 ..... 13
<b>MAS165001</b>	VOLVO ..... 3193400 ..... 13
<b>MAS165002</b>	VOLVO ..... 3193401 ..... 13
<b>MAS170001</b>	FRUEHAUF ..... AJB0092001 ..... 17
<b>MAS170002</b>	SAF ..... 4175008501 ..... 18
<b>MAS170003</b>	SAF ..... 4175024700 ..... 18
<b>MAS281501</b>	MAN ..... 81506106170 ..... 12
<b>MAS281502</b>	MAN ..... 81506106169 ..... 12
<b>MAS285901</b>	SAURER ..... ..... 6
<b>MAS285902</b>	SAURER ..... ..... 6
<b>MAS300001</b>	BPW ..... 0517482212 ..... 17
<b>MAS310001</b>	BPW ..... 0517482122 ..... 17

<b>MAS320001</b>	TRAILOR ..... 9002105 ..... 18
<b>MAS320002</b>	FRUEHAUF ..... AJB0743001 ..... 17
<b>MAS320003</b>	SMB ..... MO02416 ..... 18
<b>MAS320004</b>	SAF ..... 4175024900 ..... 18
<b>MAS320005</b>	SAE ..... 4175024000 ..... 17
	SAF ..... 4175024000 ..... 18
<b>MAS320006</b>	SAF ..... 4175024800 ..... 18
<b>MAS350001</b>	BPW ..... 0557482873 ..... 17
<b>MAS9249</b>	MERITOR/R OR ..... 21229249 ..... 17
<b>MAS9250</b>	MERITOR/R OR ..... 21229250 ..... 17
<b>MAS9251</b>	MERITOR/R OR ..... 21229251 ..... 17
<b>MAS9280</b>	MERITOR/R OR ..... 21229280 ..... 17
<b>MAS9281</b>	MERITOR/R OR ..... 21229281 ..... 17
<b>MAS9285</b>	MERITOR/R OR ..... 21229285 ..... 17
<b>MAS9286</b>	MERITOR/R OR ..... 21229286 ..... 17
<b>MAS9287</b>	MERITOR/R OR ..... 21229287 ..... 17
<b>MAS9289</b>	MERITOR/R OR ..... 21229289 ..... 17
<b>MAS9290</b>	MERITOR/R OR ..... 21229290 ..... 17
<b>MSAS114201</b>	MERCEDES ..... 9454200538 ..... 6
<b>MSAS114202</b>	MERCEDES ..... 9454200638 ..... 6
<b>MSAS115601</b>	MERCEDES ..... 9454200238 ..... 6
<b>MSAS115602</b>	MERCEDES ..... 9454200338 ..... 6
<b>MSAS115603</b>	MERCEDES ..... 9454200838 ..... 6
<b>MSAS115604</b>	MERCEDES ..... 9454200738 ..... 6
<b>MSAS115605</b>	MERCEDES ..... 9454200438 ..... 6
<b>MSAS115606</b>	MERCEDES ..... 9454200938 ..... 6
<b>MSAS115607</b>	MAN ..... 81506106263 ..... 5
<b>MSAS115608</b>	MAN ..... 81506106266 ..... 5
<b>MSAS115609</b>	MAN ..... 81506106261 ..... 5

<b>MSAS115610</b>	MAN ..... 81506106262 ..... 5
<b>MSAS143701</b>	MERCEDES ..... 9454200038 ..... 6
<b>MSAS143702</b>	MERCEDES ..... 9454200138 ..... 6
<b>MSAS610001</b>	BPW ..... 0517482212 ..... 17
<b>MSAS610002</b>	MERITOR/R OR ..... 21229249 ..... 17
<b>MSAS610003</b>	FRUEHAUF ..... AJB0743001 ..... 17
<b>MSAS610004</b>	SAF ..... 4175024900 ..... 18
<b>MSAS610005</b>	SMB ..... MO02416 ..... 18
<b>MSAS610006</b>	TRAILOR ..... TOO17649Z ..... 18
<b>MSAS610007</b>	HENRED TRAILER ..... ..... 17

On trailer applications, Automatic Slack Adjusters which use a 'saddle type' bracket are attached to the mating anchor bracket without using an additional pin or bolt. The Meritor slack adjuster utilises an alternative design 'fast fit' bracket and this also fits to the mating anchor bracket without the use of a pin or bolt.

Because Meritor 'fast fit' control arms cannot be attached to 'saddle type' anchor brackets (and vice versa), Meritor Automatic slack adjusters for trailers fitted with the 'fast fit' control arm, are always supplied with new 'fast fit' anchor brackets.

In all other respects, the construction of the Meritor Automatic Slack adjuster is the same as that of comparable product. That construction is illustrated in the exploded view below.



MERITOR FAST FIT BRACKET



MERITOR BRACKET FITTED



SADDLE TYPE BRACKET



SADDLE TYPE BRACKET FITTED

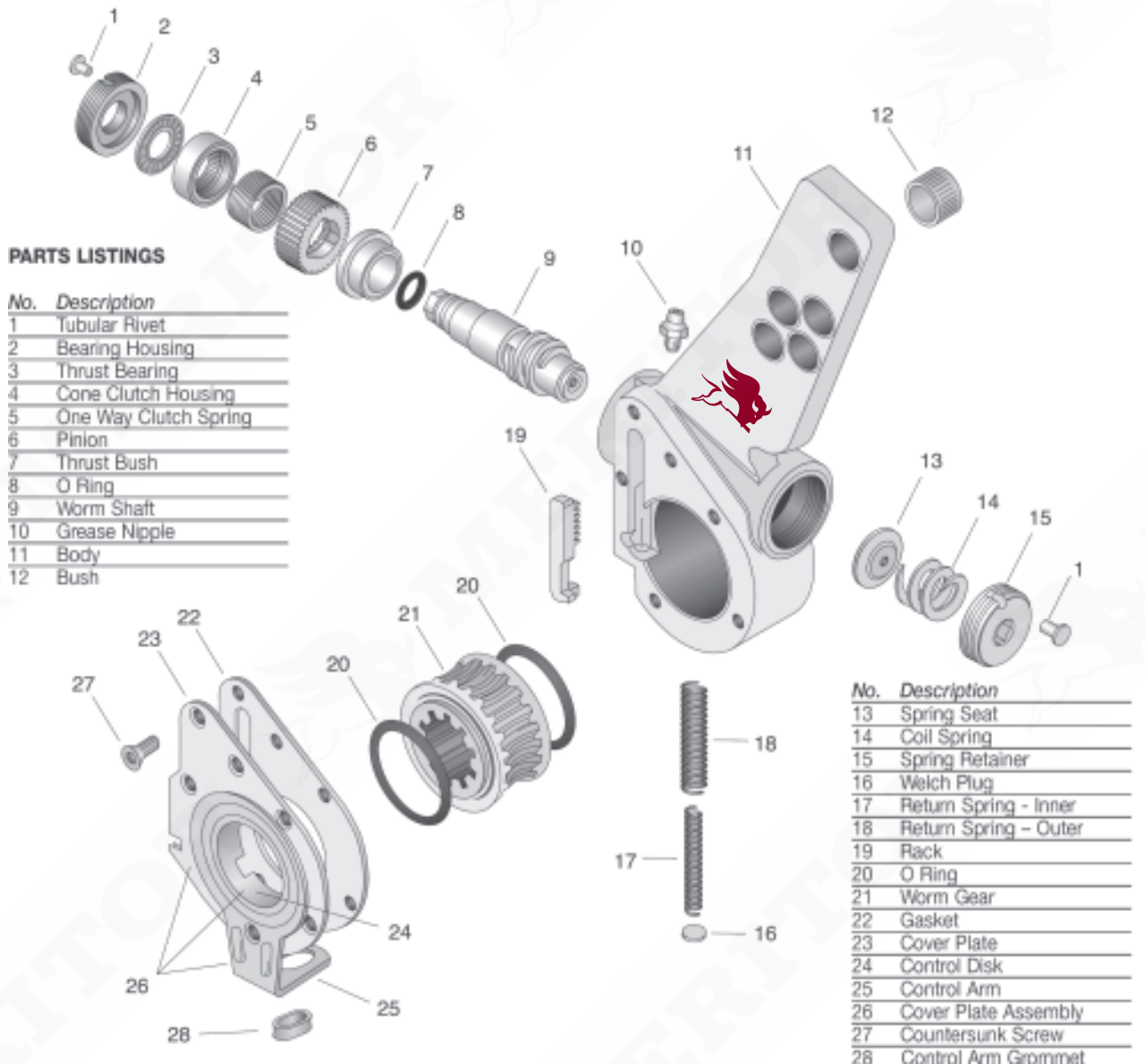



## Leviers automatiques de freins Meritor

Pour les applications avec remorques, les leviers automatiques de freins utilisant un support de type creux s'adaptent au support de fixation correspondant sans autres goupilles ou boulons. Le levier automatique de freins Meritor utilise un support "fast-fit" de conception alternative qui s'adapte lui aussi au support de fixation correspondant sans goupille ou boulon.

Comme les bras de suspension "fast-fit" de Meritor ne s'adaptent pas aux supports de fixation de type creux (et vice versa), les leviers automatiques de freins Meritor pour remorques avec bras de suspension "fast-fit" sont toujours fournis avec de nouveaux supports de fixation "fast-fit".

Hormis ce détail, la construction des leviers automatiques de freins Meritor est identique à celle d'un produit équivalent. Cette construction est illustrée ci-dessous en vue éclatée.



SUPPORT FAST-FIT MERITOR



SUPPORT MERITOR MONTE



SUPPORT DE TYPE CREUX



SUPPORT DE TYPE CREUX MONTE

### LISTE DES PIECES

N°	Description
1	Rivet tubulaire
2	Logement de palier
3	Palier de butée
4	Carter d'embrayage à cône
5	Ressort d'embrayage unidirectionnel
6	Pignon
7	Bague d'appui
8	Joint torique
9	Arbre de vis sans fin
10	Embout de graissage
11	Corps
12	Bague

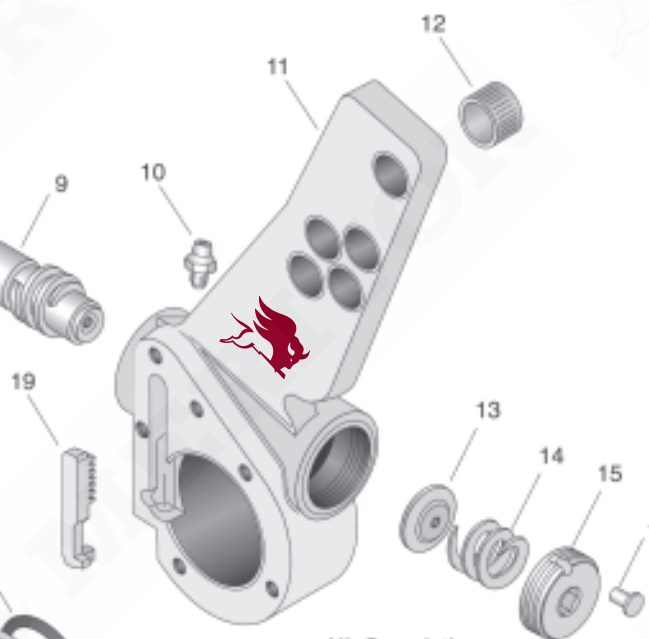
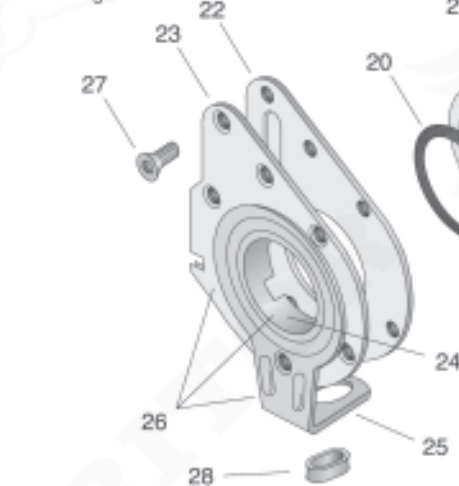

N°	Description
13	Siège de ressort
14	Ressort hélicoïdal
15	Arrêt de ressort
16	Bouchon expansible
17	Ressort de rappel intérieur
18	Ressort de rappel extérieur
19	Crémaillère
20	Joint torique
21	Roue à vis sans fin
22	Joint
23	Couvercle
24	Disque de contrôle
25	Bras de suspension
26	Ensemble couvercle
27	Vis à tête fraisée
28	Rondelle isolante, bras de suspension

Bei Anhänger Anwendungen sind automatische Gestängesteller, welche einen "sattelartigen" Bügel verwenden, am Anschluss-Ankerbügel befestigt. Ohne Verwendung eines zusätzlichen Bolzen oder Stifts. Der Meritor Gestängesteller verwendet ein alternatives Design, einen "Schnellmontage" Bügel, der ebenfalls am Anschluss-Ankerbügel angebracht ist, ohne Verwendung eines Bolzen oder Stifts.



MERITOR SCHNELLMONTAGE BÜGEL



MERITOR MONTIERTER BÜGEL

Da Meritor "Schnellmontage" Kontrollarme nicht an "sattelartige" Ankerbügel angeschlossen werden können (und umgekehrt), werden Meritor automatische Gestängesteller für Anhänger, die mit dem "Schnellmontage" Kontrollarm ausgestattet sind, immer mit dem neuen "Schnellmontage" Ankerbügel geliefert. In allen anderen Belangen ist die Konstruktion des Meritor automatischen Gestängestellers die selbe wie vergleichbare Produkte. Diese Konstruktion ist in der Explosionszeichnung unten dargestellt.



SATTELARTIGER BÜGEL



SATTELARTIGER BÜGEL MONTIERT

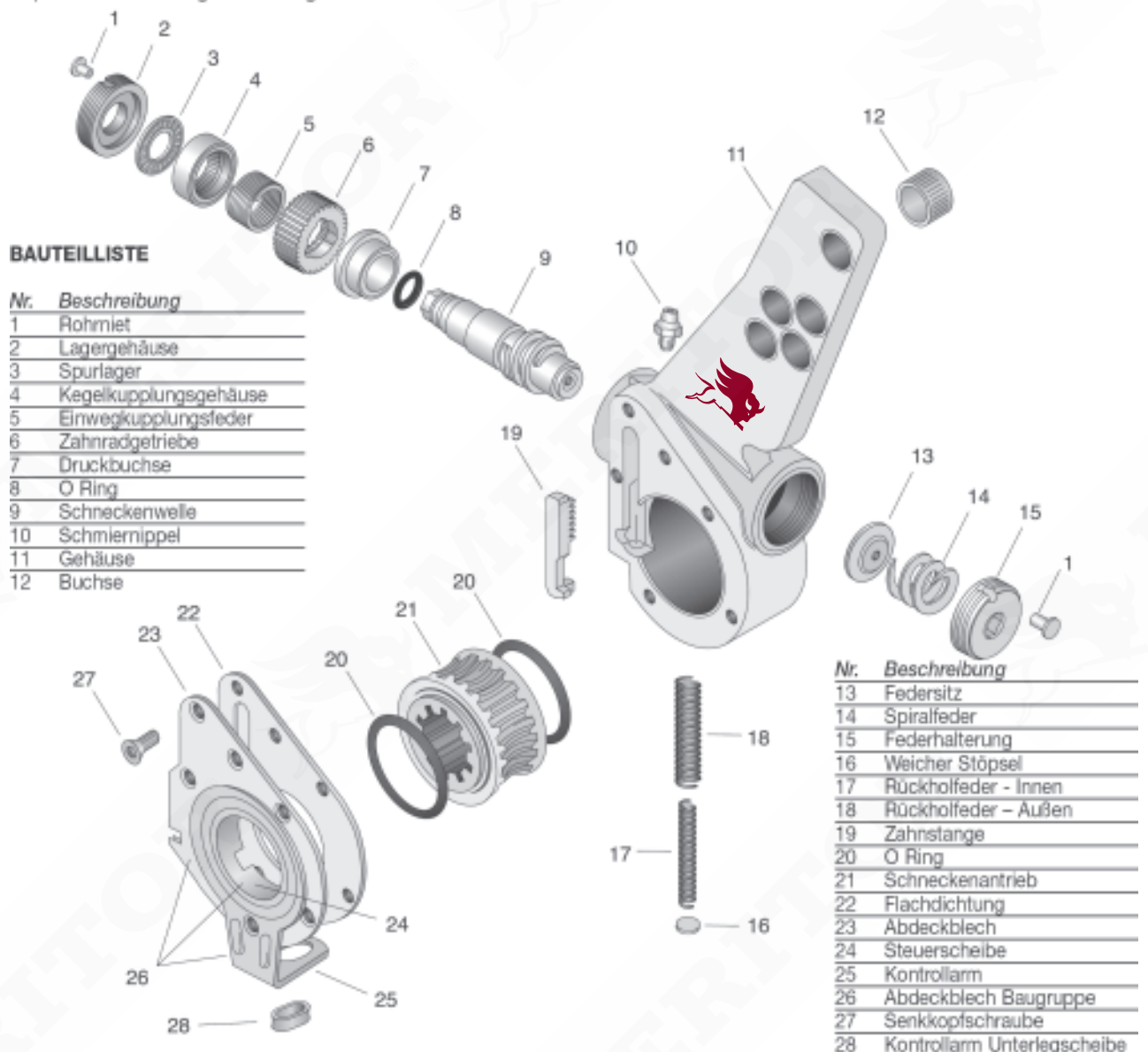

## Dispositivi di regolazione del gioco Meritor

Nelle applicazioni su rimorchio, i dispositivi automatici di regolazione del gioco che utilizzano una staffa del tipo a sella sono collegati alla staffa di ancoraggio di accoppiamento senza l'utilizzo di perni o bulloni aggiuntivi. Il dispositivo di regolazione del gioco Meritor impiega una staffa alternativa ad accoppiamento rapido, anch'essa collegata alla staffa di ancoraggio di accoppiamento senza richiedere l'utilizzo di perni o bulloni aggiuntivi.



STAFFA DI ACCOPIAMENTO RAPIDO MERITOR



STAFFA MERITOR MONTATA

Poiché i bracci di controllo ad accoppiamento rapido Meritor non possono essere collegati alle staffe di ancoraggio del tipo a sella (e viceversa), i dispositivi automatici di regolazione del gioco Meritor per i rimorchi dotati di braccio di controllo ad accoppiamento rapido vengono sempre forniti con delle nuove staffe di ancoraggio ad accoppiamento rapido.

In tutti gli altri casi, la configurazione del dispositivo automatico di regolazione del gioco Meritor è la stessa riscontrabile in prodotti equivalenti. Tale configurazione viene illustrata nello spaccato riportato di seguito.



STAFFA DEL TIPO A SELLA



STAFFA DEL TIPO A SELLA MONTATA

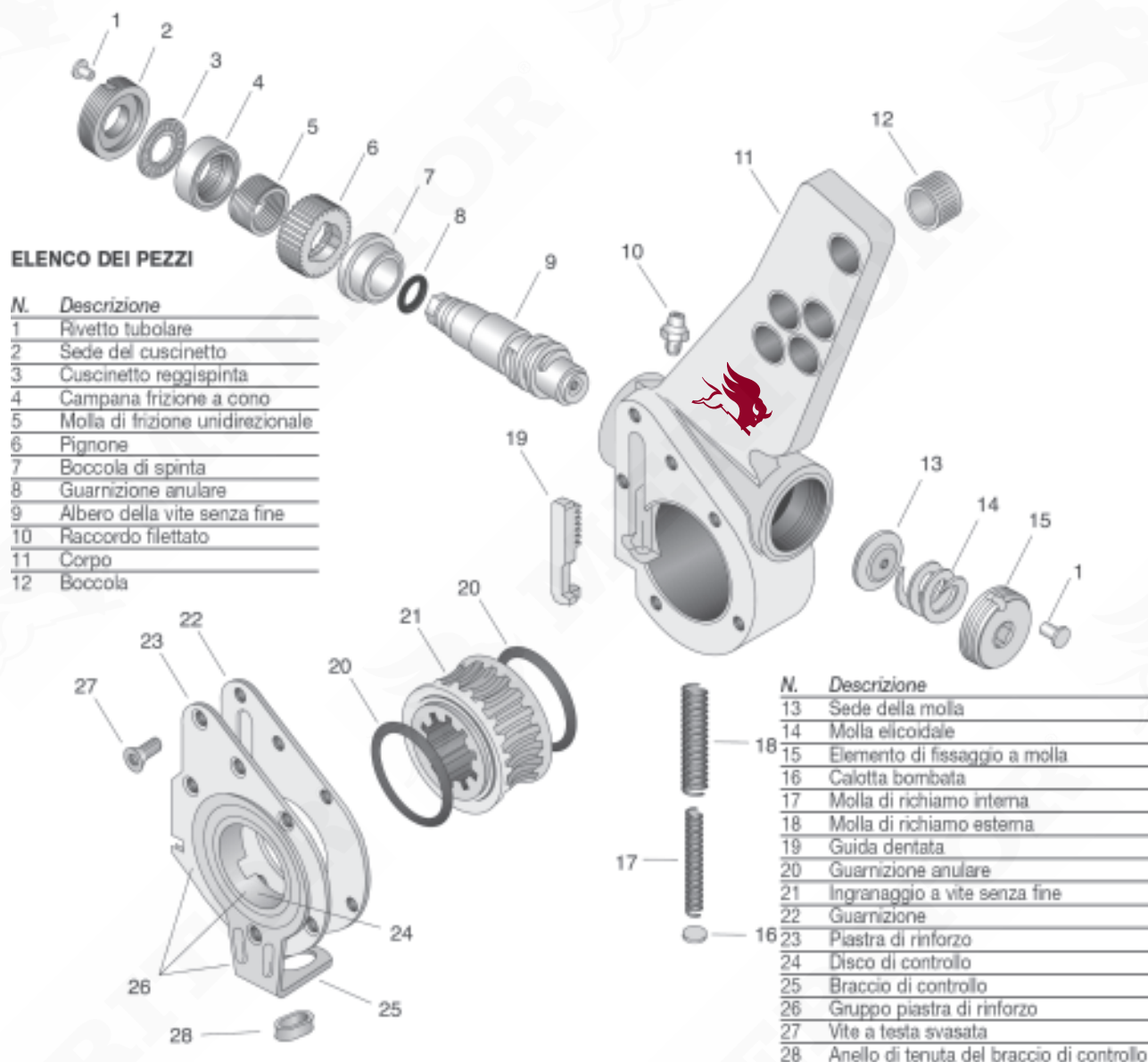

### ELENCO DEI PEZZI

N.	Descrizione
1	Rivetto tubolare
2	Sede del cuscinetto
3	Cuscinetto reggispira
4	Campana frizione a cono
5	Molla di frizione unidirezionale
6	Pignone
7	Boccola di spinta
8	Guarnizione anulare
9	Albero della vite senza fine
10	Raccordo filettato
11	Corpo
12	Boccola

N.	Descrizione
13	Sede della molla
14	Molla elicoidale
15	Elemento di fissaggio a molla
16	Calotta bombata
17	Molla di richiamo interna
18	Molla di richiamo esterna
19	Guida dentata
20	Guarnizione anulare
21	Ingranaggio a vite senza fine
22	Guarnizione
23	Piastra di rinforzo
24	Disco di controllo
25	Braccio di controllo
26	Gruppo piastra di rinforzo
27	Vite a testa svasata
28	Anello di tenuta del braccio di controllo

Voor aanhangwagen toepassingen worden automatische remstellers met een "zadeltype" plaat zonder het gebruik van een aanvullende pen of bout aan de corresponderende ankerplaat bevestigd. De remsteller van Meritor gebruikt een alternatief ontworpen "snelmontage" plaat en deze kan ook zonder het gebruik van een pen of bout aan de passende ankerplaat worden bevestigd.

Omdat "snelmontage" bedieningsarmen van Meritor niet aan "zadeltype" ankerplaten (en vice versa) worden bevestigd, worden de automatische remstellers voor aanhangwagens van Meritor voorzien van de "snelmontage" bedieningsarm altijd met nieuwe "snelmontage" ankerplaten geleverd. In alle andere opzichten is de bouw van de automatische remsteller van Meritor hetzelfde als de bouw van vergelijkbare producten. De constructie wordt in het pofbeeld hieronder weergegeven.



MERITOR SNELMONTAGE PLAAT

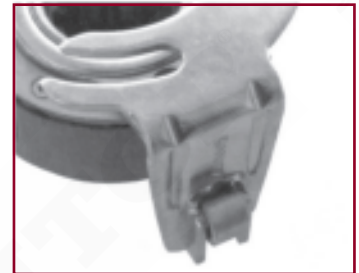

GEMONTEERDE MERITOR PLAAT



ZADELTYPE PLAAT



GEMONTEERDE ZADELTYPE PLAAT

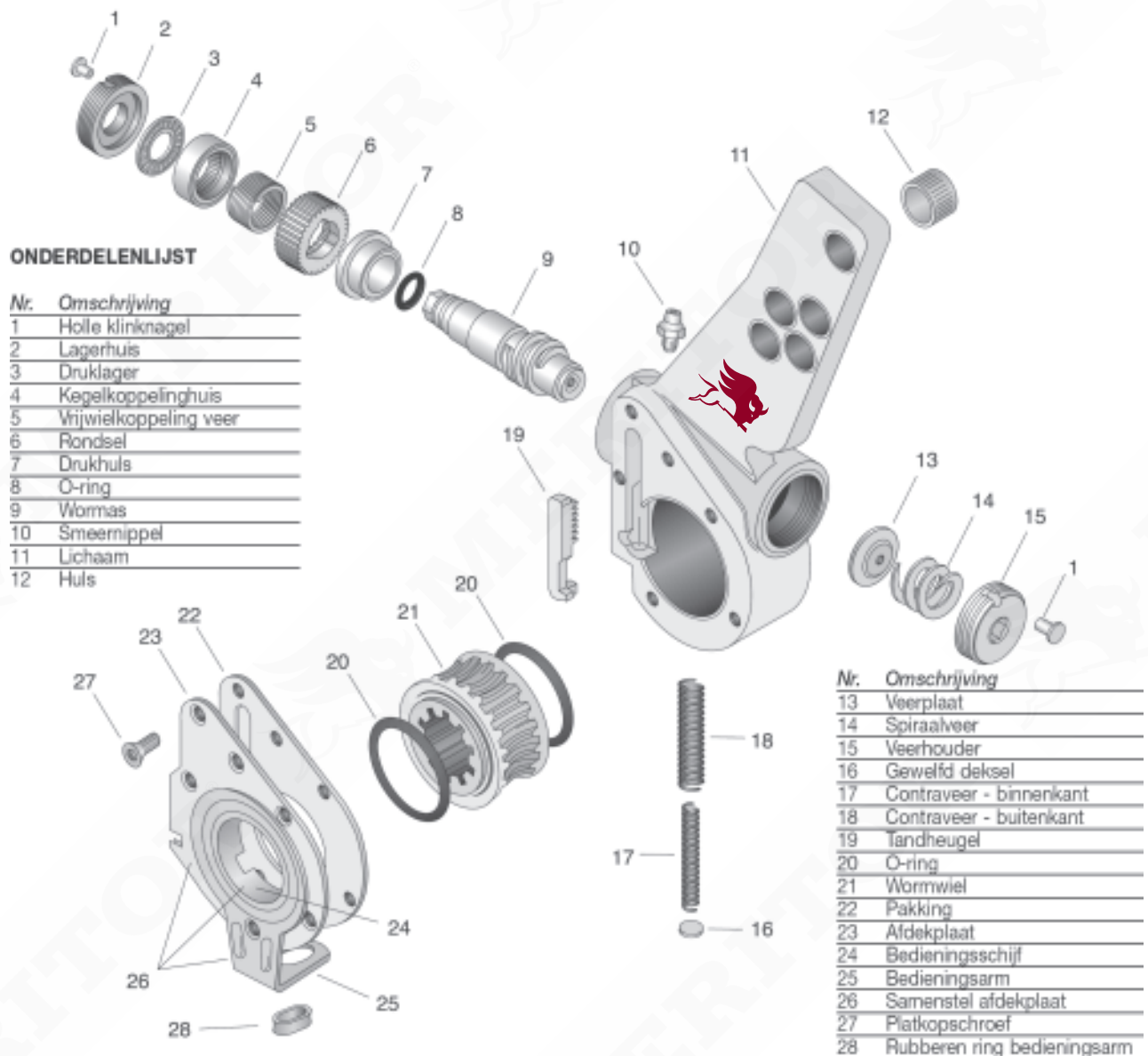

## Palancas automáticas de freno Meritor

En aplicaciones para remolques, las palancas automáticas de freno que utilizan un soporte de tipo brida se instalan en el soporte del anclaje de acoplamiento sin utilizar pasadores ni pernos adicionales. Las palancas automáticas de freno Meritor utilizan el soporte con diseño alternativo de "instalación rápida", el cual también se instala en el soporte del anclaje de acoplamiento sin utilizar pasadores ni pernos adicionales.

Debido a que los brazos de control de "instalación rápida" de Meritor no pueden instalarse en soportes de anclaje de tipo brida (ni viceversa), las palancas automáticas de freno Meritor para remolques equipados con el brazo de control de "instalación rápida" se suministran siempre con los nuevos soportes de anclaje de "instalación rápida". En el resto de los aspectos, el diseño de las palancas automáticas de freno Meritor es el mismo que el de los productos equivalentes. Dicho diseño queda ilustrado en la siguiente vista esquemática.



SOPORTE DE INSTALACIÓN RÁPIDA MERITOR



SOPORTE MERITOR INSTALADO



SOPORTE DE TIPO BRIDA



SOPORTE DE TIPO BRIDA INSTALADO

### RELACIÓN DE PIEZAS

#### Nº Descripción

1	Remache tubular
2	Alojamiento del cojinete
3	Cojinete de empuje
4	Alojamiento del embrague de cono
5	Muelle del embrague unidireccional
6	Piñón
7	Casquillo de empuje
8	Junta tórica
9	Eje sin fin
10	Engrasador
11	Carrocería
12	Casquillo

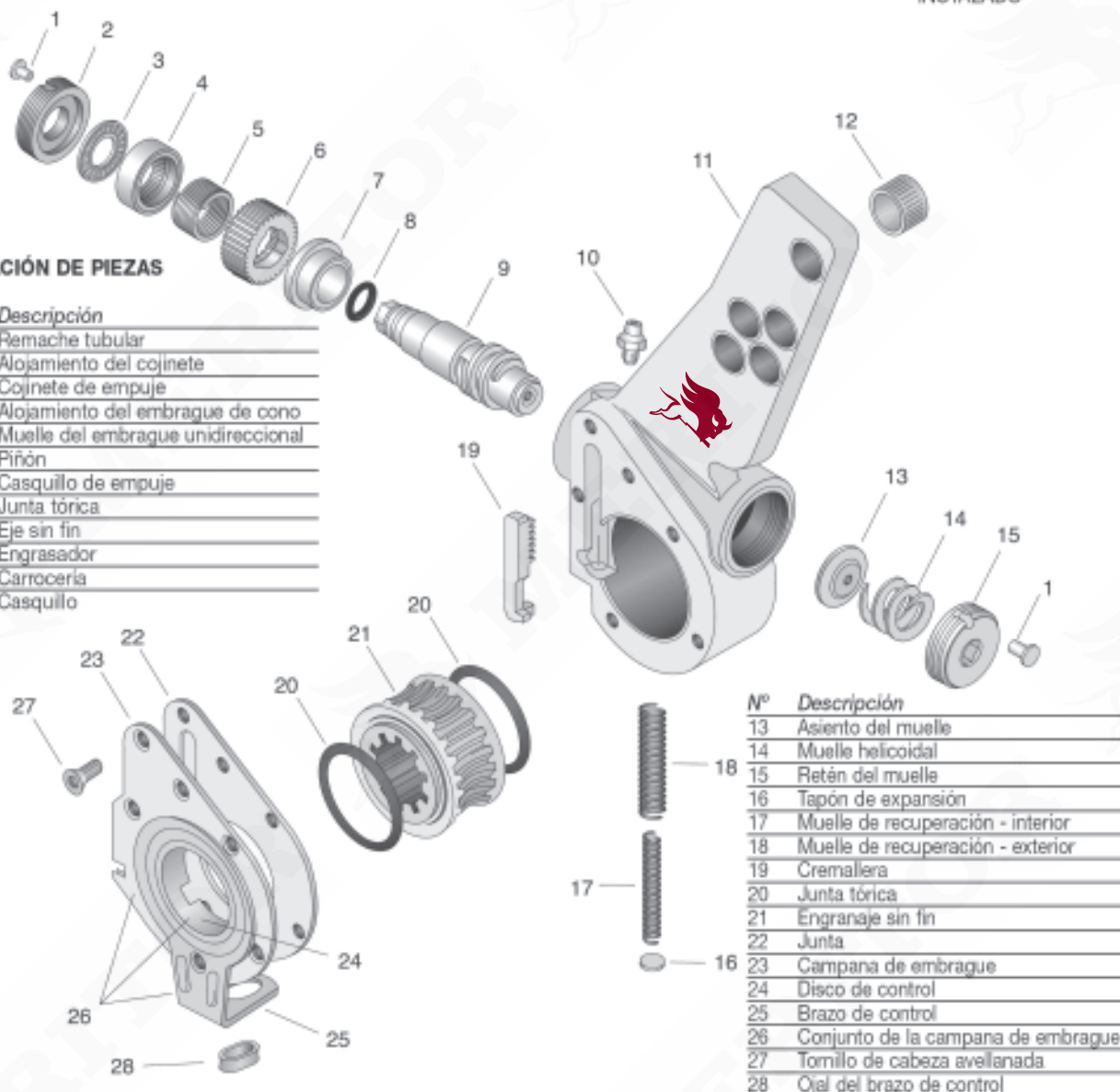

#### Nº Descripción

13	Asiento del muelle
14	Muelle helicoidal
15	Retén del muelle
16	Tapón de expansión
17	Muelle de recuperación - interior
18	Muelle de recuperación - exterior
19	Cremallera
20	Junta tórica
21	Engranaje sin fin
22	Junta
23	Campana de embrague
24	Disco de control
25	Brazo de control
26	Conjunto de la campana de embrague
27	Tomillo de cabeza avellanada
28	Ojal del brazo de control

W zastosowaniach transportowych automatyczne dźwignie rozpieraka, które wykorzystują wsporniki typu "siodłowego" są montowane na wsporniku kotwy bez użycia dodatkowych śrub lub sworzni. Dźwignia Meritor wykorzystuje alternatywną konstrukcję wspornika "fast fit", która umożliwia montaż kotwy do wspornika bez użycia śruby lub sworzni.

Ponieważ ramiona "fast fit" Meritor nie mogą być instalowane na "siodłowych" wspornikach kotew (i odwrotnie), automatyczne dźwignie rozpieraka Meritor wyposażone w ramię "fast fit" zawsze zawierają nowe wsporniki kotew "fast fit".  
We wszystkich innych aspektach konstrukcja dźwigni Meritor nie różni się od reszty porównywalnych produktów. Konstrukcja jest przedstawiona na poniższym rysunku.



WSPORNIK MERITOR FAST FIT



DOPASOWANY WSPORNIK MERITOR



WSPORNIK TYPU SIODŁOWEGO



DOPASOWANY WSPORNIK TYPU SIODŁOWEGO

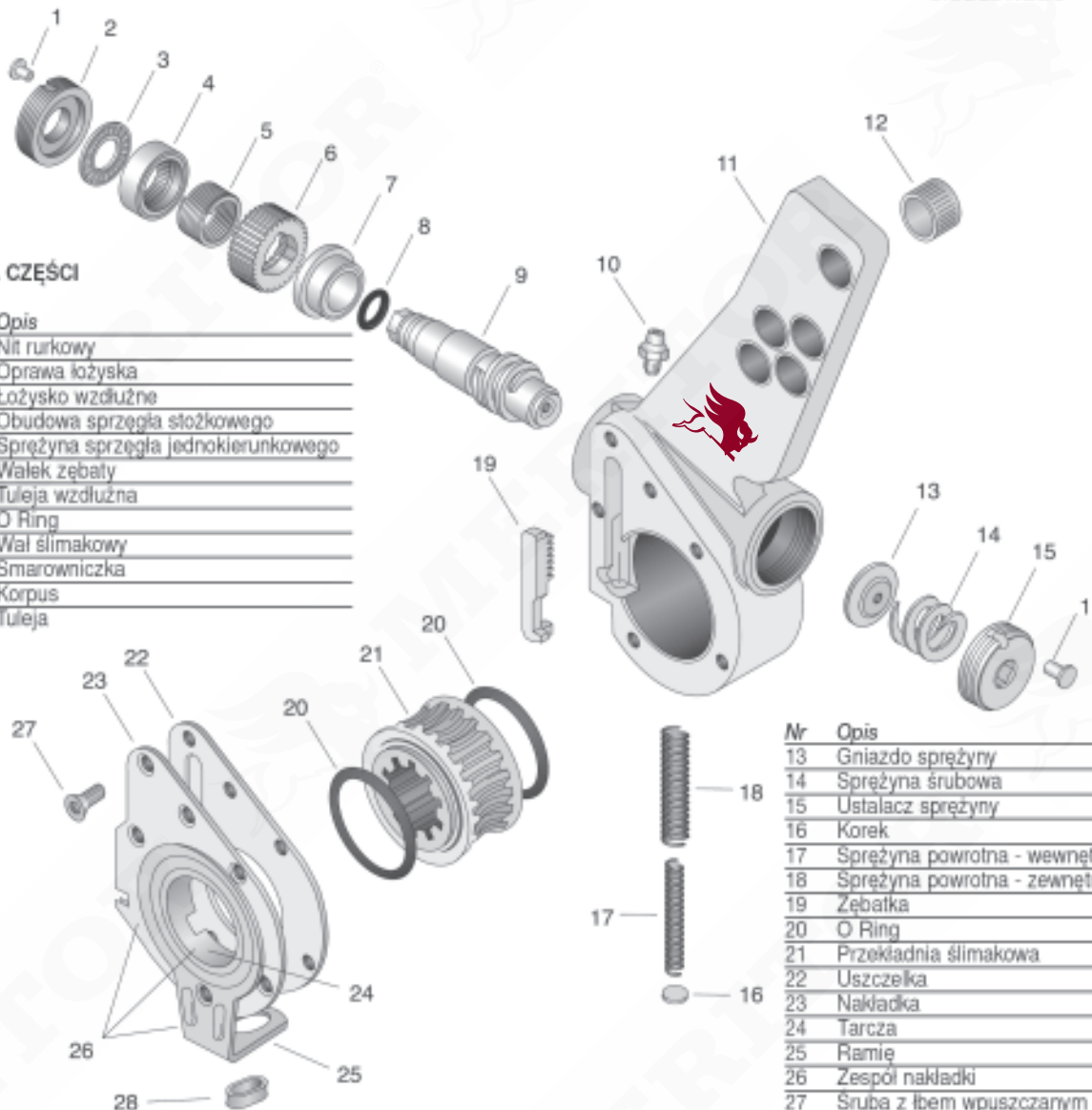

## LISTA CZĘŚCI

Nr	Opis
1	Nit rurkowy
2	Oprawa łożyska
3	Łożysko wzdłużne
4	Obudowa sprzęgła siodłowego
5	Sprężyna sprzęgła jednokierunkowego
6	Walek zębata
7	Tuleja wzdłużna
8	O Ring
9	Wal ślimakowy
10	Smarownicza
11	Korpus
12	Tuleja

Nr	Opis
13	Gniazdo sprężyny
14	Sprężyna śrubowa
15	Ustalacz sprężyny
16	Korek
17	Sprężyna powrotna - wewnętrzna
18	Sprężyna powrotna - zewnętrzna
19	Zębata
20	O Ring
21	Przekładnia ślimakowa
22	Uszczelka
23	Nakładka
24	Tarcza
25	Ramię
26	Zespół nakładki
27	Śruba z łbem wpuszczanym
28	Przelotka ramienia

# Стягивающие муфты Meritor

При применении в прицепах автоматические стягивающие муфты, которые используют седловидный кронштейн, прикрепляются к сопряженному анкерному кронштейну без применения дополнительного штифта или болта. Стягивающие муфты Meritor применяют "быстроразъемные" кронштейны альтернативной конструкции, что также позволяет прикрепляться к сопряженному анкерному кронштейну без использования дополнительного штифта или болта.

Так как "быстроразъемные" рукоятки управления Meritor не могут крепиться к анкерным кронштейнам седловидного типа (и наоборот), автоматические стягивающие муфты Meritor для прицепов, установленные с помощью "быстроразъемных" рукояток управления, всегда поставляются с новыми "быстроразъемными" анкерными кронштейнами. Во всех других отношениях конструкция автоматических стягивающих муфт Meritor аналогична сопоставимым изделиям. Данная конструкция проиллюстрирована на объемном графике ниже.



БЫСТРОРАЗЪЕМНЫЙ  
КРОНШТЕЙН MERITOR



УСТАНОВЛЕННЫЙ КРОНШТЕЙН  
MERITOR



СЕДЛОВИДНЫЙ КРОНШТЕЙН



УСТАНОВЛЕННЫЙ  
СЕДЛОВИДНЫЙ КРОНШТЕЙН

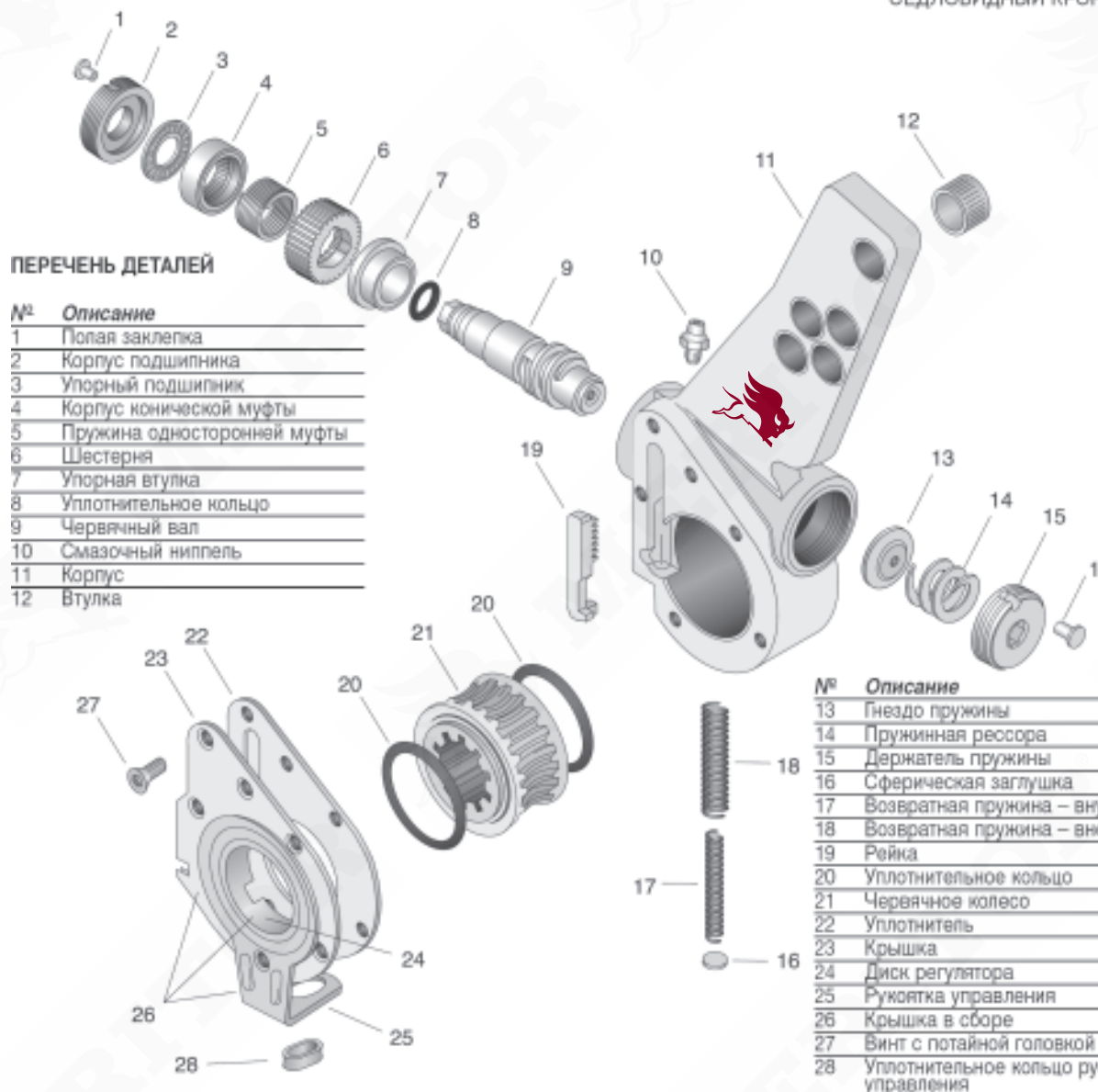

## ПЕРЕЧЕНЬ ДЕТАЛЕЙ

### № Описание

1	Полая заклепка
2	Корпус подшипника
3	Упорный подшипник
4	Корпус конической муфты
5	Пружина односторонней муфты
6	Шестерня
7	Упорная втулка
8	Уплотнительное кольцо
9	Червячный вал
10	Смазочный ниппель
11	Корпус
12	Втулка

### № Описание

13	Гнездо пружины
14	Пружинная рессора
15	Держатель пружины
16	Сферическая заглушка
17	Возвратная пружина – внутренняя
18	Возвратная пружина – внешняя
19	Рейка
20	Уплотнительное кольцо
21	Червячное колесо
22	Уплотнитель
23	Крышка
24	Диск регулятора
25	Рукоятка управления
26	Крышка в сборе
27	Винт с потайной головкой
28	Уплотнительное кольцо рукоятки управления

## Typ 1

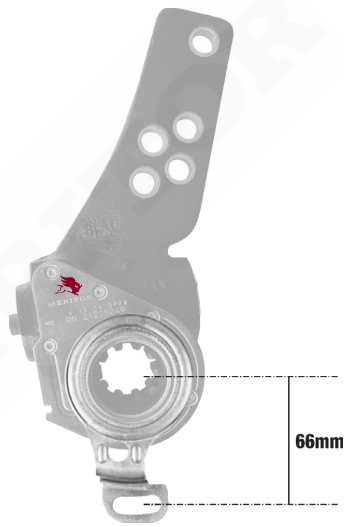

Distance between Control Arm centre to Anchor position: **66mm**  
 Distance entre le centre du bras de suspension et la position d'ancrage: **66mm**  
 Abstand vom Kontrollarm Zentrum zur Ankerposition: **66mm**  
 Distanza tra il centro del braccio di controllo e la posizione di ancoraggio: **66mm**  
 Afstand tussen hart van bedieningsarm naar ankerpositie: **66mm**  
 Distancia entre el centro del brazo de control y la posición de anclaje: **66mm**  
 Odległość pomiędzy środkiem ramienia i pozycją kotwy: **66mm**  
 Расстояние от центра рукоятки управления до позиции анкера: **66mm**

## Typ 2

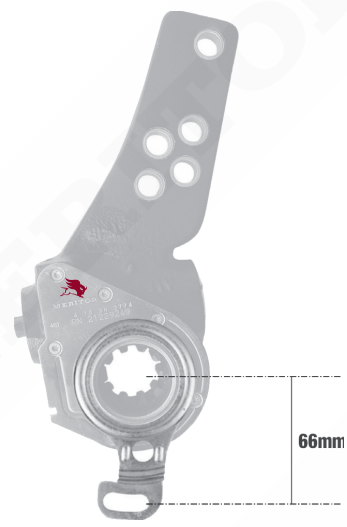

Distance between Control Arm centre to Anchor position: **66mm**  
 Distance entre le centre du bras de suspension et la position d'ancrage: **66mm**  
 Abstand vom Kontrollarm Zentrum zur Ankerposition: **66mm**  
 Distanza tra il centro del braccio di controllo e la posizione di ancoraggio: **66mm**  
 Afstand tussen hart van bedieningsarm naar ankerpositie: **66mm**  
 Distancia entre el centro del brazo de control y la posición de anclaje: **66mm**  
 Odległość pomiędzy środkiem ramienia i pozycją kotwy: **66mm**  
 Расстояние от центра рукоятки управления до позиции анкера: **66mm**

## Typ 3

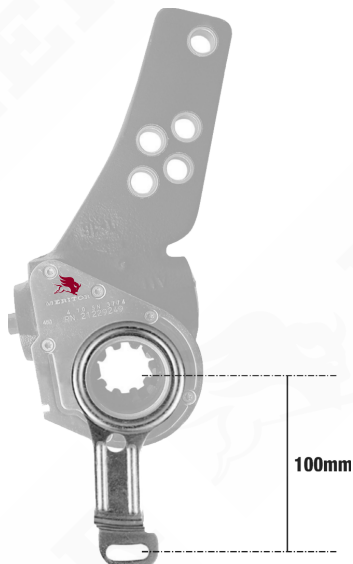

Distance between Control Arm centre to Anchor position: **100mm**  
 Distance entre le centre du bras de suspension et la position d'ancrage: **100mm**  
 Abstand vom Kontrollarm Zentrum zur Ankerposition: **100mm**  
 Distanza tra il centro del braccio di controllo e la posizione di ancoraggio: **100mm**  
 Afstand tussen hart van bedieningsarm naar ankerpositie: **100mm**  
 Distancia entre el centro del brazo de control y la posición de anclaje: **100mm**  
 Odległość pomiędzy środkiem ramienia i pozycją kotwy: **100mm**  
 Расстояние от центра рукоятки управления до позиции анкера: **100mm**

## Typ 4

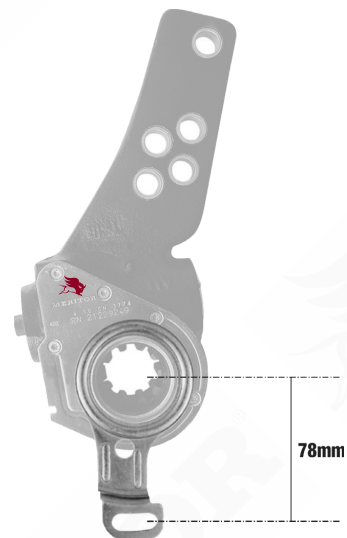

Distance between Control Arm centre to Anchor position: **78mm**  
 Distance entre le centre du bras de suspension et la position d'ancrage: **78mm**  
 Abstand vom Kontrollarm Zentrum zur Ankerposition: **78mm**  
 Distanza tra il centro del braccio di controllo e la posizione di ancoraggio: **78mm**  
 Afstand tussen hart van bedieningsarm naar ankerpositie: **78mm**  
 Distancia entre el centro del brazo de control y la posición de anclaje: **78mm**  
 Odległość pomiędzy środkiem ramienia i pozycją kotwy: **78mm**  
 Расстояние от центра рукоятки управления до позиции анкера: **78mm**



## Typ 5

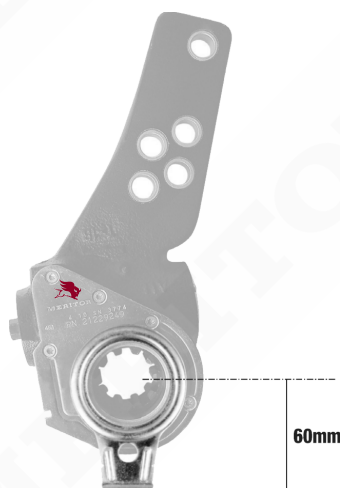

Distance between Control Arm centre to Anchor position: **60mm** Arm includes a Gommel  
 Distance entre le centre du bras de suspension et la position d'ancrage: **60mm**  
 Bras avec rondelle isolante  
 Abstand vom Kontrollarm Zentrum zur Ankerposition: **60mm** Arm beinhaltet eine Unterlegscheibe  
 Distanza tra il centro del braccio di controllo e la posizione di ancoraggio: **60mm**  
 Il braccio comprende un anello di tenuta  
 Afstand tussen hart van bedieningsarm naar ankerpositie: **60mm**  
 Rubberen ring met arm meegelverd  
 Distancia entre el centro del brazo de control y la posición de anclaje: **60mm**  
 El brazo incluye un ojal  
 Odległość pomiędzy środkiem ramienia i pozycją kotwy: **60mm**  
 Ramię zawiera przelotkę  
 Расстояние от центра рукоятки управления до позиции анкера: **60mm**  
 Рукоятка включает уплотнительное кольцо

## Typ 6

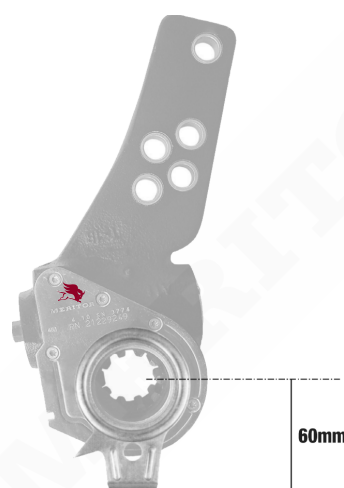

Distance between Control Arm centre to Anchor position: **60mm** Arm includes a Gommel  
 Distance entre le centre du bras de suspension et la position d'ancrage: **60mm**  
 Bras avec rondelle isolante  
 Abstand vom Kontrollarm Zentrum zur Ankerposition: **60mm** Arm beinhaltet eine Unterlegscheibe  
 Distanza tra il centro del braccio di controllo e la posizione di ancoraggio: **60mm**  
 Il braccio comprende un anello di tenuta  
 Afstand tussen hart van bedieningsarm naar ankerpositie: **60mm**  
 Rubberen ring met arm meegelverd  
 Distancia entre el centro del brazo de control y la posición de anclaje: **60mm**  
 El brazo incluye un ojal  
 Odległość pomiędzy środkiem ramienia i pozycją kotwy: **60mm**  
 Ramię zawiera przelotkę  
 Расстояние от центра рукоятки управления до позиции анкера: **60mm**  
 Рукоятка включает уплотнительное кольцо

## Typ 7

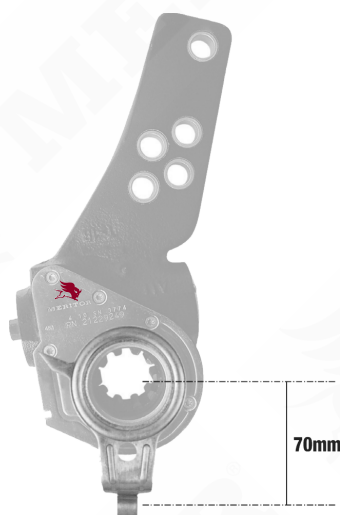

Distance between Control Arm centre to Anchor position: **70mm**  
 Distance entre le centre du bras de suspension et la position d'ancrage: **70mm**  
 Abstand vom Kontrollarm Zentrum zur Ankerposition: **70mm**  
 Distanza tra il centro del braccio di controllo e la posizione di ancoraggio: **70mm**  
 Afstand tussen hart van bedieningsarm naar ankerpositie: **70mm**  
 Distancia entre el centro del brazo de control y la posición de anclaje: **70mm**  
 Odległość pomiędzy środkiem ramienia i pozycją kotwy: **70mm**  
 Расстояние от центра рукоятки управления до позиции анкера: **70mm**

## Typ 8

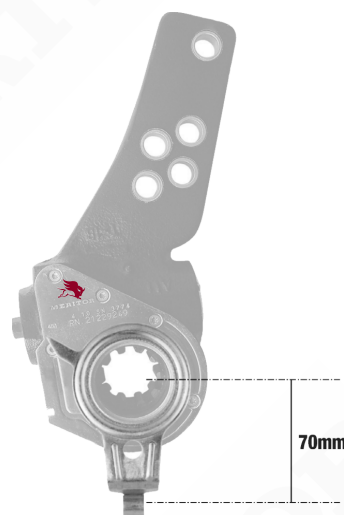

Distance between Control Arm centre to Anchor position: **70mm**  
 Distance entre le centre du bras de suspension et la position d'ancrage: **70mm**  
 Abstand vom Kontrollarm Zentrum zur Ankerposition: **70mm**  
 Distanza tra il centro del braccio di controllo e la posizione di ancoraggio: **70mm**  
 Afstand tussen hart van bedieningsarm naar ankerpositie: **70mm**  
 Distancia entre el centro del brazo de control y la posición de anclaje: **70mm**  
 Odległość pomiędzy środkiem ramienia i pozycją kotwy: **70mm**  
 Расстояние от центра рукоятки управления до позиции анкера: **70mm**

## Typ 9

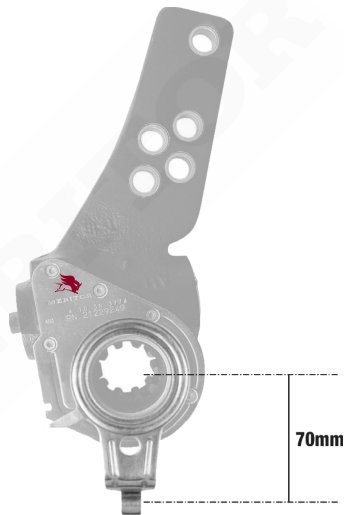

Distance between Control Arm centre to Anchor position: **70mm**  
 Distance entre le centre du bras de suspension et la position d'ancrage: **70mm**  
 Abstand vom Kontrollarm Zentrum zur Ankerposition: **70mm**  
 Distanza tra il centro del braccio di controllo e la posizione di ancoraggio: **70mm**  
 Afstand tussen hart van bedieningsarm naar ankerpositie: **70mm**  
 Distancia entre el centro del brazo de control y la posición de anclaje: **70mm**  
 Odległość pomiędzy środkiem ramienia i pozycją kotwy: **70mm**  
 Расстояние от центра рукоятки управления до позиции анкера: **70mm**

## Typ 10

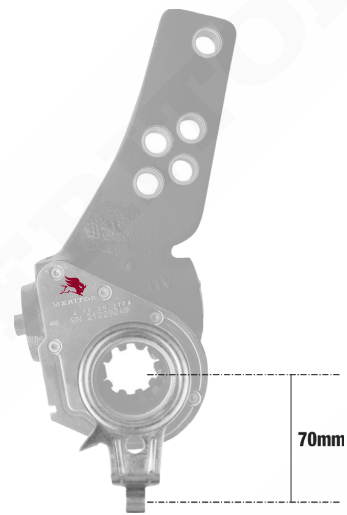

Distance between Control Arm centre to Anchor position: **70mm**  
 Distance entre le centre du bras de suspension et la position d'ancrage: **70mm**  
 Abstand vom Kontrollarm Zentrum zur Ankerposition: **70mm**  
 Distanza tra il centro del braccio di controllo e la posizione di ancoraggio: **70mm**  
 Afstand tussen hart van bedieningsarm naar ankerpositie: **70mm**  
 Distancia entre el centro del brazo de control y la posición de anclaje: **70mm**  
 Odległość pomiędzy środkiem ramienia i pozycją kotwy: **70mm**  
 Расстояние от центра рукоятки управления до позиции анкера: **70mm**

## Typ 11

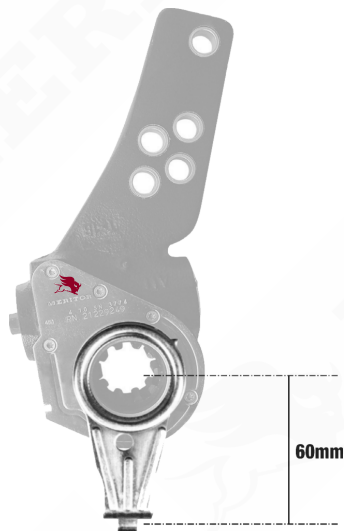

Distance between Control Arm centre to Anchor position: **60mm** Arm includes a Gomett  
 Distance entre le centre du bras de suspension et la position d'ancrage: **60mm**  
 Bras a vec rondelle isolante  
 Abstand vom Kontrollarm Zentrum zur Ankerposition: **60mm** Arm beinhaltet eine  
 Unterlegscheibe  
 Distanza tra il centro del braccio di controllo e la posizione di ancoraggio: **60mm**  
 Il braccio comprende un anello di tenuta  
 Afstand tussen hart van bedieningsarm naar ankerpositie: **60mm**  
 Rubberen ring met arm meegelverd  
 Distancia entre el centro del brazo de control y la posición de anclaje: **60mm**  
 El brazo incluye un ojal  
 Odległość pomiędzy środkiem ramienia i pozycją kotwy: **60mm**  
 Ramię zawiera przelotkę  
 Расстояние от центра рукоятки управления до позиции анкера: **60mm**  
 Рукоятка включает уплотнительное кольцо



**MERITOR®**

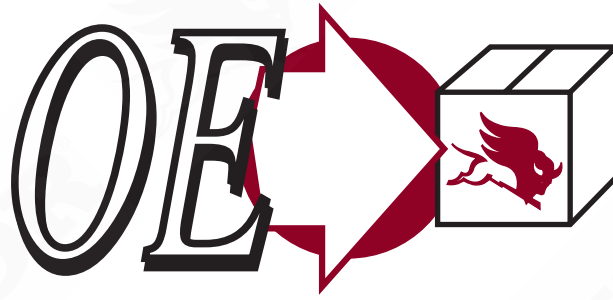

**BPW**

0517454410	MAS152901	17
0517454420	MAS152903	17
0517482020	MAS300001	17
0517482021	MAS300001	17
0517482022	MAS300001	17
0517482023	MAS300001	17
0517482032	MAS310001	17
0517482122	MAS310001	17
0517482142	MAS310001	17
0517482210	MAS300001	17
0517482211	MAS300001	17
0517482212	MAS300001	17
0517482212	MAS300001	17
0517482212	MSAS610001	17
0517482213	MAS300001	17
0517482220	MAS300001	17
0517482221	MAS300001	17
0517482222	MAS300001	17
0517482223	MAS300001	17
0517482224	MAS310001	17
0517482312	MAS310001	17
0517482472	MAS310001	17
0517482490	MAS300001	17
0517482491	MAS300001	17
0517482492	MAS300001	17
0517482493	MAS300001	17
0517482630	MAS300001	17
0517482631	MAS300001	17
0517482632	MAS300001	17
0517482633	MAS300001	17
0517482670	MAS300001	17
0517482671	MAS300001	17
0517482672	MAS300001	17
0517482673	MAS300001	17
0557482020	MAS300001	17
0557482021	MAS300001	17
0557482022	MAS300001	17
0557482023	MAS300001	17
0557482120	MAS300001	17
0557482121	MAS300001	17
0557482122	MAS300001	17
0557482123	MAS300001	17
0557482190	MAS300001	17
0557482191	MAS300001	17
0557482192	MAS300001	17
0557482193	MAS300001	17
0557482220	MAS300001	17
0557482221	MAS300001	17
0557482222	MAS300001	17
0557482223	MAS300001	17
0557482430	MAS300001	17
0557482431	MAS300001	17
0557482432	MAS300001	17
0557482433	MAS300001	17
0557482550	MAS300001	17
0557482551	MAS300001	17
0557482552	MAS300001	17
0557482553	MAS300001	17
0557482650	MAS300001	17

0557482651	MAS300001	17
0557482652	MAS300001	17
0557482653	MAS300001	17
0557482680	MAS300001	17
0557482681	MAS300001	17
0557482682	MAS300001	17
0557482683	MAS300001	17
0557482873	MAS350001	17
4175021500	MAS152903	17
4175021600	MAS152901	17
40672053000	MAS110001	17

**DAF**

0092419	MAS143807	5
0092420	MAS143808	5
0159556	MAS143801	5
0159557	MAS143802	5
0159558	MAS143803	5
0159559	MAS143804	5
0159561	MAS113802	5
0159562	MAS113801	5
0159563	MAS115613	5
0159564	MAS115614	5
0159565	MAS140006	11
0159577	MAS110015	11
0159587	MAS113803	11
0159588	MAS113804	11
0159589	MAS114501	5
0159590	MAS114502	5
219859	MAS117502	5
219860	MAS117501	5
278350	MAS143801	5
278351	MAS143802	5
279172	MAS115614	5
281090	MAS143803	5
281091	MAS143804	5
282609	MAS140005	11
284860	MAS140006	11
289691	MAS113803	11
289692	MAS113804	11
297173	MAS115613	5
361541	MAS113802	5
361542	MAS113801	5
361543	MAS114502	5
361544	MAS114501	5
390065	MAS110015	11
0537538	MAS140005	11
0740321	MAS141301	11
0740322	MAS141302	11
0755616	MAS146003	5
0755617	MAS146004	5
1263485	MAS146001	5
1263486	MAS146002	5
1282111	MAS141201	5
1282112	MAS141202	5
R9640F	MAS153812	11
R9641F	MAS153811	11

**DENNIS**

611484	MAS150008	11
611485	MAS140004	11
651623	MAS140007	11

651626	MAS150014	11
651777	MAS150010	11
652568	MAS150014	11
6869601	MAS150008	11
8228242	MAS150008	11
8550578	MAS150010	11
8550963	MAS140007	11
656007-29	MAS143806	11
656007-30	MAS143805	11
656995-104	MAS112504	11
656995-105	MAS112503	11
F4127F	MAS140007	11
F4714F	MAS143805	11
F4715F	MAS143806	11

**FODEN**

270048000	MAS150016	5
2700020000	MAS130003	5
2700021000	MAS130002	5
2700040000	MAS150017	5
7684F	MAS150013	5
F4240F	MAS150013	5

**FRUEHAUF**

AJB0092001	MAS170001	17
AJB0092001	MAS320002	17
AJB0743001	MAS320002	17
AJB0743001	MSAS610003	17
CF351148	MAS150005	17
CF351530	MAS320002	17
CF352234	MAS320002	17
CF352285	MAS320002	17

**HINO**

474801180	MAS153806	5
474801190	MAS153805	5
474801801	MAS150012	5
474801811	MAS150012	5

**IVECO**

3231273	MAS125001	11
3231343	MAS112901	11
4692759	MAS110009	5
KB3645	MAS125001	11

**KÄSSBOHRER**

8235000415	MAS150018	17
8238000835	MAS150018	17
82850000890	MAS153809	11
82850000900	MAS153810	11
82850002130	MAS153807	11
82850002140	MAS153808	11
82850005370	MAS153809	11
82850005380	MAS153810	11

**LEYLAND**

10889962	MAS151605	11
10889963	MAS151606	11
10901188	MAS150009	11
ACU3627	MAS151604	11
ACU3628	MAS151603	11
ACU3629	MAS150007	11
ACU8344	MAS132901	5
ACU8345	MAS132902	5
ACU8347	MAS110006	5

BCU5767 .....	MAS151601 .....	11
BCU5768 .....	MAS151602 .....	11
BCU5769 .....	MAS150011 .....	11

### MAN

81506106077 .....	MAS114504 .....	12
81506106078 .....	MAS114503 .....	12
81506106081 .....	MAS140001 .....	12
81506106083 .....	MAS141802 .....	5
81506106084 .....	MAS141801 .....	5
81506106126 .....	MAS281501 .....	12
81506106127 .....	MAS281502 .....	12
81506106128 .....	MAS114503 .....	12
81506106129 .....	MAS114504 .....	12
81506106139 .....	MAS115608 .....	5
81506106140 .....	MAS115607 .....	5
81506106149 .....	MAS114002 .....	12
81506106150 .....	MAS114001 .....	12
81506106151 .....	MAS140001 .....	12
81506106153 .....	MAS141802 .....	5
81506106154 .....	MAS141801 .....	5
81506106165 .....	MAS125601 .....	5
81506106166 .....	MAS125602 .....	5
81506106169 .....	MAS281502 .....	12
81506106170 .....	MAS281501 .....	12
81506106176 .....	MAS115607 .....	5
81506106177 .....	MAS115608 .....	5
81506106178 .....	MAS114001 .....	12
81506106179 .....	MAS114002 .....	12
81506106181 .....	MAS111803 .....	12
81506106182 .....	MAS111804 .....	12
81506106187 .....	MAS114504 .....	12
81506106188 .....	MAS114503 .....	12
81506106193 .....	MAS110012 .....	12
81506106194 .....	MAS110011 .....	5
81506106203 .....	MAS111803 .....	12
81506106204 .....	MAS111804 .....	12
81506106205 .....	MAS114002 .....	12
81506106206 .....	MAS114001 .....	12
81506106210 .....	MAS125602 .....	5
81506106211 .....	MAS125601 .....	5
81506106212 .....	MAS141801 .....	5
81506106213 .....	MAS141802 .....	5
81506106214 .....	MAS115607 .....	5
81506106215 .....	MAS115608 .....	5
81506106216 .....	MAS110011 .....	5
81506106217 .....	MAS110012 .....	12
81506106220 .....	MAS114503 .....	12
81506106221 .....	MAS114504 .....	12
81506106222 .....	MAS281501 .....	12
81506106223 .....	MAS281502 .....	12
81506106231 .....	MAS140001 .....	12
KL0800000-099 .....	MAS281502 .....	12
KL0800000-109 .....	MAS281501 .....	12
L1850087 .....	MAS281501 .....	12
L1850096 .....	MAS281502 .....	12
OP0700001-044 .....	MAS125602 .....	5
OP0700001-045 .....	MAS125601 .....	5
81506106261 .....	MSAS115609 .....	5
81506106262 .....	MSAS115610 .....	5
81506106263 .....	MSAS115607 .....	5

81506106266 .....	MSAS115608 .....	5
-------------------	------------------	---

### MCW

8226963 .....	MAS153803 .....	12
8226964 .....	MAS153804 .....	12
F4105F .....	MAS153803 .....	12
F4106F .....	MAS153804 .....	12
R8270F .....	MAS153803 .....	12
R8271F .....	MAS153804 .....	12
X1811183 .....	MAS153803 .....	12
X1811184 .....	MAS153804 .....	12

### MERCEDES

070112507 .....	MAS110008 .....	12
080110802 .....	MAS110005 .....	12
3014201138 .....	MAS140002 .....	12
3054202638 .....	MAS110008 .....	12
3074200138 .....	MAS141503 .....	12
3074200238 .....	MAS141504 .....	12
3074200338 .....	MAS110005 .....	12
3464201538 .....	MAS141803 .....	6
3464201638 .....	MAS141804 .....	6
3574200538 .....	MAS110003 .....	12
3574201138 .....	MAS141501 .....	12
3574201238 .....	MAS141502 .....	12
3574201338 .....	MAS111801 .....	12
3574201438 .....	MAS111802 .....	12
3574201538 .....	MAS111805 .....	12
3574201638 .....	MAS111806 .....	12
3834200438 .....	MAS115603 .....	12
3834200538 .....	MAS115604 .....	12
3874200038 .....	MAS115606 .....	6
3874200138 .....	MAS115605 .....	6
3874200238 .....	MAS115601 .....	6
3874200338 .....	MAS115602 .....	6
3894200338 .....	MAS141803 .....	6
3894200438 .....	MAS141804 .....	6
3894200738 .....	MAS140003 .....	6
3934200038 .....	MAS110017 .....	12
3964200038 .....	MAS140003 .....	6
6174200238 .....	MAS110004 .....	12
6174200338 .....	MAS115602 .....	6
6174200438 .....	MAS115601 .....	6
6194200038 .....	MAS143704 .....	6
6194200138 .....	MAS143703 .....	6
6204200038 .....	MAS141803 .....	6
6204200238 .....	MAS140003 .....	6
6204200338 .....	MAS140003 .....	6
6214200038 .....	MAS115605 .....	6
6214200138 .....	MAS115606 .....	6
6234200438 .....	MAS116002 .....	6
6234200538 .....	MAS116001 .....	6
6234200638 .....	MAS116002 .....	6
6234200738 .....	MAS116001 .....	6
6234201238 .....	MAS143704 .....	6
6234201338 .....	MAS143703 .....	6
6524200038 .....	MAS143702 .....	6
6524200138 .....	MAS143701 .....	6
6584200238 .....	MAS143702 .....	6
6584200338 .....	MAS143701 .....	6
9424200238 .....	MAS115602 .....	6
9424200338 .....	MAS115601 .....	6

9424200638 .....	MAS141803 .....	6
9424200838 .....	MAS143701 .....	6
9424200938 .....	MAS143702 .....	6
9424201038 .....	MAS115605 .....	6
9424201138 .....	MAS115606 .....	6
9454200438 .....	MSAS115605 .....	6
6524200238 .....	MAS110007 .....	12
9454200038 .....	MSAS143701 .....	6
9454200138 .....	MSAS143702 .....	6
9454200238 .....	MSAS115601 .....	6
9454200338 .....	MSAS115602 .....	6
9454200538 .....	MSAS114201 .....	6
9454200638 .....	MSAS114202 .....	6
9454200738 .....	MSAS115604 .....	6
9454200838 .....	MSAS115603 .....	6
9454200938 .....	MSAS115606 .....	6

### MERITOR/ROR

21222873 .....	MAS9250 .....	17
21222874 .....	MAS9251 .....	17
21223694 .....	MAS9249 .....	17
21224345 .....	MAS9290 .....	17
21225220 .....	MAS9281 .....	17
21225221 .....	MAS9280 .....	17
21225222 .....	MAS9281 .....	17
21226978 .....	MAS9287 .....	17
21227325 .....	MAS9289 .....	17
21229249 .....	MAS9249 .....	17
21229249 .....	MSAS610002 .....	17
21229250 .....	MAS9250 .....	17
21229251 .....	MAS9251 .....	17
21229252 .....	MAS9250 .....	17
21229253 .....	MAS9251 .....	17
21229280 .....	MAS9280 .....	17
21229281 .....	MAS9281 .....	17
21229285 .....	MAS9285 .....	17
21229286 .....	MAS9286 .....	17
21229287 .....	MAS9287 .....	17
21229289 .....	MAS9289 .....	17
21229290 .....	MAS9290 .....	17

### NEOPLAN

070276000 .....	MAS112501 .....	12
070276100 .....	MAS112502 .....	12
080250000 .....	MAS110010 .....	12
B510642 .....	MAS112502 .....	12
B510643 .....	MAS112501 .....	12

### OPTARE

L2220055 .....	MAS150015 .....	12
----------------	-----------------	----

### RENAULT

5010152965 .....	MAS110019 .....	12
5010201995 .....	MAS110018 .....	12
5000785203 .....	MAS152204 .....	12
5000785204 .....	MAS152203 .....	13
5000785205 .....	MAS152302 .....	13
5000785206 .....	MAS152301 .....	13
5000789892 .....	MAS113806 .....	6
5000789893 .....	MAS113805 .....	6
5000789894 .....	MAS123803 .....	12
5000789895 .....	MAS123804 .....	13
5000791212 .....	MAS113807 .....	12

### ... RENAULT

5000791213 .....	MAS113808 .....	13
5010056685 .....	MAS113806 .....	6
5010056686 .....	MAS113805 .....	6
5010098831 .....	MAS113813 .....	6
5010098832 .....	MAS113814 .....	6
5010098860 .....	MAS115611 .....	6
5010098861 .....	MAS115612 .....	6
5010098862 .....	MAS115609 .....	6
5010098863 .....	MAS115610 .....	6
5010216843 .....	MAS113811 .....	6
5010216844 .....	MAS113812 .....	6
5010260027 .....	MAS113809 .....	6
5010260028 .....	MAS113810 .....	6
5010260115 .....	MAS125606 .....	6
5010260116 .....	MAS125605 .....	6
5010260117 .....	MAS125603 .....	6
5010260118 .....	MAS125604 .....	6

### SAE

4175024000 .....	MAS320005 .....	17
------------------	-----------------	----

### SAF

2175015600 .....	MAS170002 .....	18
2175016800 .....	MAS170002 .....	18
2175020200 .....	MAS170002 .....	18
3434350202 .....	MAS130001 .....	18
4175008500 .....	MAS320004 .....	18
4175008501 .....	MAS170002 .....	18
4175013900 .....	MAS142504 .....	18
4175014000 .....	MAS142501 .....	18
4175014100 .....	MAS130001 .....	18
4175014400 .....	MAS170003 .....	18
4175014900 .....	MAS142503 .....	18
4175015000 .....	MAS142502 .....	18
4175015401 .....	MAS320004 .....	18
4175021100 .....	MAS320006 .....	18
4175022800 .....	MAS320004 .....	18
4175024700 .....	MAS170003 .....	18
4175024800 .....	MAS320006 .....	18
4175024900 .....	MAS320004 .....	18
4175024900 .....	MSAS610004 .....	18
5000816365 .....	MAS320004 .....	18

### SCANIA

218833 .....	MAS163802 .....	13
218834 .....	MAS163801 .....	13
278737 .....	MAS132501 .....	13
278738 .....	MAS132502 .....	13
278739 .....	MAS130004 .....	13
362135 .....	MAS115003 .....	13
384417 .....	MAS115002 .....	13
384418 .....	MAS115001 .....	13
384419 .....	MAS130004 .....	13
394181 .....	MAS132501 .....	13
394182 .....	MAS132502 .....	13
394191 .....	MAS115003 .....	13
394192 .....	MAS115004 .....	13
394195 .....	MAS113501 .....	7
394196 .....	MAS113502 .....	7
1112829 .....	MAS115002 .....	13
1112830 .....	MAS115001 .....	13

1112831 .....	MAS130004 .....	13
1112833 .....	MAS132501 .....	13
1112834 .....	MAS132502 .....	13
1112839 .....	MAS115003 .....	13
1112840 .....	MAS115004 .....	13
1358634 .....	MAS116501 .....	13
1358635 .....	MAS116502 .....	13
070265600 .....	MAS132502 .....	13
082460300 .....	MAS132501 .....	13

### SMB

0517482472 .....	MAS320003 .....	18
MO02416 .....	MAS320003 .....	18
MO02416 .....	MSAS610005 .....	18
MO23565 .....	MAS320003 .....	18
MO50082 .....	MAS320003 .....	18

### TRAILOR

9002105 .....	MAS320001 .....	18
80506556B .....	MAS320001 .....	18
M068593 .....	MAS320001 .....	18
T0017649Z .....	MAS320001 .....	18
TOO17649Z .....	MSAS610006 .....	18

### VAN HOOL

3177673 .....	MAS110014 .....	13
---------------	-----------------	----

### VOLVO

1135004 .....	MAS150006 .....	13
1136432 .....	MAS151504 .....	13
1136433 .....	MAS151503 .....	13
1195461 .....	MAS151501 .....	13
1195462 .....	MAS151502 .....	13
1196321 .....	MAS160001 .....	13
1196322 .....	MAS160002 .....	13
1197965 .....	MAS151506 .....	13
1197966 .....	MAS151505 .....	13
3136426 .....	MAS152906 .....	13
3136427 .....	MAS152905 .....	13
3193400 .....	MAS165001 .....	13
3193401 .....	MAS165002 .....	13
3193402 .....	MAS164401 .....	13
3193403 .....	MAS164402 .....	13

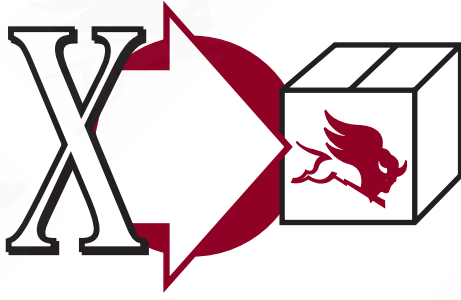



**FEBI**

15561 .....	MAS300001
15562 .....	MAS310001
18647 .....	MAS320004

**FRANCE TAMBOUR**

66005 .....	MAS300001
66008 .....	MAS170002
66010 .....	MAS320002

**HALDEX**

12254 .....	MAS153805
12255 .....	MAS153806
12256 .....	MAS150012
70618 .....	MAS150002
70624 .....	MAS150009
70626 .....	MAS151605
70627 .....	MAS151606
70662 .....	MAS163802
70663 .....	MAS163801
70664 .....	MAS117502
70665 .....	MAS117501
70698 .....	MAS170002
70706 .....	MAS110008
70709 .....	MAS150002
70710 .....	MAS152302
70711 .....	MAS152301
70712 .....	MAS152204
70713 .....	MAS152203
70722 .....	MAS141802
70723 .....	MAS141801
70730 .....	MAS114503
70731 .....	MAS114504
70734 .....	MAS140001
70753 .....	MAS141803
70754 .....	MAS141804
70760 .....	MAS115602
70761 .....	MAS115601
70771 .....	MAS141504
70772 .....	MAS141503
70775 .....	MAS110005
70802 .....	MAS9250
70803 .....	MAS9251
70804 .....	MAS320001
70810 .....	MAS110009
70818 .....	MAS150002
70847 .....	MAS281501
70848 .....	MAS281502
70859 .....	MAS150008
70867 .....	MAS140003
70870 .....	MAS110017
70877 .....	MAS170002
70887 .....	MAS150003
70893 .....	MAS153803
70894 .....	MAS153804
70902 .....	MAS150006
70907 .....	MAS281502
70908 .....	MAS281501
70909 .....	MAS151504
70910 .....	MAS151503
70943 .....	MAS151604

70944 .....	MAS151603
70945 .....	MAS150007
70947 .....	MAS115606
70948 .....	MAS115605
70949 .....	MAS130001
70952 .....	MAS115602
70953 .....	MAS115601
70954 .....	MAS110004
70960 .....	MAS142504
70961 .....	MAS142501
70962 .....	MAS281501
70963 .....	MAS281502
70964 .....	MAS114503
70965 .....	MAS114504
70966 .....	MAS110005
70967 .....	MAS141504
70968 .....	MAS141503
70969 .....	MAS152903
70970 .....	MAS152901
70971 .....	MAS150018
70983 .....	MAS170002
70984 .....	MAS320006
70986 .....	MAS140004
72007 .....	MAS142503
72008 .....	MAS142502
72010 .....	MAS310001
72012 .....	MAS115607
72013 .....	MAS115608
72036 .....	MAS115603
72037 .....	MAS115604
72038 .....	MAS116001
72039 .....	MAS116002
72053 .....	MAS110001
72057 .....	MAS320001
72059 .....	MAS110003
72062 .....	MAS143704
72063 .....	MAS143703
72066 .....	MAS320001
72103 .....	MAS150005
72104 .....	MAS150004
72107 .....	MAS143801
72108 .....	MAS143802
72109 .....	MAS143803
72110 .....	MAS143804
72119 .....	MAS150003
72152 .....	MAS151501
72153 .....	MAS151502
72158 .....	MAS114002
72159 .....	MAS114001
72160 .....	MAS113806
72161 .....	MAS113805
72162 .....	MAS123803
72163 .....	MAS123804
72166 .....	MAS160001
72167 .....	MAS160002
72170 .....	MAS110015
72173 .....	MAS115606
72174 .....	MAS115605
72177 .....	MAS110010
72180 .....	MAS130003

72181 .....	MAS130002
72197 .....	MAS140005
72202 .....	MAS140006
72203 .....	MAS112501
72204 .....	MAS112502
72208 .....	MAS110012
72211 .....	MAS141501
72212 .....	MAS141502
72213 .....	MAS140002
72223 .....	MAS113803
72224 .....	MAS113804
72232 .....	MAS151506
72233 .....	MAS151505
72238 .....	MAS142504
72239 .....	MAS142501
72250 .....	MAS170002
72251 .....	MAS320005
72252 .....	MAS150018
72253 .....	MAS150002
72254 .....	MAS320001
72255 .....	MAS150003
72258 .....	MAS320006
72261 .....	MAS150006
72263 .....	MAS310001
72266 .....	MAS170001
72267 .....	MAS9249
72268 .....	MAS150007
72269 .....	MAS320004
72270 .....	MAS170003
72271 .....	MAS310001
72274 .....	MAS320003
72282 .....	MAS150001
72301 .....	MAS114502
72302 .....	MAS114501
72303 .....	MAS125601
72304 .....	MAS125602
72308 .....	MAS140003
72310 .....	MAS113802
72311 .....	MAS113801
72312 .....	MAS115613
72313 .....	MAS115614
72318 .....	MAS113807
72319 .....	MAS113808
72320 .....	MAS141802
72321 .....	MAS141801
72322 .....	MAS140001
72330 .....	MAS110014
72342 .....	MAS110015
72351 .....	MAS281501
72352 .....	MAS281502
72362 .....	MAS150014
72364 .....	MAS140007
72367 .....	MAS150010
72368 .....	MAS153810
72369 .....	MAS153809
72403 .....	MAS132901
72404 .....	MAS132902
72406 .....	MAS110006
72414 .....	MAS115607
72415 .....	MAS115608

72434 .....	MAS114001
72435 .....	MAS114002
72439 .....	MAS151601
72440 .....	MAS151602
72441 .....	MAS150011
72455 .....	MAS111804
72456 .....	MAS111803
72457 .....	MAS150013
72467 .....	MAS130004
72478 .....	MAS113501
72479 .....	MAS113502
72486 .....	MAS115002
72487 .....	MAS115001
72488 .....	MAS115003
72489 .....	MAS115004
72491 .....	MAS132501
72492 .....	MAS132502
72500 .....	MAS281501
72501 .....	MAS281502
72508 .....	MAS114503
72509 .....	MAS114504
72512 .....	MAS281501
72513 .....	MAS281502
72523 .....	MAS143801
72524 .....	MAS143802
72525 .....	MAS143803
72526 .....	MAS143804
72534 .....	MAS140005
72535 .....	MAS140006
72536 .....	MAS113803
72537 .....	MAS113804
72538 .....	MAS114501
72539 .....	MAS114502
72542 .....	MAS113802
72543 .....	MAS113801
72544 .....	MAS115613
72545 .....	MAS115614
72548 .....	MAS110015
72569 .....	MAS320004
72576 .....	MAS320004
72578 .....	MAS110011
72581 .....	MAS320006
72591 .....	MAS153807
72592 .....	MAS153808
72593 .....	MAS143702
72594 .....	MAS143701
72596 .....	MAS110007
72608 .....	MAS141301
72609 .....	MAS141302
72620 .....	MAS115002
72621 .....	MAS115001
72622 .....	MAS130004
72624 .....	MAS132501
72625 .....	MAS132502
72630 .....	MAS115003
72631 .....	MAS115004
72660 .....	MAS132501
72661 .....	MAS132502
72662 .....	MAS130004
72663 .....	MAS115002



72664	MAS115001
72667	MAS150006
72678	MAS160001
72702	MAS320004
72703	MAS300001
72704	MAS146003
72705	MAS146004
72723	MAS151504
72724	MAS151503
72726	MAS160002
72729	MAS113501
72730	MAS113502
72740	MAS113813
72741	MAS113814
72744	MAS163802
72745	MAS163801
72758	MAS150018
72763	MAS310001
72782	MAS151501
72783	MAS151502
72784	MAS151506
72785	MAS151505
72788	MAS9249
72798	MAS115611
72799	MAS115612
72807	MAS117501
72808	MAS117502
72809	MAS111801
72810	MAS111802
72811	MAS111805
72812	MAS111806
72813	MAS115609
72814	MAS115610
72815	MAS153812
72816	MAS153811
72825	MAS115003
72826	MAS115004
72835	MAS113811
72836	MAS113812
72858	MAS110016
72875	MAS300001
72876	MAS310001
72886	MAS146001
72887	MAS146002
72888	MAS110013
72929	MAS125001
72930	MAS112901
72939	MAS150017
72948	MAS320005
72965	MAS115607
72966	MAS115608
72967	MAS110012
72968	MAS125601
72969	MAS125602
72970	MAS141802
72971	MAS141801
72972	MAS140001
72978	MAS114001
72979	MAS114002
72981	MAS111804

72982	MAS111803
72985	MAS114503
72986	MAS114504
72987	MAS281501
72988	MAS281502
72989	MAS110011
72997	MAS113809
72998	MAS113810
79004	MAS320003
79005	MAS320004
79006	MAS170003
79013	MAS113806
79014	MAS113805
79015	MAS123803
79016	MAS123804
79017	MAS113807
79018	MAS113808
79022	MAS320002
79023	MAS320001
79024	MAS141201
79025	MAS141202
79028	MAS9285
79029	MAS9286
79030	MAS152904
79031	MAS152902
79033	MAS116501
79034	MAS116502
79035	MAS320006
79040	MAS153810
79041	MAS153809
79051	MAS9287
79052	MAS154501
79053	MAS154502
79056	MAS150019
79057	MAS152201
79058	MAS152202
79059	MAS111701
79060	MAS111702
79075	MAS125606
79076	MAS125605
79077	MAS125603
79078	MAS125604
79097	MAS9280
79098	MAS9281
79105	MAS117501
79106	MAS117502
79111	MAS290002
79133	MAS150016
79150	MAS152302
79151	MAS152301
79152	MAS152204
79153	MAS152203
79156	MAS143805
79157	MAS143806
79160	MAS9289
79177	MAS150015
79183	MAS9290
79205	MAS115607
79206	MAS115608
79207	MAS110012

79208	MAS125601
79209	MAS125602
79210	MAS141802
79211	MAS141801
79212	MAS140001
79216	MAS114001
79217	MAS114002
79219	MAS111804
79220	MAS111803
79223	MAS114503
79224	MAS114504
79225	MAS281501
79226	MAS281502
79227	MAS110011
79235	MAS9249
79275	MAS165001
79276	MAS165002
79288	MAS113813
79289	MAS113814
79294	MAS115611
79295	MAS115612
79296	MAS115609
79297	MAS115610
79299	MAS113811
79300	MAS113812
79304	MAS113809
79305	MAS113810
79308	MAS125606
79309	MAS125605
79310	MAS125603
79311	MAS125604
79314	MAS130001
79315	MAS152903
79316	MAS152901
79317	MAS142503
79318	MAS142502
79319	MAS142504
79320	MAS142501
79321	MAS170002
79324	MAS320006
79326	MAS320004
79327	MAS300001
79330	MAS320005
79331	MAS320004
79332	MAS170003
79333	MAS320006
79338	MAS154501
79429	MAS112504
79430	MAS112503
79442	MAS116501
79443	MAS116502
79502	MAS110001
79677	MAS165001
79678	MAS165002
79713	MAS164401
79714	MAS164402
80000	MSAS115601
80001	MSAS115602
80008	MSAS143701
80009	MSAS143702

80010	MSAS115603
80011	MSAS115604
80012	MSAS114201
80013	MSAS114202
80014	MSAS115605
80019	MSAS610001
80020	MSAS610002
80021	MSAS610003
80022	MSAS610004
80023	MSAS610005
80024	MSAS610006
80030	MSAS115606
80037	MSAS610007

### KNORR

KB 2290	MAS151503
KB1000	MAS9249
KB1005	MAS300001
KB1010	MAS310001
KB1015	MAS320001
KB1020	MAS320002
KB1025	MAS320003
KB1030	MAS320004
KB1035	MAS320005
KB1040	MAS320006
KB1050	MAS170001
KB1056	MAS150006
KB1060	MAS150007
KB1075	MAS170002
KB1080	MAS130001
KB1085	MAS9280
KB1090	MAS9281
KB1095	MAS170003
KB1100	MAS150001
KB1105	MAS150002
KB1110	MAS142501
KB1115	MAS9250
KB1120	MAS9251
KB1125	MAS110001
KB1130	MAS142502
KB1135	MAS142503
KB1140	MAS154501
KB1145	MAS154502
KB1150	MAS150003
KB1160	MAS142504
KB1165	MAS150004
KB1175	MAS150005
KB1180	MAS9289
KB1185	MAS9287
KB1205	MAS9285
KB1210	MAS9286
KB1215	MAS152903
KB1220	MAS152901
KB1225	MAS152904
KB1230	MAS152902
KB2010	MAS143801
KB2015	MAS143802
KB2020	MAS114501
KB2025	MAS114502
KB2030	MAS140005
KB2035	MAS113801



**... KNORR**

KB2035	MAS125602
KB2040	MAS110003
KB2045	MAS110004
KB2050	MAS143701
KB2055	MAS143702
KB2060	MAS115601
KB2065	MAS115602
KB2070	MAS125601
KB2080	MAS140001
KB2085	MAS150018
KB2090	MAS141801
KB2095	MAS141802
KB2100	MAS110005
KB2105	MAS113802
KB2110	MAS113803
KB2115	MAS143803
KB2120	MAS113804
KB2125	MAS143804
KB2130	MAS140002
KB2135	MAS115603
KB2140	MAS115604
KB2145	MAS143703
KB2150	MAS140003
KB2155	MAS115605
KB2160	MAS115606
KB2165	MAS143704
KB2170	MAS130002
KB2180	MAS110006
KB2185	MAS132901
KB2190	MAS132902
KB2210	MAS115001
KB2215	MAS115002
KB2220	MAS132501
KB2225	MAS123803
KB2230	MAS113805
KB2235	MAS130003
KB2240	MAS113806
KB2245	MAS123804
KB2250	MAS130004
KB2255	MAS150006
KB2260	MAS132502
KB2265	MAS163801
KB2270	MAS163802
KB2275	MAS160001
KB2285	MAS151504
KB2295	MAS160002
KB2300	MAS151502
KB2310	MAS153803
KB2315	MAS150007
KB2320	MAS151605
KB2325	MAS150008
KB2330	MAS150009
KB2335	MAS150010
KB2340	MAS150011
KB2345	MAS151601
KB2350	MAS151602
KB2360	MAS115003
KB2375	MAS140007
KB2395	MAS110015

KB2400	MAS141301
KB2405	MAS153805
KB2410	MAS153806
KB2415	MAS150012
KB2420	MAS110007
KB2425	MAS141302
KB2435	MAS151606
KB2440	MAS110008
KB2445	MAS141803
KB2475	MAS151604
KB2480	MAS151603
KB2505	MAS112501
KB2510	MAS112502
KB2515	MAS140006
KB2595	MAS115004
KB2610	MAS115607
KB2615	MAS115608
KB2620	MAS114503
KB2625	MAS114504
KB2630	MAS115609
KB2635	MAS115610
KB2640	MAS113811
KB2645	MAS113812
KB2700	MAS153804
KB2710	MAS116502
KB2715	MAS141501
KB2720	MAS141502
KB2725	MAS146001
KB2730	MAS146002
KB2735	MAS116501
KB2745	MAS110009
KB2750	MAS116001
KB2755	MAS116002
KB2765	MAS141804
KB2795	MAS113807
KB2800	MAS113808
KB2825	MAS140004
KB2905	MAS113813
KB2910	MAS113814
KB2920	MAS115611
KB2925	MAS115612
KB2930	MAS111801
KB2955	MAS150015
KB2960	MAS110014
KB2975	MAS153808
KB3000	MAS153811
KB3005	MAS153812
KB3025	MAS150013
KB3040	MAS125603
KB3045	MAS125604
KB3050	MAS125605
KB3055	MAS125606
KB3095	MAS150014
KB3115	MAS281501
KB3120	MAS281502
KB3125	MAS141503
KB3130	MAS141504
KB3135	MAS151505
KB3140	MAS151506
KB3155	MAS111802

KB3165	MAS110011
KB3175	MAS112503
KB3180	MAS112504
KB3195	MAS152302
KB3200	MAS152301
KB3215	MAS152203
KB3220	MAS152204
KB3265	MAS114001
KB3270	MAS114002
KB3300	MAS150017
KB3325	MAS143805
KB3330	MAS143806
KB3335	MAS111803
KB3340	MAS111804
KB3400	MAS110012
KB3425	MAS141201
KB3430	MAS141202
KB3485	MAS113809
KB3490	MAS113810
KB3520	MAS113501
KB3525	MAS113502
KB3550	MAS117501
KB3555	MAS117502
KB3575	MAS153807
KB3645	MAS125001
KB3650	MAS112901
KB3655	MAS115613
KB3680	MAS153810
KB3685	MAS153809
KB3700	MAS146003
KB3705	MAS146004
KB3815	MAS111805
KB3820	MAS111806
KB3910	MAS165001
KB3915	MAS165002
KB3995	MAS110002
KB4190	MAS164401
KB4195	MAS164402
KB6500	MSAS115601
KB6505	MSAS115602
KB6510	MSAS143701
KB6515	MSAS143702
KB6520	MSAS115603
KB6525	MSAS115604
KB6530	MSAS114201
KB6535	MSAS114202
KB6540	MSAS115605
KB6545	MSAS115606
MB3660	MAS115614

**MEI**

4W1000	MAS9249
4W1005	MAS300001
4W1010	MAS300001
4W1015	MAS320001
4W1020	MAS320002
4W1025	MAS320003
4W1030	MAS320004
4W1035	MAS320005
4W1040	MAS320006
4W1045	MAS320005

4W1046	MAS350001
4W1050	MAS170001
4W1055	MAS150006
4W1060	MAS150007
4W1075	MAS170002
4W1080	MAS130001
4W1085	MAS9280
4W1090	MAS9281
4W1095	MAS170003
4W1100	MAS150001
4W1105	MAS150002
4W1110	MAS142501
4W1115	MAS9250
4W1120	MAS9251
4W1125	MAS110001
4W1130	MAS142502
4W1135	MAS142503
4W1140	MAS154501
4W1145	MAS154502
4W1150	MAS150003
4W1160	MAS142504
4W1165	MAS150004
4W1170	MAS9290
4W1175	MAS150005
4W1180	MAS9289
4W1185	MAS9287
4W1205	MAS9285
4W1210	MAS9286
4W1215	MAS152903
4W1220	MAS152901
4W1225	MAS152904
4W1230	MAS152902
4W1240	MAS290002
4W2010	MAS143801
4W2015	MAS143802
4W2020	MAS114501
4W2025	MAS114502
4W2030	MAS140005
4W2035	MAS113801
4W2035	MAS125602
4W2040	MAS110003
4W2045	MAS110004
4W2050	MAS143701
4W2055	MAS143702
4W2060	MAS115601
4W2065	MAS115602
4W2070	MAS125601
4W2075	MAS125602
4W2080	MAS140001
4W2085	MAS150018
4W2090	MAS141801
4W2095	MAS141802
4W2100	MAS110005
4W2105	MAS113802
4W2110	MAS113803
4W2115	MAS143803
4W2120	MAS113804
4W2125	MAS143804
4W2130	MAS140002
4W2135	MAS115603



4W2140	MAS115604
4W2145	MAS143703
4W2150	MAS140003
4W2155	MAS115605
4W2160	MAS115606
4W2165	MAS143704
4W2170	MAS130002
4W2180	MAS110006
4W2185	MAS132901
4W2190	MAS132902
4W2210	MAS115001
4W2215	MAS115002
4W2220	MAS132501
4W2225	MAS123803
4W2230	MAS113805
4W2235	MAS130003
4W2240	MAS113806
4W2245	MAS123804
4W2250	MAS130004
4W2255	MAS150006
4W2260	MAS132502
4W2265	MAS163801
4W2270	MAS163802
4W2275	MAS160001
4W2280	MAS151501
4W2285	MAS151504
4W2290	MAS151503
4W2295	MAS160002
4W2300	MAS151502
4W2310	MAS153803
4W2315	MAS150007
4W2320	MAS151605
4W2325	MAS150008
4W2330	MAS150009
4W2335	MAS150010
4W2340	MAS150011
4W2345	MAS151601
4W2350	MAS151602
4W2360	MAS115003
4W2375	MAS140007
4W2395	MAS110015
4W2400	MAS141301
4W2405	MAS153805
4W2410	MAS153806
4W2415	MAS150012
4W2420	MAS110007
4W2425	MAS141302
4W2435	MAS151606
4W2440	MAS110008
4W2445	MAS141803
4W2475	MAS151604
4W2480	MAS151603
4W2505	MAS112501
4W2510	MAS112502
4W2515	MAS140006
4W2595	MAS115004
4W2610	MAS115607
4W2615	MAS115608
4W2620	MAS114503
4W2625	MAS114504

4W2630	MAS115609
4W2635	MAS115610
4W2640	MAS113811
4W2645	MAS113812
4W2700	MAS153804
4W2715	MAS141501
4W2720	MAS141502
4W2725	MAS146001
4W2730	MAS146002
4W2735	MAS116501
4W2740	MAS116502
4W2745	MAS110009
4W2750	MAS116001
4W2755	MAS116002
4W2765	MAS141804
4W2795	MAS113807
4W2800	MAS113808
4W2825	MAS140004
4W2845	MAS110010
4W2905	MAS113813
4W2910	MAS113814
4W2920	MAS115611
4W2925	MAS115612
4W2930	MAS111801
4W2955	MAS150015
4W2960	MAS110014
4W2975	MAS153808
4W3000	MAS153811
4W3005	MAS153812
4W3025	MAS150013
4W3040	MAS125603
4W3045	MAS125604
4W3050	MAS125605
4W3055	MAS125606
4W3095	MAS150014
4W3115	MAS281501
4W3120	MAS281502
4W3125	MAS141503
4W3130	MAS141504
4W3135	MAS151505
4W3140	MAS151506
4W3155	MAS111802
4W3165	MAS110011
4W3175	MAS112503
4W3180	MAS112504
4W3195	MAS152302
4W3200	MAS152301
4W3215	MAS152203
4W3220	MAS152204
4W3265	MAS114001
4W3270	MAS114002
4W3300	MAS150017
4W3325	MAS143805
4W3330	MAS143806
4W3335	MAS111803
4W3340	MAS111804
4W3400	MAS110012
4W3425	MAS141201
4W3430	MAS141202
4W3485	MAS113809

4W3490	MAS113810
4W3520	MAS113501
4W3525	MAS113502
4W3550	MAS117501
4W3555	MAS117502
4W3575	MAS153807
4W3605	MAS110016
4W3645	MAS125001
4W3650	MAS112901
4W3655	MAS115613
4W3660	MAS115614
4W3680	MAS153810
4W3685	MAS153809
4W3700	MAS146003
4W3705	MAS146004
4W3815	MAS111805
4W3820	MAS111806
4W3900	MAS150019
4W3910	MAS165001
4W3915	MAS165002
4W3945	MAS285902
4W3995	MAS110013
4W4020	MAS285901
4W4025	MAS111701
4W4030	MAS111702
4W4035	MAS152201
4W4040	MAS152202
4W4135	MAS150016
4W4170	MAS110017
4W4190	MAS164401
4W4195	MAS164402
4W4255	MAS152906
4W4260	MAS152905
4W4265	MAS110018
4W4270	MAS110019
4W4285	MAS110020
4W4305	MAS143807
4W4310	MAS143808
6Y1500	MSAS610001
6Y1505	MSAS610002
6Y1510	MSAS610003
6Y1515	MSAS610004
6Y1520	MSAS610005
6Y1525	MSAS610006
6Y1530	MSAS610007
6Y6500	MSAS115601
6Y6505	MSAS115602
6Y6510	MSAS143701
6Y6515	MSAS143702
6Y6520	MSAS115603
6Y6525	MSAS115604
6Y6530	MSAS114201
6Y6535	MSAS114202
6Y6540	MSAS115605
6Y6545	MSAS115606
6Y6620	MSAS115607
6Y6625	MSAS115608
6Y6630	MSAS115609
6Y6660	MSAS115610

PETERS	
046.418-00	MAS152901
046.419-00	MAS152903
046.781-00	MAS300001
066.402-00	MAS130001
406.725-00	MAS300001

WINKLER	
351 886 016 00	MAS130001
351 886 019 00	MAS320004
351 886 117 00	MAS320006



**MERITOR**®



MERITOR®



**MERITOR®**



MERITOR®





**MERITOR®**



**MERITOR®**

© 2007 ArvinMeritor  
This catalogue may be used only to specify and sell  
products of ArvinMeritor its subsidiaries and affiliated  
companies. Use to specify and sell any other products  
is a copyright violation.

**ArvinMeritor Commercial  
Vehicle Aftermarket Ltd**  
Park Lane, Great Alne, Alcester,  
Warwickshire, B49 6HT, England  
Telephone Number: 0845 6067733

**ArvinMeritor Commercial  
Vehicle Aftermarket Ltd**  
Neugutstrasse 89,  
8600 Dübendorf, Switzerland  
Telephone Number : +41 44 824 8200

Issued 10/07



VIN 037



Distributed by:



**ArvinMeritor™**