



Air brake products

Druckluftbremsen

Equipo de frenos neumáticos

Produits freinage à air comprimé

Ricambi impianti frenanti

Travões a ar material

Elementy pneumatycznych układów hamulcowych

Детали для пневматических систем

Přístroje vzduchových brzdových systémů

CATALOGUE INDEX

O.E. NUMBER	DESCRIPTION	MAJORSELL REBUILT UNIT	MAJORSELL REPLACEMENT UNIT	UNIT PAGE	MAIN KIT	MAIN KIT PAGE
0481026022	VALVE		23D085	MISCV002.1	D63RK002A	MISCV003
0481039202	VALVE		23B050	MISCV001	B63RK004A	MISCV001
0481064105	FOOT VALVE		23J053	KV009	J63RK008A	KV010
0481064603	FOOT VALVE		23J047	KV009	J63RK008A	KV010
0500005001	LEV. VALVE		23D023	MISCV002	D63RK016A	MISCV003
0500005002	LEV. VALVE		23D024	MISCV002	D63RK016A	MISCV003
0500005006	LEV. VALVE		23D004	MISCV002	D63RK016A	MISCV003
0500005007	LEV. VALVE		23D005	MISCV002	D63RK016A	MISCV003
0500005012	LEV. VALVE		23D068	MISCV002	D63RK016A	MISCV003
0500005017	LEV. VALVE		23D002	MISCV002	D63RK016A	MISCV003
0500005018	LEV. VALVE		23D003	MISCV002	D63RK016A	MISCV003
0500005101	LEV. VALVE		23D075	MISCV002.1	D63RK016A	MISCV003
0500005102	LEV. VALVE		23D076	MISCV002.1	D63RK016A	MISCV003
0500005104	LEV. VALVE		23D069	MISCV002	D63RK016A	MISCV003
0500005105	LEV. VALVE		23D070	MISCV002.1	D63RK016A	MISCV003
050010006	N R VALVE		23E011	MISCV002.1		
065104	R12 VALVE		23D091	BXV002	D68RK012A	BXV003
065125	R12H VAVLE		23D101	BXV002	D68RK012A	BXV003
065476	VALVE		23D130	BXV002.1		
101100	FOOT VALVE		23J015	BXV005	J68RK005A	BXV007
101818	FOOT VALVE		23J066	BXV005.1	J68RK011A	BXV007
102626	R12 VALVE		23D093	BXV002	D68RK012A	BXV003
103009	R12 VALVE		23D103	BXV002	D68RK012A	BXV003
103010	R14H VALVE		23D108	BXV002	D68RK012A	BXV003
103028	R14 VALVE		23D105	BXV002	D68RK012A	BXV003
104574	R14H VALVE		23D110	BXV002.1	D68RK012A	BXV003
1186502	COMPRESSOR				A68RK104A	BX013
1186551	COMPRESSOR				A68RK105A	KZ1265-2
1186616	COMPRESSOR				A68RK105A	KZ1265-2
1186720	COMPRESSOR				A68RK094	KZ642
1186721	COMPRESSOR	68A070R			A68RK094	KZ642
1186722	COMPRESSOR	68A002R			A68RK094	KZ642
1188550	COMPRESSOR	68A042R			A68RK094	KZ642
1188748	COMPRESSOR				A68RK116A	BX015
1188844	COMPRESSOR				A68RK094	KZ642
1188889	COMPRESSOR				A68RK116A	BX015
1189085	COMPRESSOR				A68RK116A	BX015
1189100	COMPRESSOR				A68RK104A	BX013
1189106	COMPRESSOR	68A001R			A68RK094	KZ642
29103-1020	COMPRESSOR	60-060016			A60RK016	J007
1189107	COMPRESSOR				A68RK094	KZ642
1189140	COMPRESSOR				A68RK104A	BX013
1189174	COMPRESSOR	68A023R			A68RK117	BX016
1189198	COMPRESSOR				A68RK105A	KZ1265-2
1189209	COMPRESSOR				A68RK116A	BX015
1189385	COMPRESSOR	68A044R			A68RK105A	KZ1265-2
1189439	COMPRESSOR	68A009R			A68RK104A	BX013
1189495	COMPRESSOR				A68RK105A	KZ1265-2
1189495	COMPRESSOR				A68RK117	BX016
1189496	COMPRESSOR				A68RK104A	BX013
1189497	COMPRESSOR	68A018R			A68RK104A	BX013
1189498	COMPRESSOR	68A025R			A68RK104A	BX013
1189499	COMPRESSOR				A68RK105A	KZ1265-2
1189500	COMPRESSOR				A68RK105A	KZ1265-2
1-19100-220-0	COMPRESSOR		60A008		A60RK018	J009

ANY USE OF AN O.E NAME OR NUMBER IS FOR REFERENCE ONLY.
PARTS SUPPLIED BY MAJORSELL ARE MAJORSELL BRAND AND MAY NOT BE IDENTICAL TO THE O.E.

CATALOGUE INDEX

O.E. NUMBER	DESCRIPTION	MAJORSELL REBUILT UNIT	MAJORSELL REPLACEMENT UNIT	UNIT PAGE	MAIN KIT	MAIN KIT PAGE
1194125	COMPRESSOR	68A024R			A68RK118	LK3501
1194135	COMPRESSOR				A68RK118	LK4959
1194190	COMPRESSOR				A68RK105A	KZ1265-2
1194194	COMPRESSOR				A68RK118	LK4959
1194212	COMPRESSOR	68A026R			A68RK104A	BX013
1194215	COMPRESSOR	68A011R			A68RK105A	KZ1265-2
1194233	COMPRESSOR				A68RK115	LK4959
1194275	COMPRESSOR				A68RK115	LK4959
1194357	COMPRESSOR				A68RK115	LK4959
1194410	COMPRESSOR				A68RK115	LK4959
1194415	COMPRESSOR				A68RK115	LK4959
1194425	COMPRESSOR				A68RK115	LK4959
1194430	COMPRESSOR				A68RK115	LK4959
1194454	COMPRESSOR				A68RK115	LK4959
1194455	COMPRESSOR				A68RK115	LK4959
1194456	COMPRESSOR				A68RK115	LK4959
1194458	COMPRESSOR				A68RK115	LK4959
1194487	COMPRESSOR				A68RK115	LK4959
1441405000	COMPRESSOR				A67RK035	W001
1441405050	COMPRESSOR				A67RK035	W001
14501-97101	COMPRESSOR				A60RK032	J015
229500	FOOT VALVE		23J052	BXV005	J68RK011A	BXV007
229501	FOOT VALVE		23J043	BXV005	J68RK011A	BXV007
229859	Q R VALVE		23E017	BXV004	E68RK001	BXV004.1
267051	GOVERNOR		23B013	BXV001	B68RK003	BXV001
267098	GOVERNOR		23B013	BXV001	B68RK003	BXV001
274997	Q R VALVE		23E017	BXV004	E68RK001	BXV004.1
274999	Q R VALVE		23E012	BXV004	E68RK001	BXV004.1
275491	GOVERNOR		23B002	BXV001	B68RK003	BXV001
275508	GOVERNOR		23B001	BXV001	B68RK003	BXV001
277863	FOOT VALVE		23J044	BXV005	J68RK011A	BXV007
278998	FOOT VALVE		23J058	BXV005.1	J69RK011A	BXV007
279950	FOOT VALVE		23J059	BXV005.1	J68RK014A	BXV007
280375	R6 VALVE		23D017	BXV002	D68RK006A	BXV003
280479	CHECK VALVE		23E013	BXV004	E68RK002	BXV004.1
281672	RE6 VALVE		23D016	BXV002	D68RK003A	BXV003
284760	FOOT VALVE		23J060	BXV005.1	J68RK011A	BXV007
286171	FOOT VALVE		23J005	BXV005	J68RK005A	BXV007
286370	R8 VALVE		23D113	BXV002.1	D68RK004	BXV003
286771	E7 VALVE		23J070	BXV006	J68RK011A	BXV007
286773	FOOT VALVE		23J030	BXV005	J68RK011A	BXV007
286775	FOOT VALVE		23J036	BXV005	J68RK011A	BXV007
287114	R8 VALVE		23D116	BXV002.1		
287411	FOOT VALVE		23J063	BXV005.1	J68RK011A	BXV007
287564	FOOT VALVE		23J064	BXV005.1	J68RK011A	BXV007
288221	R8 VALVE		23D114	BXV002.1	D68RK004	BXV003
288383	FOOT VALVE		23J065	BXV005.1	J68RK011A	BXV007
295358	CHECK VALVE		23E055	BXV004	E68RK002	BXV004.1
29100-1803	COMPRESSOR		60A003		A60RK009	J003
29100-1840	COMPRESSOR		60A002		A60RK008	J002
29100-1872	COMPRESSOR		60A005		A60RK014	J005
29100-1891	COMPRESSOR		60A002		A60RK015	J006
29100-1961	COMPRESSOR		60A005		A60RK014	J005
29100-2065	COMPRESSOR		60A001		A60RK001	J001
29100-2123	COMPRESSOR		60A006		A60RK016	J007

ANY USE OF AN O.E NAME OR NUMBER IS FOR REFERENCE ONLY.
PARTS SUPPLIED BY MAJORSELL ARE MAJORSELL BRAND AND MAY NOT BE IDENTICAL TO THE O.E.

CATALOGUE INDEX

O.E. NUMBER	DESCRIPTION	MAJORSELL REBUILT UNIT	MAJORSELL REPLACEMENT UNIT	UNIT PAGE	MAIN KIT	MAIN KIT PAGE
29100-2151	COMPRESSOR		60A004		A60RK010	J004
29100-2364	COMPRESSOR		60A007		A60RK017	J008
295036	CHECK VALVE		23E013	BXV004		
295579	FOOT VALVE		23J005	BXV005	J68RK005A	BXV007
320060112	FOOT VALVE		23J074	MISCV004	J65RK001	MISCV004
4005000810	CONTROL VALVE		23M007	WV023		
4071300115	COMPRESSOR				A67RK026	OM402
4071300515	COMPRESSOR		23A001		A67RK026	OM402
4110345010	COMPRESSOR				A67RK001	W038
4110345310	COMPRESSOR				A67RK001	W038
4110345410	COMPRESSOR				A67RK001	W038
4110345460	COMPRESSOR				A67RK001	W038
4110345470	COMPRESSOR				A67RK001	W038
4110345610	COMPRESSOR				A67RK001	W038
4110425000	COMPRESSOR				A67RK001	W038
4110425010	COMPRESSOR				A67RK001	W038
4110425010	COMPRESSOR				A67RK001	W038
4110425020	COMPRESSOR				A67RK001	W038
4110425120	COMPRESSOR				A67RK001	W038
4110425200	COMPRESSOR				A67RK001	W038
4110425220	COMPRESSOR				A67RK001	W038
4110426000	COMPRESSOR				A67RK001	W038
4110426010	COMPRESSOR				A67RK001	W038
4110428000	COMPRESSOR				A67RK001	W038
4110428050	COMPRESSOR				A67RK001	W038
4110428070	COMPRESSOR				A67RK001	W038
4110428080	COMPRESSOR				A67RK001	W038
4110428200	COMPRESSOR				A67RK001	W038
4110428450	COMPRESSOR				A67RK001	W038
4110435010	COMPRESSOR				A67RK001	W038
4110435020	COMPRESSOR				A67RK001	W038
4110435220	COMPRESSOR				A67RK001	W038
4110435260	COMPRESSOR				A67RK001	W038
4110435710	COMPRESSOR				A67RK001	W038
4110435720	COMPRESSOR				A67RK001	W038
4110438000	COMPRESSOR				A67RK001	W038
4110438010	COMPRESSOR				A67RK001	W038
4110438050	COMPRESSOR				A67RK001	W038
4110438070	COMPRESSOR				A67RK001	W038
4110438200	COMPRESSOR				A67RK001	W038
4110438210	COMPRESSOR				A67RK001	W038
4110438440	COMPRESSOR				A67RK001	W038
4110438450	COMPRESSOR				A67RK001	W038
4111400000	COMPRESSOR	67A012R			A67RK035	W001
4111400010	COMPRESSOR				A67RK035	W001
4111400020	COMPRESSOR				A67RK035	W001
4111400030	COMPRESSOR				A67RK035	W001
4111405010	COMPRESSOR				A67RK035	W001
4111405020	COMPRESSOR				A67RK035	W001
4111405070	COMPRESSOR				A67RK035	W001
4111408000	COMPRESSOR				A67RK035	W001
4111408010	COMPRESSOR				A67RK035	W001
4111408020	COMPRESSOR				A67RK035	W001
4111408380	COMPRESSOR				A67RK035	W001
4111408390	COMPRESSOR				A67RK035	W001

ANY USE OF AN O.E NAME OR NUMBER IS FOR REFERENCE ONLY.
PARTS SUPPLIED BY MAJORSELL ARE MAJORSELL BRAND AND MAY NOT BE IDENTICAL TO THE O.E.

CATALOGUE INDEX

O.E. NUMBER	DESCRIPTION	MAJORSELL REBUILT UNIT	MAJORSELL REPLACEMENT UNIT	UNIT PAGE	MAIN KIT	MAIN KIT PAGE
4111408400	COMPRESSOR				A67RK035	W001
4111408410	COMPRESSOR				A67RK035	W001
4111408450	COMPRESSOR				A67RK035	W001
4111408460	COMPRESSOR				A67RK035	W001
4111408470	COMPRESSOR				A67RK035	W001
4111408480	COMPRESSOR				A67RK035	W001
4111408490	COMPRESSOR				A67RK035	W001
4111409100	COMPRESSOR				A67RK035	W001
4111409300	COMPRESSOR				A67RK035	W001
4111410000	COMPRESSOR				A67RK035	W002
4111410010	COMPRESSOR	67A013R			A67RK035	W002
4111410020	COMPRESSOR				A67RK035	W002
4111415000	COMPRESSOR				A67RK035	W002
4111415010	COMPRESSOR				A67RK035	W002
4111415030	COMPRESSOR				A67RK035	W002
4111415060	COMPRESSOR				A67RK035	W002
4111415070	COMPRESSOR				A67RK035	W002
4111415500	COMPRESSOR				A67RK048	W003
4111415510	COMPRESSOR				A67RK048	W003
4111416020	COMPRESSOR				A67RK035	W002
4111416400	COMPRESSOR	67A022R			A67RK035	W002
4111417020	COMPRESSOR				A67RK035	W002
4111417110	COMPRESSOR				A67RK035	W002
4111417130	COMPRESSOR				A67RK035	W002
4111418000	COMPRESSOR				A67RK035	W002
4111418040	COMPRESSOR				A67RK035	W002
4111418050	COMPRESSOR				A67RK035	W002
4111418160	COMPRESSOR	67A023R			A67RK035	W002
4111418180	COMPRESSOR				A67RK035	W002
4111418350	COMPRESSOR				A67RK035	W002
4111418450	COMPRESSOR				A67RK035	W002
4111418460	COMPRESSOR				A67RK035	W002
4111419100	COMPRESSOR				A67RK035	W002
4111419300	COMPRESSOR				A67RK035	W002
4111425660	COMPRESSOR				A67RK024	W004
4111426810	COMPRESSOR				A67RK024	W004
4111427110	COMPRESSOR				A67RK024	W004
4111428050	COMPRESSOR				A67RK024	W004
4111428160	COMPRESSOR				A67RK024	W004
4111428180	COMPRESSOR				A67RK024	W004
4111428450	COMPRESSOR				A67RK024	W004
4111428500	COMPRESSOR				A67RK024	W004
4111428800	COMPRESSOR				A67RK024	W004
4111429600	COMPRESSOR				A67RK024	W004
4111436020	COMPRESSOR				A67RK024	W005
4111436820	COMPRESSOR				A67RK024	W005
4111436930	COMPRESSOR				A67RK024	W005
4111438050	COMPRESSOR				A67RK024	W005
4111438440	COMPRESSOR				A67RK024	W005
4111438450	COMPRESSOR				A67RK024	W005
4111438610	COMPRESSOR				A67RK024	W005
4111438810	COMPRESSOR				A67RK024	W005
4111438830	COMPRESSOR				A67RK024	W005
4111450010	COMPRESSOR				A67RK035	W006
4111450030	COMPRESSOR				A67RK035	W006

ANY USE OF AN O.E NAME OR NUMBER IS FOR REFERENCE ONLY.
PARTS SUPPLIED BY MAJORSELL ARE MAJORSELL BRAND AND MAY NOT BE IDENTICAL TO THE O.E.

CATALOGUE INDEX

O.E. NUMBER	DESCRIPTION	MAJORSELL REBUILT UNIT	MAJORSELL REPLACEMENT UNIT	UNIT PAGE	MAIN KIT	MAIN KIT PAGE
4111450040	COMPRESSOR				A67RK035	W006
4111450050	COMPRESSOR				A67RK035	W006
4111450510	COMPRESSOR				A67RK055	W007
4111450520	COMPRESSOR				A67RK055	W007
4111450530	COMPRESSOR				A67RK055	W007
4111450570	COMPRESSOR				A67RK055	W007
4111455050	COMPRESSOR				A67RK055	W007
4111455070	COMPRESSOR				A67RK055	W007
4111455120	COMPRESSOR				A67RK055	W007
4111470000	COMPRESSOR				A67RK053	W008
4111470500	COMPRESSOR				A67RK053	W008
4111470580	COMPRESSOR				A67RK053	W008
4111470590	COMPRESSOR				A67RK053	W008
4111470640	COMPRESSOR				A67RK053	W008
4111470650	COMPRESSOR				A67RK053	W008
4111470660	COMPRESSOR				A67RK053	W008
4111510000	COMPRESSOR	67A054R			A67RK057	W009
4111510030	COMPRESSOR				A67RK060	W010
4111510040	COMPRESSOR				A67RK059	W015
4111530000	COMPRESSOR				A67RK057	W009
4111540000	COMPRESSOR	67A020R			A67RK060	W010
4123520010	COMPRESSOR				A67RK066	W011
4123520020	COMPRESSOR	67A056R			A67RK066	W011
4123520030	COMPRESSOR	67A033R			A67RK063	W012
4123520040	COMPRESSOR				A67RK067	W013
4123520050	COMPRESSOR	67A028R			A67RK067	W013
4123520060	COMPRESSOR				A67RK062	W014
4123520070	COMPRESSOR				A67RK062	W014
4123520080	COMPRESSOR				A67RK063	W012
4123520090	COMPRESSOR				A67RK062	W014
4123520100	COMPRESSOR	67A007R			A67RK062	W014
4123520110	COMPRESSOR	67A034R			A67RK062	W014
4123520130	COMPRESSOR				A67RK062	W014
4123520140	COMPRESSOR				A67RK062	W014
4123520150	COMPRESSOR	67A021R			A67RK062	W014
4123520160	COMPRESSOR				A67RK062	W014
4126360000	COMPRESSOR				A67RK069	W016
4127040000	COMPRESSOR	67A026R			A67RK084	W017A
4127040010	COMPRESSOR	67A027R			A67RK068	W017
	COMPRESSOR				A67RK068	W017
4127040040	COMPRESSOR	67A047R			A67RK068	W017
4127040050	COMPRESSOR	67A046R			A67RK068	W017
4127040070	COMPRESSOR				A67RK084	W017A
4127040080	COMPRESSOR	67A041R			A67RK068	W017
4127040100	COMPRESSOR				A67RK084	W017A
4127040110	COMPRESSOR				A67RK084	W017A
4127040120	COMPRESSOR	67A042R			A67RK084	W017A
4127040130	COMPRESSOR				A67RK084	W017A
4127040140	COMPRESSOR	67A044R			A67RK084	W017A
4127040150	COMPRESSOR				A67RK084	W017A
4325000200	FILTER		23E018	WV013.1		
4340140000	N R VALVE		23E019	WV013.1	E67RK022A	WV015
4341001240	VALVE		23E002	WV013	E67RK009A	WV015
4341002200	VALVE		23E056	WV014.1	E67RK009A	WV015
4341002220	VALVE		23E001	WV013	E67RK009A	WV015

ANY USE OF AN O.E NAME OR NUMBER IS FOR REFERENCE ONLY.
PARTS SUPPLIED BY MAJORSELL ARE MAJORSELL BRAND AND MAY NOT BE IDENTICAL TO THE O.E.

CATALOGUE INDEX

O.E. NUMBER	DESCRIPTION	MAJORSELL REBUILT UNIT	MAJORSELL REPLACEMENT UNIT	UNIT PAGE	MAIN KIT	MAIN KIT PAGE
4342020000	CHECK VALVE		23E032	WV014	E68RK001	BXV003.1
4342080000	CHECK VALVE		23E020	WV013.1		
4343000000	VALVE		23E003	WV013	E67RK015	WV015
4410329212	SENSOR CABLE		23M011	WV023.1		
4410329222	SENSOR CABLE		23M010	WV023.1		
4410435041	SENSOR		23M009	WV023.1		
441050080	HEIGHT SENSOR		23M002	WV023		
4410500100	HEIGHT SENSOR		23M003	WV023		
4410500110	HEIGHT SENSOR		23M001	WV023		
4410500120	HEIGHT SENSOR		23M015	WV023.1	L67RK006A	
4460043100	CONTROLLER		23M008	WV023		
4471301815	COMPRESSOR				A67RK026	OM402
4520021070	STOP COCK		23E021	WV013.1		
4522000110	COUPLING		23E022	WV013.1		
4522000120	COUPLING		23E023	WV013.1		
4522002110	COUPLING		23E024	WV013.1		
4522002120	COUPLING		23E025	WV013.1		
4613072000	FOOT VALVE		23J008	WV019	J67RK003A	WV022
4613072020	FOOT VALVE		23J017	WV019.1	J67RK003	WV022
4613072040	FOOT VALVE		23J018	WV019.1	J67RK003A	WV022
4613073700	FOOT VALVE		23J019	WV019.1	J67RK003A	WV022
4613074000	FOOT VALVE		23J024	WV020	J67RK003A	WV022
4613074390	FOOT VALVE		23J025	WV020	J67RK003A	WV022
4613074590	FOOT VALVE		23J026	WV020	J67RK003A	WV022
4613074670	FOOT VALVE		23J027	WV020	J67RK003A	WV022
4613074750	FOOT VALVE		23J028	WV020	J67RK003A	WV022
4613074760	FOOT VALVE		23J029	WV020	J67RK003A	WV022
4613074790	FOOT VALVE		23J002	WV019	J67RK003A	WV022
4613075000	FOOT VALVE		23J020	WV019.1	J67RK003A	WV022
4613075160	FOOT VALVE		23J021	WV019.1	J67RK003A	WV022
4613075200	FOOT VALVE		23J022	WV019.1	J67RK003A	WV022
4613075210	FOOT VALVE		23J023	WV019.1	J67RK003A	WV022
4613150080	FOOT VALVE		23J001	WV019	J67RK001A	WV022
4613150090	FOOT VALVE		23J035	WV020.1	J67RK001A	WV022
4613150120	FOOT VALVE		23J033	WV020.1	J67RK001A	WV022
4613150170	FOOT VALVE		23J037	WV020.1	J67RK001A	WV022
4613150360	FOOT VALVE		23J006	WV019	J67RK001A	WV022
4613150400	FOOT VALVE		23J051	WV021	J67RK001A	WV022
4613150420	FOOT VALVE		23J032	WV020	J67RK014	WV022
4613150470	FOOT VALVE		23J040	WV020.1	J67RK001A	WV022
4613151800	FOOT VALVE		23J046	WV020.1	J67RK017A	WV022
4613152530	FOOT VALVE		23J038	WV020.1		
4613152580	FOOT VALVE		23J062	WV021	J67RK008A	WV022
4613154820	FOOT VALVE		23J034	WV020.1	J67RK001A	WV022
4613154970	FOOT VALVE		23J009	WV019	J67RK001A	WV022
4613170140	FOOT VALVE		23J039	WV020.1	J67RK001A	WV022
4613190080	FOOT VALVE		23J004	WV019	J67RK009A	WV022
4613190180	FOOT VALVE		23J010	WV019		
4613190280	FOOT VALVE		23J011	WV019.1		
4613190320	FOOT VALVE		23J012	WV019.1	J67RK001A	WV022
4613192500	FOOT VALVE		23J055	WV021	J67RK015A	WV022
4613245200	FOOT VALVE		23J057	WV021	J67RK018A	WV022
4614820990	FOOT VALVE		23J041	WV020.1		
4614911020	FOOT VALVE		23J007	WV019	J67RK003A	WV022
4614912740	FOOT VALVE		23J031	WV020	J67RK003A	WV022

ANY USE OF AN O.E NAME OR NUMBER IS FOR REFERENCE ONLY.
PARTS SUPPLIED BY MAJORSELL ARE MAJORSELL BRAND AND MAY NOT BE IDENTICAL TO THE O.E.

CATALOGUE INDEX

O.E. NUMBER	DESCRIPTION	MAJORSELL REBUILT UNIT	MAJORSELL REPLACEMENT UNIT	UNIT PAGE	MAIN KIT	MAIN KIT PAGE
4614990000	FOOT VALVE		23J014	WV019.1	J67RK005A	WV022
4630131120	VALVE		23E004	WV013	E67RK023A	WV015
4630131140	VALVE		23E005	WV013	E67RK023A	WV015
4630220210	VALVE		23E030	WV014	E67RK006	WV015
4630320200	HAND VALVE		23H014	WV016.1		
4630360000	VALVE		23E034	WV014		
4637031000	TEST POINT		23E040	WV014		
4637051020	TEST POINT		23E042	WV014.1		
4640023100	VALVE		23D012	WV007	D67RK040A	WV011.1
4640023320	LEV. VALVE		23D061	WV008	D67RK040A	WV011.1
4640023380	LEV. VALVE		23D062	WV008	D67RK040A	WV011.1
4640023390	LEV. VALVE		23D063	WV008	D67RK040A	WV011.1
4640023600	LEV. VALVE		23D064	WV008	D67RK040A	WV011.1
4640024400	LEV. VALVE		23D065	WV008.1	D67RK040A	WV011.1
4640025300	LEV. VALVE		23D066	WV008.1	D67RK040A	WV011.1
4640060000	LEV. VALVE		23D049	WV008	D67RK046A	WV012
4640060020	LEV. VALVE		23D047	WV008	D67RK046A	WV012
4640060030	LEV. VALVE		23D127	WV009.1	D67RK041A	WV011.1
4640061000	LEV. VALVE		23D048	WV008	D67RK046A	WV012
4640070010	LEV. VALVE		23D050	WV008	D67RK049A	WV012
4640070030	LEV. VALVE		23D129	WV009.1	D67RK049A	WV012
4640070100	VALVE		23D090	WV009	D67RK049A	WV012
4714010100	VALVE		23D036	WV007.1	D67RK005A	WV011
4721950000	ABS VALVE		23M017	WV023.1	L67RK006A	
4721950050	SOLENOID		23M013	WV023.1	L67RK006A	
4721950110	ABS VALVE		23M016	WV023.1	L67RK006A	
4721950180	CONTROL VALVE		23M004	WV023	L67RK006A	
4721950300	VALVE		23D119	WV009		
4721950310	RELAY VALVE		23D120	WV009		
4721950410	RELAY VALVE		23D122	WV009.1	D67RK054A	WV012
4721950520	SOLENOID		23M014	WV023.1	L67RK006A	
4730170000	VALVE		23D001	WV007	D67RK027A	WV012
4735010000	Q R VALVE		23E033	WV014	E68RK001	BXV003.1
4750100260	VALVE		23D033	WV007.1	D67RK048A	WV012
4750103000	VALVE		23B095	WV004.1	B67RK004A	WV005
4750104000	VALVE		23D014	WV007.1	D67RK004A	WV011
4750154000	VALVE		23B094	WV004	B67RK036A	WV006
4753042010	VALVE		23B003	WV001	B67RK023A	WV005.1
4756040100	VALVE		23D032	WV007.1	D67RK039A	WV011.1
4756040110	VALVE		23B006	WV001	B67RK039A	WV006
4757010200	VALVE		23D035	WV007.1	D67RK029A	WV011.1
4757010510	VALVE		23D081	WV008.1	D67RK029A	WV011.1
4757100200	VALVE		23D006	WV007	D67RK004	WV011
4757110000	VALVE		23D082	WV008.1	D67RK030A	WV011.1
4757111260	VALVE		23D144	WV010	D67RK030A	WV011.1
4757120000	VALVE		23D080	WV008.1	D67RK023	WV011.1
4757130000	VALVE		23D078	WV008.1	D67RK042A	WV012
4757150000	VALVE		23D079	WV008.1	D67RK039A	WV011.1
4757155000	VALVE		23D034	WV007.1	D67RK039A	WV011.1
4801020100	CONTROL VALVE		23M006	WV023		
4802020050	VALVE		23D143	WV010	D67RK052A	WV012
4802040020	VALVE		23D142	WV010	D67RK053A	WV012
622045	CLUTCH SERVO		23F080	KGCS002.1	F77RK010	KGCSK001
622107	CLUTCH SERVO		23F011	KGCS001	F77RK005	KGCSK001
622109	CLUTCH SERVO		23F075	KGCS002	F77RK002	KGCSK001

ANY USE OF AN O.E NAME OR NUMBER IS FOR REFERENCE ONLY.
PARTS SUPPLIED BY MAJORSELL ARE MAJORSELL BRAND AND MAY NOT BE IDENTICAL TO THE O.E.

CATALOGUE INDEX

O.E. NUMBER	DESCRIPTION	MAJORSELL REBUILT UNIT	MAJORSELL REPLACEMENT UNIT	UNIT PAGE	MAIN KIT	MAIN KIT PAGE
622110	CLUTCH SERVO		23F055	KGCS002	F77RK002	KGCSK001
622190	CLUTCH SERVO		23F010	KGCS001	F77RK007	KGCSK001
622199	CLUTCH SERVO		23F019	KGCS001	F77RK007	KGCSK001
622504	CLUTCH SERVO		23F024	KGCS001	F77RK011	KGCSK001
623104	MASTER CYL.		23K016	MC001.1		NO KIT
623105	MASTER CYL.		23K017	MC001.1		NO KIT
623106	MASTER CYL.		23K018	MC001.1		NO KIT
623109	MASTER CYL.		23K002	MC001	-	NO KIT
623160	MASTER CYL.		23K001	MC001	-	NO KIT
624199	CLUTCH SERVO		23F021	KGCS001	F77RK007	KGCSK001
624248	MASTER CYL.		23K019	MC001.1		NO KIT
624502	MASTER CYL.		23K004	MC001	-	NO KIT
624503	MASTER CYL.		23K005	MC001	-	NO KIT
625290	CLUTCH SERVO		23F025	KGCS001	F77RK012	KGCSK001
625359	CLUTCH SERVO		23F020	KGCS001	F77RK016	KGCSK001.1
625375	CLUTCH SERVO		23F056	KGCS002	F77RK029	KGCSK001.1
625384	CLUTCH SERVO		23F031	KGCS001.1	F77RK019	KGCSK001.1
625436	CLUTCH SERVO		23F054	KGCS002	F77RK028	KGCSK001.1
625524	CLUTCH SERVO		23F030	KGCS001.1	F77RK021	KGCSK001.1
625671	CLUTCH SERVO		23F053	KGCS002	F77RK018	KGCSK001.1
626159	MASTER CYL.		23K020	MC001.1		NO KIT
626162	CLUTCH SERVO		23F029	KGCS001.1	F77RK020	KGCSK001.1
626392	CLUTCH SERVO		23F008	KGCS001	F77RK004A	KGCSK001
626397	CLUTCH SERVO		23F066	KGCS002	F77RK024	KGCSK001
626639	CLUTCH SERVO		23F009	KGCS001	F77RK031/032	KGCSK001.1
626693	CLUTCH SERVO		23F050	KGCS002	F77RK011	KGCSK001
626760	MASTER CYL.		23K011	MC001		NO KIT
626761	MASTER CYL.		23K012	MC001		NO KIT
626762	MASTER CYL.		23K013	MC001.1		NO KIT
626853	CLUTCH SERVO		23F032	KGCS001.1	F77RK022	KGCSK001.1
627052	CLUTCH SERVO		23F052	KGCS002	F77RK027	KGCSK001.1
627497	CLUTCH SERVO		23F028	KGCS001.1	F77RK019	KGCSK001.1
627498	CLUTCH SERVO		23F027	KGCS001.1	F77RK019	KGCSK001.1
627499	CLUTCH SERVO		23F026	KGCS001	F77RK019	KGCSK001.1
627612	CLUTCH SERVO		23F081	KGCS002.1	F77RK036	KGCSK001.1
628027	CLUTCH SERVO		23F033	KGCS001.1	F77RK028	KGCSK001.1
628036	CLUTCH SERVO		23F058	KGCS002	F77RK025	KGCSK001.1
628258	CLUTCH SERVO		23F044	KGCS001.1	F77RK018	KGCSK001.1
628259	CLUTCH SERVO		23F045	KGCS001.1	F77RK008	KGCSK001
628260	CLUTCH SERVO		23F042	KGCS001.1	F77RK018	KGCSK001.1
628275	CLUTCH SERVO		23F023	KGCS001	F77RK018	KGCSK001.1
628276	CLUTCH SERVO		23F049	KGCS001.1	F77RK008	KGCSK001
628277	CLUTCH SERVO		23F022	KGCS001	F77RK008	KGCSK001
628447	CLUTCH SERVO		23F048	KGCS001.1	F77RK025	KGCSK001.1
628448	CLUTCH SERVO		23F043	KGCS001.1	F77RK018	KGCSK001.1
628449	CLUTCH SERVO		23F046	KGCS001.1	F77RK018	KGCSK001.1
628450	CLUTCH SERVO		23F047	KGCS001.1	F77RK025	KGCSK001.1
628492	CLUTCH SERVO		23F059	KGCS002	F77RK030	KGCSK001.1
628493	CLUTCH SERVO		23F060	KGCS002	F77RK030	KGCSK001.1
628494	CLUTCH SERVO		23F057	KGCS002	F77RK030	KGCSK001.1
800629	FOOT VALVE		23J067	BXV005.1		
800630	FOOT VALVE		23J068	BXV005.1		
800631	FOOT VALVE		23J069	BXV005.1		
800632	FOOT VALVE		23J016	BXV005	J68RK005A	BXV007
8946011322	ABS CABLE		23M005	WV023		

ANY USE OF AN O.E NAME OR NUMBER IS FOR REFERENCE ONLY.
PARTS SUPPLIED BY MAJORSELL ARE MAJORSELL BRAND AND MAY NOT BE IDENTICAL TO THE O.E.

CATALOGUE INDEX

O.E. NUMBER	DESCRIPTION	MAJORSELL REBUILT UNIT	MAJORSELL REPLACEMENT UNIT	UNIT PAGE	MAIN KIT	MAIN KIT PAGE
9111410010	COMPRESSOR	67A025R			A67RK037	W018
9111420000	COMPRESSOR				A67RK036	W019
9111450020	COMPRESSOR				A67RK037	W018
9111450500	COMPRESSOR	67A031R			A67RK038	W020
9111450600	COMPRESSOR	67A016R			A67RK047	W021
9111455000	COMPRESSOR				A67RK038	W020
9111455600	COMPRESSOR	67A066R			A67RK047	W021
9111460030	COMPRESSOR	67A055R			A67RK036	W019
9111530000	COMPRESSOR				A67RK057	W009
9111530010	COMPRESSOR				A67RK057	W009
9111535100	COMPRESSOR	67A024R			A67RK058	W022
9111545000	COMPRESSOR	67A014R			A67RK070	W023
9111545020	COMPRESSOR				A67RK070	W023
9111545150	COMPRESSOR				A67RK070	W023
9115010000	COMPRESSOR				A67RK005	W024
9115010010	COMPRESSOR				A67RK005	W024
9115010100	COMPRESSOR				A67RK005	W024
9115010110	COMPRESSOR				A67RK005	W024
9115010150	COMPRESSOR	67A003R			A67RK005	W024
9115010160	COMPRESSOR	67A004R			A67RK005	W024
9115010550	COMPRESSOR				A67RK005	W024
9115010560	COMPRESSOR				A67RK005	W024
9115010570	COMPRESSOR				A67RK005	W024
9115010580	COMPRESSOR				A67RK005	W024
9115010590	COMPRESSOR	67A015R			A67RK005	W024
9115010600	COMPRESSOR	67A005R			A67RK006	W025
9115010610	COMPRESSOR	67A006R			A67RK006	W025
9115010620	COMPRESSOR				A67RK006	W025
9115010630	COMPRESSOR				A67RK005	W024
9115030500	COMPRESSOR				A67RK017	W026
9115030510	COMPRESSOR	67A037R			A67RK017	W026
9115031000	COMPRESSOR				A67RK017	W026
9115040500	COMPRESSOR				A67RK025	W027
9115040510	COMPRESSOR				A67RK025	W027
9115040520	COMPRESSOR	67A018R			A67RK025	W027
9115040560	COMPRESSOR	67A019R			A67RK056	W028
9115040590	COMPRESSOR				A67RK056	W028
9115040600	COMPRESSOR	67A009R			A67RK056	W028
9115045000	COMPRESSOR	67A010R			A67RK054	W029
9115045010	COMPRESSOR	67A029R			A67RK054	W029
9115045030	COMPRESSOR	67A045R			A67RK054	W029
9115045040	COMPRESSOR	67A038R			A67RK082	W031
9115045050	COMPRESSOR	67A039R			A67RK082	W031
9115050500	COMPRESSOR				A67RK034	W030
9115051500	COMPRESSOR	67A001R			A67RK034	W030
9115051500	COMPRESSOR	67A001R			A67RK019	W032
9115051510	COMPRESSOR	67A002R			A67RK019	W032
9115051530	COMPRESSOR				A67RK019	W032
9115051540	COMPRESSOR	67A035R			A67RK019	W032
9115060500	COMPRESSOR	67A017R			A67RK042	W033
9115060520	COMPRESSOR				A67RK049	W034
9115060530	COMPRESSOR				A67RK042	W033
9115060540	COMPRESSOR	67A058R			A67RK049	W034
9115065000	COMPRESSOR	67A050R			A67RK039	W035
9115065010	COMPRESSOR				A67RK039	W035

ANY USE OF AN O.E NAME OR NUMBER IS FOR REFERENCE ONLY.
PARTS SUPPLIED BY MAJORSELL ARE MAJORSELL BRAND AND MAY NOT BE IDENTICAL TO THE O.E.

CATALOGUE INDEX

O.E. NUMBER	DESCRIPTION	MAJORSELL REBUILT UNIT	MAJORSELL REPLACEMENT UNIT	UNIT PAGE	MAIN KIT	MAIN KIT PAGE
9115065040	COMPRESSOR				A67RK050	W036
9115065050	COMPRESSOR				A67RK050	W036
9115530000	COMPRESSOR				A67RK069	W016
9115530010	COMPRESSOR				A67RK069	W016
9115530020	COMPRESSOR				A67RK073	W037
9115530030	COMPRESSOR				A67RK069	W016
9115531000	COMPRESSOR				A67RK073	W037
9115531010	COMPRESSOR				A67RK073	W037
9115531020	COMPRESSOR				A67RK073	W037
9115531030	COMPRESSOR				A67RK073	W037
9115531040	COMPRESSOR				A67RK073	W037
9115531050	COMPRESSOR				A67RK073	W037
9343000010	TILT VALVE		23E015	WV013		
9347010000	VALVE		23B043	WV002	B67RK014A	WV005.1
9347020400	QUAD VALVE		23B009	WV001	B67RK002A	WV005
9347020410	QUAD VALVE		23B083	WV004	B67RK002A	WV005
9347020420	QUAD VALVE		23B017	WV001.1	B67RK002A	WV005
9347021920	QUAD VALVE		23B049	WV002.1	B67RK007A	WV005
9347022100	QUAD VALVE		23B007	WV001	B67RK007A	WV005
9347022110	QUAD VALVE		23B093	WV004		
9347022200	QUAD VALVE		23B020	WV001.1	B67RK007A	WV005
9347022210	QUAD VALVE		23B045	WV002	B67RK011A	WV005
9347022230	QUAD VALVE		23B021	WV001.1	B67RK015A	WV005.1
9347022400	QUAD VALVE		23B022	WV001.1	B67RK002A	WV005
9347022500	QUAD VALVE		23B012	WV001	B67RK007A	WV005
9347022600	QUAD VALVE		23B060	WV002.1	B67RK007A	WV005
9347023000	QUAD VALVE		23B077	WV003.1	B67RK006A	WV005
9347023020	QUAD VALVE		23B088	WV004	B67RK006A	WV005
9347023200	QUAD VALVE		23B078	WV003.1	B67RK003A	WV005
9347023220	QUAD VALVE		23B024	WV001.1	B67RK015A	WV005.1
9347023400	QUAD VALVE		23B079	WV003.1	B67RK010A	WV005
9347023800	QUAD VALVE		23B080	WV003.1	B67RK008A	WV005
9347023810	QUAD VALVE		23B025	WV001.1	B67RK008A	WV005
9347050050	VALVE		23B085	WV004	B67RK020A	WV005.1
9347130040	QUAD VALVE		23B058	WV002.1	B67RK030A	WV005.1
9347130350	QUAD VALVE		23B081	WV003.1	B67RK030A	WV005.1
9347140010	QUAD VALVE		23B061	WV003	B67RK037A	WV006
9347140030	QUAD VALVE		23B059	WV002.1	B67RK037A	WV006
9347140040	QUAD VALVE		23B047	WV002.1	B67RK037A	WV006
9347140050	QUAD VALVE		23B014	WV001	B67RK037A	WV006
9347140060	QUAD VALVE		23B016	WV001	B67RK037A	WV006
9347140090	QUAD VALVE		23B067	WV003	B67RK037A	WV006
9347140100	QUAD VALVE		23B068	WV003	B67RK037A	WV006
9347140110	QUAD VALVE		23B052	WV002.1	B67RK037A	WV006
9347140120	QUAD VALVE		23B019	WV001.1	B67RK037A	WV006
9347140130	QUAD VALVE		23B055	WV002.1	B67RK037A	WV006
9347140140	QUAD VALVE		23B023	WV001.1	B67RK037A	WV006
9347140150	QUAD VALVE		23B062	WV003	B67RK037A	WV006
9347140170	QUAD VALVE		23B064	WV003	B67RK037A	WV006
9347140180	QUAD VALVE		23B065	WV003	B67RK037A	WV006
9347140220	QUAD VALVE		23B069	WV003	B67RK037A	WV006
9347140280	QUAD VALVE		23B054	WV002.1	B67RK037A	WV006
9347140340	QUAD VALVE		23B070	WV003.1	B67RK037A	WV006
9347140370	QUAD VALVE		23B066	WV003	B67RK037A	WV006
9347140400	QUAD VALVE		23B071	WV003.1	B67RK037A	WV006

ANY USE OF AN O.E NAME OR NUMBER IS FOR REFERENCE ONLY.
PARTS SUPPLIED BY MAJORSELL ARE MAJORSELL BRAND AND MAY NOT BE IDENTICAL TO THE O.E.

CATALOGUE INDEX

O.E. NUMBER	DESCRIPTION	MAJORSELL REBUILT UNIT	MAJORSELL REPLACEMENT UNIT	UNIT PAGE	MAIN KIT	MAIN KIT PAGE
9347140410	QUAD VALVE		23B072	WV003.1	B67RK037A	WV006
9347141090	QUAD VALVE		23B092	WV004	B67RK037A	WV006
9347141100	QUAD VALVE		23B091	WV004	B67RK037A	WV006
934714230	QUAD VALVE		23B098	WV004.1	B67RK037A	WV006
9347141250	QUAD VALVE		23B098	WV003.1	B67RK037A	WV006
9347141260	QUAD VALVE		23B074	WV003.1	B67RK037A	WV006
9347141510	QUAD VALVE		23B084	WV004		
9522000210	COUPLING		23E026	WV013.1		
9522000220	COUPLING		23E027	WV013.1		
9522002210	COUPLING		23E028	WV014		
9522002220	COUPLING		23E029	WV014		
9617221560	HAND VALVE		23H043	WV017.1	H67RK014	WV018.1
9617222320	HAND VALVE		23H030	WV017.1	H67RK012A	WV018.1
9617222640	HAND VALVE		23H041	WV017.1	H67RK013A	WV018.1
9617222690	HAND VALVE		23H042	WV017.1	H67RK012A	WV018.1
9617222720	HAND VALVE		23H025	WV017	H67RK012A	WV018.1
9617222750	HAND VALVE		23H026	WV017	H67RK013A	WV018.1
9617223050	HAND VALVE		23H027	WV017	H67RK012A	WV018.1
9617223140	HAND VALVE		23H035	WV017.1	H67RK012A	WV018.1
9617223240	HAND VALVE		23H028	WV017	H67RK012A	WV018.1
9617230380	HAND VALVE		23H037	WV017.1	H67RK017	WV018.1
9617231040	HAND VALVE		23H021	WV017	H67RK017	WV018.1
9617231070	HAND VALVE		23H023	WV017	H67RK017	WV018.1
9617231080	HAND VALVE		23H022	WV017	H67RK017	WV018.1
9617231110	HAND VALVE		23H036	WV017.1	H67RK017	WV018.1
9617231180	HAND VALVE		23H024	WV017	H67RK017	WV018.1
9617231220	HAND VALVE		23H033	WV017.1		
9617231250	HAND VALVE		23H032	WV017.1		
9617232040	HAND VALVE		23H045	WV018	H67RK017	WV018.1
9617232080	HAND VALVE		23H044	WV018	H67RK017	WV018.1
9617011000	HAND VALVE		23H003	WV016	H67RK019	WV018.1
9617011100	HAND VALVE		23H004	WV016	H67RK019	WV018.1
9617020010	HAND VALVE		23H013	WV016.1	H67RK019	WV018.1
9617020050	HAND VALVE		23H005	WV016	H67RK019	WV018.1
9617020110	HAND VALVE		23H007	WV016	H67RK019	WV018.1
9617020140	HAND VALVE		23H006	WV016	H67RK019	WV018.1
9617020310	HAND VALVE		23H008	WV016	H67RK019	WV018.1
9617221500	HAND VALVE		23H016	WV016.1	H67RK014A	WV018.1
9617221510	HAND VALVE		23H009	WV016	H67RK014	WV018.1
9617221600	HAND VALVE		23H017	WV016.1	H67RK014A	WV018.1
9617221680	HAND VALVE		23H020	WV016.1		
9617222120	HAND VALVE		23H018	WV016.1	H67RK012A	WV018.1
9617222520	HAND VALVE		23H010	WV016.1	H67RK012A	WV018.1
9617222580	HAND VALVE		23H011	WV016.1	H67RK012A	WV018.1
9617223020	HAND VALVE		23H002	WV016	H67RK012A	WV018.1
9617230010	HAND VALVE		23H019	WV016.1	H67RK017	WV018.1
9700511020	CLUTCH SERVO		23F002	WCS001	F67RK006A	WCSK001
9700511070	CLUTCH SERVO		23F005	WCS001	F67RK005	WCSK001
9700511110	CLUTCH SERVO		23F006	WCS001	F67RK004	WCSK001
9700511140	CLUTCH SERVO		23F040	WCS001.1	F67RK006A	WCSK001
9700511240	CLUTCH SERVO		23F001	WCS001	F67RK005	WCSK001
9700511260	CLUTCH SERVO		23F041	WCS001.1	F67RK006A	WCSK001
9700511270	CLUTCH SERVO		23F039	WCS001.1	F67RK005	WCSK001
9700511280	CLUTCH SERVO		23F013	WCS001	F67RK005	WCSK001
9700511290	CLUTCH SERVO		23F003	WCS001	F67RK013A	WCSK001

ANY USE OF AN O.E NAME OR NUMBER IS FOR REFERENCE ONLY.
PARTS SUPPLIED BY MAJORSELL ARE MAJORSELL BRAND AND MAY NOT BE IDENTICAL TO THE O.E.

CATALOGUE INDEX

O.E. NUMBER	DESCRIPTION	MAJORSELL REBUILT UNIT	MAJORSELL REPLACEMENT UNIT	UNIT PAGE	MAIN KIT	MAIN KIT PAGE
9700511310	CLUTCH SERVO		23F007	WCS001	F67RK002A	WCSK001
9700511320	CLUTCH SERVO		23F004	WCS001	F67RK014A	WCSK001
9700511370	CLUTCH SERVO		23F012	WCS001	F67RK013A	WCSK001
9700511510	CLUTCH SERVO		23F034	WCS001.1	F67RK011A	WCSK001
9700511560	CLUTCH SERVO		23F065	WCS001.1		
9700511580	CLUTCH SERVO		23F070	WCS001.1	F67RK010A	WCSK001
9700511590	CLUTCH SERVO		23F071	WCS001.1	F67RK010A	WCSK001
9700511630	CLUTCH SERVO		23F073	WCS001.1	F67RK014A	WCSK001
9700511710	CLUTCH SERVO		23F067	WCS001.1		
9700512090	CLUTCH SERVO		23F016	WCS001	F67RK016A	WCSK001
9700512180	CLUTCH SERVO		23F074	WCS001.1	F67RK018	WCSK001.1
9700511640	CLUTCH SERVO		23F017	WCS001		
9700514050	CLUTCH SERVO		23F062	WCS001.1	F67RK017	WCSK001
9700514060	CLUTCH SERVO		23F117	WCS002	F67RK003A	WCSK001
9700514070	CLUTCH SERVO		23F061	WCS001.1	F67RK016	WCSK001
9700514140	CLUTCH SERVO		23F118	WCS002	F67RK021A	WCSK001.1
9700514240	CLUTCH SERVO		23F119	WCS002	F67RK021A	WCSK001.1
9700514220	CLUTCH SERVO		23F094	WCS001.1	F67RK027	WCSK001.1
9700514290	CLUTCH SERVO		23F096	WCS001.1	F67RK023A	WCSK001.1
9700514360	CLUTCH SERVO		23F100	WCS001.1	F67RK028	WCSK001.1
9710021500	VALVE		23D031	WV007.1	D67RK009A	WV011
9710021520	VALVE		23D132	WV009.1	D67RK010A	WV011
9710023000	VALVE		23D088	WV009		
9710023040	VALVE		23D134	WV009.1	D67RK055A	WV012
9710029212	SENSOR CABLE		23M012	WV023.1		
9730010100	VALVE		23D008	WV007	D67RK001A	WV011
9730010200	VALVE		23D021	WV007.1	D67RK001A	WV011
9730012100	VALVE		23D020	WV007.1	D67RK001A	WV011
9730020000	VALVE		23D009	WV007	D67RK012A	WV011
9730024020	VALVE		23D013	WV007	D67RK012A	WV011
9730025200	VALVE		23D010	WV007	D67RK014A	WV011
9730025210	VALVE		23D042	WV007.1	D67RK014A	WV011
9730080020	VALVE		23D074	WV008.1	D67RK044A	WV012
9730090010	VALVE		23D136	WV009.1	D67RK035A	WV011.1
9730090100	VALVE		23D072	WV008.1	D67RK035A	WV011.1
9730093000	VALVE		23D073	WV008.1	D67RK045A	WV012
9730110000	VALVE		23D083	WV009	D67RK033A	WV011.1
9730110010	VALVE		23D011	WV007	D67RK033A	WV011.1
9730110020	VALVE		23D084	WV009	D67RK033A	WV011.1
9730110080	VALVE		23D086	WV009	D67RK033A	WV011.1
9730110090	VALVE		23D123	WV009.1	D67RK033A	WV011.1
9730110500	VALVE		23D117	WV009		
9730112000	VALVE		23D125	WV009.1	D67RK033A	WV011.1
9730112050	VALVE		23D126	WV009.1	D67RK033A	WV011.1
9730112060	VALVE		23D140	WV009	D67RK033A	WV011.1
9735000000	Q R VALVE		23E009	WV013	E68RK001	BXV003.1
9735000060	Q R VALVE		23E046	WV014.1	E68RK001	BXV003.1
9735000140	Q R VALVE		23E012	WV013	E68RK001	BXV003.1
9735000180	Q R VALVE		23E047	WV014.1	E68RK001	BXV003.1
9750010000	VALVE		23E039	WV014		
9753001100	VALVE		23B053	WV002.1	B67RK017A	WV005.1
9753001110	VALVE		23B027	WV001.1	B67RK017A	WV005.1
9753005500	VALVE		23B026	WV001.1	B67RK017A	WV005.1
9753030600	VALVE		23B029	WV002	B67RK027	WV005.1
9753030840	VALVE		23B031	WV002	B67RK027	WV005.1

ANY USE OF AN O.E NAME OR NUMBER IS FOR REFERENCE ONLY.
PARTS SUPPLIED BY MAJORSELL ARE MAJORSELL BRAND AND MAY NOT BE IDENTICAL TO THE O.E.

CATALOGUE INDEX

O.E. NUMBER	DESCRIPTION	MAJORSELL REBUILT UNIT	MAJORSELL REPLACEMENT UNIT	UNIT PAGE	MAIN KIT	MAIN KIT PAGE
9753030850	VALVE		23B032	WV002	B67RK027	WV005.1
9753034410	VALVE		23B033	WV002	B67RK027	WV005.1
9753034470	VALVE		23B046	WV002.1	B67RK027	WV005.1
9753034730	QUAD VALVE		23B082	WV004	B67RK027	WV005.1
9753034740	VALVE		23B015	WV001	B67RK027	WV005.1
9753034780	VALVE		23B034	WV002	B67RK027	WV005.1
9753035040	VALVE		23B035	WV002	B67RK027	WV005.1
AB2778	VALVE		23D013	KV003		
AB2783	VALVE		23D077	KV004	D68RK001A	BXV003.1
AC574	VALVE		23D139	MARV001.1	D78RK006A	MARV001.1
AC599A	VALVE		23D141	MARV001.1	D78RK019A	MARV001.1
AC61ZA	COMPRESSOR				A78RK009	MAR001
AC61ZB	COMPRESSOR				A78RK009	MAR001
AC61ZC	COMPRESSOR				A78RK009	MAR001
AC62ZA	COMPRESSOR				A78RK009	MAR001
AC62ZAG	COMPRESSOR				A78RK009	MAR001
AC63ZA	COMPRESSOR				A78RK014	MAR002
AC63ZAG	COMPRESSOR				A78RK014	MAR002
AC63ZB	COMPRESSOR				A78RK014	MAR002
AC63ZBG	COMPRESSOR				A78RK014	MAR002
AC64ZB	COMPRESSOR				A78RK014	MAR002
AC64ZCG	COMPRESSOR	78A001R			A78RK014	MAR002
AC67A	COMPRESSOR				A78RK001	MAR003
AC67AA	COMPRESSOR				A78RK001	MAR003
AC67AC	COMPRESSOR				A78RK001	MAR003
AC67AZG	COMPRESSOR				A78RK001	MAR003
AC67BA	COMPRESSOR				A78RK001	MAR003
AC75A	COMPRESSOR				A78RK007	MAR006
ACX61ZA	COMPRESSOR				A78RK009	MAR001
ACX61ZAG	COMPRESSOR				A78RK009	MAR001
ACX61ZC	COMPRESSOR				A78RK009	MAR001
ACX61ZCG	COMPRESSOR				A78RK009	MAR001
ACX66B	COMPRESSOR				A78RK014	MAR002
ACX66BG	COMPRESSOR				A78RK014	MAR002
ACX67A	COMPRESSOR				A78RK001	MAR003
ACX67AA	COMPRESSOR				A78RK001	MAR003
ACX67AAG	COMPRESSOR				A78RK001	MAR003
ACX67BA	COMPRESSOR				A78RK001	MAR003
ACX67BAG	COMPRESSOR				A78RK001	MAR003
ACX67CA	COMPRESSOR				A78RK001	MAR003
ACX68A	COMPRESSOR				A78RK019	MAR004
ACX68AS	COMPRESSOR				A78RK019	MAR004
ACX68D	COMPRESSOR				A78RK019	MAR004
ACX69A	COMPRESSOR				A78RK020	MAR005
ACX69AS	COMPRESSOR				A78RK020	MAR005
ACX69AXU	COMPRESSOR				A78RK020	MAR005
ACX69BXS	COMPRESSOR				A78RK020	MAR005
ACX69CX	COMPRESSOR				A78RK020	MAR005
ACX69D	COMPRESSOR				A78RK020	MAR005
ACX69DX	COMPRESSOR				A78RK020	MAR005
ACX69DXU	COMPRESSOR				A78RK020	MAR005
ACX75FG	COMPRESSOR				A78RK007	MAR006
ACX75ZA	COMPRESSOR				A78RK007	MAR006
ACX75ZF	COMPRESSOR				A78RK007	MAR006
ACX75ZFG	COMPRESSOR				A78RK007	MAR006

ANY USE OF AN O.E NAME OR NUMBER IS FOR REFERENCE ONLY.
PARTS SUPPLIED BY MAJORSELL ARE MAJORSELL BRAND AND MAY NOT BE IDENTICAL TO THE O.E.

CATALOGUE INDEX

O.E. NUMBER	DESCRIPTION	MAJORSELL REBUILT UNIT	MAJORSELL REPLACEMENT UNIT	UNIT PAGE	MAIN KIT	MAIN KIT PAGE
ACX75ZZGG	COMPRESSOR				A78RK007	MAR006
ACX78C	COMPRESSOR				A78RK007	MAR006
ACX79CG	COMPRESSOR				A78RK007	MAR006
ACX80A	COMPRESSOR				A78RK021	MAR007
ACX80AA	COMPRESSOR				A78RK021	MAR007
ACX82	COMPRESSOR				A78RK021	MAR007
ACX82A	COMPRESSOR				A78RK021	MAR007
ACX82AS	COMPRESSOR				A78RK021	MAR007
ACX82AXU	COMPRESSOR				A78RK021	MAR007
ACX82BXS	COMPRESSOR				A78RK021	MAR007
ACX83A	COMPRESSOR				A78RK021	MAR007
ACX83AS	COMPRESSOR				A78RK021	MAR007
ACX83B	COMPRESSOR				A78RK021	MAR007
ACTROS	COMPRESSOR			AXOR ACTROS	A67RK068	AXOR ACTROS
AE1206	VALVE		23E004	KV006	E67RK023A	WV013.1
AE1207	VALVE		23E005	KV006	E67RK023A	WV013.1
AE1208	VALVE		23E037	KV006.1		
AE2100	STOP COCK		23E021	KV006.1		
AE4158	QUAD VALVE		23B036	KV001	B66RK001A	KV002.1
AE4162	VALVE		23B007	KV001	B66RK001A	KV002.1
AE4612	QUAD VALVE		23B075	KV001.1	B66RK006A	KV002.1
AE4170	QUAD VALVE		23B048	KV001.1	B66RK001A	KV002.1
AE4178	QUAD VALVE		23B037	KV001	B66RK001A	KV002.1
AE4179	QUAD VALVE		23B038	KV001	B66RK001A	KV002.1
AE4183	QUAD VALVE		23B039	KV001	B66RK001A	KV002.1
AE4186	QUAD VALVE		23B051	KV001.1	B66RK001A	KV002.1
AE4188	QUAD VALVE		23B040	KV001.1	B66RK001A	KV002.1
AE4190	QUAD VALVE		23B041	KV001.1	B66RK001A	KV002.1
AE4404	QUAD VALVE		23B090	KV001.1	B66RK001A	KV002.1
AE4405	QUAD VALVE		23B096	KV002	B66RK001	KV002.1
AE4440	QUAD VALVE		23B076	KV001.1	B66RK011A	KV002.1
AE4451	QUAD VALVE		23B097	KV002	B66RK011A	KV002.1
AE4528	VALVE		23B089	KV001.1	B66RK009A	KV002.1
AE4610	QUAD VALVE		23B056	KV001.1	B66RK006A	KV002.1
AE4613	QUAD VALVE		23B057	KV001.1	B66RK006A	KV002.1
AE5115	VALVE		23E019	KV006.1	E67RK022A	WV013.1
APGA1605P	CLUTCH SERVO		23F015	WCS001	F69RK002A	WCSK001
APGA6620	FOOT VALVE		23J054	WV021	J69RK007A	WV022.1
APGA6635	HAND VALVE		23H012	WV016.1	H69RK004	WV018.1
APSA5890	HAND VALVE		23H040	WV017.1	H69RK009A	WV018.1
APSA7314-1	FOOT VALVE		23J045	WV020.1	J69RK006A	WV022.1
ATEGO	COMPRESSOR			AXOR ATEGO	A67RK057	AXOR ATEGO
AXOR	COMPRESSOR			AXOR 1840	A67RK062	AXOR 1840
BX921	COMPRESSOR				A66RK058	LK3994
BX922	COMPRESSOR				A66RK066	LK4954
BX922	COMPRESSOR				A66RK059	BX011
DB2111	CHECK VALVE		23E039	KV006.1		
DPM42A	HAND VALVE		23H003	MARV002		
DPM47A	HAND VALVE		23H006	MARV002		
DPM81B	HAND VALVE		23H009	MARV002		
DPM90D	HAND VALVE		23H034	MARV002	H78RK003A	MARV002
DPM94AAX	HAND VALVE		23H038	MARV002	H78RK003A	MARV002
DPM95AAX	HAND VALVE		23H039	MARV002		
DR3200	VALVE		23B004	KV001	B66RK003A	KV002.1
DR3500	VALVE		23B005	KV001	B66RK004A	KV002.1

ANY USE OF AN O.E NAME OR NUMBER IS FOR REFERENCE ONLY.
PARTS SUPPLIED BY MAJORSELL ARE MAJORSELL BRAND AND MAY NOT BE IDENTICAL TO THE O.E.

CATALOGUE INDEX

O.E. NUMBER	DESCRIPTION	MAJORSELL REBUILT UNIT	MAJORSELL REPLACEMENT UNIT	UNIT PAGE	MAIN KIT	MAIN KIT PAGE
DR3502	VALVE		23B008	KV001	B66RK004A	KV002.1
DR4345	VALVE		23E002	KV006	E67RK009A	WV015
DX75BA	FOOT VALVE		23J061	MARV003	J78RK004A	MARV003
EE1100	TILT VALVE		23E015	KV006		
EL1300	COMPRESSOR				A73RK001	MID015
EL1600	COMPRESSOR				A73RK001	MID015
HB1135	HAND VALVE		23H003	KV008		
HB1136	HAND VALVE		23H004	KV008	H66RK004A	KV008.1
HB1142	HAND VALVE		23H046	KV008	H66RK009A	KV008.1
HB1143	HAND VALVE		23H031	KV008	H66RK004A	KV008.1
HB1154	HAND VALVE		23H029	KV008	H66RK002A	KV008.1
HB1176	HAND VALVE		23H015	KV008	H66RK004	KV008.1
HB1201	HAND VALVE		23H010	KV008	H63RK001 & 2	KV008.1
HB1258	HAND VALVE		23H001	KV008	H66RK004A	KV008.1
KG200801	MASTER CYL.		23K015	MC001.1		NO KIT
KG2303002	MASTER CYL.		23K003	MC001	-	NO KIT
KG259514	MASTER CYL.		23K007	MC001	-	NO KIT
KG259615	MASTER CYL.		23K006	MC001	-	NO KIT
KG260411	MASTER CYL.		23K014	MC001.1		NO KIT
KG2801411	MASTER CYL.		23K008/009	MC001		NO KIT
KG280201	MASTER CYL.		23K010	MC001		NO KIT
KW1294-1	Q R VALVE		23E047	BXV004	E68RK001	BXV004.1
KW3405-1	TEST POINT		23E042	BXV004		NO KIT
KW3731-1	TEST POINT		23E040	BXV004		NO KIT
KW4282-2	TEST POINT		23E041	BXV004		NO KIT
KX9000	Q R VALVE		23E009	KV006	E68RK001	BXV004.1
KX18101	R8 VALVE		23D112	BXV002.1	D68RK002	BXV003
KY1001-1	RE6 VALVE		23D016	BXV002	D68RK003A	BXV003
KZ1030	COMPRESSOR				A68RK105A	KZ1265-2
KZ1087	COMPRESSOR				A68RK103	15.5/440
KZ1114	COMPRESSOR	6A069R			A68RK092A	KZ1114
KZ1115	COMPRESSOR				A68RK104A	BX013
KZ1143	COMPRESSOR	68A016R			A68RK092A	KZ1114
KZ1187	COMPRESSOR				A68RK104A	BX013
KZ1211	COMPRESSOR				A68RK104A	BX013
KZ1228	COMPRESSOR				A68RK094	KZ642
KZ1257	COMPRESSOR				A68RK105A	KZ1265-2
KZ1265	COMPRESSOR				A68RK105A	KZ1265-2
KZ1303	COMPRESSOR				A68RK105A	KZ1265-2
KZ396	COMPRESSOR				A68RK094	KZ642
KZ433	COMPRESSOR	68A002R			A68RK094	KZ642
KZ456	COMPRESSOR				A68RK094	KZ642
KZ625	COMPRESSOR				A68RK094	KZ642
KZ641	COMPRESSOR				A68RK094	KZ642
KZ642	COMPRESSOR	68A001R			A68RK094	KZ642
KZ800	COMPRESSOR	68A027R			A68RK040A	BX019
KZ801	COMPRESSOR				A68RK040A	BX019
KZ802	COMPRESSOR				A68RK040A	BX019
KZ803	COMPRESSOR	68A015R			A68RK040A	BX019
KZ857	COMPRESSOR				A68RK094	KZ642
KZ929	COMPRESSOR				A68RK040A	BX019
KZ930	COMPRESSOR				A68RK040A	BX019
KZ931	COMPRESSOR				A68RK040A	BX019
KZ932	COMPRESSOR				A68RK040A	BX019
KZ958	COMPRESSOR				A68RK040A	BX019

ANY USE OF AN O.E NAME OR NUMBER IS FOR REFERENCE ONLY.
PARTS SUPPLIED BY MAJORSELL ARE MAJORSELL BRAND AND MAY NOT BE IDENTICAL TO THE O.E.

CATALOGUE INDEX

O.E. NUMBER	DESCRIPTION	MAJORSELL REBUILT UNIT	MAJORSELL REPLACEMENT UNIT	UNIT PAGE	MAIN KIT	MAIN KIT PAGE
KZ959	COMPRESSOR				A68RK040A	BX019
KZ960	COMPRESSOR				A68RK040A	BX019
KZ961	COMPRESSOR				A68RK040A	BX019
KZ996	COMPRESSOR				A68RK094	KZ642
LA2103	FILTER		23E018	KV006.1		
LK1300	COMPRESSOR	66A044R			A66RK008	LK1300
LK1303	COMPRESSOR	66A046R			A66RK008	LK1303
LK1314	COMPRESSOR	66A035R			A66RK008	LK1314
LK1500	COMPRESSOR	66A047R			A66RK008	LK1500
LK1503	COMPRESSOR				A66RK008	LK1500
LK1504	COMPRESSOR				A66RK008	LK1500
LK1505	COMPRESSOR				A66RK008	LK1500
LK1506	COMPRESSOR				A66RK008	LK1506
LK1510	COMPRESSOR				A66RK008	LK1506
LK1511	COMPRESSOR	66A036R			A66RK008	LK1506
LK1516	COMPRESSOR					LK1516
LK1517	COMPRESSOR					LK1516
LK1518	COMPRESSOR					LK1516
LK1521	COMPRESSOR					LK1521
LK1522	COMPRESSOR					LK1521
LK1523	COMPRESSOR					LK1521
LK1524	COMPRESSOR				A66RK008	LK1524
LK1525	COMPRESSOR	66A089R			A66RK008	LK1525
LK1526	COMPRESSOR					LK1525
LK1527	COMPRESSOR	66A037R			A66RK008	LK1527
LK1532	COMPRESSOR				A66RK008	LK1532
LK1539	COMPRESSOR	66A061R			A66RK008	LK1539
LK1549	COMPRESSOR				A66RK008	LK1549
LK1554	COMPRESSOR				A66RK044	K003
LK1555	COMPRESSOR				A66RK044	K003
LK1567	COMPRESSOR				A66RK044	K003
LK1813	COMPRESSOR	66A040R			A66RK017	LK1813
LK1900	COMPRESSOR	66A048R			A66RK009	LK1900
LK1901	COMPRESSOR	66A049R			A66RK009	LK1900
LK1906	COMPRESSOR				A66RK017A	LK1909
LK1908	COMPRESSOR				A66RK017A	LK1909
LK3501	COMPRESSOR					LK3501
LK3515	COMPRESSOR					LK3515
LK3813	COMPRESSOR	66A003R			A66RK045	LP3975
LK3826	COMPRESSOR				A66RK020A	LK3826
LK3832	COMPRESSOR	66A066R			A66RK020A	LK3832
LK3834	COMPRESSOR	66A071R			A66RK042	LK3834
LK3904	COMPRESSOR				A66RK020	LK3904
LK3917	COMPRESSOR					LK3917
LK3933	COMPRESSOR				A66RK020A	LK3933
LK3935	COMPRESSOR				A66RK045	LP3975
LK3941	COMPRESSOR				A66RK020A	LK3933
LK3943	COMPRESSOR				A66RK020A	LK3943
LK3944	COMPRESSOR				A66RK020A	LK3943
LK3950	COMPRESSOR				A66RK020	LK3950
LK3954	COMPRESSOR				A66RK020A	LK3950
LK3959	COMPRESSOR				A66RK047	LK3959
LK3963	COMPRESSOR				A66RK020A	LK3963
LK3965	COMPRESSOR	66A064R			A66RK047	LK3965
LK3970	COMPRESSOR				A66RK045	LP3975

ANY USE OF AN O.E NAME OR NUMBER IS FOR REFERENCE ONLY.
PARTS SUPPLIED BY MAJORSELL ARE MAJORSELL BRAND AND MAY NOT BE IDENTICAL TO THE O.E.

CATALOGUE INDEX

O.E. NUMBER	DESCRIPTION	MAJORSELL REBUILT UNIT	MAJORSELL REPLACEMENT UNIT	UNIT PAGE	MAIN KIT	MAIN KIT PAGE
LK3971	COMPRESSOR				A66RK045	LP3975
LK3972	COMPRESSOR				A66RK045	LP3975
LK3976	COMPRESSOR				A66RK058	LK3994
LK3978	COMPRESSOR				A66RK020A	LK3978
LK3980	COMPRESSOR				A66RK020A	LK3978
LK3982	COMPRESSOR	66A091R			A66RK047	LK3982
LK3986	COMPRESSOR				A66RK045	LP3975
LK3994	COMPRESSOR	66A068R			A66RK058	LK3994
LK4909	COMPRESSOR				A66RK057	LK4909
LK4910	COMPRESSOR				A66RK057	LK4909
LK4911	COMPRESSOR				A66RK057	LK4909
LK4913	COMPRESSOR				A66RK057	LK4909
LK4918	COMPRESSOR	66A008R			A66RK034	LK4919
LK4919	COMPRESSOR				A66RK034	LK4919
LK4920	COMPRESSOR	66A080R			A66RK034	LK4920
LK4921	COMPRESSOR	66A087R			A66RK034	LK4921
LK4922	COMPRESSOR				A66RK034	LK4921
LK4927	COMPRESSOR				A66RK034	LK4921
LK4930	COMPRESSOR	66A069R			A66RK059	BX011
LK4931	COMPRESSOR				A66RK057	LK4931
LK4932	COMPRESSOR				A66RK057	LK4931
LK4939	COMPRESSOR				A66RK057	LK4939
LK4941	COMPRESSOR	66A085R			A66RK005	LP4949
LK4954	COMPRESSOR	66A079R			A66RK079	LK4954
LK4959	COMPRESSOR				A68RK118	LK4959
LP1316	COMPRESSOR				A66RK035	K015
LP1317	COMPRESSOR				A66RK035	K015
LP1321	COMPRESSOR				A66RK035	K015
LP1325	COMPRESSOR				A66RK035	K015
LP1327	COMPRESSOR				A66RK035	K015
LP1328	COMPRESSOR				A66RK035	K015
LP1330	COMPRESSOR				A66RK035	K015
LP1331	COMPRESSOR				A66RK035	K015
LP1332	COMPRESSOR				A66RK035	K015
LP1337	COMPRESSOR				A66RK035	K015
LP1545	COMPRESSOR				A66RK035	K015
LP1546	COMPRESSOR				A66RK035	K015
LP1566	COMPRESSOR				A66RK035	K015
LP1567	COMPRESSOR	66A050R			A66RK035	K015
LP1568	COMPRESSOR	66A053R			A66RK035	K015
LP1573	COMPRESSOR	66A054R			A66RK035	K015
LP1575	COMPRESSOR				A66RK035	K015
LP1577	COMPRESSOR				A66RK035	K015
LP1578	COMPRESSOR				A66RK035	K015
LP1580	COMPRESSOR				A66RK035	K015
LP1582	COMPRESSOR				A66RK035	K015
LP1585	COMPRESSOR	66A051R			A66RK035	K015
LP1588	COMPRESSOR	66A052R			A66RK035	K015
LP1589	COMPRESSOR				A66RK035	K015
LP1591	COMPRESSOR				A66RK035	K015
LP1596	COMPRESSOR				A66RK044	K003
LP1598	COMPRESSOR				A66RK044	K003
LP1599	COMPRESSOR				A66RK044	K003
LP1873	COMPRESSOR				A66RK017A	LK1900
LP1881	COMPRESSOR				A66RK017A	LK1901

ANY USE OF AN O.E NAME OR NUMBER IS FOR REFERENCE ONLY.
PARTS SUPPLIED BY MAJORSELL ARE MAJORSELL BRAND AND MAY NOT BE IDENTICAL TO THE O.E.

CATALOGUE INDEX

O.E. NUMBER	DESCRIPTION	MAJORSELL REBUILT UNIT	MAJORSELL REPLACEMENT UNIT	UNIT PAGE	MAIN KIT	MAIN KIT PAGE
LP1882	COMPRESSOR				A66RK017A	LK1909
LP1883	COMPRESSOR				A66RK017A	LK1909
LP1982	COMPRESSOR				A66RK017A	LK1909
LP1990	COMPRESSOR				A66RK017A	LK1909
LP3832	COMPRESSOR				A66RK038	K019
LP3833	COMPRESSOR				A66RK038	K019
LP3843	COMPRESSOR				A66RK038	K019
LP3852	COMPRESSOR				A66RK038	K019
LP3857	COMPRESSOR				A66RK038	K019
LP3860	COMPRESSOR				A66RK038	K019
LP3861	COMPRESSOR				A66RK038	K019
LP3862	COMPRESSOR				A66RK038	K019
LP3934	COMPRESSOR				A66RK020A	LK3978
LP3970	COMPRESSOR	66A090R			A66RK058	LP3970
LP3975	COMPRESSOR				A66RK045	LP3975
LP3980	COMPRESSOR				A66RK065	LP3980
LP3982	COMPRESSOR				A66RK020A	LP3982
LP3986	COMPRESSOR				A66RK065	LP3980
LP4812	COMPRESSOR	66A009R			A66RK007	LP4812
LP4813	COMPRESSOR	66A010R			A66RK007	LP4812
LP4814	COMPRESSOR	66A011R			A66RK007	LP4812
LP4815	COMPRESSOR	66A012R			A66RK007	LP4812
LP4818	COMPRESSOR				A66RK041	LP4944
LP4819	COMPRESSOR				A66RK033	LP4855
LP4820	COMPRESSOR				A66RK004	LP4825
LP4821	COMPRESSOR				A66RK004	LP4825
LP4823	COMPRESSOR				A66RK031	
LP4825	COMPRESSOR	66A013R			A66RK004	LP4825
LP4827	COMPRESSOR	66A065R			A66RK033	LP4855
LP4828	COMPRESSOR				A66RK033	LP4855
LP4829	COMPRESSOR	66A012R			A66RK004	LP4825
LP4830	COMPRESSOR				A66RK031	
LP4831	COMPRESSOR				A66RK033	LP4855
LP4832	COMPRESSOR				A66RK041	LP4944
LP4833	COMPRESSOR				A66RK033	LP4855
LP4838	COMPRESSOR				A66RK033	LP4855
LP4843	COMPRESSOR				A66RK033	LP4855
LP4844	COMPRESSOR				A66RK007	LP4844
LP4845	COMPRESSOR	66A014R			A66RK033	LP4855
LP4846	COMPRESSOR				A66RK033	LP4855
LP4847	COMPRESSOR				A66RK033	LP4855
LP4848	COMPRESSOR				A66RK033	LP4855
LP4849	COMPRESSOR				A66RK033	LP4855
LP4850	COMPRESSOR				A66RK031	
LP4851	COMPRESSOR				A66RK033	LP4855
LP4852	COMPRESSOR					LP4852
LP4853	COMPRESSOR				A66RK033	LP4855
LP4855	COMPRESSOR				A66RK033	LP4855
LP4857	COMPRESSOR				A68RK118	LK4959
LP4861	COMPRESSOR				A68RK118	LK4959
LP4862	COMPRESSOR				A68RK118	LK4959
LP4918	COMPRESSOR				A66RK034	LP4919
LP4919	COMPRESSOR				A66RK034	LP4919
LP4922	COMPRESSOR				A66RK034	LP4919
LP4930	COMPRESSOR	66A002R			A66RK005	LP4949

ANY USE OF AN O.E NAME OR NUMBER IS FOR REFERENCE ONLY.
PARTS SUPPLIED BY MAJORSELL ARE MAJORSELL BRAND AND MAY NOT BE IDENTICAL TO THE O.E.

CATALOGUE INDEX

O.E. NUMBER	DESCRIPTION	MAJORSELL REBUILT UNIT	MAJORSELL REPLACEMENT UNIT	UNIT PAGE	MAIN KIT	MAIN KIT PAGE
LP4934	COMPRESSOR	66A001R			A66RK005	LP4949
LP4936	COMPRESSOR				A66RK005	LP4949
LP4939	COMPRESSOR				A66RK041	LP4944
LP4940	COMPRESSOR				A66RK041	LP4944
LP4941	COMPRESSOR				A66RK041	LP4944
LP4942	COMPRESSOR				A66RK041	LP4944
LP4943	COMPRESSOR				A66RK041	LP4944
LP4944	COMPRESSOR				A66RK041	LP4944
LP4945	COMPRESSOR				A66RK041	LP4944
LP4948	COMPRESSOR				A66RK005	LP4949
LP4949	COMPRESSOR	66A024R			A66RK005	LP4949
LP4954	COMPRESSOR					LP4954
LP4955	COMPRESSOR				A66RK005	LP4949
LP4957	COMPRESSOR	66A029R			A66RK005	LP4949
LP4960	COMPRESSOR	66A015R			A66RK005	LP4949
LP4961	COMPRESSOR				A66RK005	LP4949
LP4962	COMPRESSOR	66A030R			A66RK005	LP4949
LP4963	COMPRESSOR				A66RK005	LP4949
LP4964	COMPRESSOR	66A016R			A66RK005	LP4949
LP4965	COMPRESSOR	66A031R			A66RK005	LP4949
LP4966	COMPRESSOR	66A032R			A66RK005	LP4949
LP4967	COMPRESSOR	66A017R			A66RK005	LP4949
LP4968	COMPRESSOR	66A026R			A66RK005	LP4949
LP4969	COMPRESSOR	66A034R			A66RK034	LP4919
LP4970	COMPRESSOR				A66RK034	LP4919
LP4974	COMPRESSOR	66A004R			A66RK005	LP4949
LP4977	COMPRESSOR				A66RK005	LP4949
LP4979	COMPRESSOR				A66RK005	LP4949
LP4980	COMPRESSOR				A66RK005	LP4949
LP4981	COMPRESSOR				A66RK005	LP4949
LP4983	COMPRESSOR				A66RK034	LP4919
LP4984	COMPRESSOR				A66RK034	LP4919
LP4985	COMPRESSOR	66A018R			A66RK034	LP4985
LP4986	COMPRESSOR	66A048R			A66RK034	LP4985
LP4988	COMPRESSOR				A66RK034	LP4985
LP4989	COMPRESSOR				A66RK034	LP4985
LP4990	COMPRESSOR				A66RK034	LP4990
LP4991	COMPRESSOR	66A082R			A66RK034	LP4990
LP4992	COMPRESSOR	66A086R			A66RK034	LP4990
LP4993	COMPRESSOR	66A083R			A66RK034	LP4990
LP4994	COMPRESSOR				A66RK034	LP4994
LP4995	COMPRESSOR				A66RK034	LP4996
LP4996	COMPRESSOR	66A081R			A66RK034	LP4996
LP4997	COMPRESSOR				A66RK034	LP4996
LP4998	COMPRESSOR				A66RK005	LP4949
LP4999	COMPRESSOR				A66RK005	LP4949
MB4434	FOOT VALVE		23J042	KV009	J66RK001A	KV010
MB4630	FOOT VALVE		23J049	KV009	J66RK008A	KV010
MB4636	FOOT VALVE		23J048	KV009	J66RK008A	KV010
MB4681	FOOT VALVE		23J013	KV009	J66RK002A	KV010
MB4690	FOOT VALVE		23J003	KV009	J66RK012A	KV010.1
MB4694	FOOT VALVE		23J056	KV009.1	J66RK012A	KV010.1
MB4849	FOOT VALVE		23J050	KV009	J66RK012A	KV010.1
ME067899	COMPRESSOR		60A010		A60RK023	J11
ME091248	COMPRESSOR		60A009		A60RK022	J010

ANY USE OF AN O.E NAME OR NUMBER IS FOR REFERENCE ONLY.
PARTS SUPPLIED BY MAJORSELL ARE MAJORSELL BRAND AND MAY NOT BE IDENTICAL TO THE O.E.

CATALOGUE INDEX

O.E. NUMBER	DESCRIPTION	MAJORSELL REBUILT UNIT	MAJORSELL REPLACEMENT UNIT	UNIT PAGE	MAIN KIT	MAIN KIT PAGE
ME150355	COMPRESSOR		60A011		A60RK027	J012
ME150591	COMPRESSOR		60A012		A60RK027	J013
OM402	COMPRESSOR				A67RK026	OM402
OM402	COMPRESSOR				A67RK051	OM402
OM403	COMPRESSOR				A67RK026	OM402
OM403	COMPRESSOR				A67RK051	OM402
OM422	COMPRESSOR				A67RK026	OM422
OM422	COMPRESSOR				A67RK051	OM422
OM423	COMPRESSOR				A67RK026	OM422
OM423	COMPRESSOR				A67RK051	OM422
OM442	COMPRESSOR				A67RK041	OM442
OM457	COMPRESSOR			AXOR OM457	A67RK069	AXOR OM457
QE296	COMPRESSOR				A74RK017A	CUM001
QE296	COMPRESSOR				A74RK017B	CUM001
RE1110	VALVE		23D008	KV003	D66RK004A	KV005
RE1115	RELAY VALVE		23D021	KV003	D66RK004A	KV005
RE2221	VALVE		23D001	KV003	D66RK006A	KV005
SS296	COMPRESSOR				A74RK001A	CUM001
SS296	COMPRESSOR				A74RK002A	CUM001
SS296	COMPRESSOR				A74RK010	CUM001
SS378	COMPRESSOR				A74RK017A	CUM001
SS378	COMPRESSOR				A74RK017B	CUM001
ST676	COMPRESSOR				A74RK012	CUM001
SV1260	LEV. VALVE		23D025	KV003	D66RK017A	KV005.1
SV1278	LEV. VALVE		23D027	KV003	D66RK017A	KV005.1
SV1280	LEV. VALVE		23D045	KV003.1	D66RK016A	KV005.1
SV1281	LEV. VALVE		23D046	KV003.1	D66RK016A	KV005.1
SV1288	LEV. VALVE		23D057	KV004	D66RK016A	KV005.1
SV1294	LEV. VALVE		23D058	KV004	D66RK017A	KV005.1
SV1295	LEV. VALVE		23D051	KV003.1	D66RK016A	KV005.1
SV1310	LEV. VALVE		23D026	KV003	D66RK017A	KV005.1
SV1313	LEV. VALVE		23D027	KV003	D66RK017A	KV005.1
SV1323	LEV. VALVE		23D052	KV003.1	D66RK016A	KV005.1
SV1329	LEV. VALVE		23D044	KV003.1	D66RK016A	KV005.1
SV1345	LEV. VALVE		23D054	KV003.1	D66RK016A	KV005.1
SV1350	LEV. VALVE		23D087	KV004	D66RK017A	KV005.1
SV1361	LEV. VALVE		23D028	KV003	D66RK017A	KV005.1
SV1362	LEV. VALVE		23D029	KV003.1	D66RK017A	KV005.1
SV1395	LEV. VALVE		23D055	KV003.1	D66RK016A	KV005.1
SV1399	LEV. VALVE		23D053	KV003.1	D66RK016A	KV005.1
SV1411	LEV. VALVE		23D056	KV003.1	D66RK016A	KV005.1
SV1412	LEV. VALVE		23D059	KV004	D66RK017A	KV005.1
SZ1114	CYL.		23E036	KV006.1		
SZ1115	CYL.		23E006	KV006	E66RK008	KV007
SZ1159	CYL.		23E007	KV006	E66RK008	KV007
SZ1166	CYL.		23E010	KV006	E66RK009	KV007
TF1000	COMPRESSOR				A69RK021A	TF500
TF400	COMPRESSOR				A68RK008A	BX008
TF500	COMPRESSOR				A69RK021A	277057
TF501	COMPRESSOR				A68RK038A	TF501
TF550	COMPRESSOR				A68RK096A	TF550-750
TF600	COMPRESSOR				A68RK058A	TF600-700
TF700	COMPRESSOR				A68RK058A	TF600-700
TF750	COMPRESSOR				A68RK096A	TF550-750
VG3200	CLUTCH SERVO		23F038	KCS001	F66RK001	KCSK001

ANY USE OF AN O.E NAME OR NUMBER IS FOR REFERENCE ONLY.
PARTS SUPPLIED BY MAJORSELL ARE MAJORSELL BRAND AND MAY NOT BE IDENTICAL TO THE O.E.

CATALOGUE INDEX

O.E. NUMBER	DESCRIPTION	MAJORSELL REBUILT UNIT	MAJORSELL REPLACEMENT UNIT	UNIT PAGE	MAIN KIT	MAIN KIT PAGE
VG3204	CLUTCH SERVO		23F037	KCS001	F66RK001	KCSK001
VG3208	CLUTCH SERVO		23F036	KCS001	F66RK002A	KCSK001
VG3213	CLUTCH SERVO		23F035	KCS001	F66RK006A	KCSK001
VG3221	CLUTCH SERVO		23F078	KCS001	F66RK008A	KCSK001
VG3261	CLUTCH SERVO		23F179	KCS001.1	F66RK010A	KCSK001
VG3262	CLUTCH SERVO		23F123	KCS001	F66RK011A	KCSK001
VG3265	CLUTCH SERVO		23F068	KCS001	F66RK001	KCSK001
VG3267	CLUTCH SERVO		23F072	KCS001	F66RK007A	KCSK001
VG3268	CLUTCH SERVO		23F069	KCS001	F66RK002A	KCSK001
VG3269	CLUTCH SERVO		23F093	KCS001	F66RK008A	KCSK001
VG3289	CLUTCH SERVO		23F079	KCS001	F66RK008A	KCSK001
VG3361	CLUTCH SERVO		23F063	KCS001	F66RK003	KCSK001

ANY USE OF AN O.E NAME OR NUMBER IS FOR REFERENCE ONLY.
PARTS SUPPLIED BY MAJORSELL ARE MAJORSELL BRAND AND MAY NOT BE IDENTICAL TO THE O.E.

Majorsell parts for :-

KZ1114

Principal users :-
DAF

**MAJORSELL
REBUILD**

CBU1206 3906251

68A069R



- 75 mm bore.
- Through drive.
- Air cooled.
- Weight : 11 Kg.
- Flange mount.
- Engine oil lubrication.
- Air inlet : $\frac{3}{4}$ " , air delivery : $\frac{1}{2}$ ".

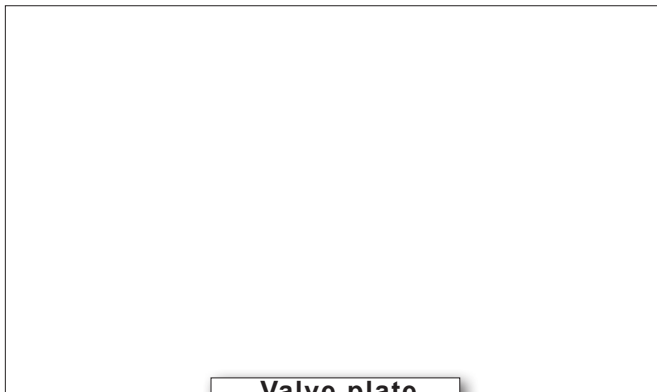
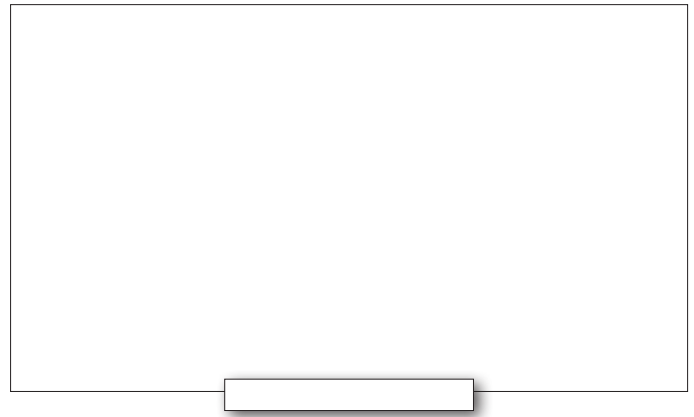
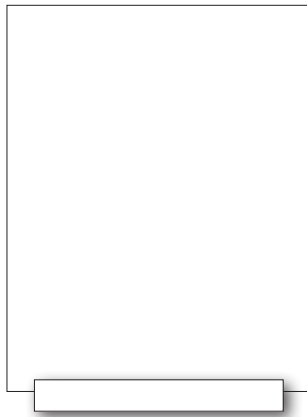
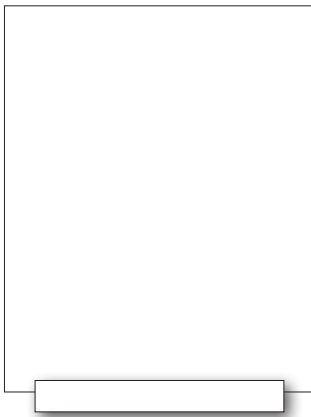

Valve plate

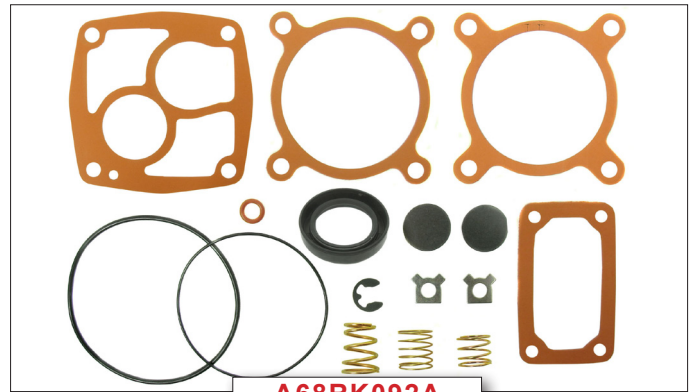

A68RK092A

<p>020011 Std A68RK010 020012 +0.25 mm A68RK011 020013 +0.50 mm A68RK012 020014 +0.75 mm A68RK013 020015 +1.00 mm</p>	<p>75 mm 4 x $\frac{3}{32}$" 2 x $\frac{5}{32}$"</p>	<p>1 Kit = 2 pistons</p>
--	--	---------------------------------

Piston & Rings

Ring set

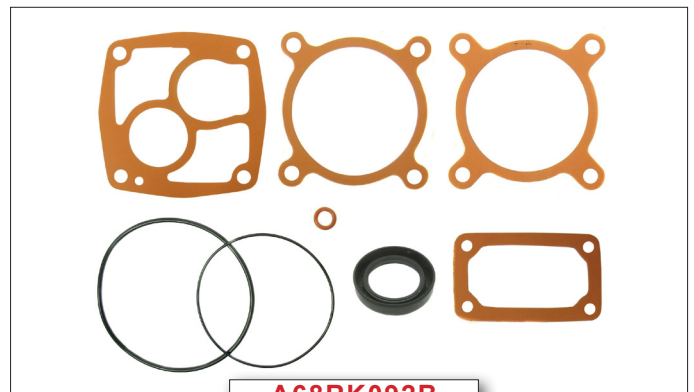

A68RK092B

Check our web site for suitability of these and other parts, or contact us directly.
 Original part numbers are used for reference only. Check all applications.
 All parts offered are Majorsell brand and may not be of an original supply.
 Majorsell kit content and ring sets may be different to the original.



KZ1114



Crankshaft



Bushes



140240

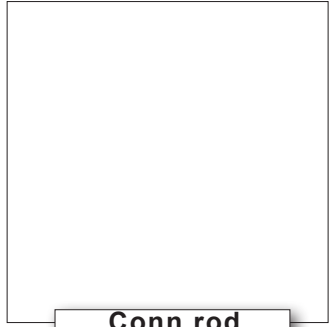

Conn rod



Head

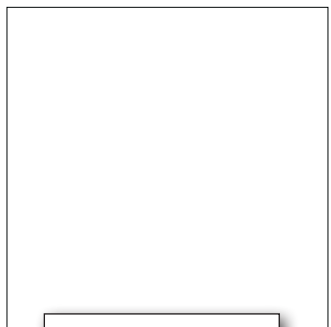
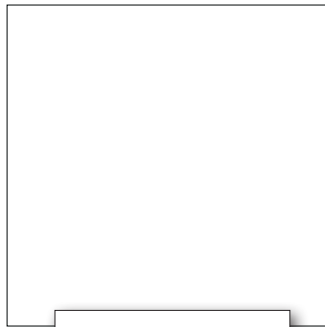

End cover

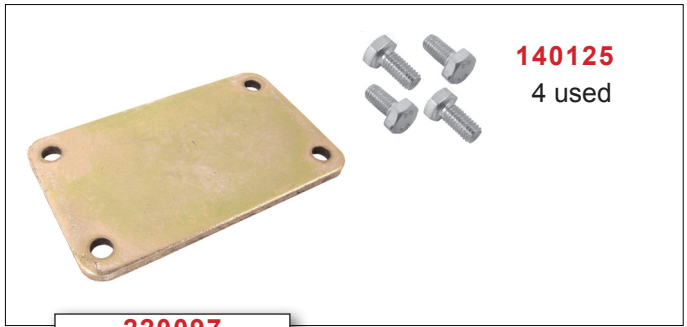

220097

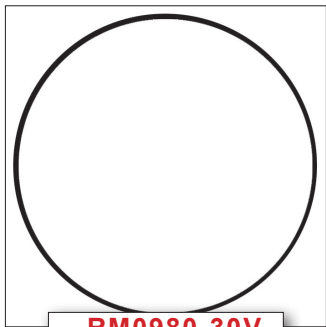

RM0980-30V

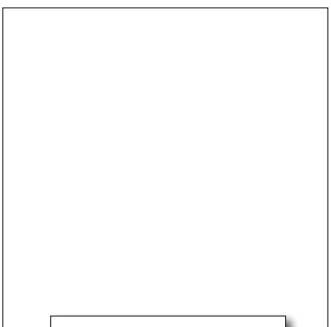
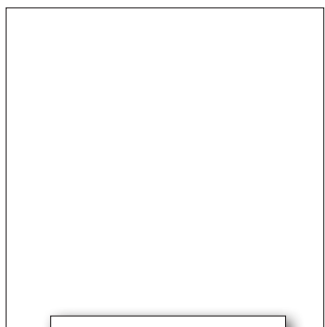
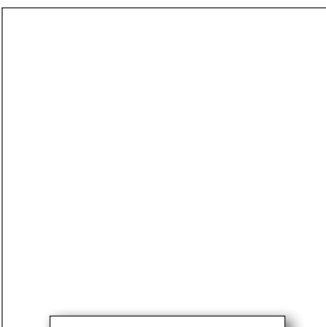
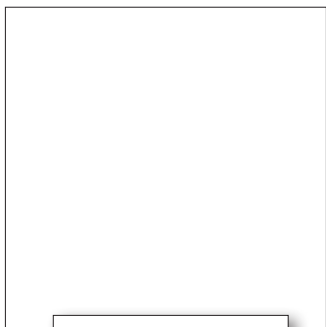
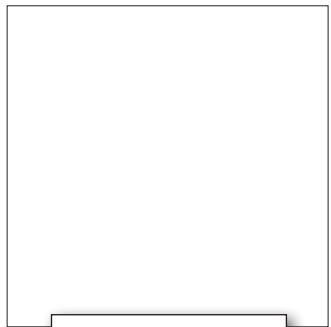
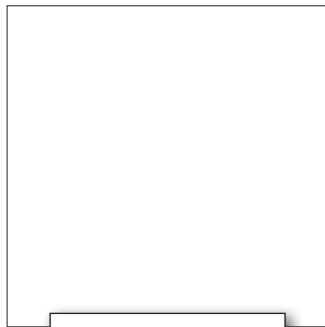
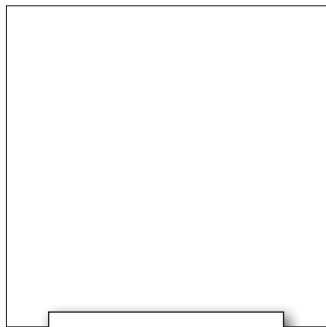

Majorsell parts for :-

KZ1265-2

Principal users :-
Foden

**MAJORSELL
REBUILD**

WDKZ12652

68A101R



- 80 mm bore.
- Non through drive.
- Water cooled.
- Weight : 12 Kg.
- Base mount.
- Engine oil lubrication.
- Water ports : 1/2".
- Air inlet : 3/4", air delivery : 1/2".

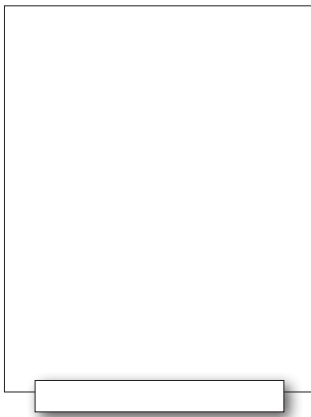

A68RK105C

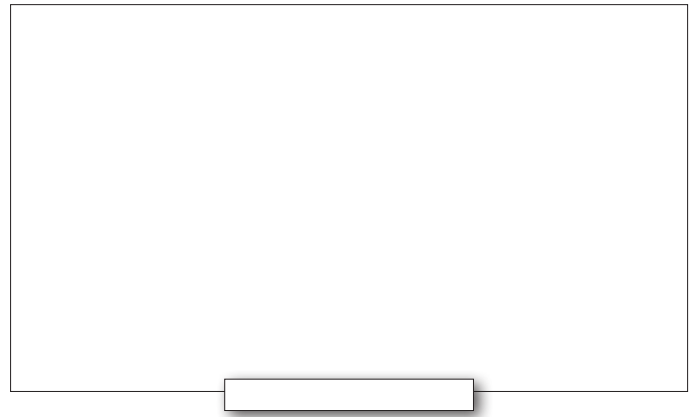

A68RK105V

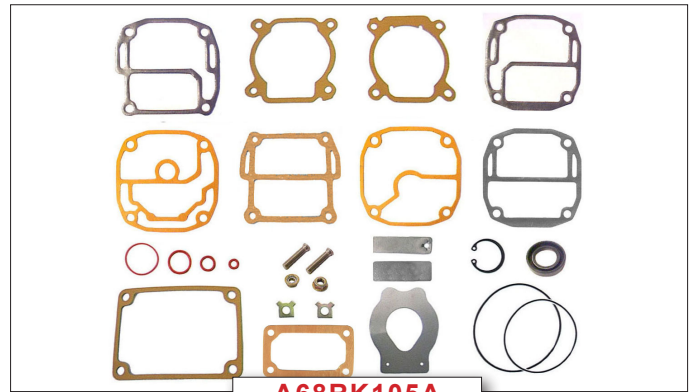

A68RK105A

020140	Std	A68RK110
020141	+0.50 mm	A68RK111
020142	+1.00 mm	A68RK114

	80 mm	
	2 x 2 mm	
	1 x 4 mm	

Piston & Rings

Ring set

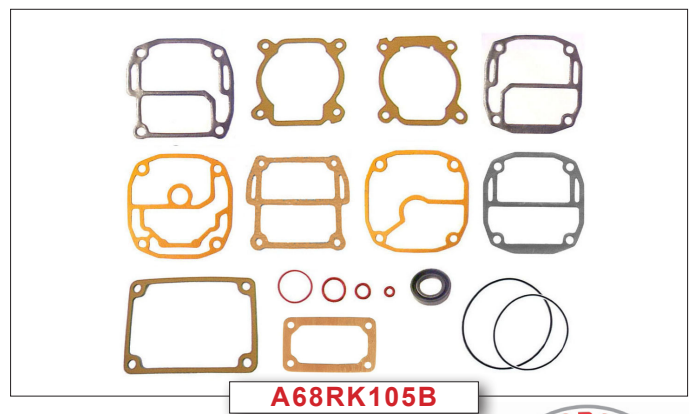

A68RK105B

Check our web site for suitability of these and other parts, or contact us directly.
Original part numbers are used for reference only. Check all applications.
All parts offered are Majorsell brand and may not be of an original supply.
Majorsell kit content and ring sets may be different to the original.



KZ1265-2



Crankshaft

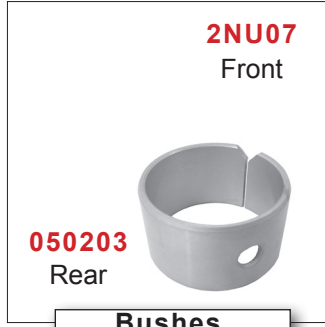

Bushes



090004



Conn rod



Head

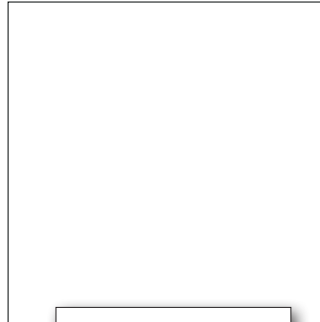

050026

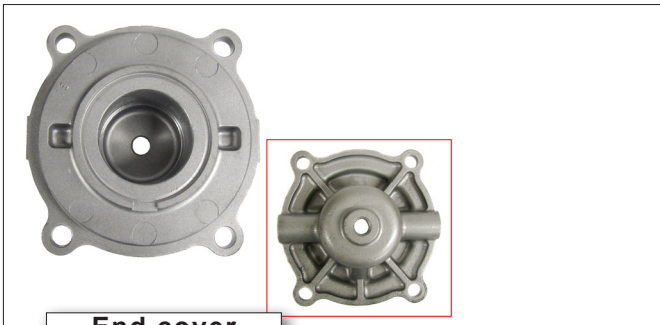

End cover

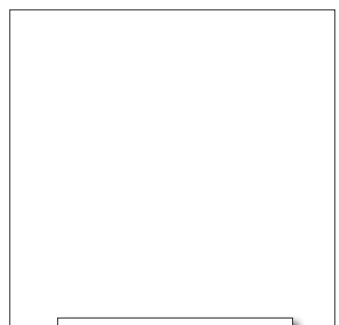
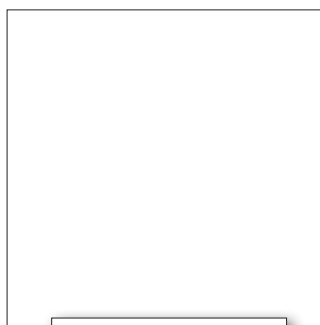
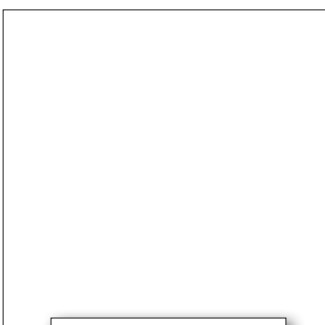
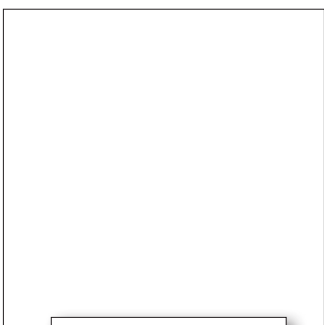
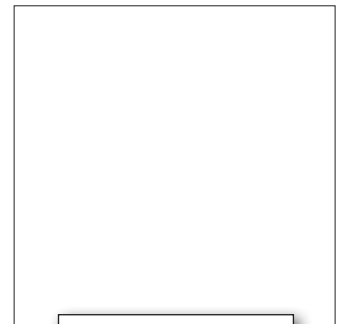
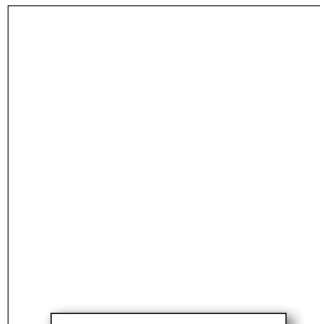
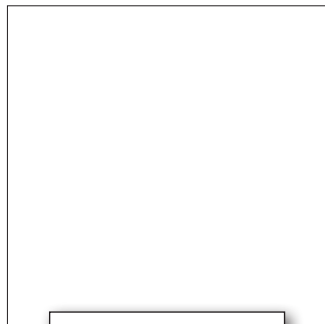
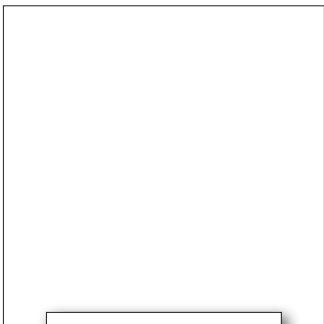
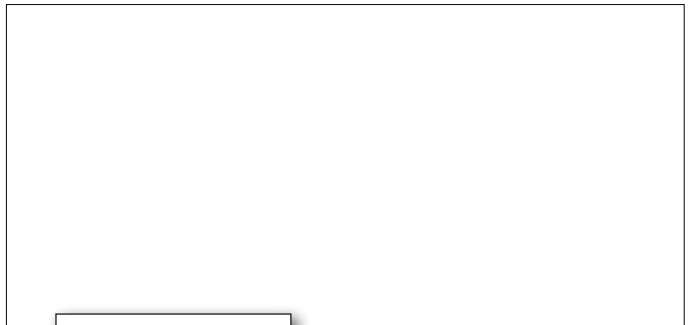

Majorsell parts for :-

KZ642

Principal users :-
Scania ERF DAF

571043, 300162
136751-4R
BBU7608

**MAJORSELL
REBUILD**

**68A001R
68A001R
68A001R**

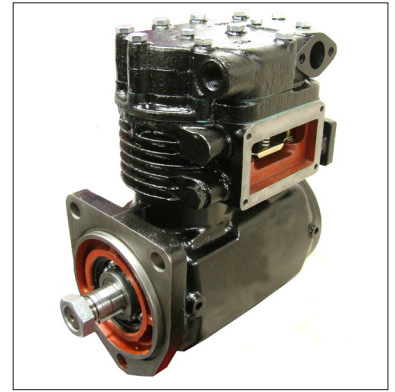

- 75 mm bore.
- Non through drive.
- Water cooled.
- Weight : 19 Kg.
- Flange mount.
- Engine oil lubrication.
- Water ports : M18 x 1.5 mm.
- Air ports : flanges.

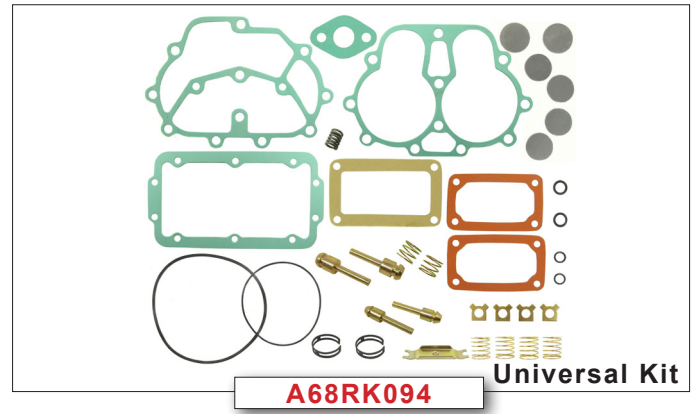
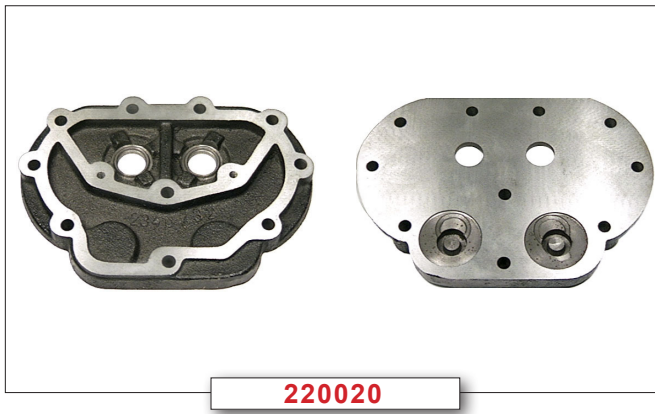
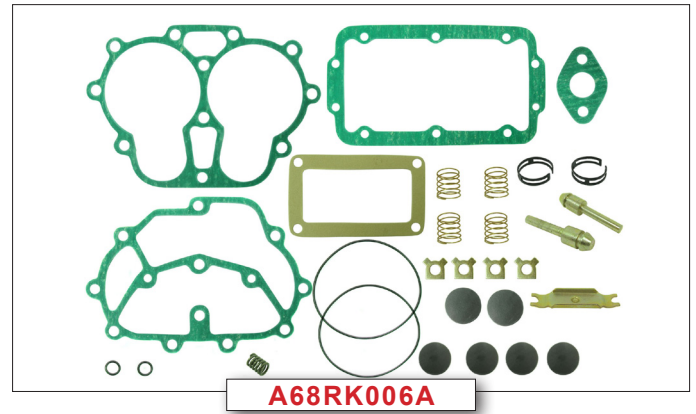
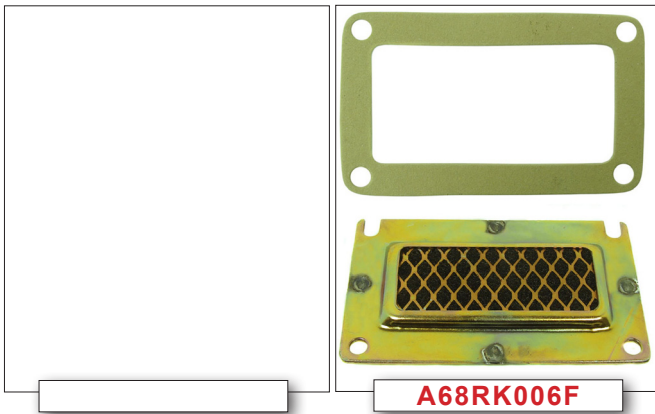

<p>020011 Std A68RK024 020012 +0.25 mm A68RK025 020013 +0.50 mm A68RK026 020014 +0.75 mm A68RK027 020088 +1.00 mm A68RK095</p>	<p>75 mm 4 x 3/32" mm 2 x 5/32" mm</p>	<p>1 Kit = 2 pistons Ring set</p>
--	--	---

Piston & Rings

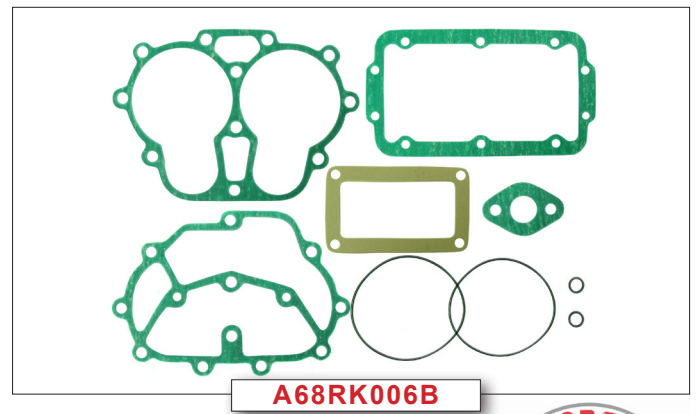

Check our web site for suitability of these and other parts, or contact us directly.
Original part numbers are used for reference only. Check all applications.
All parts offered are Majorsell brand and may not be of an original supply.
Majorsell kit content and ring sets may be different to the original.



KZ642



220008

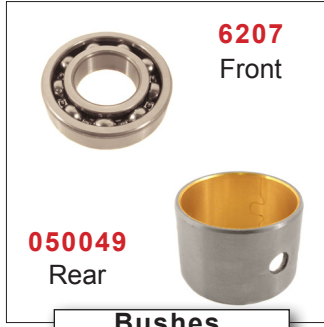

050049
Rear

6207
Front

Bushes



140014



220019



220021

140120
10 used

140126
2 used



220326



060142
2 used



220009
New Style



220097
2 used

140125
8 used

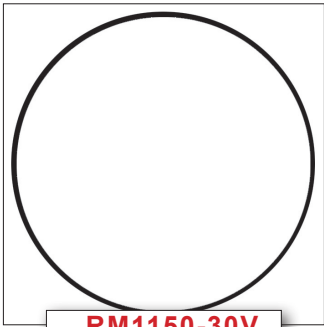

RM1150-30V



130010

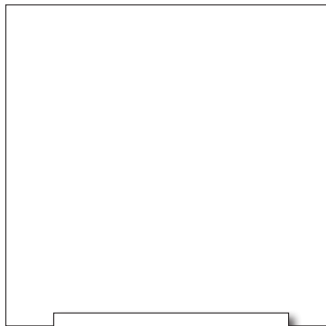
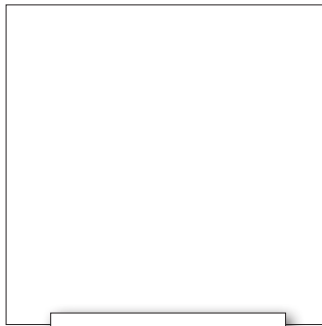
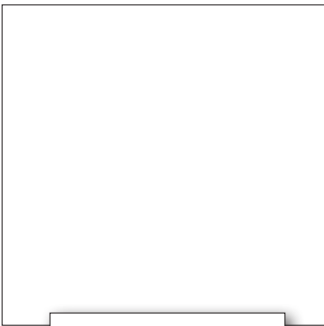
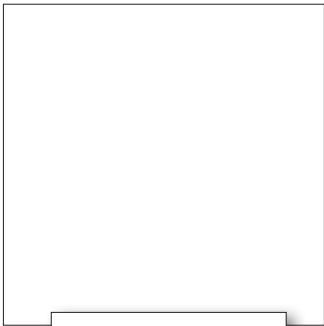
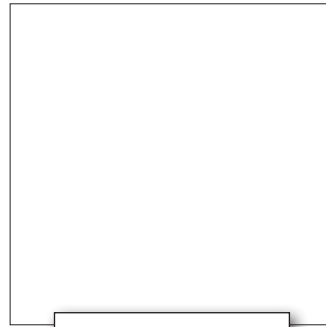
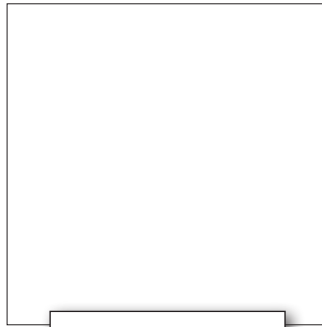

Majorsell parts for :-

Principal users :-
Volvo - Scania

TYPICAL 15.5/440

DISC VALVE

**MAJORSELL
REBUILD**

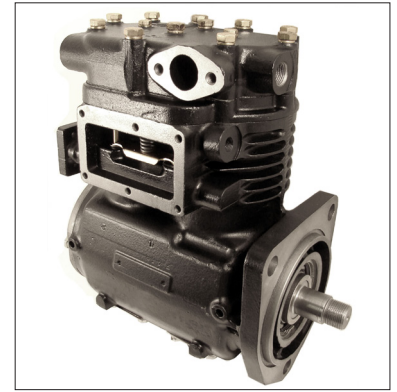

- 75 mm bore.
- Non through drive.
- Water cooled.
- Weight 21 Kg.
- Flange mount.
- Engine oil lubrication.
- Water ports : metric or imperial.
- Air ports : metric or imperial.

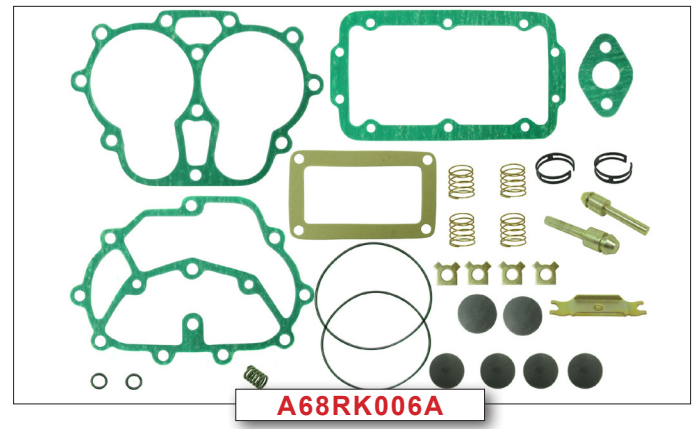
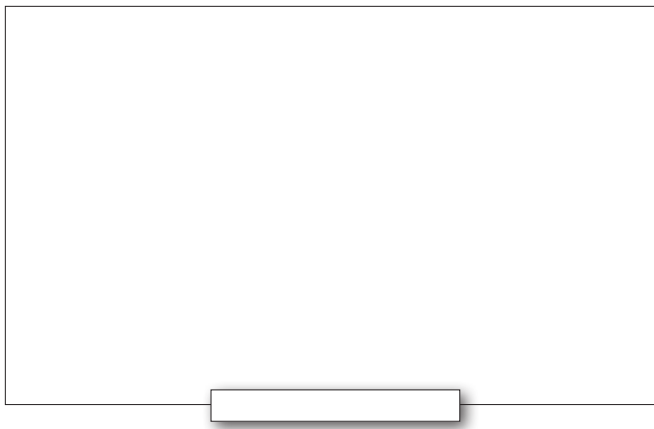
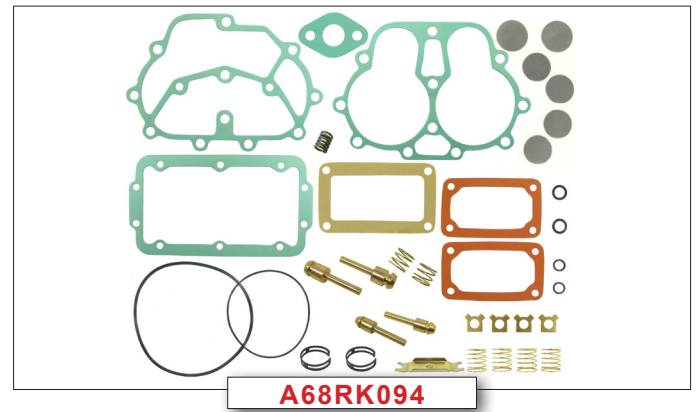

020011	Std	A68RK024
020012	+0.25 mm	A68RK025
020013	+0.50 mm	A68RK026
020014	+0.75 mm	A68RK027
020088	+1.00 mm	A68RK095

75 mm
4 x $\frac{3}{32}$
2 x $\frac{5}{32}$

Piston & Rings **Ring set**

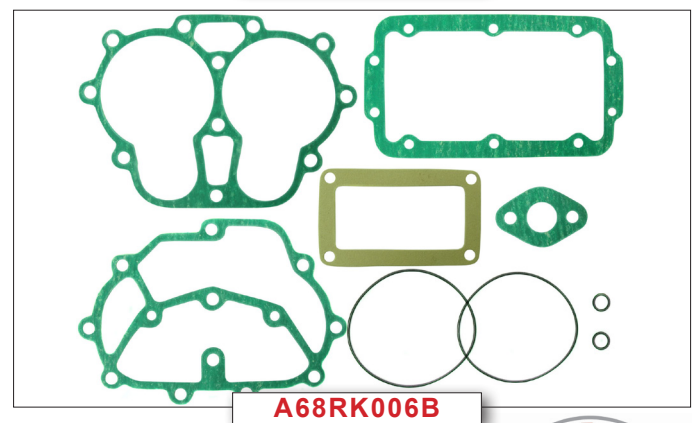

Check our web site for suitability of these and other parts, or contact us directly.
Original part numbers are used for reference only. Check all applications.
All parts offered are Majorsell brand and may not be of an original supply.
Majorsell kit content and ring sets may be different to the original.



TYPICAL 15.5/440



220008



Bushes



140014



220019

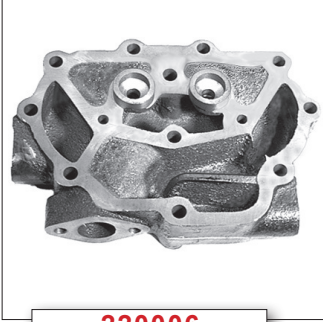

220006



220007



220009

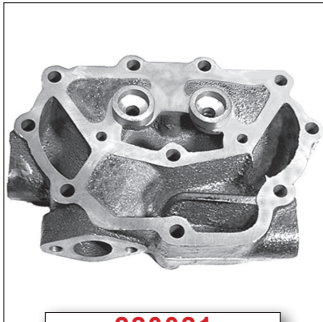
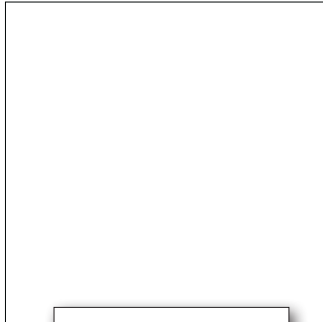

220021



220020



220097



220098



060142



220326

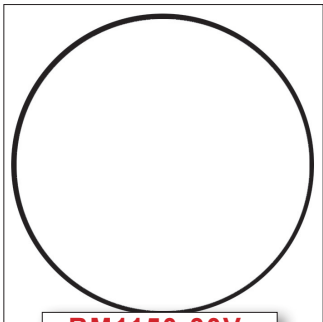
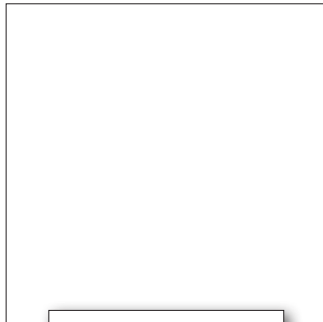
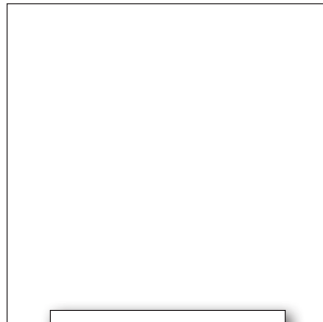

RM1150-30V

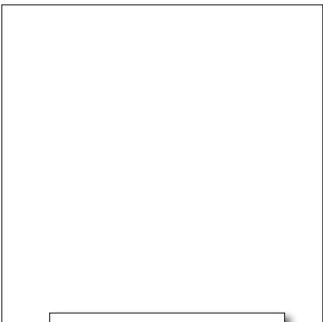
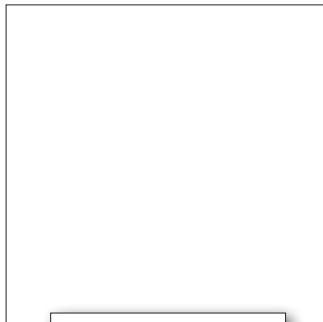
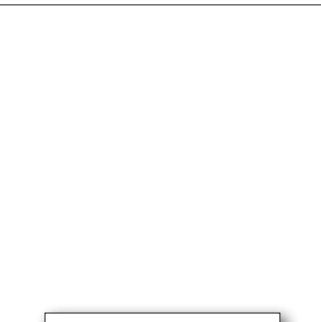

Majorsell parts for :-

Principal users :-
Volvo - Scania

TYPICAL 15.5/440

REED VALVE

**MAJORSSELL
REBUILD**

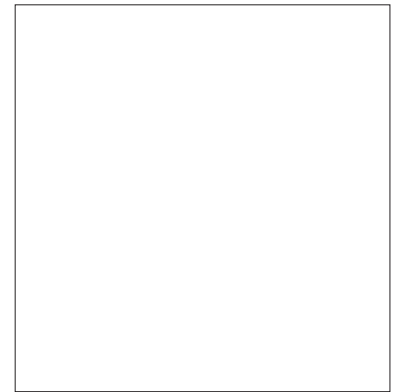

- 75 mm bore.
- Non through drive.
- Water cooled.
- Weight 21 Kg.
- Flange mount.
- Engine oil lubrication.
- Water ports : metric or imperial.
- Air ports : metric or imperial.



A68RK103C

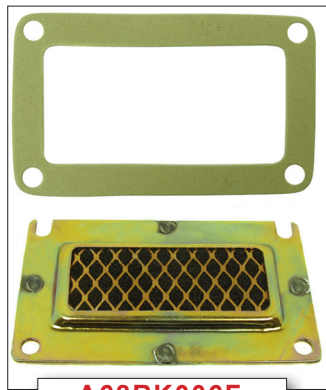

A68RK006F

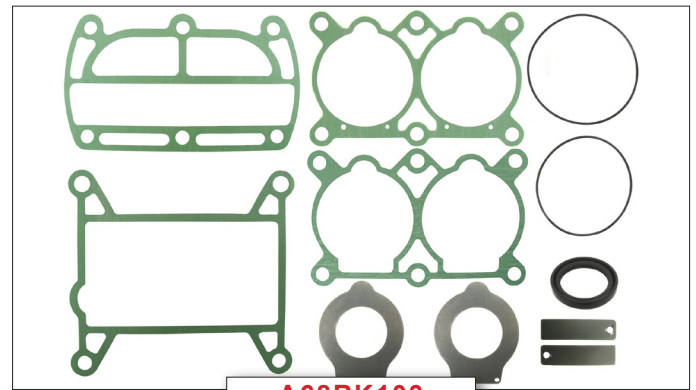

A68RK103



A68RK103V

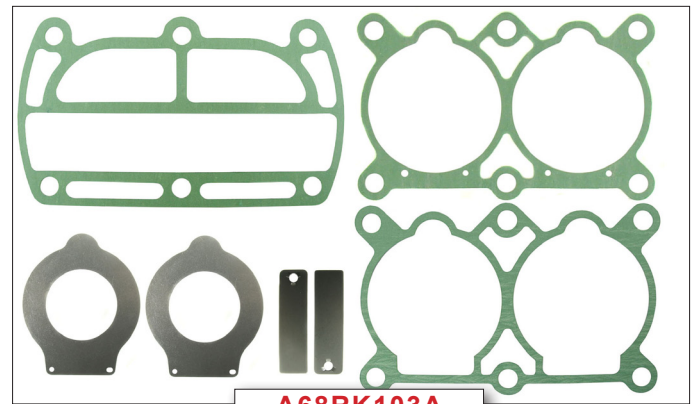

A68RK103A

020011	Std	A68RK024
020012	+0.25 mm	A68RK025
020013	+0.50 mm	A68RK026
020014	+0.75 mm	A68RK027
020088	+1.00 mm	A68RK095

75 mm

4 x $\frac{3}{32}$ mm

2 x $\frac{5}{32}$ mm

Piston & Rings

Ring set

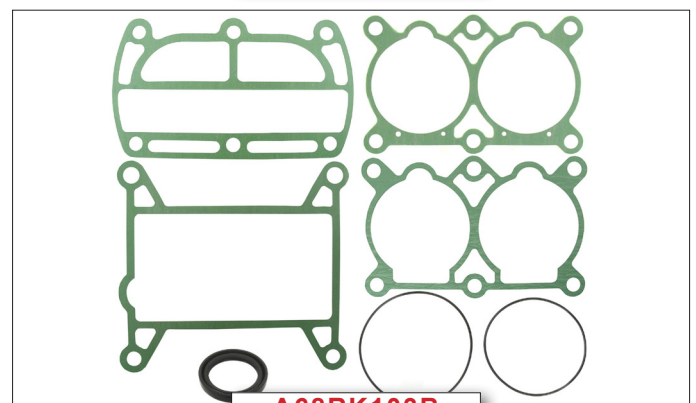

A68RK103B

Check our web site for suitability of these and other parts, or contact us directly.
Original part numbers are used for reference only. Check all applications.
All parts offered are Majorsell brand and may not be of an original supply.
Majorsell kit content and ring sets may be different to the original.



TYPICAL 15.5/440



220008



050049



140014



220019

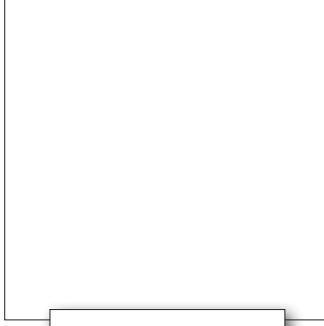
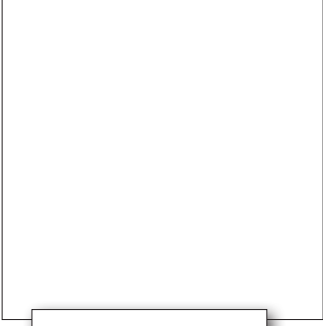

220009



110004

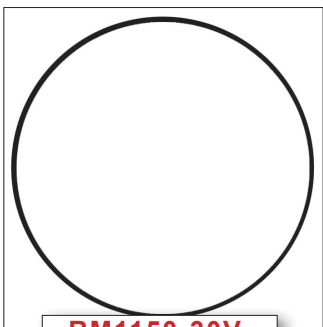
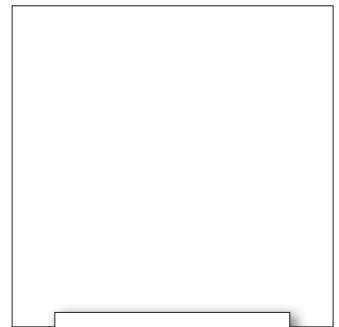
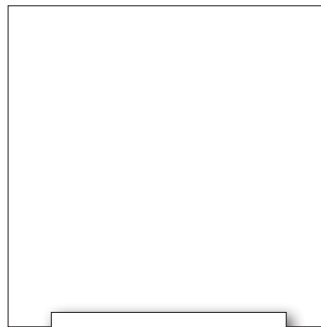
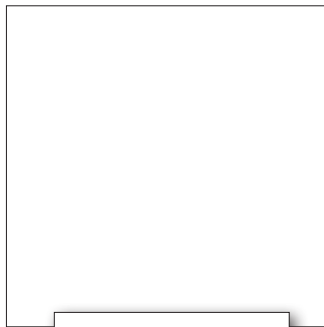
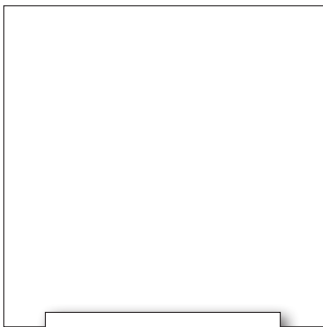
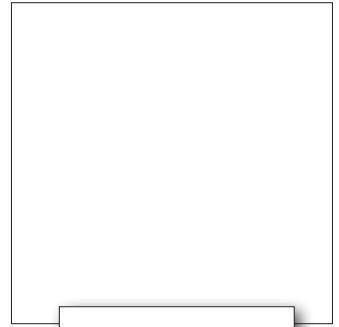
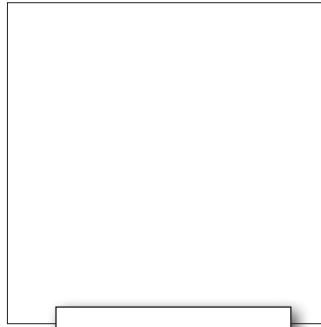
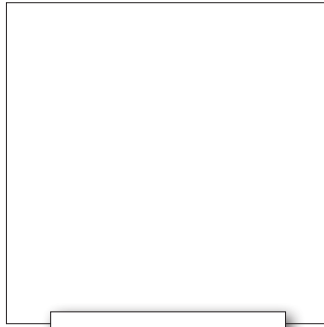
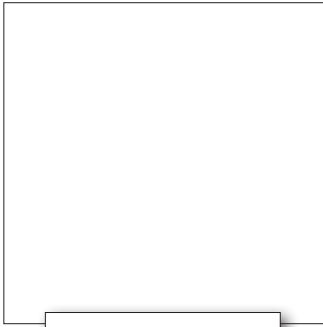

RM1150-30V

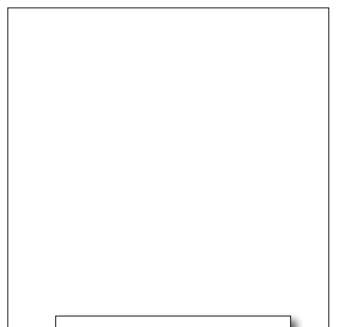
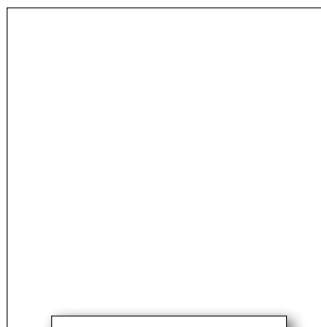
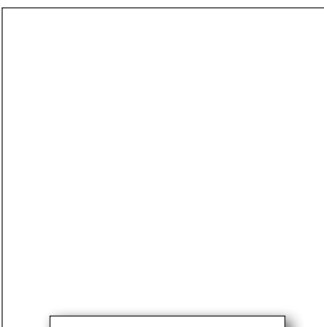

Majorsell Ltd
ENGLAND
sales@majorsell.co.uk
www.majorsell.co.uk

Notes :-



Majorsell parts for :-

Principal users :-

TYPICAL TF500 PARTS

**MAJORSELL
REBUILD**

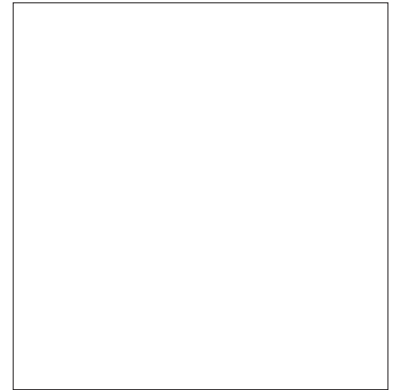

- 2 1/2" mm bore.
- Air and water cooled.
- Weight 25 Kg (+/-).
- Various mount.



B68RK003



A68RK056A



A69RK021

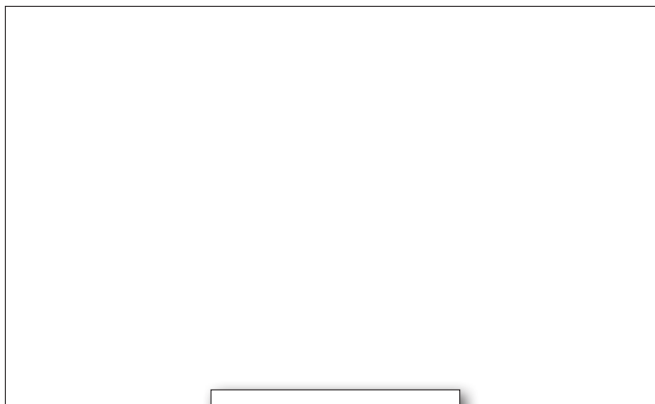

A69RK021A

020000	Std	A68RK001
020001	+0.010	A68RK002
020002	+0.020	A68RK003
020003	+0.030	A68RK004
020004	+0.040	A68RK005

2 1/2" bore

6 x 3/32"

4 x 1/18"

Pistons supplied without rings.

Piston & Rings

Ring set



A69RK021B

Check our web site for suitability of these and other parts, or contact us directly. Original part numbers are used for reference only. Check all applications. All parts offered are Majorsell brand and may not be of an original supply. Majorsell kit content and ring sets may be different to the original.



TYPICAL TF500 PARTS



060070



060140



Front

6207



Rear

6011

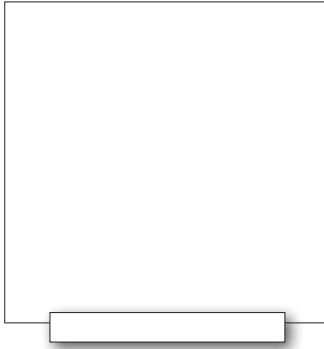
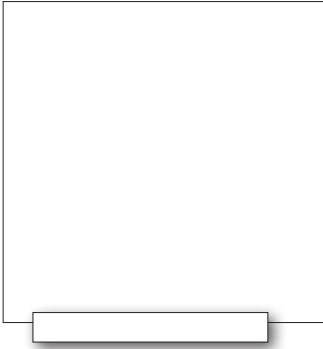

090008



050005 STD

050007 +020``

Tab inserts

050108	1.97`` O.D.
050114	2.76``
050132	2.60``

TF Washers

050049	NO HOLE	2.13`` O.D.
050064	SLOT HOLE	2.30``
050103	NO HOLE	1.50``
050109	NO HOLE	2.30
050115	SLOT HOLE	1.50
As required		

TF Bushes

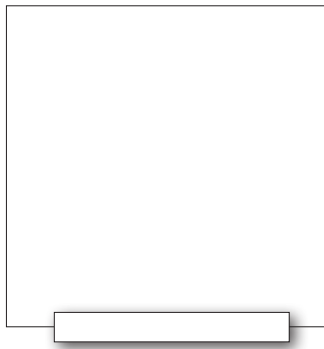
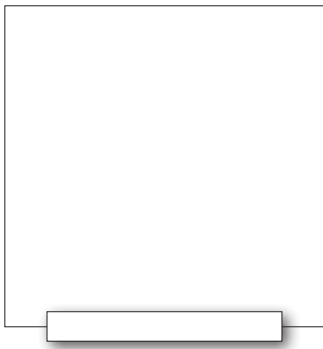

050108



050059

$6 \times \frac{3}{32}$	$10 \times \frac{3}{32}$	
$4 \times \frac{1}{8}$		
Std	A68RK072	A68RK014
+0.010	A68RK073	A68RK015
+0.020	A68RK074	A68RK016
+0.030	A68RK075	A68RK017
+0.040	A68RK076	A68RK018
Alternative design - no pistons available		

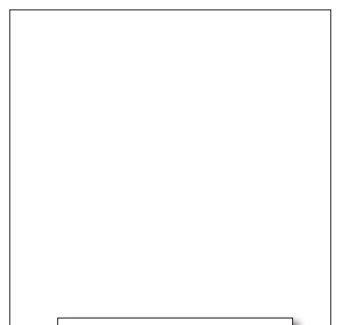
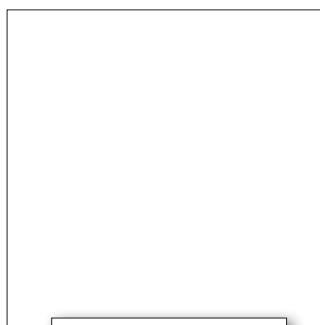

Majorsell parts for :-

Principal users :-

TYPICAL TF501 PARTS

**MAJORSELL
REBUILD**

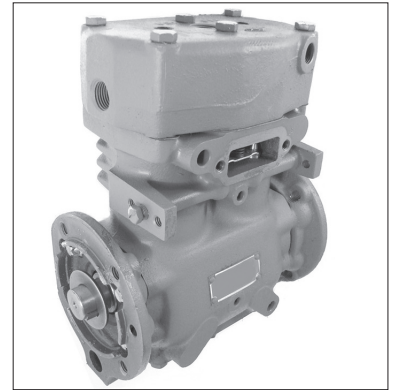

68A053R

• 2 5/8" mm bore.

• Various mount.

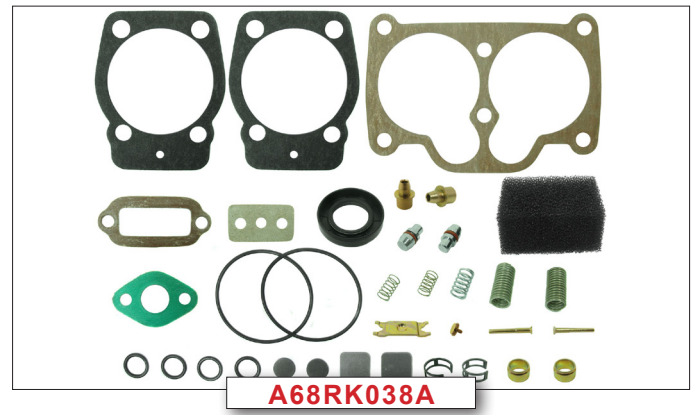
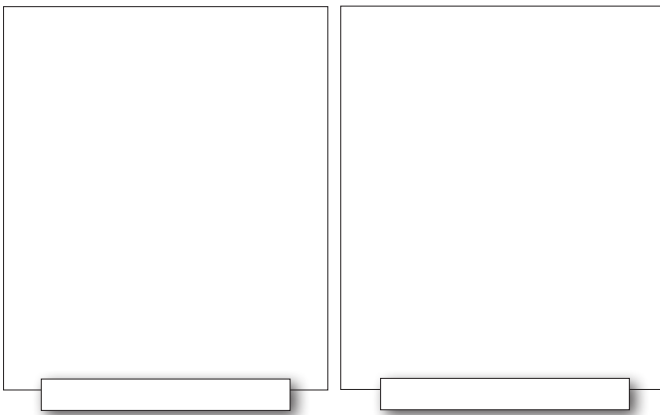

A68RK038A

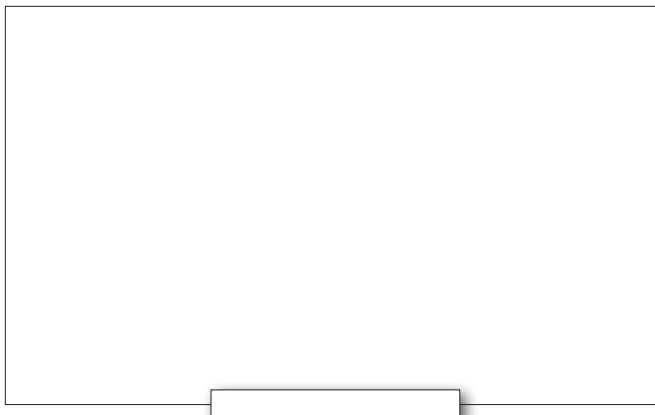

A68RK056A

<p>020028 020029 020030 020031 020032</p>	<p>Std +0.010" +0.020" +0.030" +0.040"</p> <p>2 5/8" bore 6 x 3/32 mm 4 x 1/18 mm</p>	<p>A68RK051 A68RK052 A68RK053 A68RK054 A68RK055</p>
---	---	---

Pistons supplied without rings.

Piston & Rings

Ring set

D2 KIT

B68RK003

Check our web site for suitability of these and other parts, or contact us directly. Original part numbers are used for reference only. Check all applications. All parts offered are Majorsell brand and may not be of an original supply. Majorsell kit content and ring sets may be different to the original.



TYPICAL TF501 PARTS



050114 STD
 050115 +0.010'
 050116 +0.020'
 050117 +0.030'

Inserts

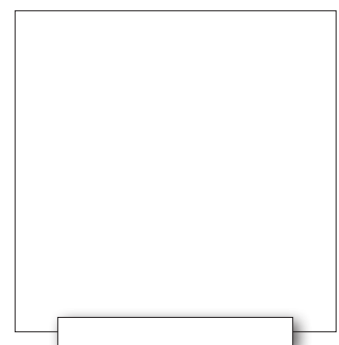
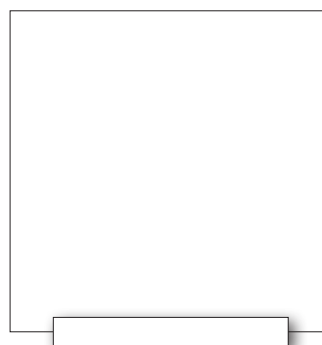
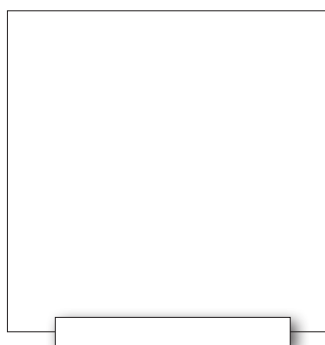
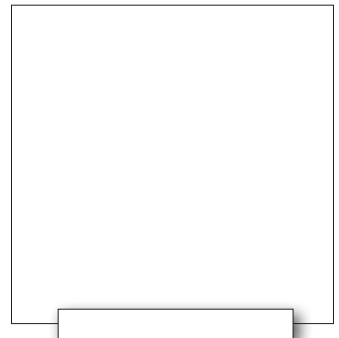

	6 x $\frac{3}{32}$	4 x $\frac{3}{32}$
	4 x $\frac{3}{16}$	2 x $\frac{3}{16}$
Std	A68RK067	A68RK046
+0.010'	A68RK068	A68RK047
+0.020'	A68RK069	A68RK048
+0.030'	A68RK070	A68RK049
+0.040'	A68RK071	A68RK050

Alternative design - no pistons available

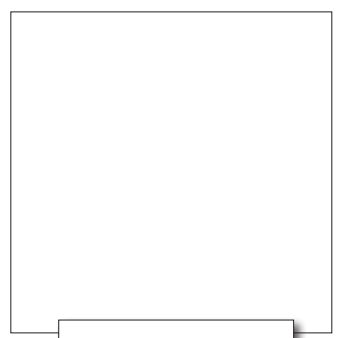
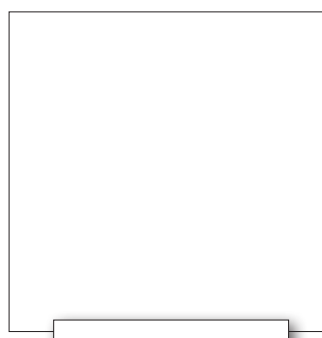

Majorsell parts for :-

Principal users :-

TYPICAL TF550-750 PARTS

**MAJORSELL
REBUILD**

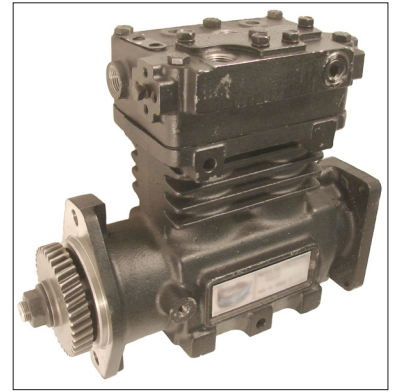

• 2 7/8" mm bore.

• Various mounts.

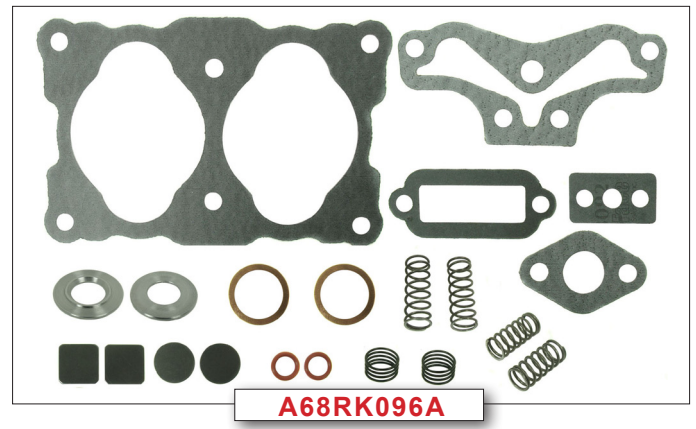
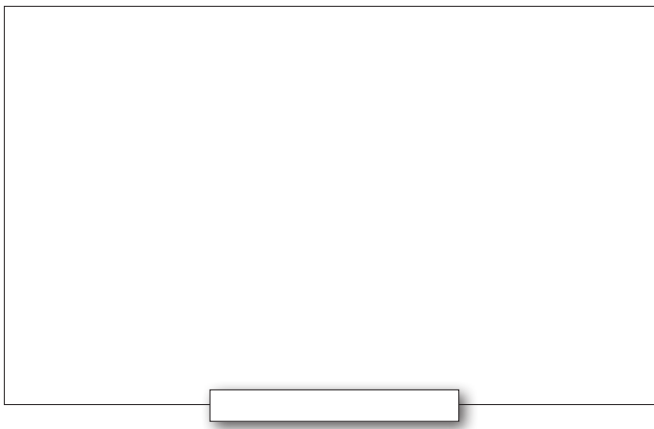
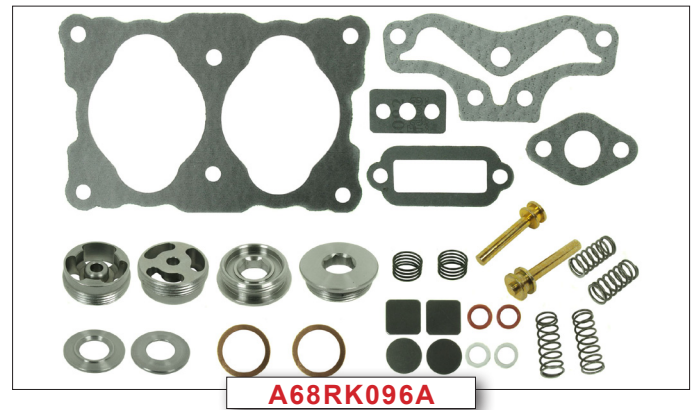
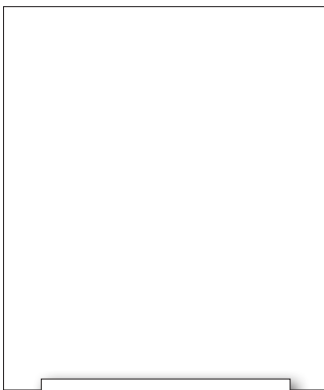

TF550		TF750
020106	Std	020101
020107	+0.010	020102
020108	+0.020	020103
020109	+0.030	020104
020110	+0.040	020105

Piston & Rings

Std

+0.010

+0.020

+0.030

+0.040

A68RK097

A68RK098

A68RK099

A68RK100

A68RK101

Rings for both

6 x 3/32

4 x 3/16

Ring set

Check our web site for suitability of these and other parts, or contact us directly. Original part numbers are used for reference only. Check all applications. All parts offered are Majorsell brand and may not be of an original supply. Majorsell kit content and ring sets may be different to the original.



TYPICAL TF550-750 PARTS



050064



050115



050202



050108



6207



6011



050171 STD
050172 +0.010'
050173 +0.020'
Inserts



050114



010393

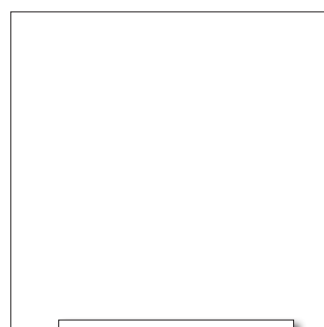
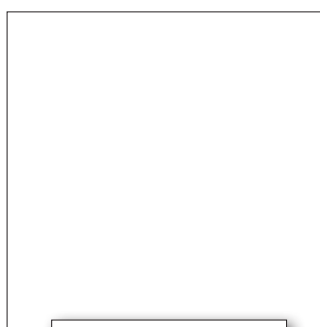
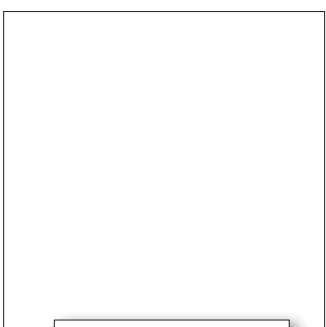
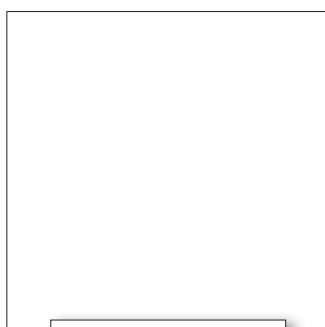
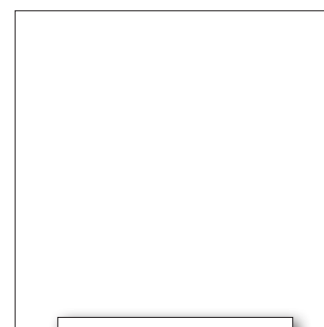
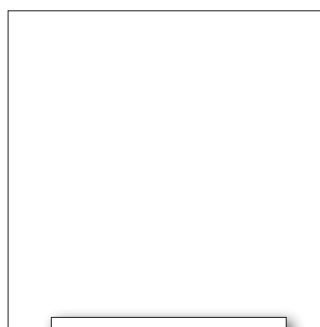
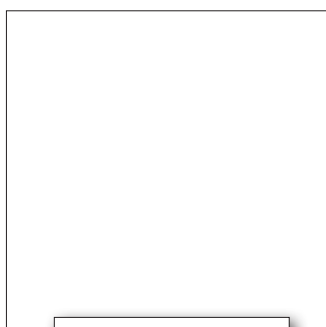
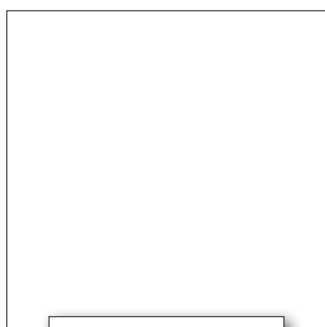
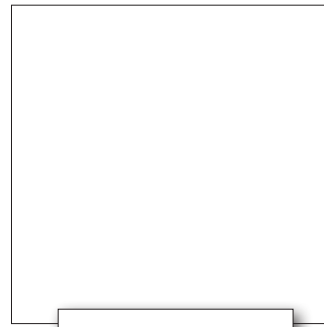
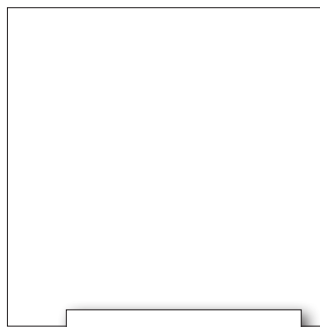
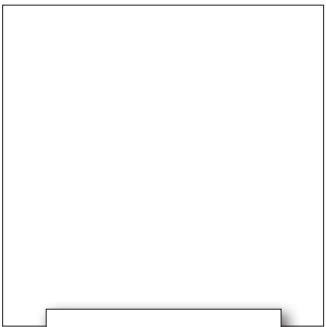

Majorsell parts for :-

TYPICAL TF600-TF700 PARTS

Principal users :-

**MAJORSSELL
REBUILD**

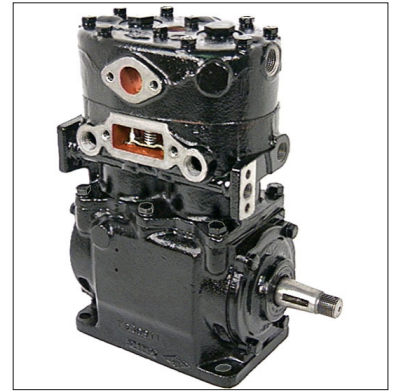

• 2 3/4" mm bore.

• Various mounts.

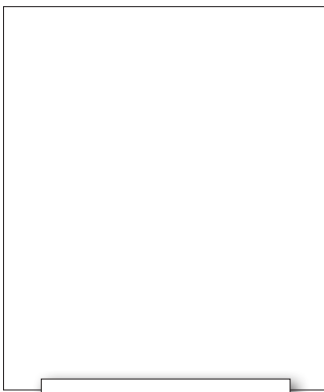

A68RK056A

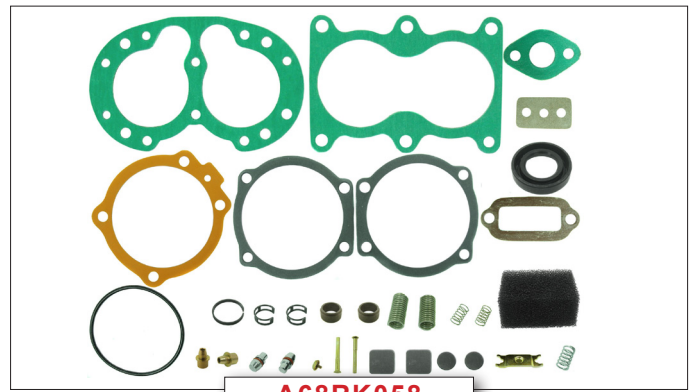

A68RK058

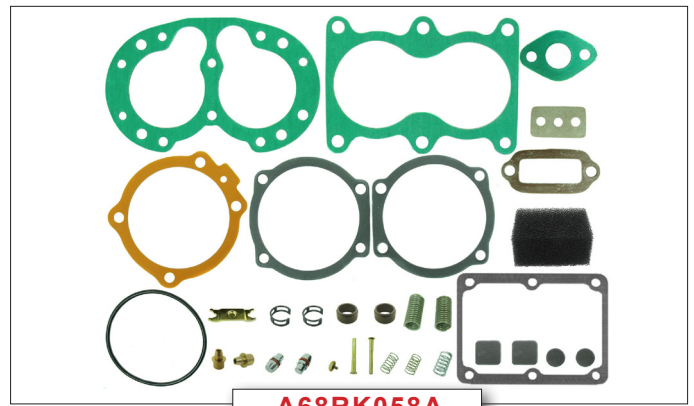
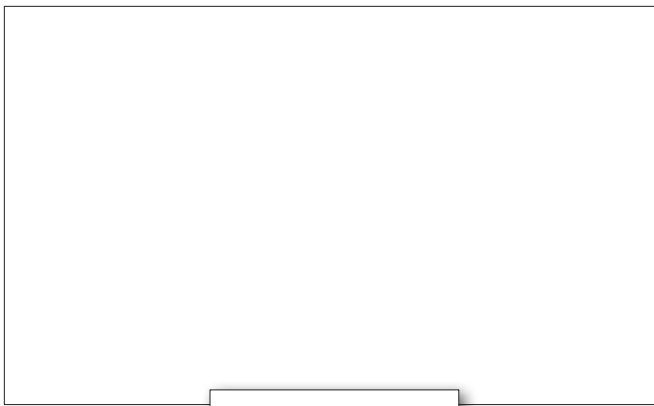

A68RK058A

<p>020038 020039 020040 020041 020042</p>	<p>Std +0.010 +0.020 +0.030 +0.040</p>	<p>A68RK019 A68RK020 A68RK021 A68RK022 A68RK023</p>
---	--	---

2 5/8" bore

6 x 3/32"
4 x 1/18"

Pistons supplied without rings

Piston & Rings

Ring set

D2 KIT

B68RK003

Check our web site for suitability of these and other parts, or contact us directly. Original part numbers are used for reference only. Check all applications. All parts offered are Majorsell brand and may not be of an original supply. Majorsell kit content and ring sets may be different to the original.



TYPICAL TF600-TF700 PARTS



110014



6011
6207



09008



STD
050009



220196

140173
10 used



060070



060140

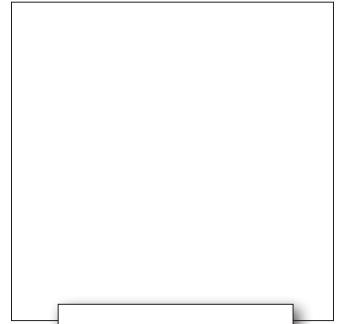
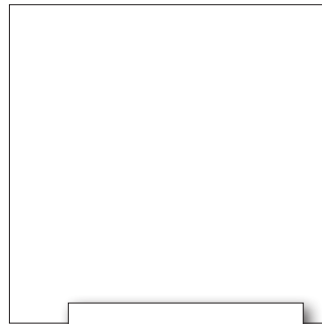
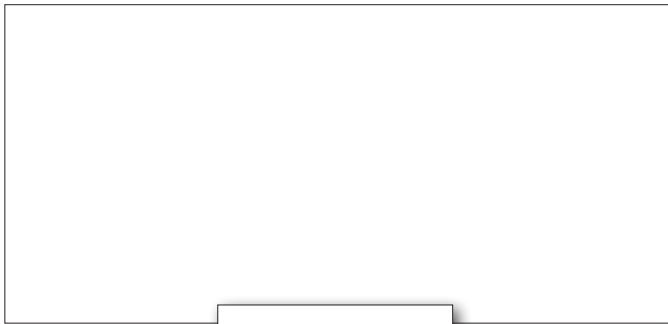

050115



050108



050114



050132



050059



050064



050103



050109

TYPICAL 2150 PARTS

BX007

**B
E
N
D
I
X**



A68RK009



A68RK009A

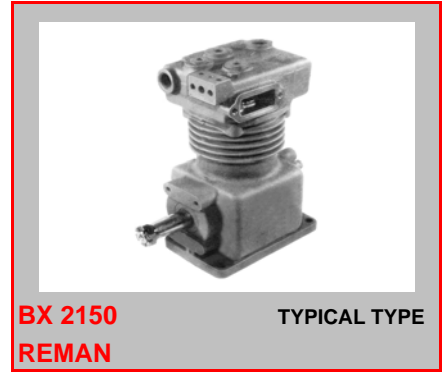

**BX 2150
REMAN**

TYPICAL TYPE



B68RK003 D2 GOVERNOR KIT



A68RK056A

COMPRESSORS USING A68RK009

TO SEE SOME APPLICATIONS FOR BX 2150 COMPRESSORS REFER TO OUR WEB SITE. SOME COMPONENTS ILLUSTRATED DO NOT FIT ALL APPLICATIONS.



PISTONS
2 5/8" SUPPLIED WITHOUT RINGS

- 020028 STD
- 020029 +010"
- 020030 +020"
- 020031 +030"
- 020032 +040"

SUITABLE FOR 020028 > 020032

- | | |
|-------|----------|
| STD | A68RK051 |
| +010" | A68RK052 |
| +020" | A68RK053 |
| +030" | A68RK054 |
| +040" | A68RK055 |

RINGS
6 x 3/32", 4 x 1/8"

NO PISTON AVAILABLE

- | | |
|-------|----------|
| STD | A68RK046 |
| +010" | A68RK047 |
| +020" | A68RK048 |
| +030" | A68RK049 |
| +040" | A68RK050 |

RING KIT
4 x 3/32", 2 x 3/16" FOR 2 PISTONS
3 RING PISTON

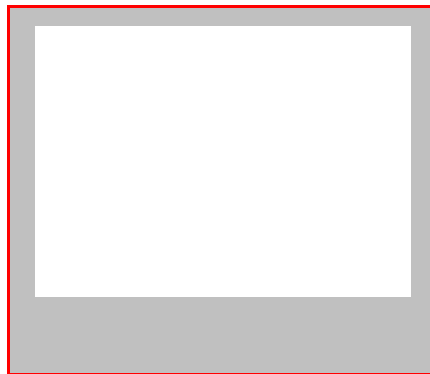

CHECK OUR WEB SITE FOR SUITABILITY OF THESE AND OTHER PARTS, OR CONTACT US.

ALL PARTS OFFERED ARE MAJORSELL BRAND AND MAY NOT BE OF AN ORIGINAL SUPPLY.

ORIGINAL PART NUMBERS ARE USED FOR REFERENCE ONLY. **CHECK ALL APPLICATIONS.**



Fax ++44 121 455 0272 sales@majorsell.co.uk www.majorsell.co.uk



BX007.1

TYPICAL 2150 PARTS

**B
E
N
D
I
X**

050059	NO HOLE	2.13" O.D.
050064	SLOT HOLE	2.30"
050103	NO HOLE	1.50"
050109	NO HOLE	2.30"
050115	SLOT HOLE	1.50"

SOME OVER SIZES AVAILABLE

AS REQUIRED

TF BUSHES



WHERE FITTED

050108



110014

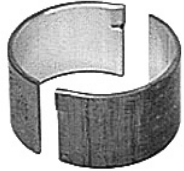

- 050014 STD
- 050015 +010"
- 050016 +020"
- 050017 +030"

INSERTS



TYPICAL TF 400 PARTS

BX008

**B
E
N
D
I
X**

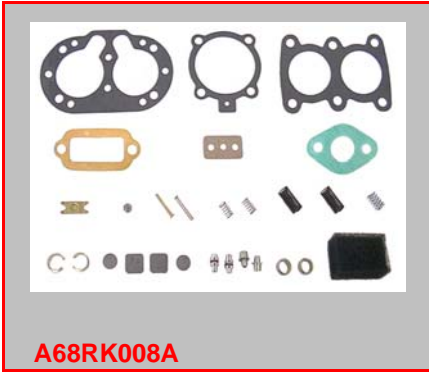

A68RK008A



A68RK008D

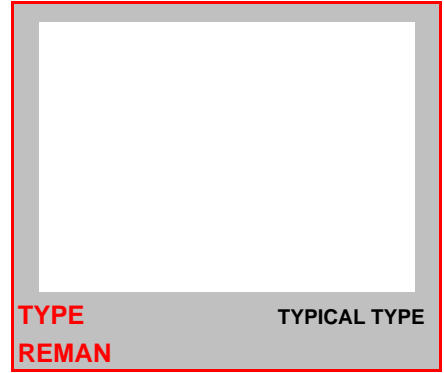

**TYPE
REMAN**

TYPICAL TYPE



B68RK003 D2 GOVERNOR KIT



A68RK056A

COMPRESSORS USING A68RK008

TO SEE SOME APPLICATIONS FOR TF 400 COMPRESSORS REFER TO OUR WEB SITE. SOME COMPONENTS ILLUSTRATED DO NOT FIT ALL APPLICATIONS.



PISTONS

SUITABLE FOR 020033 > 020036

STD	A68RK032
+010"	A68RK033
+020"	A68RK034
+030"	A68RK035

8 x 1/8"

RINGS



A68RK032

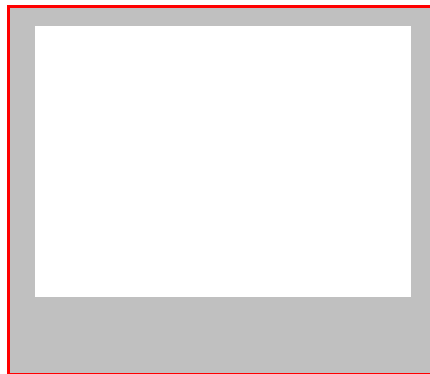

CHECK OUR WEB SITE FOR SUITABILITY OF THESE AND OTHER PARTS, OR CONTACT US.

ALL PARTS OFFERED ARE MAJORSELL BRAND AND MAY NOT BE OF AN ORIGINAL SUPPLY.

ORIGINAL PART NUMBERS ARE USED FOR REFERENCE ONLY. **CHECK ALL APPLICATIONS.**



Fax ++44 121 455 0272 sales@majorsell.co.uk www.majorsell.co.uk



BX008.1

TYPICAL TF 400 PARTS

**B
E
N
D
I
X**

050059	NO HOLE	2.13" O.D.
050064	SLOT HOLE	2.30"
050103	NO HOLE	1.50"
050109	NO HOLE	2.30"
050115	SLOT HOLE	1.50"

SOME OVER SIZES AVAILABLE
AS REQUIRED
TF BUSHES

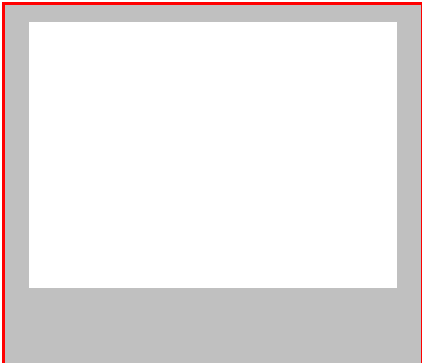
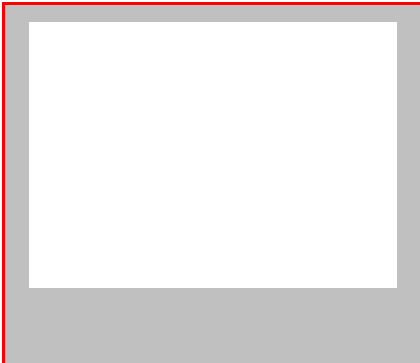
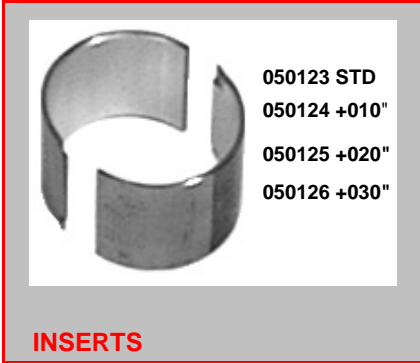

TYPICAL TF 1000 PARTS

BX009

**B
E
N
D
I
X**



A69RK021 2 USED



A69RK021A UNIVERSAL KIT



TF 1000 TYPICAL TYPE

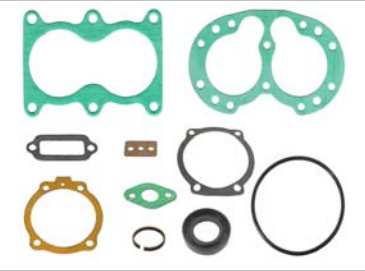

A69RK021B



A68RK056A

COMPRESSORS USING A69RK021

TO SEE SOME APPLICATIONS FOR TF 1000 COMPRESSORS REFER TO OUR WEB SITE. SOME COMPONENTS ILLUSTRATED DO NOT FIT ALL APPLICATIONS.



B68RK003 D2 GOVERNOR KIT



2 1/2" STD 4 USED

SUPPLIED WITHOUT RINGS

020000	A68RK001	STD
020001	A68RK002	+0.010"
020002	A68RK003	+0.020"
020003	A68RK004	+0.030"
020004	A68RK005	+0.040"

6 X 3/32", 4 X 1 1/8"

PISTONS & USUAL RINGS

FULL REPAIR REQUIREMENTS

2 x A69RK021A 1 x 090008
 1 x 010076 1 x 110008
 4 x PISTONS 2 X RING KITS
 4 PAIRS INSERTS

STD	A68RK072
+010"	A68RK073
+020"	A68RK074
+030"	A68RK075
+040"	A68RK076

6 X 3/32", 4 X 1 1/8"

RINGS DIFFERENT RING STYLE

STD	A68RK014
+010"	A68RK015
+020"	A68RK016
+030"	A68RK017
+040"	A68RK018

10 X 3/32"

RINGS ALL RINGS THE SAME

CHECK OUR WEB SITE FOR SUITABILITY OF THESE AND OTHER PARTS, OR CONTACT US.

ALL PARTS OFFERED ARE MAJORSELL BRAND AND MAY NOT BE OF AN ORIGINAL SUPPLY.

ORIGINAL PART NUMBERS ARE USED FOR REFERENCE ONLY. **CHECK ALL APPLICATIONS.**



Fax ++44 121 455 0272 sales@majorsell.co.uk www.majorsell.co.uk



BX009.1

TYPICAL TF 1000 PARTS

**B
E
N
D
I
X**



060070



060140



110008



090008

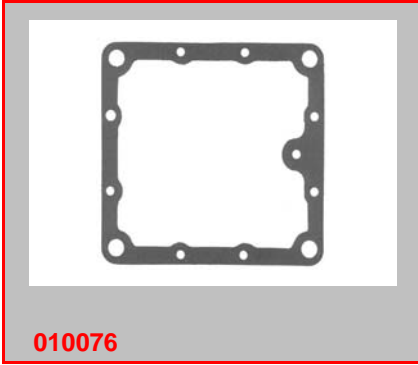

010076



050059	NO HOLE	2.13" O.D.
050064	SLOT HOLE	2.30"
050103	NO HOLE	1.50"
050109	NO HOLE	2.30"
050115	SLOT HOLE	1.50"

SOME OVER SIZES AVAILABLE
AS REQUIRED

TF BUSHES

050108	1.97" O.D.
050114	2.76"
050132	2.60"

AS REQUIRED

TF WASHERS

050095	STD
050096	+010"
050097	+020"
050098	+030"

2 TAB INSERTS



SOME TF GASKETS

BX010

**B
E
N
D
I
X**

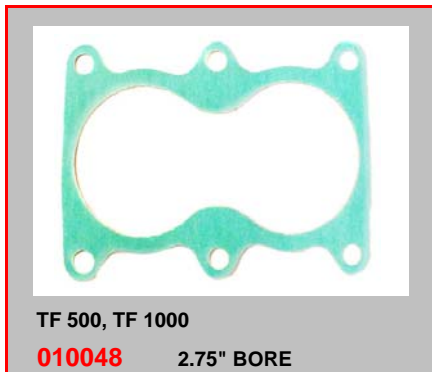
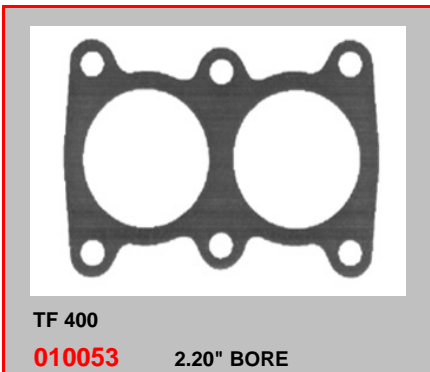
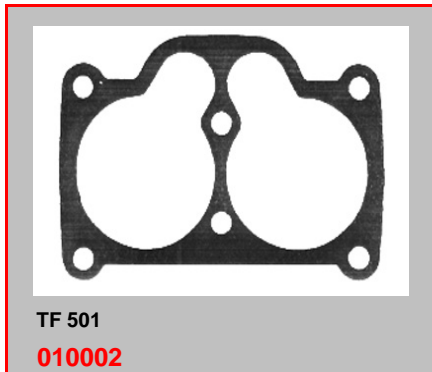
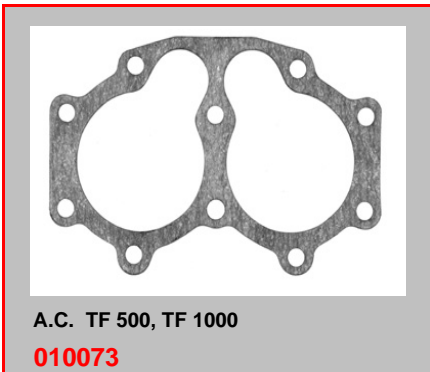
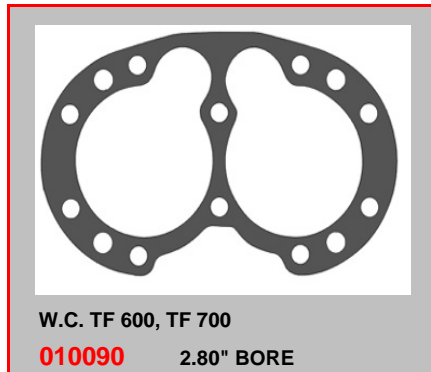
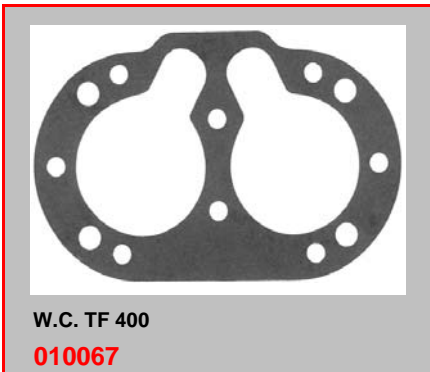

CHECK OUR WEB SITE FOR SUITABILITY OF THESE AND OTHER PARTS, OR CONTACT US.
ALL PARTS OFFERED ARE MAJORSELL BRAND AND MAY NOT BE OF AN ORIGINAL SUPPLY.
ORIGINAL PART NUMBERS ARE USED FOR REFERENCE ONLY. **CHECK ALL APPLICATIONS.**



Fax ++44 121 455 0272 sales@majorsell.co.uk www.majorsell.co.uk



BX010.1

SOME TF GASKETS

B
E
N
D
I
X

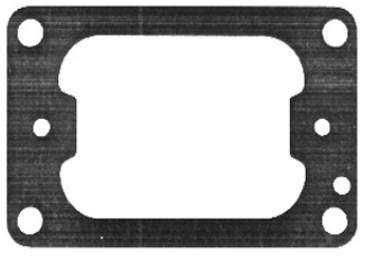

TF 400, TF 500, TF 600, TF 700, TF 1000
010001

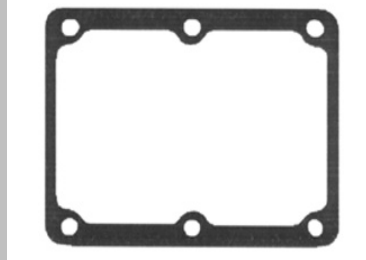

TF 500
010027

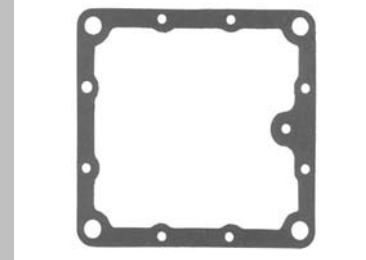

TF 1000
020076

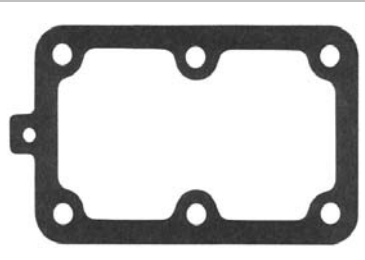

TF 501
010092



TF 500, TF 600, TF 700
010061

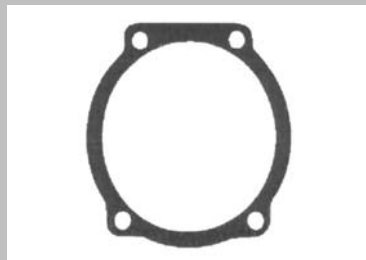

TF 500, TF 600, TF 700
010050

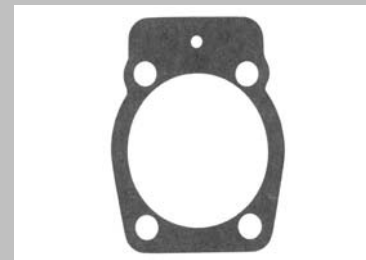

TF 501
010095



TYPICAL PARTS FOR BX 921, BX 922

BX011

**B
E
N
D
I
X**

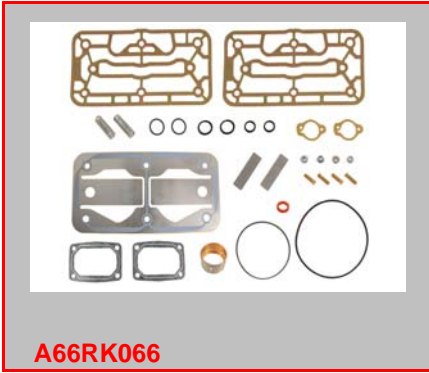

A66RK066

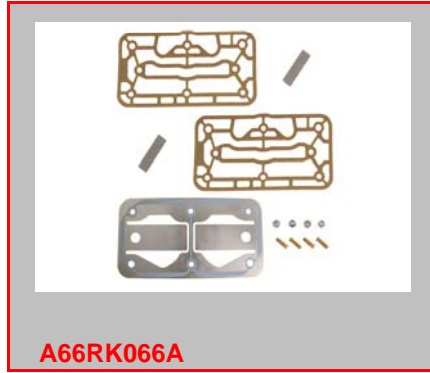

A66RK066A

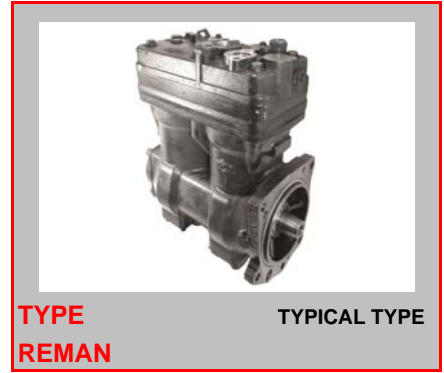

**TYPE
REMAN**

TYPICAL TYPE

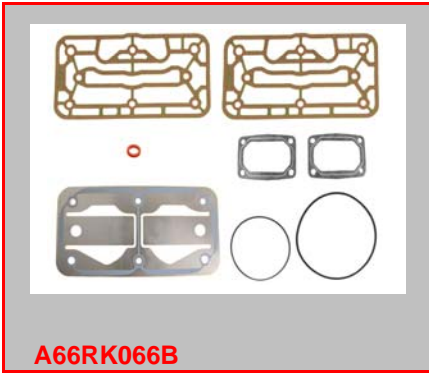

A66RK066B



A66RK066C SINGLE

TO SEE SOME APPLICATIONS FOR 921 & 922 COMPRESSORS REFER TO OUR WEB SITE. SOME COMPONENTS ILLUSTRATED DO NOT FIT ALL APPLICATIONS.

SEE ALSO PAGE K021

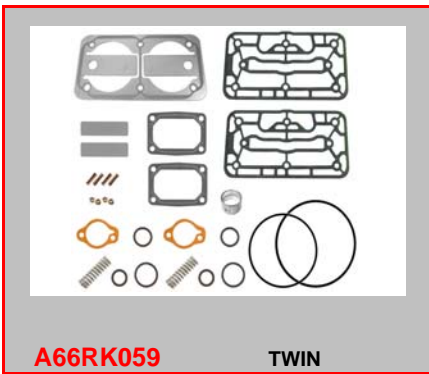

A66RK059 TWIN

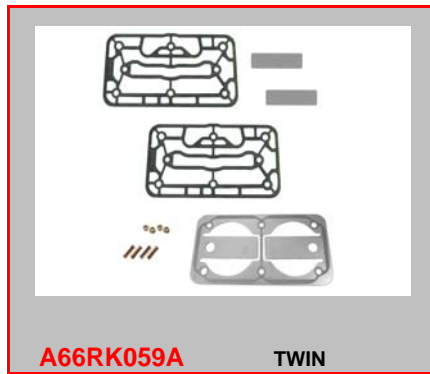

A66RK059A TWIN



**TYPE 922 TWIN
REMAN TYPICAL TYPE**

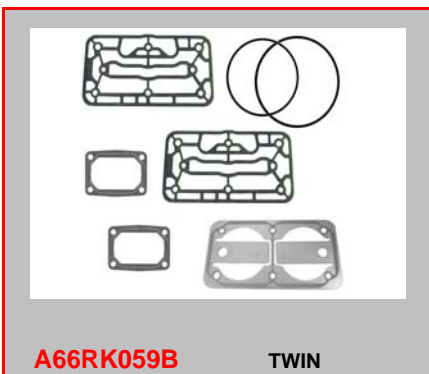

A66RK059B TWIN



A66RK059C TWIN



**1 OR 2 KITS AS REQUIRED
A66RK042D**

CHECK OUR WEB SITE FOR SUITABILITY OF THESE AND OTHER PARTS, OR CONTACT US.

ALL PARTS OFFERED ARE MAJORSELL BRAND AND MAY NOT BE OF AN ORIGINAL SUPPLY.

ORIGINAL PART NUMBERS ARE USED FOR REFERENCE ONLY. **CHECK ALL APPLICATIONS.**



Fax ++44 121 455 0272 sales@majorsell.co.uk www.majorsell.co.uk



BX011.1

B
E
N
D
I
X



020158 STD
020159 +.5mm
020160 +1.00mm

92mm PISTON WITH RINGS



A66RK060 STD
A66RK061 +.50
A66RK062 +1.00

2 x 2.5, 1 x 4.00 mm

92mm RING KIT 1 PISTON

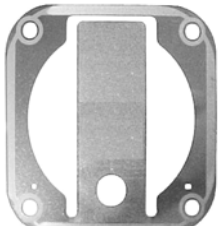
060281



060309



050186 922 COMPRESSOR



050203 921 COMPRESSOR



6308 921 COMPRESSOR



050206 921 COMPRESSOR



A66RK058 SINGLE



A66RK058A SINGLE

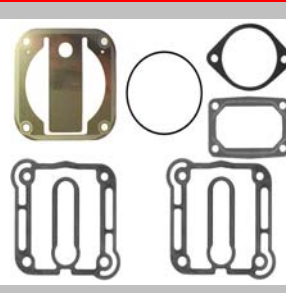

A66RK058B SINGLE

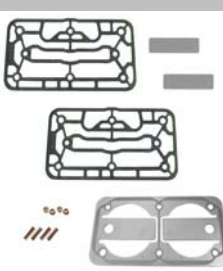

A66RK059A TWIN



921 SINGLE
TYPICAL TYPE

TYPICAL PARTS FOR 1W150R TYPES

BX013

**B
E
N
D
I
X**



A68RK104A

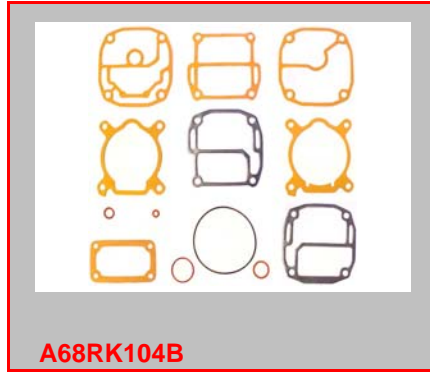

A68RK104B



68A009R

TYPICAL TYPE
REBUILD



A68RK104C

SEE OVER PAGE BX013-1
FOR VALVE PLATES

COMPRESSORS USING A68RK104A
REBUILD

KZ1115	
KZ1187	
KZ1211	
1186502	
1189100	
1189140	
1189439	68A009R
1189496	
1189497	68A018R
1189498	68A025R
1194212	68A026R



050211 REAR
SOME TYPES



050203 FRONT
SOME TYPES



75mm

020011	A68RK010	STD
020012	A68RK011	+0.25
020013	A68RK012	+0.50
020014	A68RK013	+0.75
020088		+1.00

2 x 3/32", 1 x 5/32"

PISTONS & RINGS



140141

CHECK OUR WEB SITE FOR SUITABILITY OF THESE AND OTHER PARTS, OR CONTACT US.
ALL PARTS OFFERED ARE MAJORSELL BRAND AND MAY NOT BE OF AN ORIGINAL SUPPLY.
ORIGINAL PART NUMBERS ARE USED FOR REFERENCE ONLY. **CHECK ALL APPLICATIONS.**



Fax ++44 121 455 0272 sales@majorsell.co.uk www.majorsell.co.uk



BX013.1

**B
E
N
D
I
X**



SUITABLE FOR:-

KZ1115	KZ1187	KZ1211
1186502	1189100	1189439
1184212	1189497	

A68RK104V



SUITABLE FOR:-

1189498

ESS TYPE

A68RK104V1



TYPICAL PARTS FOR 190cc TYPES

BX015

**B
E
N
D
I
X**

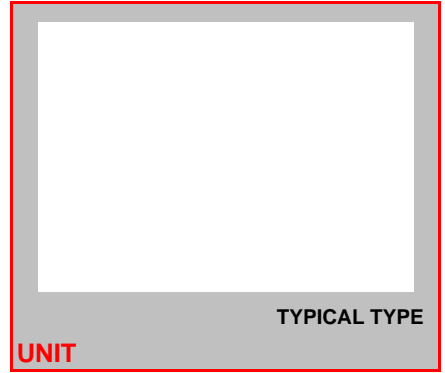
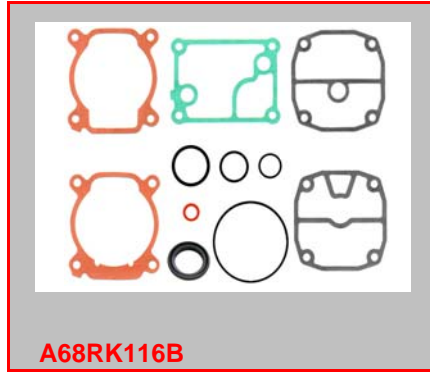
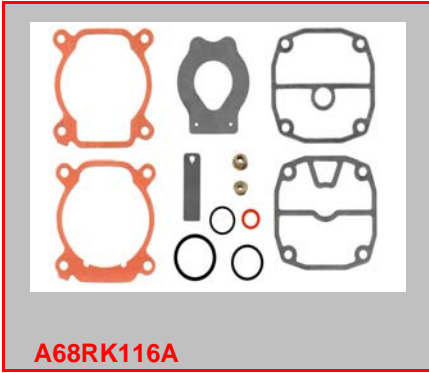

COMPRESSORS USING A68RK116A
REBUILD

1188748
1188889
1189085
1189209



020140	A68RK110	STD
020141	A68RK111	+0.50
020142	A68RK114	+1.00

2 x 2, 1 x 4mm

PISTONS & RINGS



CHECK OUR WEB SITE FOR SUITABILITY OF THESE AND OTHER PARTS, OR CONTACT US.

ALL PARTS OFFERED ARE MAJORSELL BRAND AND MAY NOT BE OF AN ORIGINAL SUPPLY.

ORIGINAL PART NUMBERS ARE USED FOR REFERENCE ONLY. **CHECK ALL APPLICATIONS.**



Fax ++44 121 455 0272 sales@majorsell.co.uk www.majorsell.co.uk



BX015.1

B
E
N
D
I
X





A68RK117



A68RK117A



68A023R
TYPICAL TYPE
REBUILD

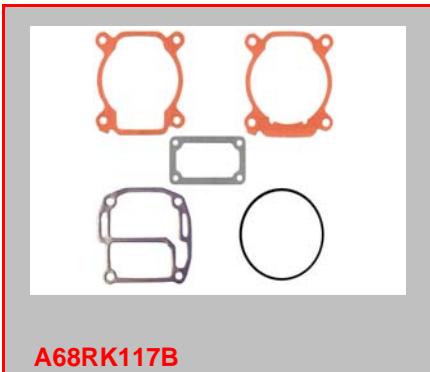

A68RK117B



A68RK105C

COMPRESSORS USING A68RK117
REBUILD

1189174 68A023R
1189495



6207
FRONT



050203



A68RK105V
AS REQUIRED



80mm

020140	A68RK110	STD
020141	A68RK111	+0.50
020142	A68RK114	+1.00

2 x 2, 1 x 4mm
PISTONS & RINGS



A68RK109V

CHECK OUR WEB SITE FOR SUITABILITY OF THESE AND OTHER PARTS, OR CONTACT US.

ALL PARTS OFFERED ARE MAJORSELL BRAND AND MAY NOT BE OF AN ORIGINAL SUPPLY.

ORIGINAL PART NUMBERS ARE USED FOR REFERENCE ONLY. **CHECK ALL APPLICATIONS.**



Fax ++44 121 455 0272 sales@majorsell.co.uk www.majorsell.co.uk



BX016.1

B
E
N
D
I
X



TYPICAL PARTS FOR 146 + 215 TYPES

BX019

B
E
N
D
I
X

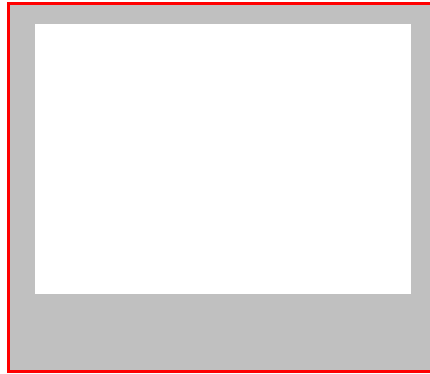
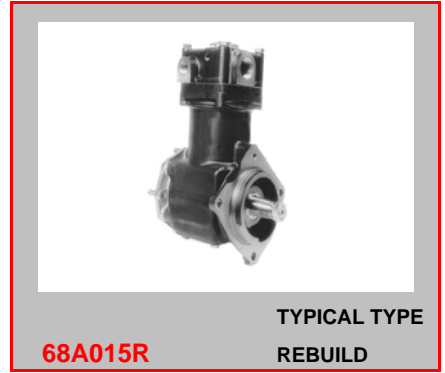

COMPRESSORS USING A68RK040A

TYPE		REBUILD
146	KZ800	68A027R
146	KZ801	
215	KZ802	
215	KZ803	68A015R
146	KZ929	
146	KZ930	
215	KZ931	
215	KZ932	
146	KZ958	
146	KZ959	
215	KZ960	
215	KZ961	



020084	A68RK087	STD
020085	A68RK088	+0.25
020086	A68RK089	+0.50
020087	A68RK090	+0.75

2 x 3/32", 2 x 3/16"
PISTONS & RINGS



020011	A68RK010	STD
020012	A68RK011	+0.25
020013	A68RK012	+0.50
020014	A68RK013	+0.75
020088		+1.00

2 x 3/32", 1 x 5/32"
PISTONS & RINGS



CHECK OUR WEB SITE FOR SUITABILITY OF THESE AND OTHER PARTS, OR CONTACT US.
ALL PARTS OFFERED ARE MAJORSELL BRAND AND MAY NOT BE OF AN ORIGINAL SUPPLY.
ORIGINAL PART NUMBERS ARE USED FOR REFERENCE ONLY. **CHECK ALL APPLICATIONS.**



Fax ++44 121 455 0272 sales@majorsell.co.uk www.majorsell.co.uk



BX019.1

**B
E
N
D
I
X**



SUITABLE FOR:-

A68RK105V



SUITABLE FOR:-

1186551
1194215

A68RK109V



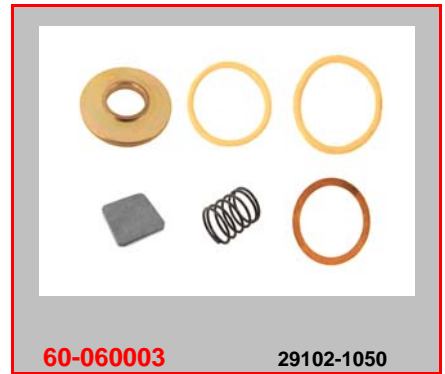

CHECK OUR WEB SITE FOR SUITABILITY OF THESE AND OTHER PARTS, OR CONTACT US.
ALL PARTS OFFERED ARE MAJORSELL BRAND AND MAY NOT BE OF AN ORIGINAL SUPPLY.
ORIGINAL PART NUMBERS ARE USED FOR REFERENCE ONLY. **CHECK ALL APPLICATIONS.**



Fax ++44 121 455 0272 sales@majorsell.co.uk www.majorsell.co.uk



J001.1

J
A
P
A
N
E
S
E



60-RM0980-30S 9851-99101

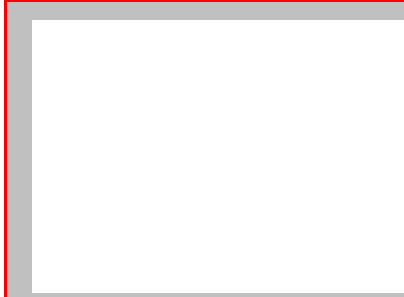

9851-95101



60-220014 29105-1030



29161-1090



29171-100

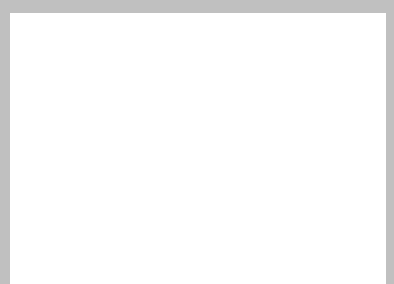
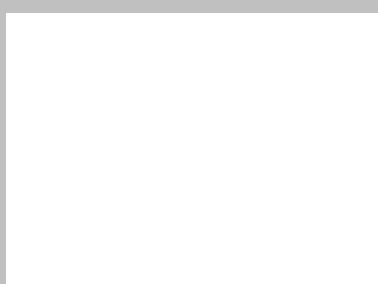
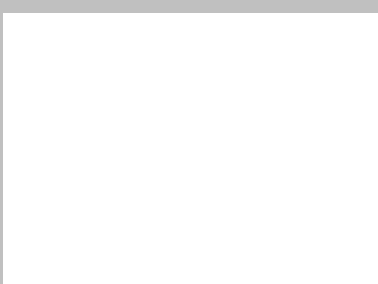
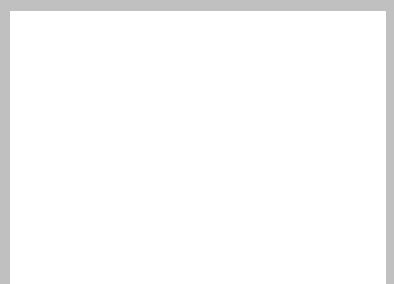
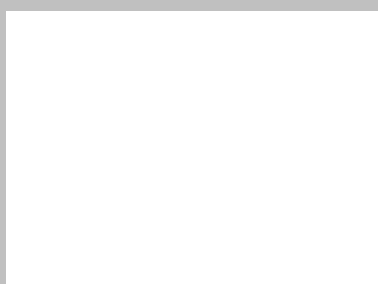
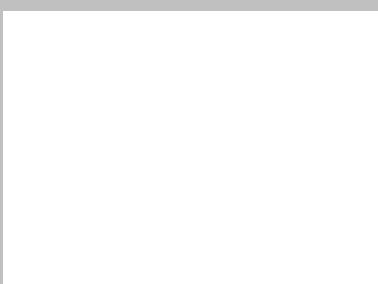
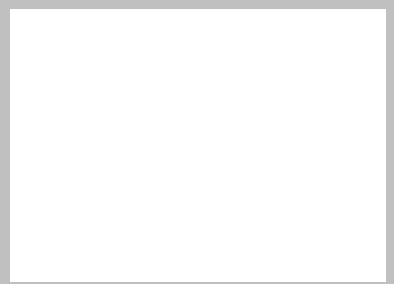
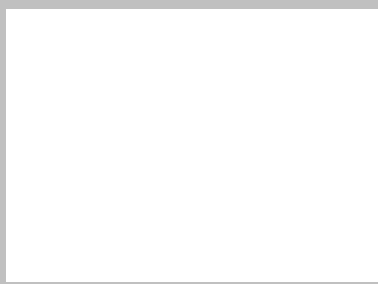
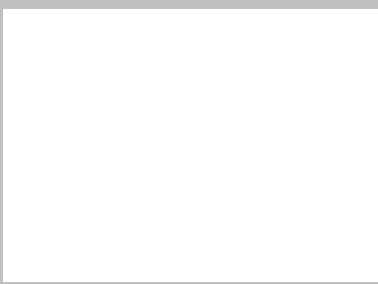

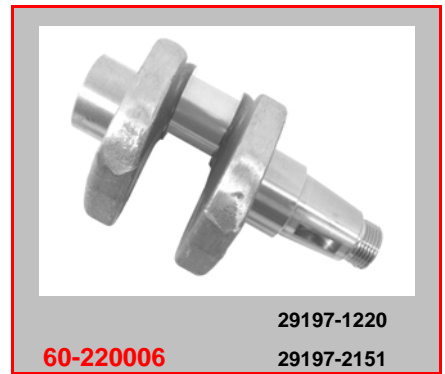
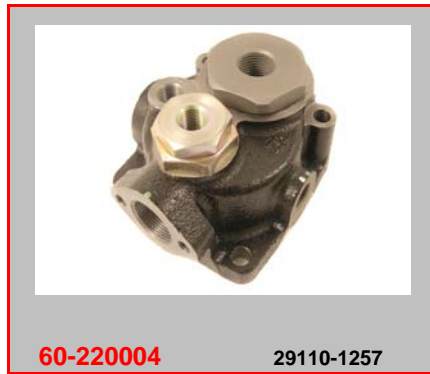

CHECK OUR WEB SITE FOR SUITABILITY OF THESE AND OTHER PARTS, OR CONTACT US.

ALL PARTS OFFERED ARE MAJORSSELL BRAND AND MAY NOT BE OF AN ORIGINAL SUPPLY.

ORIGINAL PART NUMBERS ARE USED FOR REFERENCE ONLY. **CHECK ALL APPLICATIONS.**



Fax ++44 121 455 0272 sales@majorsell.co.uk www.majorsell.co.uk



J002.1

J
A
P
A
N
E
S
E

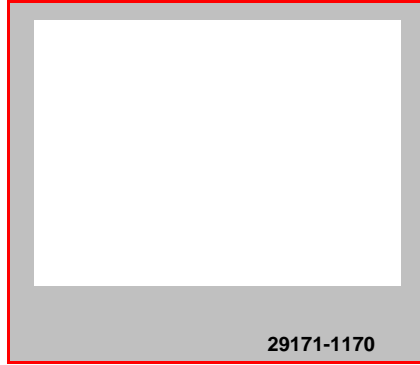
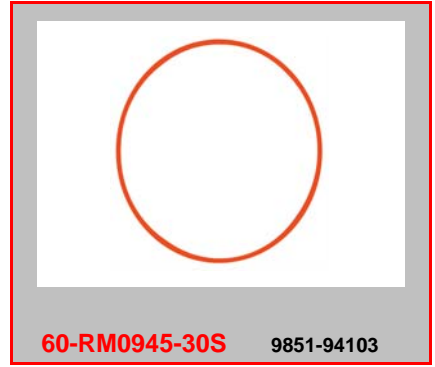
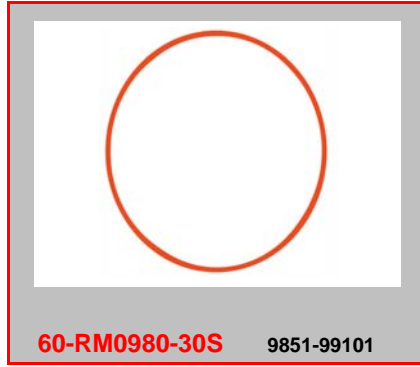

IN DEVELOPMENT

A60RK009



60-220008 29110-1536



60A003 29100-1803



60-060004 29101-1170



60-060009 29102-1270



60-060006 29102-1330



60-060010 29103-1140



1x5mm, 3x3mm 85mm STD

A60RK005 29106-1060



60-220006 29197-1220
29197-2151



60-020002L AIR COOLED
29109-1010



60-020003 85mm
29191-1110



60-220011 29105-1050

CHECK OUR WEB SITE FOR SUITABILITY OF THESE AND OTHER PARTS, OR CONTACT US.

ALL PARTS OFFERED ARE MAJORSELL BRAND AND MAY NOT BE OF AN ORIGINAL SUPPLY.

ORIGINAL PART NUMBERS ARE USED FOR REFERENCE ONLY. **CHECK ALL APPLICATIONS.**



Fax ++44 121 455 0272 sales@majorsell.co.uk www.majorsell.co.uk



J003.1

J
A
P
A
N
E
S
E

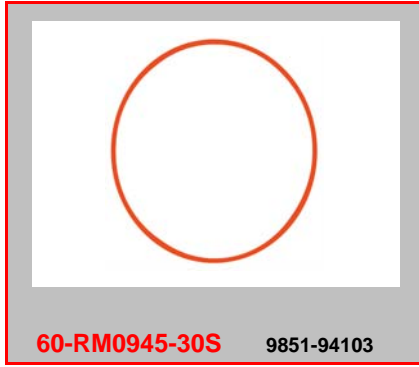
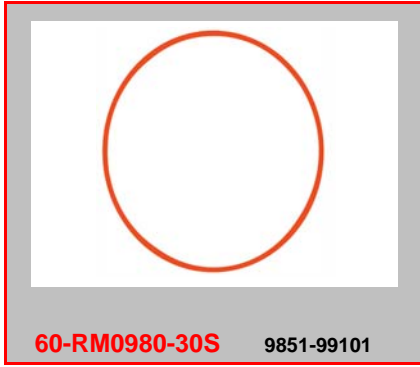



CHECK OUR WEB SITE FOR SUITABILITY OF THESE AND OTHER PARTS, OR CONTACT US.

ALL PARTS OFFERED ARE MAJORSELL BRAND AND MAY NOT BE OF AN ORIGINAL SUPPLY.

ORIGINAL PART NUMBERS ARE USED FOR REFERENCE ONLY. **CHECK ALL APPLICATIONS.**



Fax ++44 121 455 0272 sales@majorsell.co.uk www.majorsell.co.uk



J004.1

J
A
P
A
N
E
S
E

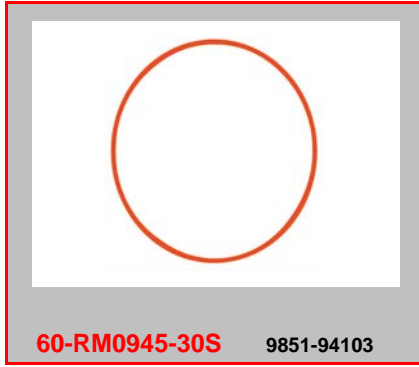
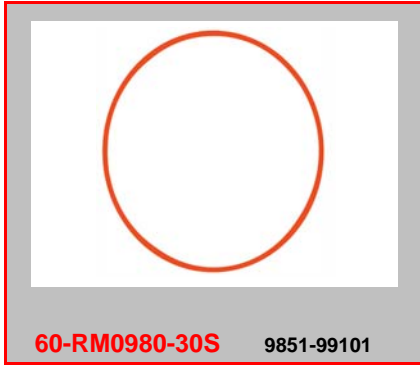

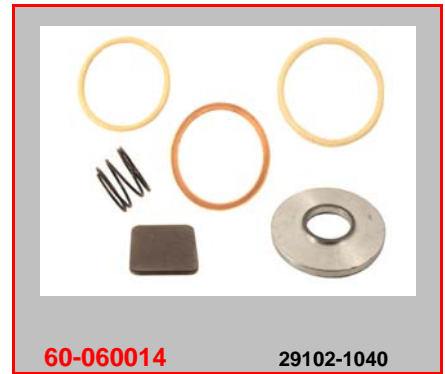
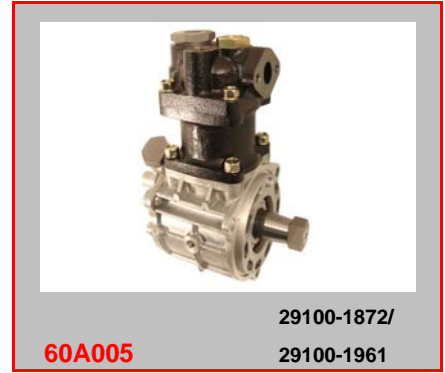

CHECK OUR WEB SITE FOR SUITABILITY OF THESE AND OTHER PARTS, OR CONTACT US.
 ALL PARTS OFFERED ARE MAJORSELL BRAND AND MAY NOT BE OF AN ORIGINAL SUPPLY.
 ORIGINAL PART NUMBERS ARE USED FOR REFERENCE ONLY. **CHECK ALL APPLICATIONS.**



Fax ++44 121 455 0272 sales@majorsell.co.uk www.majorsell.co.uk



J005.1

J
A
P
A
N
E
S
E



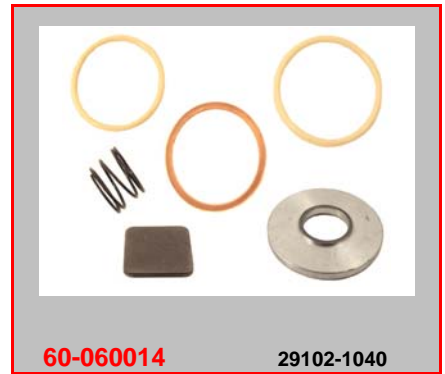
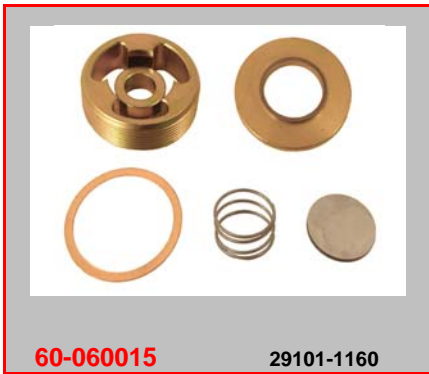
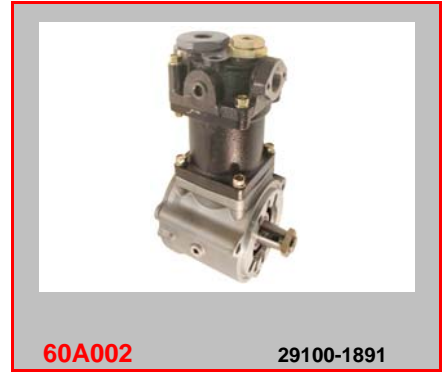
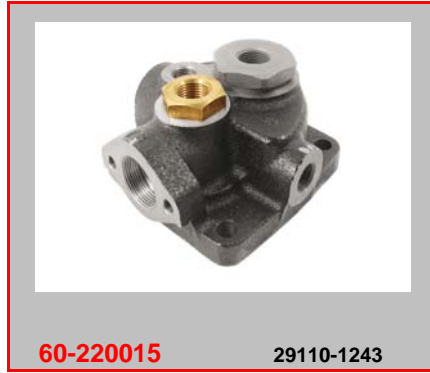
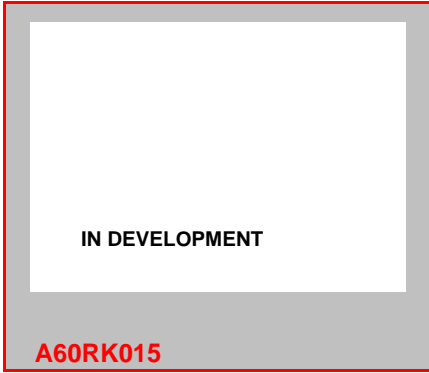

CHECK OUR WEB SITE FOR SUITABILITY OF THESE AND OTHER PARTS, OR CONTACT US.
ALL PARTS OFFERED ARE MAJORSELL BRAND AND MAY NOT BE OF AN ORIGINAL SUPPLY.
ORIGINAL PART NUMBERS ARE USED FOR REFERENCE ONLY. **CHECK ALL APPLICATIONS.**



Fax ++44 121 455 0272 sales@majorsell.co.uk www.majorsell.co.uk



J006.1

J
A
P
A
N
E
S
E

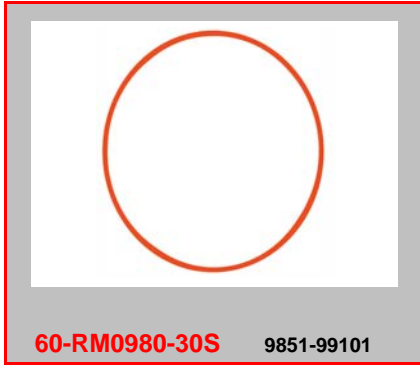

IN DEVELOPMENT

A60RK016



60-220017 29110-1380



60A006 29100-2123



60-060015 29101-1160



66mm HIGH
60-060017 29107-1240S



60-060014 29102-1040



60-060016 29103-1020



1x4mm, 3x3mm 80mm STD
A60RK002 29106-1100



60-220003 29197-1130



60-020001L 29165-1150
29165-1050



60-020001 29191-1020



60-220014 29105-1030

CHECK OUR WEB SITE FOR SUITABILITY OF THESE AND OTHER PARTS, OR CONTACT US.

ALL PARTS OFFERED ARE MAJORSELL BRAND AND MAY NOT BE OF AN ORIGINAL SUPPLY.

ORIGINAL PART NUMBERS ARE USED FOR REFERENCE ONLY. **CHECK ALL APPLICATIONS.**



Fax ++44 121 455 0272 sales@majorsell.co.uk www.majorsell.co.uk



J007.1

J
A
P
A
N
E
S
E

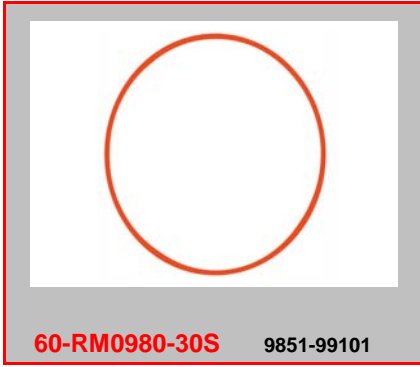

IN DEVELOPMENT

A60RK017



60-220018 29110-1674



60A007 29100-2364



2 USED

60-060018 29101-1380



2 USED

60-060019 29107-1250



2 USED

60-060020 29102-1361



2 USED

60-060021 29103-1190



1x4mm, 3x3mm 80mm STD

2 USED

A60RK002 29106-1130



60-220020 29197-1500

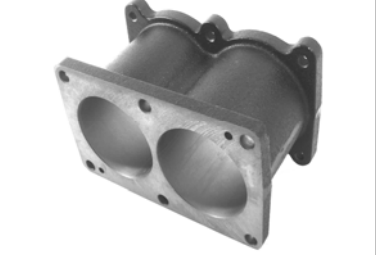

60-020006L 29165-1230



2 USED 80mm

60-020001 29191-1020



60-220019 29105-1090

CHECK OUR WEB SITE FOR SUITABILITY OF THESE AND OTHER PARTS, OR CONTACT US.

ALL PARTS OFFERED ARE MAJORSELL BRAND AND MAY NOT BE OF AN ORIGINAL SUPPLY.

ORIGINAL PART NUMBERS ARE USED FOR REFERENCE ONLY. **CHECK ALL APPLICATIONS.**



Fax ++44 121 455 0272 sales@majorsell.co.uk www.majorsell.co.uk



J008.1

J
A
P
A
N
E
S
E

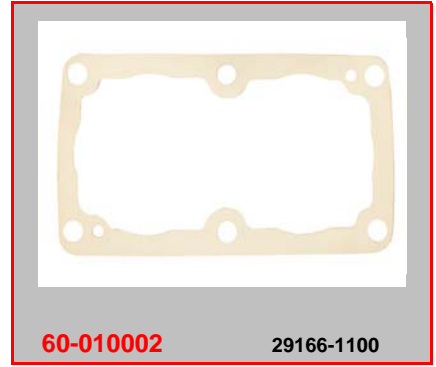
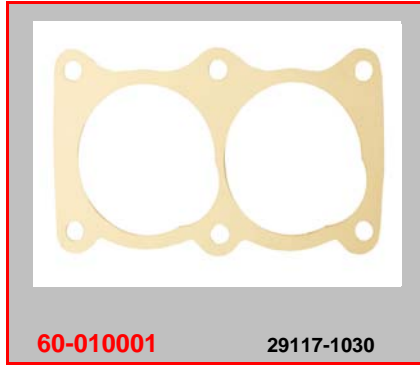
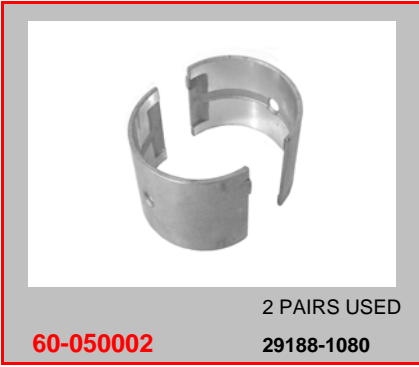

IN DEVELOPMENT

A60RK018



60-220023 1-191100-019-0



60A008 1-19100-220-0



60-060022 6BG1-IN-KIT

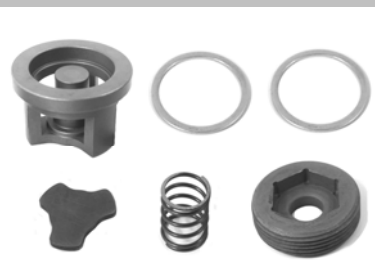

60-060023 6BG1-EX-KIT

IN DEVELOPMENT

60-010003 1-19115-006-0

IN DEVELOPMENT

1-19158-020-0



A60RK033 1-19163-027-0



60-220022 1-19171-030-1



60-020007L 1-19151-222-0



60-020008 1-19161-008-0



60-220021 1-19173-011-0

CHECK OUR WEB SITE OR FOR SUITABILITY OF THESE AND OTHER PARTS, OR CONTACT US.

ALL PARTS OFFERED ARE MAJORSELL BRAND AND MAY NOT BE OF AN ORIGINAL SUPPLY.

ORIGINAL PART NUMBERS ARE USED FOR REFERENCE ONLY. **CHECK ALL APPLICATIONS.**



Fax ++44 121 455 0272 sales@majorsell.co.uk www.majorsell.co.uk



J009.1

J
A
P
A
N
E
S
E

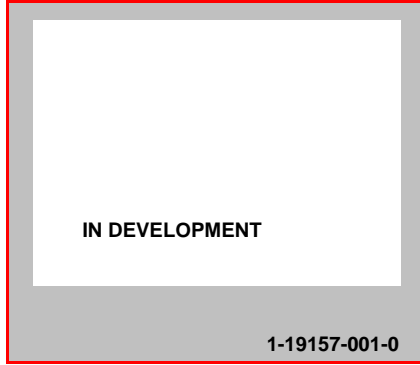



CHECK OUR WEB SITE FOR SUITABILITY OF THESE AND OTHER PARTS, OR CONTACT US.

ALL PARTS OFFERED ARE MAJORSELL BRAND AND MAY NOT BE OF AN ORIGINAL SUPPLY.

ORIGINAL PART NUMBERS ARE USED FOR REFERENCE ONLY. **CHECK ALL APPLICATIONS.**



Fax ++44 121 455 0272 sales@majorsell.co.uk www.majorsell.co.uk



J010.1

J
A
P
A
N
E
S
E

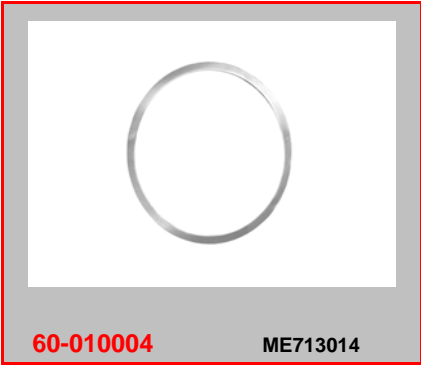

IN DEVELOPMENT

A60RK023



2 USED
ME713199

60-220024



60A010

ME067899



2 USED
ME713033

60-060024



2 USED
ME713032

60-060025



2 USED
ME713032-KIT

60-060026



2 USED
ME713027

60-060027



80mm STD
2 USED
ME713125

A60RK024



60-220029

ME713268



2 USED
ME713111

60-020011L



80mm STD
2 USED
ME713110

60-020012



2 USED
ME713108

60-220028

CHECK OUR WEB SITE FOR SUITABILITY OF THESE AND OTHER PARTS, OR CONTACT US.

ALL PARTS OFFERED ARE MAJORSELL BRAND AND MAY NOT BE OF AN ORIGINAL SUPPLY.

ORIGINAL PART NUMBERS ARE USED FOR REFERENCE ONLY. **CHECK ALL APPLICATIONS.**



Fax ++44 121 455 0272 sales@majorsell.co.uk www.majorsell.co.uk



J011.1

J
A
P
A
N
E
S
E

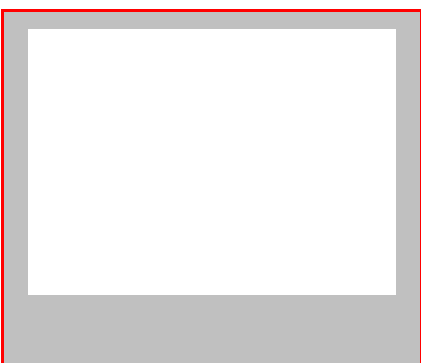
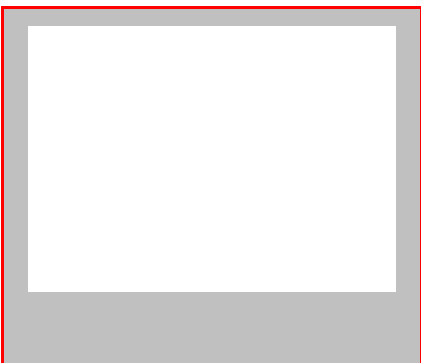
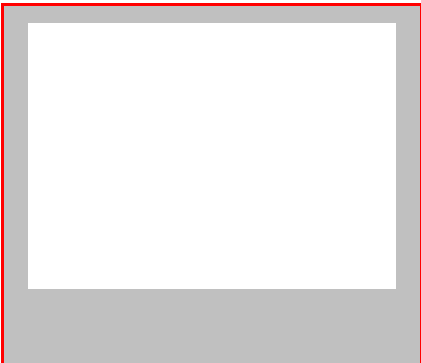
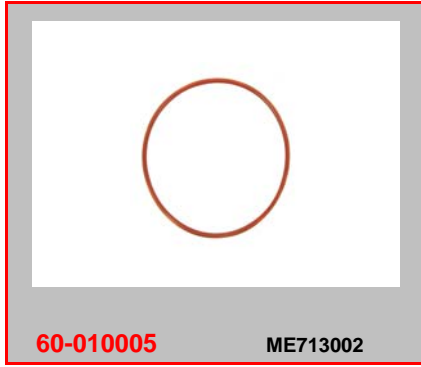
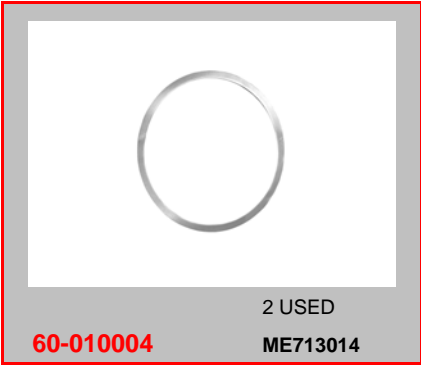

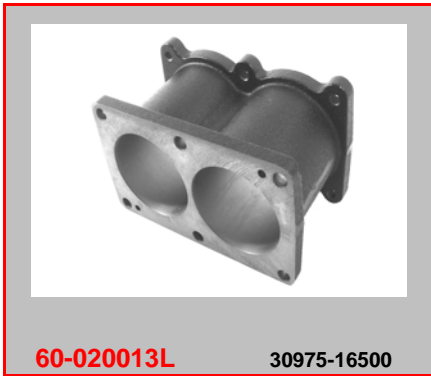
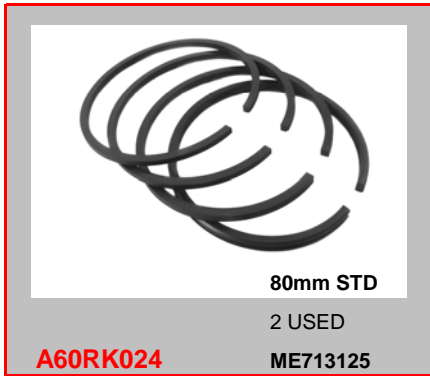

CHECK OUR WEB SITE FOR SUITABILITY OF THESE AND OTHER PARTS, OR CONTACT US.

ALL PARTS OFFERED ARE MAJORSELL BRAND AND MAY NOT BE OF AN ORIGINAL SUPPLY.

ORIGINAL PART NUMBERS ARE USED FOR REFERENCE ONLY. **CHECK ALL APPLICATIONS.**



Fax ++44 121 455 0272 sales@majorsell.co.uk www.majorsell.co.uk



J012.1

J
A
P
A
N
E
S
E

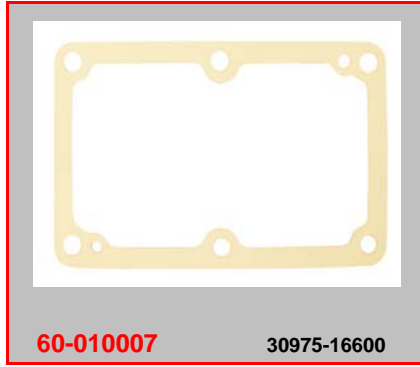
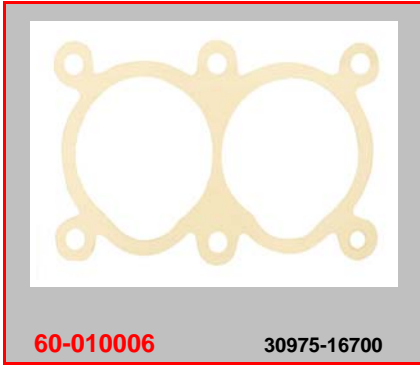

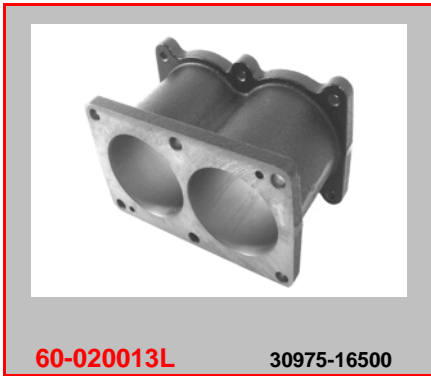
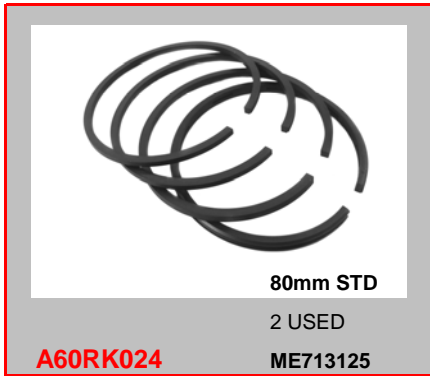

CHECK OUR WEB SITE FOR SUITABILITY OF THESE AND OTHER PARTS, OR CONTACT US.

ALL PARTS OFFERED ARE MAJORSELL BRAND AND MAY NOT BE OF AN ORIGINAL SUPPLY.

ORIGINAL PART NUMBERS ARE USED FOR REFERENCE ONLY. **CHECK ALL APPLICATIONS.**



Fax ++44 121 455 0272 sales@majorsell.co.uk www.majorsell.co.uk



J013.1

J
A
P
A
N
E
S
E

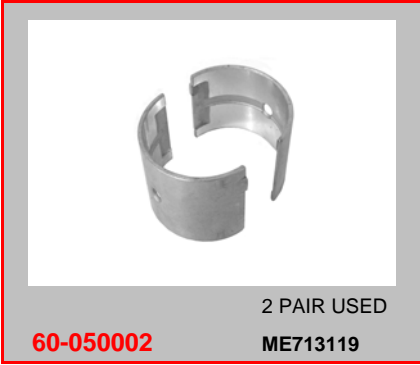
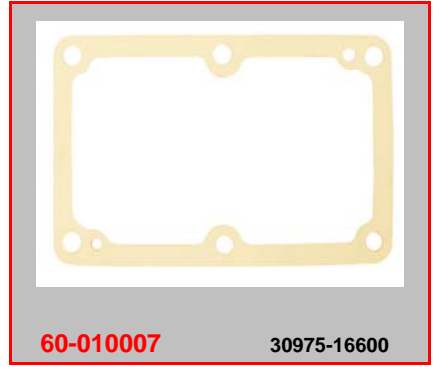
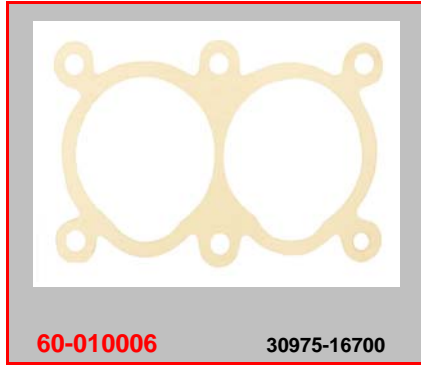

8DC20, 40, 80, 90
1977



60-220039

31275-72010

60-060040

ME067030



60-060041

ME048010

60-060042

ME260003

6D20, 22 1980



60-220040

ME713206

60-060024

ME713033



60-060025

ME713032

60-060026

ME713032-KIT

60-060027

ME713027

CHECK OUR WEB SITE FOR SUITABILITY OF THESE AND OTHER PARTS, OR CONTACT US.
ALL PARTS OFFERED ARE MAJORSELL BRAND AND MAY NOT BE OF AN ORIGINAL SUPPLY.
ORIGINAL PART NUMBERS ARE USED FOR REFERENCE ONLY. **CHECK ALL APPLICATIONS.**



Fax ++44 121 455 0272 sales@majorsell.co.uk www.majorsell.co.uk



J014.1

J
A
P
A
N
E
S
E

ISUZU 10PC1 1984



60-220037

1-19110-018-1



60-060036



60-060037

**ISUZU 6RB1 6QA1
1997**



60-220038

1-19110-016-1



60-060038



60-060039

IN DEVELOPMENT

A60RK032



60-220034 14540-99208



60A013 14501-97101



60-060032 14570-99129



90mm L
60-060033 14569-99327



60-060034 14569-KIT

IN DEVELOPMENT

60-060035 14550-99010S

IN DEVELOPMENT

90mm STD
A60RK029 14529-99011



60-220036 14509-99111



60-020014L 14535-99019



90mm STD
60-020015 14528-99015



60-220035 14516-99013

CHECK OUR WEB SITE FOR SUITABILITY OF THESE AND OTHER PARTS, OR CONTACT US.

ALL PARTS OFFERED ARE MAJORSELL BRAND AND MAY NOT BE OF AN ORIGINAL SUPPLY.

ORIGINAL PART NUMBERS ARE USED FOR REFERENCE ONLY. **CHECK ALL APPLICATIONS.**



Fax ++44 121 455 0272 sales@majorsell.co.uk www.majorsell.co.uk



J015.1

J
A
P
A
N
E
S
E

NISSAN CW520 RF8
1990
continued



60-RM1095-30S 14514-99105

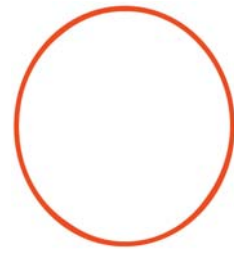

60-RM1040-30S 14514-99101



60-050005 14516-99013A

IN DEVELOPMENT

14516-99019

IN DEVELOPMENT

14513-99117

IZUZU 6D20, 22
1980



60-220040

ISUZU 10PC1 1984



**ISUZU 6RB1 6QA1
1997**



CHECK OUR WEB SITE FOR SUITABILITY OF THESE AND OTHER PARTS, OR CONTACT US.

ALL PARTS OFFERED ARE MAJORSELL BRAND AND MAY NOT BE OF AN ORIGINAL SUPPLY.

ORIGINAL PART NUMBERS ARE USED FOR REFERENCE ONLY. **CHECK ALL APPLICATIONS.**



Fax ++44 121 455 0272 sales@majorsell.co.uk www.majorsell.co.uk



J016.1

J
A
P
A
N
E
S
E



Majorsell parts for :-

LK1300

Principal users :-

Iveco - Daf

01261731 01261729
01173872 01173867

0537989

MAJORSELL

66A044R
66A044R



66A044R

- 75 mm bore.
- Non-through drive.
- Air cooled.
- Weight 7 Kg
- Base mount.
- Engine oil lubrication.
- Air ports M26 x 1.5.



A66RK008C



A66RK008



A66RK008V



A66RK008A

Original 4-ring piston no longer available.
Piston rings are available for old 4-ring piston :

A66RK012



020114 Std (supplied with rings)
Piston rings are available separately for this piston :
A66RK027

75 mm
2 x 2, 1 x 4 mm

Piston & Rings

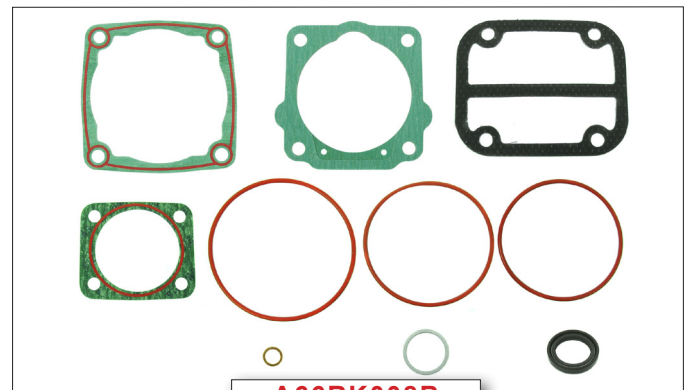

A66RK008B

Check our web site for suitability of these and other parts, or contact us directly.
Original part numbers are used for reference only. Check all applications.
All parts offered are Majorsell brand and may not be of an original supply.
Majorsell kit content and ring sets may be different to the original.



LK1300



220111



Bushes



140015



220014



Blank ports as required

220086

140130
4 used

140138
4 used

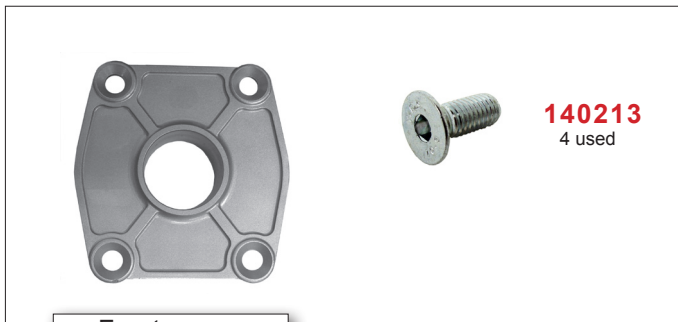
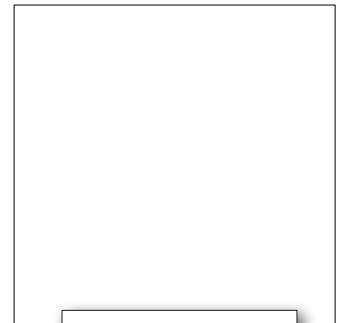
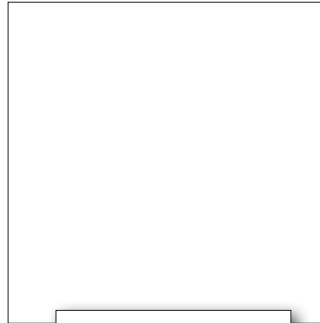

Front cover

140213
4 used



220139

140124
4 used

140103
4 used

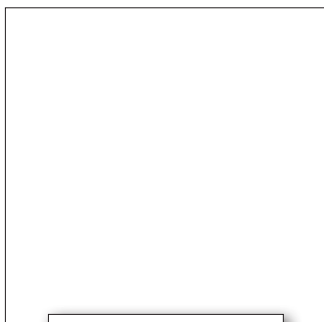

Majorsell

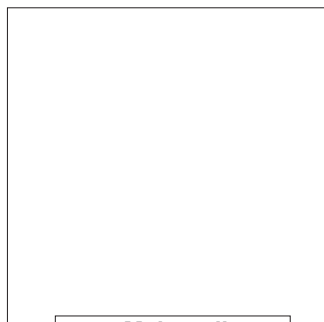

Majorsell

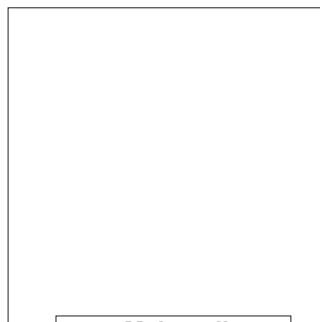

Majorsell

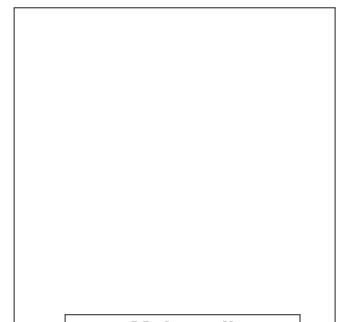

Majorsell



020165

140155
4 used

140103
4 used



020165K1

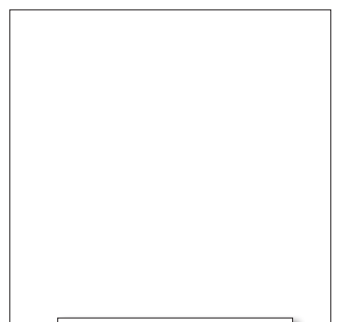

Majorsell

Majorsell Ltd
ENGLAND
sales@majorsell.co.uk
www.majorsell.co.uk

Notes :-

Majorsell parts for :-

LK1303

Principal users :-

Iveco

01173870

**MAJORSELL
REBUILD**

66A046R



- 75 mm bore.
- Non-through drive.
- Air cooled.
- Weight 7 Kg
- Base mount.
- Engine oil lubrication.
- Air ports M26 x 1.5.

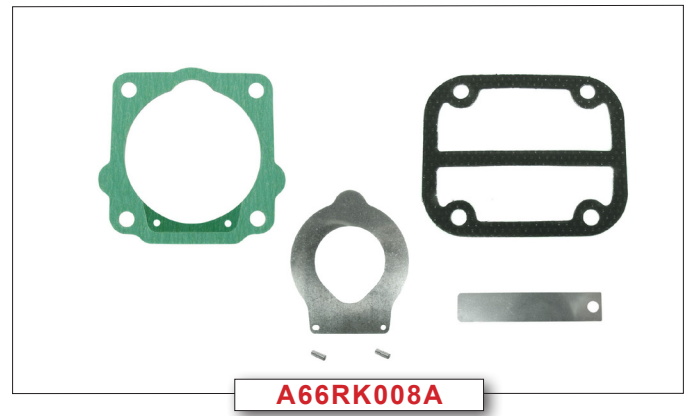
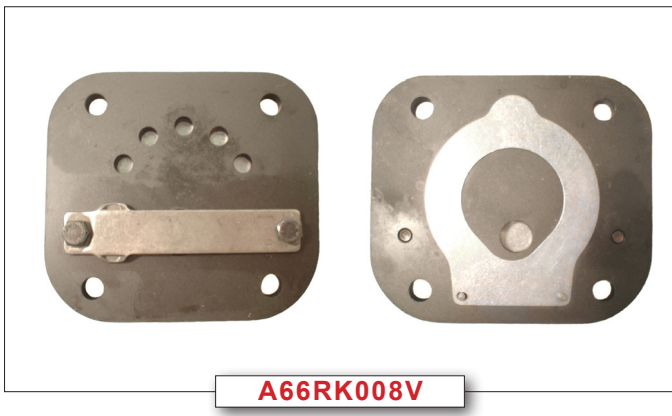
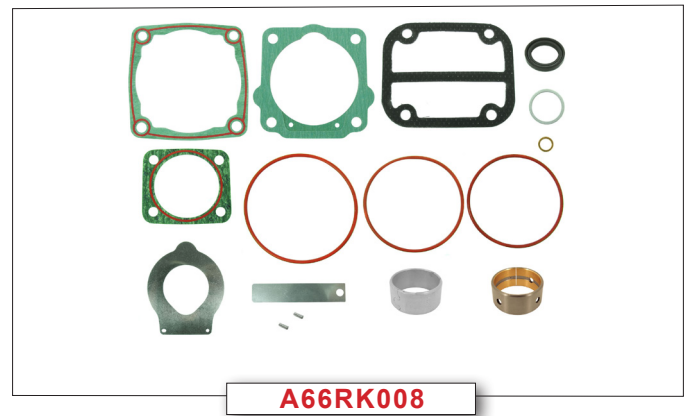
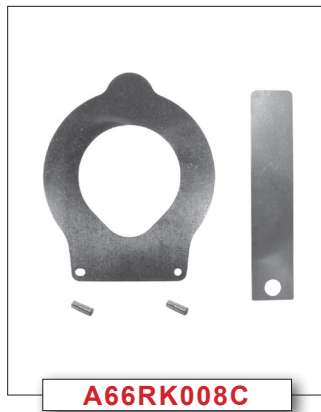

Original 4-ring piston no longer available.
Piston rings are available for old 4-ring piston :

A66RK012



020114 Std (supplied with rings)
Piston rings are available
separately for this piston :
A66RK027

75 mm
2 x 2, 1 x 4 mm

Piston & Rings

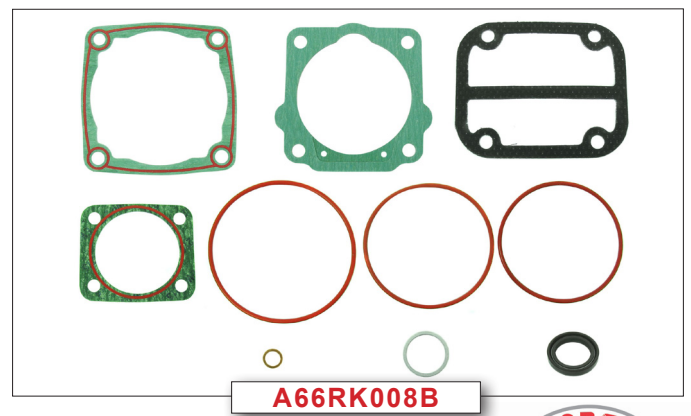

Check our web site for suitability of these and other parts, or contact us directly.
Original part numbers are used for reference only. Check all applications.
All parts offered are Majorsell brand and may not be of an original supply.
Majorsell kit content and ring sets may be different to the original.



LK1303



220111



Bushes



140015



220014



220086

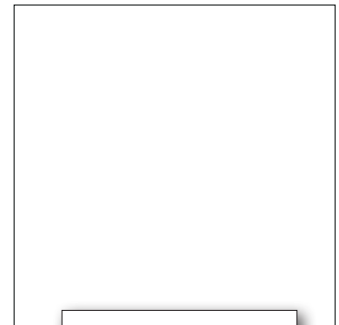
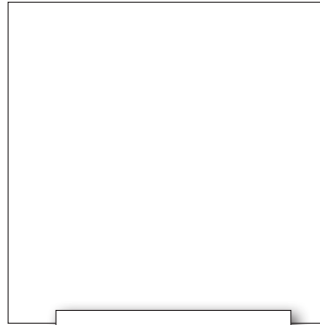

220123



220139

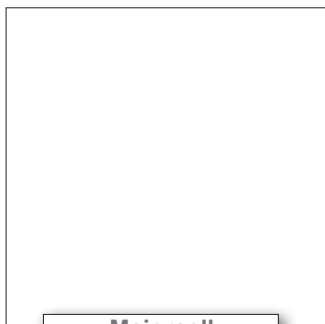

Majorsell

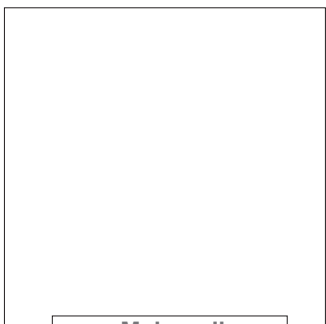

Majorsell

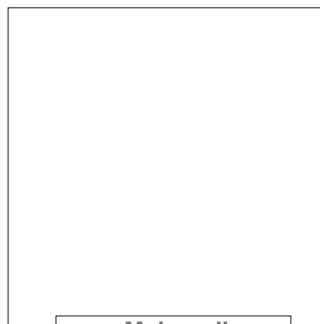

Majorsell

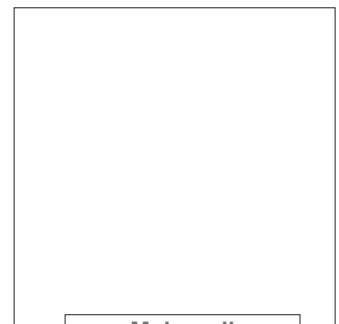

Majorsell



020165



020165K1

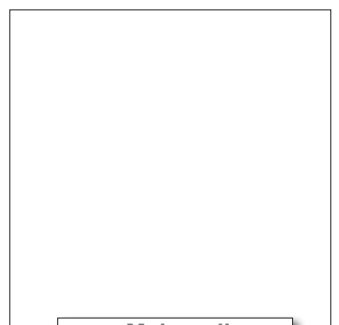

Majorsell

Majorsell Ltd
ENGLAND
sales@majorsell.co.uk
www.majorsell.co.uk

Notes :-

Majorsell parts for :-

LK1309 - LK1310 - LK1311 - LK1314

Principal users :-

Iveco

**MAJORSELL
REBUILD**

LK1309	01173868	Base mount
LK1310		Flange mount
LK1311	01173873	Base mount
LK1314	01261822	Base mount

66A035R



66A035R

- 75 mm bore.
- Non-through drive.
- Air cooled.
- Weight 8 Kg
- Mount as above.
- Engine oil lubrication.
- Air ports M26 x 1.5.

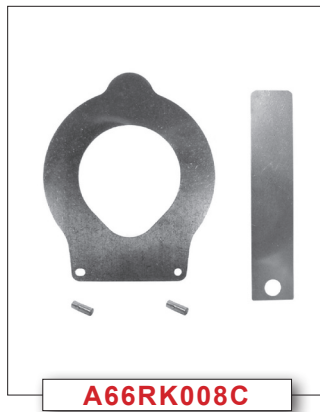

A66RK008C

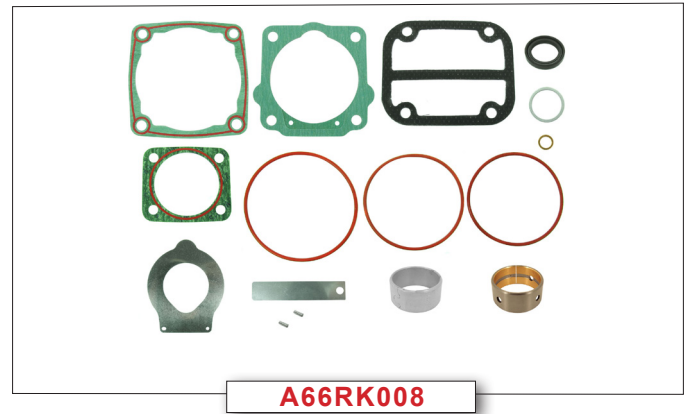

A66RK008

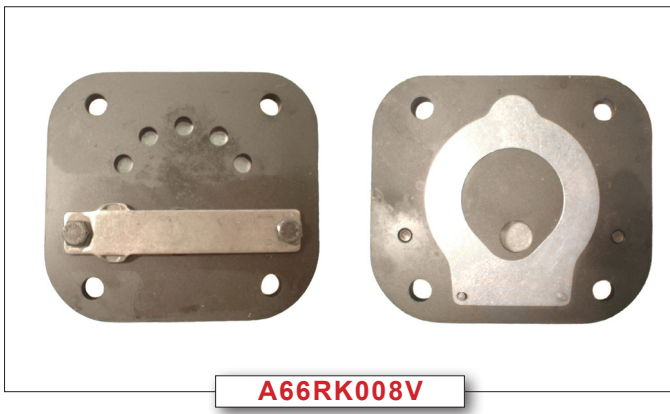

A66RK008V

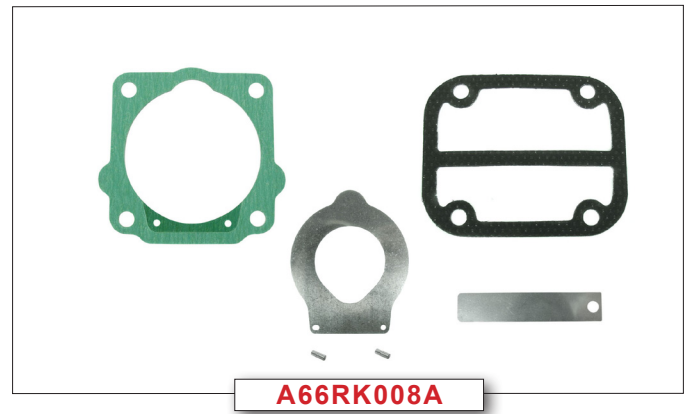

A66RK008A

Original 4-ring piston no longer available.
Piston rings are available for old 4-ring piston :

A66RK012



020114 Std (supplied with rings)

Piston rings are available separately for this piston :

A66RK027

75 mm
2 x 2, 1 x 4 mm

Piston & Rings

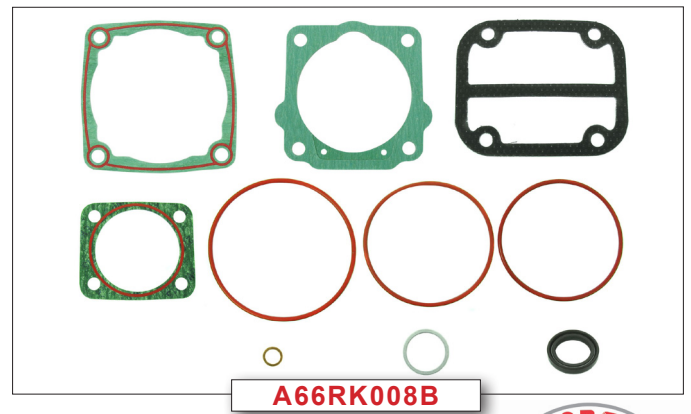

A66RK008B

Check our web site for suitability of these and other parts, or contact us directly.
Original part numbers are used for reference only. Check all applications.
All parts offered are Majorsell brand and may not be of an original supply.
Majorsell kit content and ring sets may be different to the original.



LK1309 - LK1310 - LK1311 - LK1314



220111



Bushes



140015



220014



Blank ports as required

220086

140130
4 used

140138
4 used

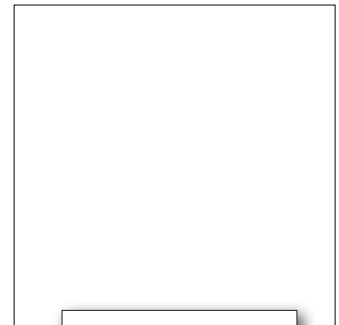
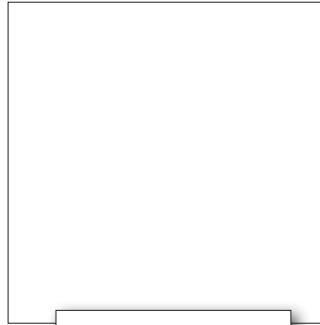

220139

140124
4 used

140103
4 used



220123

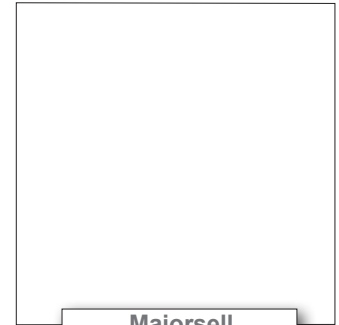

Majorsell

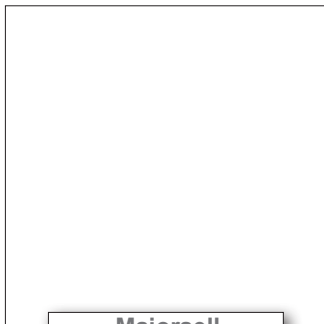

Majorsell



Majorsell



Majorsell

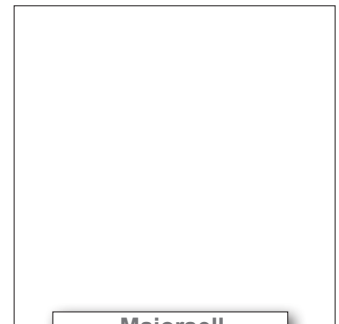

Majorsell



020165

140155
4 used

140103
4 used



020165K1

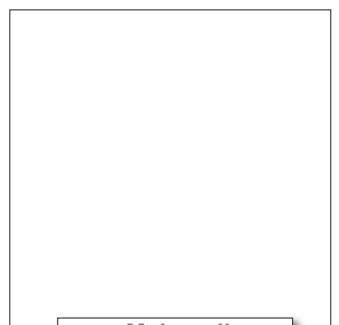

Majorsell

Majorsell Ltd
ENGLAND
sales@majorsell.co.uk
www.majorsell.co.uk

Notes :-

Majorsell parts for :-

LK1314

Principal users :-

Iveco

1173868, 1261822

**MAJORSELL
REBUILD**

66A035R



66A035

- 75 mm bore.
- Non-through drive.
- Air cooled.
- Weight 8 Kg
- Base mount.
- Engine oil lubrication.
- Air ports M26 x 1.5.

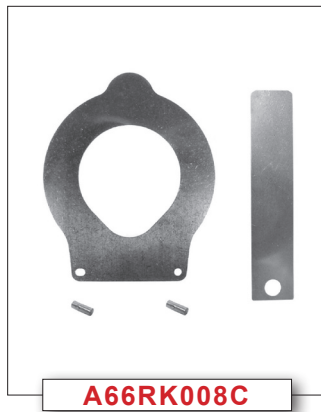

A66RK008C

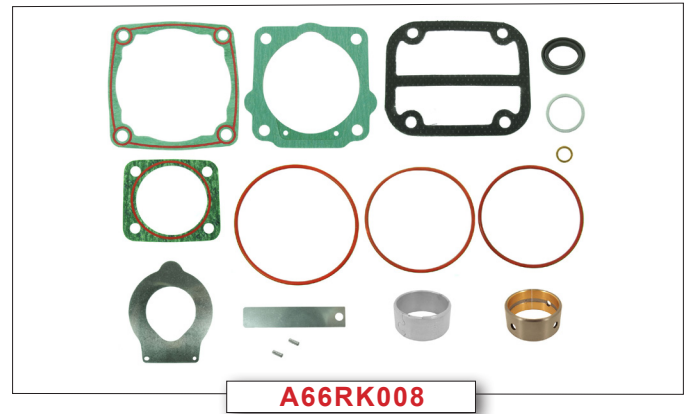

A66RK008



A66RK008V

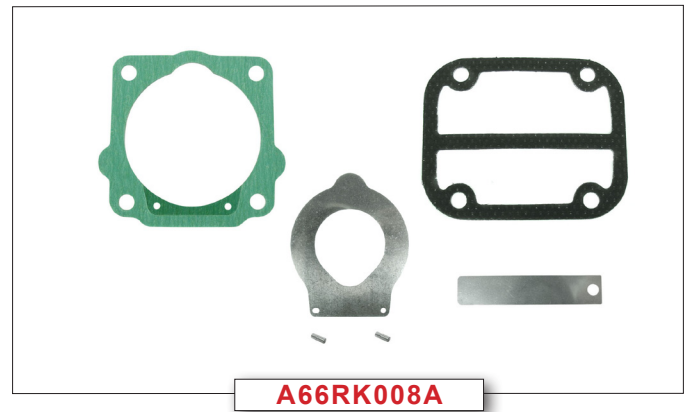

A66RK008A

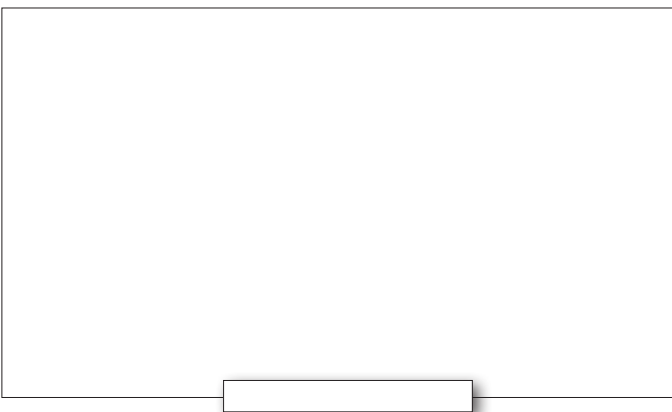

A66RK008B

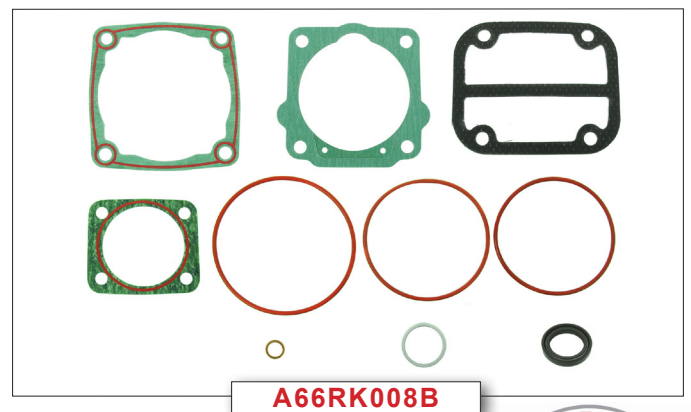

Check our web site for suitability of these and other parts, or contact us directly.
Original part numbers are used for reference only. Check all applications.
All parts offered are Majorsell brand and may not be of an original supply.
Majorsell kit content and ring sets may be different to the original.



LK1314



220111



Bushes



140015



220014



Blank ports as required

220086

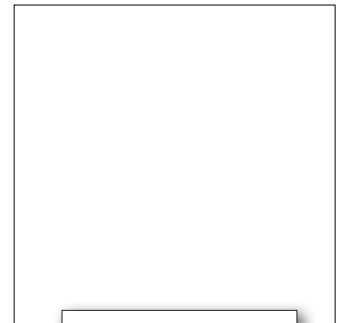
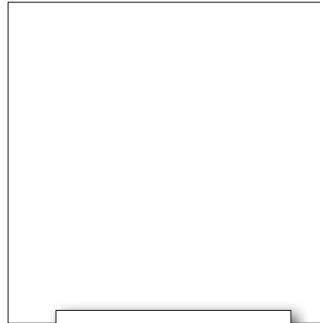

220123

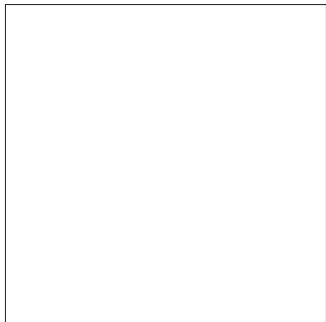

220139

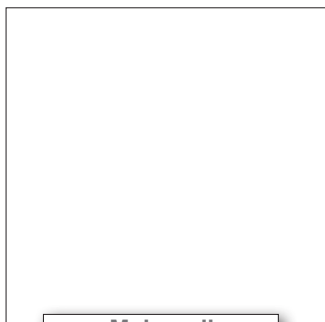

Majorsell

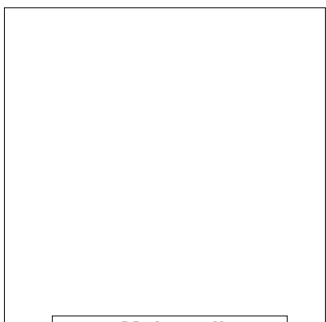

Majorsell

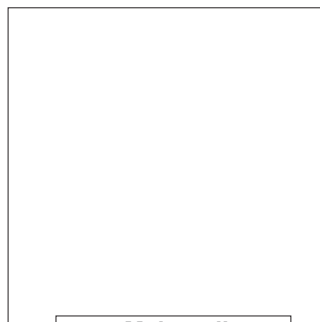

Majorsell

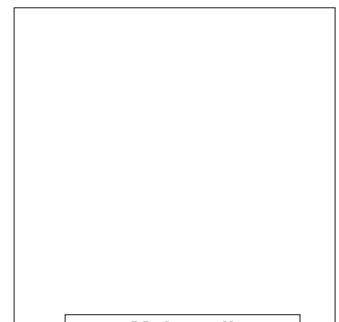

Majorsell



020165



020165K

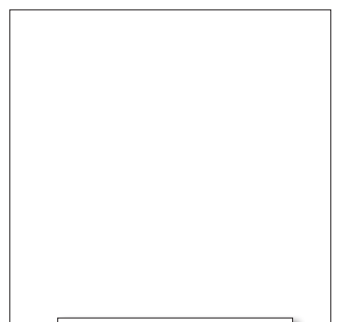

Majorsell

Majorsell Ltd
 ENGLAND
sales@majorsell.co.uk
www.majorsell.co.uk

Notes :-

Majorsell parts for :-

LK1500 - LK1503 - LK1504 - LK1505

Principal users :-

MAJORSELL

Iveco	01173863, 08009674, 01173877	LK1500
Iveco	01173876, 42017954, 42522660	LK1503
Iveco	01173875	LK1504
MAN	51541017141, 51541017124	LK1505

66A047R
66A137R



66A137R

- 75 mm bore.
- Non-through drive.
- Air cooled.
- Weight 7 Kg
- Base mount.
- Engine oil lubrication.
- Inlet & delivery ports M20 x 1.5.

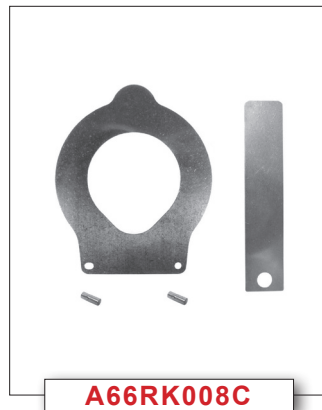

A66RK008C

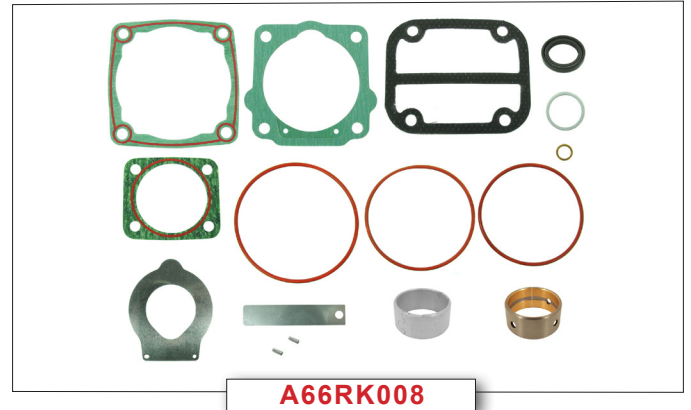

A66RK008

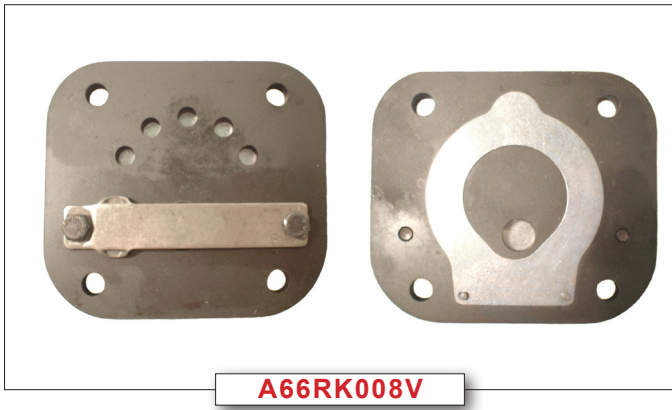

A66RK008V

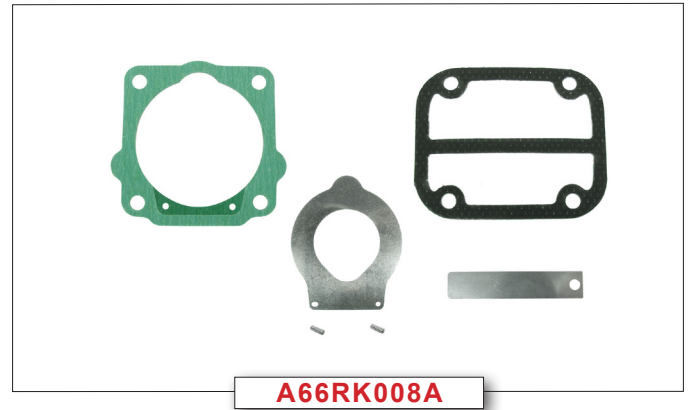

A66RK008A

020124	Std	A66RK027
020125	+0.50 mm	A66RK028
020126	+1.00 mm	A66RK029

75 mm

2 x 2 mm
1 x 4 mm

Piston & Rings

Ring set

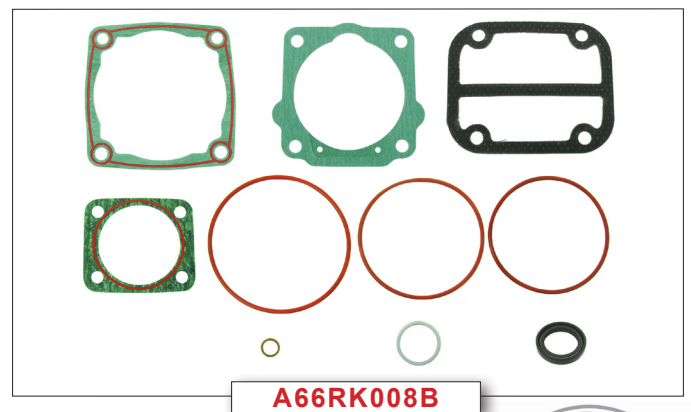

A66RK008B

Check our web site for suitability of these and other parts, or contact us directly. Original part numbers are used for reference only. Check all applications. All parts offered are Majorsell brand and may not be of an original supply. Majorsell kit content and ring sets may be different to the original.



LK1500 - LK1503 - LK1504 - LK1505



220111



050181

Front

050182

Rear

Bushes



140015



220014



Blank ports as required

220086

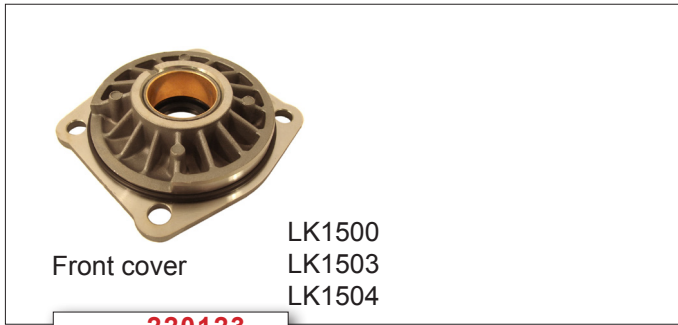
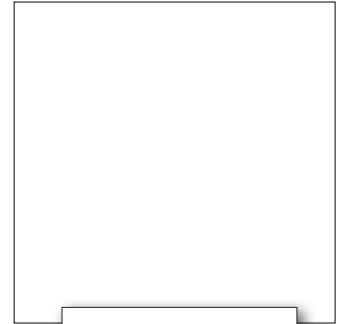
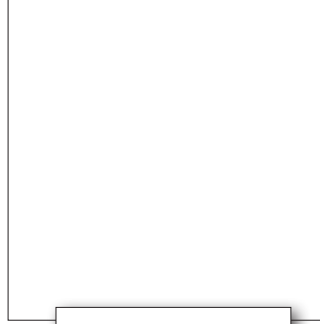
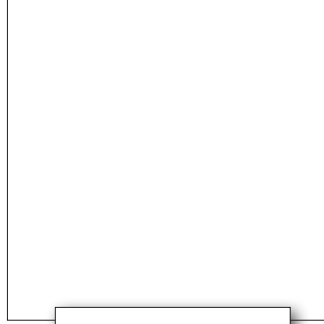

Front cover

LK1500
LK1503
LK1504

220123

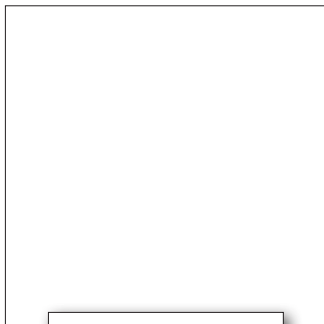
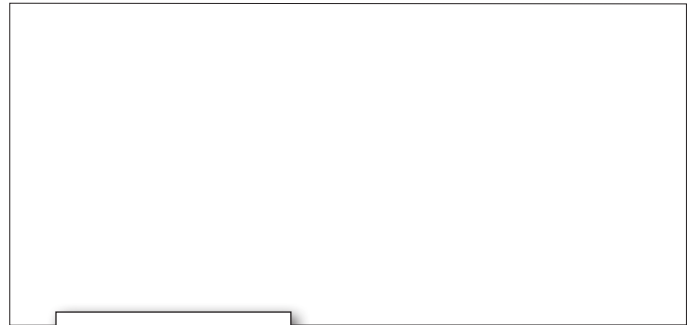

020165

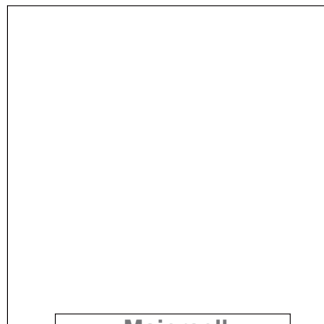

Majorsell

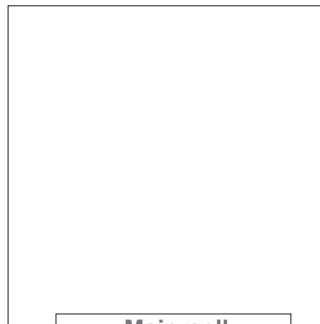

Majorsell



Majorsell



020165



020165K

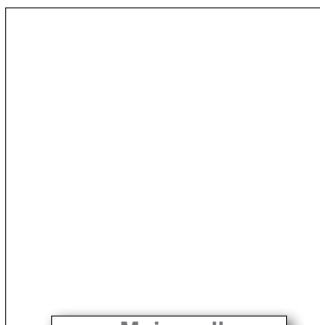

Majorsell

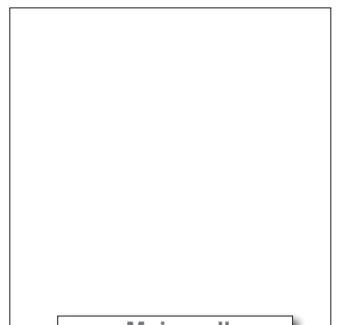

Majorsell

Majorsell Ltd
ENGLAND
sales@majorsell.co.uk
www.majorsell.co.uk

Notes :-

Majorsell parts for :-

LK1506 - LK1510 - LK1511

Principal users :-

**MAJORSELL
REBUILD**

LK1506
MAN 51541017125, 51541017164, 51541017165

LK1510
MAN 51541017166

LK1511
Mercedes 0031314801, 0031316301

66A036R



66A036R

- 75 mm bore.
- Base mount.
- Engine oil lubrication.
- Non-through drive.
- Air cooled.
- Air ports : M26 x 1.5.
- Weight 7.2 Kg
- LK1506 - through drive.
- LK1510 & LK1511 - non-through drive.

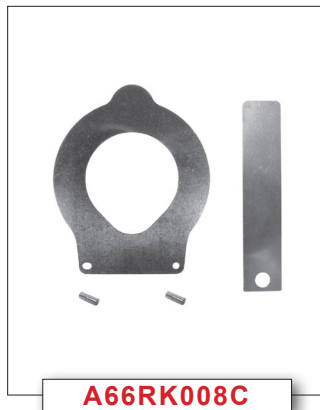

A66RK008C

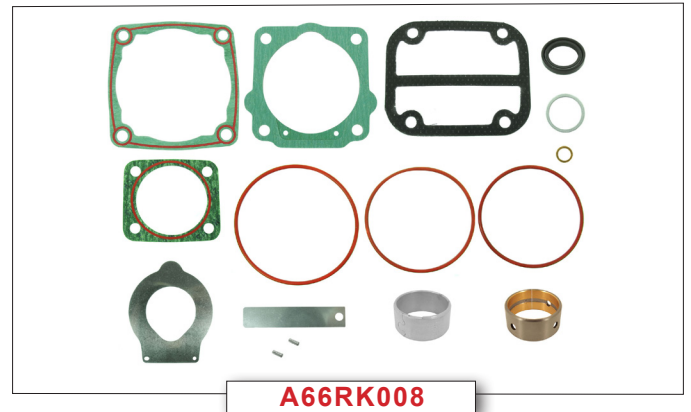

A66RK008



A66RK008V

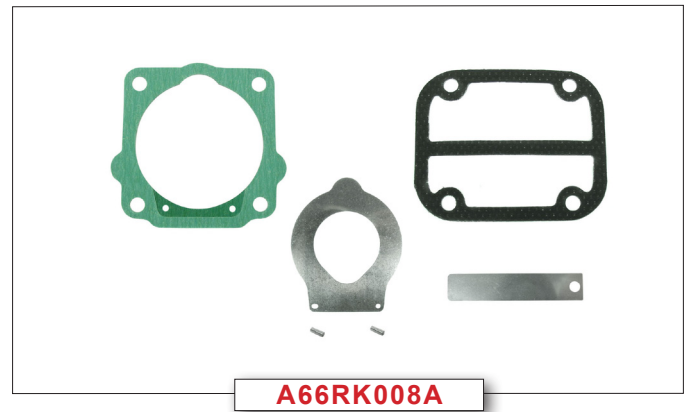

A66RK008A

020124	Std	A66RK027
020125	+0.50 mm	A66RK028
020126	+1.00 mm	A66RK029

	75 mm	
	2 x 2 mm	
	1 x 4 mm	

Piston & Rings

Ring set

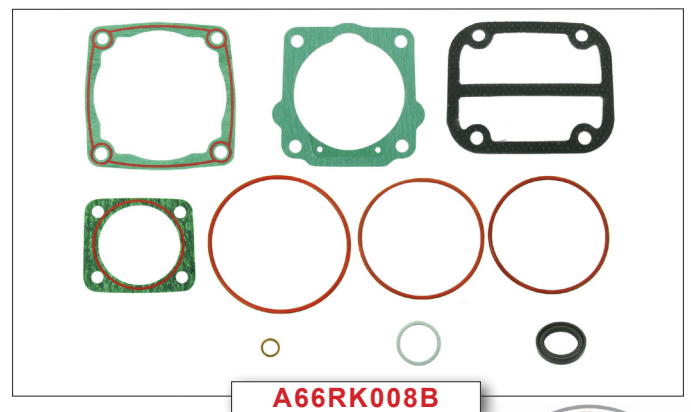

A66RK008B

Check our web site for suitability of these and other parts, or contact us directly.
Original part numbers are used for reference only. Check all applications.
All parts offered are Majorsell brand and may not be of an original supply.
Majorsell kit content and ring sets may be different to the original.



LK1506 - LK1510 - LK1511

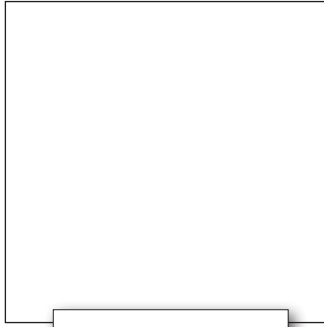

Bushes

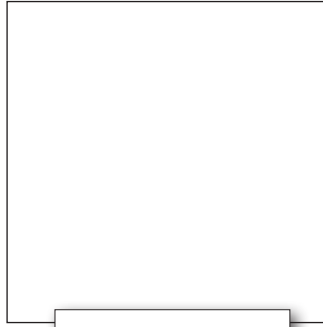

220014



220086

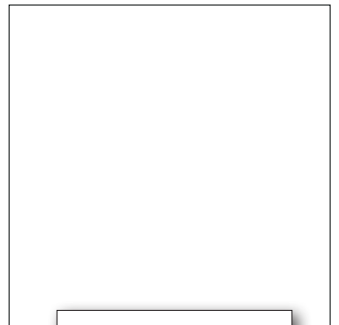
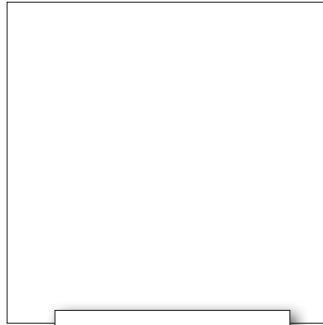

End cover

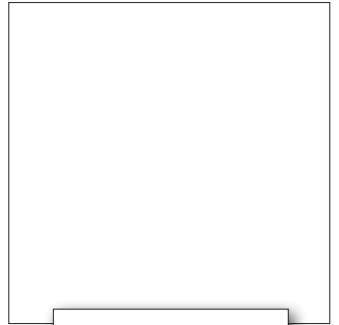
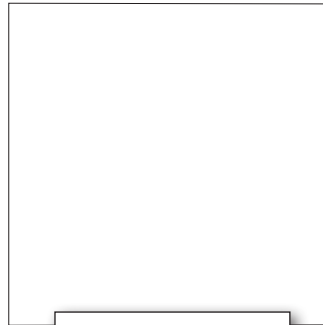

Majorsell



Majorsell



Majorsell

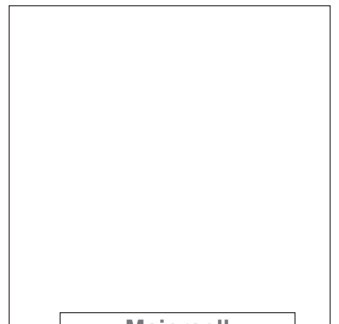

Majorsell



020165



020165K

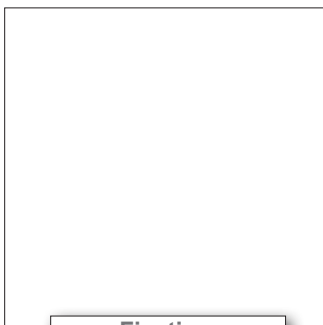

Fixatives

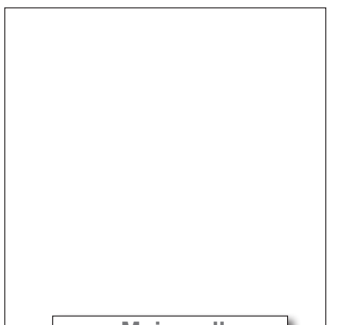

Majorsell

Majorsell Ltd
ENGLAND
sales@majorsell.co.uk
www.majorsell.co.uk

Notes :-

Majorsell parts for :-

LK1516 - LK1517 - LK1518

Principal users :-

**MAJORSELL
REBUILD**

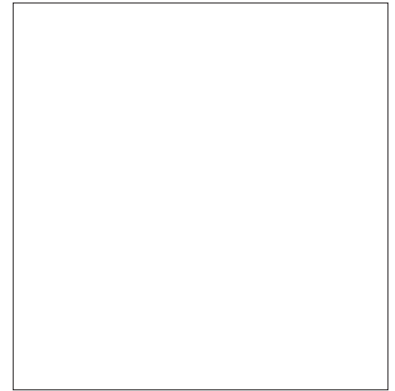

- 75 mm bore.
- Engine oil lubrication.
- Air cooled.
- Weight 7.5 Kg
- LK1516 - base mount, through drive.
- LK1518 - base mount, non-through drive.

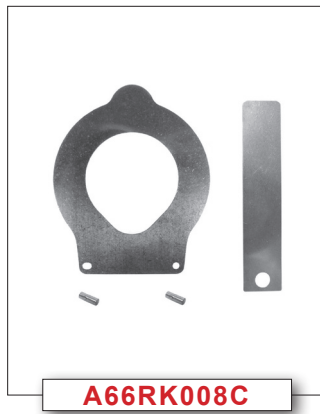

A66RK008C

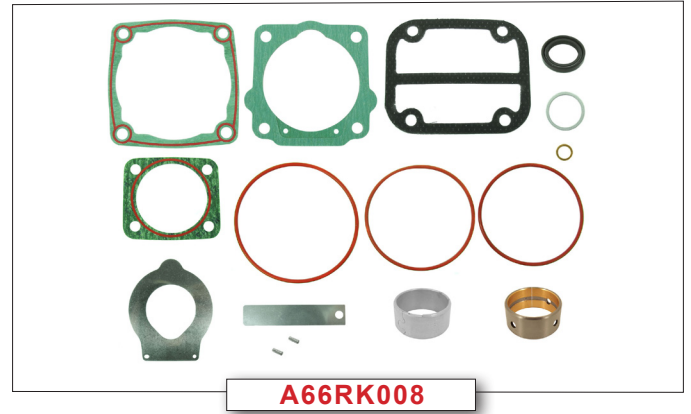

A66RK008



A66RK008V



A66RK008A

	020124	Std	A66RK027
	020125	+0.50 mm	A66RK028
	020126	+1.00 mm	A66RK029
	75 mm		
	2 x 2 mm		
	1 x 4 mm		

Piston & Rings

Ring set

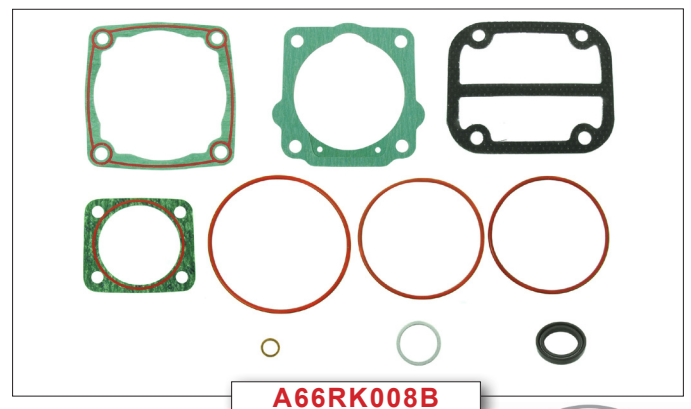

A66RK008B

Check our web site for suitability of these and other parts, or contact us directly. Original part numbers are used for reference only. Check all applications. All parts offered are Majorsell brand and may not be of an original supply. Majorsell kit content and ring sets may be different to the original.



LK1516 - LK1517 - LK1518

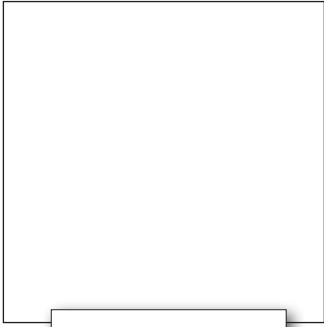

[Label box]

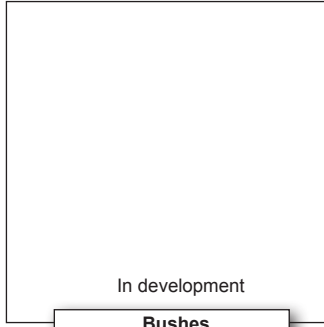

In development

Bushes

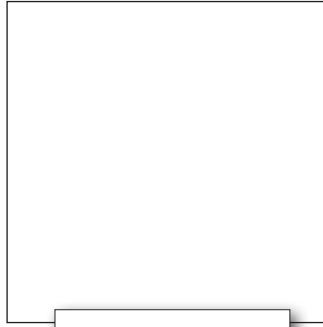

[Label box]

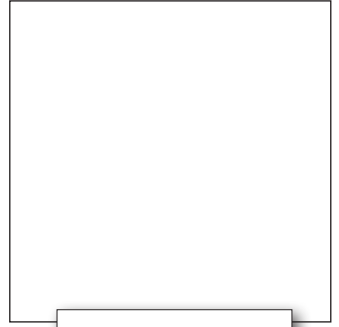

[Label box]



140130
4 used

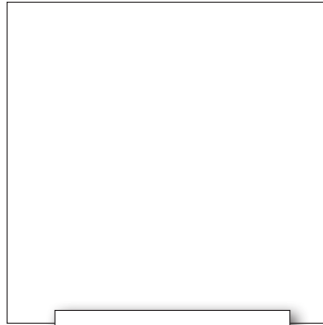

[Label box]

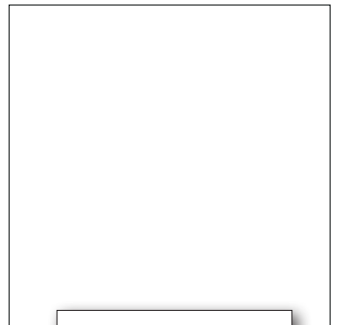

[Label box]

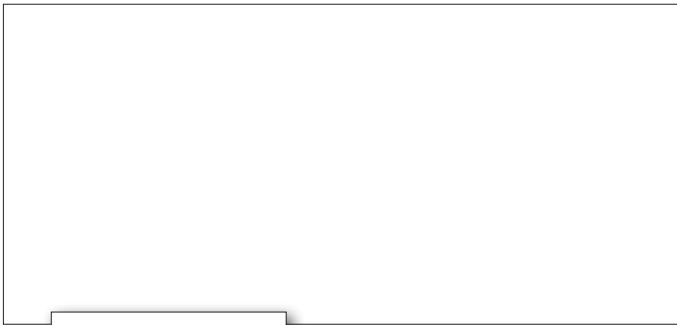

[Label box]

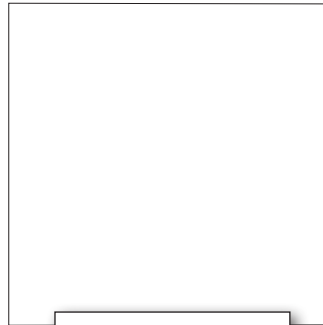

[Label box]

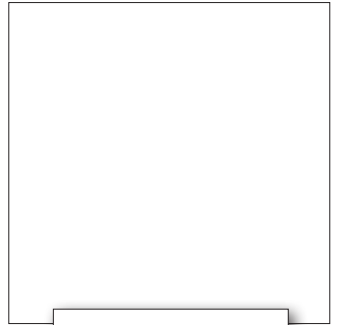

[Label box]



Majorsell

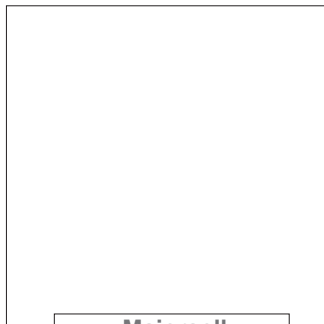

Majorsell



Majorsell

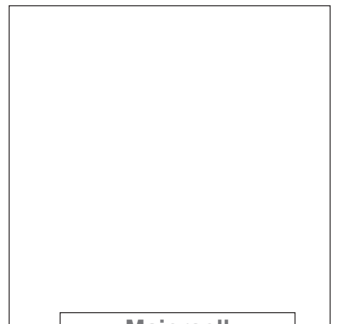

Majorsell



020165



020165K

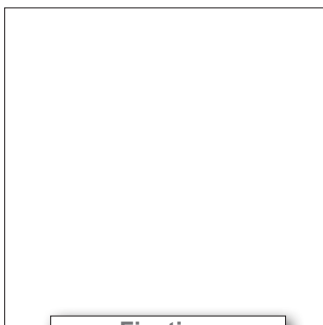

Fixatives

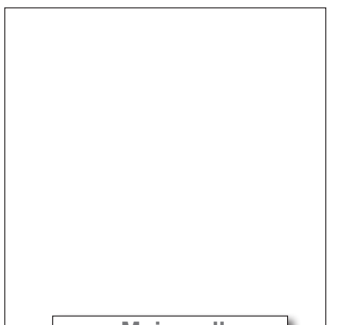

Majorsell

Majorsell Ltd
ENGLAND
sales@majorsell.co.uk
www.majorsell.co.uk

Notes :-

Majorsell parts for :-

LK1521 - 1522 - 1523

Principal users :-

**MAJORSELL
REBUILD**

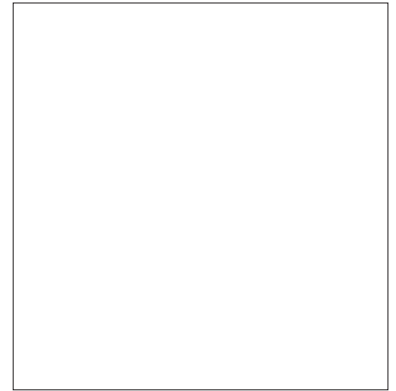

- 75 mm bore.
- Air cooled.
- Air ports : M26 x 1.5.

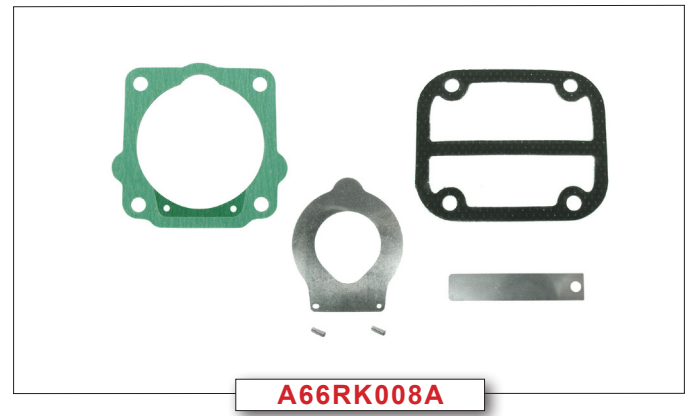
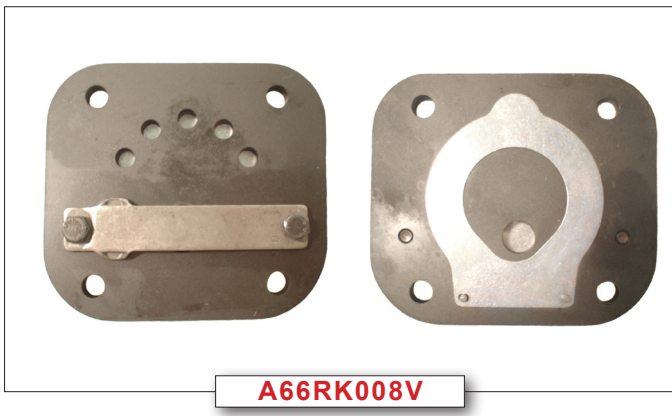
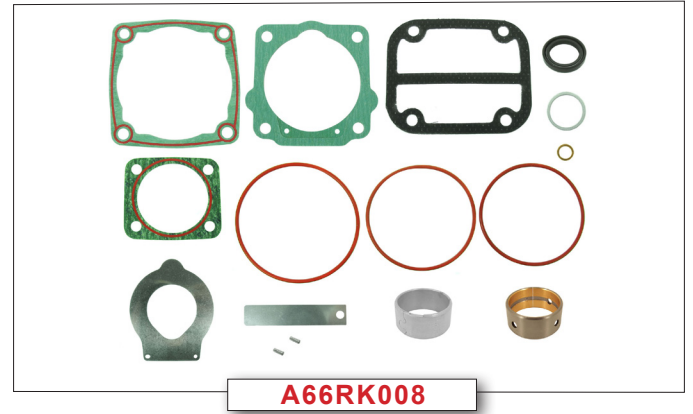
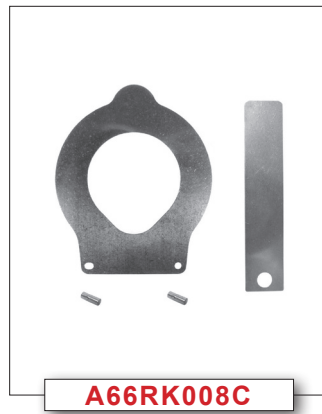

020124	Std	A66RK027
020125	+0.50 mm	A66RK028
020126	+1.00 mm	A66RK029

	75 mm	
	2 x 2 mm	
	1 x 4 mm	

Piston & Rings **Ring set**

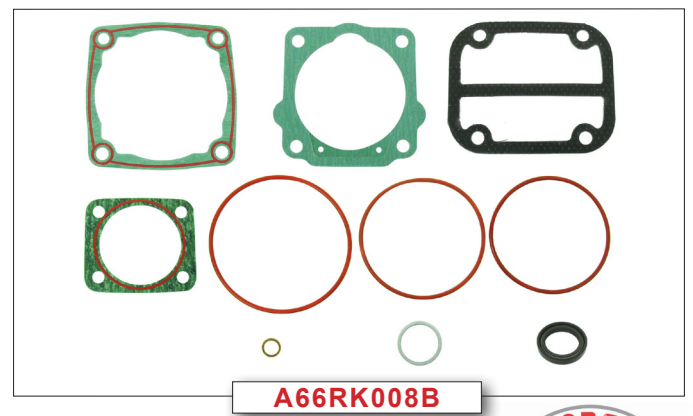

Check our web site for suitability of these and other parts, or contact us directly.
 Original part numbers are used for reference only. Check all applications.
 All parts offered are Majorsell brand and may not be of an original supply.
 Majorsell kit content and ring sets may be different to the original.



LK1521 - 1522 - 1523

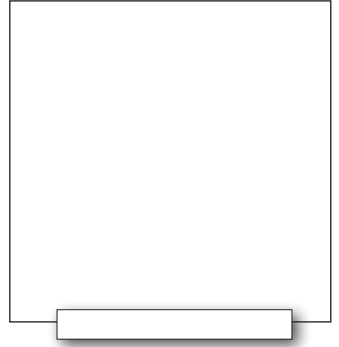
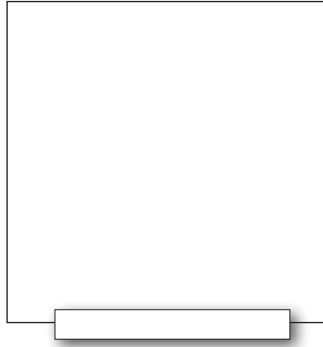
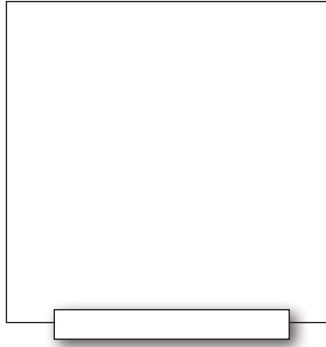
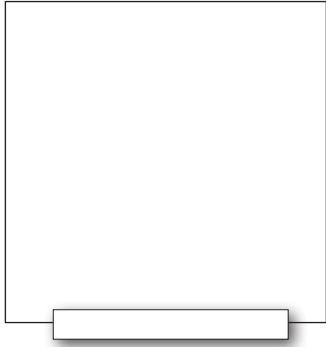

140130
4 used

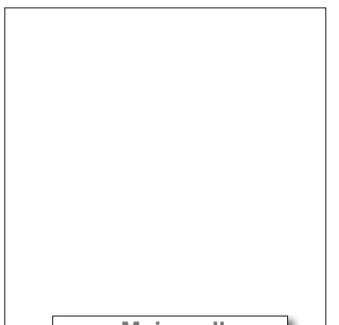
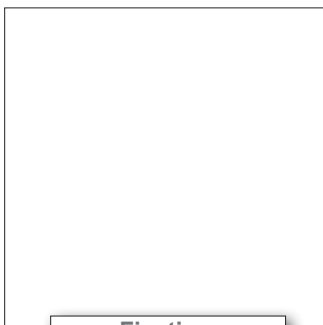
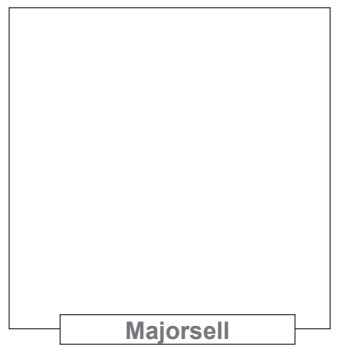
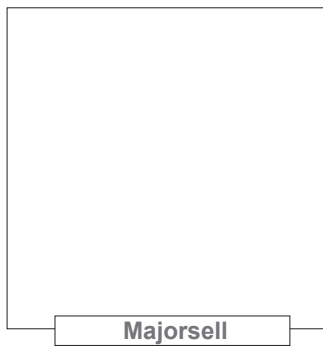
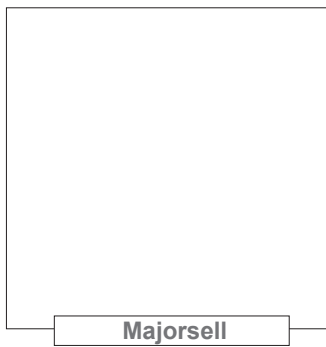
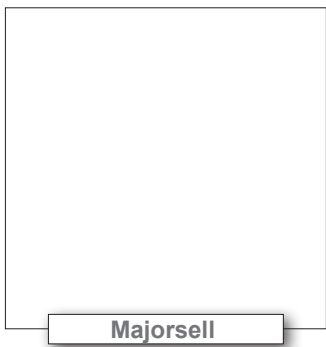
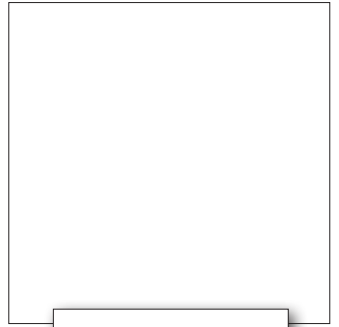
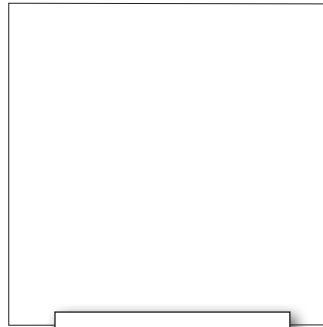
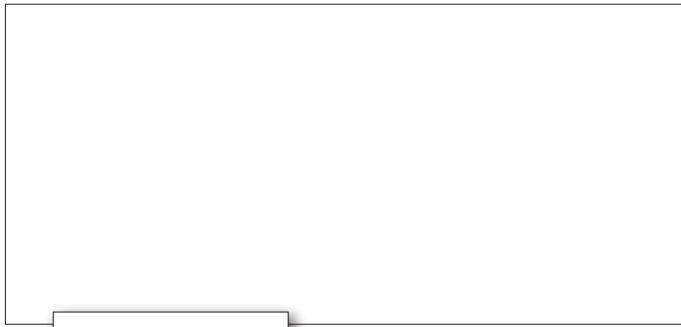
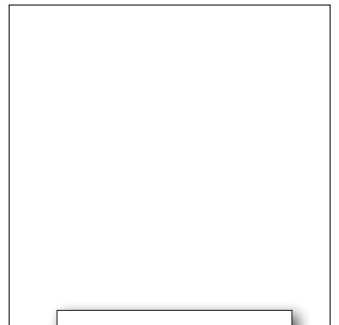
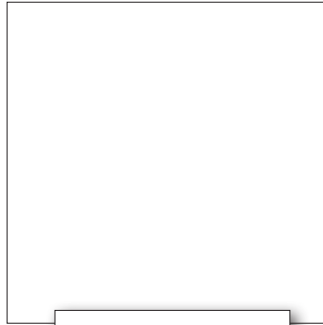

Majorsell Ltd
ENGLAND
sales@majorsell.co.uk
www.majorsell.co.uk

Notes :-

Majorsell parts for :-

LK1524

Principal users :-

Iveco

01175309

**MAJORSELL
REBUILD**

66A128R



- 75 mm bore.
- Non-through drive.
- Air cooled.
- Weight 7 Kg
- Base mount.
- Engine oil lubrication.
- Inlet & delivery ports : M26 x 1.5.

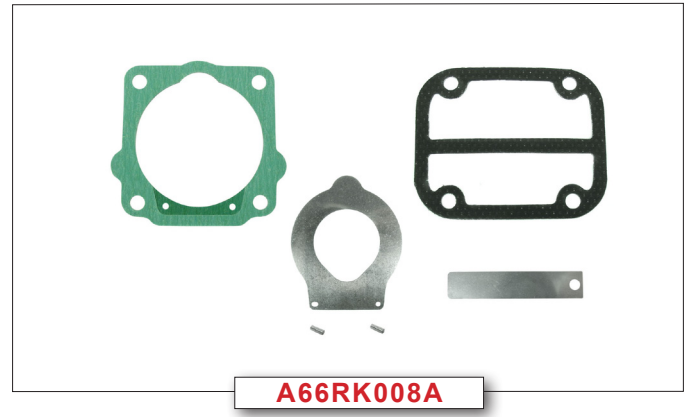
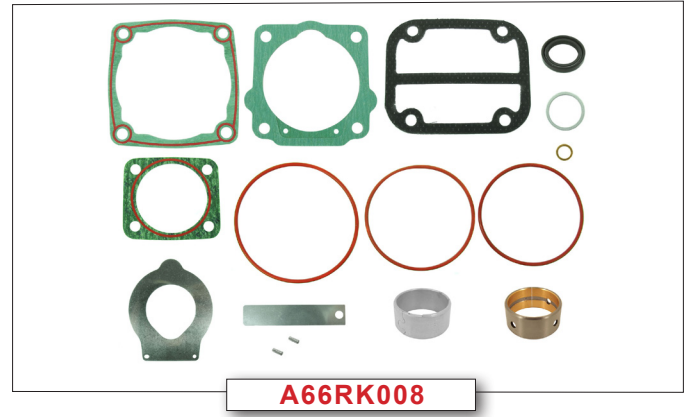
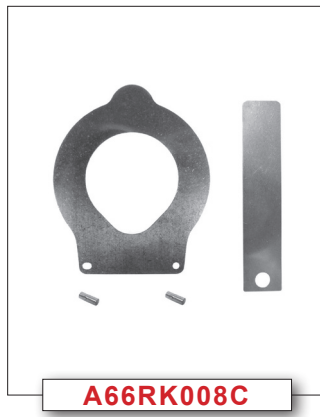

<p>020124 Std 020125 +0.50 mm 020126 +1.00 mm</p>	<p>A66RK027 A66RK028 A66RK029</p>
	
<p>75 mm 2 x 2 mm 1 x 4 mm</p>	
Piston & Rings	Ring set

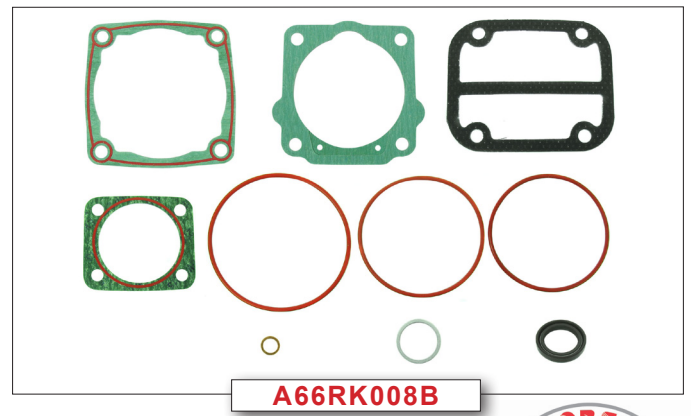

Check our web site for suitability of these and other parts, or contact us directly. Original part numbers are used for reference only. Check all applications. All parts offered are Majorsell brand and may not be of an original supply. Majorsell kit content and ring sets may be different to the original.



LK1524



220111



Bushes



140015



220014



Blank ports as required

220086



140130
4 used



140138
4 used

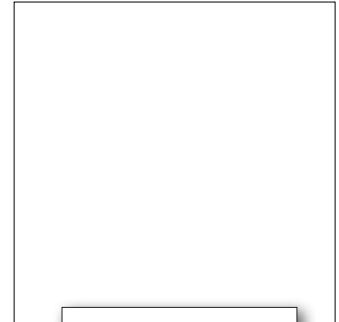
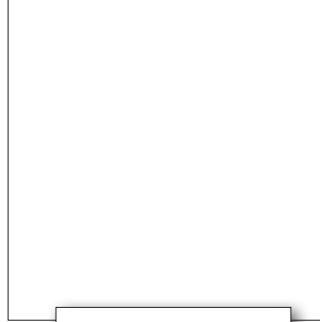

220139



140124
4 used



140103
4 used



220123

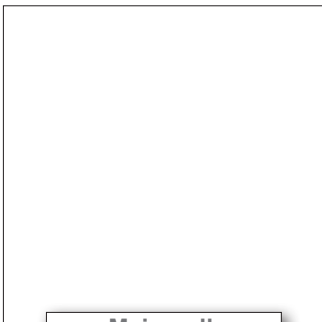
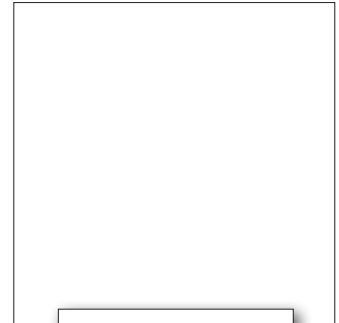

Majorsell

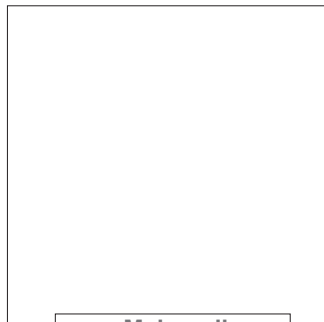

Majorsell

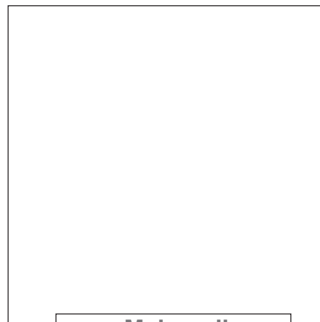

Majorsell

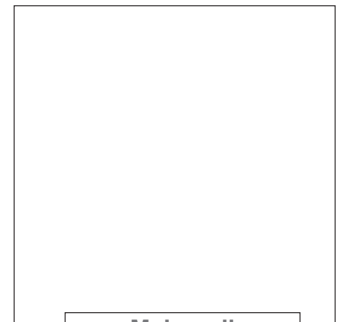

Majorsell



020165



020165K

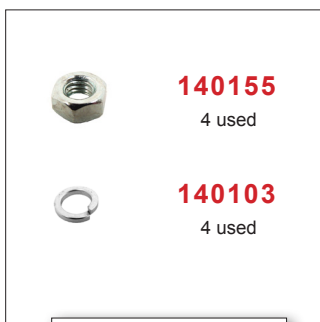

140155
4 used

140103
4 used

Fixatives

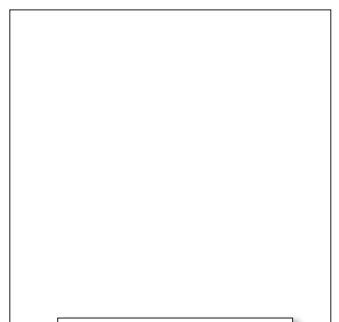

Majorsell

Majorsell Ltd
ENGLAND
sales@majorsell.co.uk
www.majorsell.co.uk

Notes :-

Majorsell parts for :-

LK1525 - LK1526

Principal users :-
DAF

**MAJORSELL
REBUILD**

LK1525

272732

66A089R



66A089R

- 75 mm bore.
- Through drive.
- Air cooled.
- Weight 8 Kg.
- Flange mount.
- Engine oil lubrication.
- Air ports M26 x 1.5

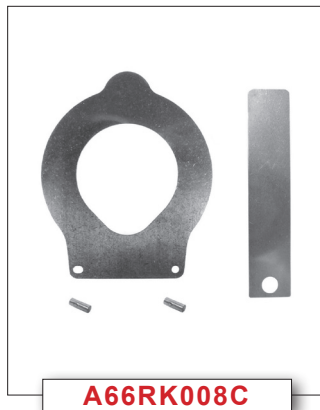

A66RK008C

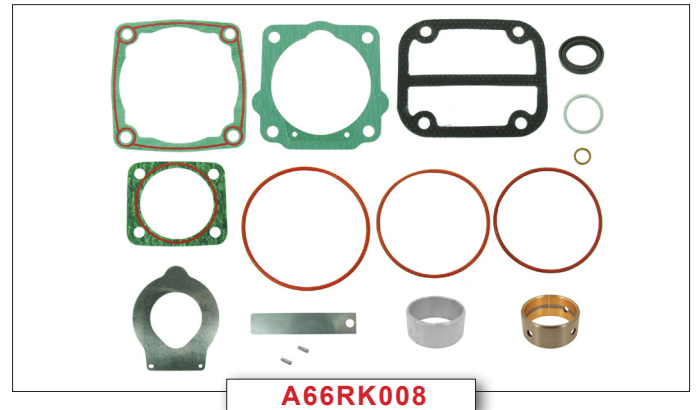

A66RK008



A66RK008V



A66RK008A

	020124	Std	A66RK027
	020125	+0.50 mm	A66RK028
	020126	+1.00 mm	A66RK029
		75 mm	
		2 x 2 mm	
		1 x 4 mm	
			

Piston & Rings

Ring set

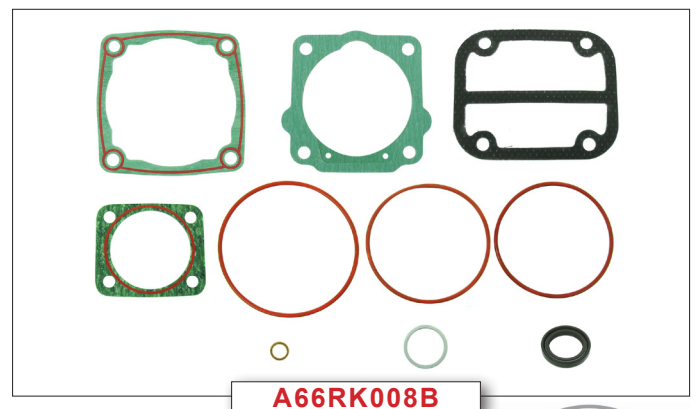

A66RK008B

Check our web site for suitability of these and other parts, or contact us directly. Original part numbers are used for reference only. Check all applications. All parts offered are Majorsell brand and may not be of an original supply. Majorsell kit content and ring sets may be different to the original.



LK1525 - LK1526



Crankshaft



Front

050228



140015



220014



Blank ports as required

220086



140131
4 used

140138
4 used

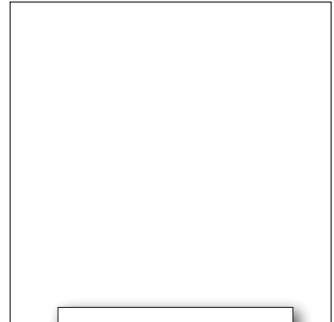
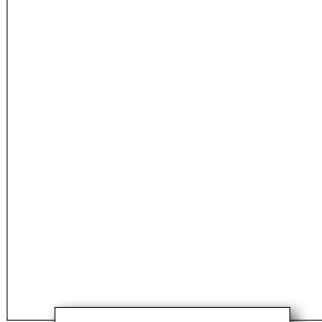

Rear Cover

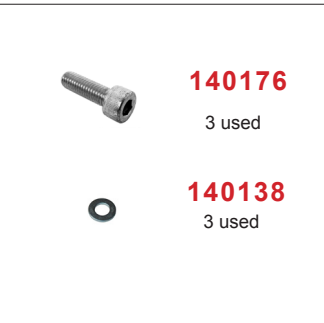

140176
3 used

140138
3 used

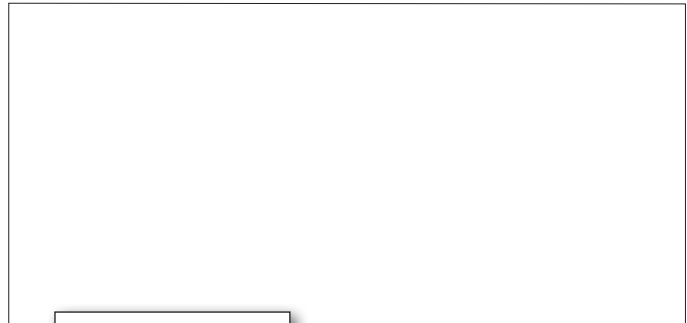

Majorsell

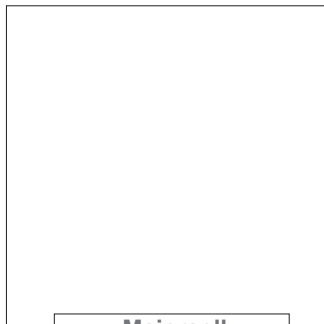

Majorsell



Majorsell



Majorsell



020165



020165K

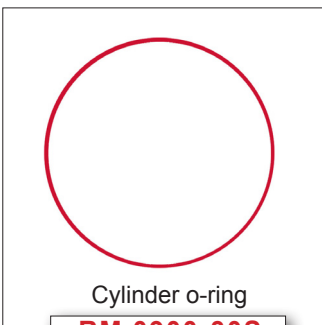

Cylinder o-ring
RM 0900-30S



140155
4 used

140103
4 used

Fixatives

Majorsell parts for :-

LK1527

Principal users :-
Mercedes

MAJORSELL
REBUILD

0041310501

66A037R



- 75 mm bore.
- Through drive.
- Air cooled.
- Weight 7.5 Kg.
- Base mount.
- Engine oil lubrication.
- Air ports M26 x 1.5

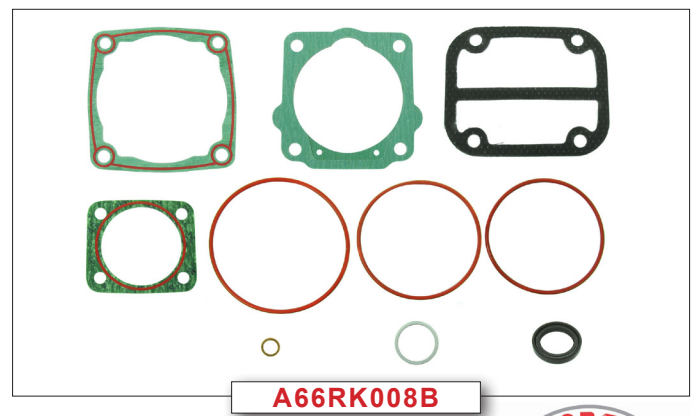
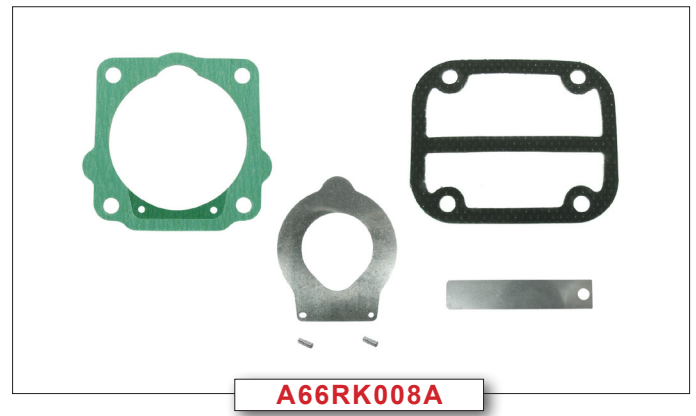
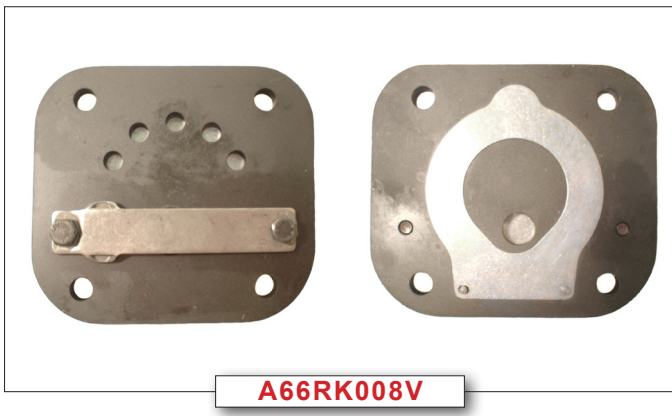
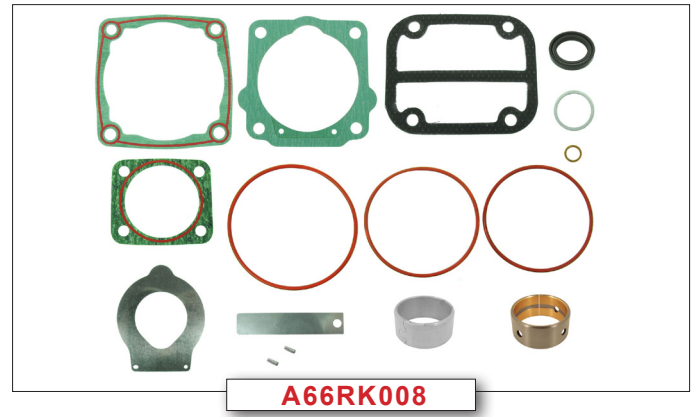
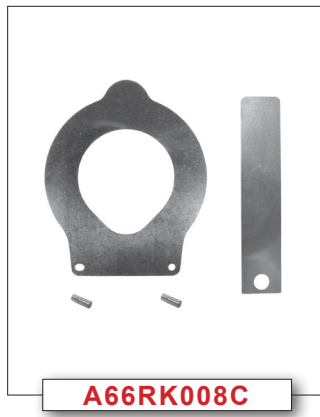

Check our web site for suitability of these and other parts, or contact us directly. Original part numbers are used for reference only. Check all applications. All parts offered are Majorsell brand and may not be of an original supply. Majorsell kit content and ring sets may be different to the original.



LK1527



220124



050181

050182



140015



220014



220086



140130



140138

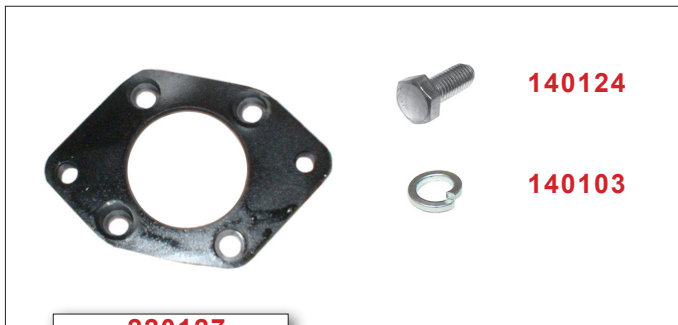
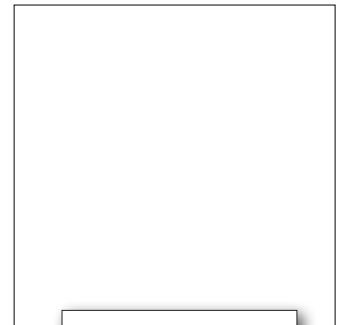
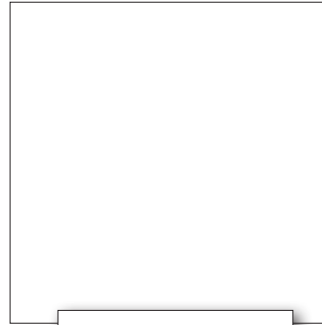

220127



140124



140103



220123

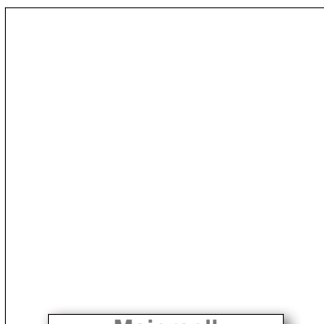
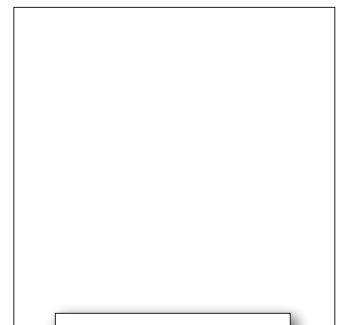

Majorsell

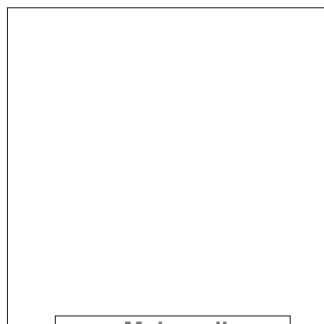

Majorsell

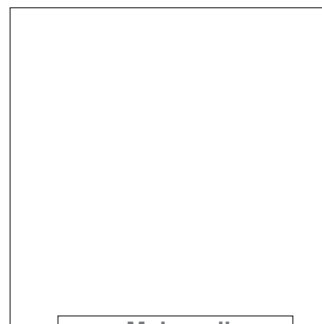

Majorsell

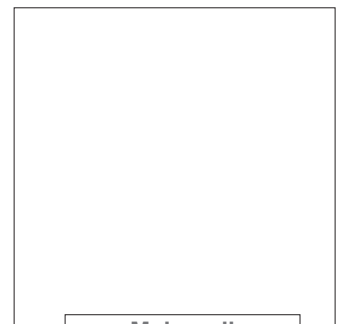

Majorsell



020165



020165K



140155

140103

Fixatives

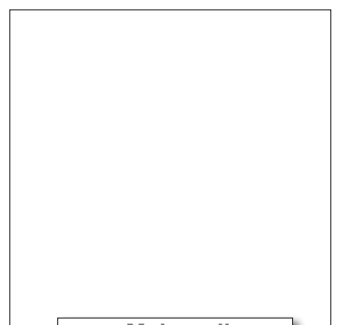

Majorsell

Majorsell Ltd
ENGLAND
sales@majorsell.co.uk
www.majorsell.co.uk

Notes :-

Majorsell parts for :-

LK1532

Principal users :-

Mercedes

**MAJORSELL
REBUILD**

0041311901

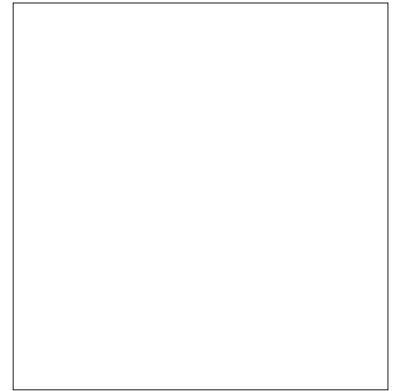

- 75 mm bore.
- Non-through drive.
- Air cooled.
- Weight 7.2 Kg

- Base mount.
- Engine oil lubrication.
- Air ports : M26 x 1.5.

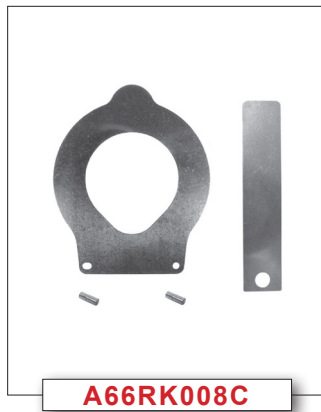

A66RK008C

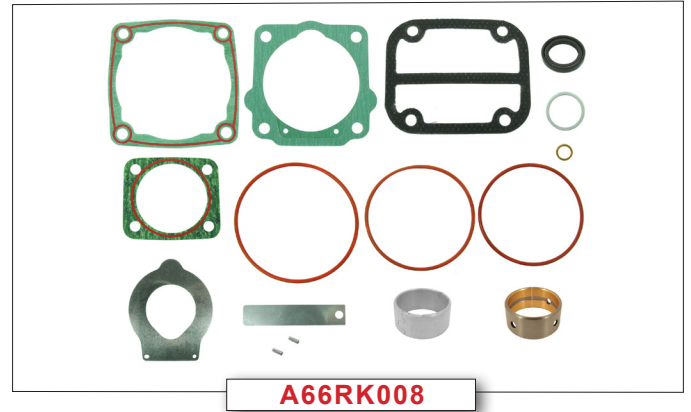

A66RK008



A66RK008V



A66RK008A

020124	Std	A66RK027
020125	+0.50 mm	A66RK028
020126	+1.00 mm	A66RK029

	75 mm	
	2 x 2 mm	
	1 x 4 mm	

Piston & Rings

Ring set

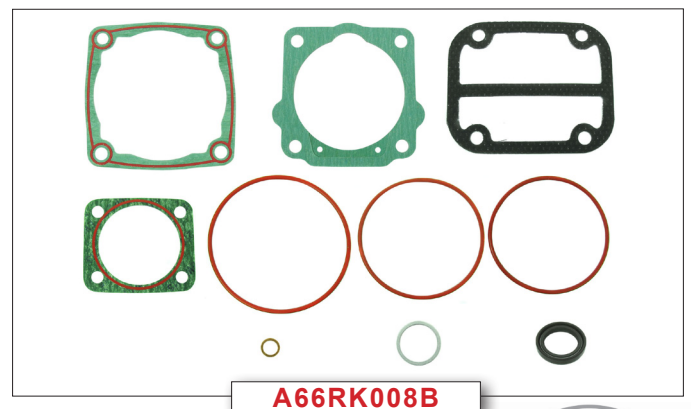

A66RK008B

Check our web site for suitability of these and other parts, or contact us directly. Original part numbers are used for reference only. Check all applications. All parts offered are Majorsell brand and may not be of an original supply. Majorsell kit content and ring sets may be different to the original.



LK1532

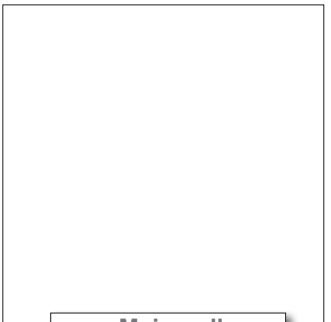
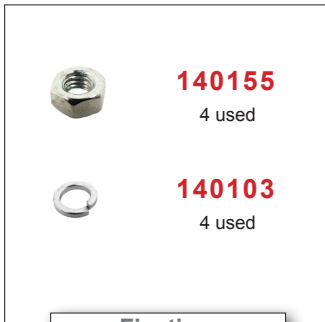
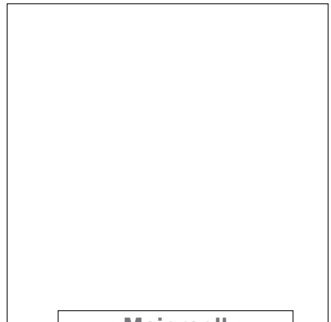
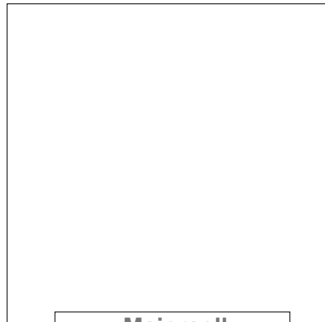
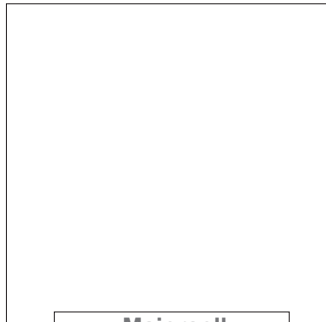
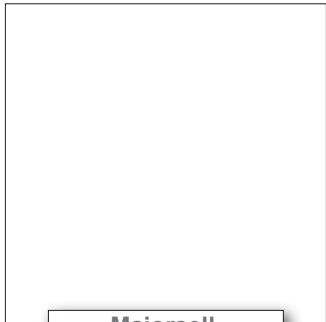
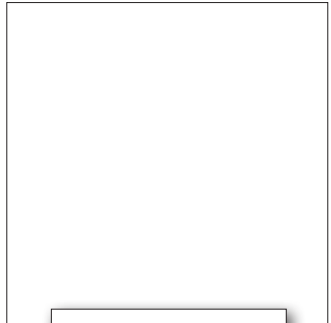
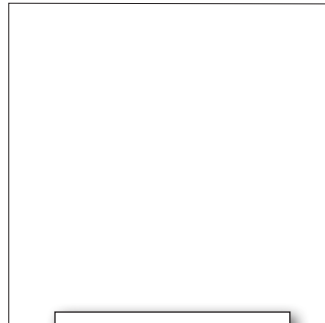
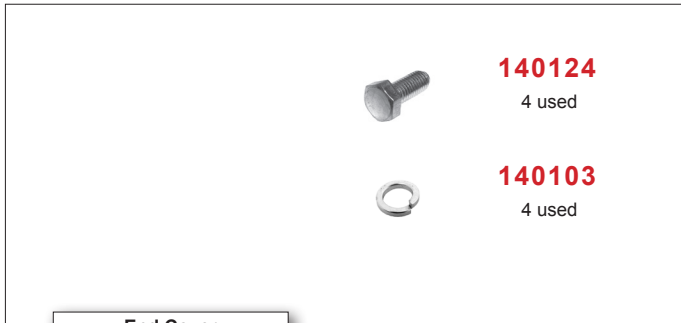
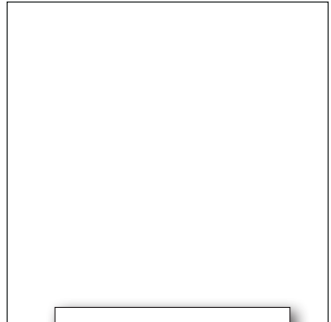
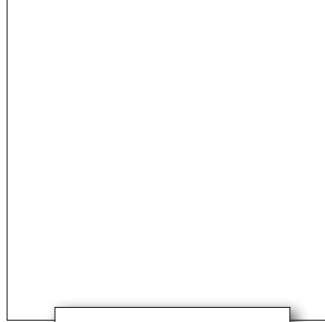
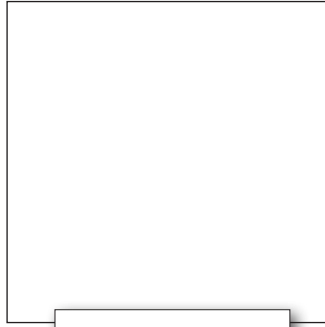
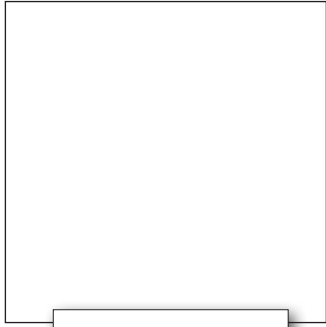

Majorsell Ltd
ENGLAND
sales@majorsell.co.uk
www.majorsell.co.uk

Notes :-

Majorsell parts for :-

LK1539

Principal users :-
DAF

**MAJORSELL
REBUILD**

0537989

66A061R



- 75 mm bore.
- Through drive.
- Air cooled.
- Weight 8 Kg.
- Flange mount.
- Engine oil lubrication.
- Air ports M26 x 1.5

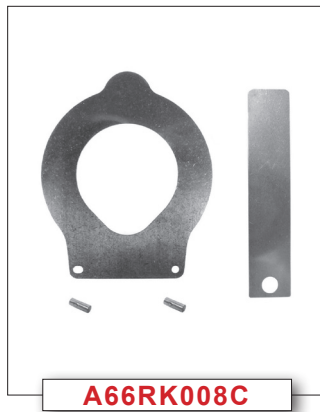

A66RK008C

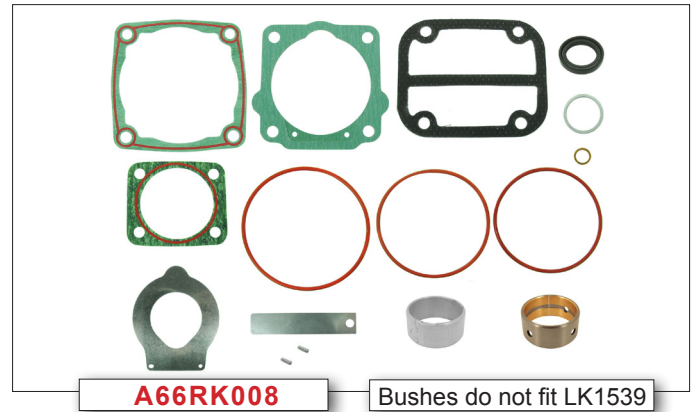

A66RK008

Bushes do not fit LK1539



A66RK008V



A66RK008A



Piston & Rings

Ring set

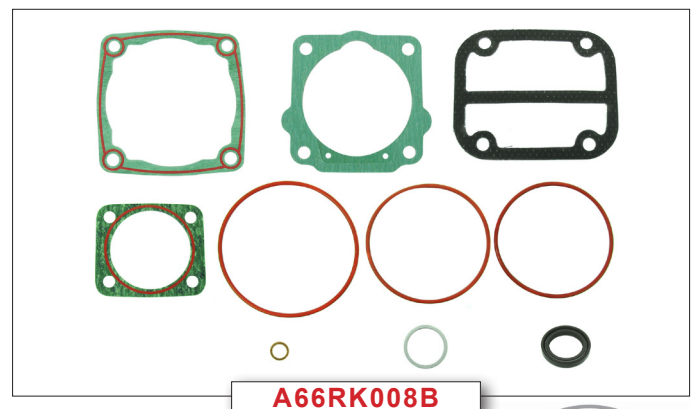

A66RK008B

Check our web site for suitability of these and other parts, or contact us directly.
Original part numbers are used for reference only. Check all applications.
All parts offered are Majorsell brand and may not be of an original supply.
Majorsell kit content and ring sets may be different to the original.



LK1539



Crankshaft



Front

050228



140016



220014



Blank ports as required

220136

140131
4 used

140138
4 used



220086



Rear Cover

140176
3 used

140138
3 used

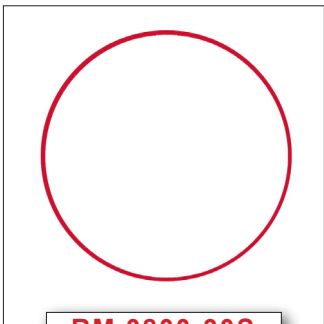

RM 0800-30S

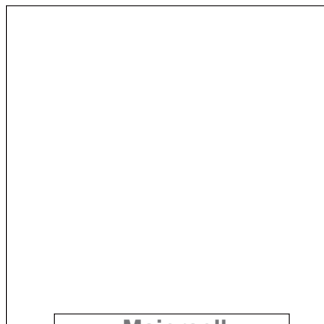

Majorsell



Majorsell



Majorsell



020165



020165K

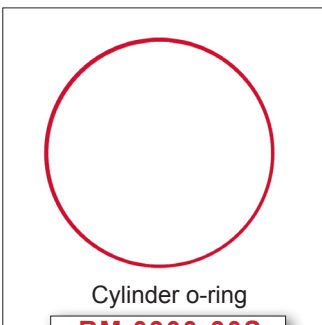

Cylinder o-ring
RM 0900-30S



140155
4 used

140103
4 used

Fixatives

Majorsell Ltd
ENGLAND
sales@majorsell.co.uk
www.majorsell.co.uk

Notes :-

Majorsell parts for :-

LK1549

Principal users :-
Iveco

**MAJORSELL
REBUILD**

01179230

66A113R

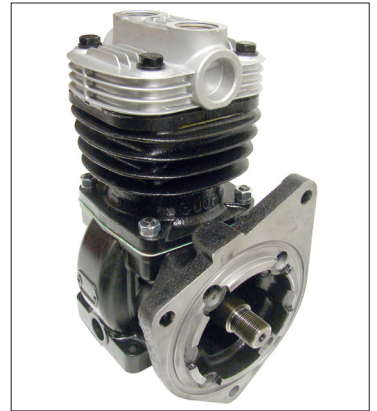

- 75 mm bore.
- Non-through drive.
- Air cooled.
- Weight 10 Kg.
- Flange mount.
- Engine oil lubrication.
- Air ports M26 x 1.5

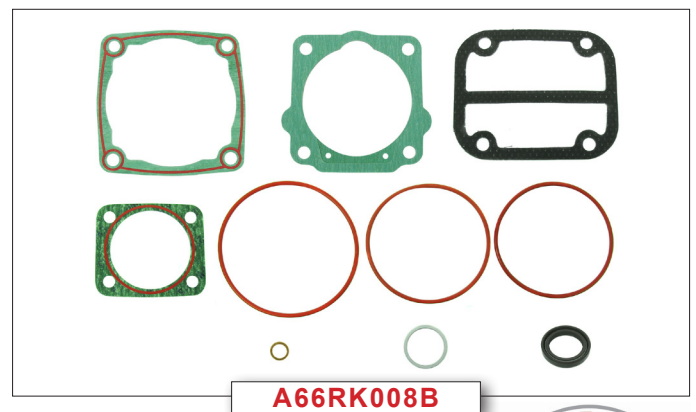
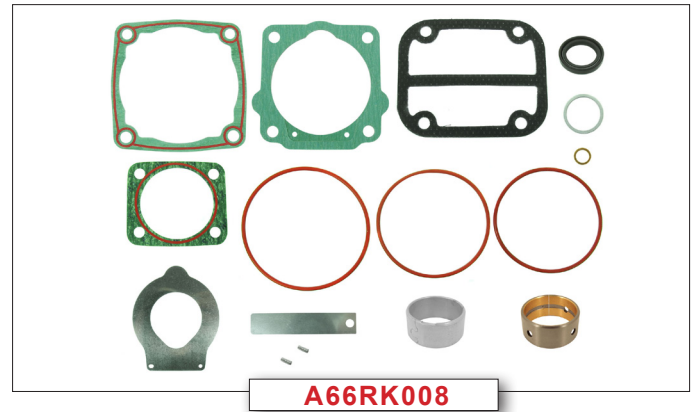
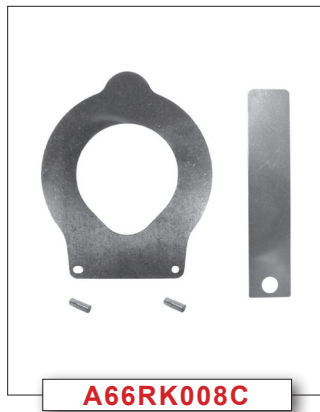

Check our web site for suitability of these and other parts, or contact us directly. Original part numbers are used for reference only. Check all applications. All parts offered are Majorsell brand and may not be of an original supply. Majorsell kit content and ring sets may be different to the original.



LK1549



Crankshaft



Bushes



140016



220014



220136



Blank ports as required

220086

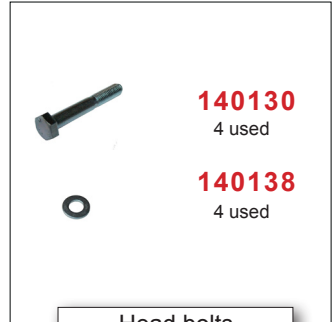

Head bolts



220139



Front Flange

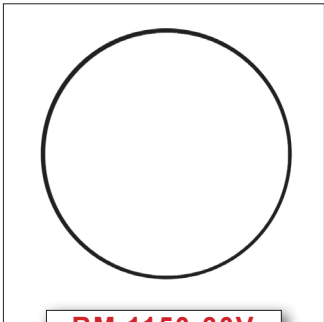

RM 1150-30V

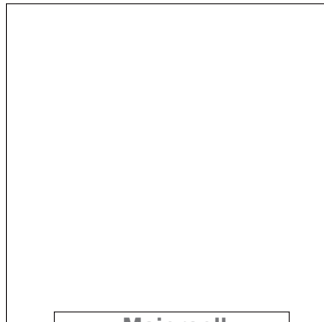

Majorsell

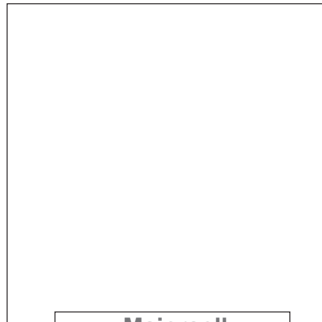

Majorsell

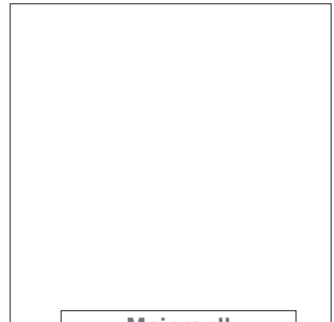

Majorsell



020165



020165K



Fixatives

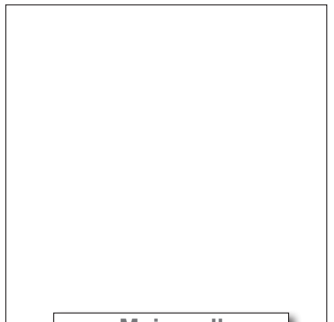

Majorsell

Majorsell Ltd
ENGLAND
sales@majorsell.co.uk
www.majorsell.co.uk

Notes :-

Majorsell parts for :-

LK1813

Principal users :-
Mercedes

MAJORSELL
REBUILD

0041317401, 0041317701, 0041319401 **66A040R**



- 88 mm bore.
- Through drive.
- Air cooled.
- Weight 8 Kg.
- Side mount.
- Engine oil lubrication.
- Air ports M26 x 1.5.

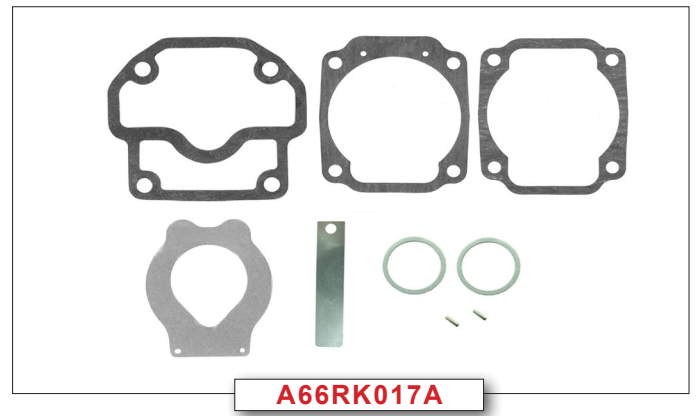
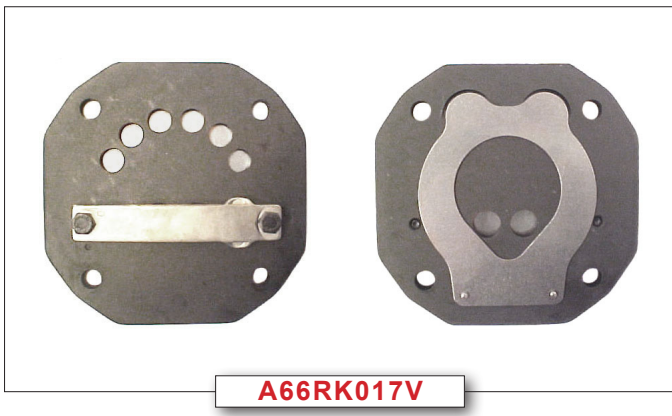
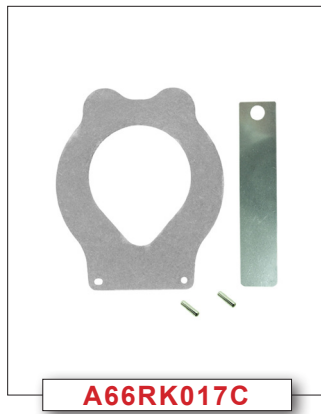

	020112	Std	A66RK010
	020113	+0.50 mm	A66RK011
	020129	+1.00 mm	A66RK015
		88 mm	
		2 x 2.5 mm	
		1 x 4 mm	

Piston & Rings **Ring set**

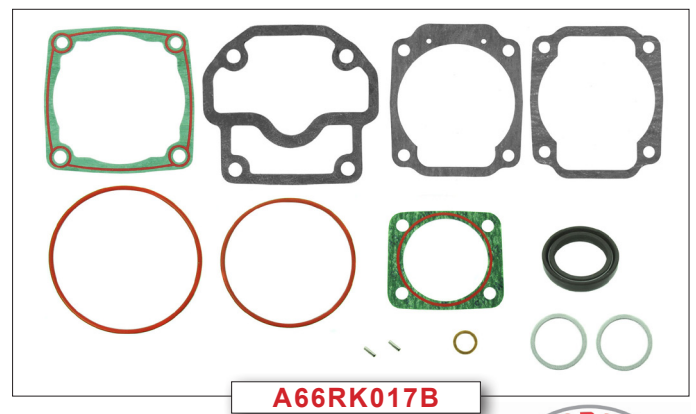

Check our web site for suitability of these and other parts, or contact us directly. Original part numbers are used for reference only. Check all applications. All parts offered are Majorsell brand and may not be of an original supply. Majorsell kit content and ring sets may be different to the original.



LK1813



220062



050189
Front

050181
Rear

Bushes



140015



220014



220061



140120
4 used



140138
4 used



220128



220129



140135
3 used

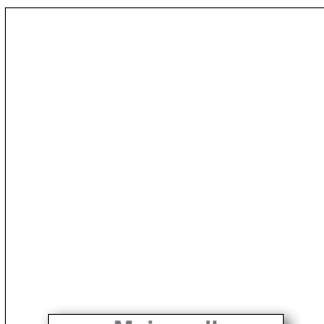
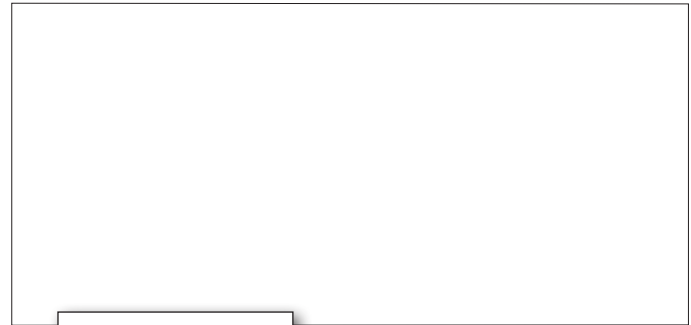

Majorsell



Majorsell



Majorsell

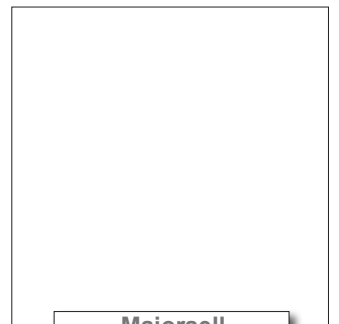

Majorsell



020152



020152K

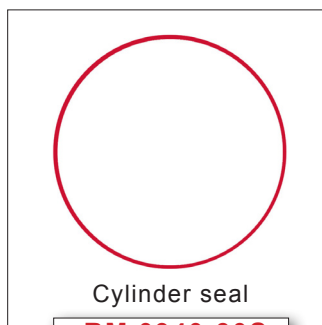

Cylinder seal

RM 0940-30S



140155
4 used

140103
4 used

Fixatives

Majorsell Ltd
ENGLAND
sales@majorsell.co.uk
www.majorsell.co.uk

Notes :-

Majorsell parts for :-

LK1900 LK1901

Principal users :-

Iveco

**MAJORSELL
REBUILD**

01174433, 01173859, 01261951,
01261653

66A048R

01173860, 01174472, 01261657,
42522671

66A049R

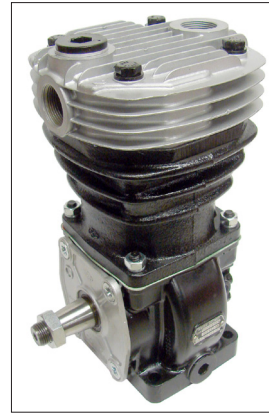

66A048R



66A049

- 88 mm bore.
- Non-through drive.
- Air cooled.
- Weight 8 Kg.

- Base mount.
- Engine oil lubrication.
- Air ports M26 x 1.5.

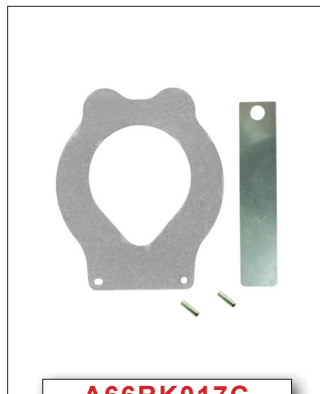

A66RK017C



A66RK009



A66RK017V



A66RK017A

	020112	Std	A66RK010
	020113	+0.50 mm	A66RK011
	020129	+1.00 mm	A66RK015
		88 mm	
		2 x 2.5 mm	
		1 x 4 mm	

Piston & Rings

Ring set

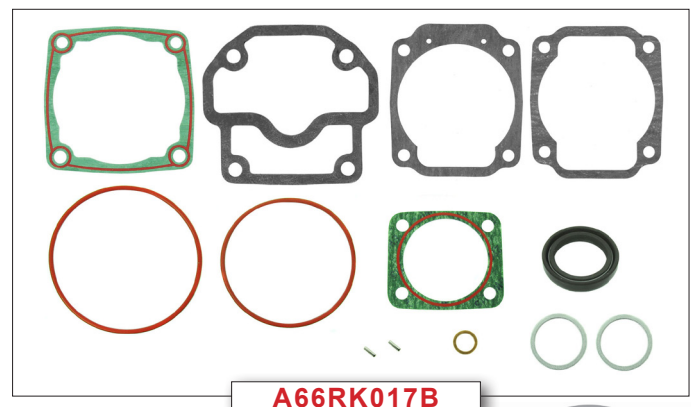

A66RK017B

Check our web site for suitability of these and other parts, or contact us directly. Original part numbers are used for reference only. Check all applications. All parts offered are Majorsell brand and may not be of an original supply. Majorsell kit content and ring sets may be different to the original.



LK1900 LK1901



220071



Bushes



140015



220052



220117



220125

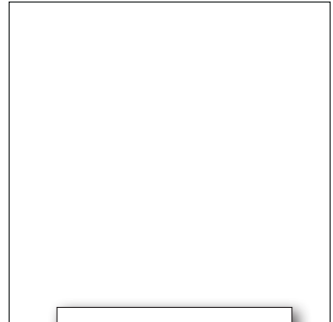

220139



220123

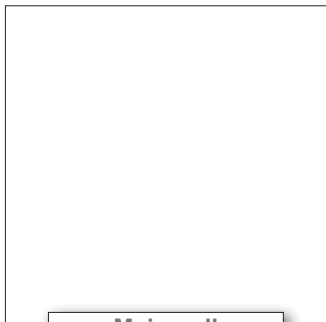

Majorsell

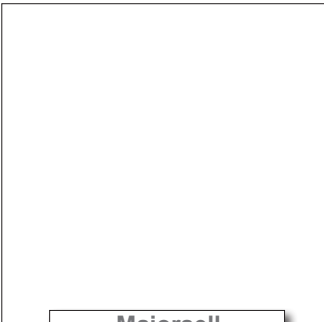

Majorsell



Majorsell

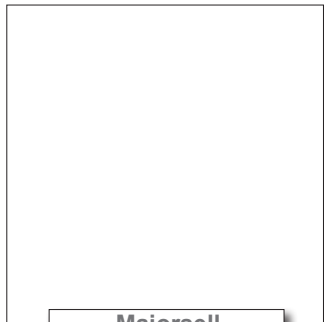

Majorsell



020161



020161K



Fixatives

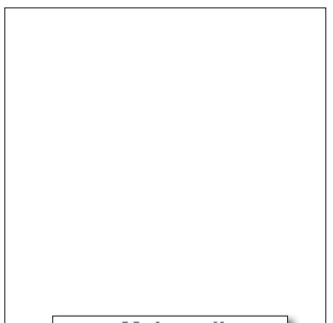

Majorsell

Majorsell parts for :-

LK1909

Principal users :-
Iveco

**MAJORSELL
REBUILD**

01177075

66A120R



- 88 mm bore.
- Non-through drive.
- Water cooled
- Weight 10 Kg.
- Base mount.
- Engine oil lubrication.
- Water ports : M14 x 1.5
- Air ports : M26 x 1.5.

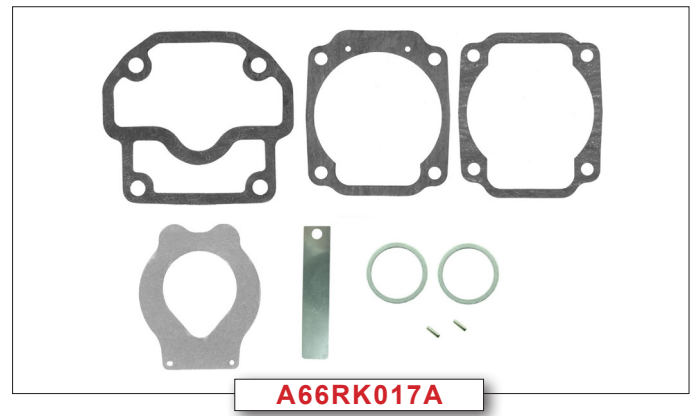
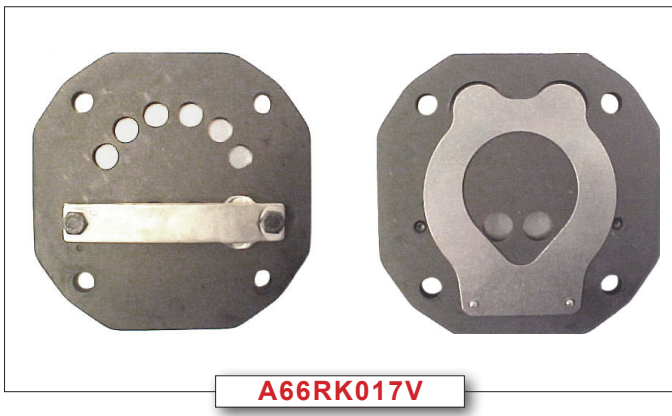
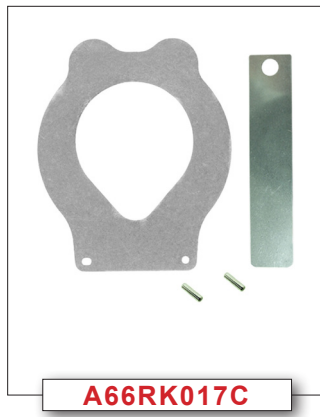

<p>020112 Std A66RK010 020113 +0.50 mm A66RK011 020129 +1.00 mm A66RK015</p>	<p>88 mm 2 x 2.5 mm 1 x 4 mm</p>	
Piston & Rings		Ring set

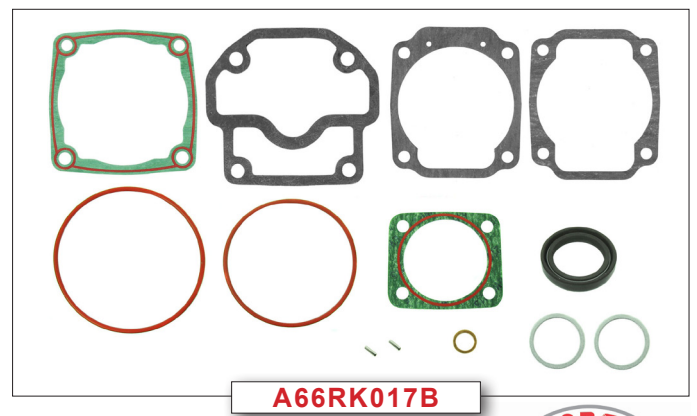

Check our web site for suitability of these and other parts, or contact us directly.
Original part numbers are used for reference only. Check all applications.
All parts offered are Majorsell brand and may not be of an original supply.
Majorsell kit content and ring sets may be different to the original.



LK1909

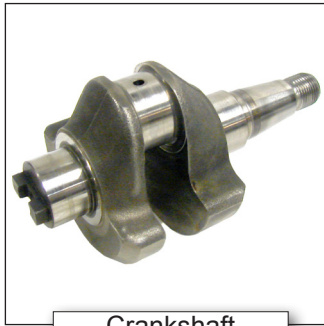

Crankshaft



050181
Front



050182
Rear

Bushes



140015



050090
1 pr.

220052



220125



140120
4 used

140138
4 used

220117



220139

140124
4 used

140103
4 used



220123

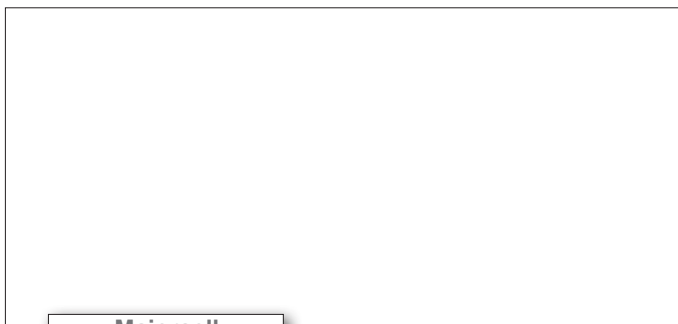

Majorsell



Majorsell



020161



020161K



140155
4 used

140103
4 used

Fixatives

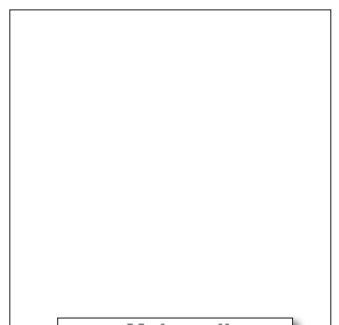

Majorsell

Majorsell Ltd
ENGLAND
sales@majorsell.co.uk
www.majorsell.co.uk

Notes :-

Majorsell parts for :-

LK3501

Principal users :-

Volvo

**MAJORSELL
REBUILD**

5003218, 6795599, 6772238

66A027R



Fits FL6.

- 75 mm bore.
- Non-through drive.
- Water cooled.
- Weight 11 Kg
- Base mount.
- Engine oil lubrication.
- Water ports M18 x 1.5 mm.
- Air ports M26 x 1.5 mm.

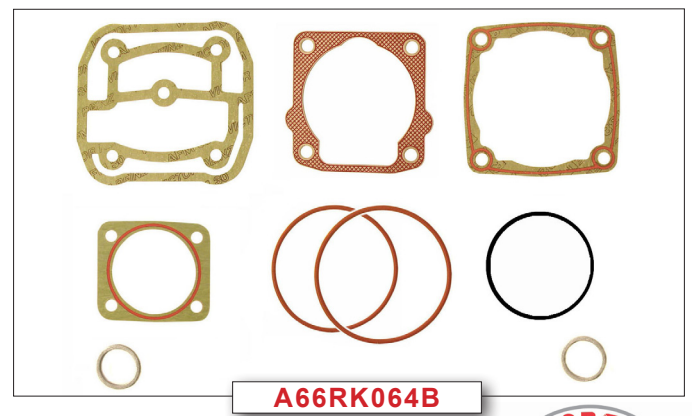
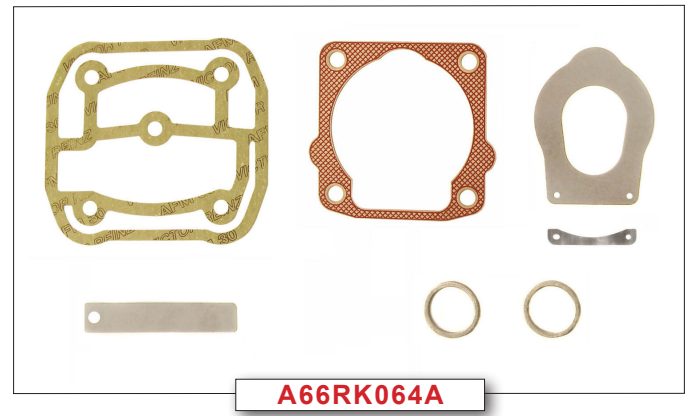
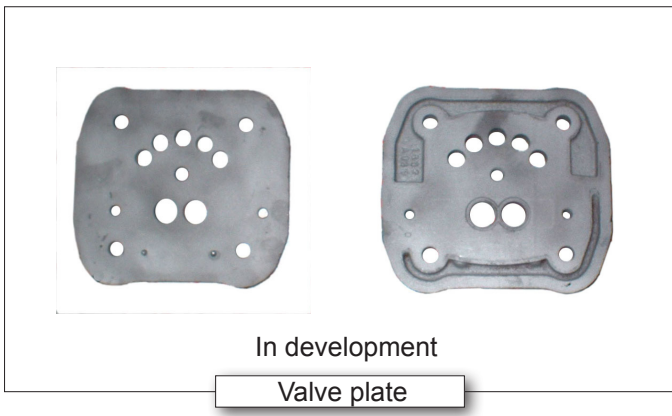
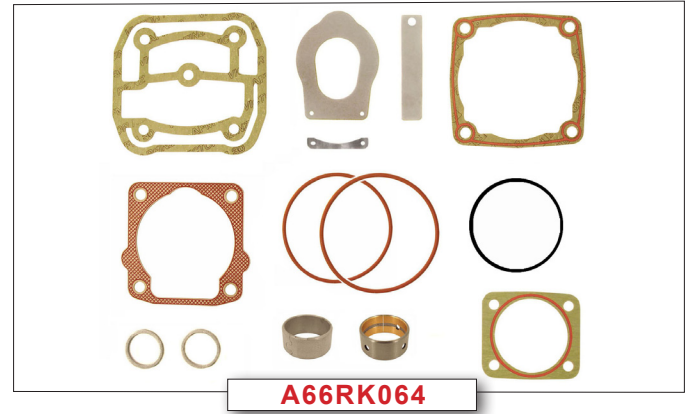

Check our web site for suitability of these and other parts, or contact us directly. Original part numbers are used for reference only. Check all applications. All parts offered are Majorsell brand and may not be of an original supply. Majorsell kit content and ring sets may be different to the original.



LK3501



Crankshaft



Bushes



140016



220014

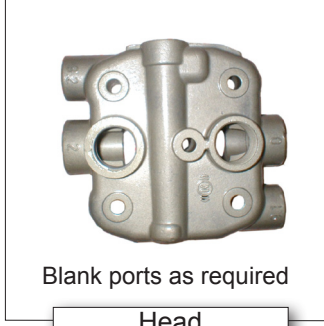

Blank ports as required

Head



140120
4 used

140132
1 used

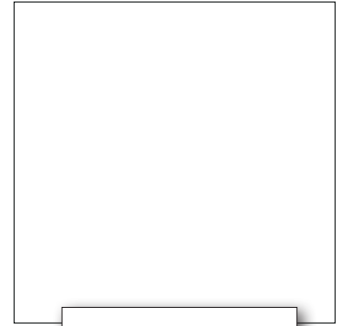
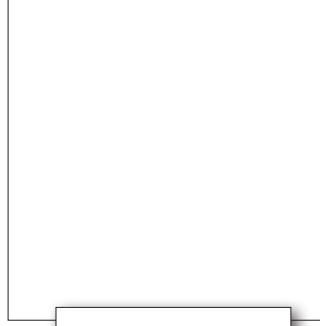

Rear end cover

220139



140124
4 used

140103
4 used



Front flange

220140

140170
4 used

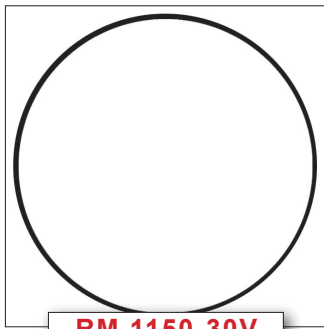

RM 1150-30V

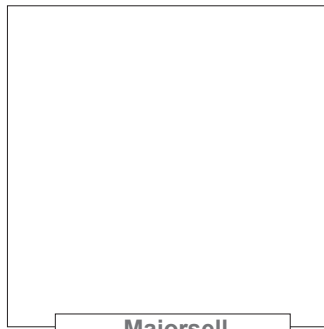

Majorsell

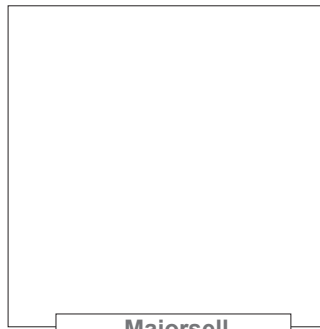

Majorsell

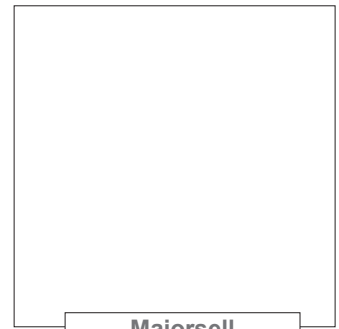

Majorsell



020165



020165K

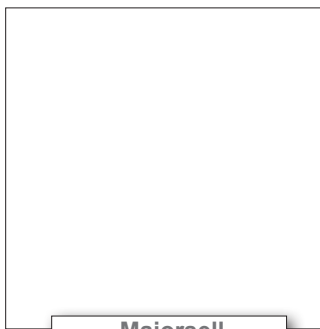

Majorsell

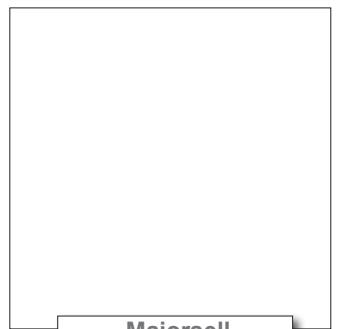

Majorsell

Majorsell Ltd
ENGLAND
sales@majorsell.co.uk
www.majorsell.co.uk

Notes :-

Majorsell parts for :-

LK3515

Principal users :-

Iveco

**MAJORSELL
REBUILD**

01180579

66A116R



- 75 mm bore.
- Non-through drive.
- Water cooled.
- Weight 11 Kg
- Flange mount.
- Engine oil lubrication.
- Water ports M16 x 1.5 mm.
- Air ports M26 x 1.5 mm.

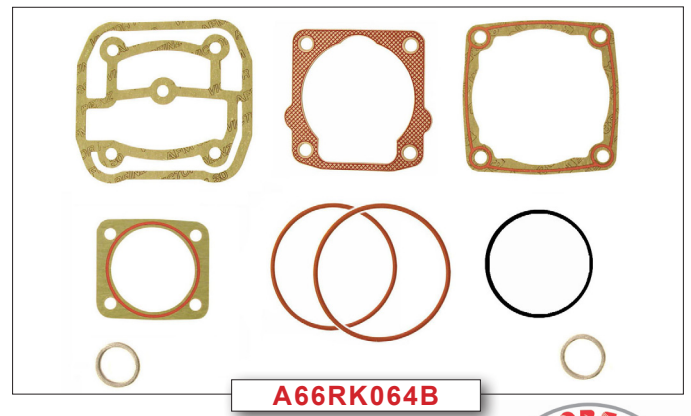
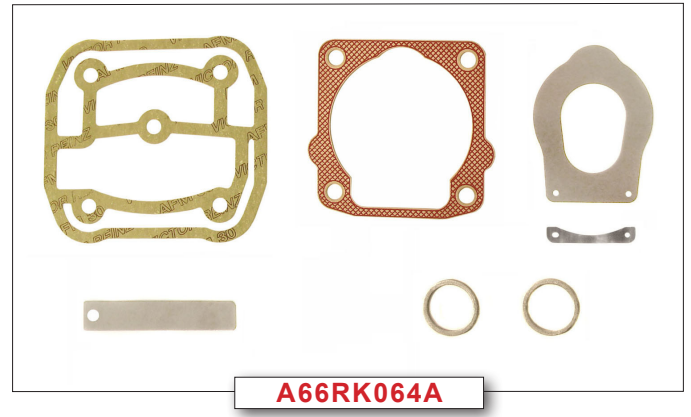
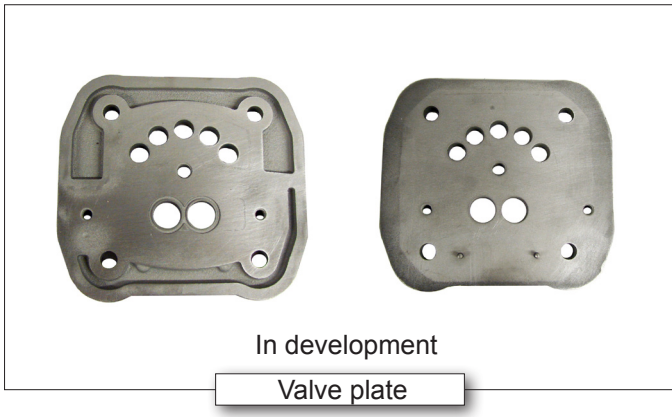
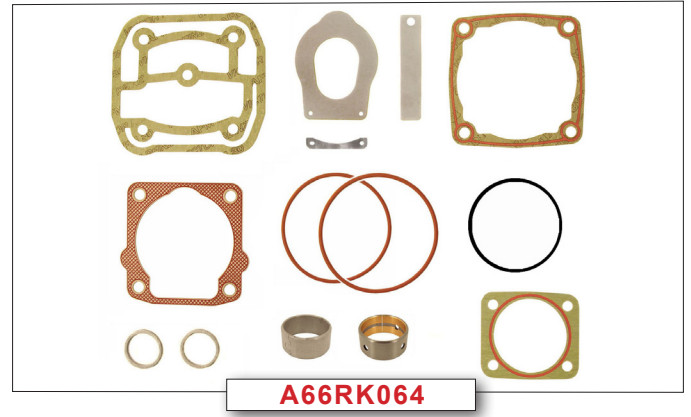

Check our web site for suitability of these and other parts, or contact us directly. Original part numbers are used for reference only. Check all applications. All parts offered are Majorsell brand and may not be of an original supply. Majorsell kit content and ring sets may be different to the original.



LK3515



Crankshaft



Bushes



140016



220014

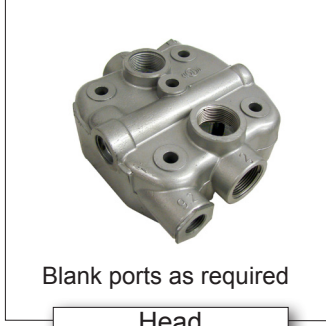

Blank ports as required

Head



140120
4 used

140132
1 used

140138
4 used

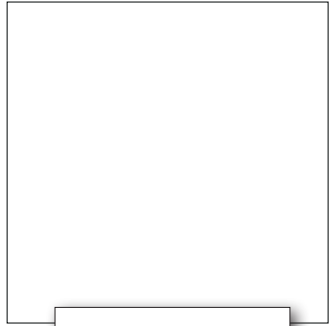
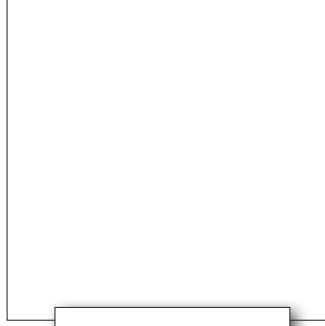

Rear end cover

220139

140124
4 used

140103
4 used



Front flange

220140

140170
6 used

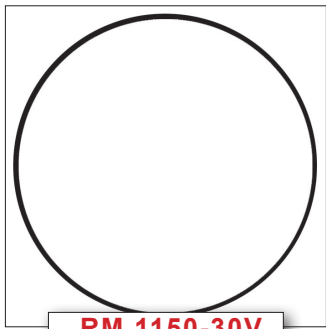

RM 1150-30V

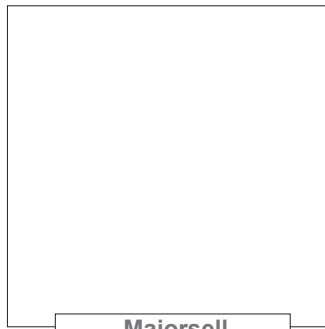

Majorsell

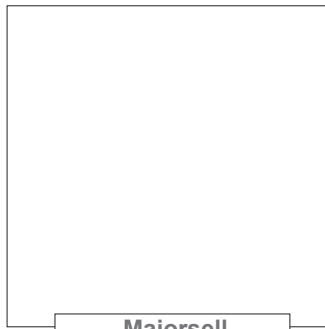

Majorsell

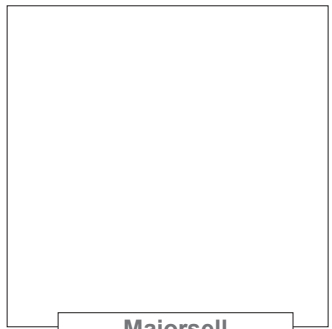

Majorsell



020165



020165K

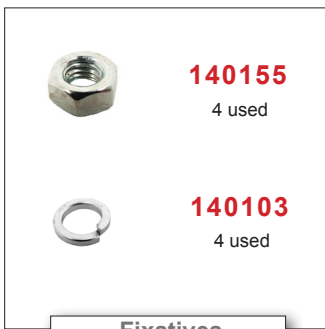

140155
4 used

140103
4 used

Fixatives

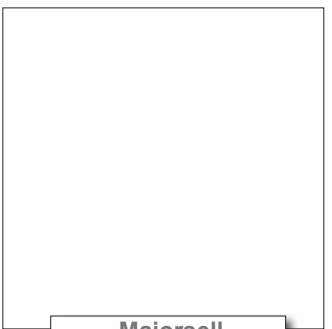

Majorsell

Majorsell Ltd
ENGLAND
sales@majorsell.co.uk
www.majorsell.co.uk

Notes :-

Majorsell parts for :-

LK3802

Principal users :-
Volvo

MAJORSELL
REBUILD

50033219 6772239

66A028R



- 88 mm bore.
- Non-through drive.
- Water cooled
- Weight 11 Kg.
- Flange mount.
- Engine oil lubrication.
- Water ports : M22 x 1.5
- Air ports : M26 x 1.5.

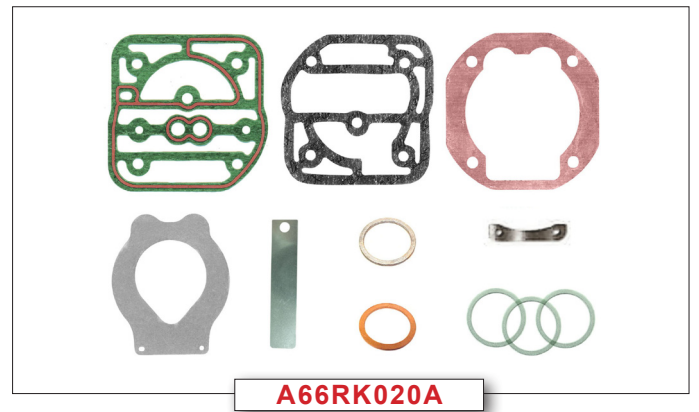
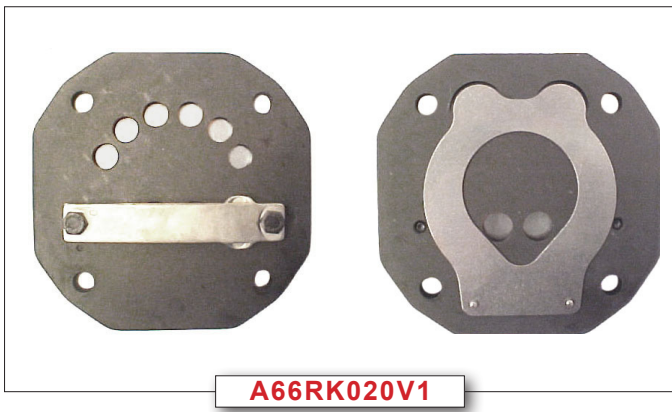
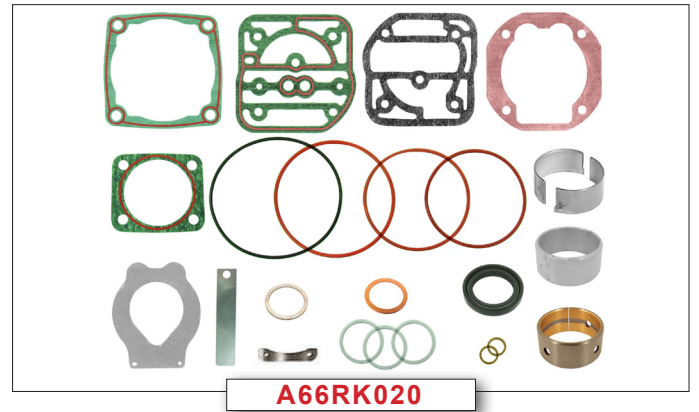

<p>020112 Std A66RK010 020113 +0.50 mm A66RK011 020129 +1.00 mm A66RK015</p>	<p>88 mm 2 x 2.5 mm 1 x 4 mm</p>	
--	--	--

Piston & Rings **Ring set**

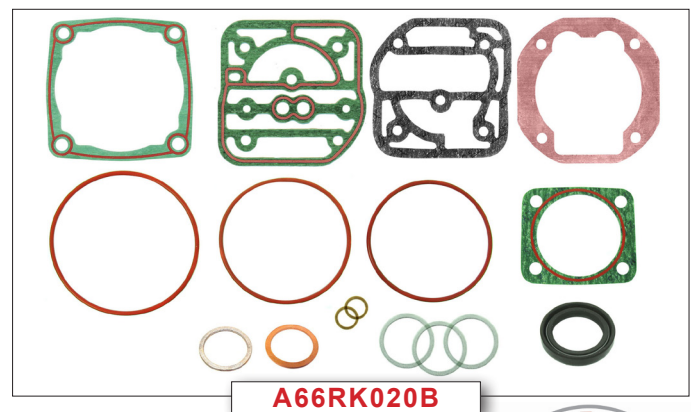

Check our web site for suitability of these and other parts, or contact us directly. Original part numbers are used for reference only. Check all applications. All parts offered are Majorsell brand and may not be of an original supply. Majorsell kit content and ring sets may be different to the original.



LK3802



220138



Bushes



140016



220014



220106



220096

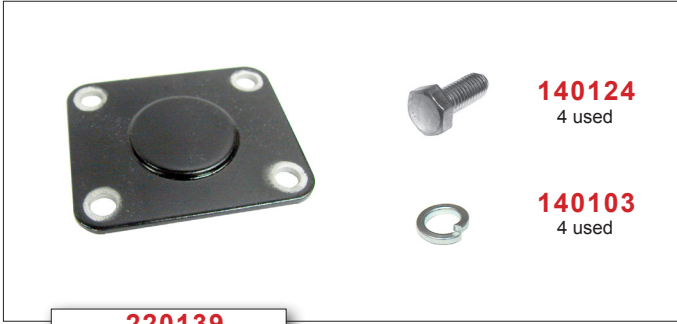

220139



220140

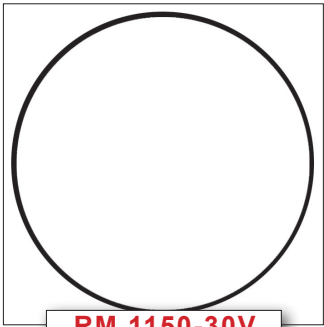

RM 1150-30V

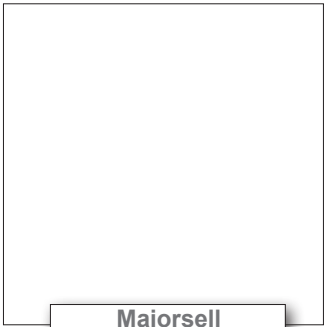

Majorsell

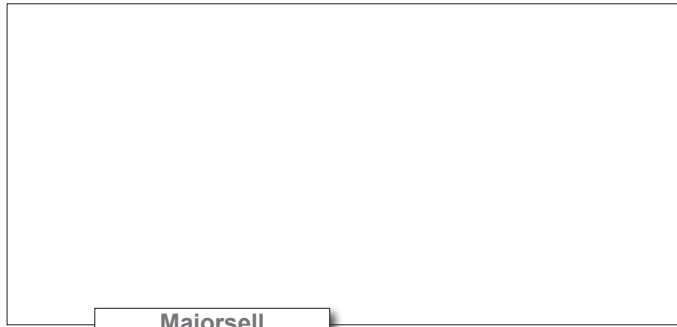

Majorsell



020152



020152K



Fixatives

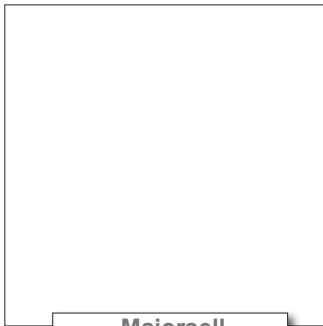

Majorsell

Majorsell Ltd
ENGLAND
sales@majorsell.co.uk
www.majorsell.co.uk

Notes :-

Majorsell parts for :-

LK3826

Principal users :-
MAN

**MAJORSELL
REBUILD**

51541017231

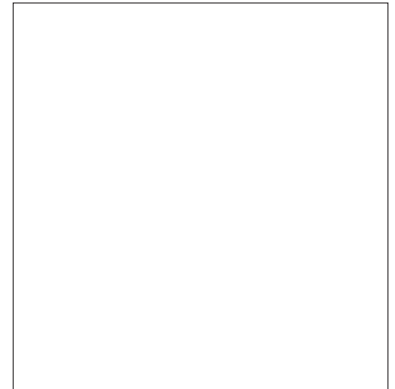

L2000, M2000

- 88 mm bore.
- Through drive.
- Water cooled.
- Weight 9 Kg
- Flange mount.
- Engine oil lubrication.
- Water ports M22 x 1.5.
- Air ports M26 x 1.5



A66RK001C

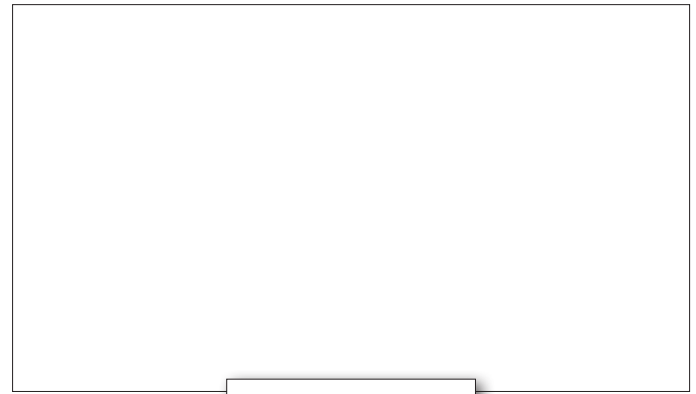

A66RK020V



A66RK020A

020112	Std	A66RK010
020113	+0.50 mm	A66RK011
020129	+1.00 mm	A66RK015



Piston & Rings

88 mm

2 x 2.5 mm

1 x 4 mm



Ring set

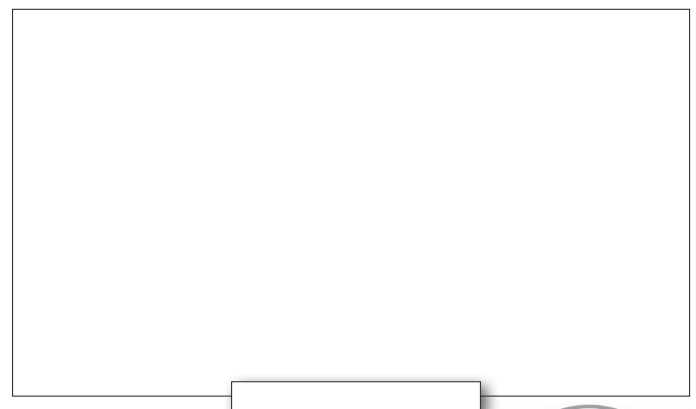

Check our web site for suitability of these and other parts, or contact us directly. Original part numbers are used for reference only. Check all applications. All parts offered are Majorsell brand and may not be of an original supply. Majorsell kit content and ring sets may be different to the original.



LK3826

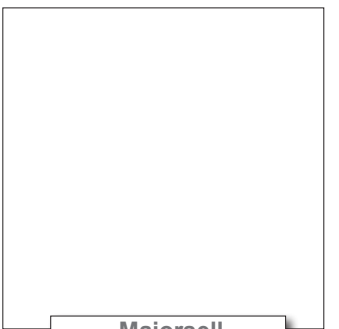
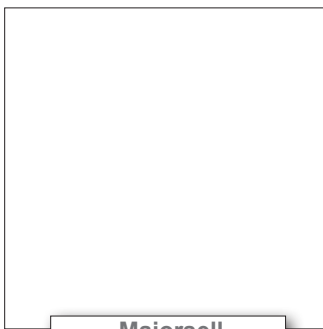
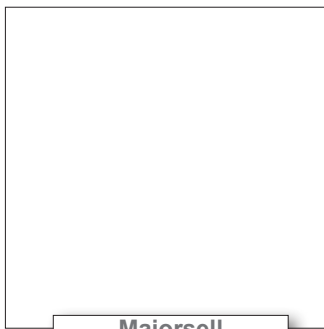
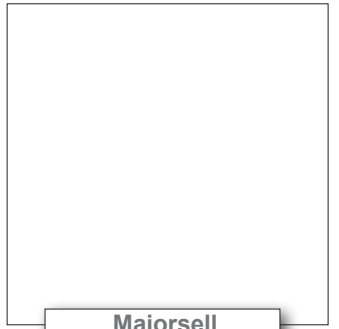
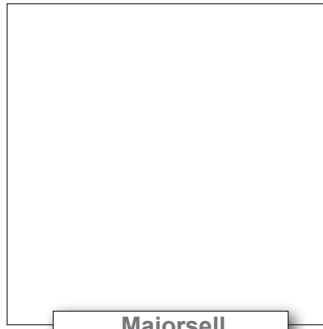
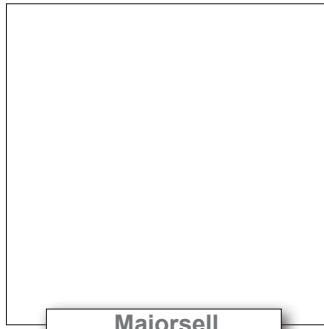
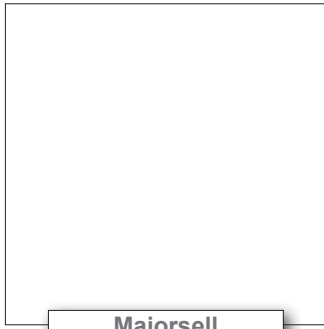
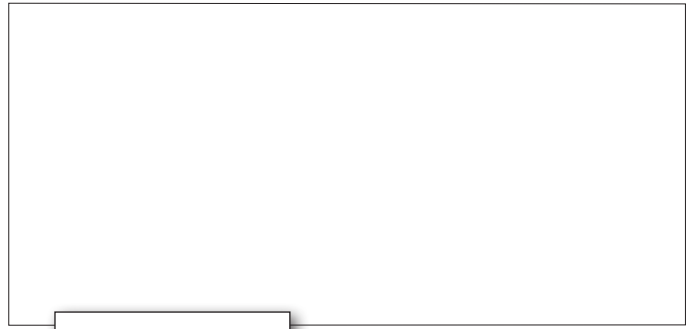
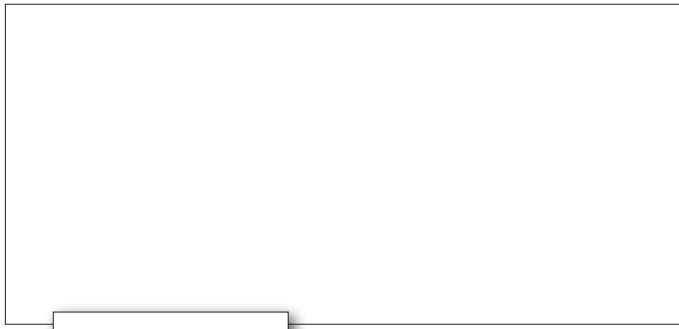
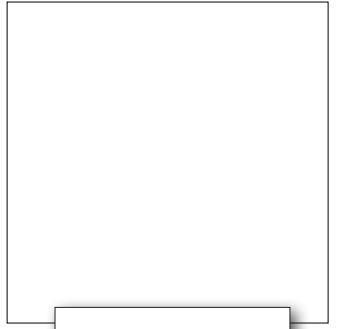
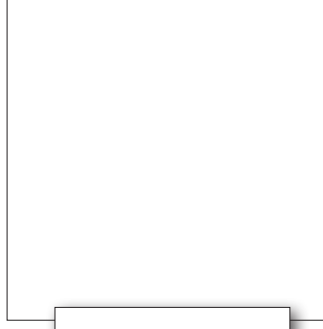
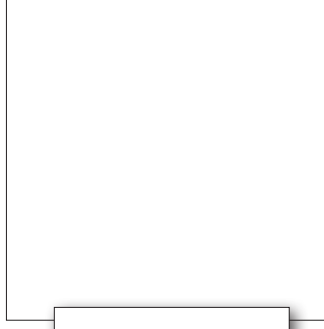
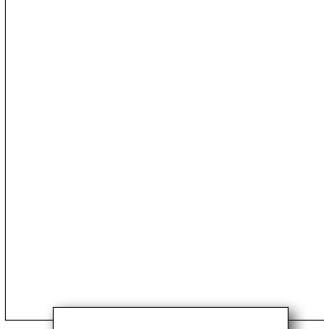
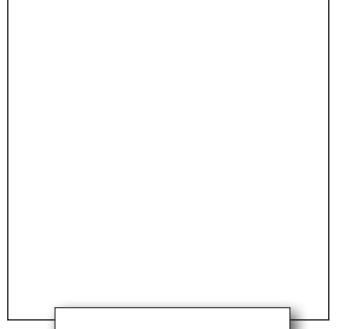
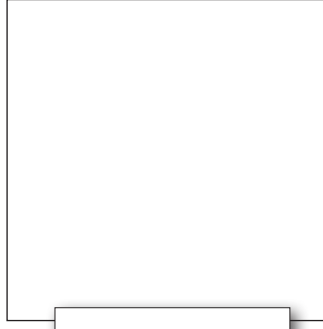
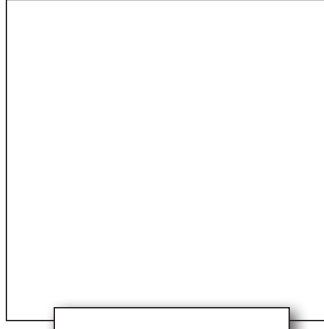
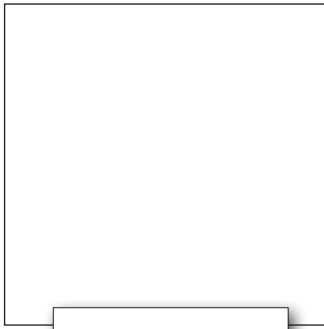

Majorsell Ltd
ENGLAND
sales@majorsell.co.uk
www.majorsell.co.uk

Notes :-

Majorsell parts for :-

LK3832

Principal users :-
Volvo

MAJORSELL
REBUILD

66A066R

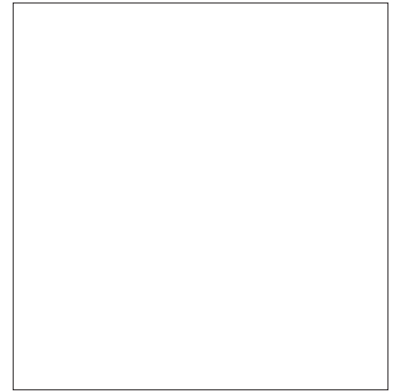

Used on FM

- 88 mm bore.
- Through drive.
- Water cooled.
- Weight -

- Base mount.
- Engine oil lubrication.
- Water ports M22 x 1.5.
- Air ports M26 x 1.5



A66RK001C

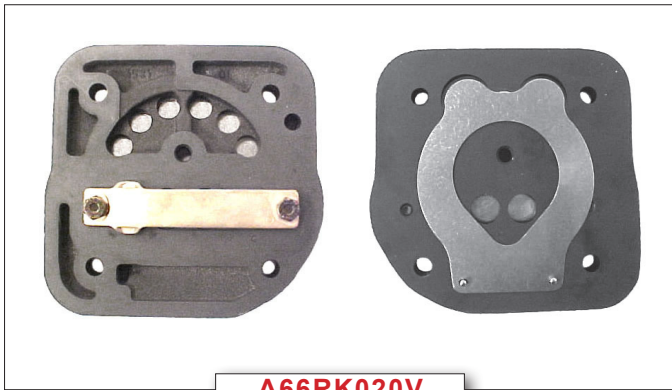
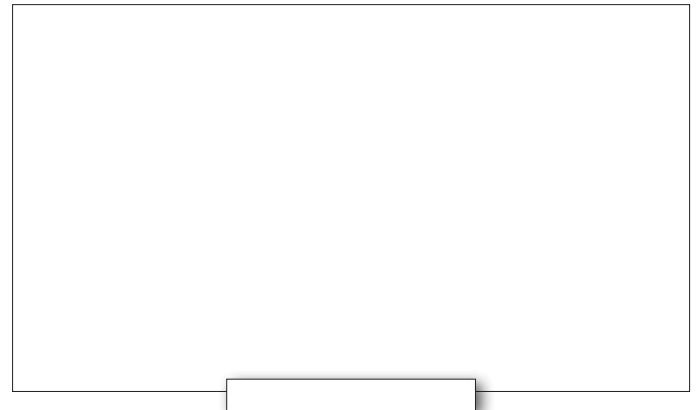

A66RK020V



A66RK020A



Piston & Rings

Ring set

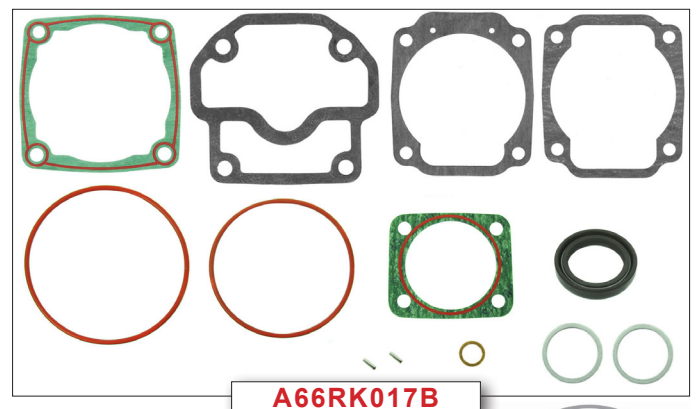

A66RK017B

Check our web site for suitability of these and other parts, or contact us directly.
Original part numbers are used for reference only. Check all applications.
All parts offered are Majorsell brand and may not be of an original supply.
Majorsell kit content and ring sets may be different to the original.



LK3832

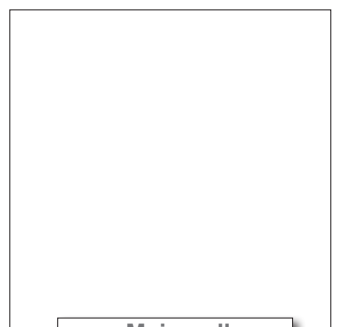
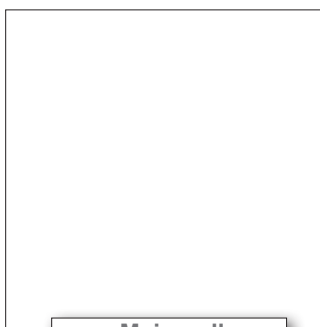
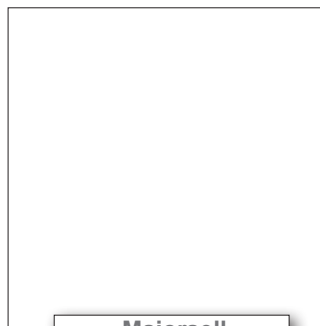
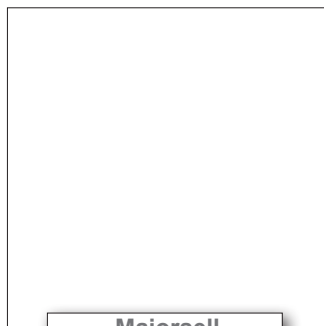
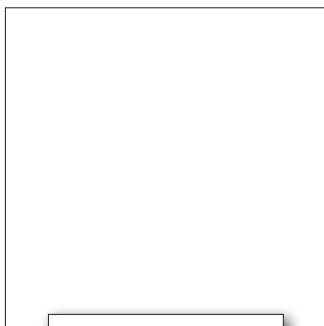
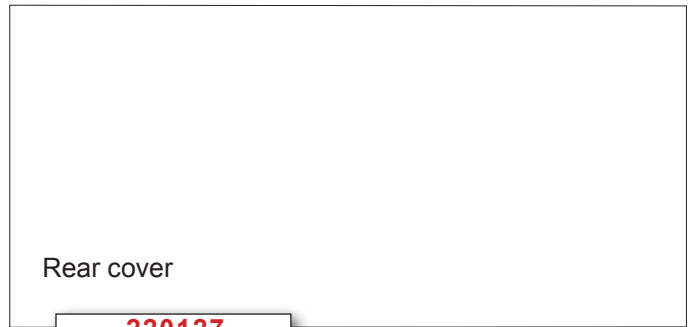
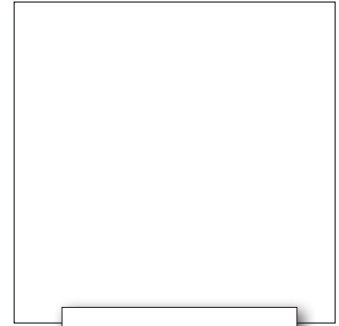
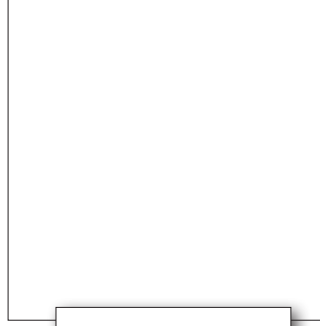
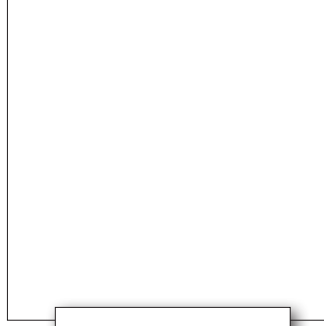

Majorsell Ltd
ENGLAND
sales@majorsell.co.uk
www.majorsell.co.uk

Notes :-

Majorsell parts for :-

LK3834

Principal users :-
Perkins

**MAJORSELL
REBUILD**

2488A291

66A071R



- 80 mm bore.
- Non-through drive.
- Water cooled.
- Weight 10 Kg

- Flange mount.
- Engine oil lubrication.
- Water ports M16 x 1.5.
- Air inlet : M26 x 1.5, delivery : M22 x 1.5 mm

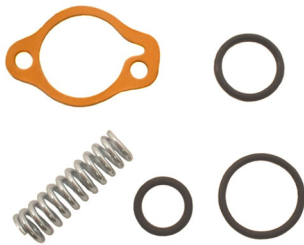

A66RK042D

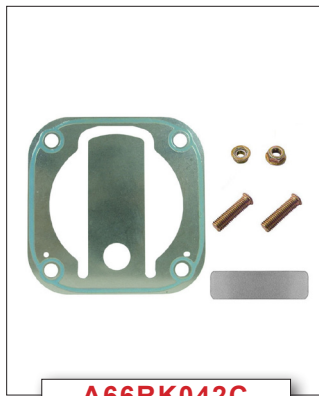

A66RK042C

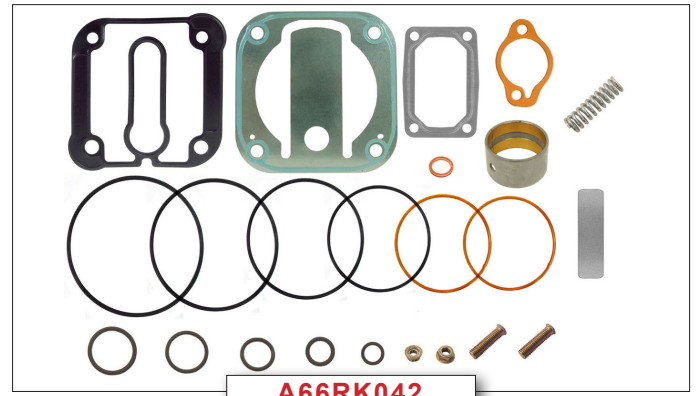

A66RK042



A66RK042V



A66RK042A

020154	Std	A66RK049
020155	+0.50 mm	A66RK050
020156	+1.00 mm	A66RK051



Piston & Rings

80 mm
2 x 2.5 mm
1 x 4 mm



Ring set

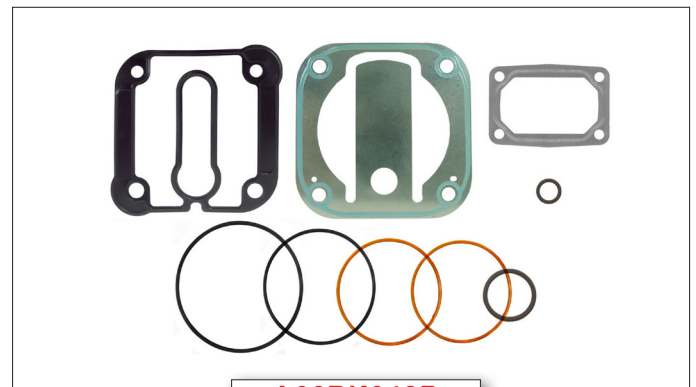

A66RK042B

Check our web site for suitability of these and other parts, or contact us directly.
Original part numbers are used for reference only. Check all applications.
All parts offered are Majorsell brand and may not be of an original supply.
Majorsell kit content and ring sets may be different to the original.



LK3834



Crankshaft



Front

050186



140141



220044

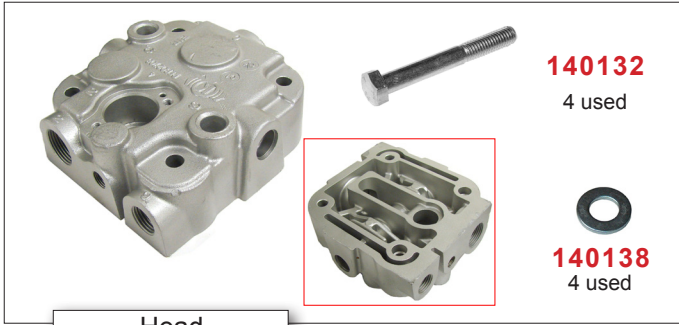

Head

140132
4 used

140138
4 used

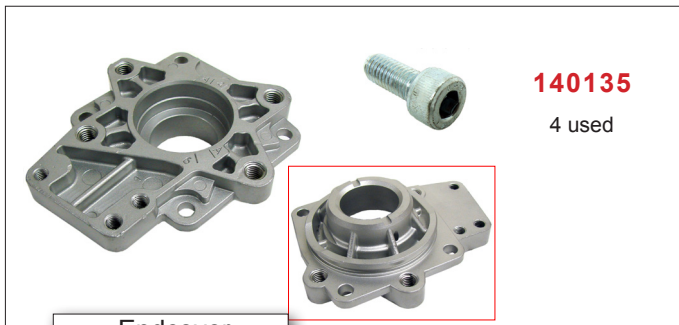
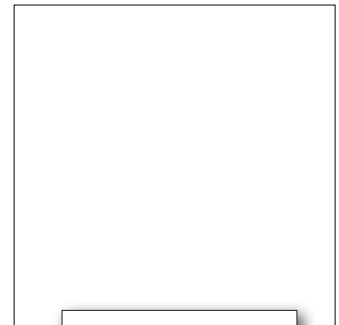
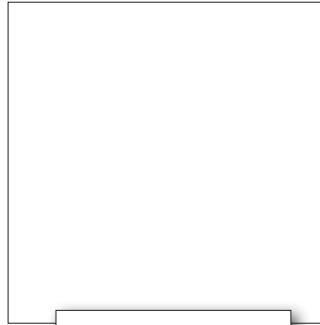

Endcover

140135
4 used



Sump

140134
4 used

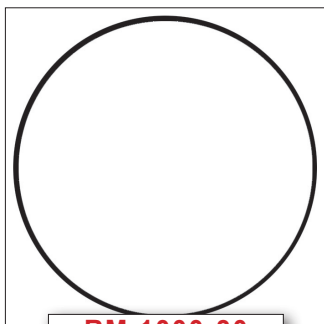

RM 1000-30

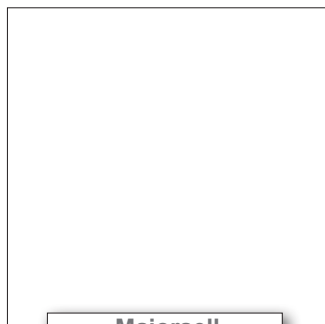

Majorsell

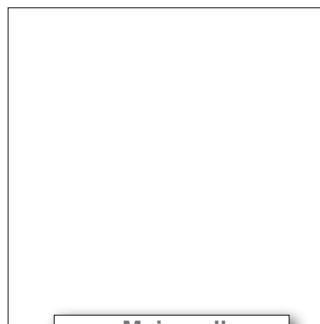

Majorsell

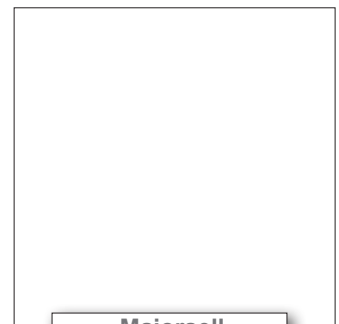

Majorsell

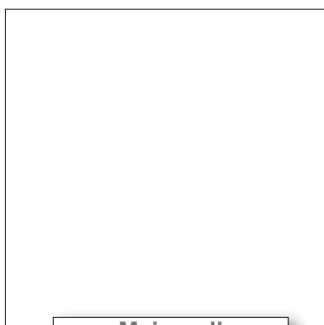

Majorsell

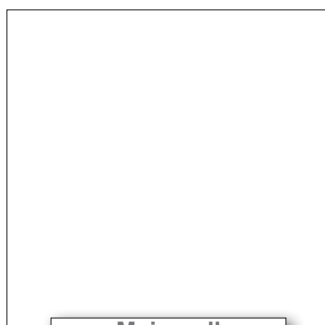

Majorsell

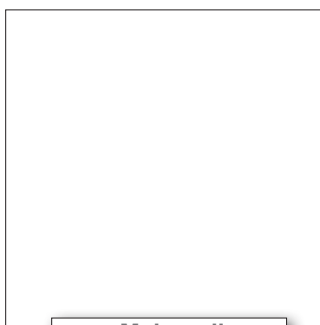

Majorsell

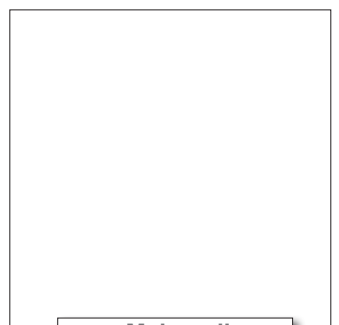

Majorsell

Majorsell parts for :-

LK3837

Principal users :-
Perkins

2488A294

MAJORSELL
REBUILD

66A073R



- 80 mm bore.
- Through drive.
- Water cooled.
- Weight 10 Kg.
- Flange mount.
- Engine oil lubrication.
- Water ports : M16 x 1.5.
- Air ports : M26 x1.5.

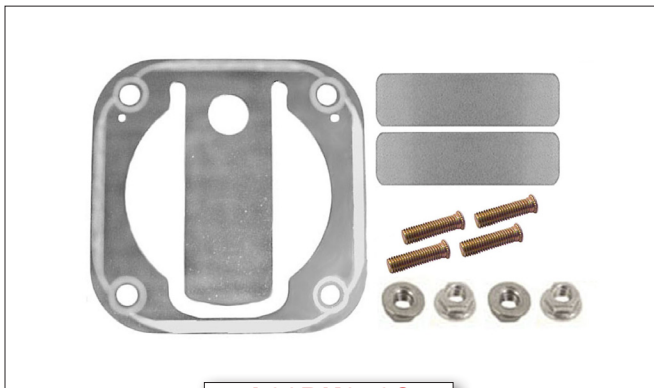

A66RK046C

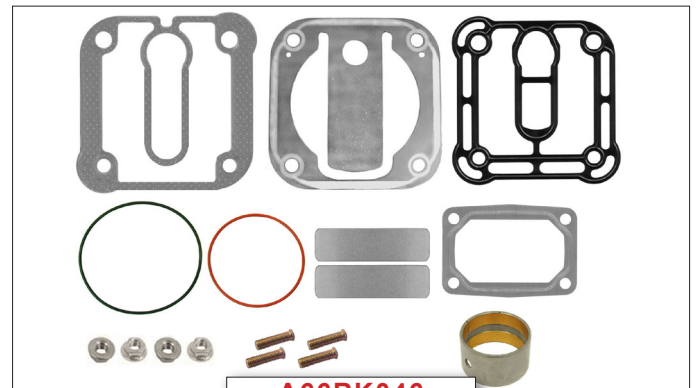

A66RK046



A66RK046V



A66RK046A

020154	Std	A66RK049
020155	+0.50 mm	A66RK050
020156	+1.00 mm	A66RK051

	80 mm	
	2 x 2.5 mm	
	1 x 4 mm	

Piston & Rings	Ring set
---------------------------	-----------------

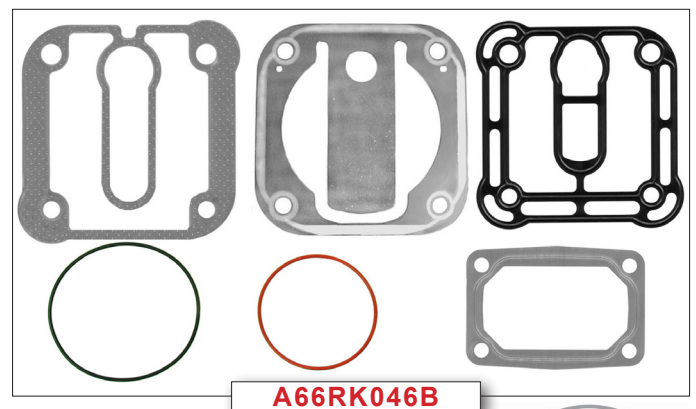

A66RK046B

Check our web site for suitability of these and other parts, or contact us directly. Original part numbers are used for reference only. Check all applications. All parts offered are Majorsell brand and may not be of an original supply. Majorsell kit content and ring sets may be different to the original.



LK3837



Crankshaft



Bushes



140141



220044

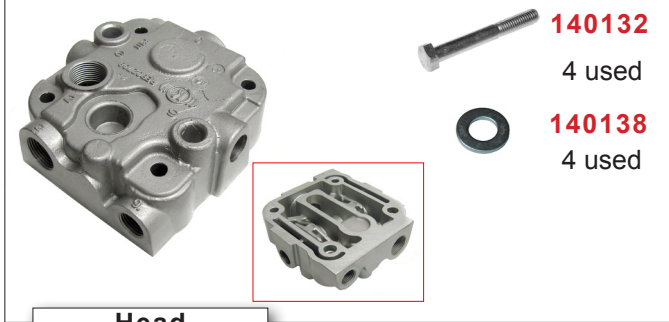

Head

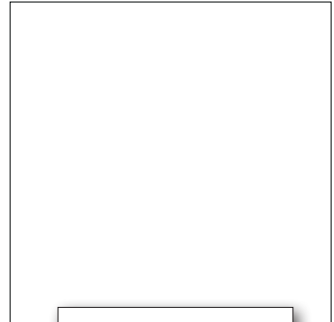
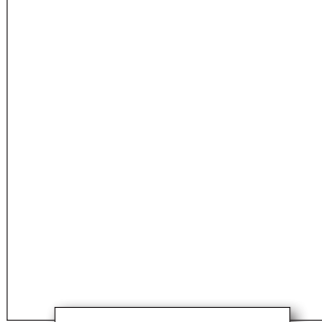

Rear cover



Sump cover

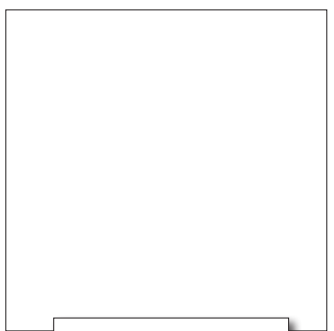
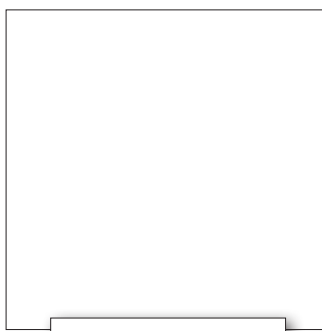
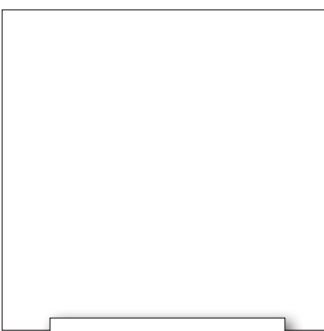
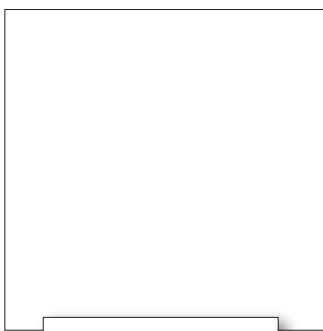
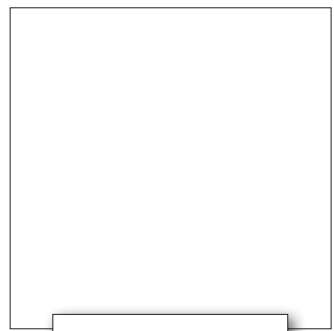
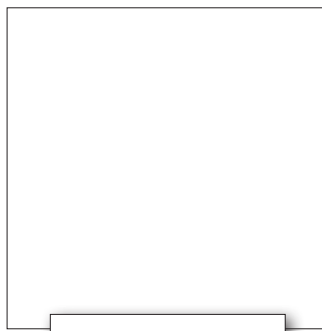
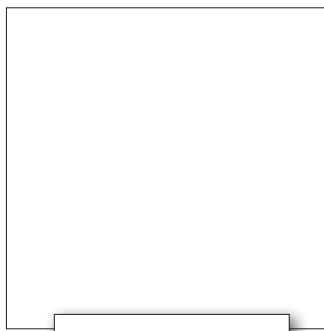
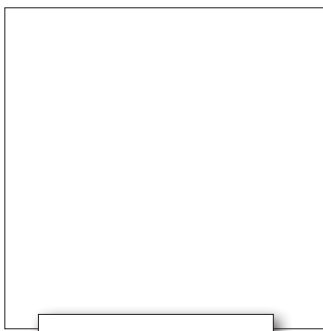

Majorsell parts for :-

LK3904

Principal users :-
Iveco

**MAJORSELL
REBUILD**

01174474, 01173720, 42522673

66A114R



- 88 mm bore.
- Non through drive
- Water cooled.
- Weight 10 Kg.
- Flange mount.
- Engine oil lubrication.
- Water ports M14 x 1.5 mm
- Air ports M26 x 1.5.

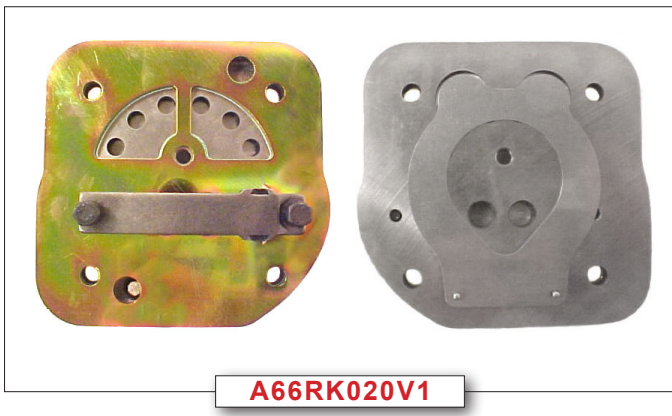
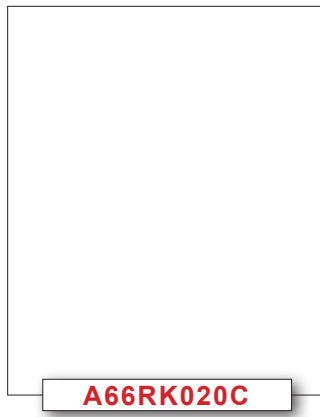

<p>020112 Std A66RK010 020113 +0.50 mm A66RK011 020129 +1.00 mm A66RK015</p>	<p>88 mm</p> <p>2 x 2.5, 1 x 4 mm</p>	
--	---------------------------------------	--

Piston & Rings

Ring set



Check our web site for suitability of these and other parts, or contact us directly.
Original part numbers are used for reference only. Check all applications.
All parts offered are Majorsell brand and may not be of an original supply.
Majorsell kit content and ring sets may be different to the original.



LK3904

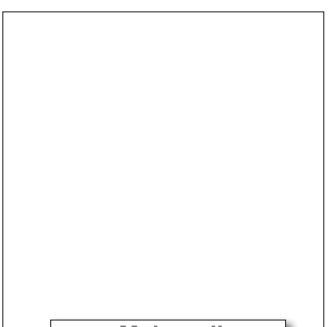
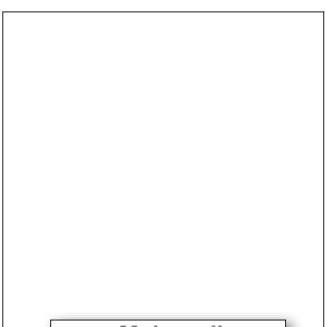
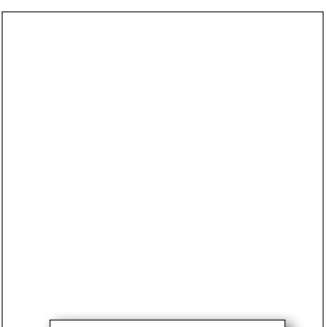
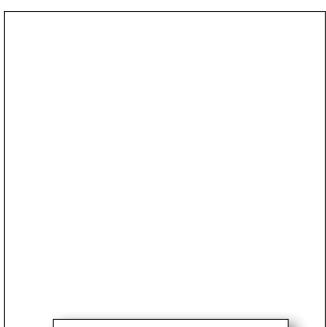
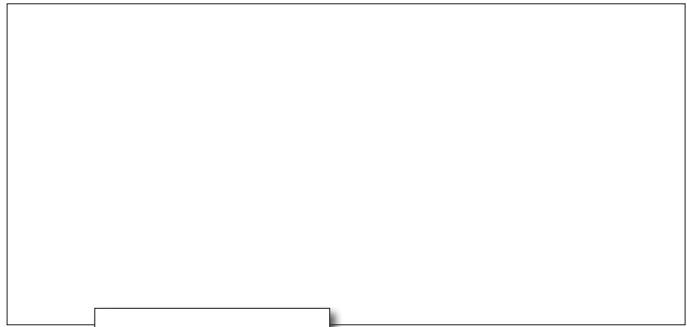
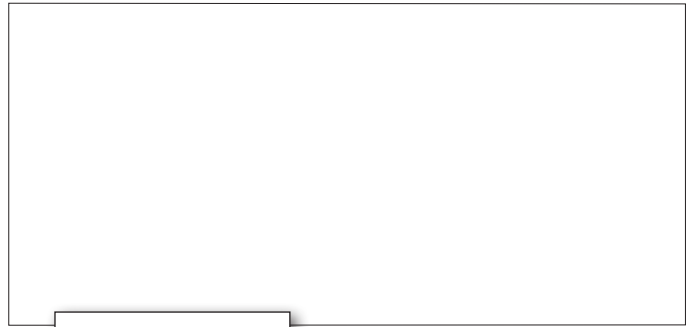
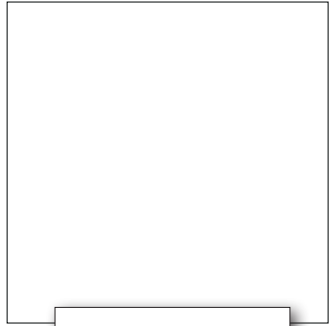
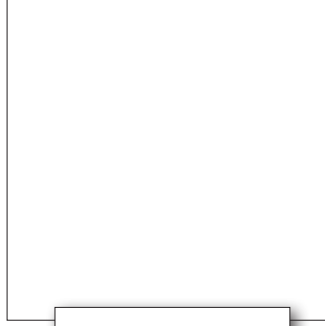
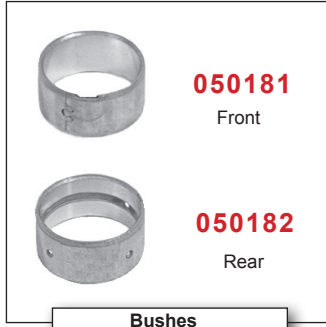

Majorsell parts for :-

LK3917

Principal users :-

MAJORSELL
REBUILD

66A111R

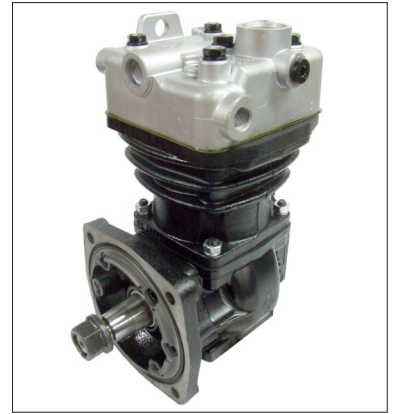

- 88 mm bore.
- Non through drive
- Water cooled.
- Weight 10 Kg.
- Flange mount.
- Engine oil lubrication.
- Water ports M16 x 1.5 mm
- Air inlet : Flange, Delivery : M18 x 1.5 mm.

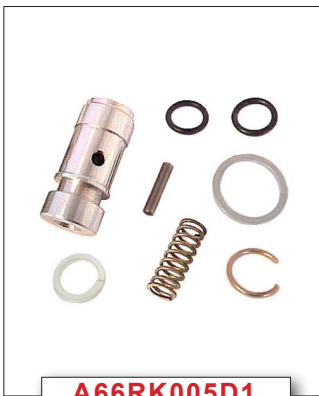

A66RK005D1



A66RK047C

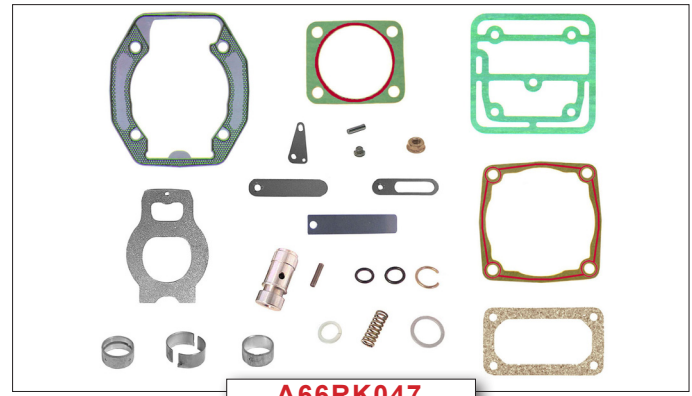

A66RK047



A66RK047V



A66RK047A



Piston & Rings

Ring set

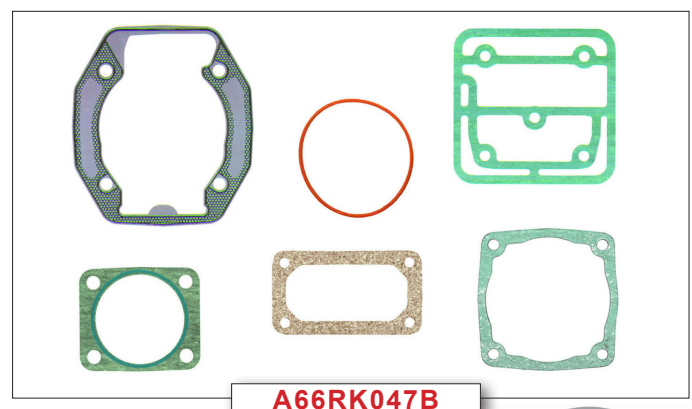

A66RK047B

Check our web site for suitability of these and other parts, or contact us directly.
Original part numbers are used for reference only. Check all applications.
All parts offered are Majorsell brand and may not be of an original supply.
Majorsell kit content and ring sets may be different to the original.



LK3917



Crankshaft



Bushes



140016



220014



Head

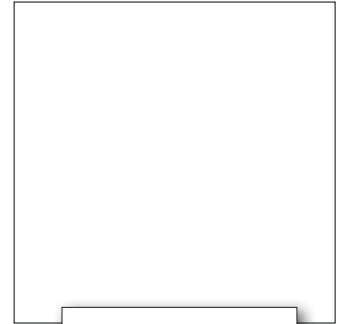
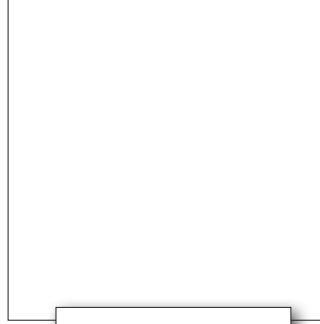

Front Cover



Rear Cover

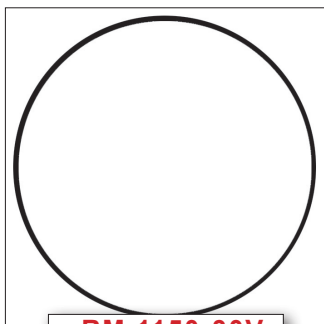

RM 1150-30V

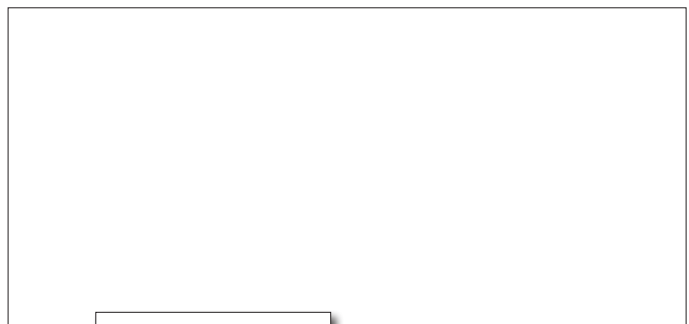
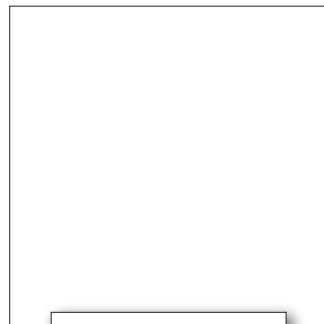

020170

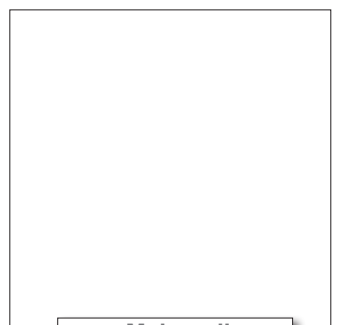
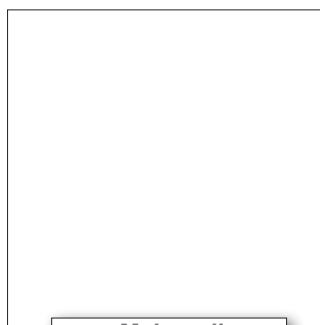

Majorsell

Majorsell

Majorsell Ltd
 ENGLAND
sales@majorsell.co.uk
www.majorsell.co.uk

Notes :-

Majorsell parts for :-

LK3933 - LK3941

Principal users :-
Iveco

MAJORSELL
REBUILD

LK3933	1179342
LK3941	1179584

66A127R
66A119R



66A127R

- 88 mm bore.
- LK3933 through drive
- Engine oil lubrication.
- Air cooled cylinder.
- Weight 13 Kg.
- Flange mount.
- LK3941 non-through drive.
- Oil cooled head
- Oil ports M14 x 1.5
- Air ports M26 x 1.5.



A66RK001C

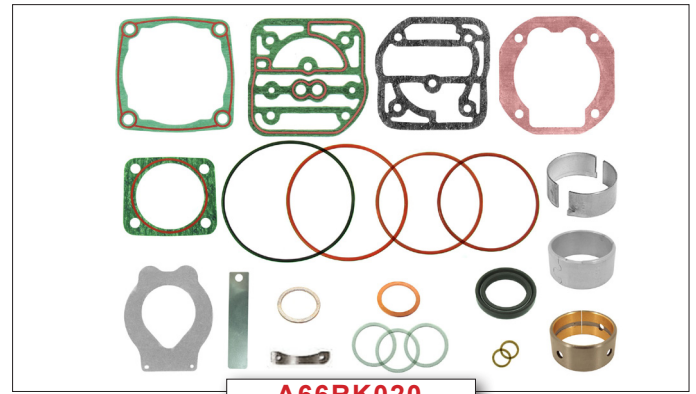

A66RK020



A66RK020V1



A66RK020A

020112	Std	A66RK010
020113	+0.50 mm	A66RK011
020129	+1.00 mm	A66RK015

88 mm
2 x 2.5 mm
1 x 4 mm

Piston & Rings

Ring set

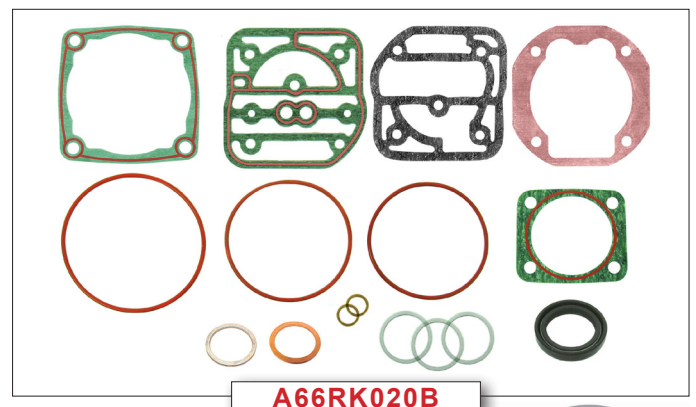

A66RK020B

Check our web site for suitability of these and other parts, or contact us directly. Original part numbers are used for reference only. Check all applications. All parts offered are Majorsell brand and may not be of an original supply. Majorsell kit content and ring sets may be different to the original.



LK3933 - LK3941



Crankshaft



Bushes



140016



050090
1 pr.

220052

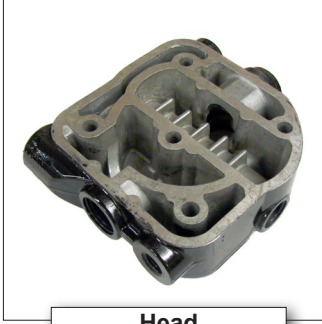

Head



140143
4 used

140132
1 used

140138
4 used

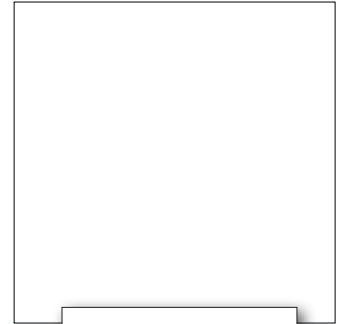
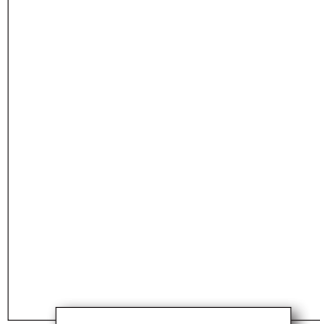

LK3933

End cover



140135
4 used



LK3933 &
LK3941

Front flange



140170
6 used



LK3941

End cover



140124
4 used



140138
4 used

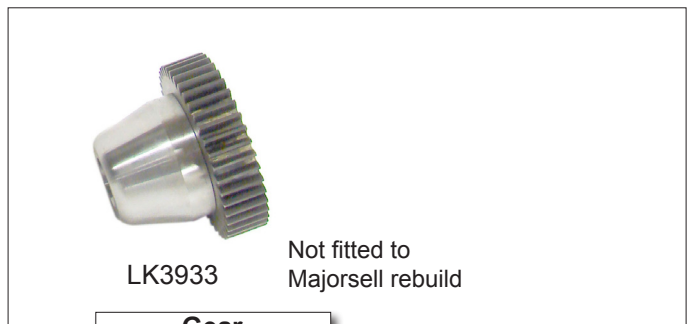

LK3933

Not fitted to
Majorsell rebuild

Gear

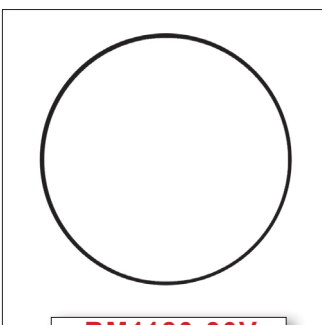

RM1180-30V

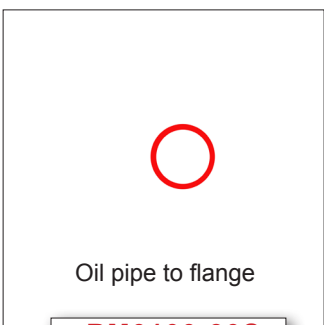

Oil pipe to flange

RM0100-30S

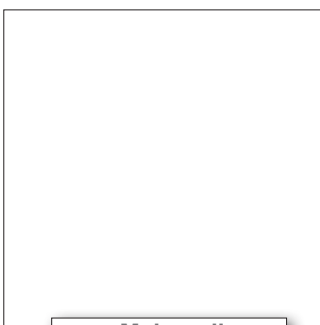

Majorsell

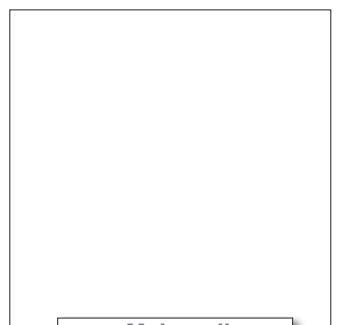

Majorsell

Majorsell Ltd
ENGLAND
sales@majorsell.co.uk
www.majorsell.co.uk

Notes :- The same crankshaft, conn rod and head fits both LK3933 & LK3941.

Majorsell parts for :-

LK3943 - LK3944

Principal users :-
MAN

**MAJORSELL
REBUILD**

LK3943

LK3944 51541017214

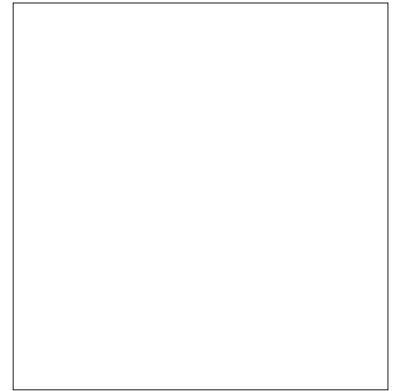

- 88 mm bore.
- Non through drive.
- Water cooled.
- Weight 10 Kg.
- Flange mount.
- Engine oil lubrication.
- Air ports M22 x 1.5
- Water ports M22 x 1.5.



A66RK001C

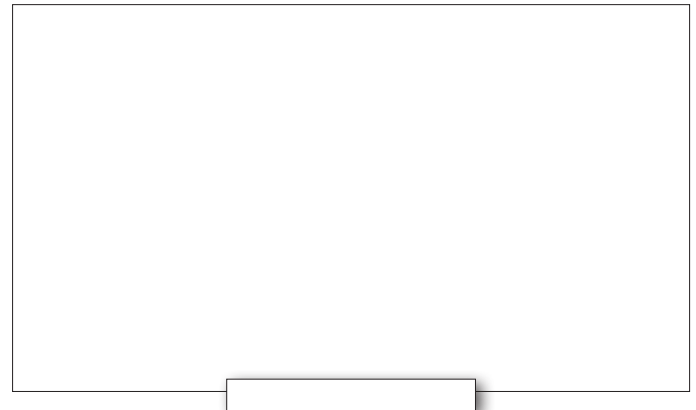

A66RK020V



A66RK020A

<p>020112 Std A66RK010 020113 +0.50 mm A66RK011 020129 +1.00 mm A66RK015</p>	<p>88 mm</p> <p>2 x 2.5, 1 x 4 mm</p>	
--	---------------------------------------	--

Piston & Rings

Ring set

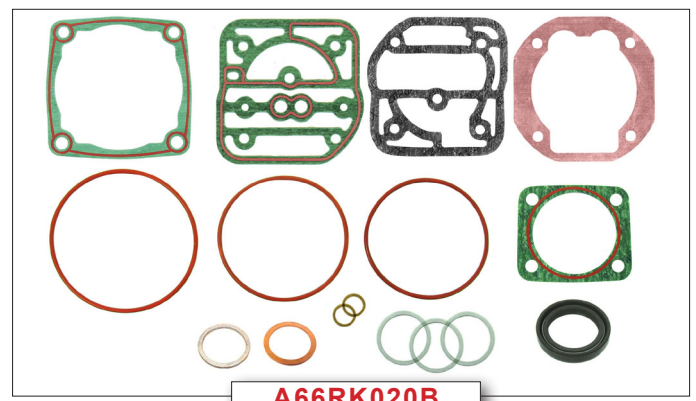

A66RK020B

Check our web site for suitability of these and other parts, or contact us directly.
 Original part numbers are used for reference only. Check all applications.
 All parts offered are Majorsell brand and may not be of an original supply.
 Majorsell kit content and ring sets may be different to the original.



LK3943 - LK3944

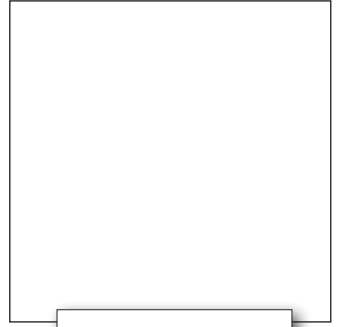
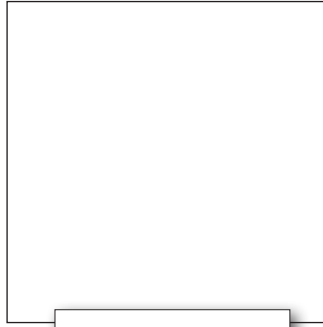
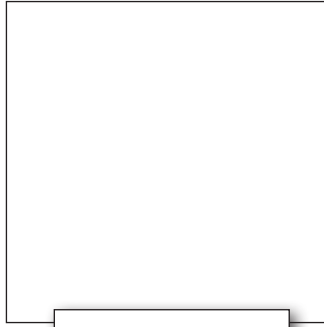
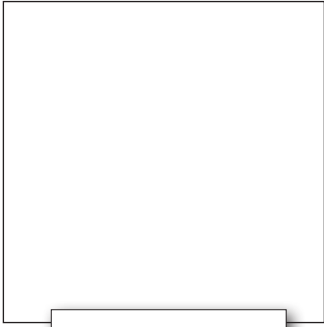

220096

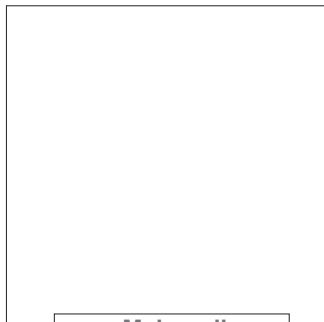
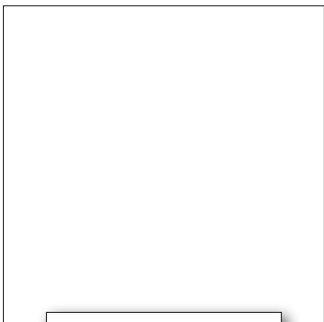
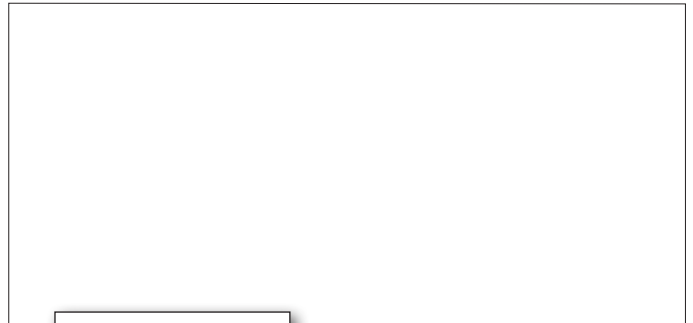
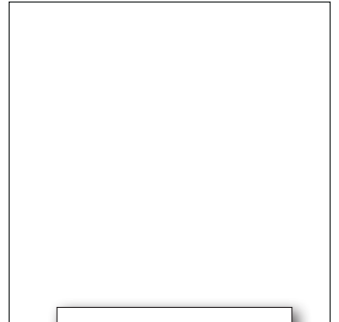
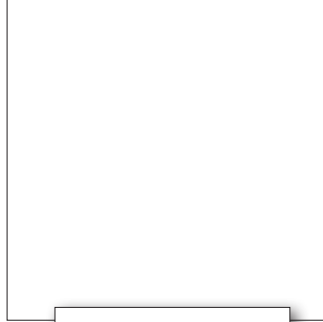
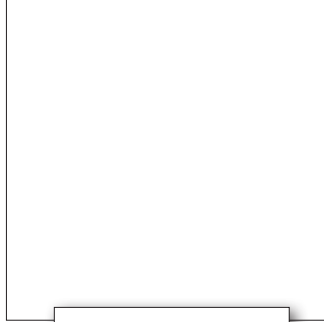

Majorsell

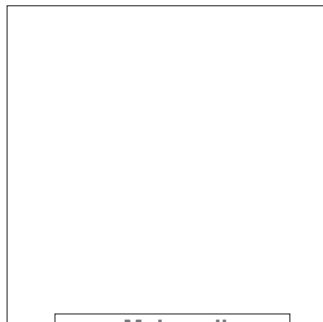

Majorsell

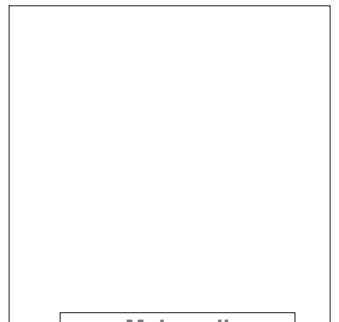

Majorsell



020161



020161K

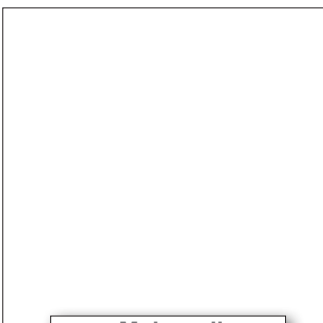

Majorsell

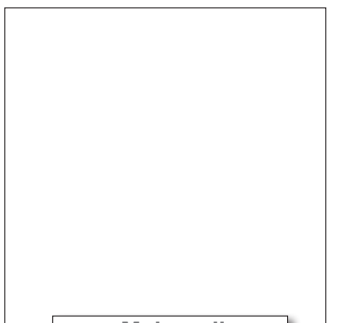

Majorsell

Majorsell Ltd
ENGLAND
sales@majorsell.co.uk
www.majorsell.co.uk

Notes :-

Majorsell parts for :-

LK3950 - LK3954

Principal users :-
MAN

**MAJORSELL
REBUILD**

LK3950	81541146019, 51541017216. Flange mount / non-through drive.
LK3954	51541017217. Base mount / through drive.

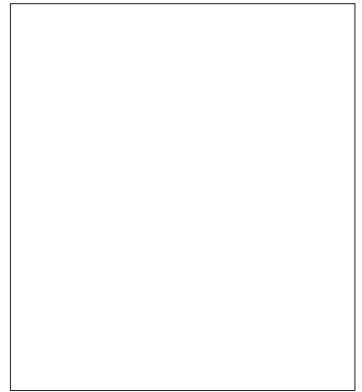

LK3950 fits L2000, M2000.

- 88 mm bore.
- Drive - see above.
- Water cooled.
- Weight 10 Kg.
- Mount - see above.
- Engine oil lubrication.
- Water ports M22 x 1.5
- Air ports M26 x 1.5.

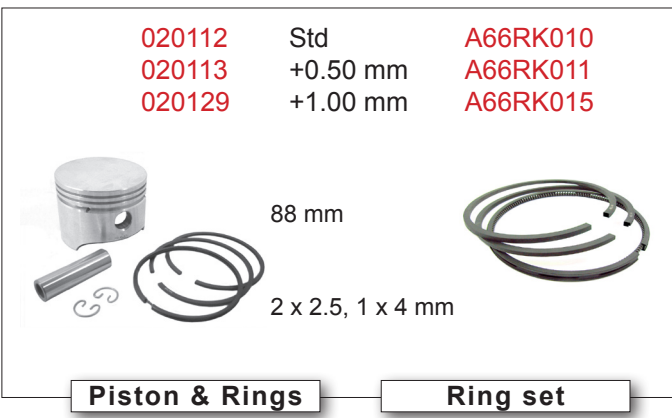
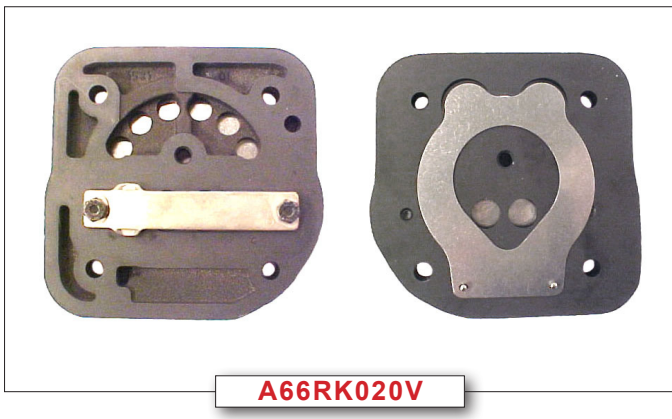
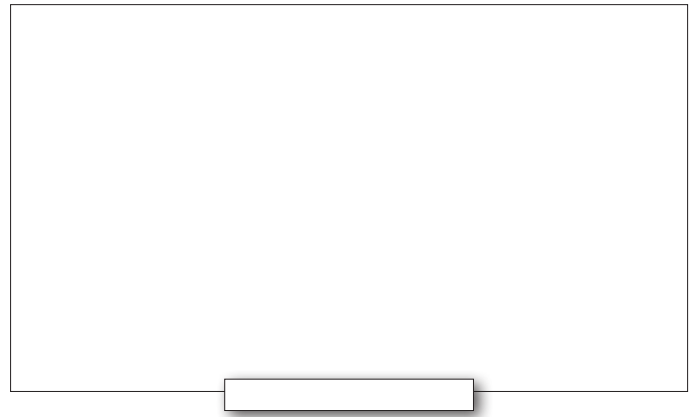

Check our web site for suitability of these and other parts, or contact us directly.
Original part numbers are used for reference only. Check all applications.
All parts offered are Majorsell brand and may not be of an original supply.
Majorsell kit content and ring sets may be different to the original.



LK3950 - LK3954

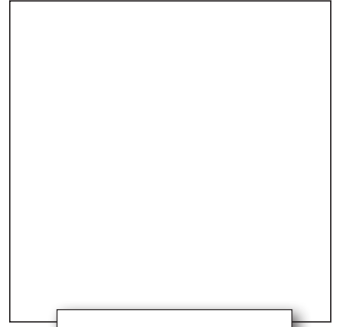
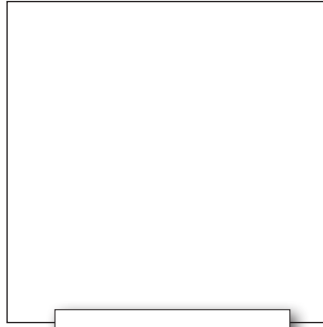
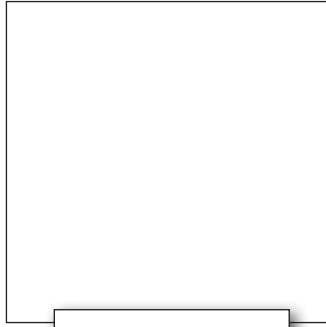
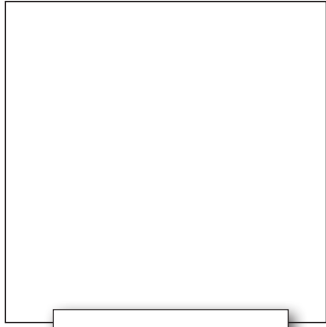

220106

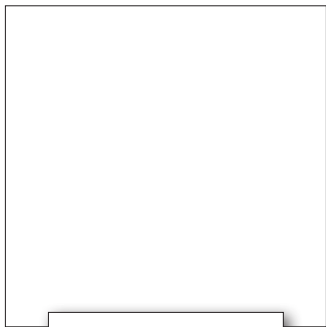
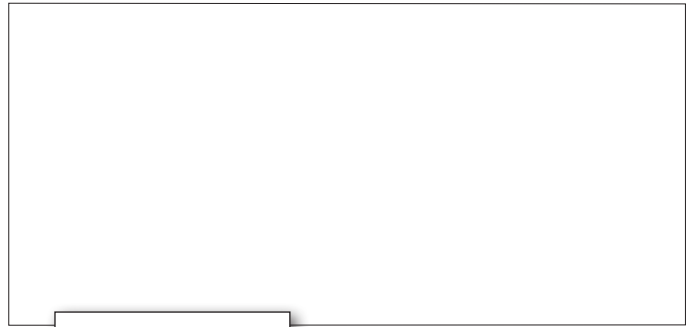
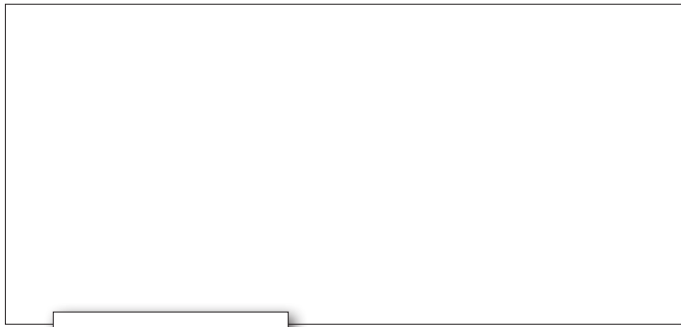
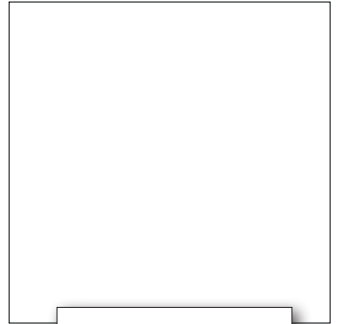
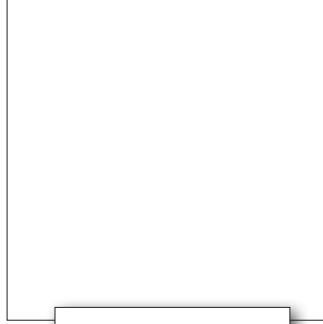
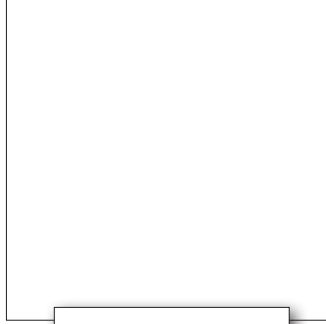

Majorsell



Majorsell

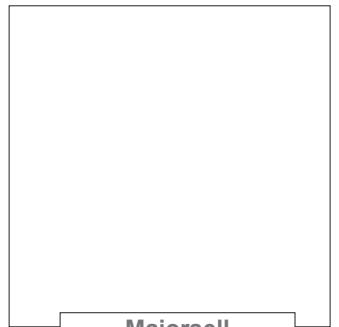

Majorsell



020161



020161K

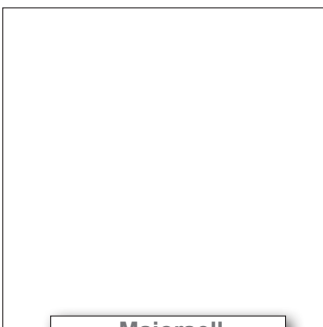

Majorsell



Majorsell

Majorsell Ltd
ENGLAND
sales@majorsell.co.uk
www.majorsell.co.uk

Notes :-

Majorsell parts for :-

LK3959

Principal users :-
Iveco

MAJORSELL

04222619

66A125R



- 88 mm bore.
- Through drive
- Water cooled.
- Weight 11 Kg.
- Flange mount.
- Engine oil lubrication.
- Water ports M16 x 1.5 mm
- Air inlet ports : Manifold, Delivery ports : M18 x 1.5 mm.

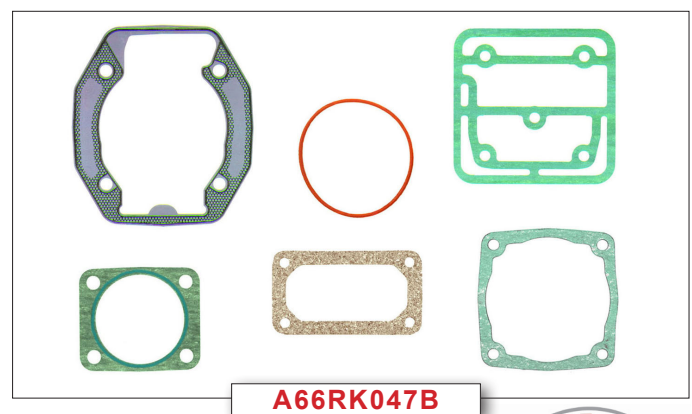
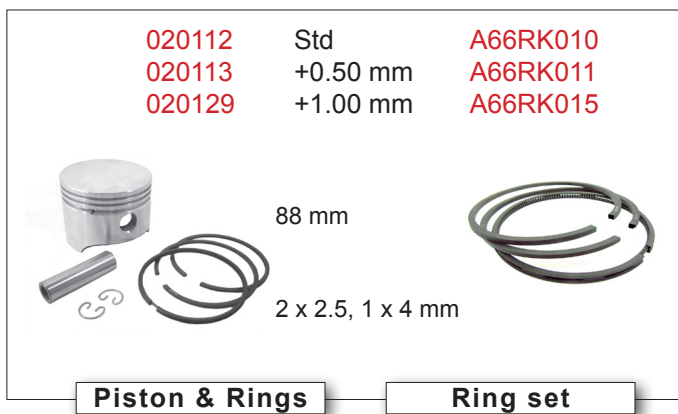
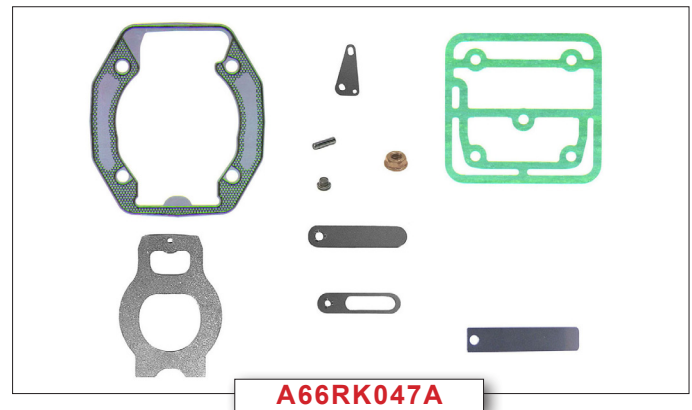
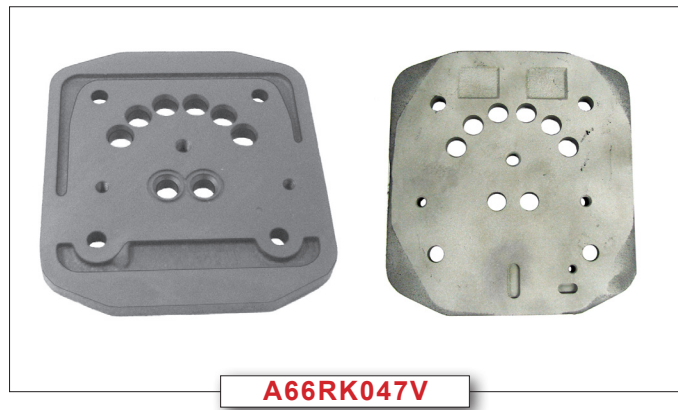
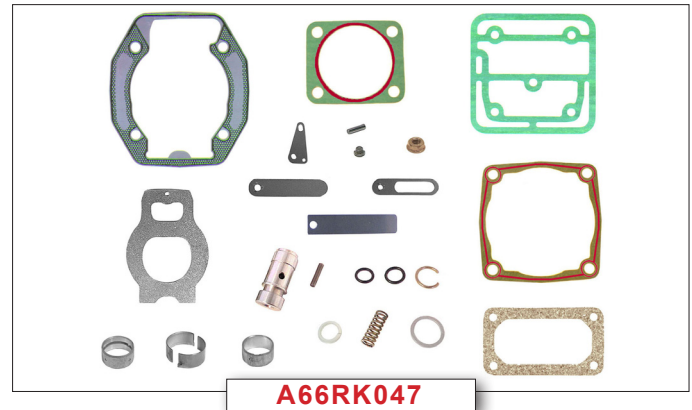
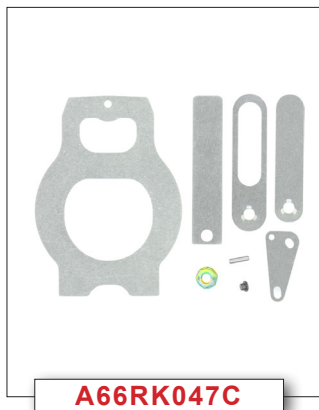

Check our web site for suitability of these and other parts, or contact us directly. Original part numbers are used for reference only. Check all applications. All parts offered are Majorsell brand and may not be of an original supply. Majorsell kit content and ring sets may be different to the original.



LK3959



Crankshaft



050181

Front

050182

Rear

Bushes



140016



220014

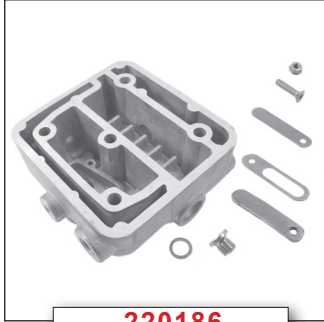

220186



140143

4 used

140132

1 used

140138

4 used

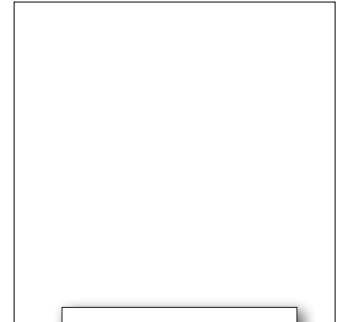
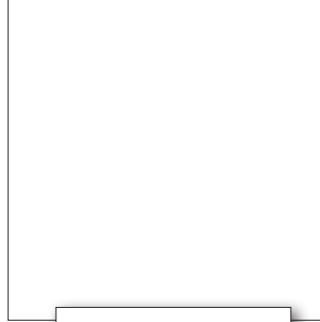

End Cover

140103

4 used

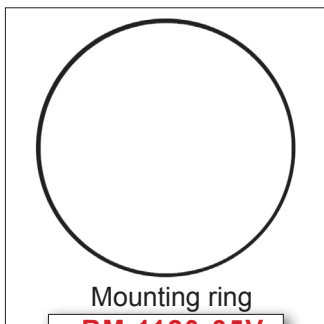
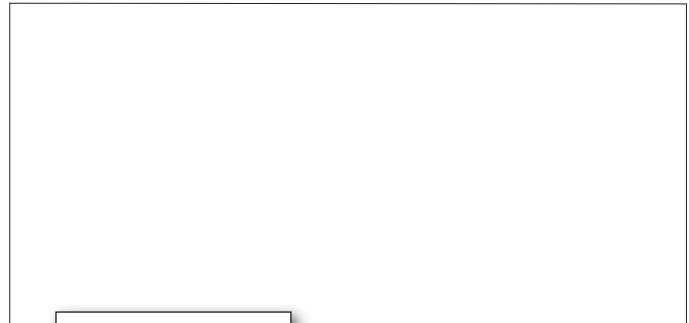

Mounting ring

RM 1120-35V

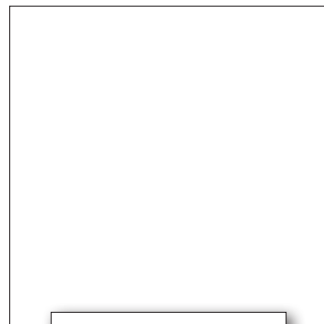

Majorsell



020170



140155

4 used

140103

4 used

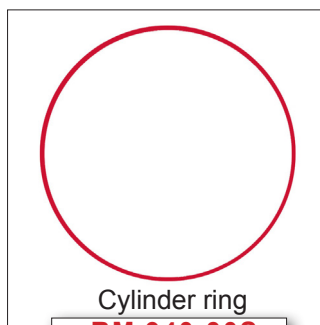

Cylinder ring

RM 940-30S

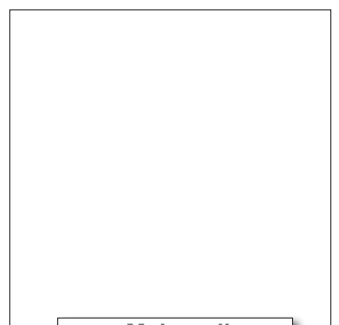

Majorsell

Majorsell Ltd
 ENGLAND
sales@majorsell.co.uk
www.majorsell.co.uk

Notes :-

Majorsell parts for :-

LK3963

Principal users :-

MAJORSELL
REBUILD

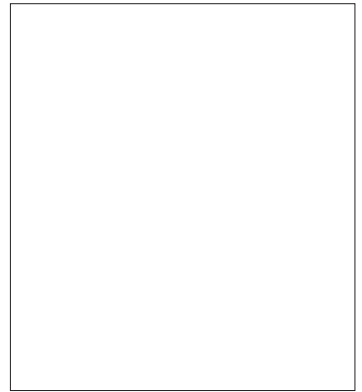

- 88 mm bore.
- Non-through drive.
- Water cooled.
- Weight
- Base mount.
- Engine oil lubrication.
- Water ports M22 x 1.5
- Air ports M26 x 1.5.



A66RK001C

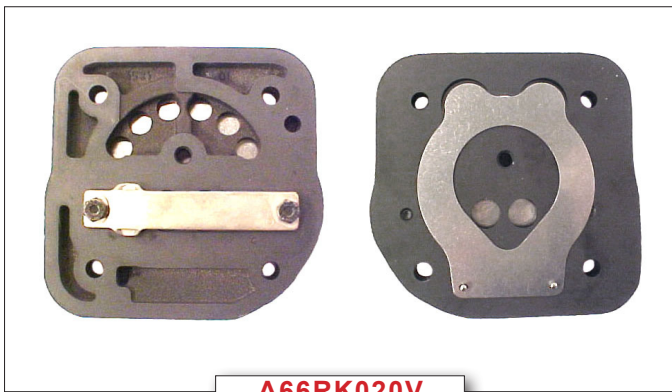
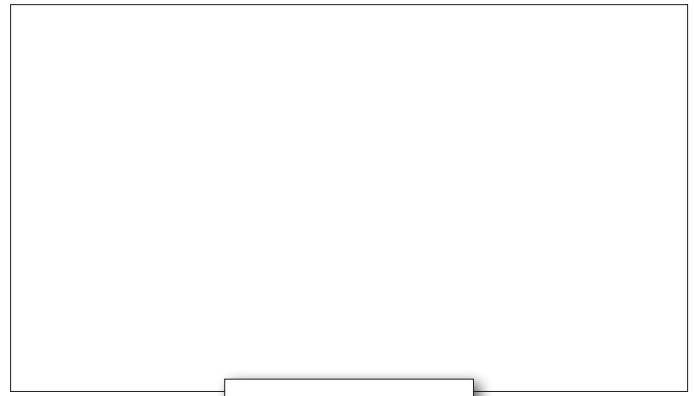



A66RK020V



A66RK020A

020112	Std	A66RK010
020113	+0.50 mm	A66RK011
020129	+1.00 mm	A66RK015

	88 mm	
	2 x 2.5,	
	1 x 4 mm	

Piston & Rings	Ring set
---------------------------	-----------------



020161



020161K

Check our web site for suitability of these and other parts, or contact us directly. Original part numbers are used for reference only. Check all applications. All parts offered are Majorsell brand and may not be of an original supply. Majorsell kit content and ring sets may be different to the original.



LK3963

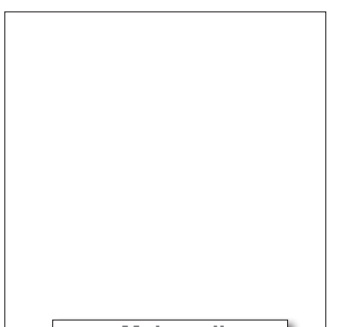
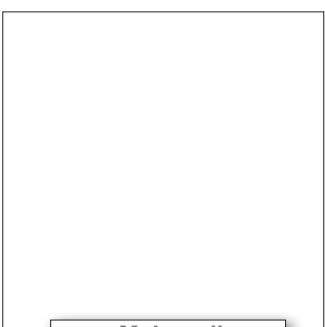
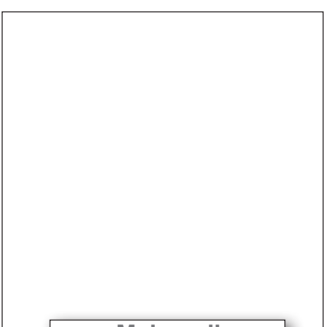
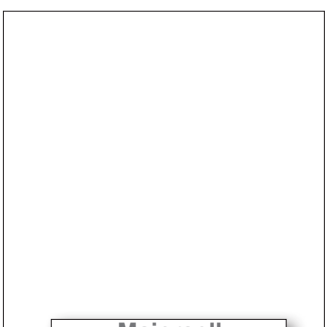
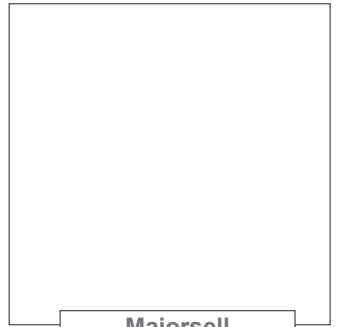
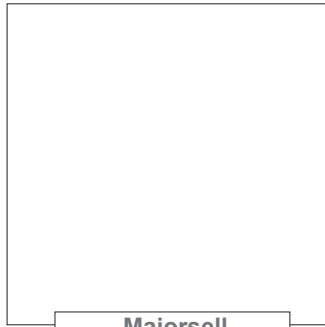
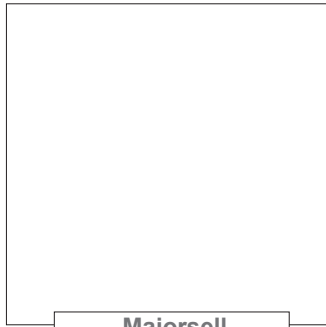
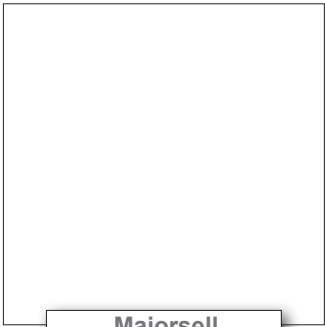
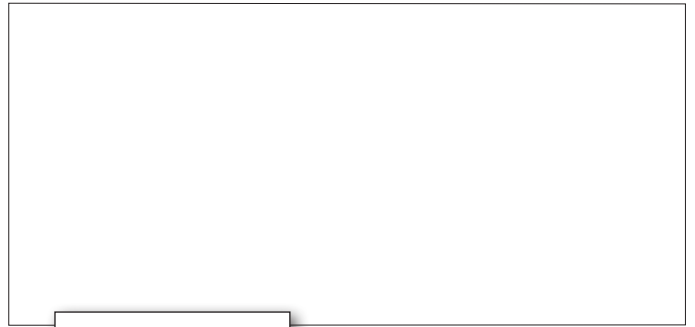
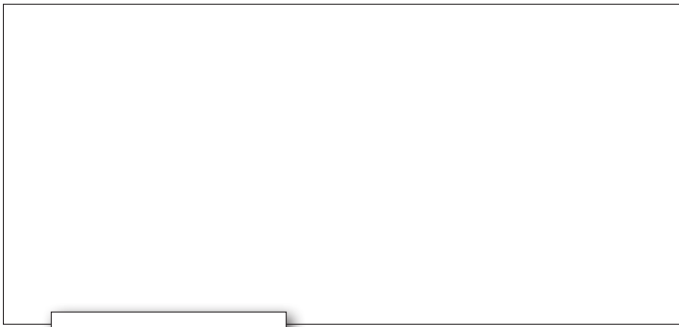
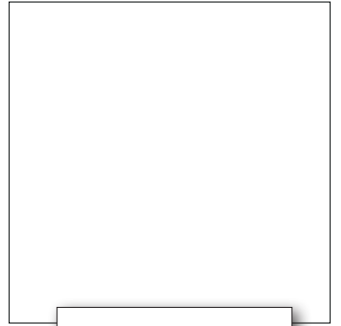
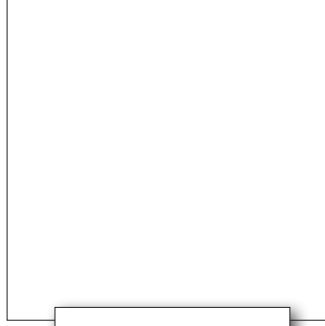
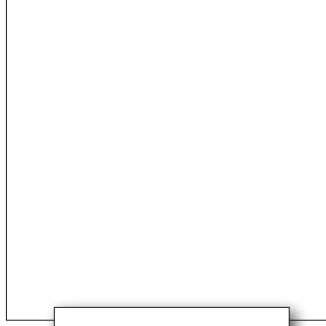
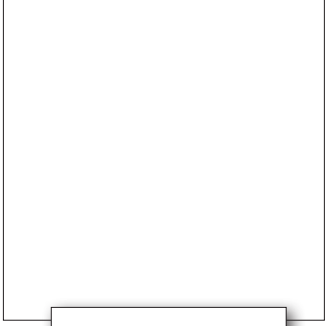
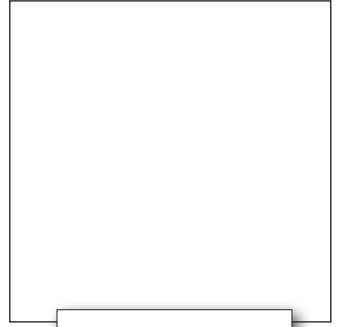
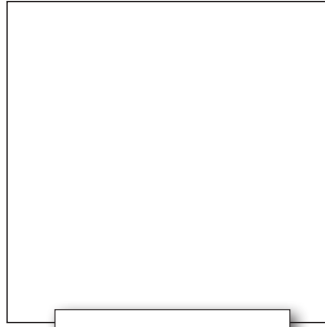
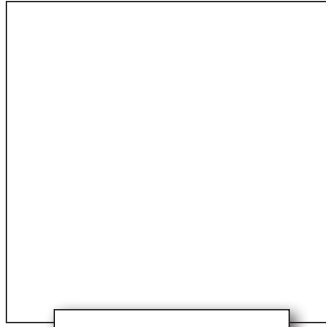
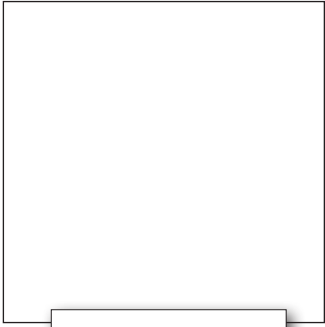

Majorsell parts for :-

LK3965

Principal users :-
Iveco

MAJORSELL
REBUILD

1180656 01180656

66A064R



- 88 mm bore.
- Through drive
- Water cooled.
- Weight 12 Kg.
- Flange mount.
- Engine oil lubrication.
- Water ports M18
- Air inlet M30, delivery M18.



A66RK005D1



A66RK047C

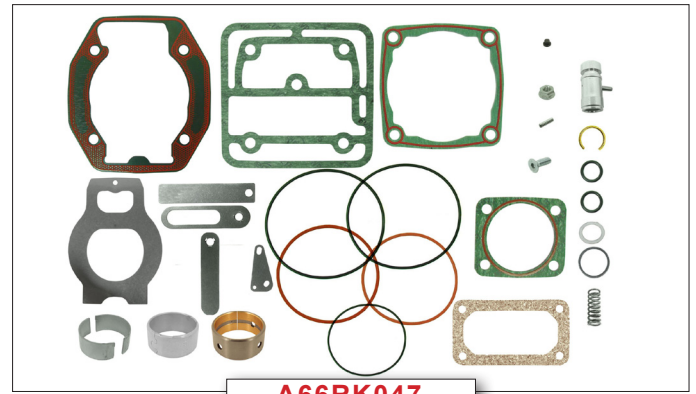

A66RK047



A66RK047V



A66RK047A

	020112	Std	A66RK010
	020113	+0.50 mm	A66RK011
	020129	+1.00 mm	A66RK015
	88 mm		
	2 x 2.5 mm,		
	1 x 4 mm		

Piston & Rings

Ring set

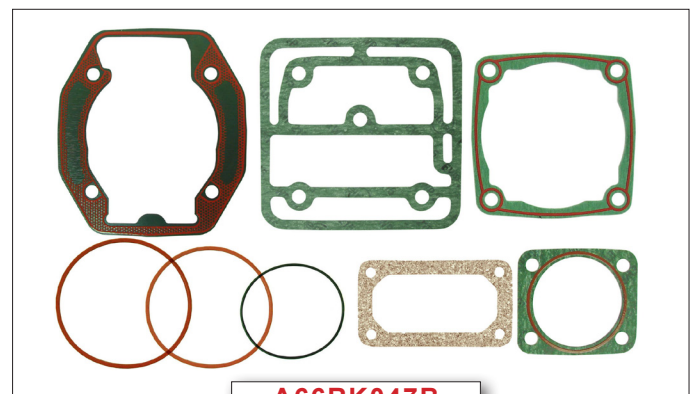

A66RK047B

Check our web site for suitability of these and other parts, or contact us directly. Original part numbers are used for reference only. Check all applications. All parts offered are Majorsell brand and may not be of an original supply. Majorsell kit content and ring sets may be different to the original.



LK3965

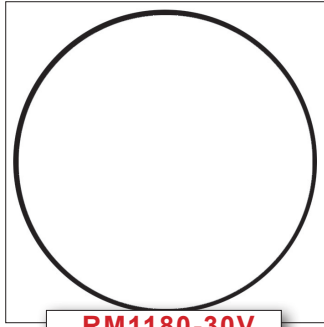
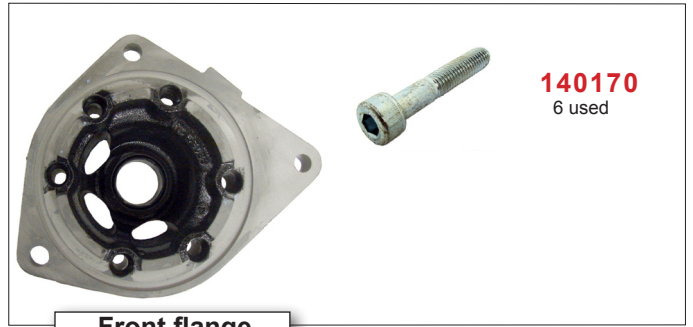
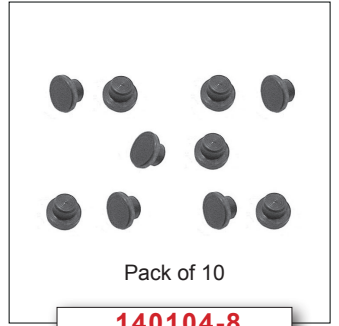
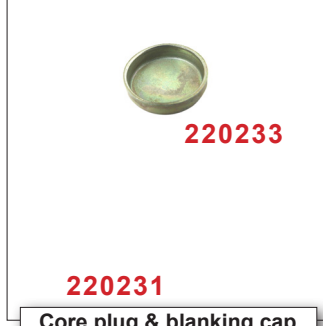
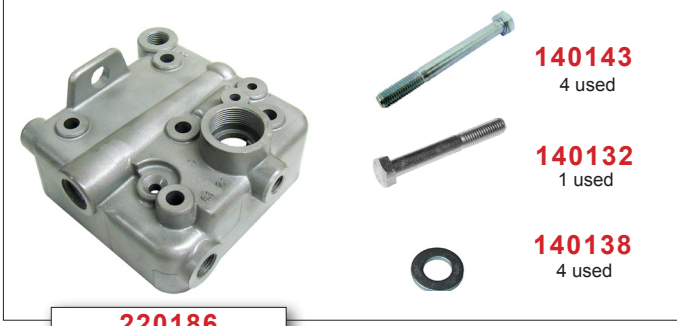

Majorsell Ltd
ENGLAND
sales@majorsell.co.uk
www.majorsell.co.uk

Notes :- 140105-8 sliders are oversize to fit slot after machining out to 8mm width.

Majorsell parts for :-

LK3978 LK3980

Principal users :-
MAN

**MAJORSELL
REBUILD**

LK3978	51541017245	Base mount, non-through drive
LK3980	51541017247	Flange mount, through drive

- 88 mm bore.
- Drive varies - see above.
- Water cooled.
- Weight 10 Kg

- Mount varies - see above.
- Engine oil lubrication.
- Water ports M22 x 1.5.
- Air ports M26 x 1.5

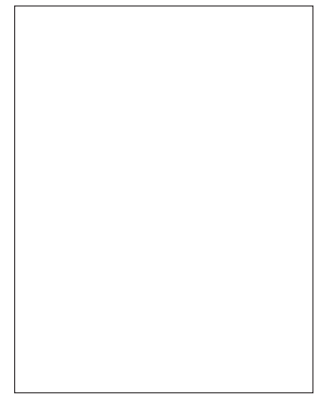

A66RK001C

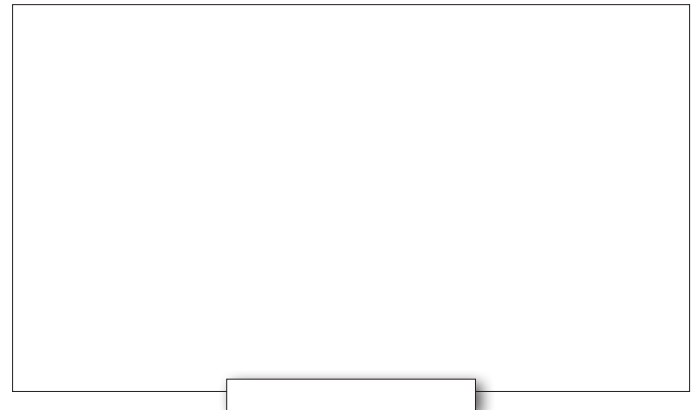

A66RK020V



A66RK020A



A66RK020B

020112	Std	A66RK010
020113	+0.50 mm	A66RK011
020129	+1.00 mm	A66RK015

	88 mm	
	2 x 2.5 mm	
	1 x 4 mm	

Piston & Rings **Ring set**

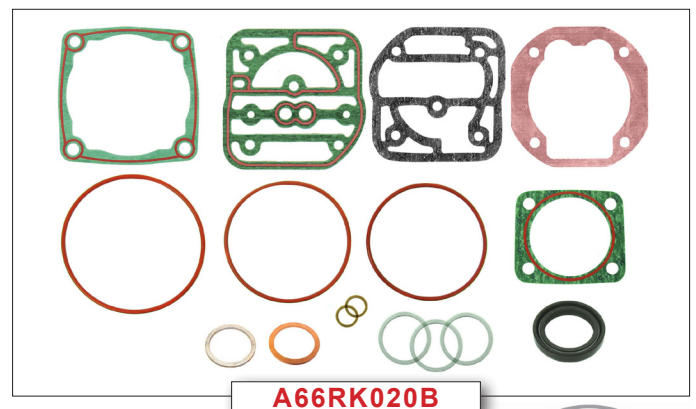

A66RK020B

Check our web site for suitability of these and other parts, or contact us directly. Original part numbers are used for reference only. Check all applications. All parts offered are Majorsell brand and may not be of an original supply. Majorsell kit content and ring sets may be different to the original.



LK3978 LK3980

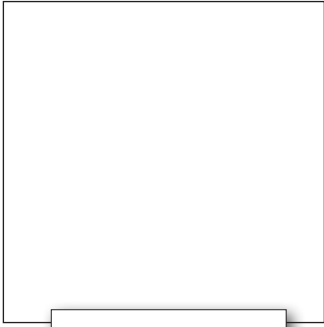

[Label]

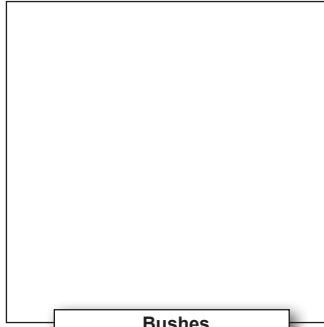

Bushes

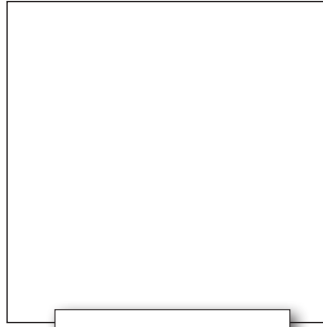

[Label]

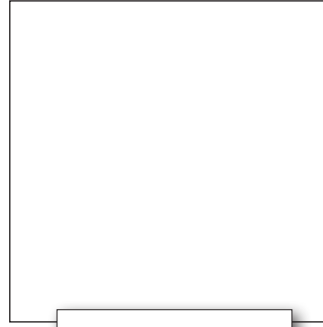

[Label]



LK3978

220096

[Label]

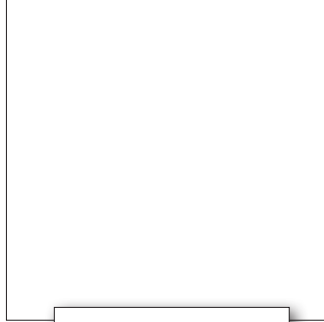

[Label]

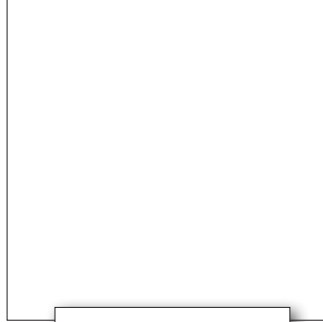

[Label]

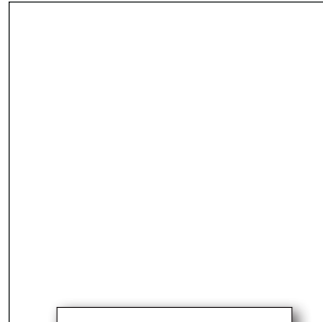

[Label]



[Label]

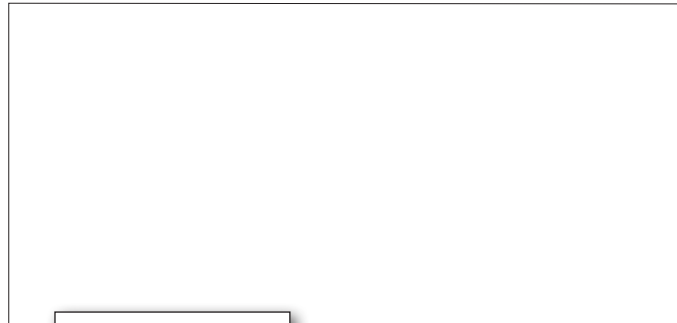

[Label]

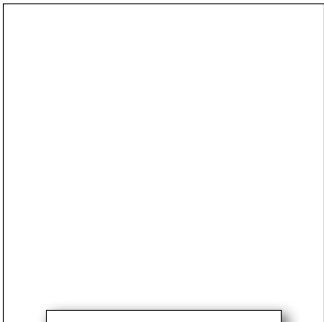

[Label]

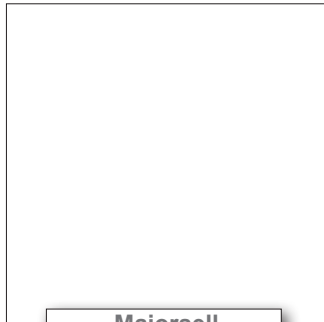

Majorsell



Majorsell

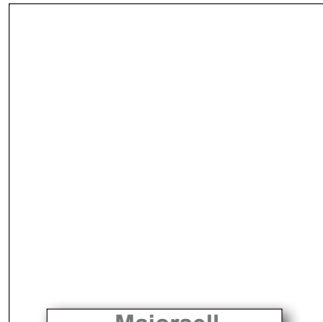

Majorsell

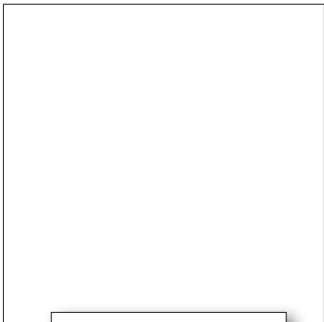

[Label]

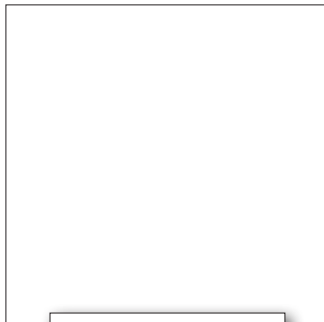

[Label]

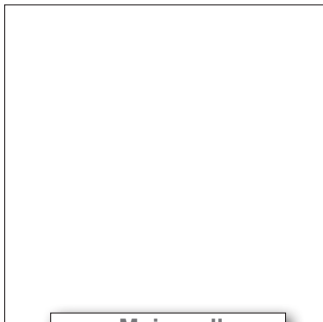

Majorsell

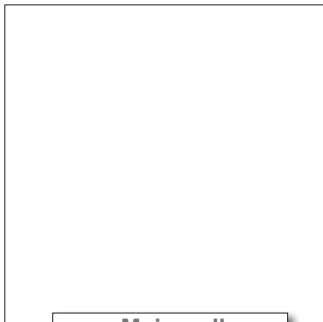

Majorsell

Majorsell Ltd
ENGLAND
sales@majorsell.co.uk
www.majorsell.co.uk

Notes :-

Majorsell parts for :-

LK3982

Principal users :-

Volvo

3987601

**MAJORSELL
REBUILD**

66A091R



- 88 mm bore.
- Non-through drive.
- Water cooled.
- Weight 11 Kg

- Flange mount.
- Engine oil lubrication.
- Water ports M16 x 1.5 mm.
- Air inlet : Manifold, Delivery : M18 x 1.5 mm.

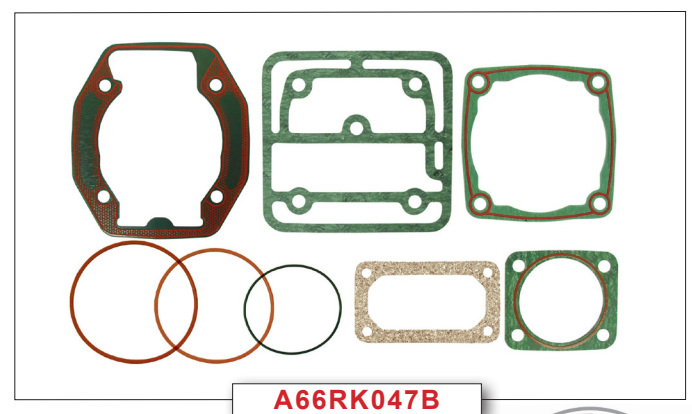
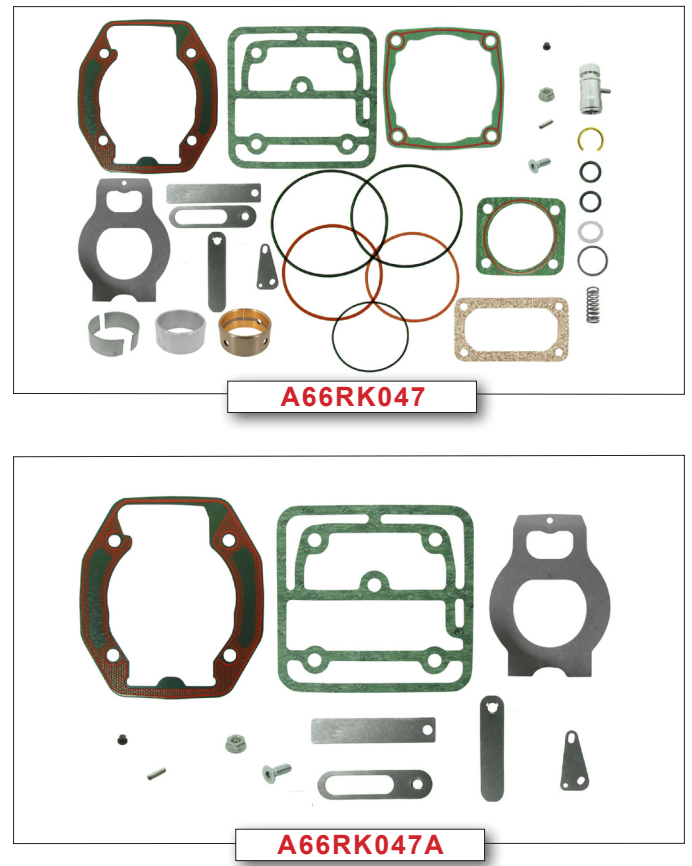

Check our web site for suitability of these and other parts, or contact us directly.
 Original part numbers are used for reference only. Check all applications.
 All parts offered are Majorsell brand and may not be of an original supply.
 Majorsell kit content and ring sets may be different to the original.



LK3982



Crankshaft



Bushes



140016



220014



Head

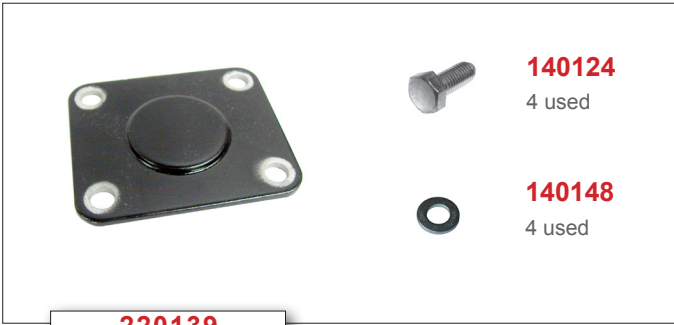
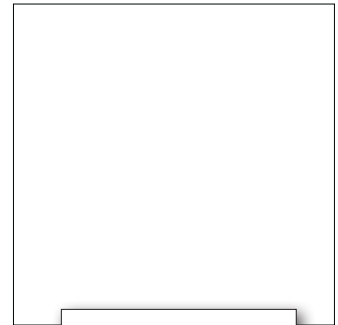
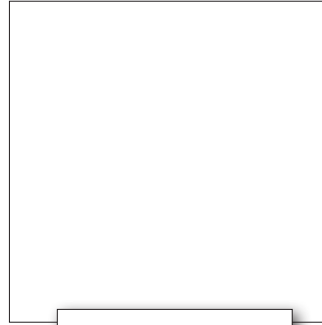

220139

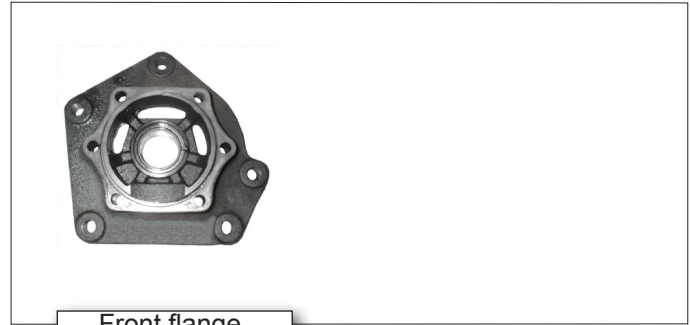

Front flange

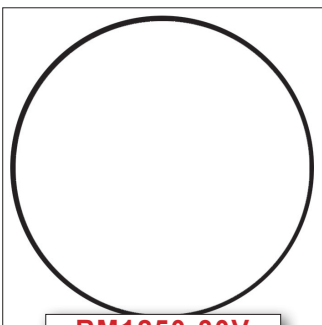

RM1250-30V

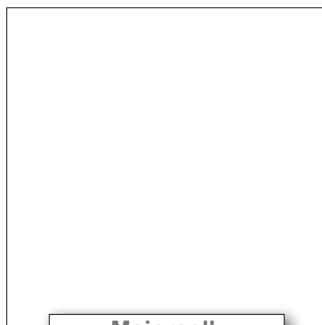

Majorsell

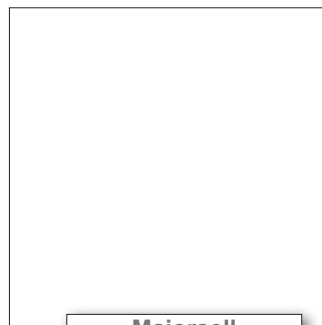

Majorsell

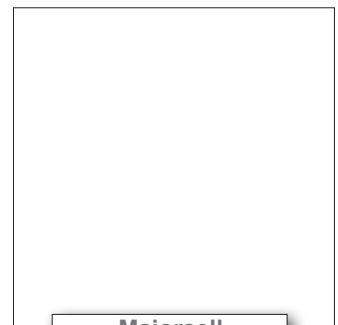

Majorsell



020170

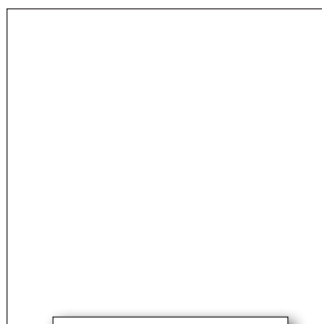
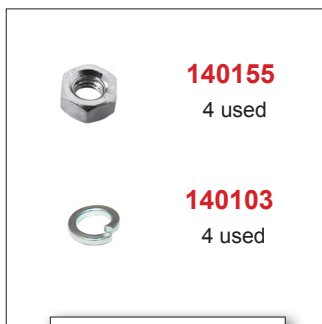

Majorsell

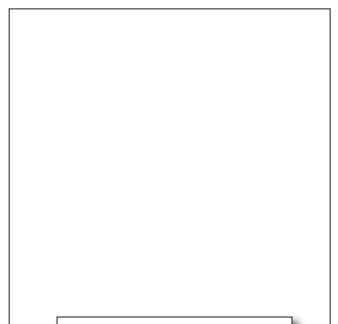

Majorsell

Majorsell Ltd
 ENGLAND
sales@majorsell.co.uk
www.majorsell.co.uk

Notes :-

Majorsell parts for :-

LK3994

Principal users :-
Cummins / Iveco

MAJORSELL

4897301, 504016818

66A068R

SEB22532 - use A66RK058
5008558 - use A66RK058A

- 92 mm bore.
- Through drive
- Water cooled.
- Weight
- Flange mount.
- Engine oil lubrication.
- Water ports M16 x 1.5 mm
- Air ports : M22 x 1.5 mm.

Used on Cummins, Iveco.

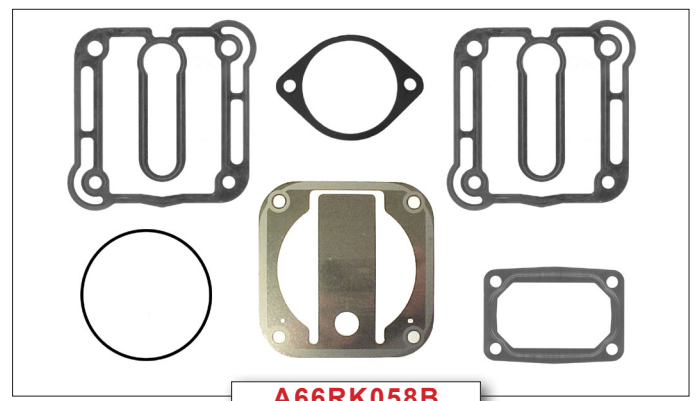
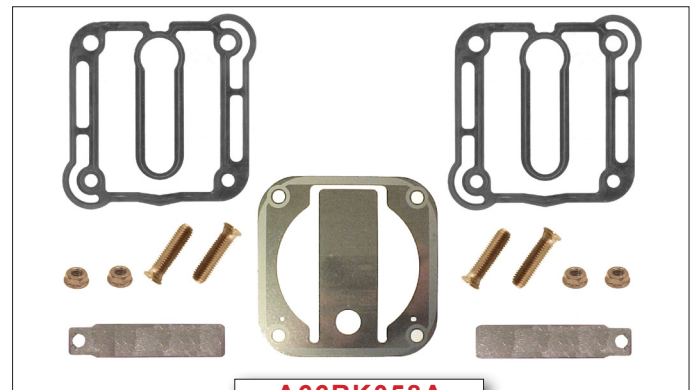
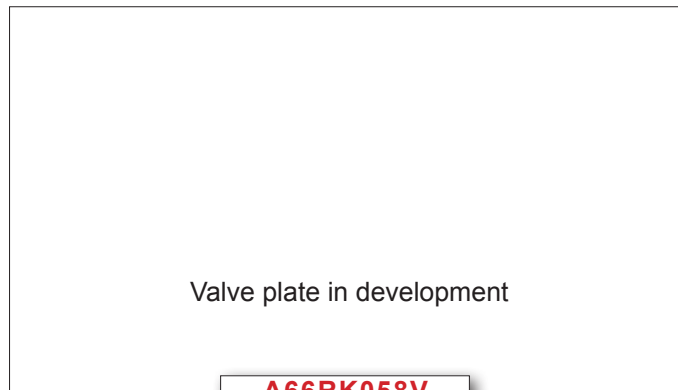
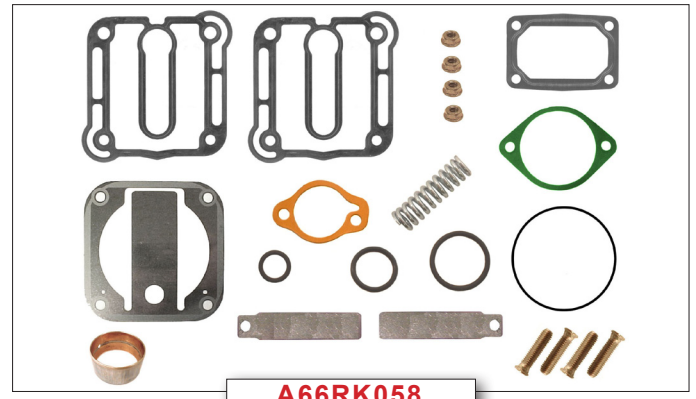
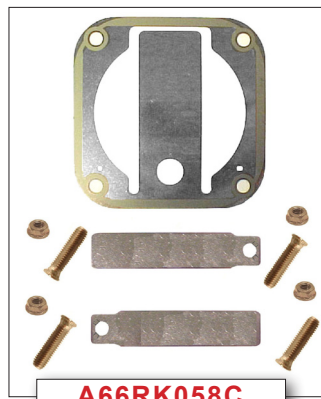

Check our web site for suitability of these and other parts, or contact us directly.
Original part numbers are used for reference only. Check all applications.
All parts offered are Majorsell brand and may not be of an original supply.
Majorsell kit content and ring sets may be different to the original.



LK3994

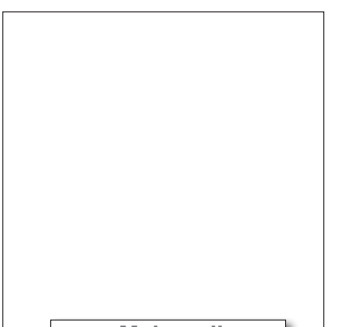
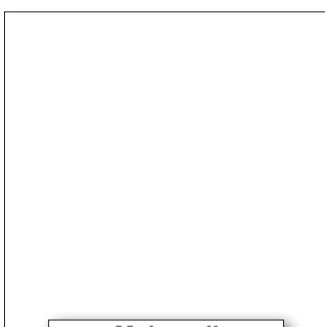
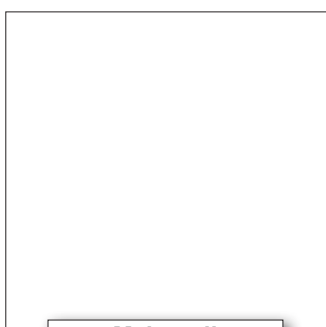
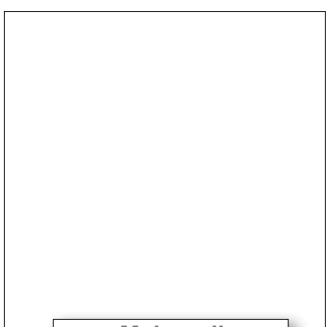
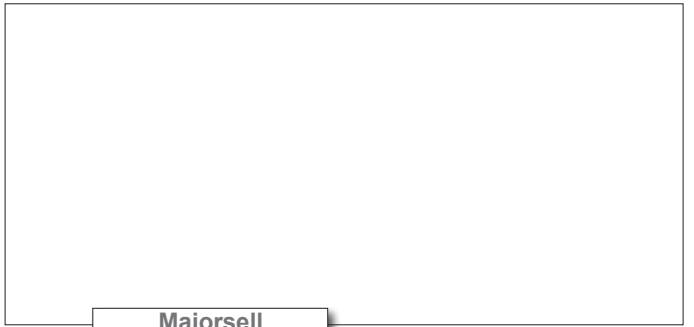
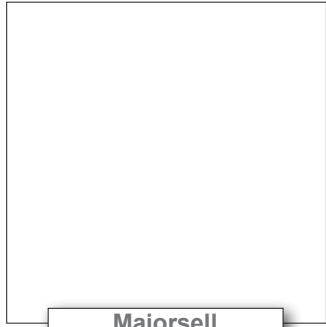
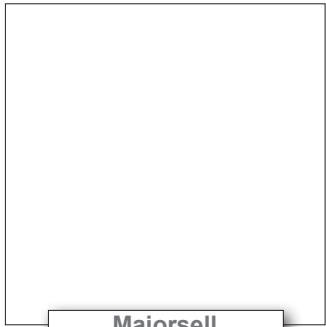
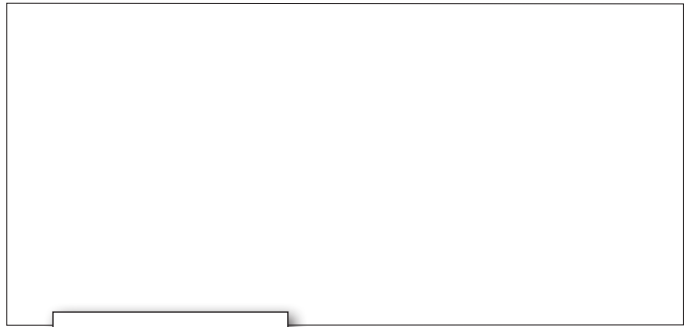
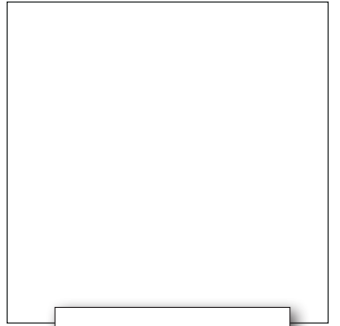
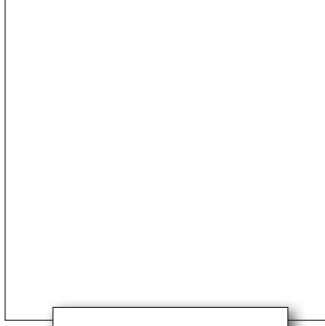
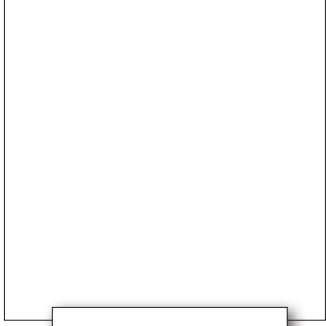
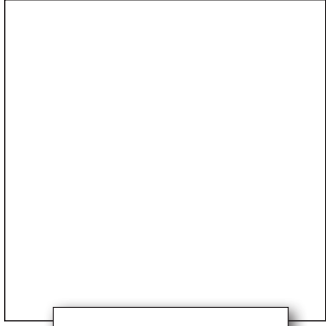
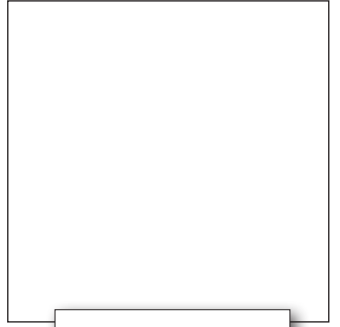
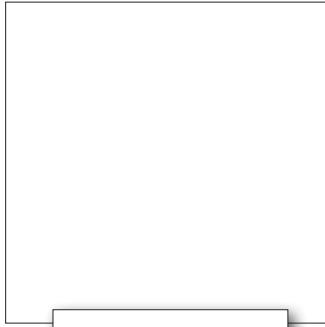
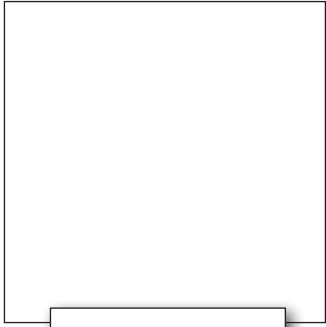
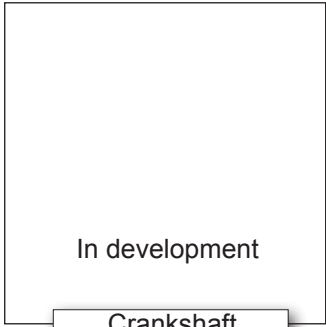

Majorsell parts for :-

LK4909 - LK4910 - LK4911 - LK4913

Principal users :-
MAN

**MAJORSELL
REBUILD**

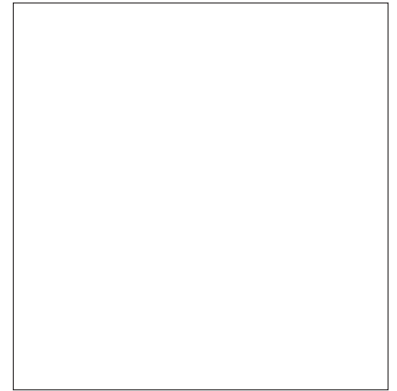

LK4909	51541017215
LK4913	51541017235, 51541019215, 51541017243

- 88 mm bore.
- Non-through drive.
- Water cooled.
- Air inlet - manifold
- Weight 18 Kg.
- Flange mount.
- Engine oil lubrication.
- Water ports M16 x 1.5 mm.
- Air delivery M26 x 1.5 mm.

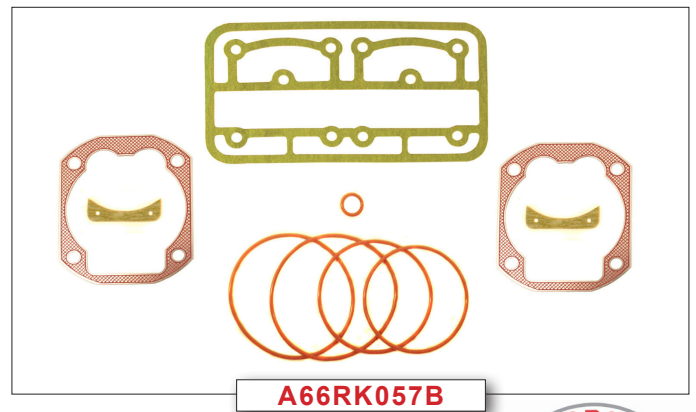
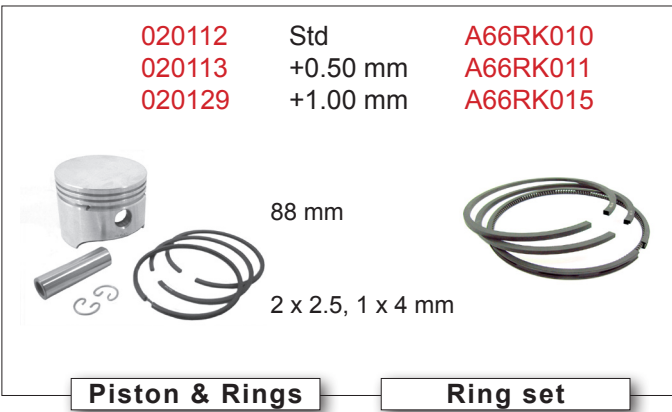
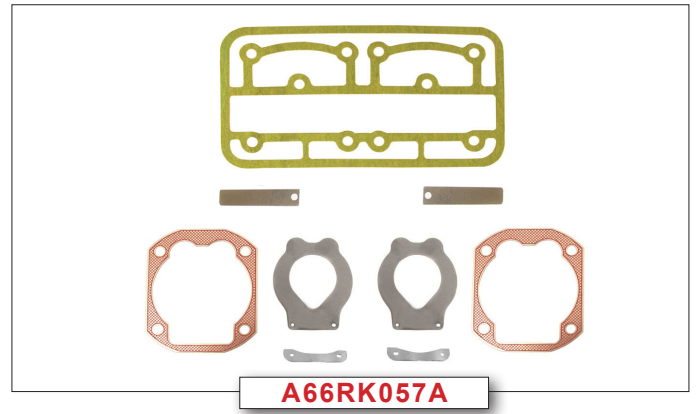
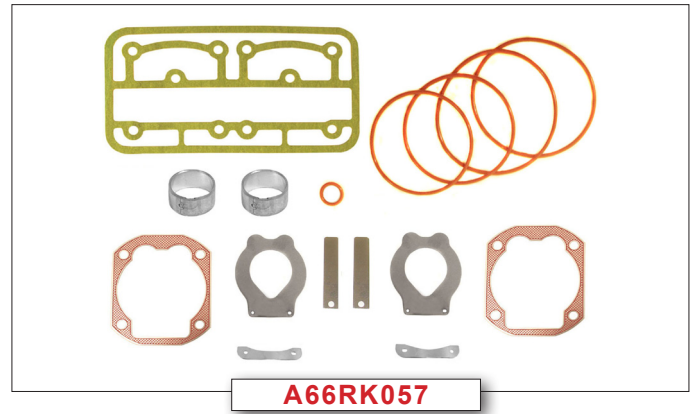
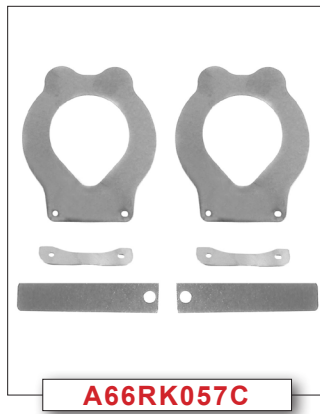

Check our web site for suitability of these and other parts, or contact us directly.
Original part numbers are used for reference only. Check all applications.
All parts offered are Majorsell brand and may not be of an original supply.
Majorsell kit content and ring sets may be different to the original.



LK4909 - LK4910 - LK4911 - LK4913

In development

Crankshaft

In development

Conn Rod

In development

Head

In development

End cover

Majorsell

Majorsell

Majorsell

Majorsell

Majorsell

Majorsell

Majorsell

Majorsell parts for :-

LK4919

Principal users :-
Volvo

**MAJORSELL
REBUILD
66A146R**

K000231	70330002	85000081
	70305890	8113815

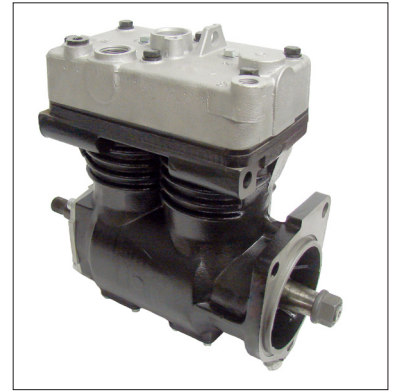

- 88 mm bore.
- Through drive.
- Water cooled.
- Weight 22 Kg.
- Flange mount.
- Engine oil lubrication.
- Water ports : M16 x 1.5.
- Air inlet : manifold, delivery : M26 x1.5.

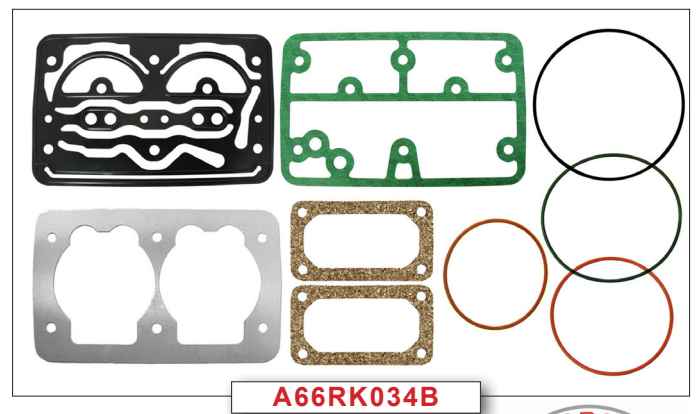
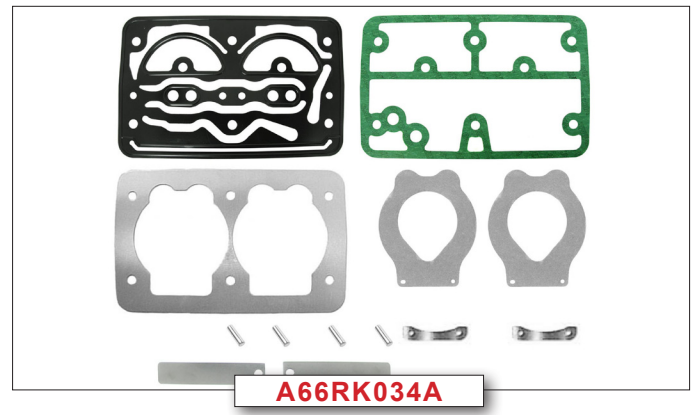
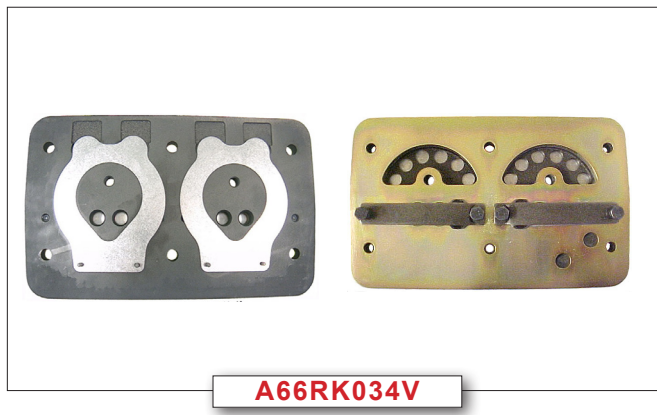
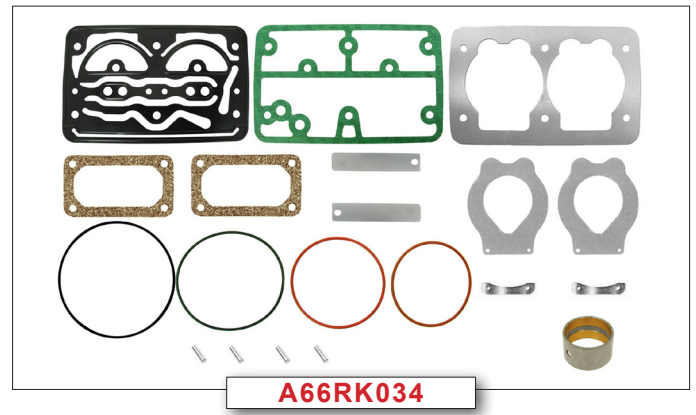

Check our web site for suitability of these and other parts, or contact us directly. Original part numbers are used for reference only. Check all applications. All parts offered are Majorsell brand and may not be of an original supply. Majorsell kit content and ring sets may be different to the original.



LK4919



220216



Front & Rear

050186



140016



220069



220219

140140
6 used



140132
2 used



140138
8 used

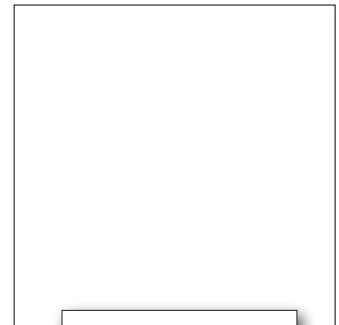
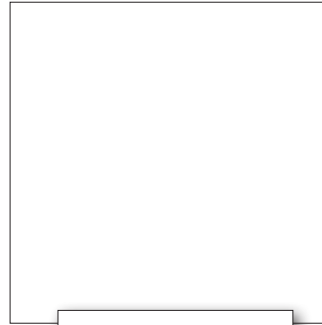

Rear end cover

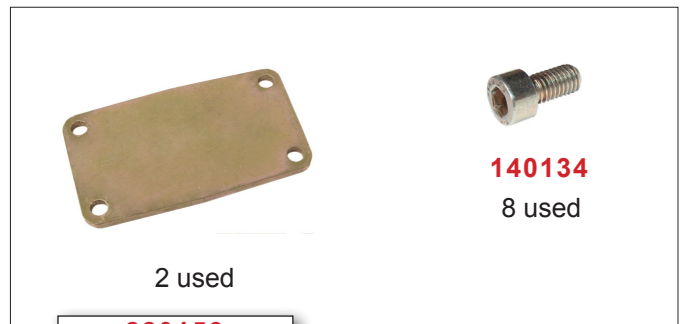

2 used

220153



140134
8 used

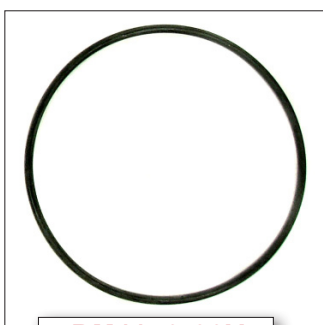

RM1150-30V

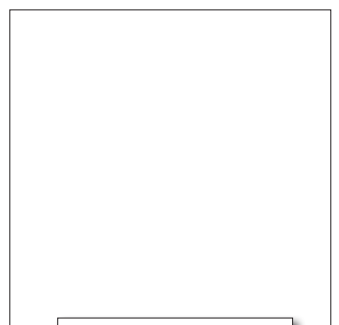
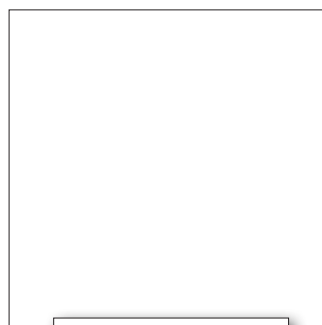
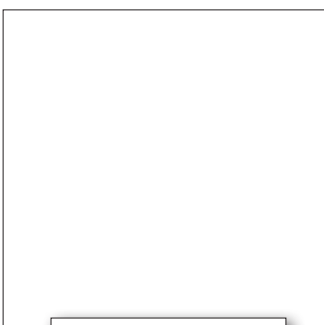
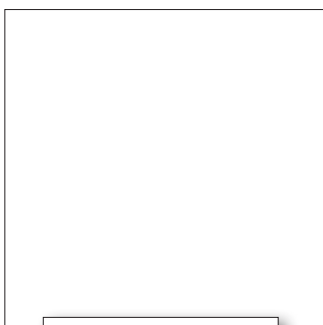
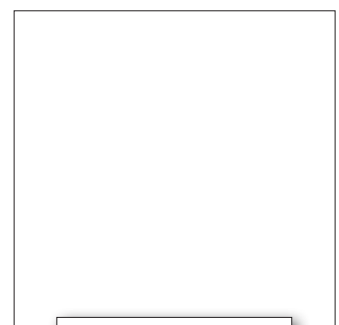
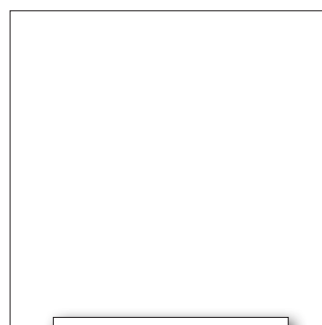
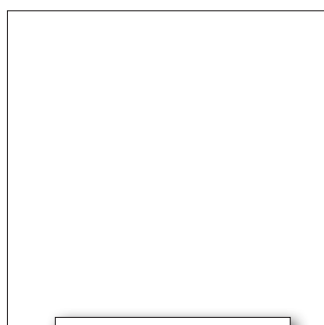

Majorsell parts for :-

LK4920

Principal users :-
Volvo

**MAJORSELL
REBUILD
66A080R**

70330003 70305891 8113816

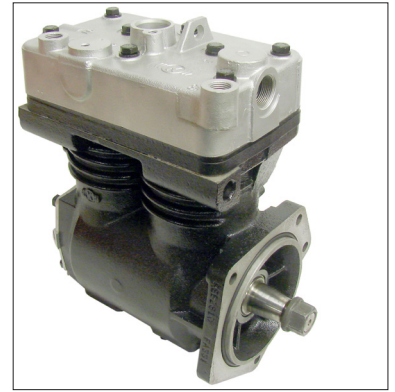

- 88 mm bore.
- Non through drive.
- Water cooled.
- Weight 20 Kg.
- Flange mount.
- Engine oil lubrication.
- Water ports : M16 x 1.5.
- Air inlet : manifold, delivery : M26 x1.5.

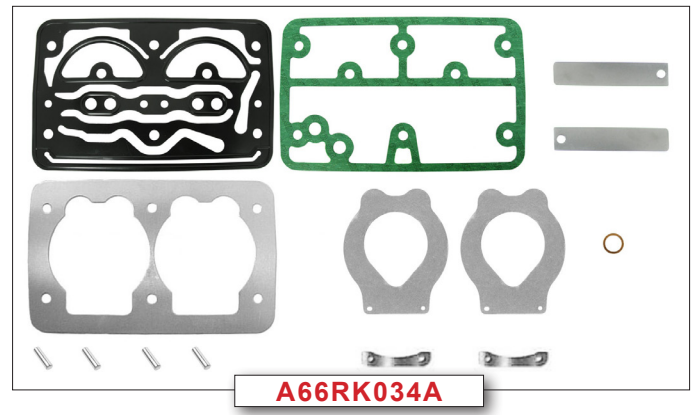
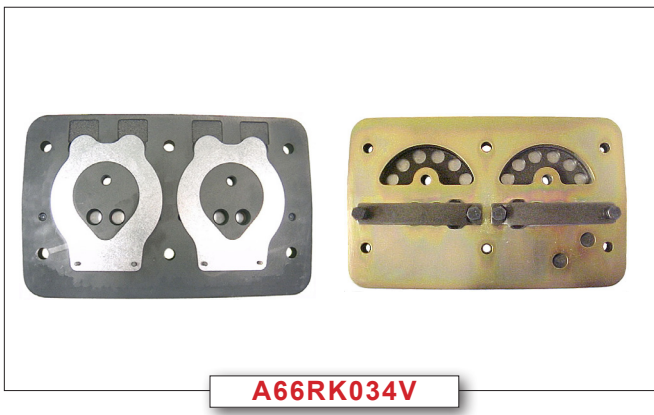
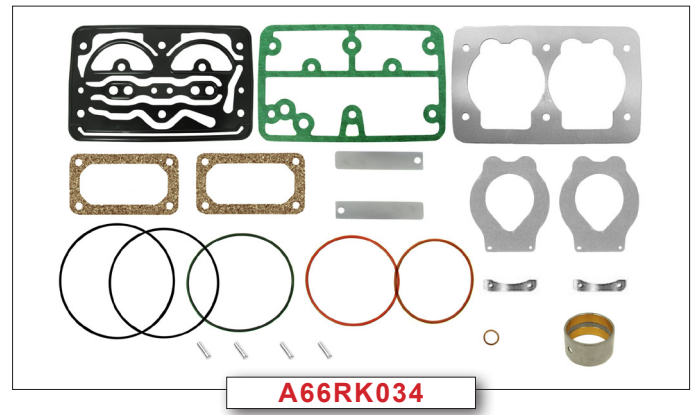

<p>020112 020113 020129</p>	<p>Std +0.50 mm +1.00 mm</p> <p>88 mm 2 x 2.5 mm 1 x 4 mm</p>	<p>A66RK010 A66RK011 A66RK015</p>
Piston & Rings		Ring set

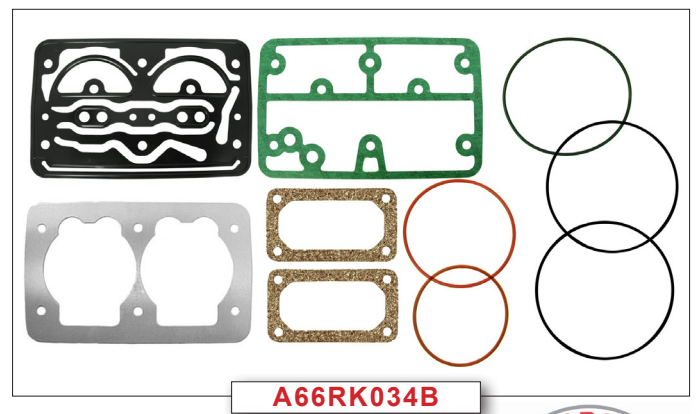

Check our web site for suitability of these and other parts, or contact us directly.
Original part numbers are used for reference only. Check all applications.
All parts offered are Majorsell brand and may not be of an original supply.
Majorsell kit content and ring sets may be different to the original.



LK4920



220214



Front

050186



140016



220069

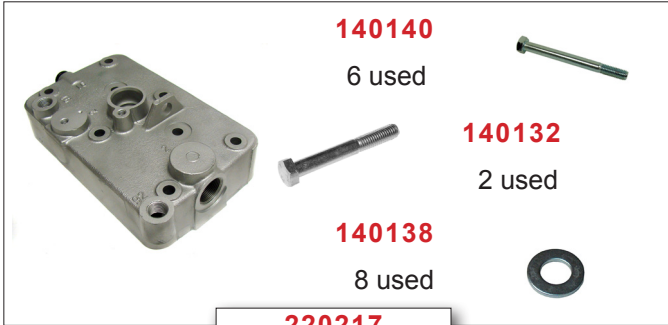

140140

6 used

140132

2 used

140138

8 used

220217

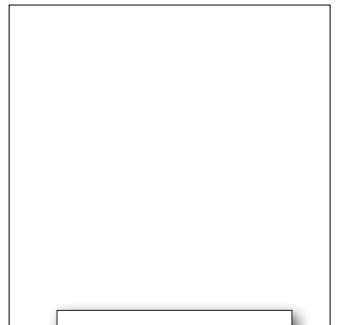
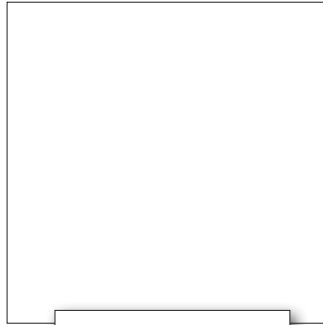

220083



140197

8 used

2 used

220153

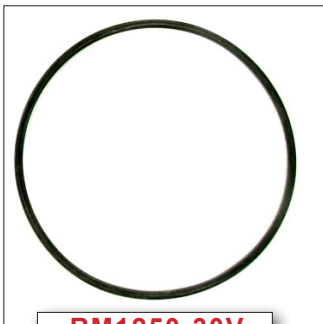

RM1250-30V

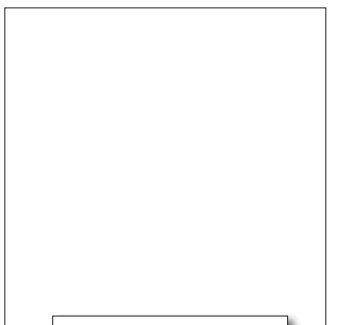
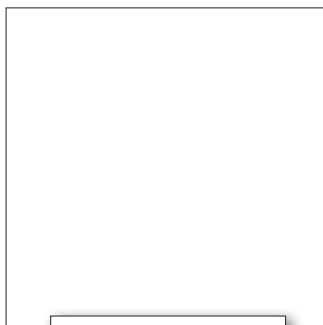
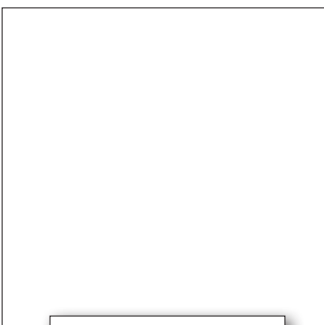
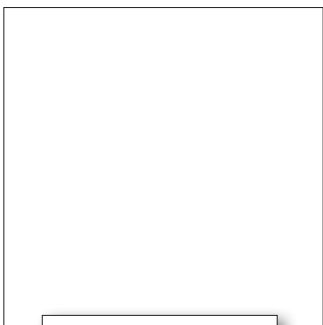
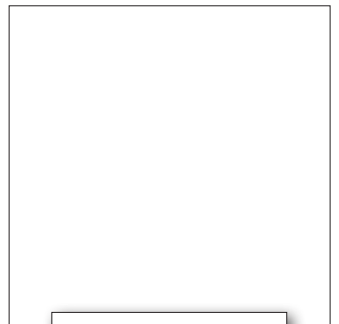
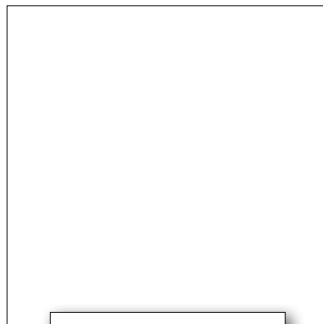
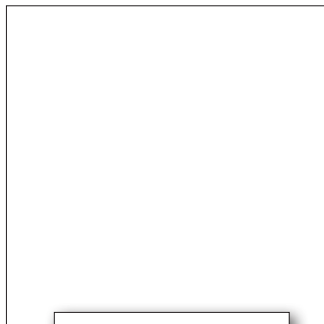

Majorsell parts for :-

LK4921

Principal users :-
Volvo

8113634 70305892

**MAJORSELL
REBUILD
66A087R**



- 88 mm bore.
- Non through drive.
- Water cooled.
- Weight 22 Kg.
- Flange mount.
- Engine oil lubrication.
- Water ports : M16 x 1.5.
- Air inlet : manifold, delivery : M26 x1.5.

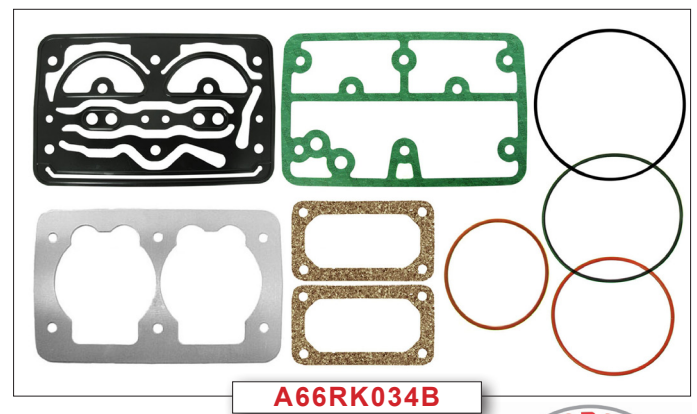
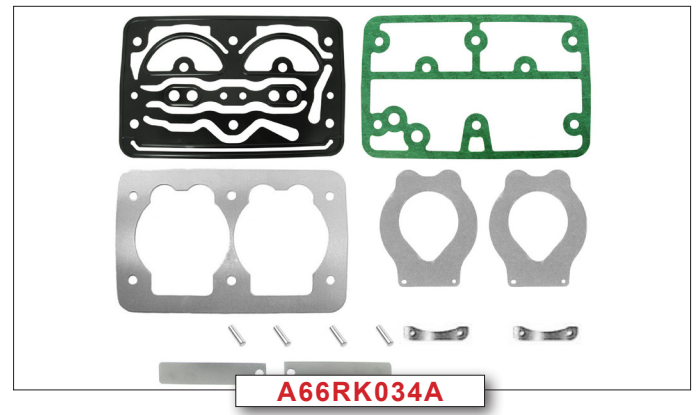
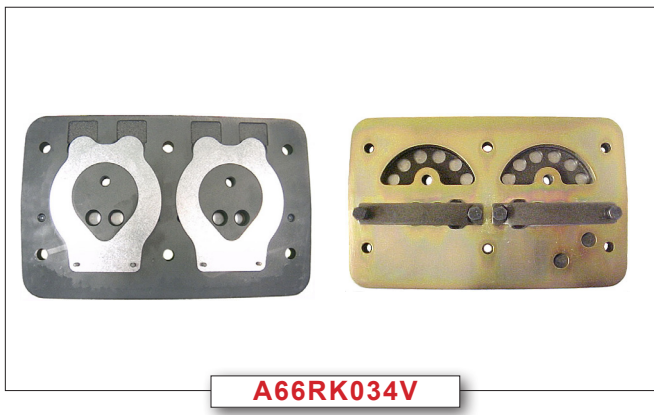
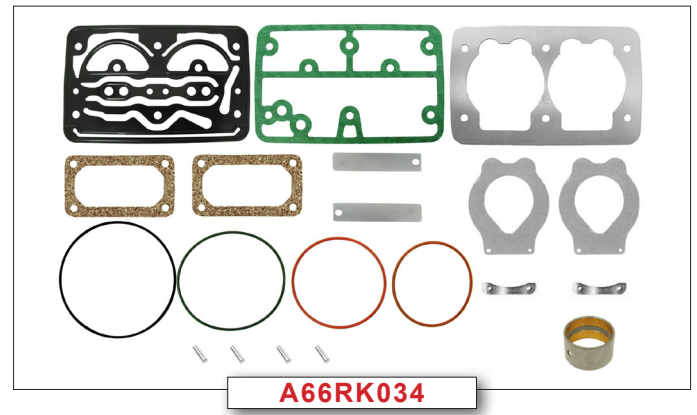

Check our web site for suitability of these and other parts, or contact us directly.
Original part numbers are used for reference only. Check all applications.
All parts offered are Majorsell brand and may not be of an original supply.
Majorsell kit content and ring sets may be different to the original.



LK4921



220159



Front

050186



140016



220069

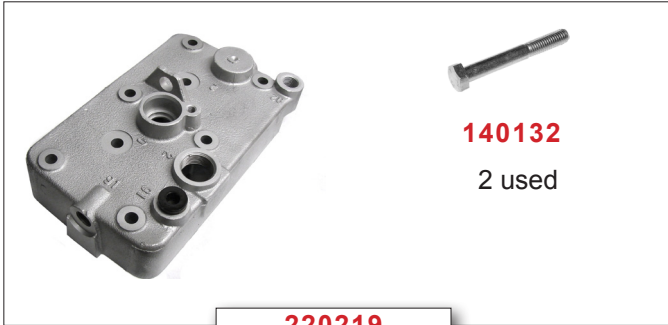

220219



140132

2 used

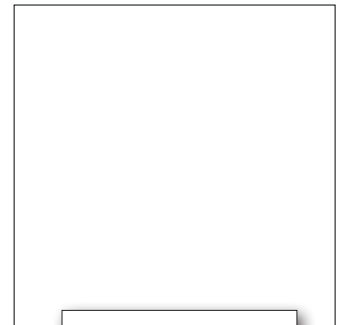
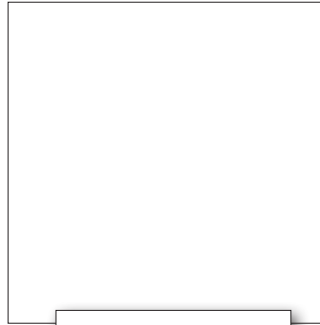

220083



2 used

220153

140134

8 used

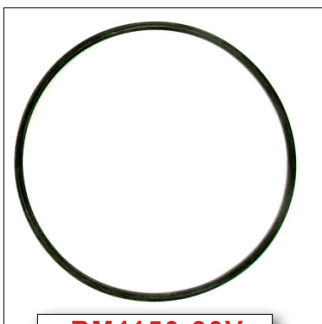

RM1150-30V

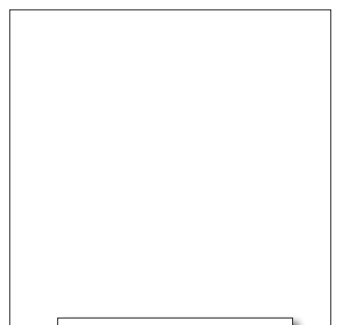
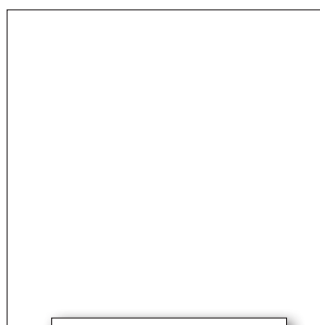
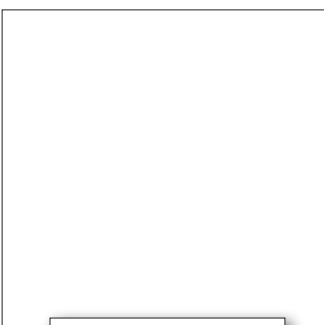
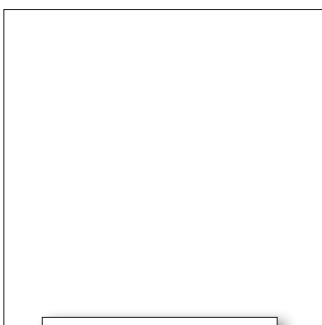
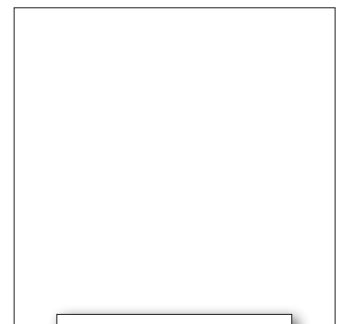
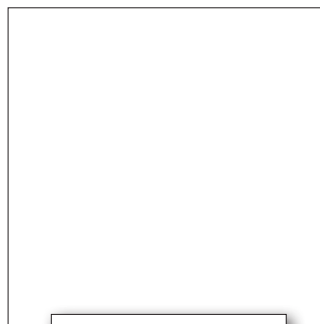
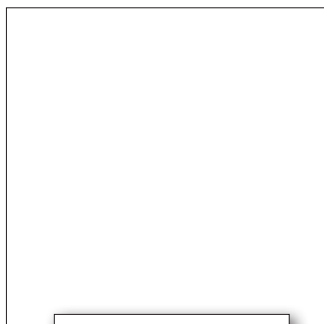

Majorsell parts for :-

LK4927

Principal users :-
Volvo / Deutz

MAJORSELL
REBUILD

04227086

66A122R



- 88 mm bore.
- Non through drive.
- Water cooled.
- Weight 20 Kg.
- Flange mount.
- Engine oil lubrication.
- Water ports M16 x 1.5.
- Air inlet : manifold, air delivery : M26 x1.5.



A66RK034C



A66RK034



A66RK034V

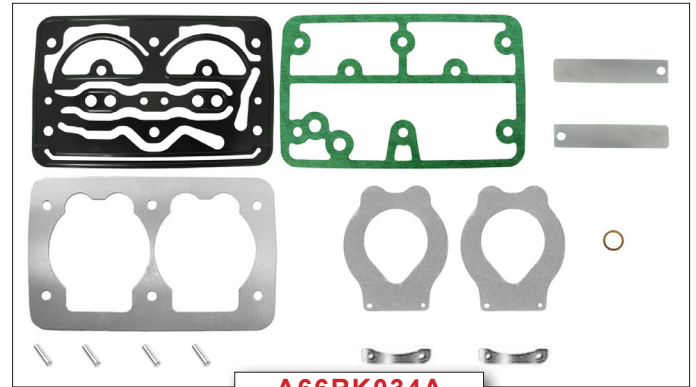

A66RK034A

<p>020112 020113 020129</p> 	<p>Std +0.50 mm +1.00 mm</p> <p>88 mm 2 x 2.5 mm 1 x 4 mm</p>	<p>A66RK010 A66RK011 A66RK015</p> 
---	---	---

Piston & Rings

Ring set

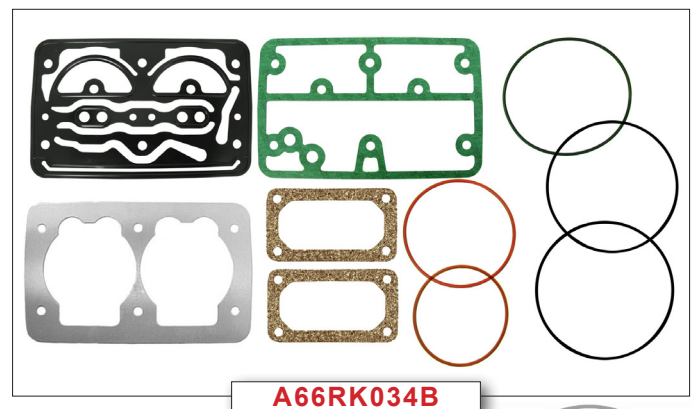

A66RK034B

Check our web site for suitability of these and other parts, or contact us directly.
Original part numbers are used for reference only. Check all applications.
All parts offered are Majorsell brand and may not be of an original supply.
Majorsell kit content and ring sets may be different to the original.



LK4927



220159



Front

050186



140016



220069



140140
6 used



140132
2 used



140138
6 used



220301



A66RK005CP

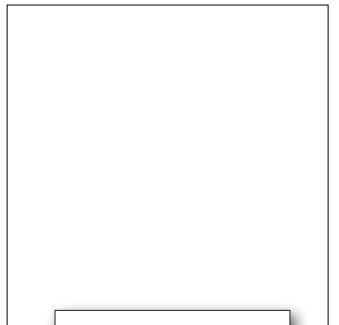

220083



2 used

220153



140134
8 used



RM1200-35V

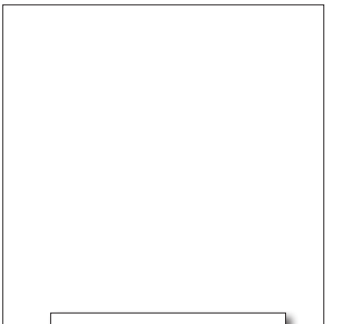
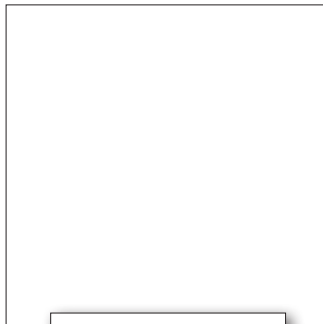
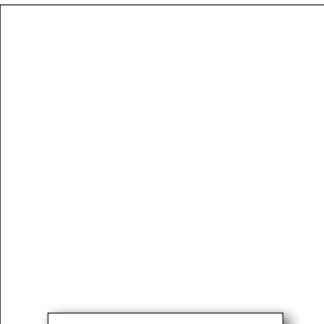
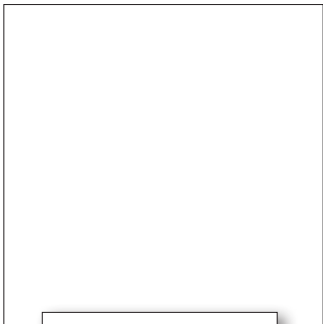
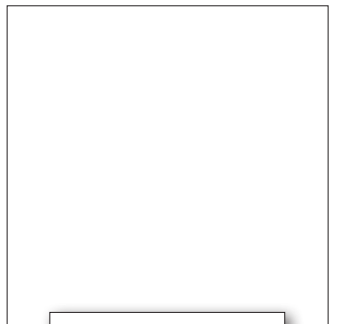
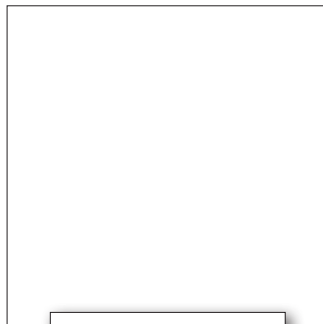
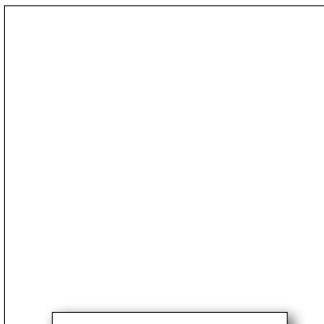

Majorsell parts for :-

LK4931 - LK4932

Principal users :-
MAN

**MAJORSELL
REBUILD**

LK4931	51541009029 51541007029 51541007015
LK4932	51541007041

66A103R



LK4931 used on NL202 bus

- 88 mm bore.
- Through drive.
- Water cooled.
- Air inlet - manifold
- Weight 17 Kg
- Flange mount.
- Engine oil lubrication.
- Water ports M16 x 1.5 mm.
- Air delivery : M26 x 1.5 mm.

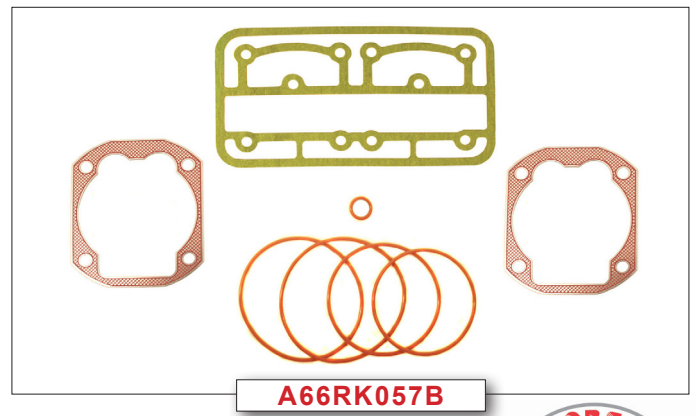
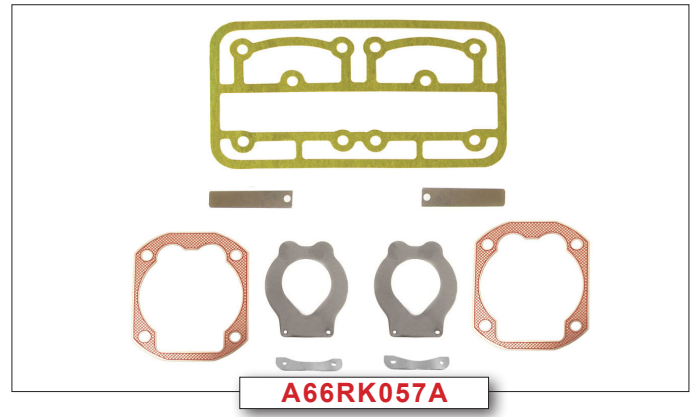
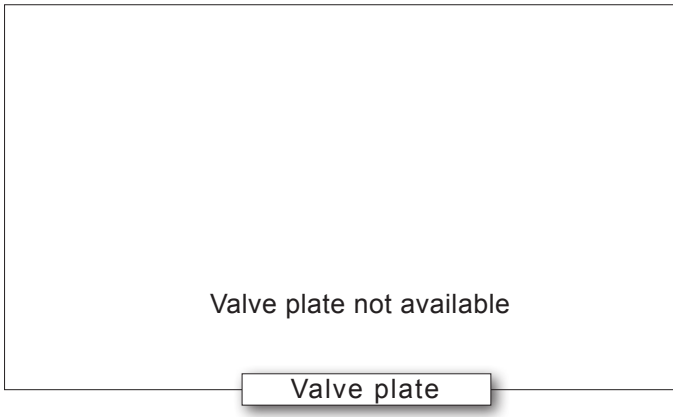
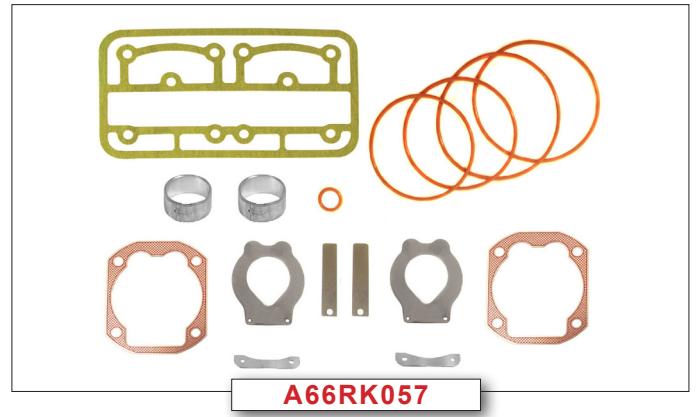
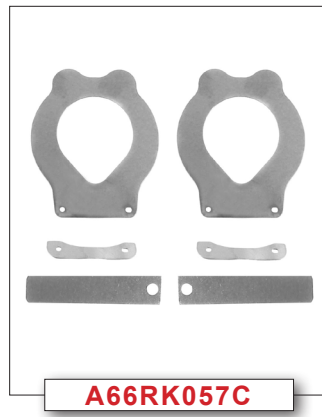

Check our web site for suitability of these and other parts, or contact us directly. Original part numbers are used for reference only. Check all applications. All parts offered are Majorsell brand and may not be of an original supply. Majorsell kit content and ring sets may be different to the original.



LK4931 - LK4932



Crankshaft



2 used
Front and rear bush

050181

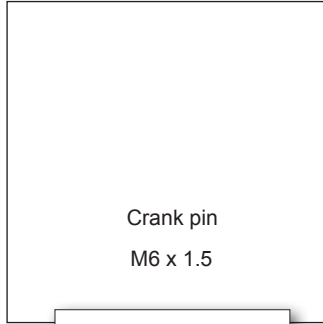

Crank pin
M6 x 1.5



2 used

220014



220291

Head bolts

140143
8 used

140132
2 used

140138
8 used



220290

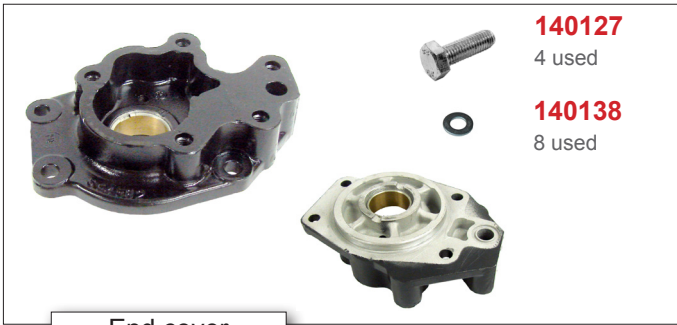
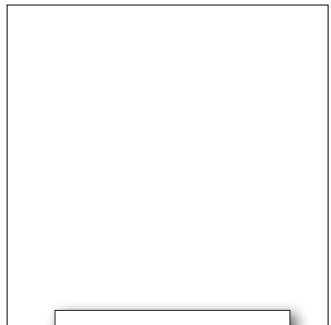

End cover

140127
4 used

140138
8 used

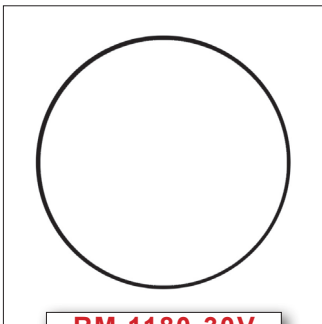
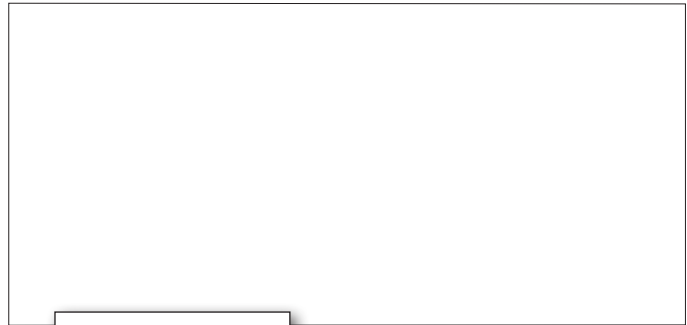

RM 1180-30V

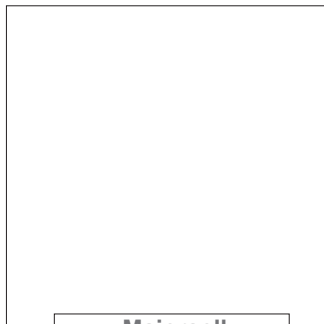

Majorsell



Majorsell



Majorsell

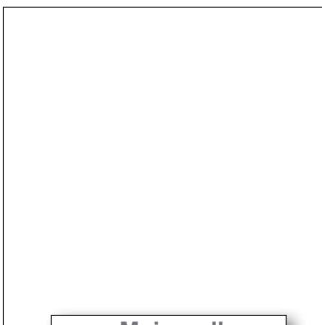

Majorsell

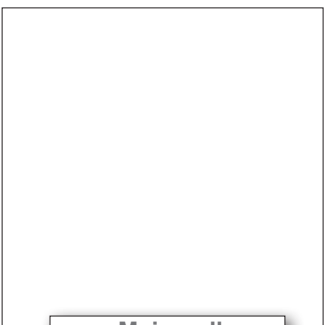

Majorsell

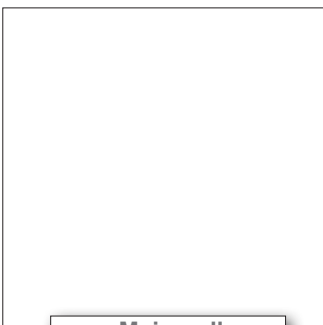

Majorsell

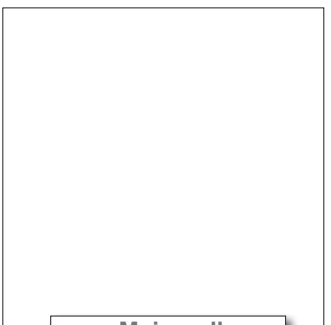

Majorsell

Majorsell Ltd
ENGLAND
sales@majorsell.co.uk
www.majorsell.co.uk

Notes :-

Majorsell parts for :-

LK4935 - LK4936

Principal users :-
Iveco

MAJORSELL
REBUILD

LK4935	504055169
LK4936	41211122 - 41211340

66A098R

66A104R



66A098R

- 86 mm bore.
- Through drive.
- Water cooled.
- Weight 17 Kg
- Flange mount.
- Engine oil lubrication.
- Water ports : M18 x 1.5 mm.
- Air ports : M26 x 1.5 mm.



A68RK115D

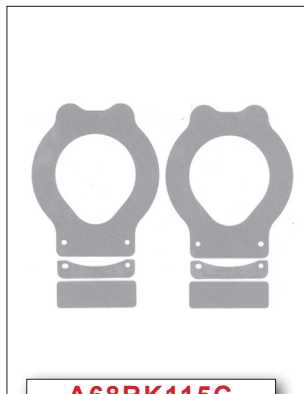

A68RK115C

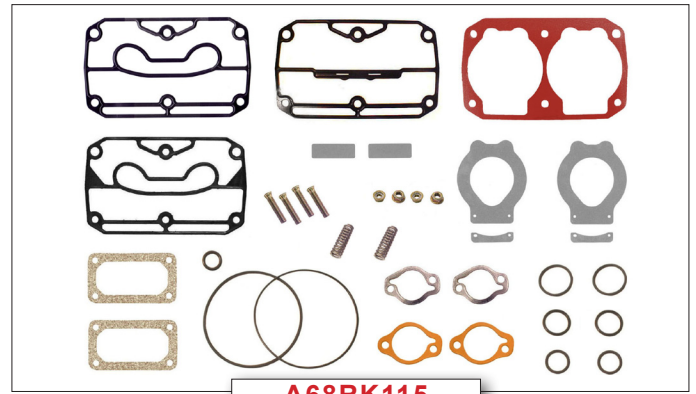

A68RK115



A68RK115D1



A68RK115V

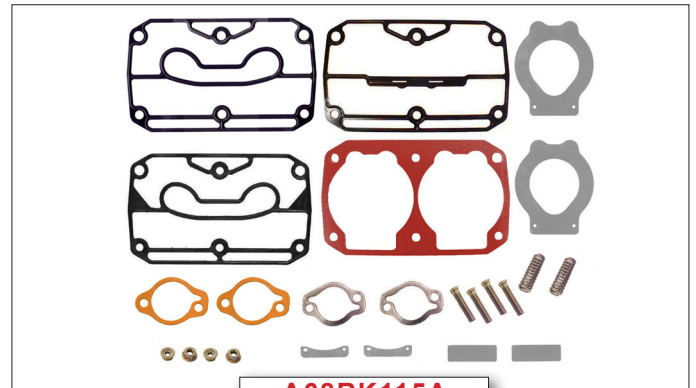

A68RK115A

020127	Std	A66RK030
020128	+0.50 mm	A66RK032
020164	+1.00 mm	A66RK068

86 mm
2 x 2 mm
1 x 4 mm

Piston & Rings

Ring set

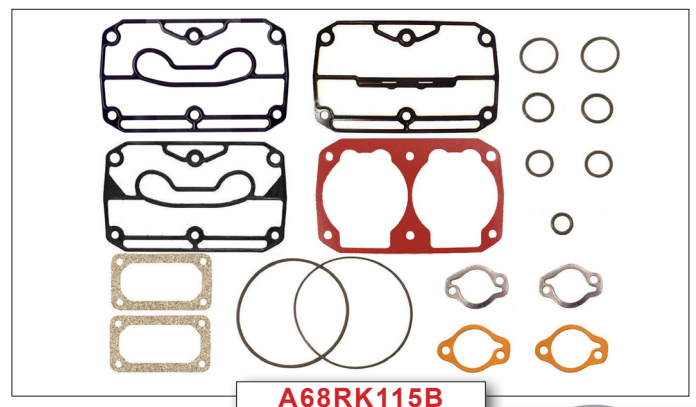

A68RK115B

Check our web site for suitability of these and other parts, or contact us directly. Original part numbers are used for reference only. Check all applications. All parts offered are Majorsell brand and may not be of an original supply. Majorsell kit content and ring sets may be different to the original.



LK4935 - LK4936



Crankshaft



Front bush

050205



140015



2 used

220044



Head

Head bolts

140102
6 used

140138
6 used

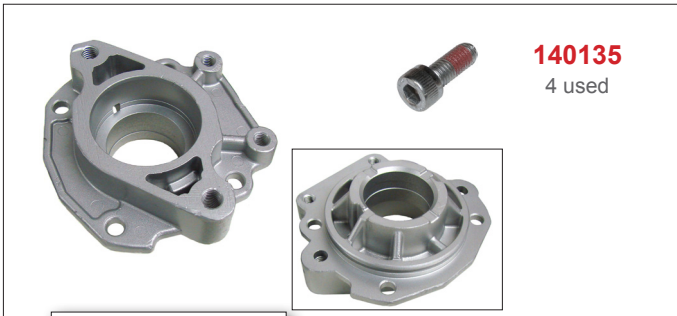
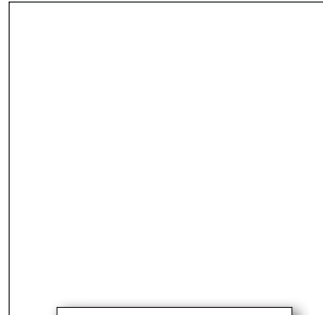
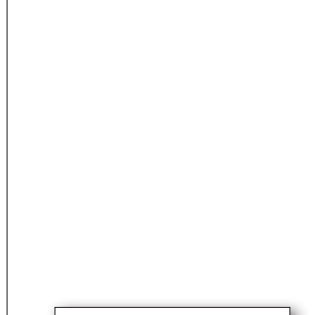

End cover

140135
4 used



2 used

220097



140125
8 used

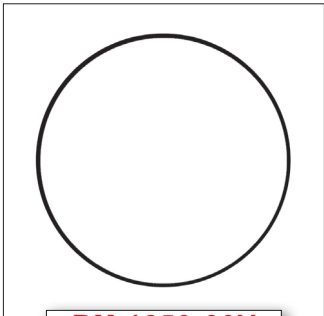

RM 1250-30V

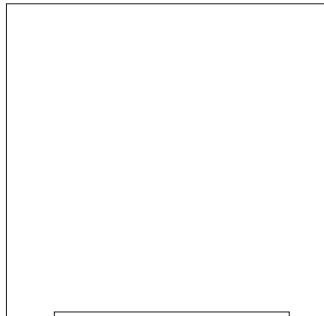

Majorsell

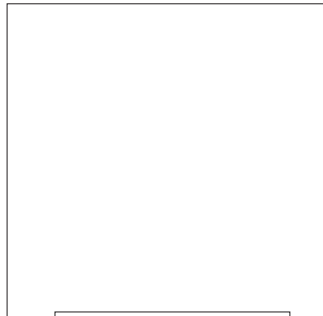

Majorsell

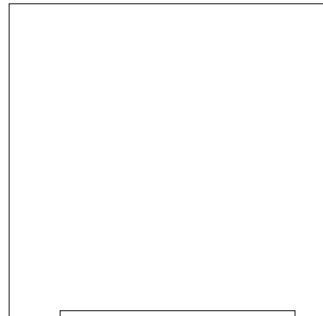

Majorsell



Majorsell

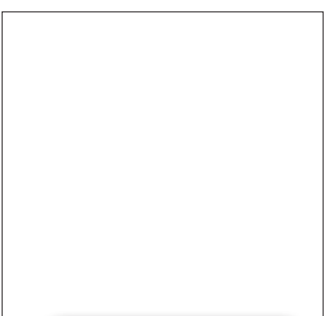

Majorsell

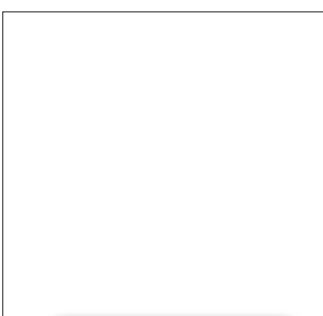

Majorsell

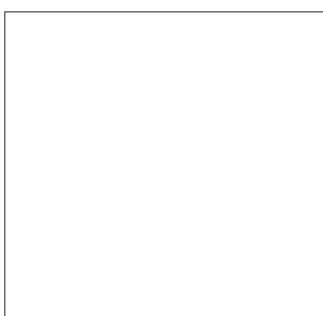

Majorsell

Majorsell parts for :-

LK4939

Principal users :-
MAN

**MAJORSELL
REBUILD**

LK4939

51541007069

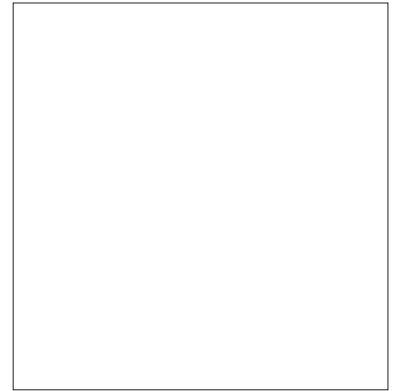

- 88 mm bore.
- Non-through drive.
- Water cooled.
- Air inlet - manifold
- Weight 18 Kg.
- Flange mount.
- Engine oil lubrication.
- Water ports M16 x 1.5 mm.
- Air delivery M26 x 1.5 mm.

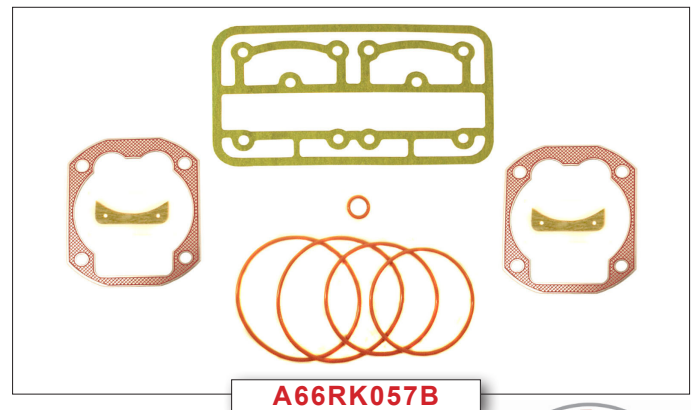
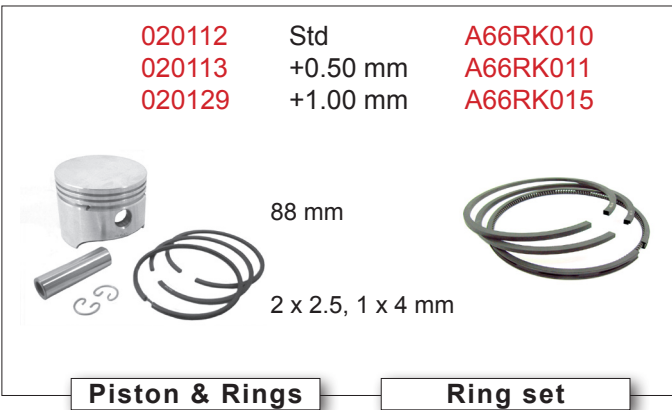
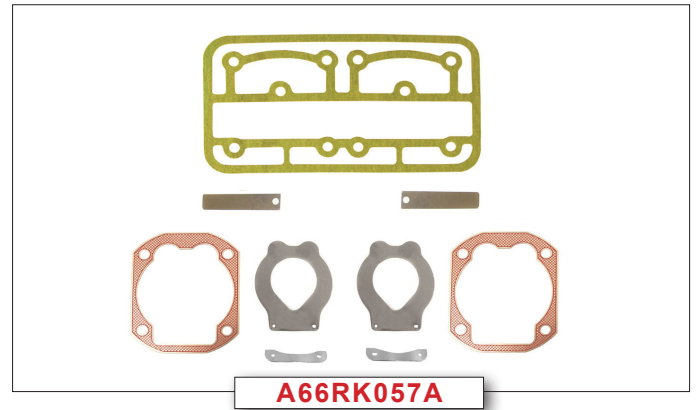
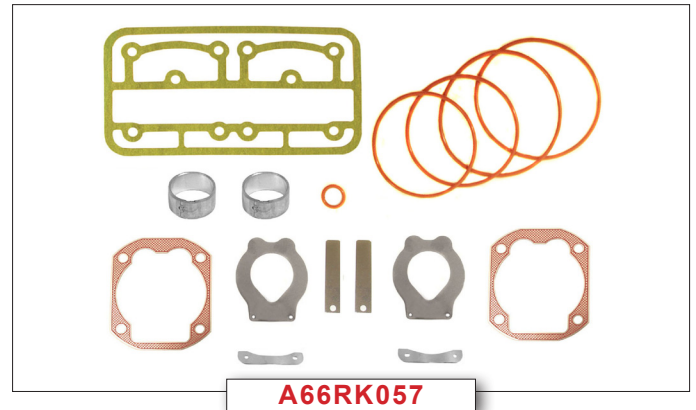
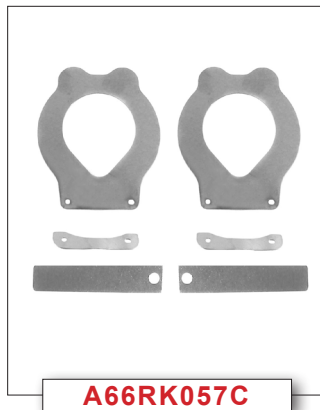

Check our web site for suitability of these and other parts, or contact us directly.
Original part numbers are used for reference only. Check all applications.
All parts offered are Majorsell brand and may not be of an original supply.
Majorsell kit content and ring sets may be different to the original.



LK4939

In development

Crankshaft

In development

Head

Head bolts

In development

End cover

Majorsell

Majorsell

Majorsell

Majorsell

Majorsell

Majorsell

Majorsell

Majorsell parts for :-

LP4949

Principal users :-
Volvo

MAJORSSELL
REBUILD

8112821 - 3118286

66A024R

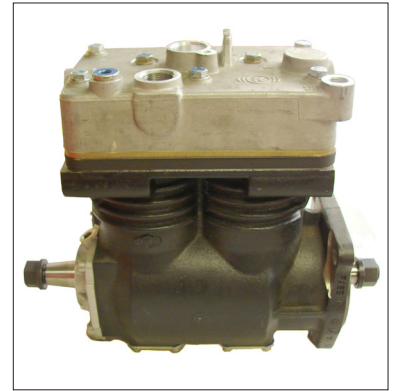

- 88 mm bore.
- Through drive.
- Water cooled.
- Air inlet - M26
- Weight 22 Kg
- Flange mount.
- Engine oil lubrication.
- Water ports : M18 x 1.5 mm.
- Air delivery : M22 x 1.5 mm.

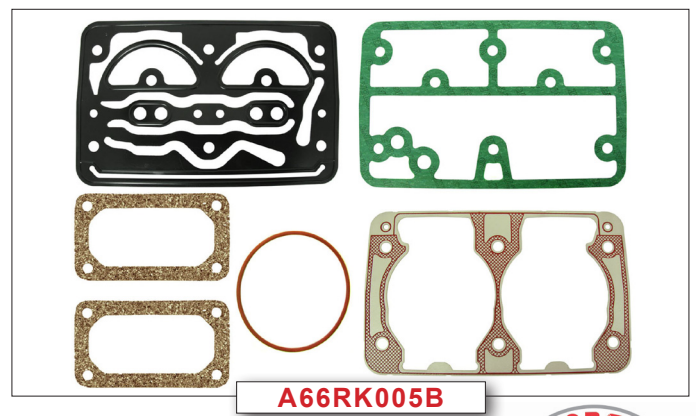
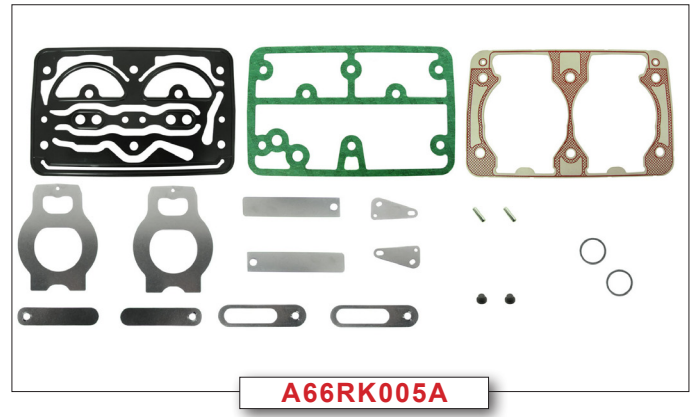
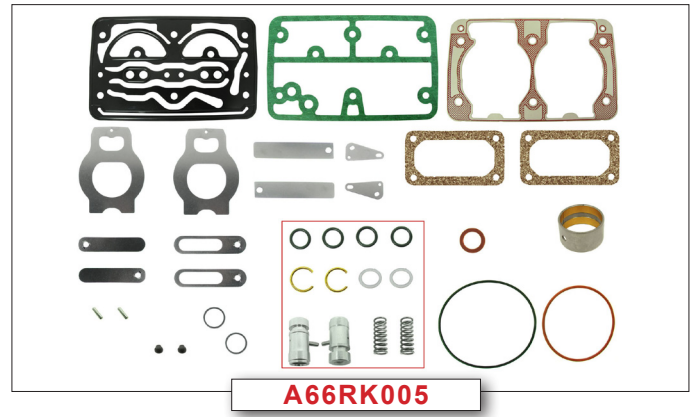
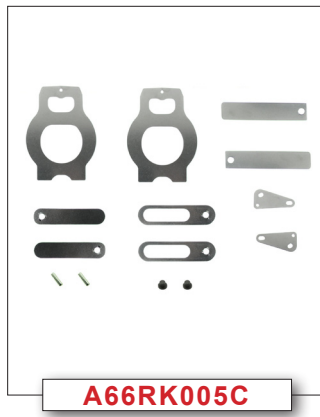

Check our web site for suitability of these and other parts, or contact us directly. Original part numbers are used for reference only. Check all applications. All parts offered are Majorsell brand and may not be of an original supply. Majorsell kit content and ring sets may be different to the original.



LP4949



220216



Front bush

050186



2 used

140016



220069



220073

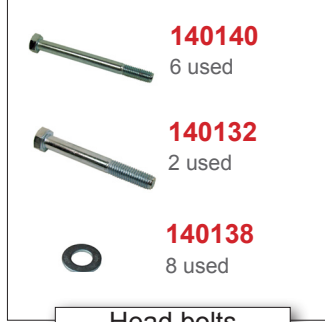

140140

6 used

140132

2 used

140138

8 used

Head bolts



See 'Notes' below

140105-8mm

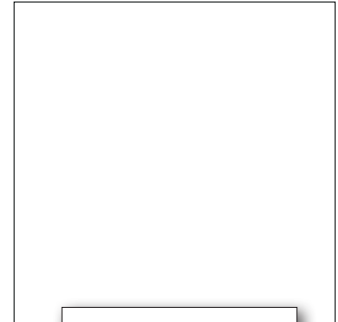

220218

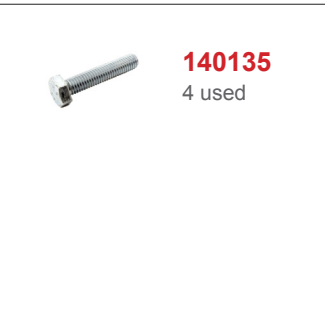

140135

4 used



2 used

220153



140134

8 used

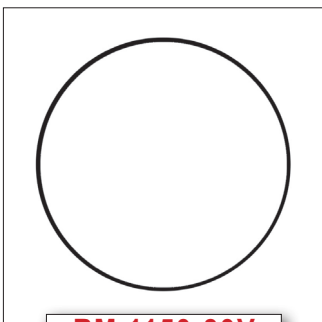

RM 1150-30V



110041

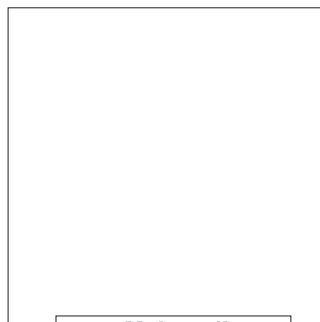

Majorsell

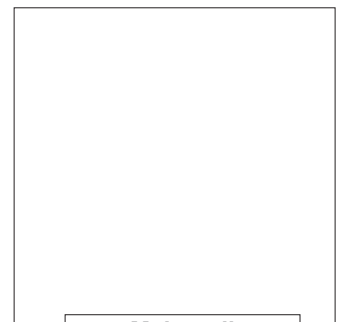

Majorsell

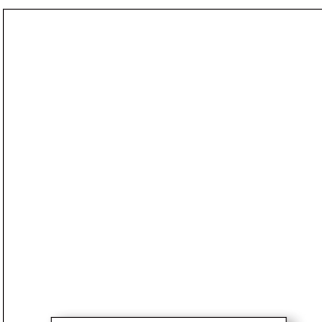

Majorsell

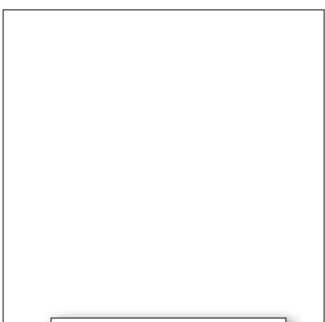

Majorsell

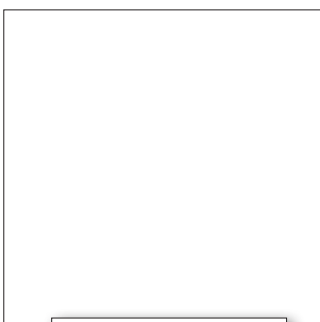

Majorsell

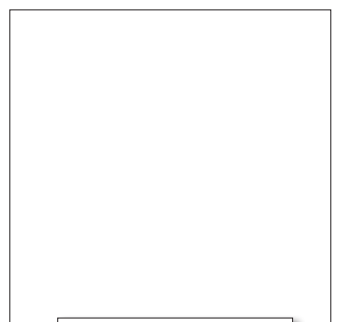

Majorsell

Majorsell parts for :-

LK4954

Principal users :-

MAJORSELL
REBUILD

66A079R

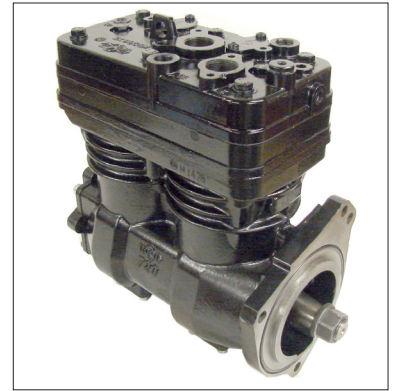

- 92 mm bore.
- Through drive.
- Water cooled.
- Weight 21 Kg.
- Flange mount.
- Engine oil lubrication.
- Water ports M16 x 1.5 mm.
- Air ports M26 x 1.5 mm.

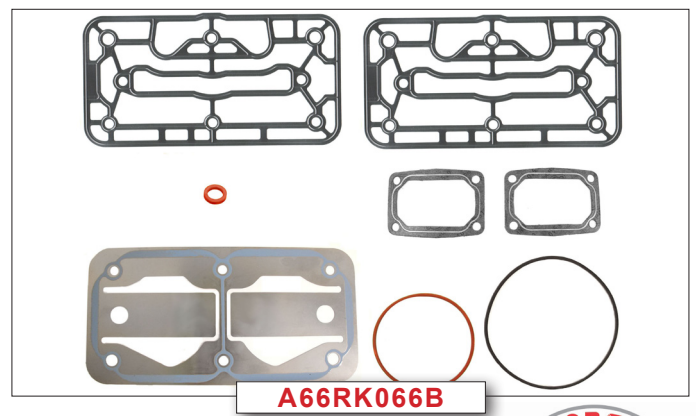
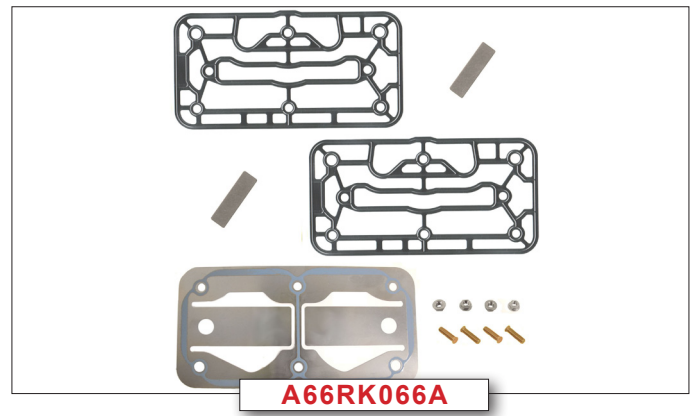
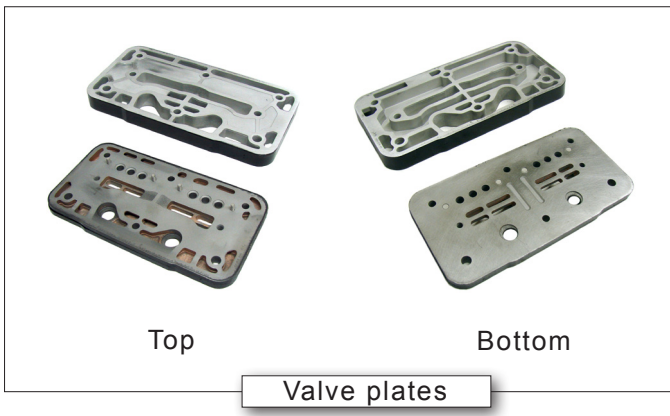
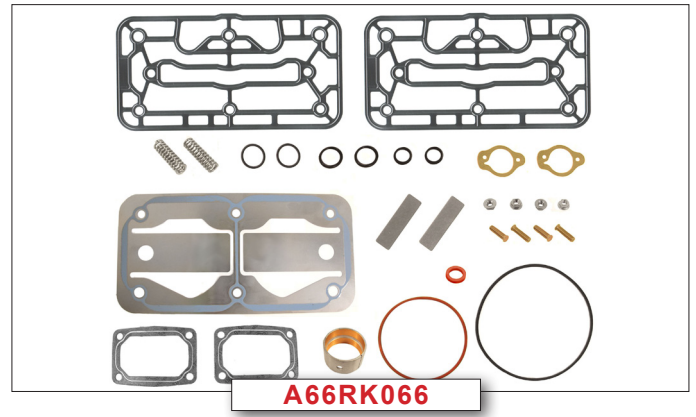

Check our web site for suitability of these and other parts, or contact us directly. Original part numbers are used for reference only. Check all applications. All parts offered are Majorsell brand and may not be of an original supply. Majorsell kit content and ring sets may be different to the original.



LK4954



Crankshaft



Front bush

050186



140016



Conn Rod

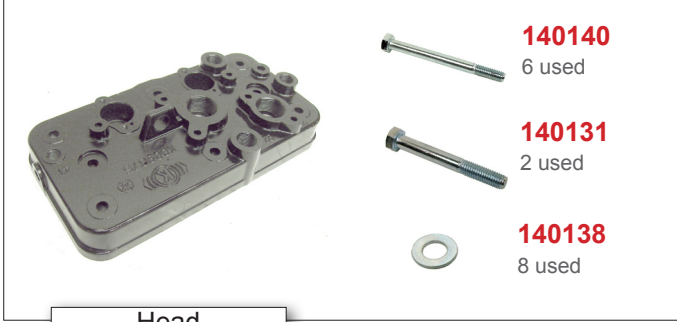

Head

140140
6 used

140131
2 used

140138
8 used

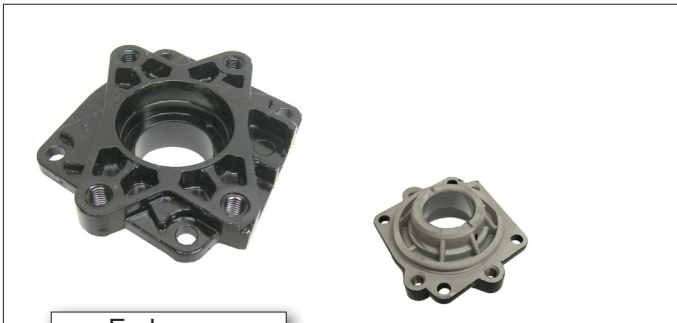
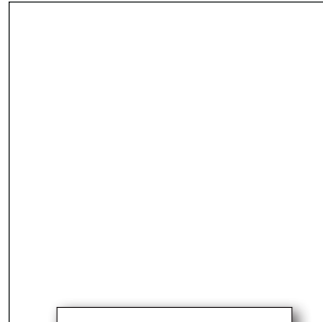
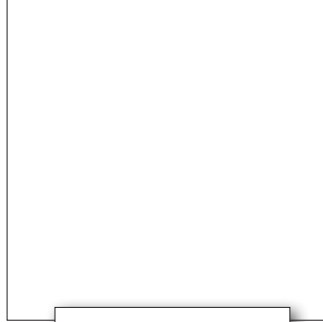

End cover

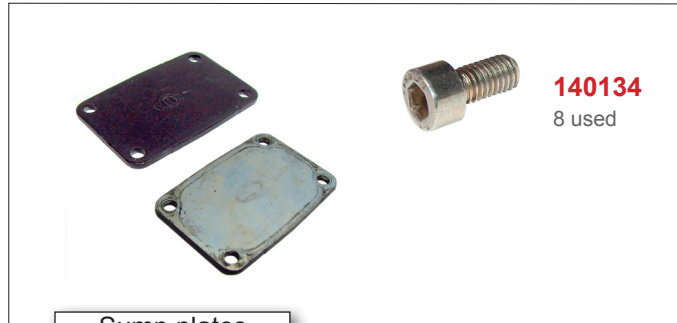

Sump plates

140134
8 used

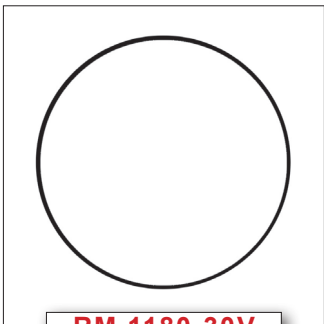

RM 1180-30V

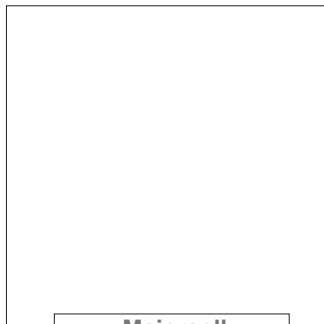

Majorsell



Majorsell

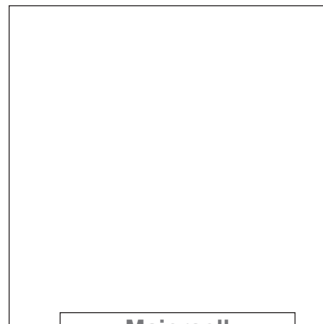

Majorsell

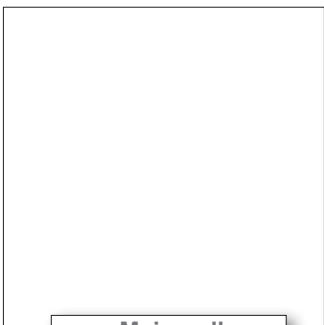

Majorsell

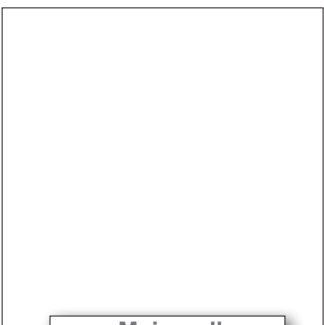

Majorsell

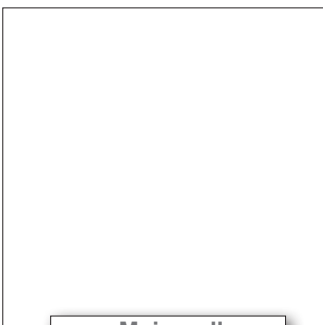

Majorsell

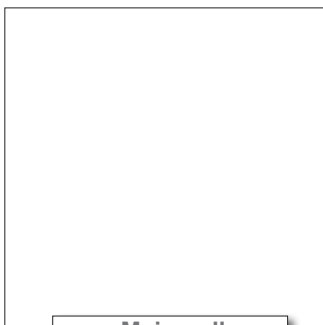

Majorsell

Majorsell Ltd
ENGLAND
sales@majorsell.co.uk
www.majorsell.co.uk

Notes :-

Majorsell parts for :-

LK4959

Principal users :-
Perkins

**MAJORSELL
REBUILD**

2488A302

66A075R

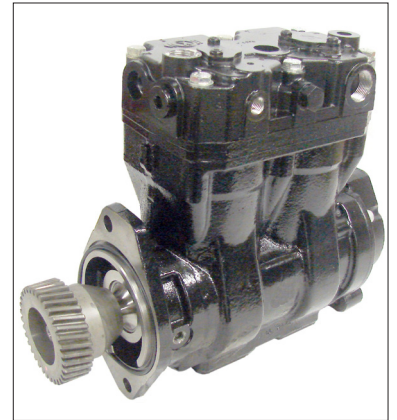

- 86 mm bore.
- Through drive.
- Water cooled.
- Weight 17 Kg
- Flange mount.
- Engine oil lubrication.
- Water ports : M18 x 1.5 mm.
- Air ports : M26 x 1.5 mm.

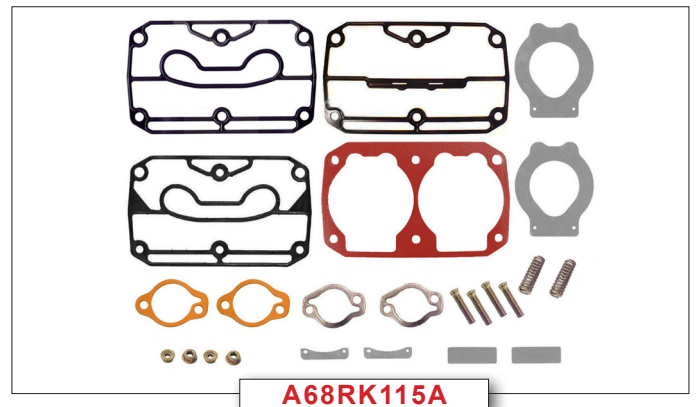
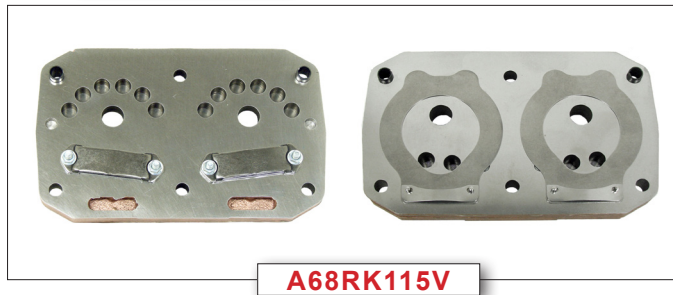
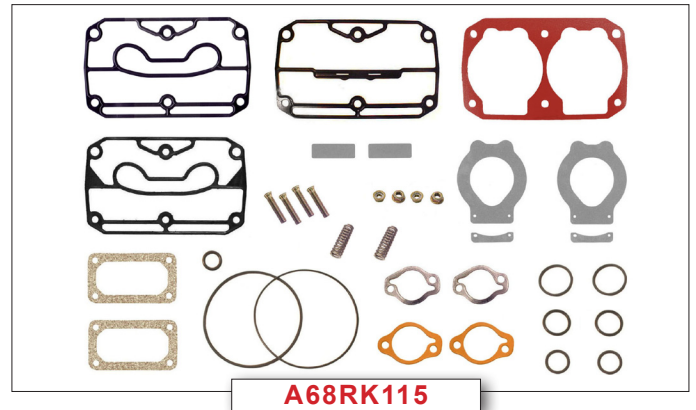
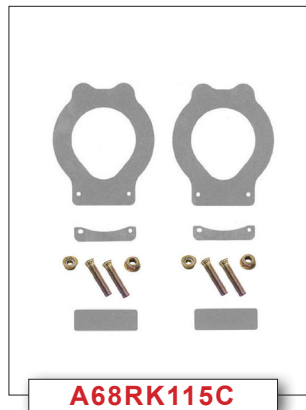
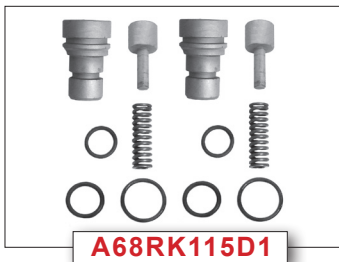

020127	Std	A66RK030
020128	+0.50 mm	A66RK032
020164	+1.00 mm	A66RK068

86 mm
2 x 2 mm
1 x 4 mm

Piston & Rings **Ring set**

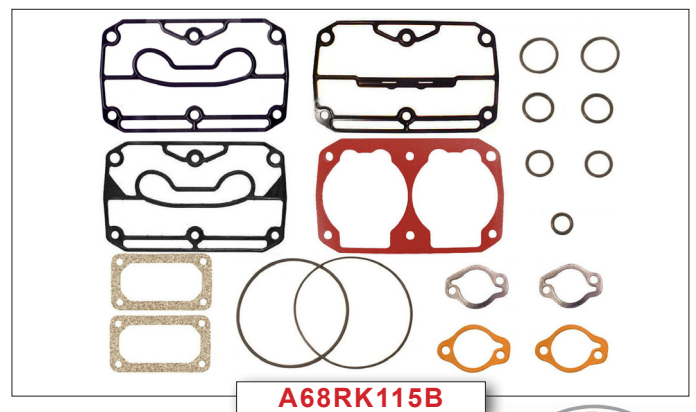

Check our web site for suitability of these and other parts, or contact us directly. Original part numbers are used for reference only. Check all applications. All parts offered are Majorsell brand and may not be of an original supply. Majorsell kit content and ring sets may be different to the original.



LK4959

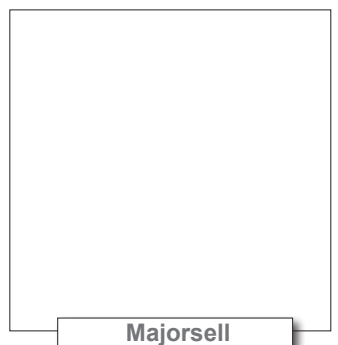
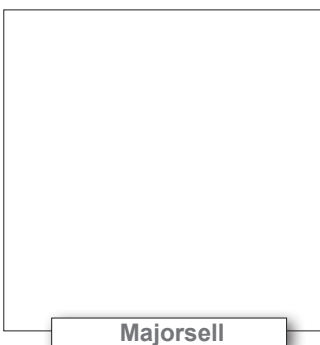
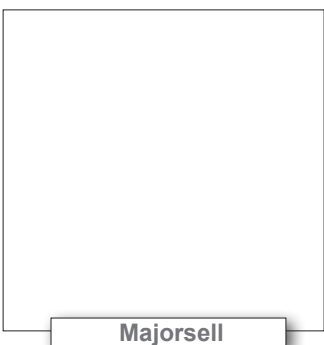
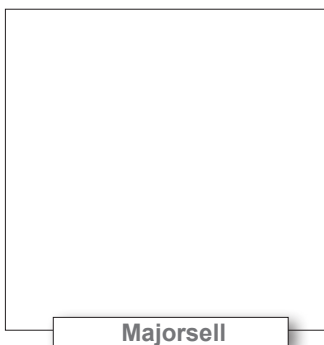
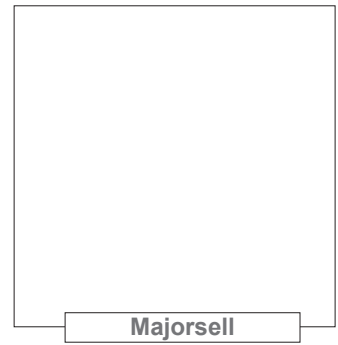
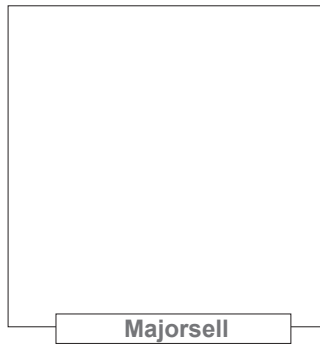
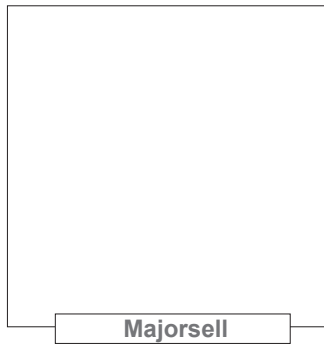
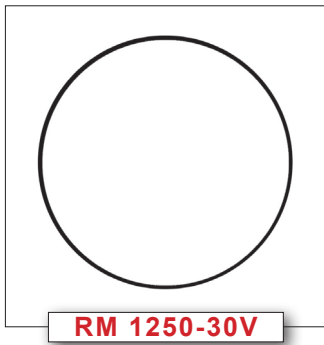
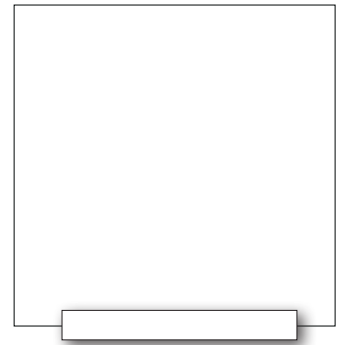
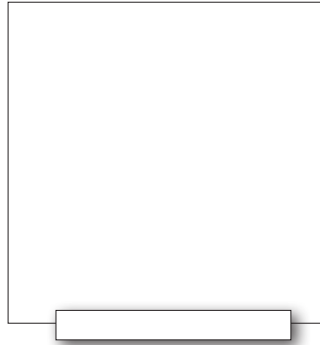
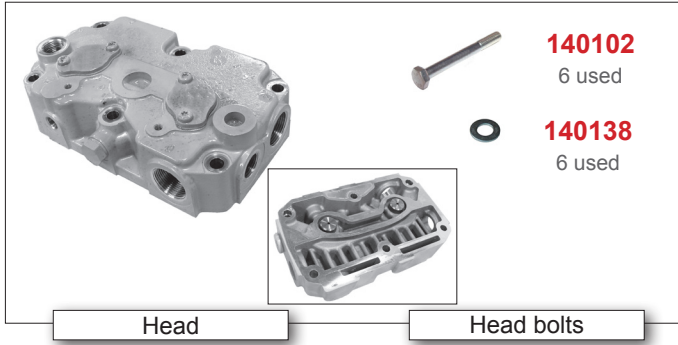
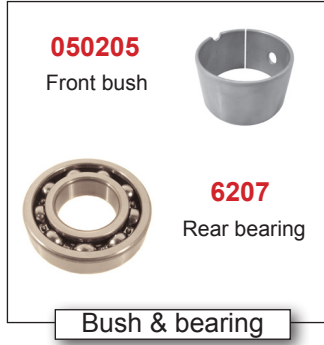
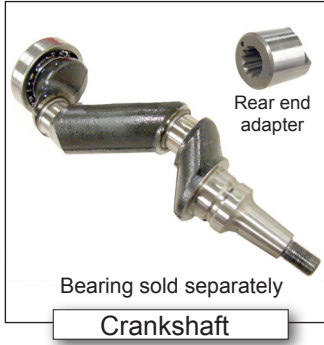

Majorsell Ltd
ENGLAND
sales@majorsell.co.uk
www.majorsell.co.uk

Notes :-

Majorsell parts for :-

LP3970

Principal users :-

**MAJORSELL
REBUILD**

Volvo 20568594 85000345
3181133 8113830

66A090R

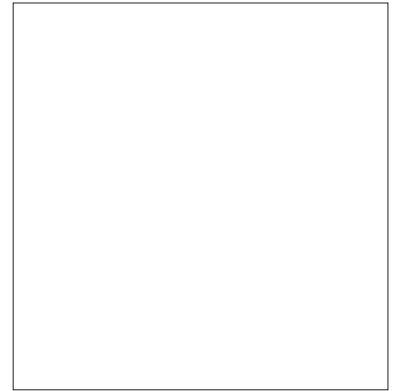

- 92 mm bore.
- Flange mount.
- Used on FL6.
- Non-ESS.

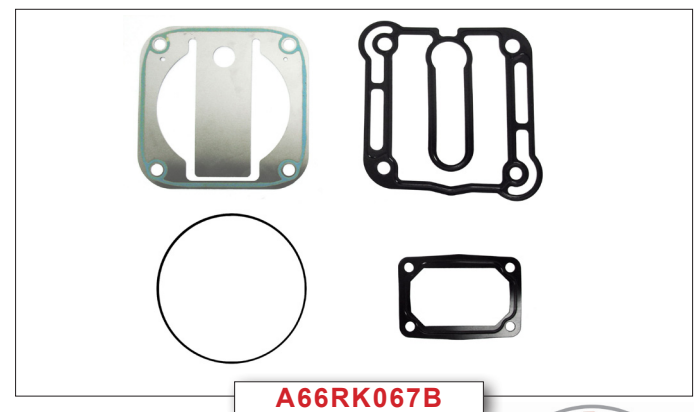
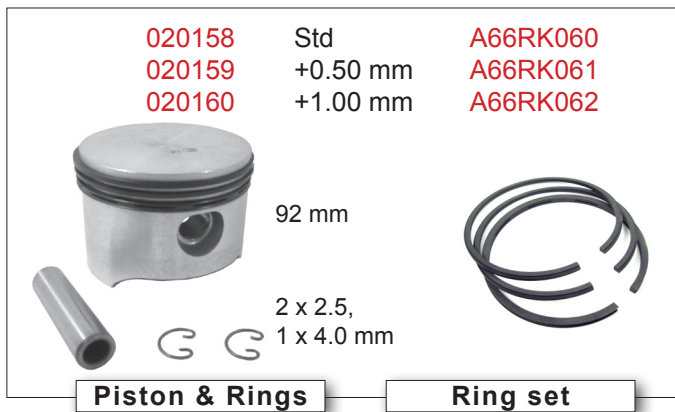
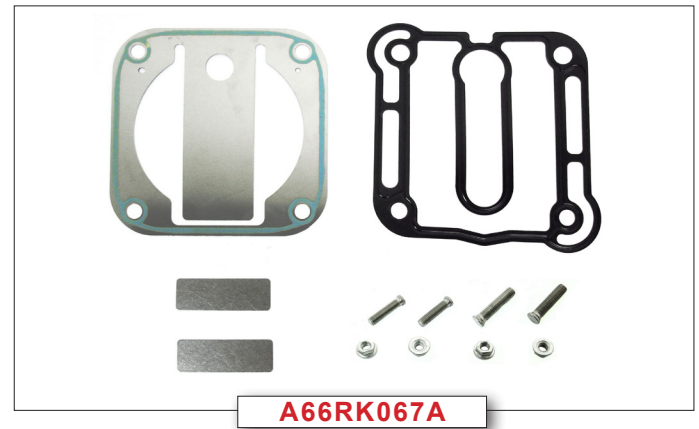
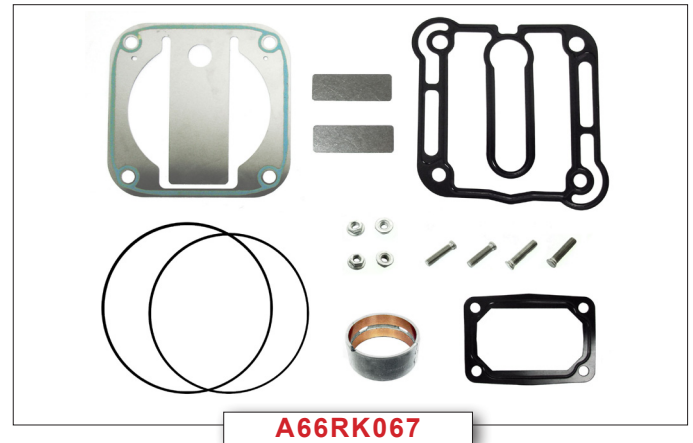
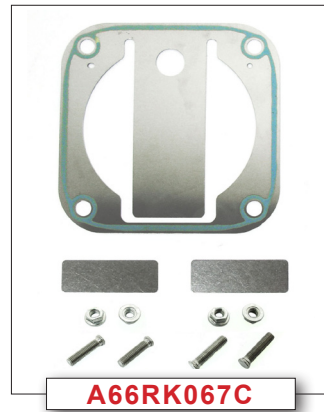

Check our web site for suitability of these and other parts, or contact us directly. Original part numbers are used for reference only. Check all applications. All parts offered are Majorsell brand and may not be of an original supply. Majorsell kit content and ring sets may be different to the original.



LP3970

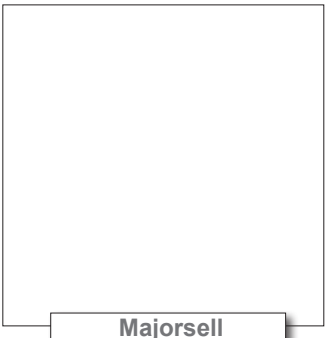
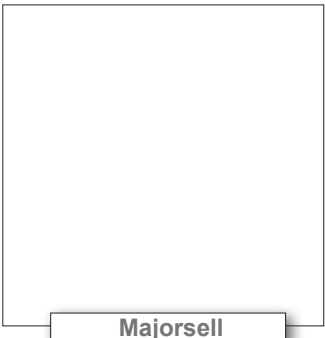
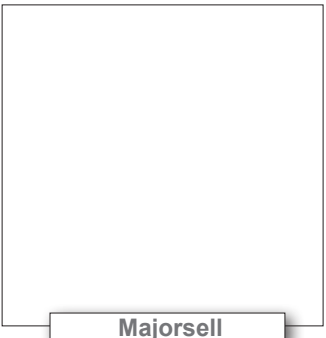
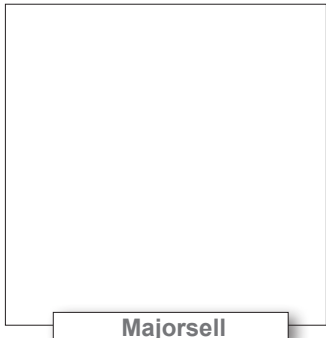
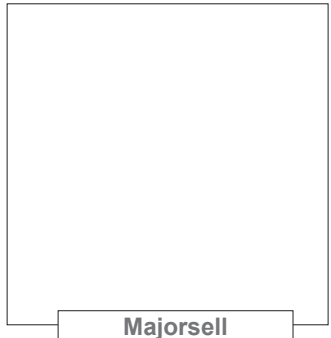
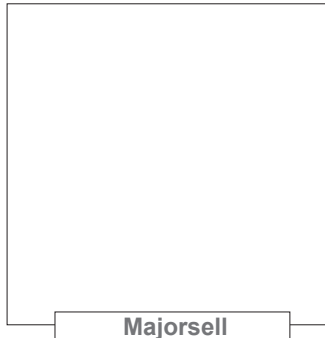
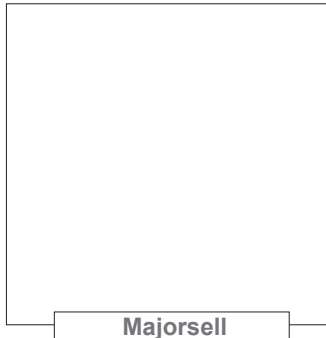
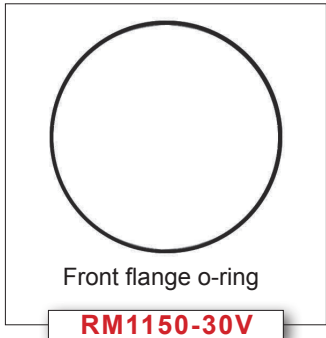
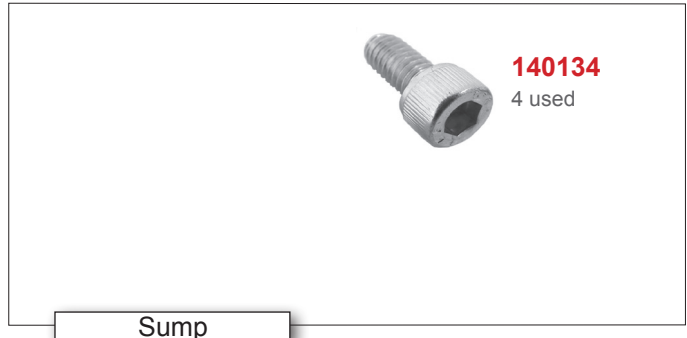
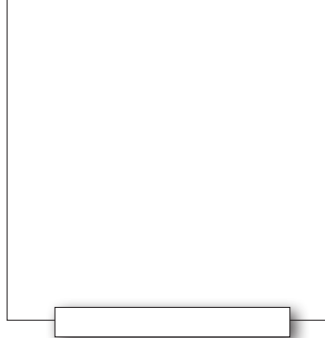
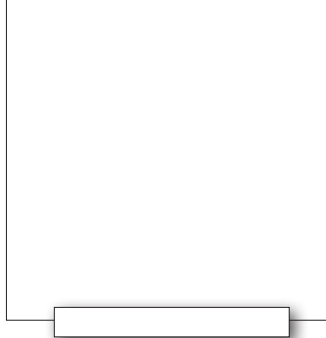
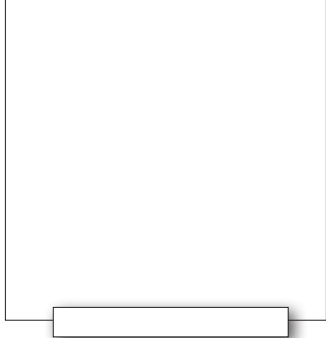
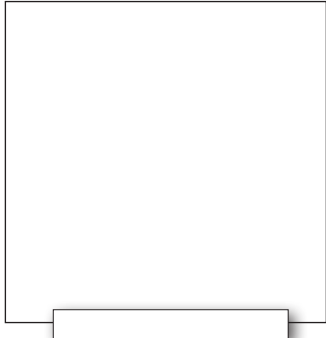

Majorsell parts for :-

LP3975

Principal users :-
Iveco

**MAJORSSELL
REBUILD**

04227084V

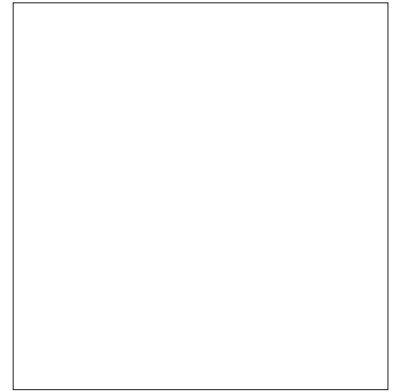

- 88 mm bore.
- Through drive.
- Water cooled.
- Flange mount.
- Engine oil lubrication.
- Water ports : M16 x 1.5.
- Air ports : M26 x1.5.



A66RK001C

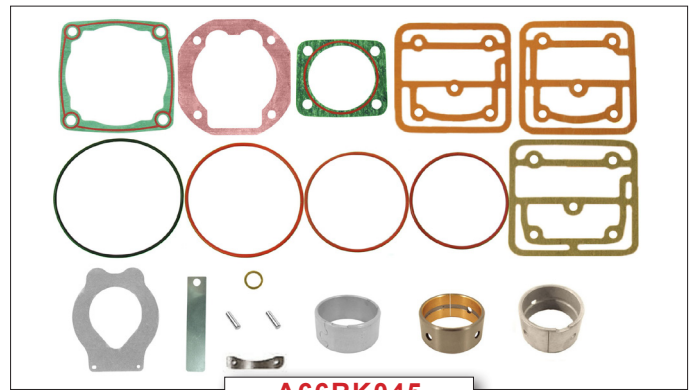

A66RK045

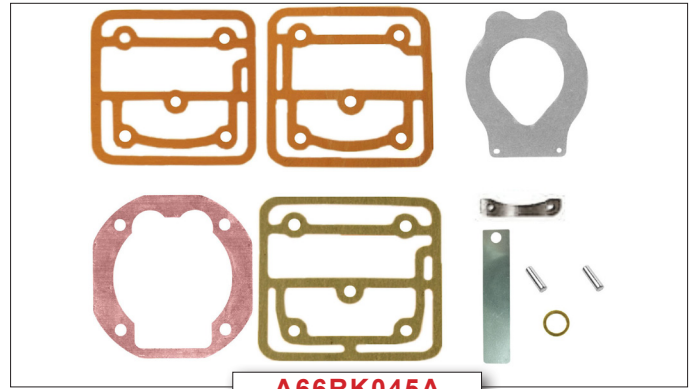
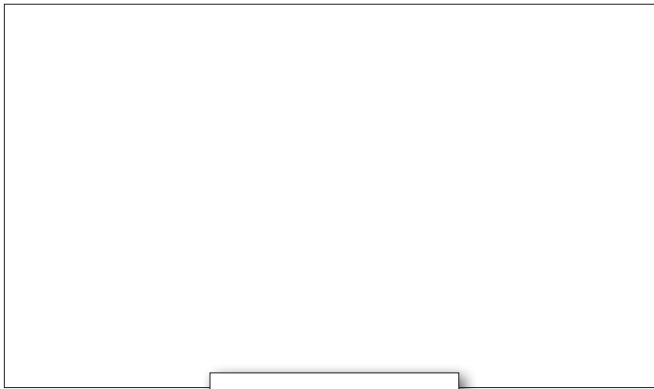

A66RK045A

<p>020112 020113 020129</p> 	<p>Std +0.50 mm +1.00 mm</p> <p>88 mm 2 x 2.5 mm 1 x 4 mm</p> 	<p>A66RK010 A66RK011 A66RK015</p>
---	---	---

Piston & Rings

Ring set

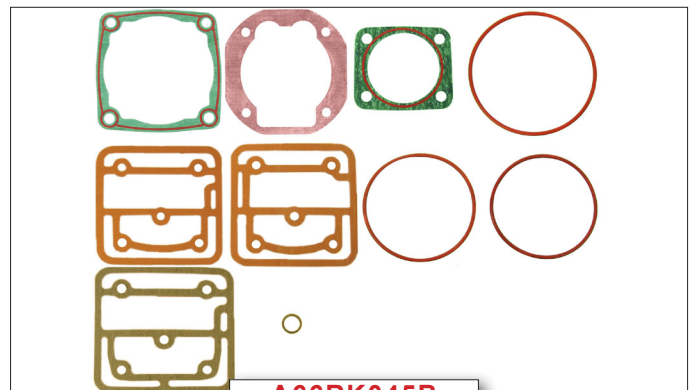

A66RK045B

Check our web site for suitability of these and other parts, or contact us directly.
Original part numbers are used for reference only. Check all applications.
All parts offered are Majorsell brand and may not be of an original supply.
Majorsell kit content and ring sets may be different to the original.



LP3975



Majorsell parts for :-

LP3980 LP3986

Principal users :-
MAN

**MAJORSELL
REBUILD**

LP3980 51541007078 51541007087 51541007095

LP3986

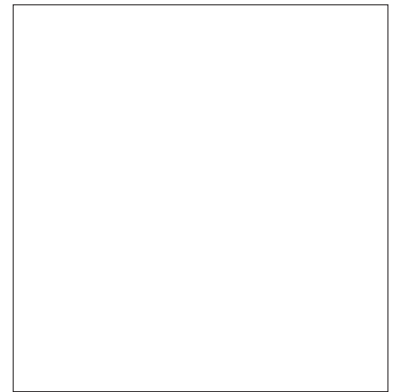

- 92 mm bore.
- Single 360 cm³.
- Through drive.
- Water cooled.
- Weight 18 Kg.
- Side mount.
- Engine oil lubrication.
- Air ports : M26 x 1.5.
- Water ports : M16 x 1.5.

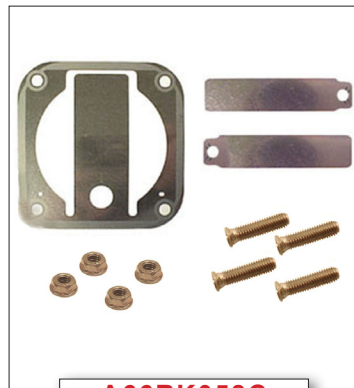

A66RK058C

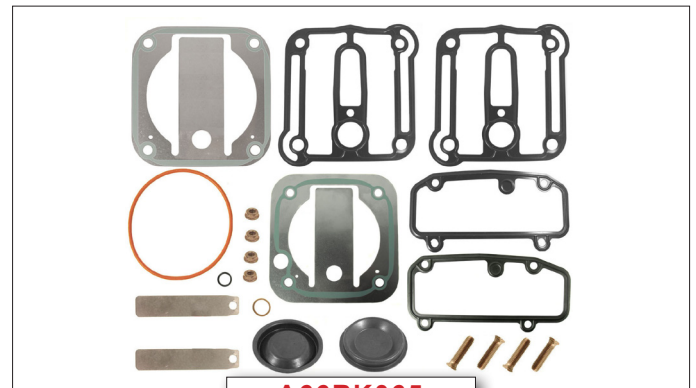

A66RK065



Valve plate
In development

A66RK058V

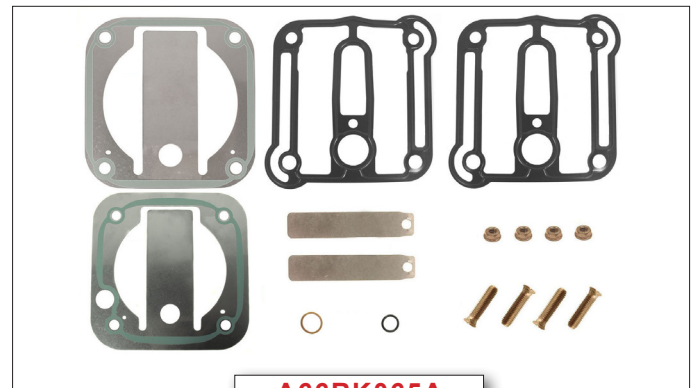

A66RK065A

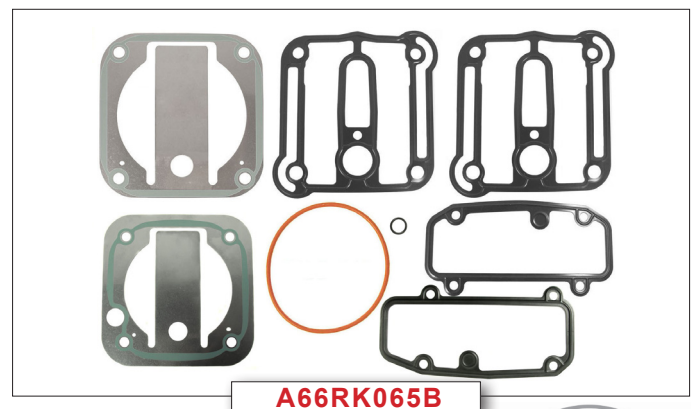

A66RK065B

Check our web site for suitability of these and other parts, or contact us directly.
Original part numbers are used for reference only. Check all applications.
All parts offered are Majorsell brand and may not be of an original supply.
Majorsell kit content and ring sets may be different to the original.



LP3980 LP3986



Majorsell parts for :-

LP3982

Principal users :-

MAN

**MAJORSELL
REBUILD**

51541007016

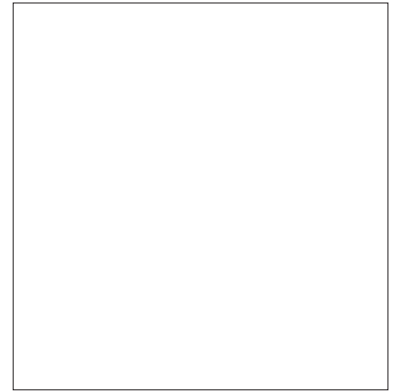

- 88 mm bore.
- Base mount.
- Non-through drive.
- Water cooled.
- Weight 9 Kg
- Single 300 cm³
- Engine oil lubrication.
- Water ports : M22 x 1.5 mm.
- Air ports : M26 x 1.5 mm.

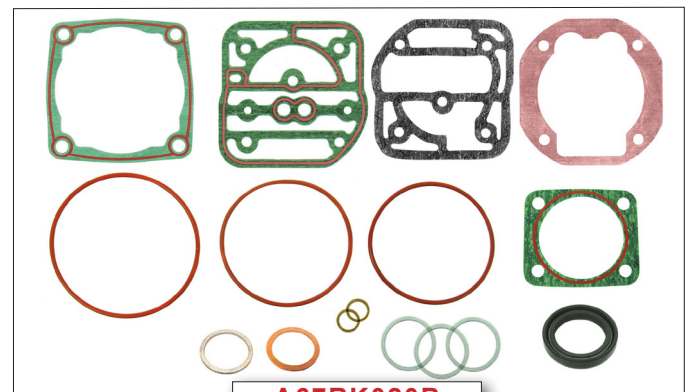
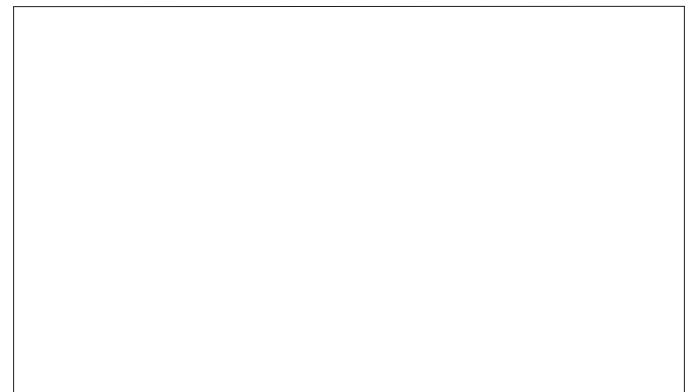

Check our web site for suitability of these and other parts, or contact us directly. Original part numbers are used for reference only. Check all applications. All parts offered are Majorsell brand and may not be of an original supply. Majorsell kit content and ring sets may be different to the original.



LP3982

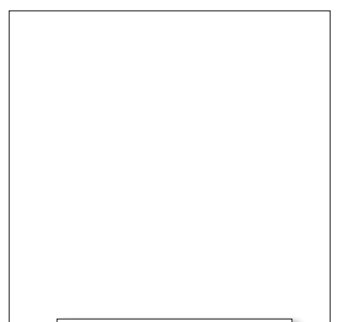
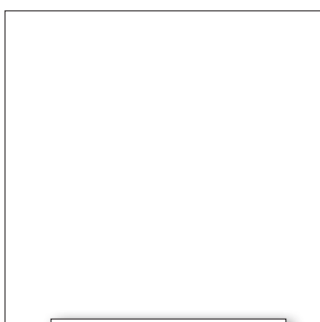
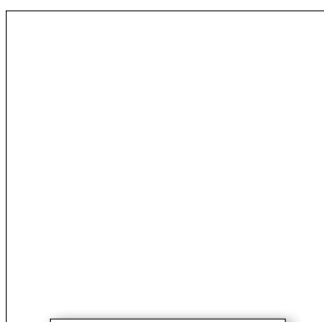
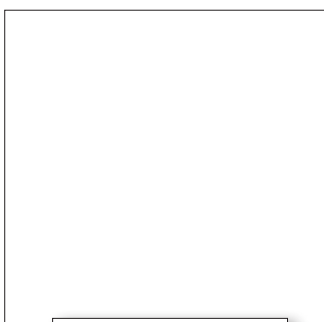
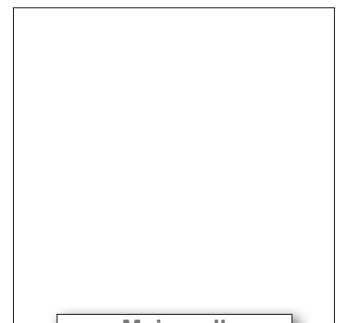
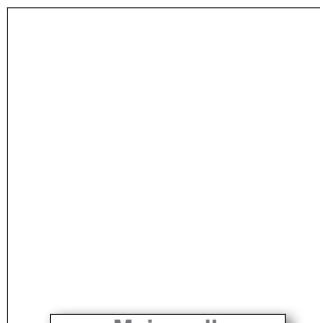
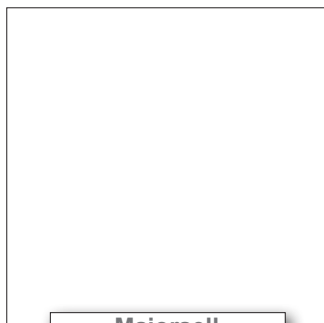
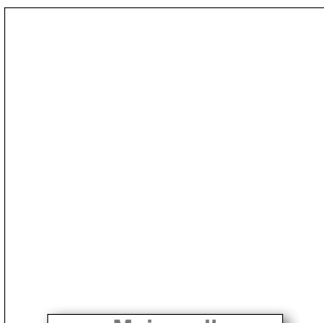
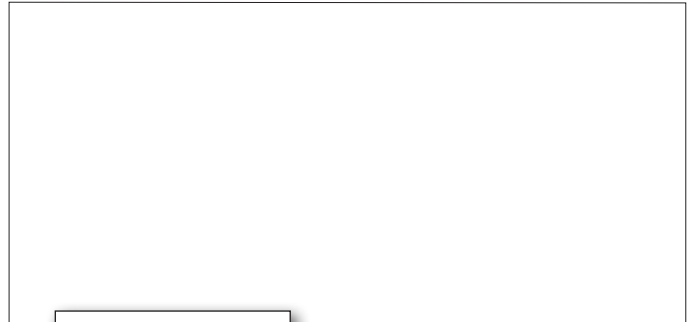
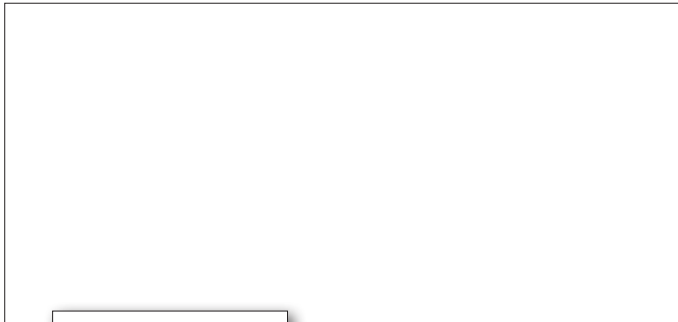
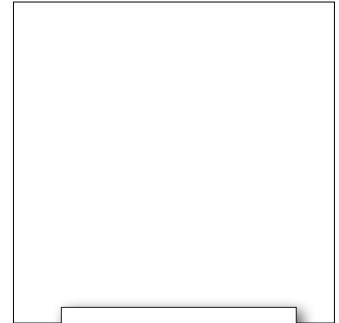
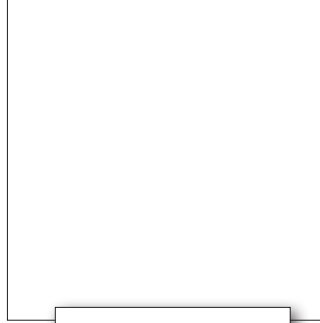
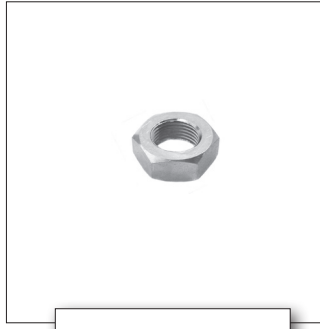
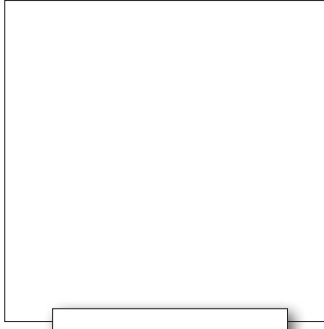

Majorsell parts for :-

LP4812 - LP4813 - LP4814 - LP4815

Principal users :-
Volvo - Iveco

**MAJORSSELL
REBUILD**



LP4812	1599999	5003217	8005487	66A009R
LP4813	1613632	5003336		66A010R
LP4814	1303226	571183		66A011R
LP4815	1303227	571184		66A012R

- 75 mm bore.
- Non through drive.
- Water cooled valve plate.
- Weight 16 Kg.
- Flange mount.
- Engine oil lubrication.
- Water ports : M16 x 1.5.
- Air ports : M26 x1.5.



A66RK007C

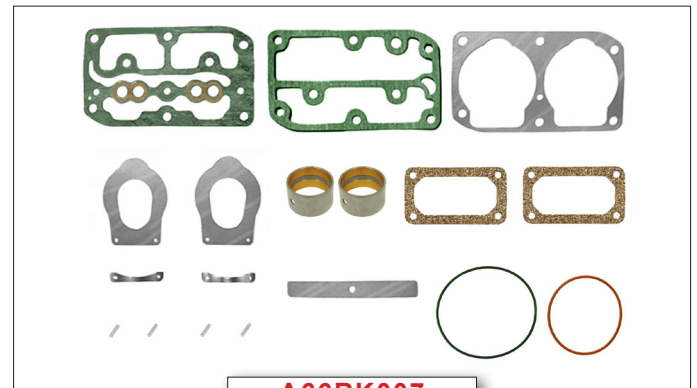

A66RK007



A66RK007V



A66RK007A

020124	Std	A66RK027
020125	+0.50 mm	A66RK028
020126	+1.00 mm	A66RK029

	75 mm	
	2 x 2 mm	
	1 x 4 mm	

Piston & Rings

Ring set

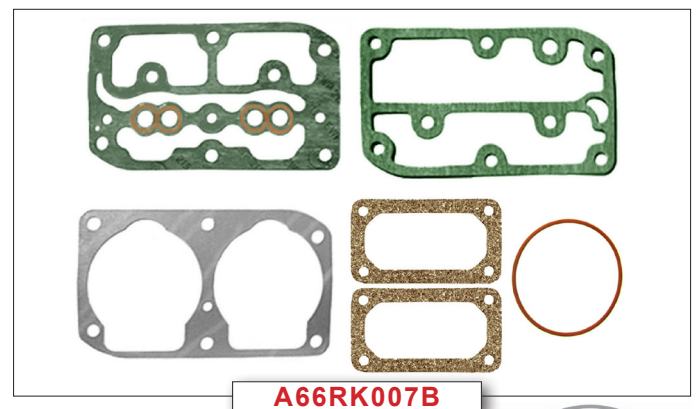

A66RK007B

Check our web site for suitability of these and other parts, or contact us directly. Original part numbers are used for reference only. Check all applications. All parts offered are Majorsell brand and may not be of an original supply. Majorsell kit content and ring sets may be different to the original.



LP4812 - LP4813 - LP4814 - LP4815



220154



Front & rear

050186



Crankshaft nut
right hand thread

140016



2 used

No inserts used

220084

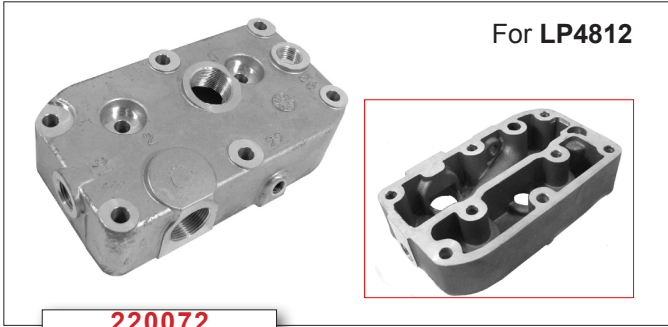

For LP4812

220072



For LP4814 & LP4815

220191

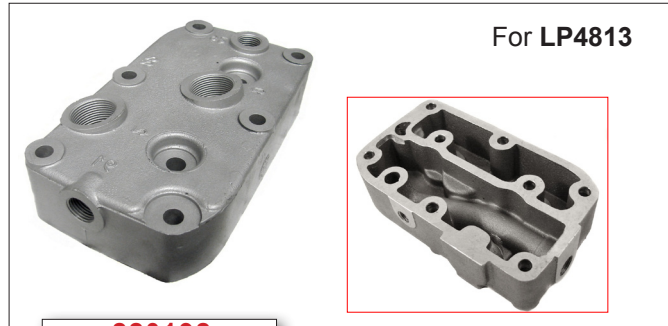

For LP4813

220192

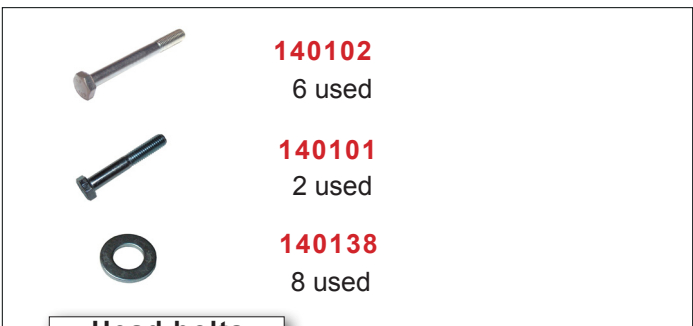

140102

6 used

140101

2 used

140138

8 used

Head bolts



220099

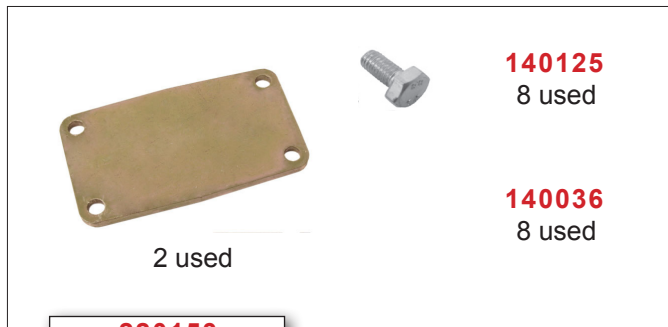

140125
8 used

140036
8 used

2 used

220153

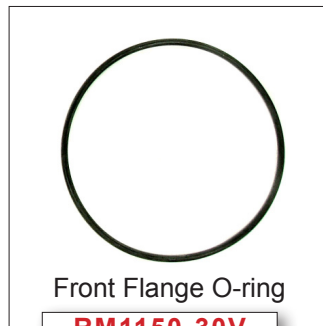

Front Flange O-ring

RM1150-30V

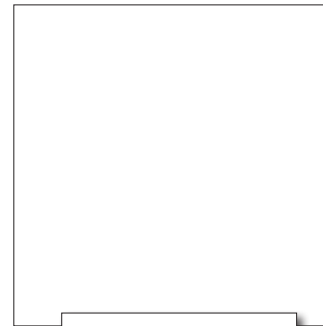
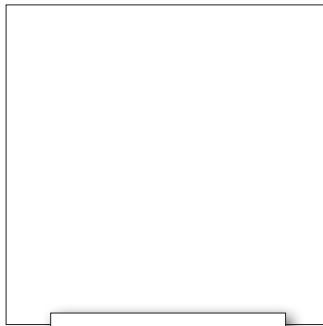
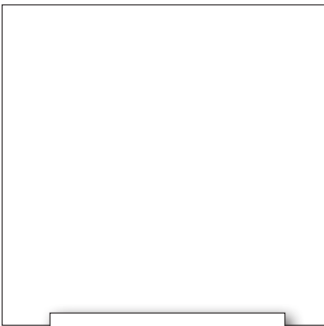

Notes :-

Majorsell parts for :-

LP4825

Principal users :-

Volvo

8112427 8150407

66A013R

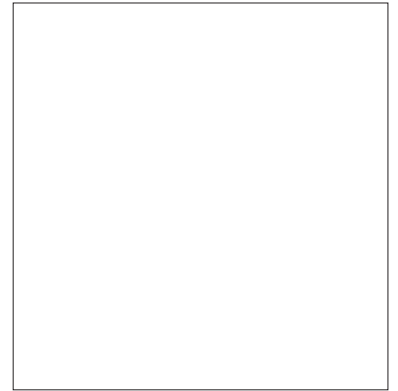

- 75 mm bore.
- Non-through drive.
- Water cooled.
- Water ports : M16 x 1.5.
- Weight 18 Kg.
- Flange mount.
- Engine oil lubrication.
- Air Inlet : manifold
- Air delivery port : M26 x 1.5.



A66RK005D



A66RK004C

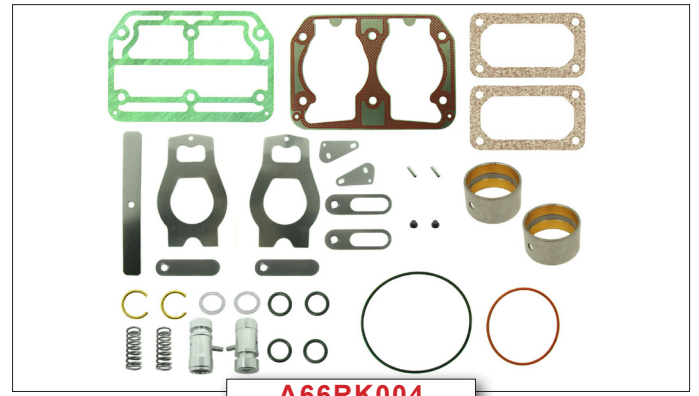

A66RK004



A66RK004V

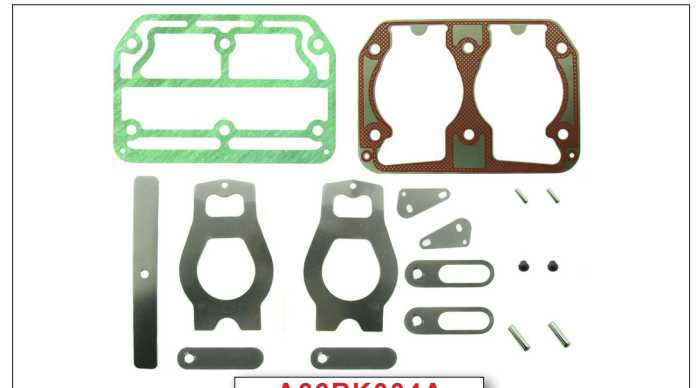

A66RK004A

020124	Std	A66RK027
020125	+0.50 mm	A66RK028
020126	+1.00 mm	A66RK029

75 mm

2 x 2 mm
1 x 4 mm

Piston & Rings

Ring set

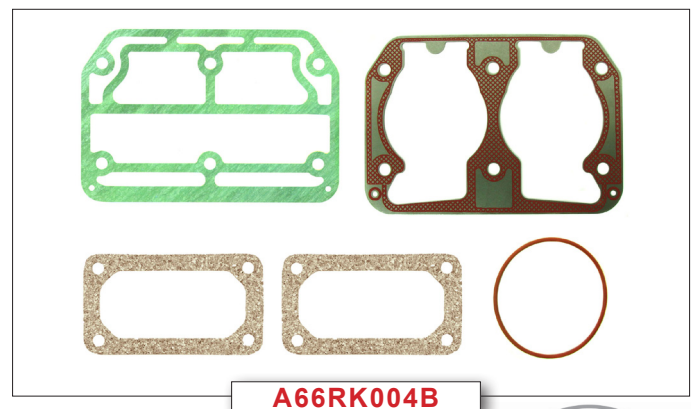

A66RK004B

Check our web site for suitability of these and other parts, or contact us directly. Original part numbers are used for reference only. Check all applications. All parts offered are Majorsell brand and may not be of an original supply. Majorsell kit content and ring sets may be different to the original.



LP4825

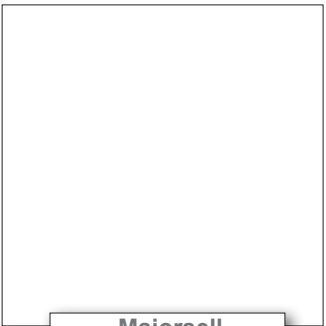
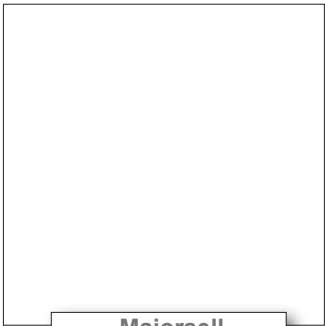
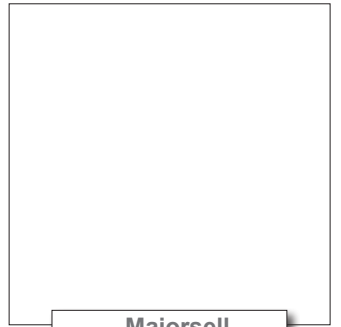
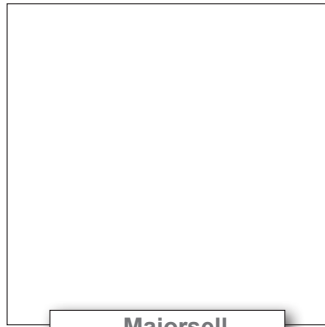
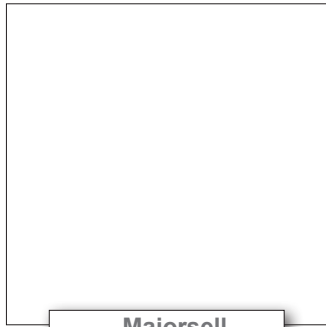
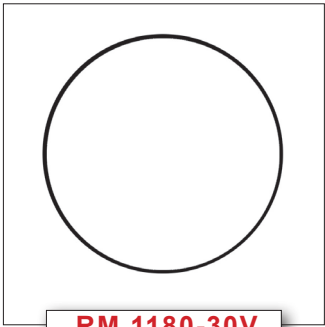
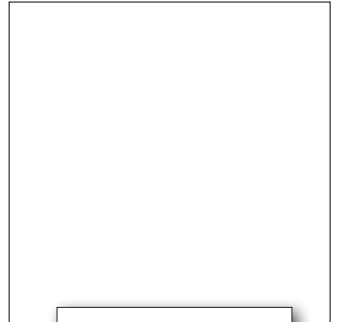
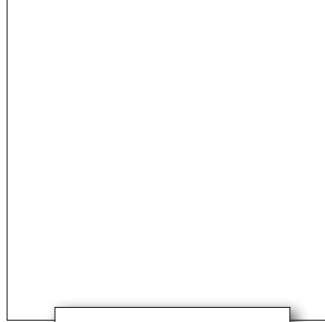

Majorsell parts for :-

LP4844

Principal users :-
Scania

**MAJORSELL
REBUILD**

1381951 1381961 571288

66A067R



- 75 mm bore.
- Non through drive.
- Water cooled.
- Weight 16 Kg.
- Flange mount.
- Engine oil lubrication.
- Air Inlet and delivery ports : M26 x 1.5.
- Water ports : M16 x 1.5.

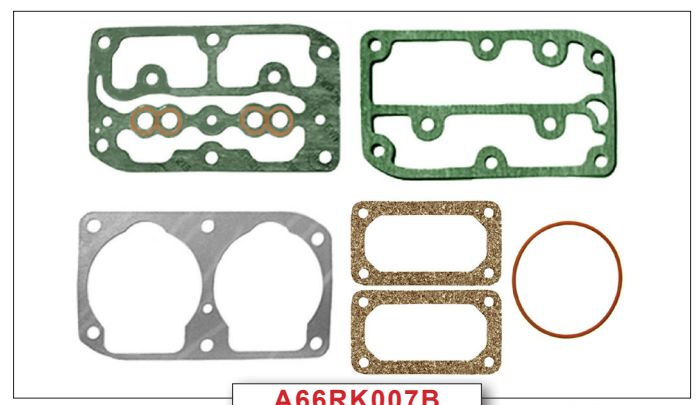

Check our web site for suitability of these and other parts, or contact us directly. Original part numbers are used for reference only. Check all applications. All parts offered are Majorsell brand and may not be of an original supply. Majorsell kit content and ring sets may be different to the original.



LP4844



220154



Front & rear bush

050181



Crankshaft nut
Right hand thread

140016



2 used

220084



220191

140143
8 used

140132
2 used

140138
8 used

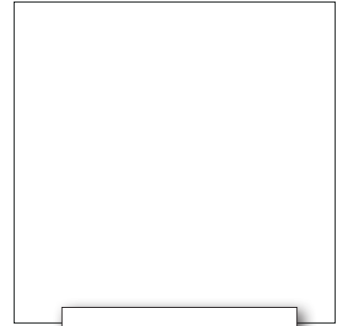
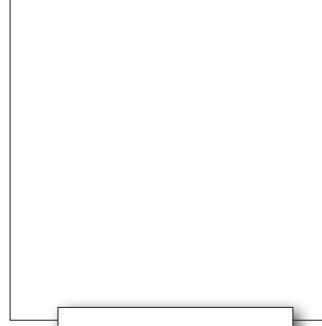

220099



2 used

220153

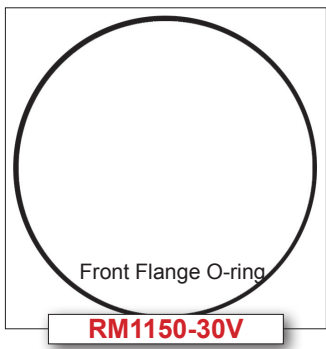

Front Flange O-ring

RM1150-30V

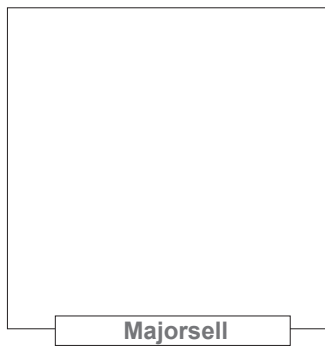

Majorsell

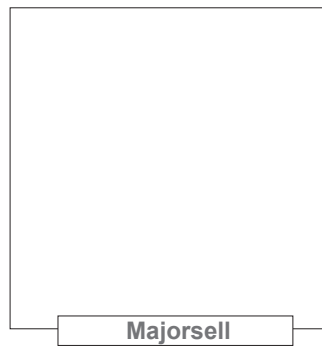

Majorsell

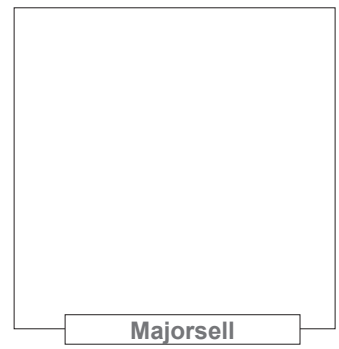

Majorsell

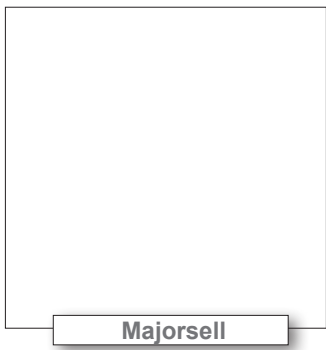

Majorsell

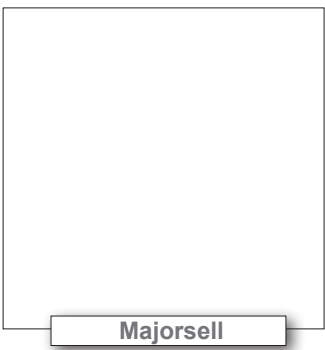

Majorsell

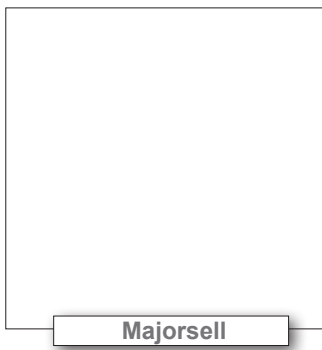

Majorsell

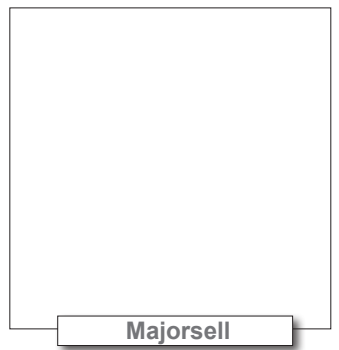

Majorsell

Majorsell Ltd
ENGLAND
sales@majorsell.co.uk
www.majorsell.co.uk

Notes :-

Majorsell parts for :-

LP4852

Principal users :-

Iveco

**MAJORSELL
REBUILD**

01181453 01181454

66A129R



- 75 mm bore.
- Flange mount.
- Water cooled.
- Weight 16 Kg.
- Non through drive.
- Engine oil lubrication.
- Water ports M16 x 1.5.
- Air ports M26 x 1.5.

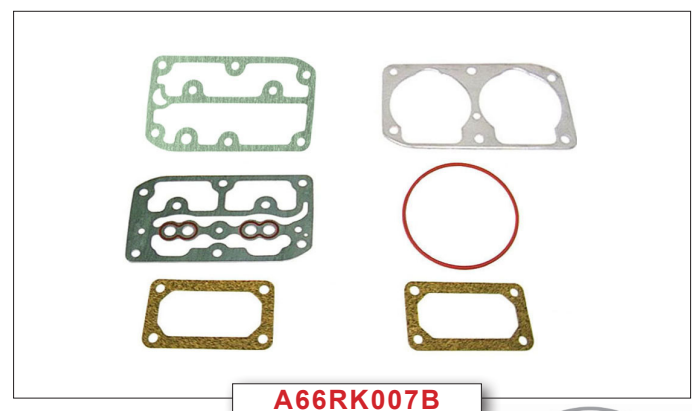
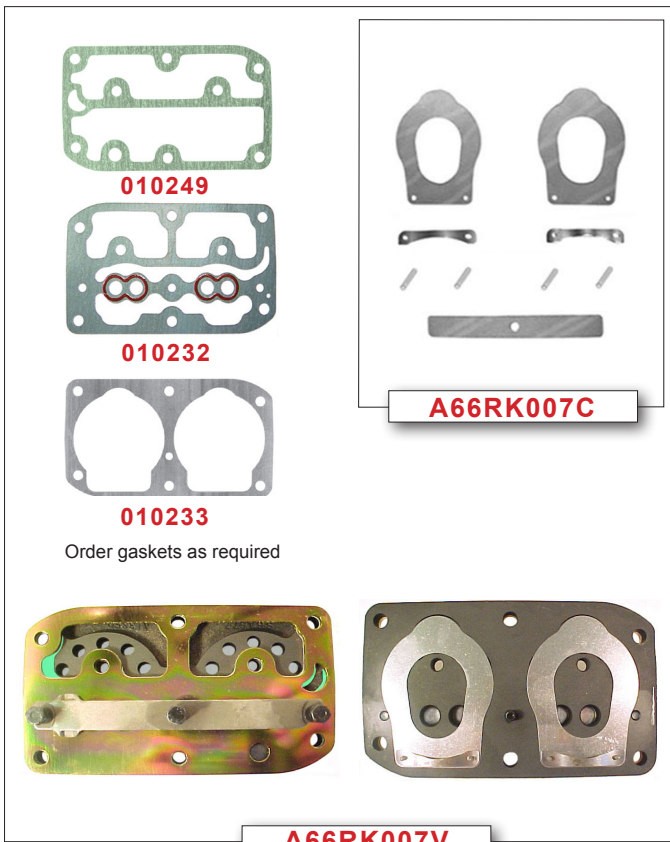

Check our web site for suitability of these and other parts, or contact us directly. Original part numbers are used for reference only. Check all applications. All parts offered are Majorsell brand and may not be of an original supply. Majorsell kit content and ring sets may be different to the original.



LP4852



In development

Crankshaft



Front & rear

050186



Crankshaft nut
-right hand thread

140016



2 used

No inserts used

220084



* Plug as required



140102
6 used



140138
6 used

140101
2 used

Head bolts

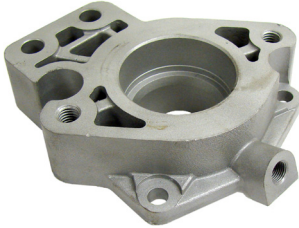

Majorsell

Majorsell

140135
4 used

Rear cover

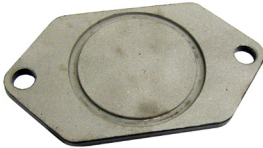
140214
2 used

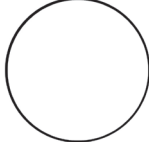
RM0570-30V

Rear cover plate



140134
8 used

2 used

220153

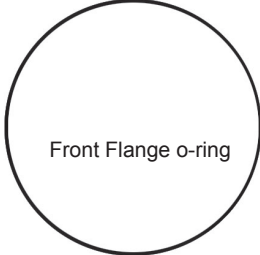

Front Flange o-ring

RM1150-30V

Majorsell

Majorsell

Majorsell

Majorsell

Majorsell

Majorsell parts for :-

LP4855

Principal users :-
RVI

501045646 5010553129

**MAJORSELL
REBUILD
66A100R**

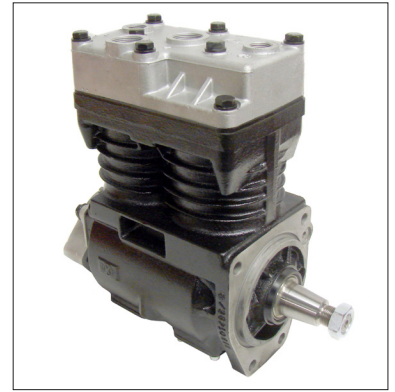

- 78 mm bore.
- Through drive.
- Water cooled.
- Weight 17 Kg.
- Flange mount.
- Engine oil lubrication.
- Water ports : M18 x 1.5.
- Air ports : M26 x 1.5.

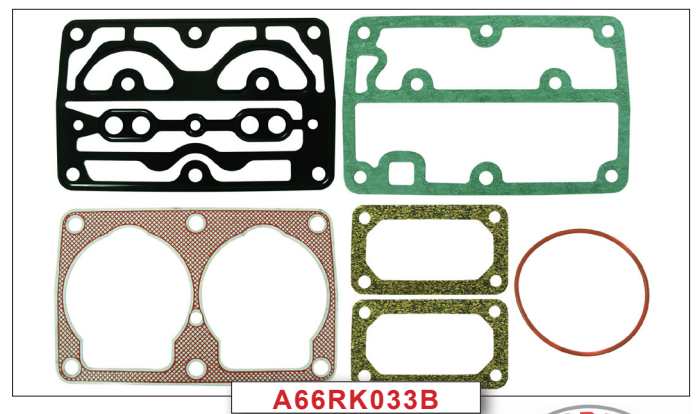
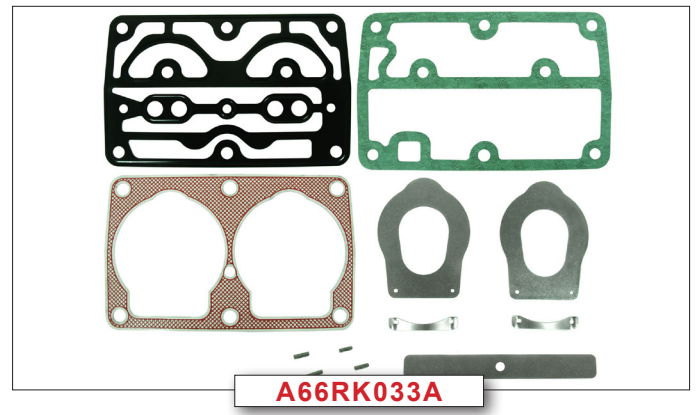
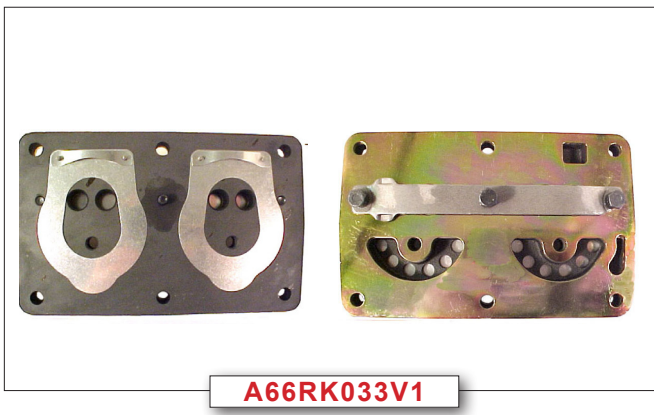
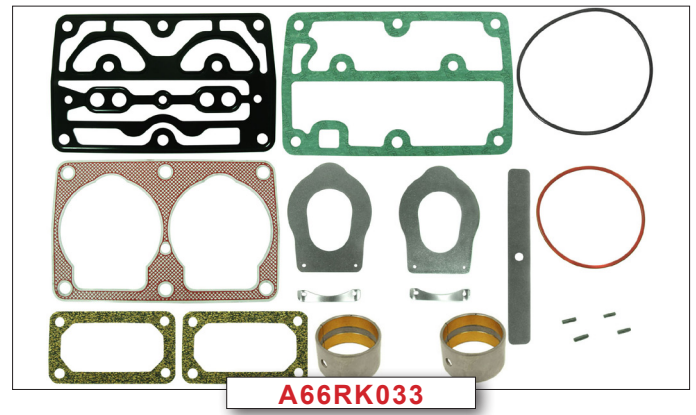

Check our web site for suitability of these and other parts, or contact us directly.
Original part numbers are used for reference only. Check all applications.
All parts offered are Majorsell brand and may not be of an original supply.
Majorsell kit content and ring sets may be different to the original.



LP4855



Crankshaft



Bushes



140015



220250

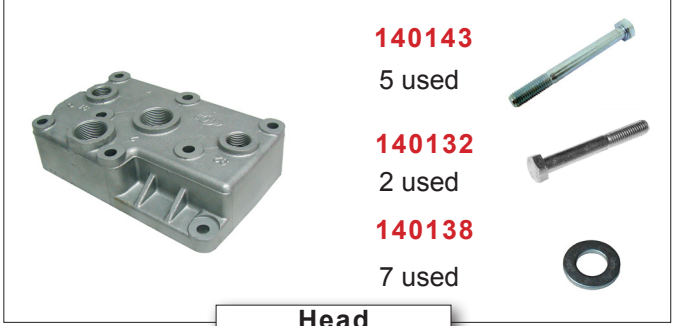

Head

140143
5 used

140132
2 used

140138
7 used

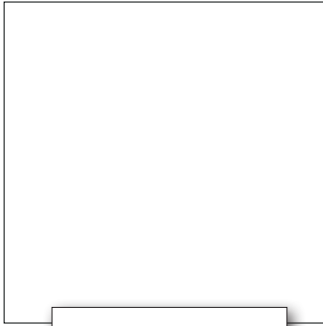
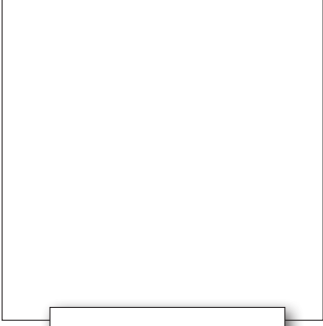

End cover



220153

140134
8 used

2 used

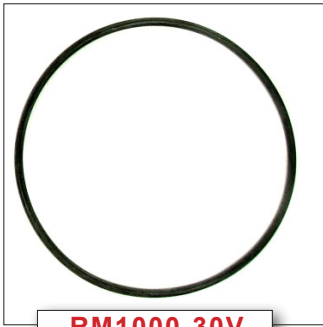

RM1000-30V



160114

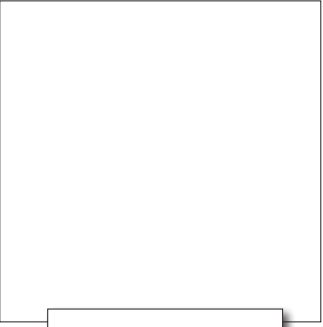
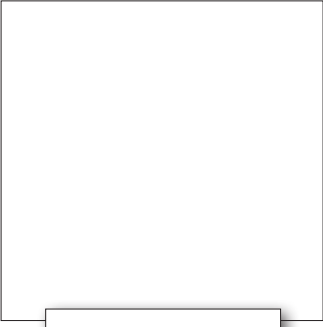
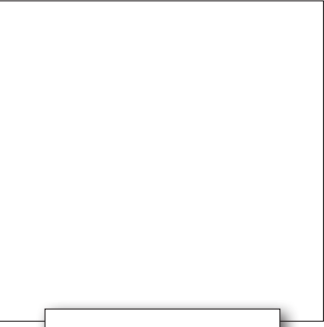
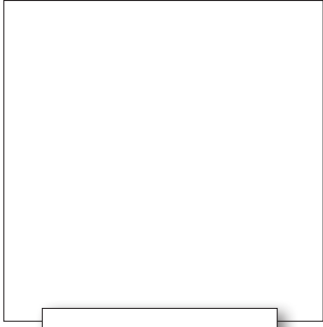
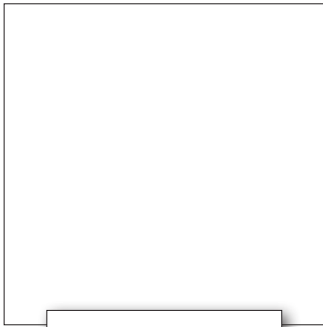
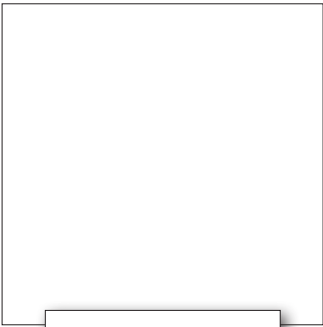

Majorsell parts for :-

LP4914

Principal users :-
Iveco

MAJORSELL
REBUILD

01173112

66A138R

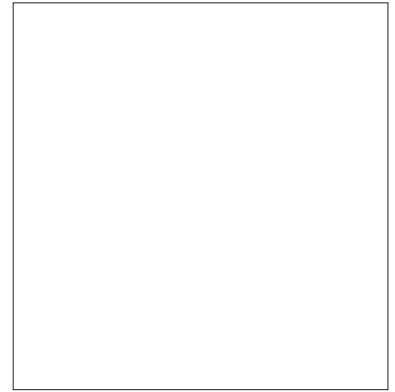

- 88 mm bore.
- Non through drive.
- Water cooled.
- Weight 21 Kg.
- Flange mount V2.
- Engine oil lubrication.
- Water ports : M14 x 1.5.
- Air ports : M26 x 1.5.



A66RK039C

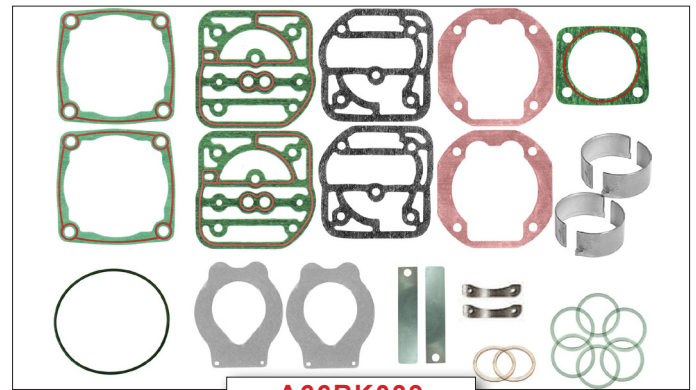

A66RK039

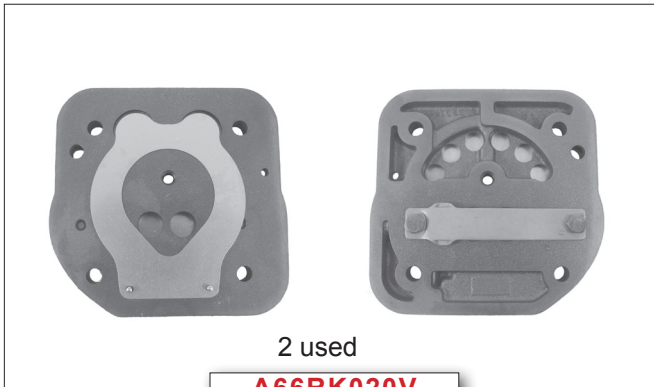

2 used

A66RK020V

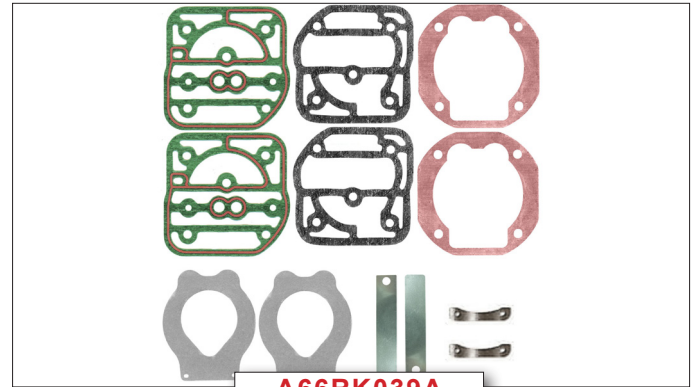

A66RK039A

020112	Std	A66RK010
020113	+0.50 mm	A66RK011
020129	+1.00 mm	A66RK015

	88 mm	
	2 x 2.5 mm	
	1 x 4 mm	

Piston & Rings

Ring set

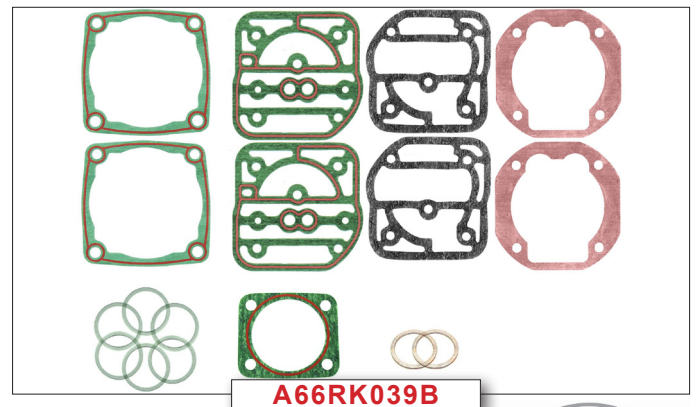

A66RK039B

Check our web site for suitability of these and other parts, or contact us directly.
Original part numbers are used for reference only. Check all applications.
All parts offered are Majorsell brand and may not be of an original supply.
Majorsell kit content and ring sets may be different to the original.



LP4914

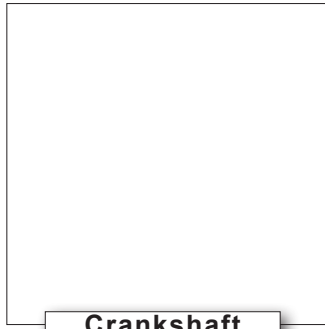

Crankshaft

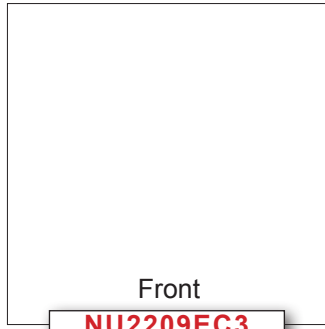

Front

NU2209EC3



140016



050090
2 used

2 used

220152

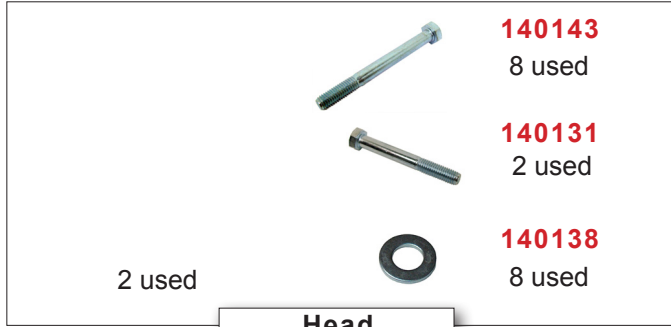

2 used

Head

140143
8 used

140131
2 used

140138
8 used



220139

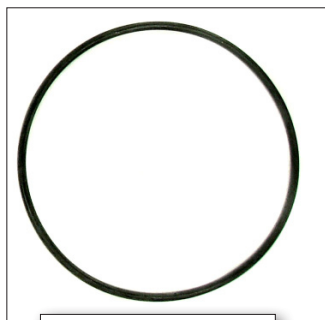

RM0920-30V



2 used

020169L



2 used

020169



140103
8 used

140155
8 used

Majorsell parts for :-

LP4921

Principal users :-
Iveco Volvo

**MAJORSELL
REBUILD**

1174168 8113634
70305892 8113634

**66A062R
66A062R**

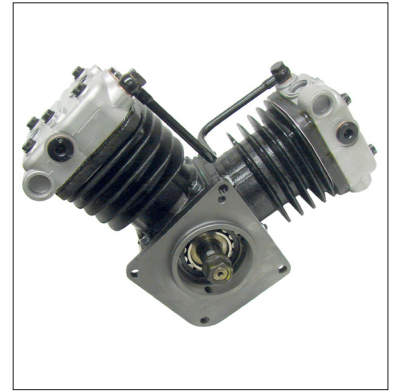

- 88 mm bore.
- Non through drive.
- Head oil cooled.
- Oil ports : M14 x 1.5.
- Weight 22 Kg.
- Flange mount.
- Engine oil lubrication.
- Cylinder air cooled.
- Air ports : M26 x 1.5.



A66RK039C

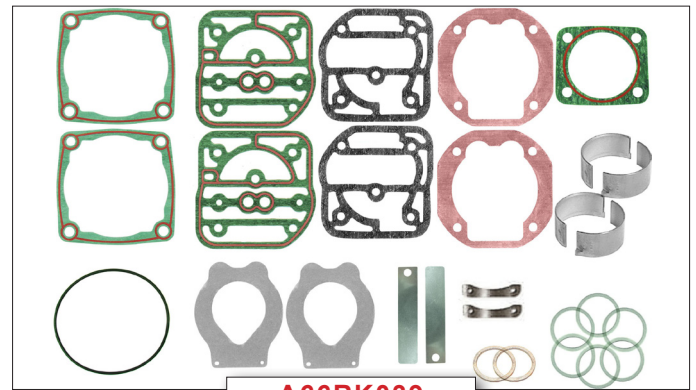

A66RK039

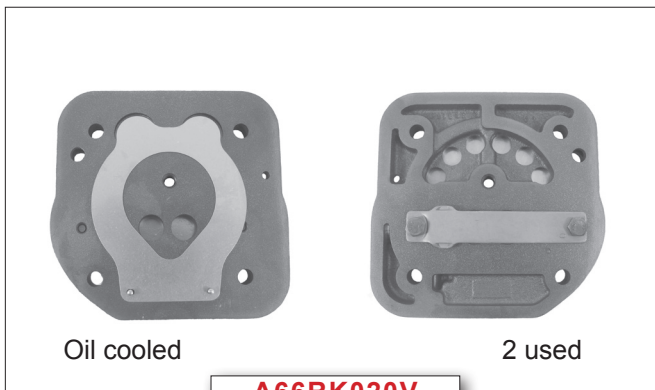

Oil cooled

2 used

A66RK020V

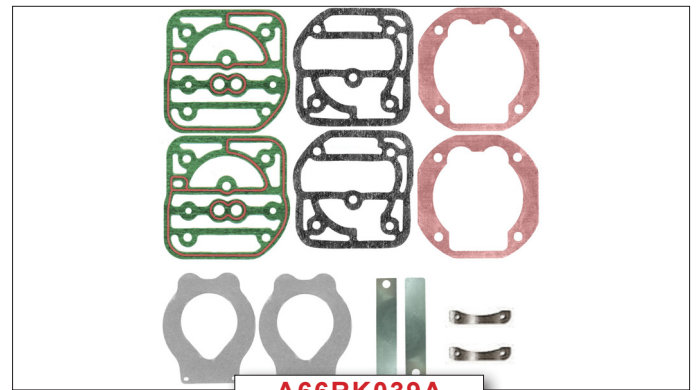

A66RK039A

<p>020112 020113 020129</p> 	<p>Std +0.50 mm +1.00 mm</p> <p>88 mm 2 used 2 x 2.5 mm 1 x 4 mm</p> 	<p>A66RK010 A66RK011 A66RK015</p>
---	--	---

Piston & Rings

Ring set

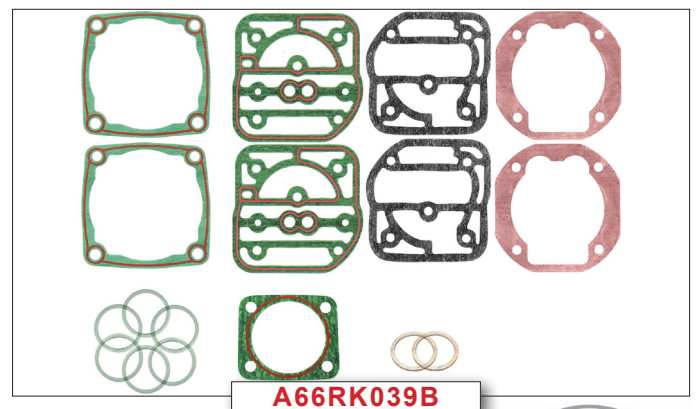

A66RK039B

Check our web site for suitability of these and other parts, or contact us directly.
Original part numbers are used for reference only. Check all applications.
All parts offered are Majorsell brand and may not be of an original supply.
Majorsell kit content and ring sets may be different to the original.



LP4921

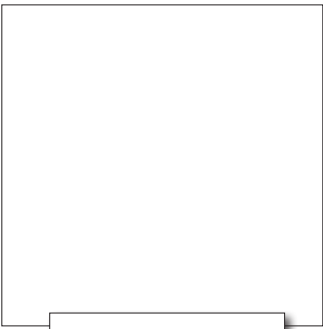
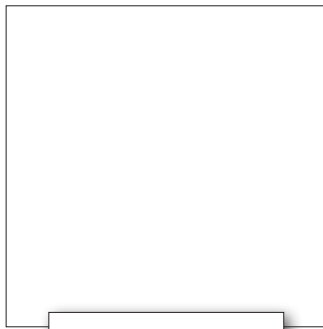
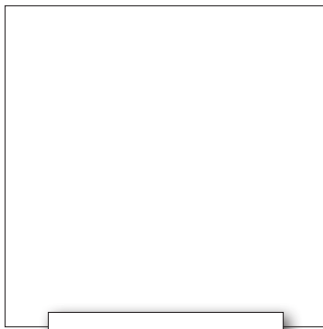
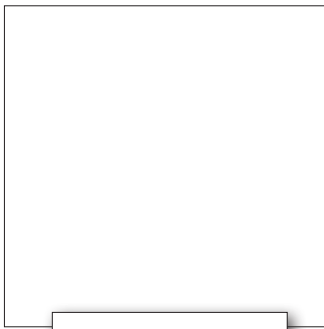
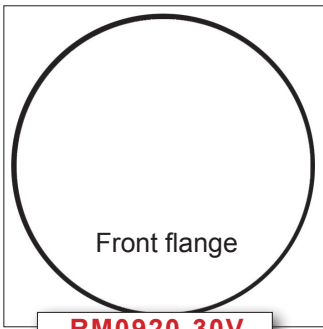
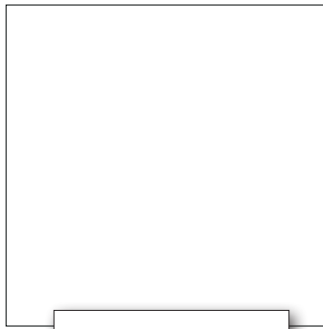
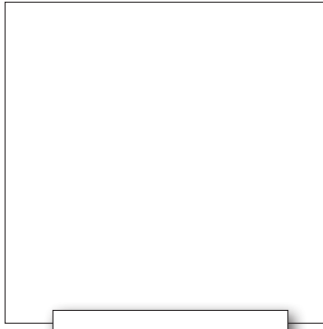
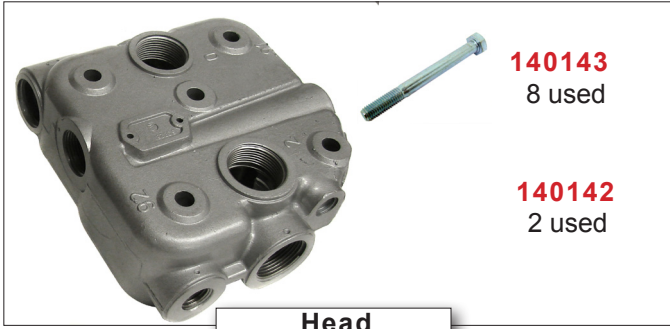

Majorsell parts for :-

LP4944

Principal users :-
RVI

**MAJORSELL
REBUILD**

5000691880

66A141R

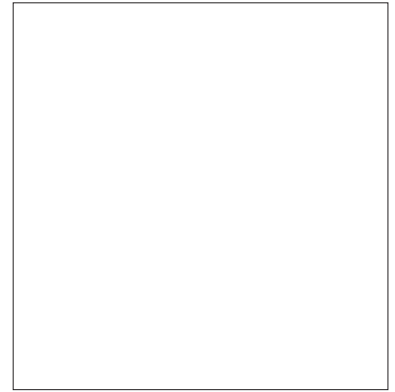

- 70 mm bore.
- Non through drive.
- Water cooled.
- Weight 17 Kg.
- Flange mount.
- Engine oil lubrication.
- Water ports : M18 x 1.5.
- Air ports : M26 x 1.5.

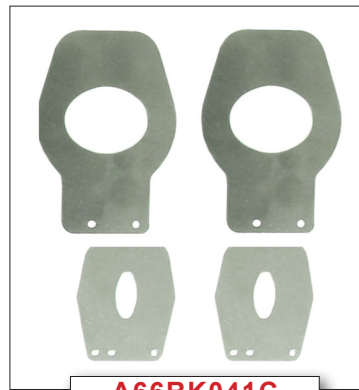

A66RK041C

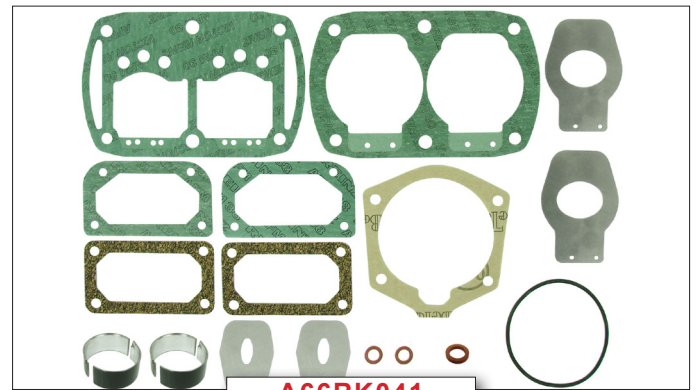

A66RK041

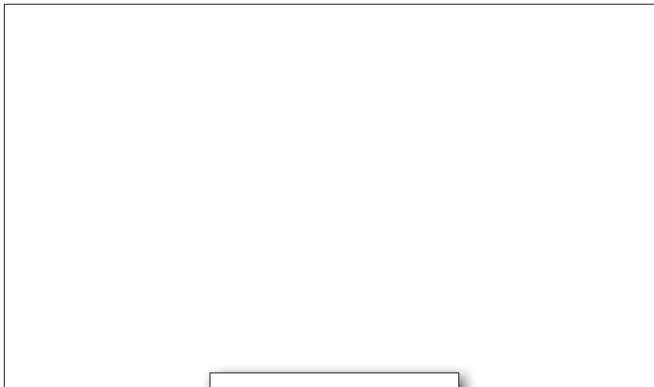

A66RK041A

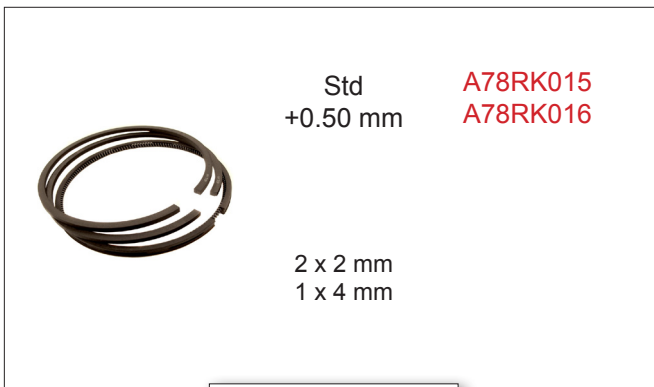

Std **A78RK015**
+0.50 mm **A78RK016**

2 x 2 mm
1 x 4 mm

Ring set

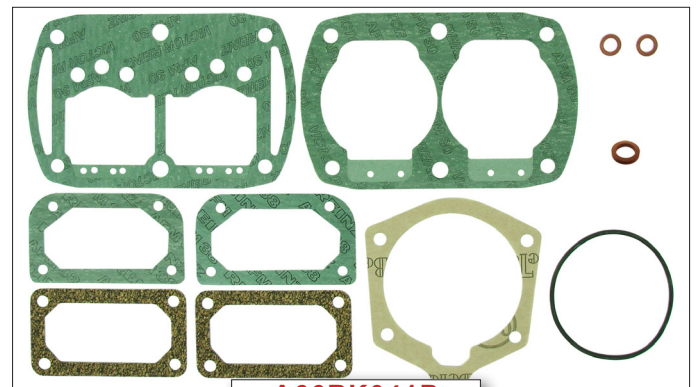

A66RK041B

Check our web site for suitability of these and other parts, or contact us directly.
Original part numbers are used for reference only. Check all applications.
All parts offered are Majorsell brand and may not be of an original supply.
Majorsell kit content and ring sets may be different to the original.



LP4944

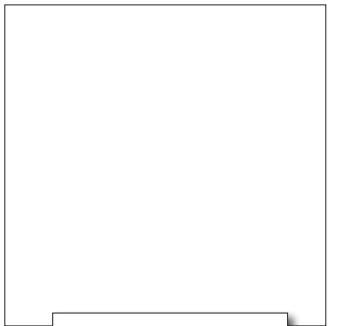
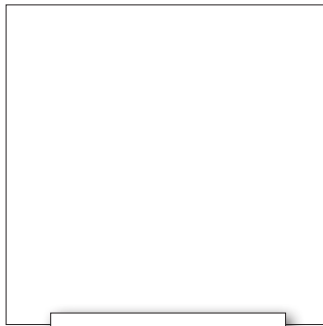
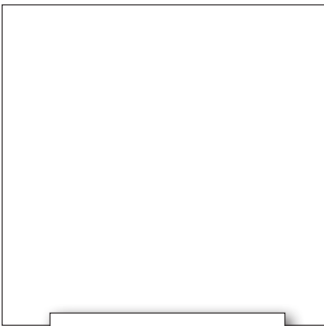
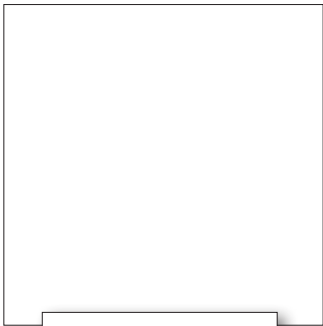
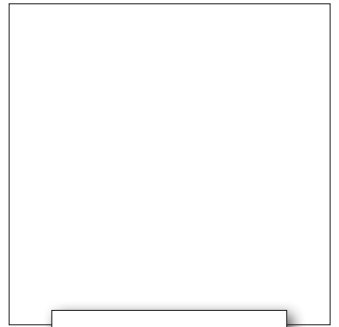
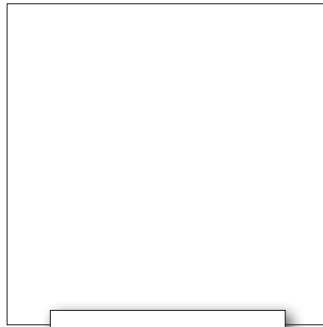
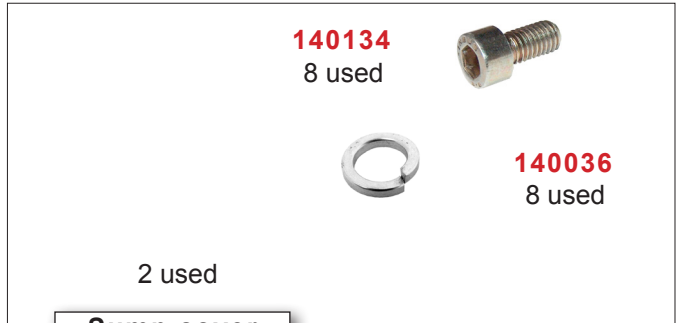
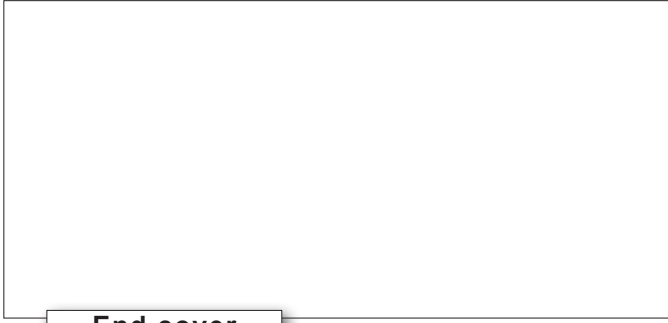
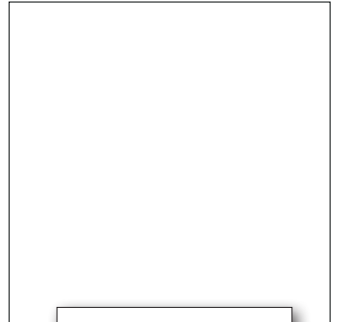
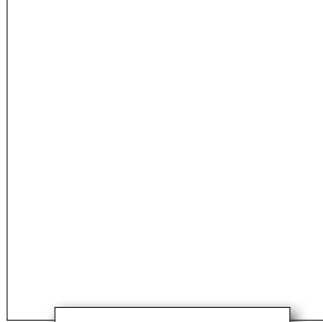

Majorsell parts for :-

LP4954

Principal users :-

MAJORSELL
REBUILD

66A079R

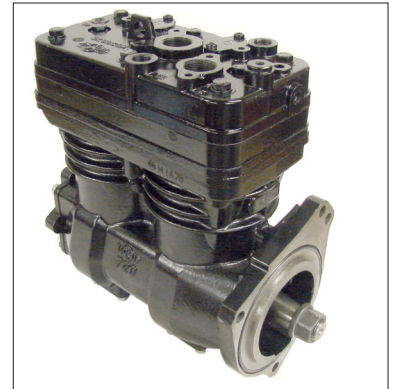

- 92 mm bore.
- Through drive.
- Water cooled.
- Weight 21 Kg.
- Flange mount.
- Engine oil lubrication.
- Water ports : M16 x 1.5 mm.
- Air ports : M26 x 1.5 mm.

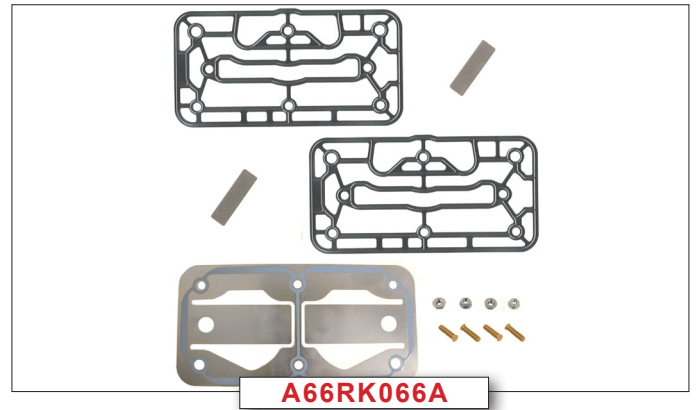
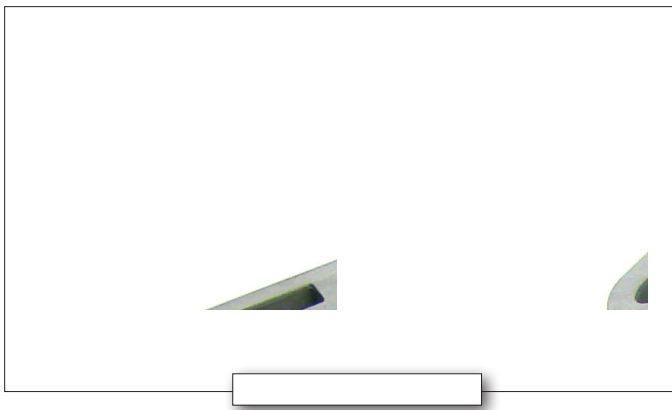
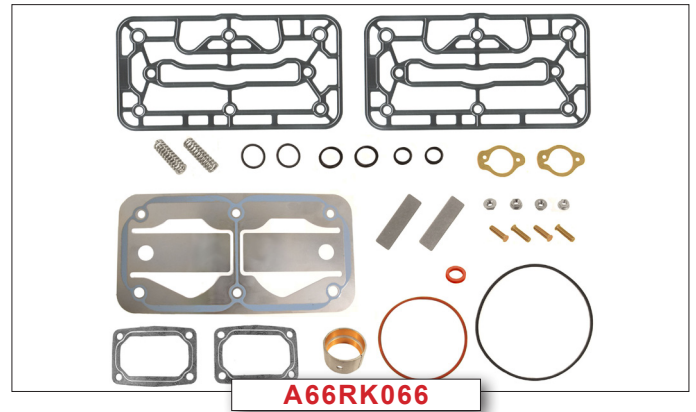

<p>020158 Std A66RK060</p> <p>020159 +0.50 mm A66RK061</p> <p>020160 +1.00 mm A66RK062</p>	<p>92 mm</p> <p>2 x 2.5 mm</p> <p>1 x 4 mm</p>	
--	--	--

Piston & Rings

Ring set

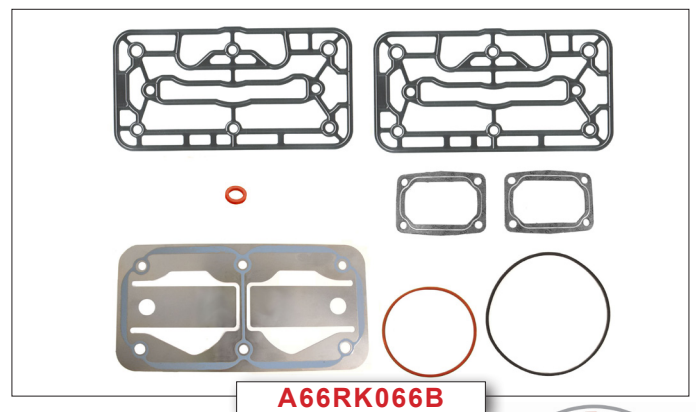

Check our web site for suitability of these and other parts, or contact us directly. Original part numbers are used for reference only. Check all applications. All parts offered are Majorsell brand and may not be of an original supply. Majorsell kit content and ring sets may be different to the original.



LP4957



Crankshaft



Front bush

050186



140016



Conn rod



Head



140140
6 used



140131
2 used



140138
8 used

Head bolts



End cover

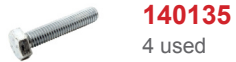

140135
4 used

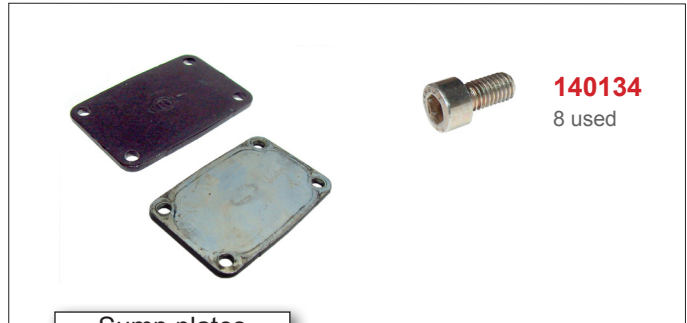

Sump plates



140134
8 used

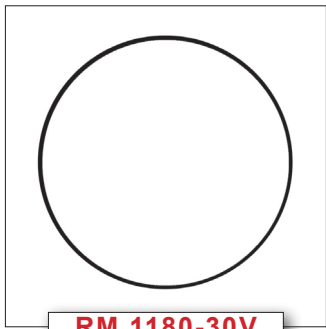

RM 1180-30V

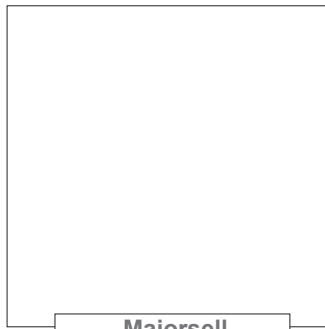
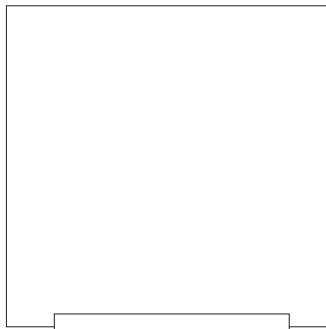

Majorsell

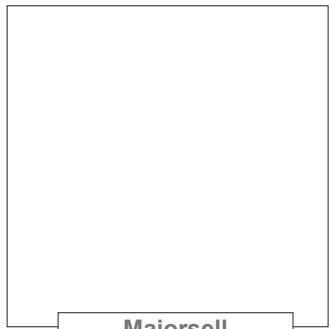

Majorsell

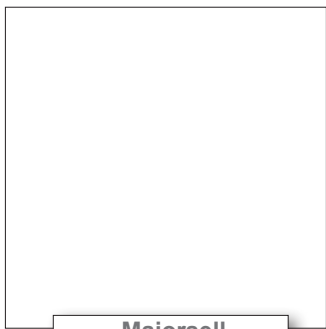

Majorsell

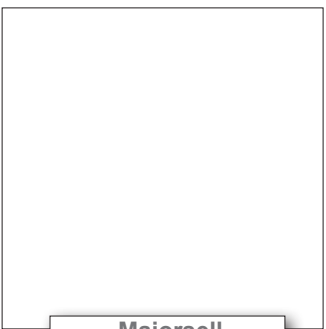

Majorsell



Majorsell



Majorsell

Notes :-

140105-8 sliders (8 mm) are used to replace the original 6mm sliders after the grooves in the top of the cylinder block become worn and have to be machined out to 8 mm width.

Majorsell parts for :-

LP4985

Principal users :-
Volvo

**MAJORSELL
REBUILD
66A018R**

8113405 3173001



- 88 mm bore.
- Non through drive.
- Water cooled.
- Weight 21 Kg.
- Flange mount.
- Engine oil lubrication.
- Water ports M16 x 1.5.
- Air inlet : manifold, delivery : M26 x1.5.

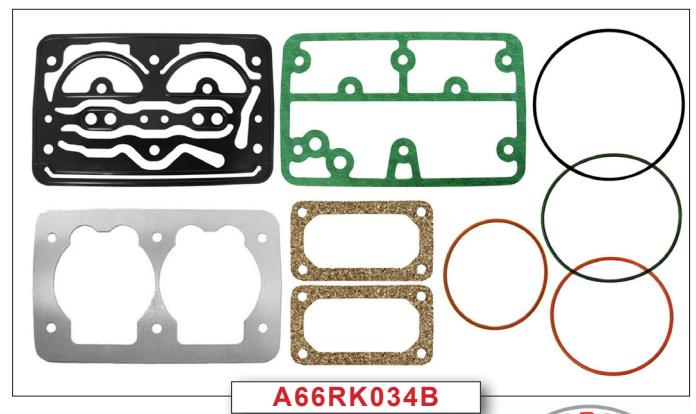
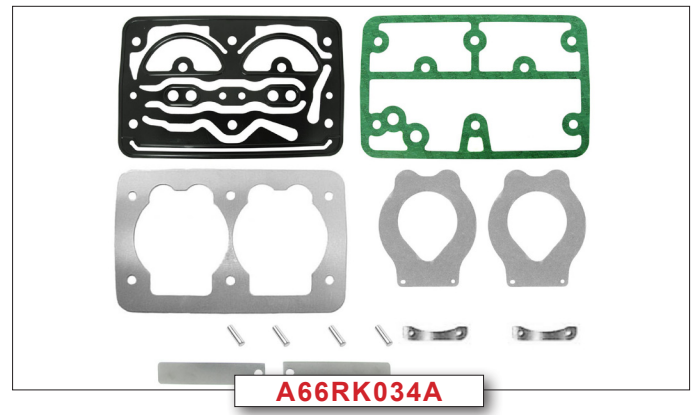
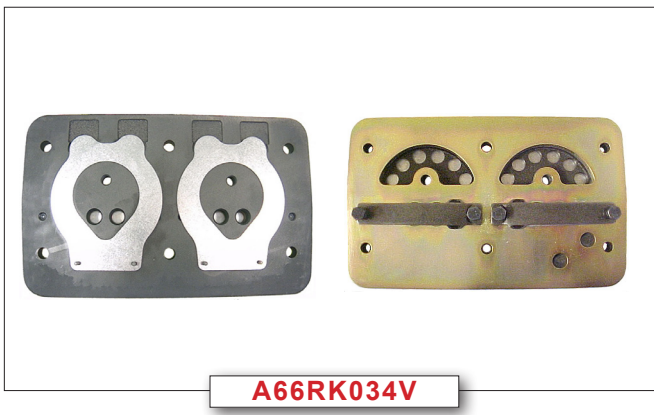
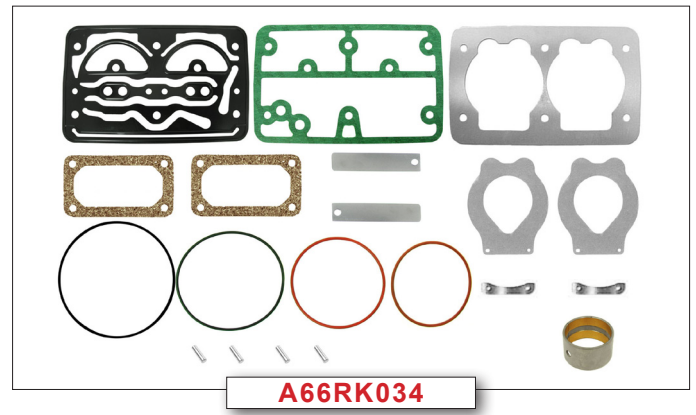

Check our web site for suitability of these and other parts, or contact us directly.
Original part numbers are used for reference only. Check all applications.
All parts offered are Majorsell brand and may not be of an original supply.
Majorsell kit content and ring sets may be different to the original.



LP4985



220214



050186



140016



220069



220217

- 140132**
2 used
- 140140**
6 used
- 140138**
8 used

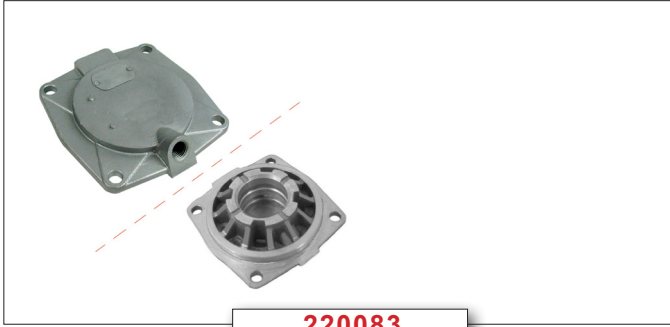
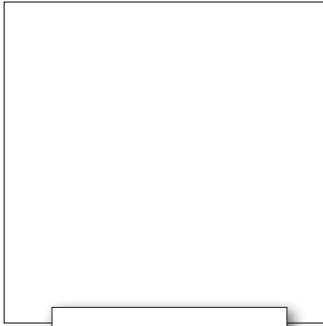
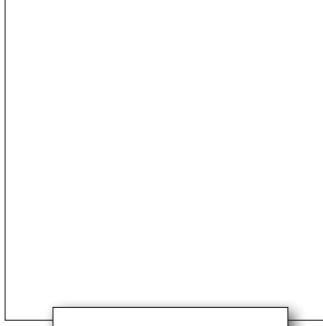

220083

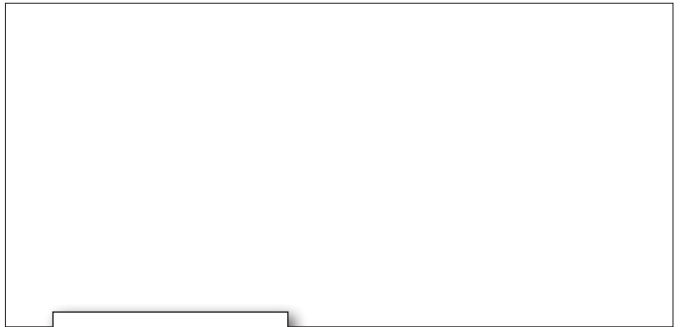

RM1250-30V

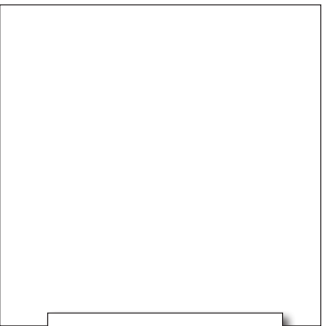
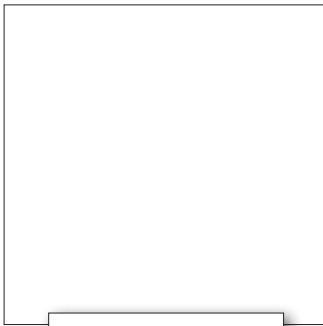
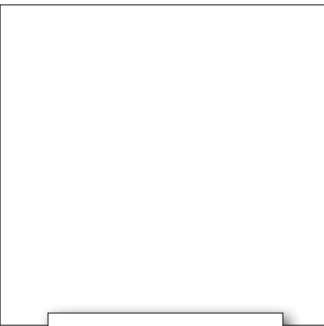
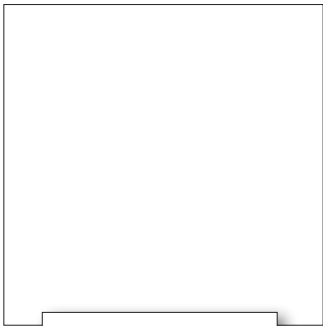
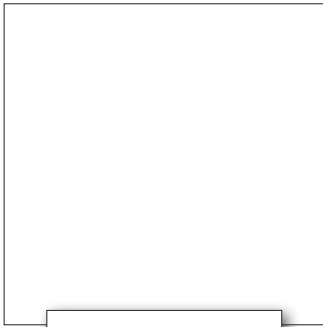
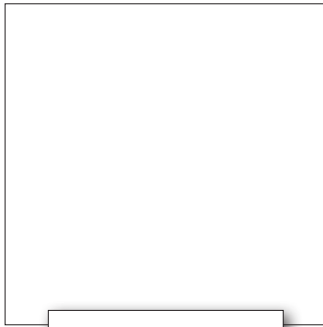
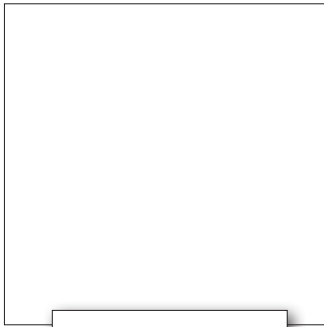

Majorsell parts for :-

LP4991 LP4993

Principal users :-
Volvo

MAJORSELL
REBUILD

8113564 70303442
8113565 70303443

66A082R
66A083R

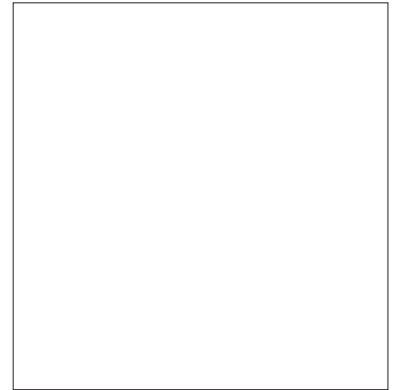

- 88 mm bore.
- Through drive.
- Water cooled.
- Weight 22 Kg.
- Flange mount.
- Engine oil lubrication.
- Water ports : M16 x 1.5.
- Air inlet : pipe, delivery : M26 x 1.5.



A66RK034C

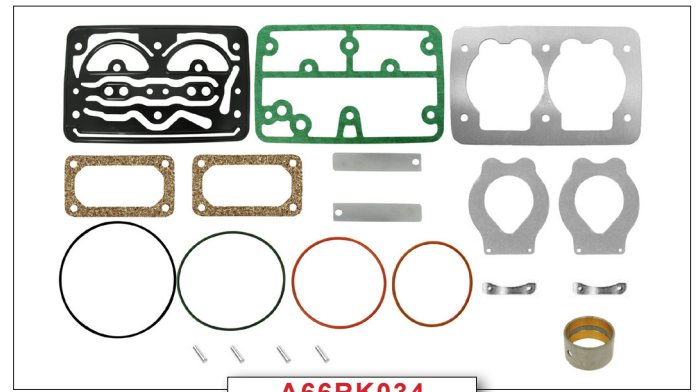

A66RK034



A66RK034V

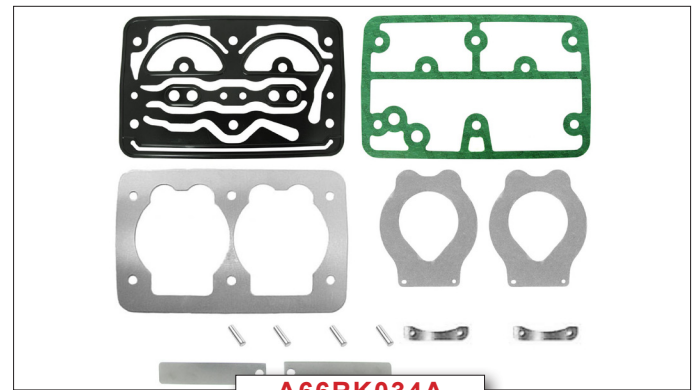

A66RK034A

020112	Std	A66RK010
020113	+0.50 mm	A66RK011
020129	+1.00 mm	A66RK015

	88 mm	
	2 x 2.5 mm	
	1 x 4 mm	

Piston & Rings

Ring set

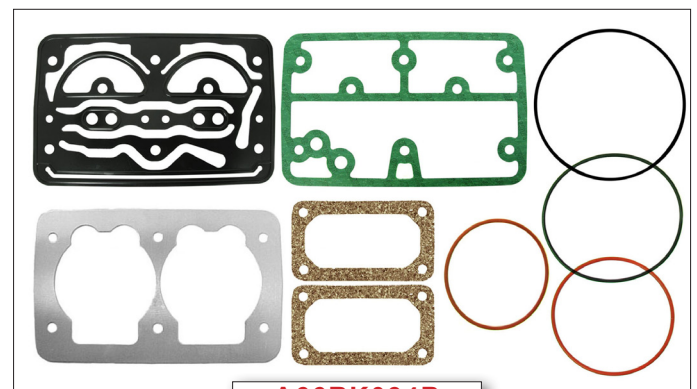

A66RK034B

Check our web site for suitability of these and other parts, or contact us directly.
Original part numbers are used for reference only. Check all applications.
All parts offered are Majorsell brand and may not be of an original supply.
Majorsell kit content and ring sets may be different to the original.



LP4991

LP4993



220216



050186



140016



220069

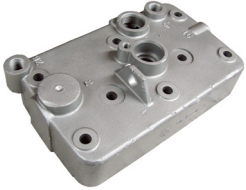

140140
6 used

140132
2 used

140138
8 used



220219



A66RK005CP

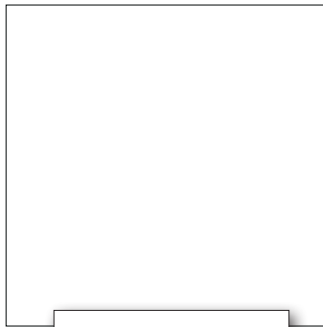

140135
4 used

140138
4 used

Rear cover



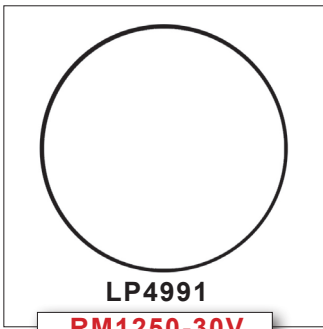

140134
8 used

220153

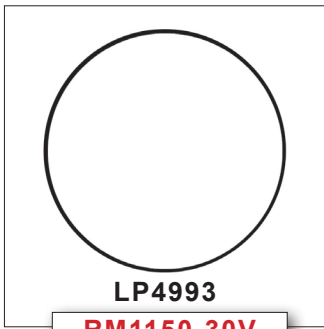

LP4991
RM1250-30V



LP4993
RM1150-30V

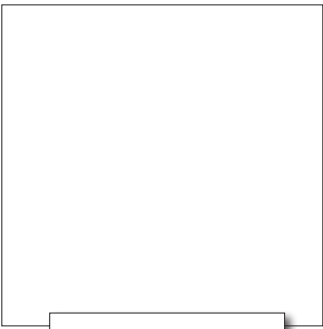
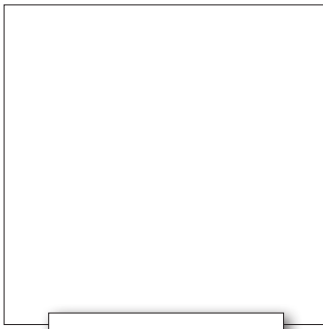
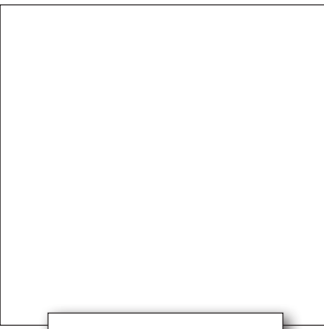
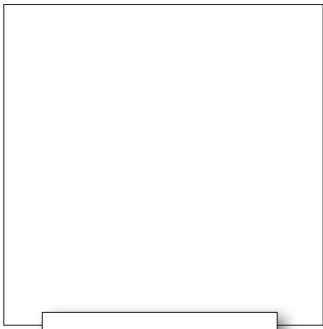
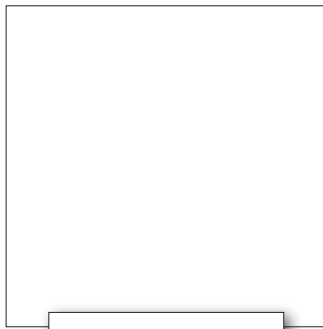
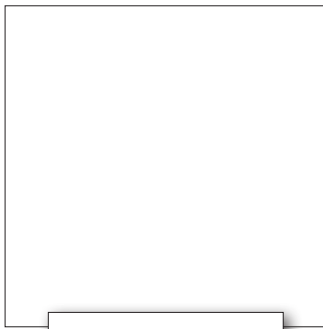

Majorsell parts for :-

LP4992

Principal users :-
Volvo

70330098	85000199	70305894
811592	70330006	

MAJORSSELL
REBUILD

66A086R
66A086R

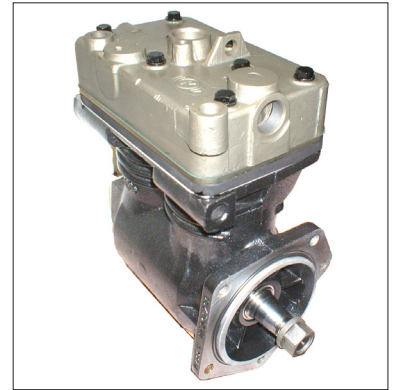

- 88 mm bore.
- Non through drive.
- Water cooled.
- Weight 22 Kg.
- Flange mount.
- Engine oil lubrication.
- Water ports : M16 x 1.5.
- Air inlet : manifold, delivery : M26 x1.5.



A66RK034C



A66RK034



A66RK034V

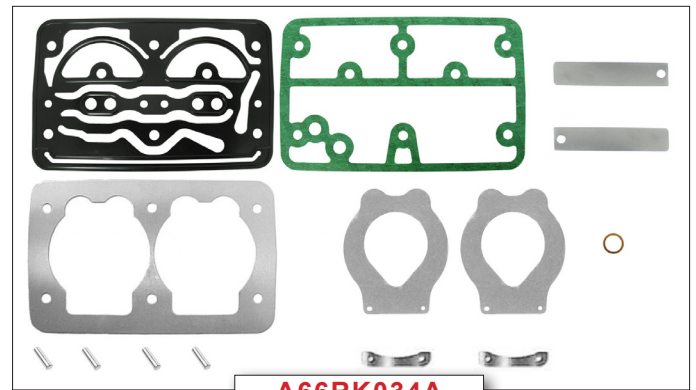

A66RK034A



Piston & Rings

Ring set

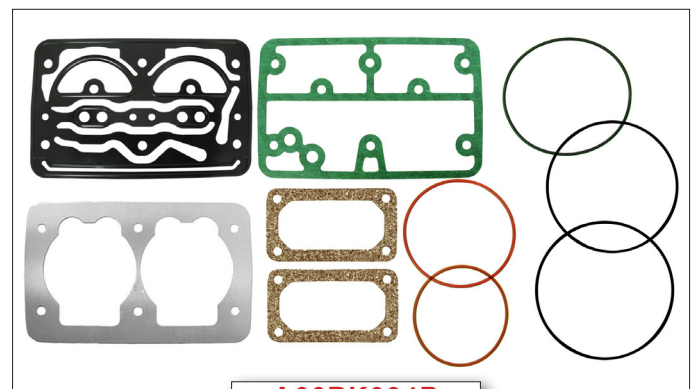

A66RK034B

Check our web site for suitability of these and other parts, or contact us directly. Original part numbers are used for reference only. Check all applications. All parts offered are Majorsell brand and may not be of an original supply. Majorsell kit content and ring sets may be different to the original.



LP4992



Crankshaft



Front

050186



140016



220069

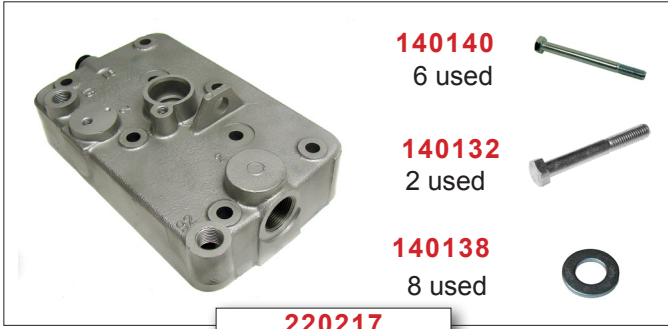

220217

140140
6 used



140132
2 used



140138
8 used

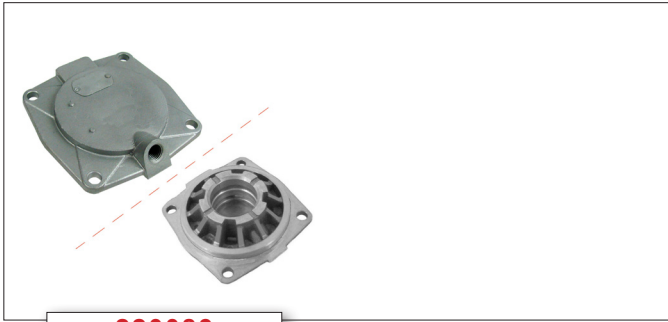
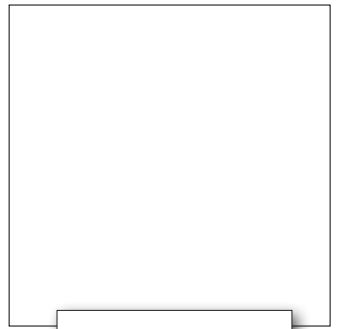
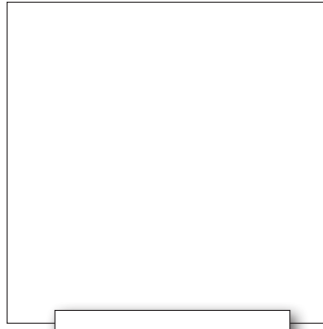

220083



2 used

220153



140134
8 used



RM1250-30V

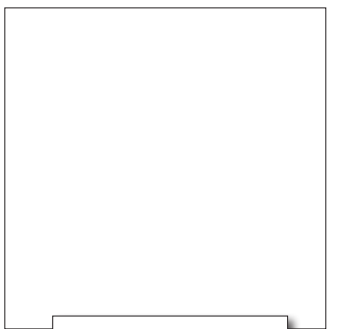
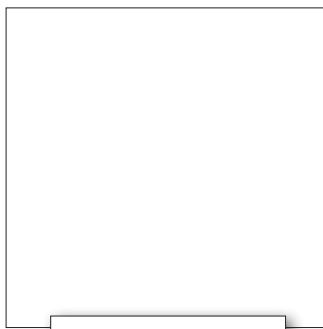
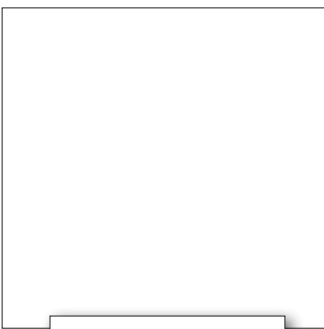
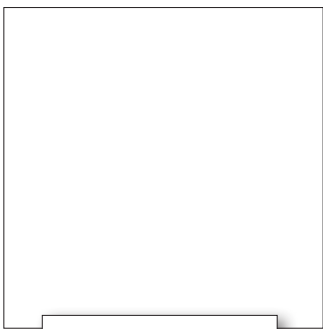
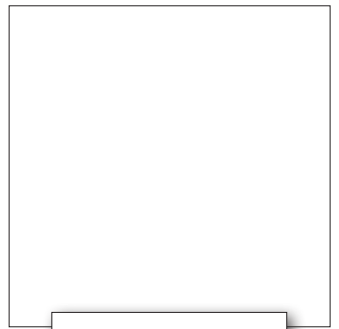
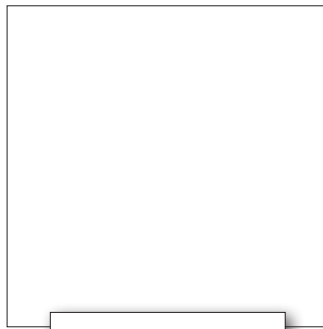
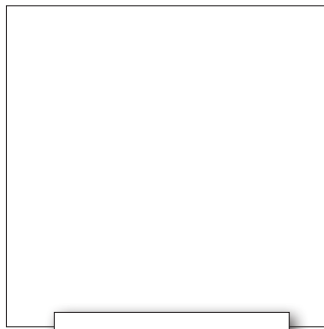

Majorsell parts for :-

LP4994

Principal users :-
Volvo

**MAJORSELL
REBUILD
66A109R**

8113566 70303444

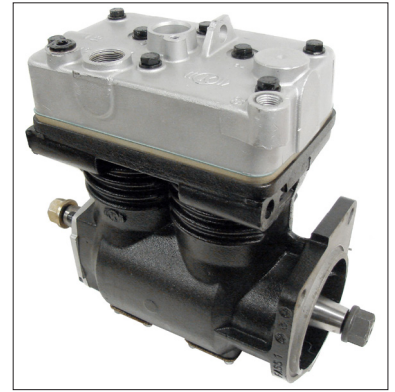

- 88 mm bore.
- Through drive.
- Water cooled.
- Weight 22 Kg.
- Flange mount.
- Engine oil lubrication.
- Water ports M16 x 1.5.
- Air inlet : 'pipe', air delivery : M26 x1.5.

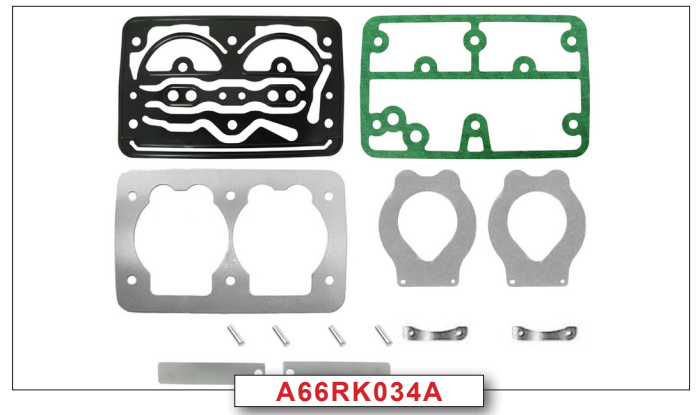
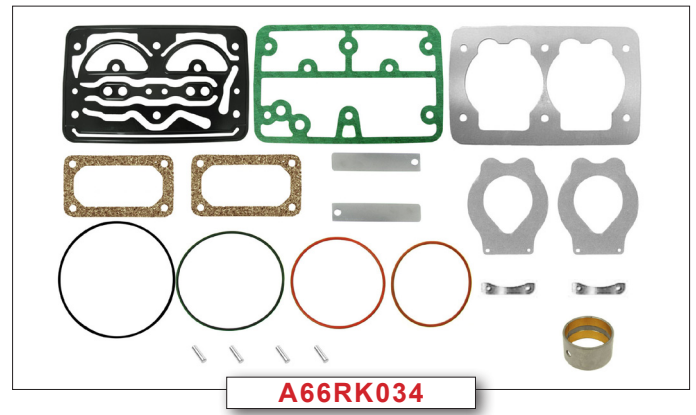

020112	Std	A66RK010
020113	+0.50 mm	A66RK011
020129	+1.00 mm	A66RK015

	88 mm	
	2 x 2.5 mm	
	1 x 4 mm	

Piston & Rings **Ring set**

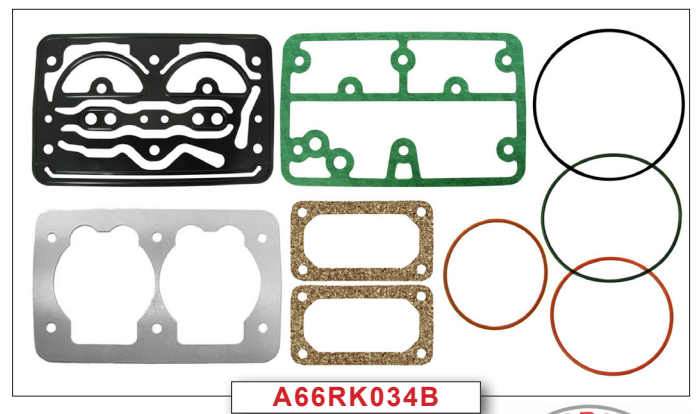

Check our web site for suitability of these and other parts, or contact us directly. Original part numbers are used for reference only. Check all applications. All parts offered are Majorsell brand and may not be of an original supply. Majorsell kit content and ring sets may be different to the original.



LP4994



220216



050186
Front

050126
Rear

Bushes



2 used

140016



220069

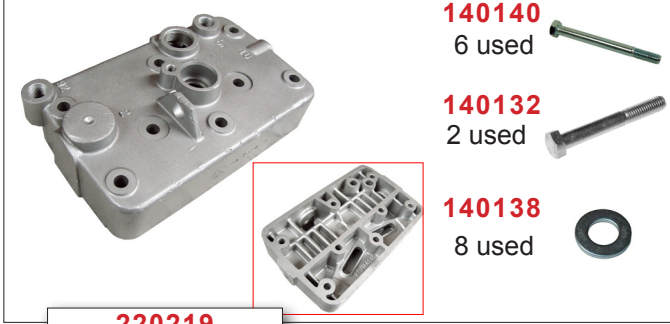

140140
6 used

140132
2 used

140138
8 used

220219

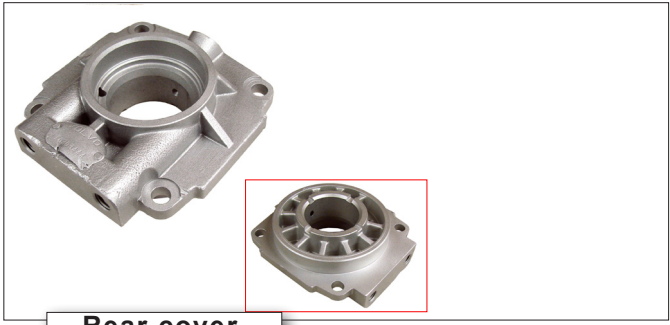
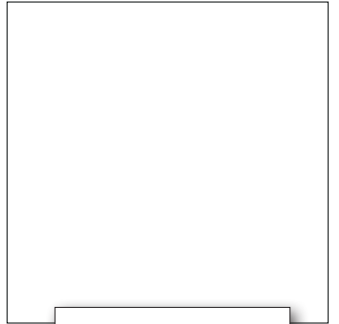
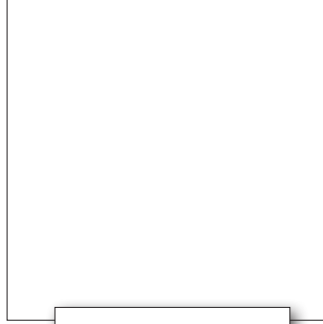

Rear cover

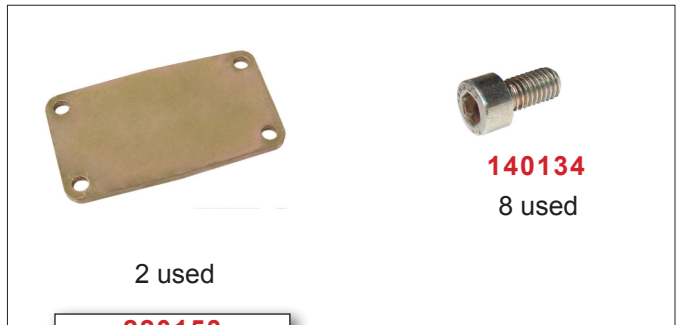

140134
8 used

2 used

220153

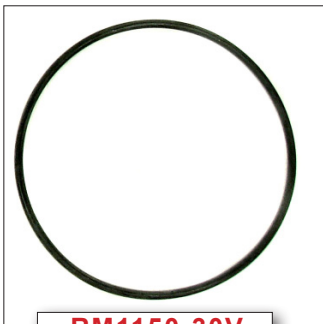

RM1150-30V

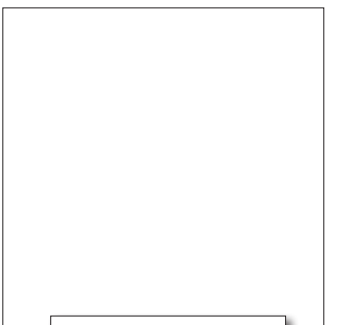
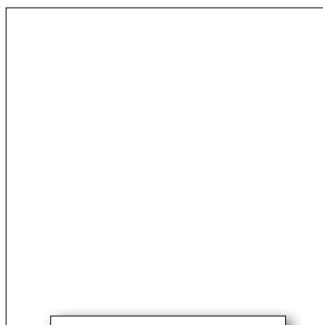
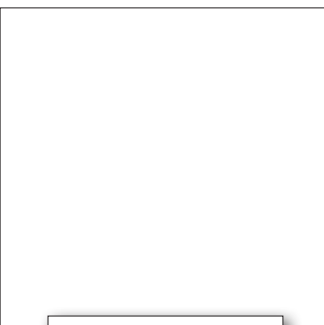
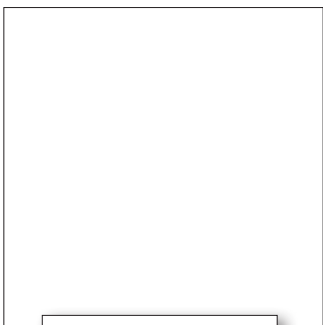
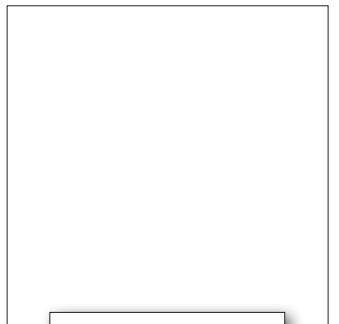
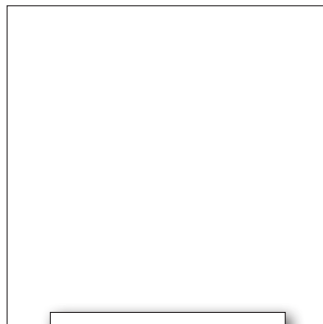
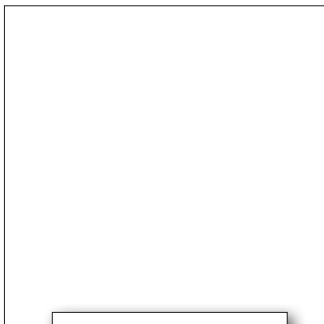

Majorsell parts for :-

LP4996

Principal users :-
Volvo

**MAJORSELL
REBUILD
66A081R**

8113567 70303446

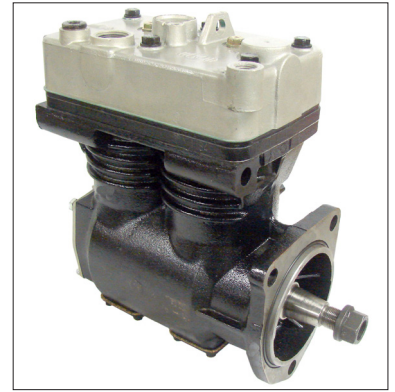

- 88 mm bore.
- Non through drive.
- Water cooled.
- Weight 20 Kg.
- Flange mount.
- Engine oil lubrication.
- Water ports : M26 x 1.5.
- Air inlet : manifold, air delivery : M26 x1.5.

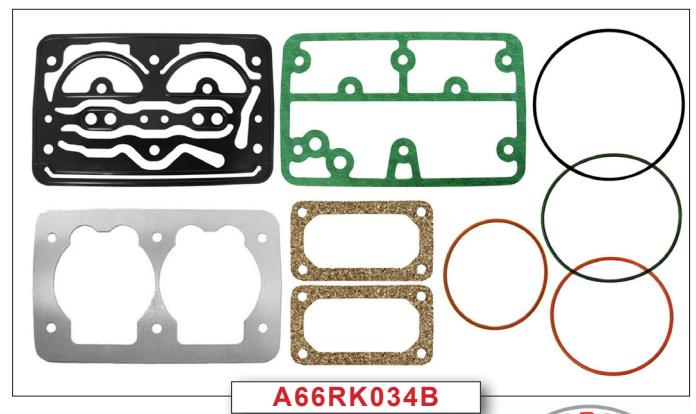
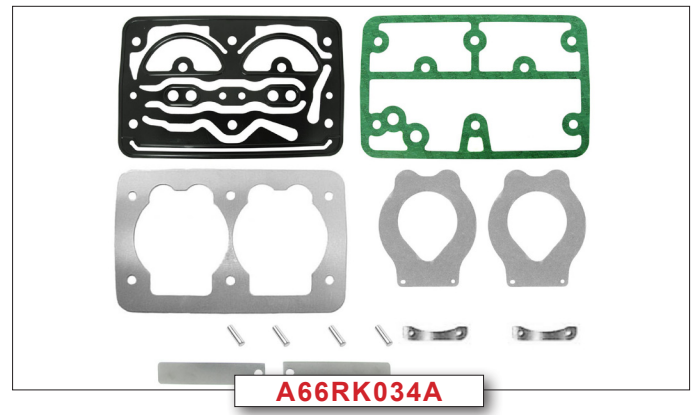
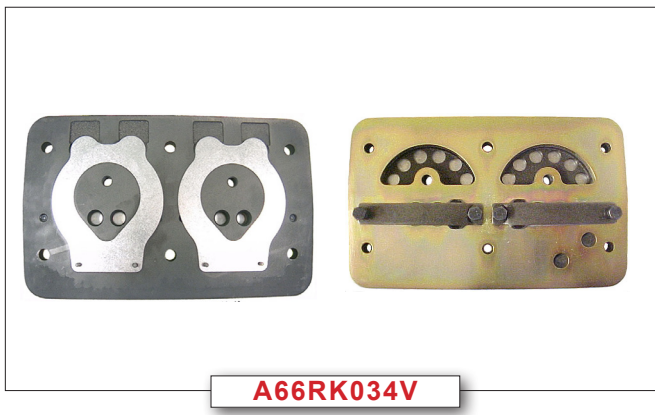
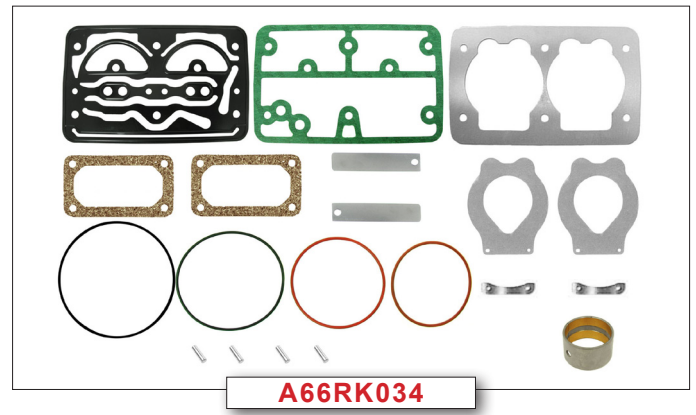

Check our web site for suitability of these and other parts, or contact us directly.
Original part numbers are used for reference only. Check all applications.
All parts offered are Majorsell brand and may not be of an original supply.
Majorsell kit content and ring sets may be different to the original.



LP4996



220159



Front

050186



140016



220069



140140
6 used

140132
2 used

140138
8 used

220219

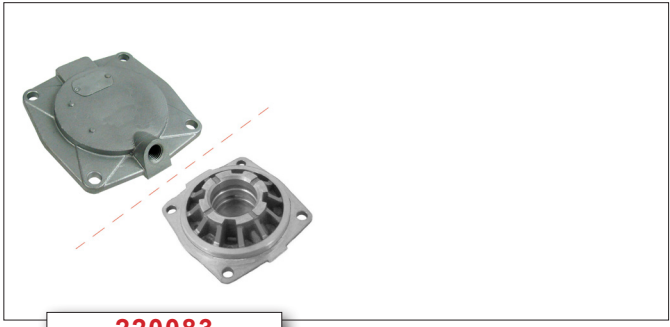
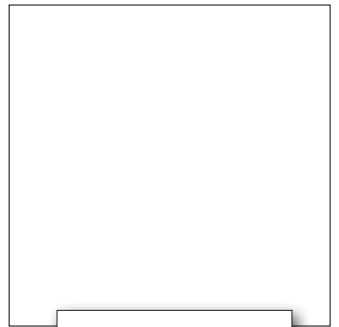
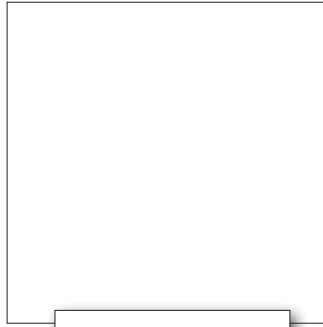

220083

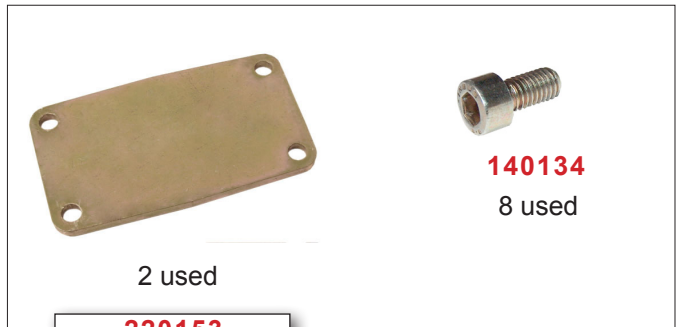

2 used

140134
8 used

220153

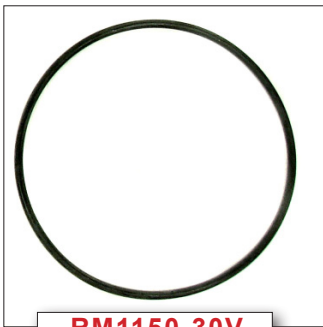

RM1150-30V

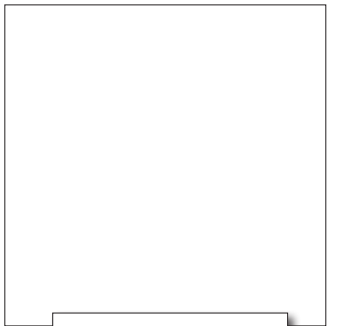
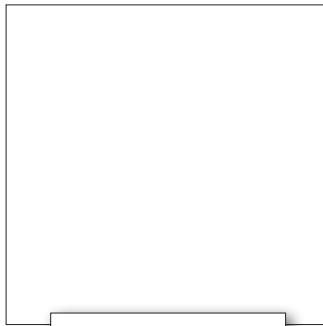
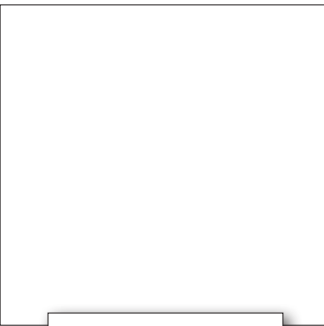
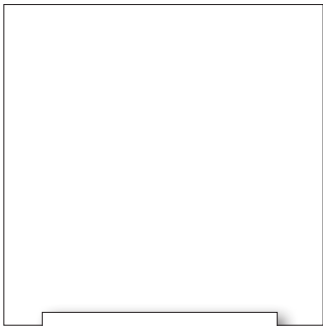
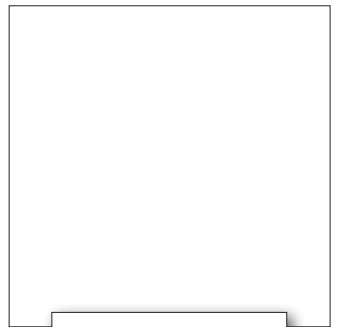
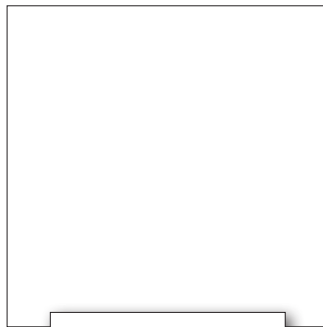
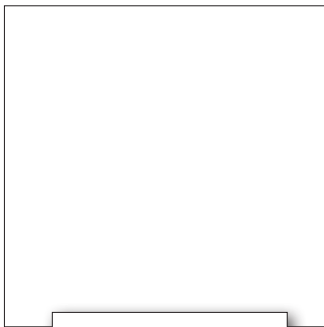

TYPICAL PARTS FOR 75mm SINGLE TYPES

K003

K
N
O
R
R

IN DEVELOPMENT

A66RK044

A66RK044A

IN DEVELOPMENT

TYPICAL TYPE

UNIT

A66RK044B

Blank image placeholder.

COMPRESSORS USING A66RK044
REBUILD

LK1554
LK1555
LK1567

LP1596
LP1598
LP1599

75mm

020124	A66RK027	STD
020125	A66RK028	+0.50
020126	A66RK029	+1.00

2 x 2, 1 x 4mm
PISTON & RINGS

A66RK044V

A66RK044V

A66RK038C

CHECK OUR WEB SITE FOR SUITABILITY OF THESE AND OTHER PARTS, OR CONTACT US.

ALL PARTS OFFERED ARE MAJORSELL BRAND AND MAY NOT BE OF AN ORIGINAL SUPPLY.

ORIGINAL PART NUMBERS ARE USED FOR REFERENCE ONLY. **CHECK ALL APPLICATIONS.**



Fax ++44 121 455 0272 sales@majorsell.co.uk www.majorsell.co.uk



K003.1

**K
N
O
R
R**



SOME TYPES

220071



SOME TYPES

140015



TYPICAL PARTS FOR 75mm SINGLE TYPES

K015

K
N
O
R
R



A66RK035



A66RK035A



LP1325

TYPICAL TYPE
REBUILD

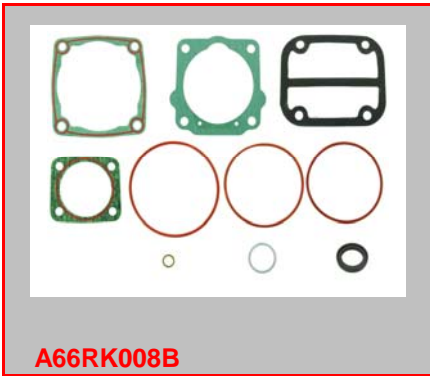

A66RK008B

SEE OVER PAGE K002.1
FOR VALVE PLATES AND
REED VALVE KITS

COMPRESSORS USING A66RK035
REBUILD

LP1316	
LP1317	
LP1321	
LP1325	
LP1327	
LP1328	
LP1330	
LP1331	
LP1332	
LP1337	
LP1545	
LP1546	
LP1566	
LP1567	66A050R
LP1568	66A053R
LP1573	66A054R
LP1575	
LP1577	
LP1578	
LP1580	
LP1582	
LP1585	66A051R
LP1588	66A052R
LP1589	
LP1591	



75mm

020124	A66RK027	STD
020125	A66RK028	+0.50
020126	A66RK029	+1.00

2 x 2, 1 x 4mm
PISTON & RINGS



CHECK OUR WEB SITE FOR SUITABILITY OF THESE AND OTHER PARTS, OR CONTACT US.
ALL PARTS OFFERED ARE MAJORSELL BRAND AND MAY NOT BE OF AN ORIGINAL SUPPLY.
ORIGINAL PART NUMBERS ARE USED FOR REFERENCE ONLY. **CHECK ALL APPLICATIONS.**



Fax ++44 121 455 0272 sales@majorsell.co.uk www.majorsell.co.uk



K015.1

K
N
O
R
R

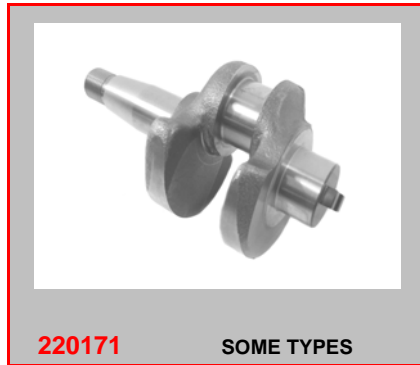

TYPICAL PARTS FOR 78mm SINGLE TYPES

K019

K
N
O
R
R



A66RK038



A66RK038A

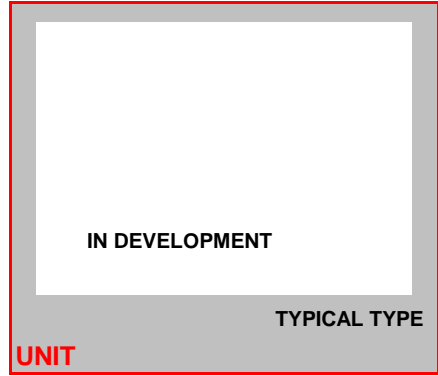

UNIT

IN DEVELOPMENT

TYPICAL TYPE



A66RK038B



A66RK038C

COMPRESSORS USING A66RK038 REBUILD

- LP3832
- LP3833
- LP3843
- LP3852
- LP3857
- LP3860
- LP3861
- LP3862



78mm

020150	A66RK036	STD
020151	A66RK037	+0.50
		+1.00

2 x 2, 1 x 4mm
PISTON & RINGS



A66RK038V



A66RK038V



CHECK OUR WEB SITE FOR SUITABILITY OF THESE AND OTHER PARTS, OR CONTACT US.
 ALL PARTS OFFERED ARE MAJORSELL BRAND AND MAY NOT BE OF AN ORIGINAL SUPPLY.
 ORIGINAL PART NUMBERS ARE USED FOR REFERENCE ONLY. **CHECK ALL APPLICATIONS.**



Fax ++44 121 455 0272 sales@majorsell.co.uk www.majorsell.co.uk



K019.1

K
N
O
R
R

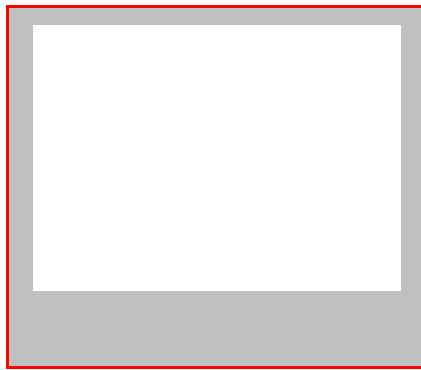
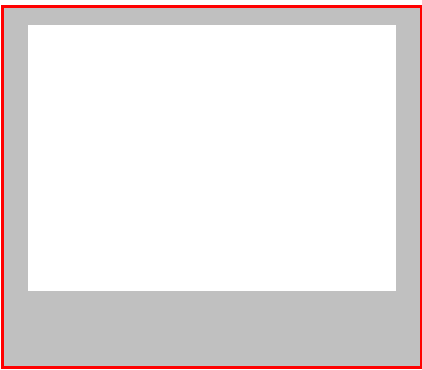

TYPICAL PARTS FOR 65mm SINGLE TYPES

MAR001

M
A
R
J
O
R
S
E
L
L



A78RK009



A78RK009A



IN DEVELOPMENT

TYPICAL TYPE



A78RK009B



A78RK009C

COMPRESSORS USING A78RK009
REBUILD

AC61ZA
AC61ZB
AC61ZC

AC62ZA
AC62ZAG

ACX61ZA
ACX61ZAG
ACX61ZC
ACX61ZCG



65mm

020064	A78RK012	STD
020065	A78RK013	+0.50

2 x 2, 1 x 4mm
PISTON & RINGS



A78RK009V

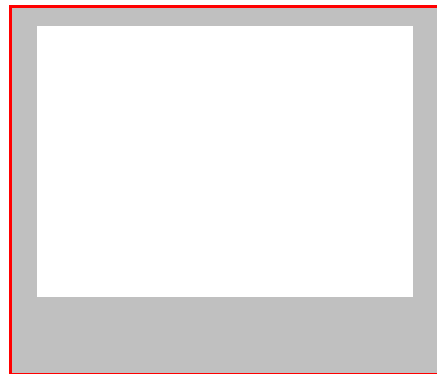

CHECK OUR WEB SITE FOR SUITABILITY OF THESE AND OTHER PARTS, OR CONTACT US.

ALL PARTS OFFERED ARE MAJORSELL BRAND AND MAY NOT BE OF AN ORIGINAL SUPPLY.

ORIGINAL PART NUMBERS ARE USED FOR REFERENCE ONLY. **CHECK ALL APPLICATIONS.**



Fax ++44 121 455 0272 sales@majorsell.co.uk www.majorsell.co.uk



MAR001.1

M
A
R
E
L
L
I



FRONT

050141



050129



SUPPLIED ASSEMBLED

220027



220026

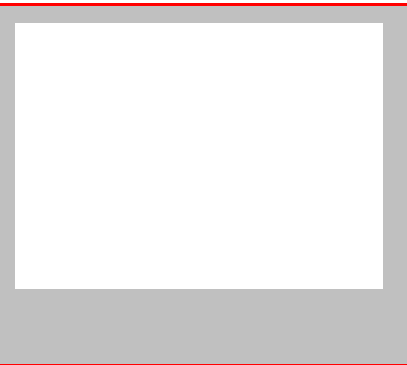

TYPICAL PARTS FOR 70mm SINGLE TYPES

MAR002

M
A
R
J
O
R
S
E
L
L



A78RK014



A78RK014A



78A001R

TYPICAL TYPE



A78RK014B



A78RK009C

COMPRESSORS USING A78RK014 REBUILD

AC63ZA
AC63ZAG
AC63ZB
AC63ZBG

AC64ZB
AC64ZCG 78A001R

ACX66B
ACX66BG



70mm

020074	A78RK015	STD
020075	A78RK016	+0.50

2 x 2, 1 x 4mm
PISTON & RINGS



A78RK009V



CHECK OUR WEB SITE FOR SUITABILITY OF THESE AND OTHER PARTS, OR CONTACT US.

ALL PARTS OFFERED ARE MAJORSSELL BRAND AND MAY NOT BE OF AN ORIGINAL SUPPLY.

ORIGINAL PART NUMBERS ARE USED FOR REFERENCE ONLY. **CHECK ALL APPLICATIONS.**



Fax ++44 121 455 0272 sales@majorsell.co.uk www.majorsell.co.uk



MAR002.1

M
A
R
E
L
L
I



TYPICAL PARTS FOR 80mm SINGLE TYPES

MAR003

**M
A
R
J
O
R
S
E
L
L**



A78RK001



A78RK001A



IN DEVELOPMENT

TYPICAL TYPE



A78RK001B



A78RK001C

COMPRESSORS USING A78RK001 REBUILD

AC67A
AC67AA
AC67AC
AC67AZG
AC67BA

ACX67A
ACX67AA
ACX67AAG
ACX67BA
ACX67BAG
ACX67CA



A78RK001V



A78RK001V



80mm

020057	A78RK002	STD
020057	A78RK004	+0.50

2 x 2, 1 x 4mm
PISTON & RINGS

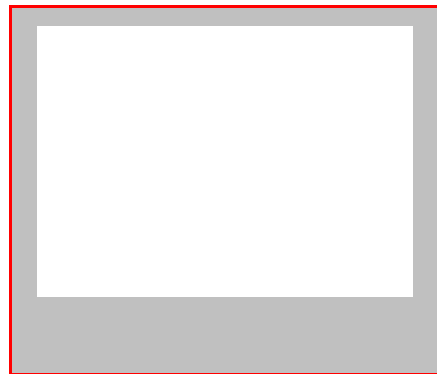

CHECK OUR WEB SITE FOR SUITABILITY OF THESE AND OTHER PARTS, OR CONTACT US.

ALL PARTS OFFERED ARE MAJORSSELL BRAND AND MAY NOT BE OF AN ORIGINAL SUPPLY.

ORIGINAL PART NUMBERS ARE USED FOR REFERENCE ONLY. **CHECK ALL APPLICATIONS.**



Fax ++44 121 455 0272 sales@majorsell.co.uk www.majorsell.co.uk



MAR003.1

M
A
R
E
L
L
I



220045



SUPPLIED ASSEMBLED

220028



WHERE USED

050129



REAR

050158

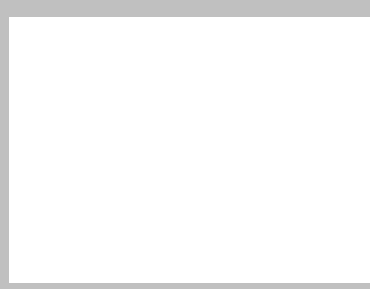
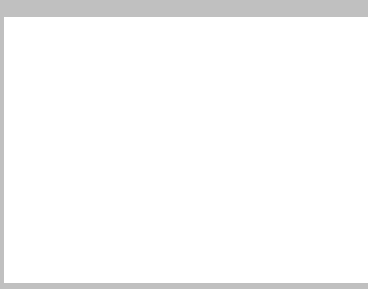
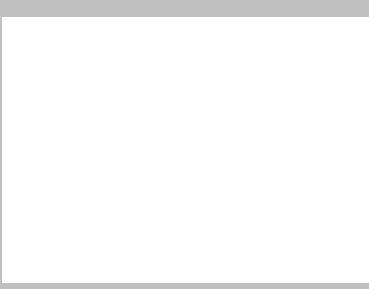
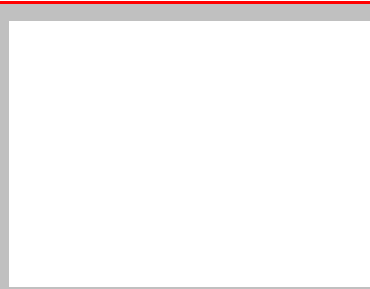
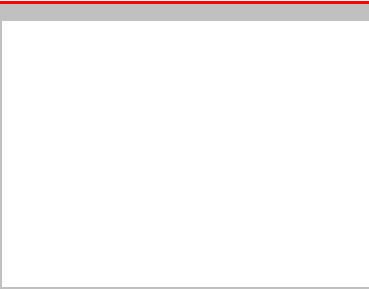

TYPICAL PARTS FOR 65mm SINGLE TYPES

MAR004

**M
A
R
E
L
L
I**



A78RK019



A78RK019A

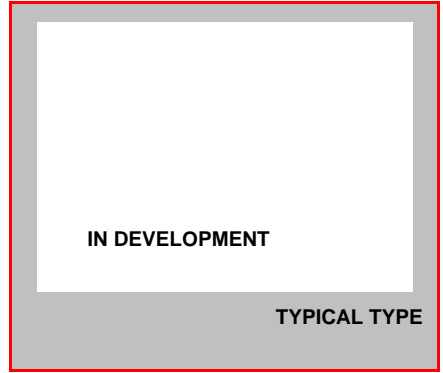

IN DEVELOPMENT

TYPICAL TYPE



A78RK019B



A78RK019C

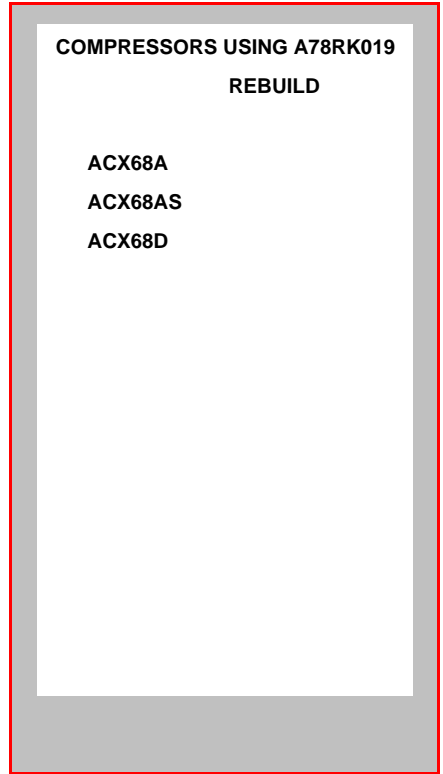

COMPRESSORS USING A78RK019
REBUILD

- ACX68A
- ACX68AS
- ACX68D



80mm

020064	A78RK012	STD
020065	A78RK013	+0.50

2 x 2, 1 x 4mm
PISTON & RINGS



CHECK OUR WEB SITE FOR SUITABILITY OF THESE AND OTHER PARTS, OR CONTACT US.
ALL PARTS OFFERED ARE MAJORSELL BRAND AND MAY NOT BE OF AN ORIGINAL SUPPLY.
ORIGINAL PART NUMBERS ARE USED FOR REFERENCE ONLY. **CHECK ALL APPLICATIONS.**



Fax ++44 121 455 0272 sales@majorsell.co.uk www.majorsell.co.uk



MAR004.1

M
A
R
E
L
L
I



TYPICAL PARTS FOR 80mm SINGLE TYPES

MAR005

**M
A
R
E
L
L
I**



A78RK020



A78RK020A



IN DEVELOPMENT

TYPICAL TYPE

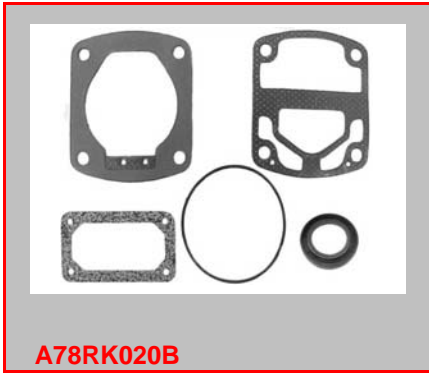

A78RK020B



A78RK020C

COMPRESSORS USING A78RK020
REBUILD

- ACX69A
- ACX69AS
- ACX69AXU
- ACX69BXS
- ACX69CX
- ACX69D
- ACX69DXU
- ACX69DX



A78RK020V



A78RK020V



80mm

020057	A78RK002	STD
020057	A78RK004	+0.50

2 x 2, 1 x 4mm
PISTON & RINGS



CHECK OUR WEB SITE FOR SUITABILITY OF THESE AND OTHER PARTS, OR CONTACT US.
ALL PARTS OFFERED ARE MAJORSELL BRAND AND MAY NOT BE OF AN ORIGINAL SUPPLY.
ORIGINAL PART NUMBERS ARE USED FOR REFERENCE ONLY. **CHECK ALL APPLICATIONS.**



Fax ++44 121 455 0272 sales@majorsell.co.uk www.majorsell.co.uk





TYPICAL PARTS FOR 80mm TWIN TYPES

MAR006

**M
A
R
J
O
R
S
E
L
L**



A78RK007



A78RK007A

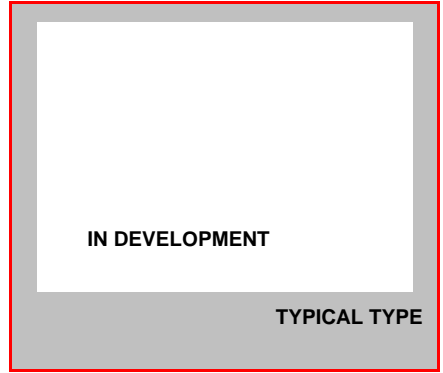

IN DEVELOPMENT

TYPICAL TYPE



A78RK007B



A78RK007C

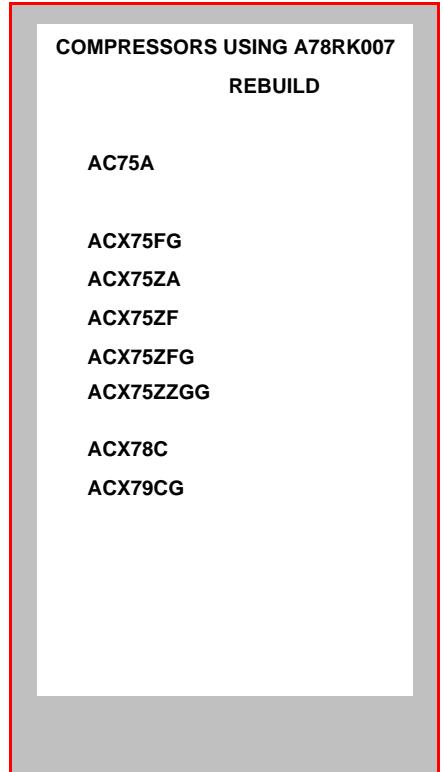

COMPRESSORS USING A78RK007
REBUILD

AC75A

ACX75FG

ACX75ZA

ACX75ZF

ACX75ZFG

ACX75ZZGG

ACX78C

ACX79CG



A78RK007V



A78RK007V



80mm



IN DEVELOPMENT

220038

CHECK OUR WEB SITE FOR SUITABILITY OF THESE AND OTHER PARTS, OR CONTACT US.
ALL PARTS OFFERED ARE MAJORSELL BRAND AND MAY NOT BE OF AN ORIGINAL SUPPLY.
ORIGINAL PART NUMBERS ARE USED FOR REFERENCE ONLY. **CHECK ALL APPLICATIONS.**



Fax ++44 121 455 0272 sales@majorsell.co.uk www.majorsell.co.uk



MAR006.1

M
A
R
E
L
L
I



TYPICAL PARTS FOR 80mm TWIN TYPES

MAR007

**M
A
R
J
O
R
S
E
L
L**

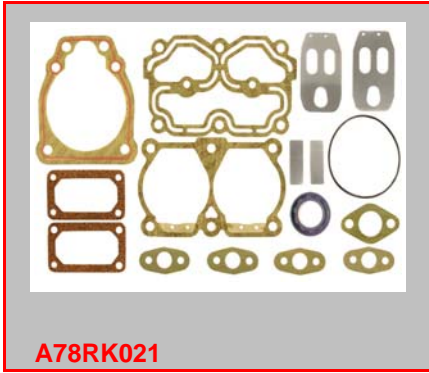

A78RK021



A78RK021A

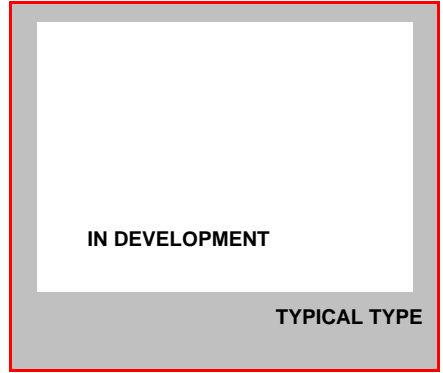

IN DEVELOPMENT

TYPICAL TYPE

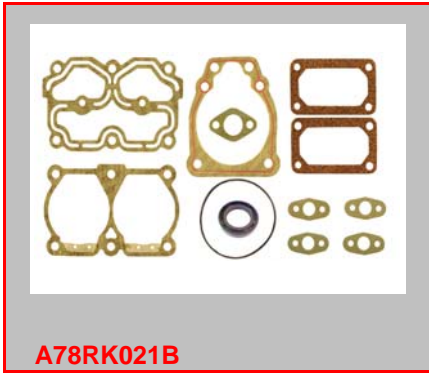

A78RK021B



A78RK021C

COMPRESSORS USING A78RK021 REBUILD

ACX80A
ACX80AA

ACX82
ACX82A
ACX82AS
ACX82AXU
ACX82BXS

ACX83A NOTE RINGS
ACX83AS NOTE RINGS
ACX83B NOTE RINGS



80mm

020057	A78RK002	STD
020057	A78RK004	+0.50

2 x 2, 1 x 4mm
PISTON & RINGS

A78RK026	STD
A78RK027	+0.5

RINGS ONLY AVAILABLE
2 x 1.5, 1 x 3mm
ACX83A, ACX83AS, ACX83B

CHECK OUR WEB SITE FOR SUITABILITY OF THESE AND OTHER PARTS, OR CONTACT US.

ALL PARTS OFFERED ARE MAJORSSELL BRAND AND MAY NOT BE OF AN ORIGINAL SUPPLY.

ORIGINAL PART NUMBERS ARE USED FOR REFERENCE ONLY. **CHECK ALL APPLICATIONS.**



Fax ++44 121 455 0272 sales@majorsell.co.uk www.majorsell.co.uk



MAR007.1

TYPICAL PARTS FOR 82mm TWIN

M
A
R
E
L
L
I

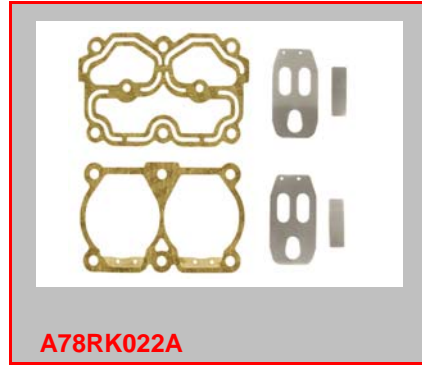
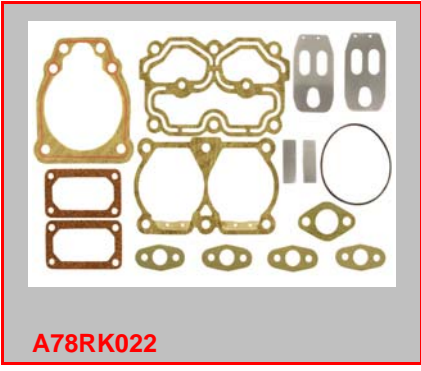

IN DEVELOPMENT

TYPICAL TYPE

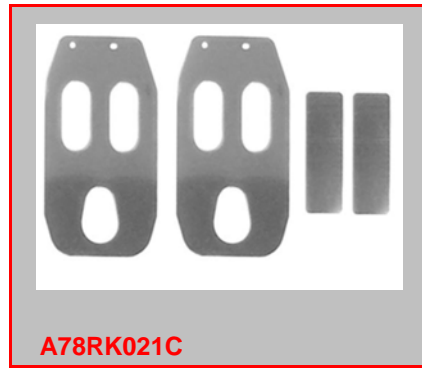
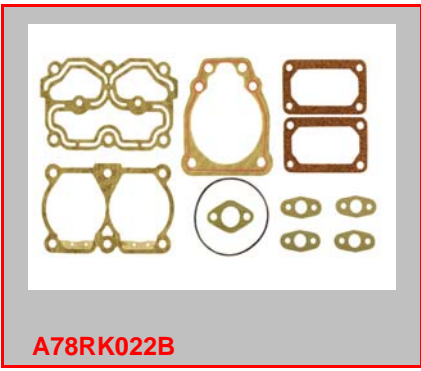

COMPRESSORS USING A78RK022
REBUILD

ACX83D
ACX83DK
ACX83DX
ACX83DXU

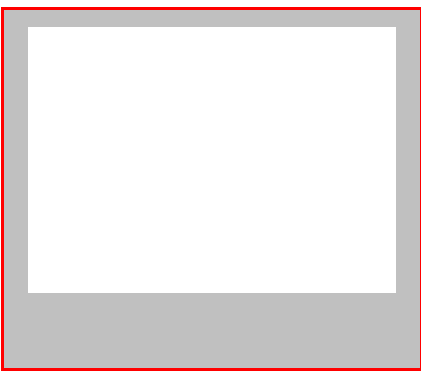

020099	A78RK024	STD
020057	A78RK025	+0.50

2 x 2.5 1 x 4mm

PISTON & RINGS





COMPRESSORS USING A67RK035

	REBUILD
411140000	67A012R
4111400010	
4111400020	
4111400030	
4111405000	
4111405010	
4111405020	
4111405050	
4111405070	
4111408000	
4111408010	
4111408020	
4111408380	
4111408390	
4111408400	
4111408410	
4111408450	
4111408460	
4111408470	
4111408480	
4111408490	
4111409100	
4111409300	



020067	A67RK013	STD
020076	A67RK014	+0.50
020095	A67RK023	+1.00

2 x 2, 1 x 4mm

PISTONS & RINGS



CHECK OUR WEB SITE FOR SUITABILITY OF THESE AND OTHER PARTS, OR CONTACT US.

ALL PARTS OFFERED ARE MAJORSELL BRAND AND MAY NOT BE OF AN ORIGINAL SUPPLY.

ORIGINAL PART NUMBERS ARE USED FOR REFERENCE ONLY. **CHECK ALL APPLICATIONS.**



Fax ++44 121 455 0272 sales@majorsell.co.uk www.majorsell.co.uk



W001.1

W
A
B
C
O



220063 MOST TYPES

IN DEVELOPMENT

220064 MOST TYPES



140131 MOST TYPES

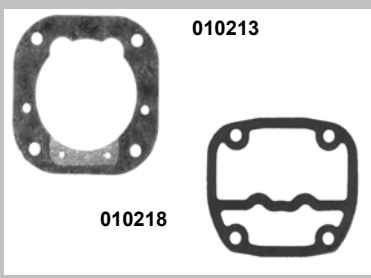

010213

010218



020067	A67RK013	STD
020076	A67RK014	+0.50
020095	A67RK023	+1.00

2 x 2, 1 x 4mm
PISTONS & RINGS

COMPRESSORS USING A67RK035 REBUILD

4111410000	
4111410010	67A013R
4111410020	
4111415000	
4111415010	
4111415030	
4111415060	
4111415070	
4111416020	
4111416400	67A022R
4111417020	
4111417110	
4111417130	
4111418000	
4111418020	
4111418040	
4111418050	
4111418160	67A023R
4111418180	
4111418350	
4111418450	
4111418460	
4111419100	
4111419300	



CHECK OUR WEB SITE FOR SUITABILITY OF THESE AND OTHER PARTS, OR CONTACT US.
 ALL PARTS OFFERED ARE MAJORSELL BRAND AND MAY NOT BE OF AN ORIGINAL SUPPLY.
 ORIGINAL PART NUMBERS ARE USED FOR REFERENCE ONLY. **CHECK ALL APPLICATIONS.**



Fax ++44 121 455 0272 sales@majorsell.co.uk www.majorsell.co.uk



W002.1

W
A
B
C
O



220173 SOME TYPES



220063 SOME TYPES



140131 MOST TYPES



050189 MOST TYPES



220064 MOST TYPES

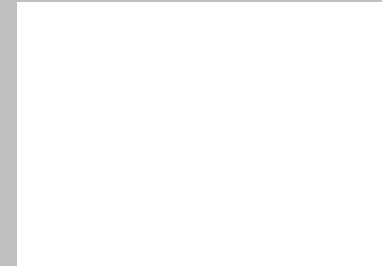

140016 MOST TYPES

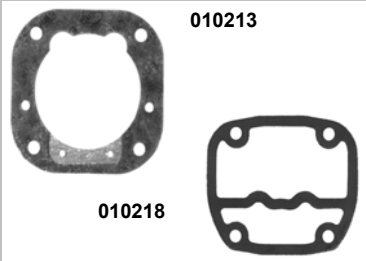

010213

010218

VALVE PLATE
RELATED GASKETS

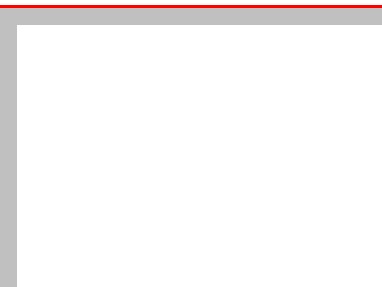
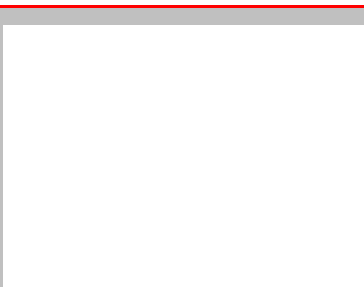
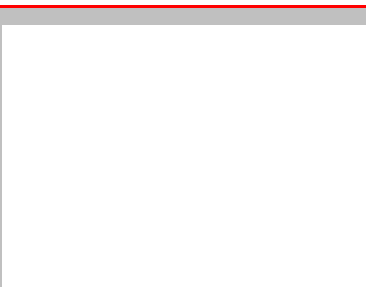



A67RK048



A67RK048A



UNIT

IN DEVELOPMENT

TYPICAL TYPE



A67RK048B



A67RK035C

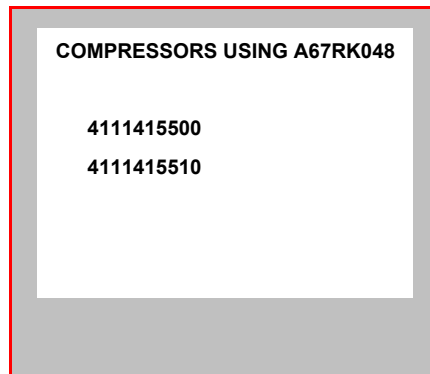

COMPRESSORS USING A67RK048

4111415500

4111415510



A67RK035V



A67RK035V

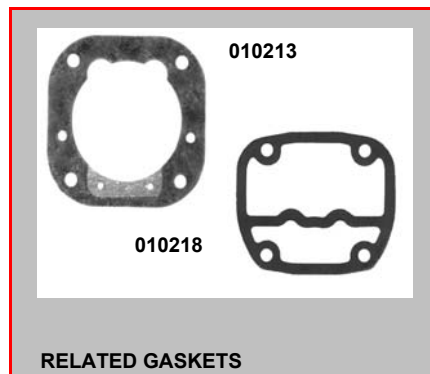

010213

010218

RELATED GASKETS



75mm

020067	A67RK013	STD
020076	A67RK014	+0.50
020095	A67RK023	+1.00

2x2, 1x4mm
PISTONS & RINGS



CHECK OUR WEB SITE FOR SUITABILITY OF THESE AND OTHER PARTS, OR CONTACT US.
ALL PARTS OFFERED ARE MAJORSELL BRAND AND MAY NOT BE OF AN ORIGINAL SUPPLY.
ORIGINAL PART NUMBERS ARE USED FOR REFERENCE ONLY. **CHECK ALL APPLICATIONS.**



Fax ++44 121 455 0272 sales@majorsell.co.uk www.majorsell.co.uk



W003.1

W
A
B
C
O



220063

IN DEVELOPMENT

220064



140131





A67RK024



A67RK024A



4111428050 TYPICAL TYPE
UNIT



A67RK024B



A67RK024C

COMPRESSORS USING A67RK024 REBUILD

- 4111425660
- 4111426810
- 4111427110
- 4111428050
- 4111428160
- 4111428180
- 4111428450
- 4111428500
- 4111428800
- 4111429600



4111425660 4111426810
4111428500 4111428800
4111429600

A67RK004V



4111427110 4111428050
4111428160 4111428180
4111428450

A67RK024V

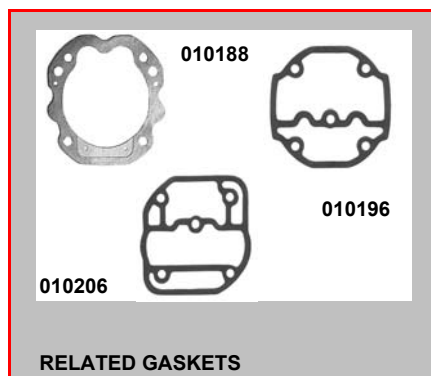

RELATED GASKETS

CHECK OUR WEB SITE OR DVD FOR SUITABILITY OF THESE AND OTHER PARTS, OR CONTACT US.
ALL PARTS OFFERED ARE MAJORSELL BRAND AND MAY NOT BE OF AN ORIGINAL SUPPLY.
ORIGINAL PART NUMBERS ARE USED FOR REFERENCE ONLY. **CHECK ALL APPLICATIONS.**



Fax ++44 121 455 0272 sales@majorsell.co.uk www.majorsell.co.uk



W004.1

W
A
B
C
O



020068 020118 020147

020068	STD	<u>32mm</u>
020069	+0.50mm	CROWN
020070	+1.00mm	HEIGHT
020118	STD	<u>35mm</u>
020119	+0.50mm	CROWN
		HEIGHT

CHECK CROWN HEIGHT

020147	STD	<u>37mm</u>
020148	+0.50mm	CROWN
020149	+1.00mm	HEIGHT



CHECK CROWN HEIGHT

A67RK007	STD
A67RK009	+0.50mm
A67RK011	+1.00mm



RING KIT FOR ALL TYPES



050189 MOST TYPES REAR



050158 SOME TYPES FRONT



140131 65mm 140143 80mm

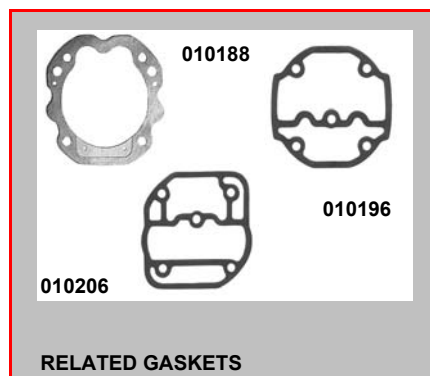
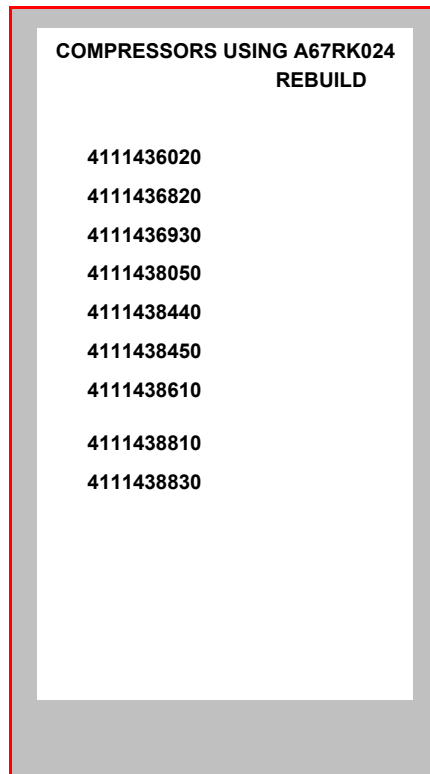

CHECK OUR WEB SITE FOR SUITABILITY OF THESE AND OTHER PARTS, OR CONTACT US.

ALL PARTS OFFERED ARE MAJORSELL BRAND AND MAY NOT BE OF AN ORIGINAL SUPPLY.

ORIGINAL PART NUMBERS ARE USED FOR REFERENCE ONLY. **CHECK ALL APPLICATIONS.**



Fax ++44 121 455 0272 sales@majorsell.co.uk www.majorsell.co.uk



W005.1

W
A
B
C
O



020068 **020118** **020147**

020068	STD	<u>32mm</u>
020069	+0.50mm	CROWN
020070	+1.00mm	HEIGHT
020118	STD	<u>35mm</u>
020119	+0.50mm	CROWN
		HEIGHT

CHECK CROWN HEIGHT

020147	STD	<u>37mm</u>
020148	+0.50mm	CROWN
020149	+1.00mm	HEIGHT



CHECK CROWN HEIGHT

A67RK007	STD
A67RK009	+0.50mm
A67RK011	+1.00mm



RING KIT FOR ALL TYPES



4111436820
4111433610
4111438810
4111438830

220025 SOME TYPES



140131 65mm **140143** 80mm



050189 MOST TYPES REAR



050158 SOME TYPES FRONT

IN DEVELOPMENT

6206 SOME TYPES FRONT

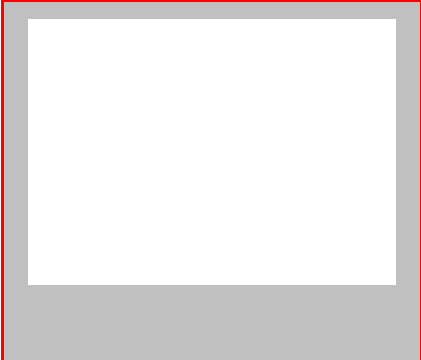



A67RK035



A67RK035A



UNIT

IN DEVELOPMENT

TYPICAL TYPE



A67RK035B



A67RK035C

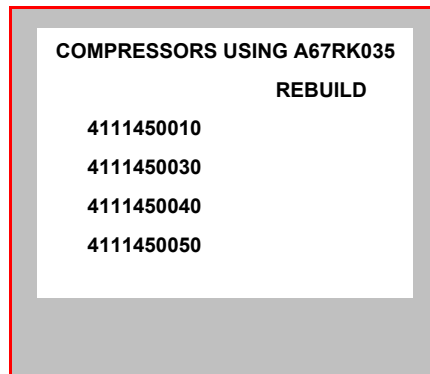

COMPRESSORS USING A67RK035
REBUILD

- 4111450010
- 4111450030
- 4111450040
- 4111450050



A67RK035V



A67RK035V

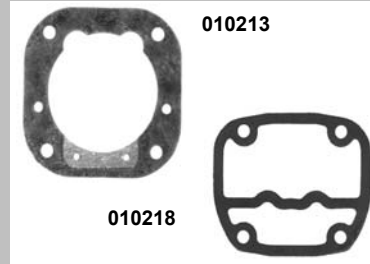

RELATED GASKETS



75mm

020067	A67RK013	STD
020076	A67RK014	+0.50
020095	A67RK023	+1.00

2x2, 1x4mm
PISTONS & RINGS



CHECK OUR WEB SITE FOR SUITABILITY OF THESE AND OTHER PARTS, OR CONTACT US.
ALL PARTS OFFERED ARE MAJORSELL BRAND AND MAY NOT BE OF AN ORIGINAL SUPPLY.
ORIGINAL PART NUMBERS ARE USED FOR REFERENCE ONLY. **CHECK ALL APPLICATIONS.**



Fax ++44 121 455 0272 sales@majorsell.co.uk www.majorsell.co.uk



W006.1

W
A
B
C
O

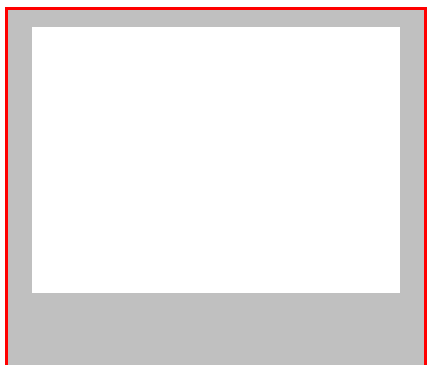
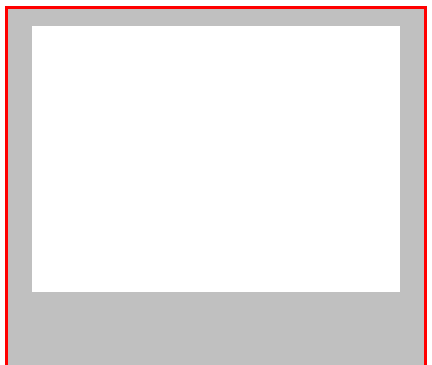
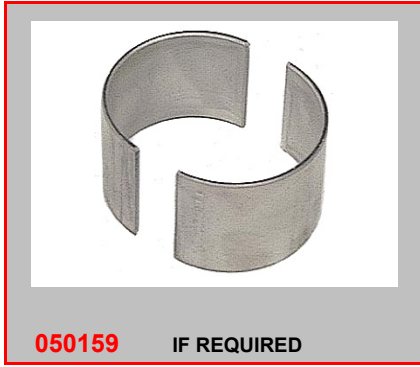

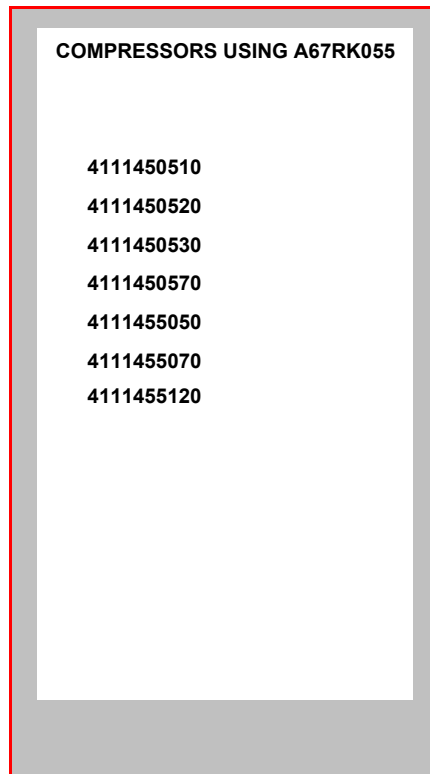

020067	A67RK013	STD
020076	A67RK014	+0.50
020095	A67RK023	+1.00

2x2, 1x4mm
PISTONS & RINGS

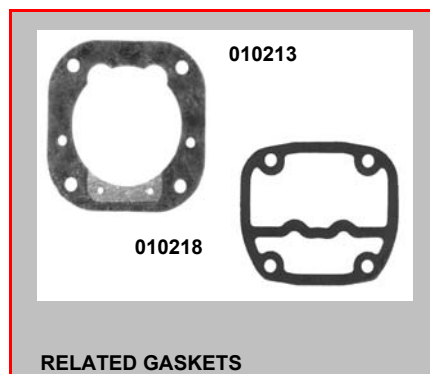

CHECK OUR WEB SITE OR DVD FOR SUITABILITY OF THESE AND OTHER PARTS, OR CONTACT US.

ALL PARTS OFFERED ARE MAJORSELL BRAND AND MAY NOT BE OF AN ORIGINAL SUPPLY.

ORIGINAL PART NUMBERS ARE USED FOR REFERENCE ONLY. **CHECK ALL APPLICATIONS.**



Fax ++44 121 455 0272 sales@majorsell.co.uk www.majorsell.co.uk



W007.1

W
A
B
C
O

IN DEVELOPMENT

220307 SOME TYPES

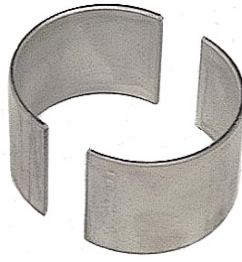

050159 IF REQUIRED



050158 FRONT ALL TYPES





A67RK053



A67RK053A



IN DEVELOPMENT

TYPICAL TYPE

UNIT



A67RK053B



A67RK024C

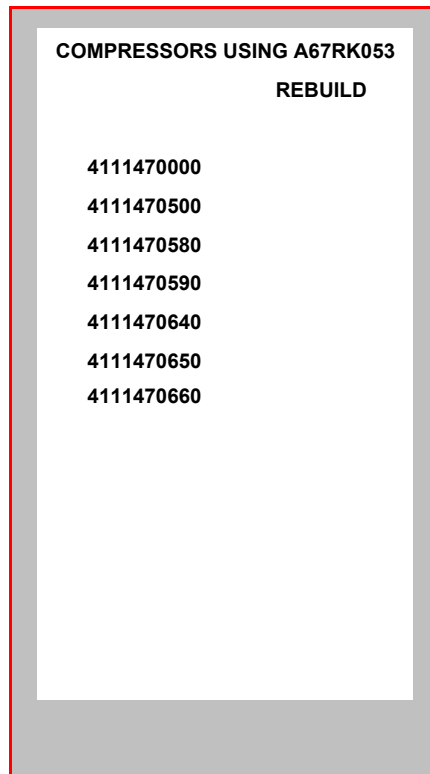

COMPRESSORS USING A67RK053
REBUILD

- 4111470000
- 4111470500
- 4111470580
- 4111470590
- 4111470640
- 4111470650
- 4111470660



A67RK024V



A67RK024V



A67RK004V



A67RK004V

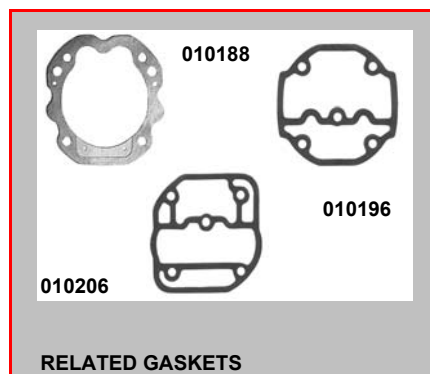

RELATED GASKETS

CHECK OUR WEB SITE FOR SUITABILITY OF THESE AND OTHER PARTS, OR CONTACT US.
ALL PARTS OFFERED ARE MAJORSELL BRAND AND MAY NOT BE OF AN ORIGINAL SUPPLY.
ORIGINAL PART NUMBERS ARE USED FOR REFERENCE ONLY. **CHECK ALL APPLICATIONS.**



Fax ++44 121 455 0272 sales@majorsell.co.uk www.majorsell.co.uk



W008.1

W
A
B
C
O



020068 **020118** **020147**

020068	STD	<u>32mm</u>
020069	+0.50mm	CROWN
020070	+1.00mm	HEIGHT
020118	STD	<u>35mm</u>
020119	+0.50mm	CROWN
		HEIGHT

CHECK CROWN HEIGHT

020147	STD	<u>37mm</u>
020148	+0.50mm	CROWN
020149	+1.00mm	HEIGHT



CHECK CROWN HEIGHT

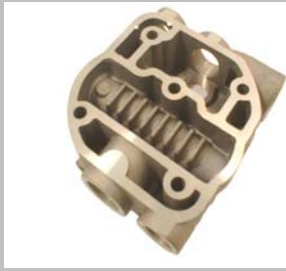

220025 SOME TYPES



2x2.5, 1x4mm A67RK009 +0.50mm
A67RK007 A67RK011 +1.00mm

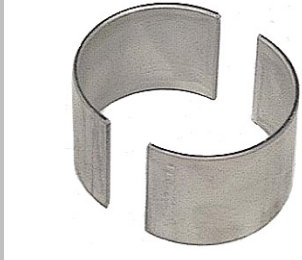

050159 IF REQUIRED



050189 REAR SOME TYPES



050158 SOME SOME TYPES

140132 x 1	60mm
140130 x 1	55mm
140144 x 1	40mm
140143 x 4	80mm
140131 x 4	65mm

HEAD BOLTS AS REQUIRED



140016 MOST TYPES



A67RK057



A67RK057A



4111510000 TYPICAL TYPE
67A054R

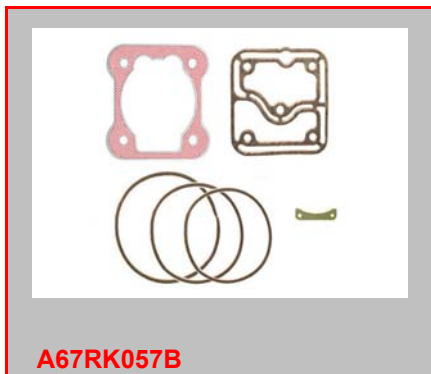

A67RK057B



A67RK057C

COMPRESSORS USING A67RK057
REBUILD

4111510000	67A054R
4111530000	
9111530000	
9111530010	



220093 CHECK APPLICATION



050200 FRONT CHECK APPLICATION



220145



220100 CHECK APPLICATION



85mm STD.

020023	A69RK028	STD
020024	A69RK054	+0.50
020025	A69RK055	+1.00

2 x 2, 1 x 4mm
PISTONS & RINGS

CHECK OUR WEB SITE FOR SUITABILITY OF THESE AND OTHER PARTS, OR CONTACT US.
ALL PARTS OFFERED ARE MAJORSELL BRAND AND MAY NOT BE OF AN ORIGINAL SUPPLY.
ORIGINAL PART NUMBERS ARE USED FOR REFERENCE ONLY. **CHECK ALL APPLICATIONS.**



Fax ++44 121 455 0272 sales@majorsell.co.uk www.majorsell.co.uk



W009.1

W
A
B
C
O

IN DEVELOPMENT

220178

4111530000

140144 x 1
140131 x 4



HEAD BOLTS



140016



050209

FRONT SOME TYPES



A67RK060



A67RK060A



4111540000 TYPICAL TYPE
67A020R



A67RK060B



COMPRESSORS USING A67RK060

	REBUILD
4111510030	-
4111540000	67A020R



220093 CHECK APPLICATION



050200 FRONT CHECK APPLICATION



220149



220100 CHECK APPLICATION



85mm STD.

020023	A69RK028	STD
020024	A69RK054	+0.50
020025	A69RK055	+1.00

2 x 2, 1 x 4mm
PISTONS & RINGS

CHECK OUR WEB SITE FOR SUITABILITY OF THESE AND OTHER PARTS, OR CONTACT US.
ALL PARTS OFFERED ARE MAJORSELL BRAND AND MAY NOT BE OF AN ORIGINAL SUPPLY.
ORIGINAL PART NUMBERS ARE USED FOR REFERENCE ONLY. **CHECK ALL APPLICATIONS.**



Fax ++44 121 455 0272 sales@majorsell.co.uk www.majorsell.co.uk



W010.1

W
A
B
C
O

IN DEVELOPMENT

4111540000

220178

140139 x 1
140131 x 4



HEAD BOLTS



140016



4111540000

220150



220151



220058





A67RK066



A67RK066A



67A056R

TYPICAL TYPE

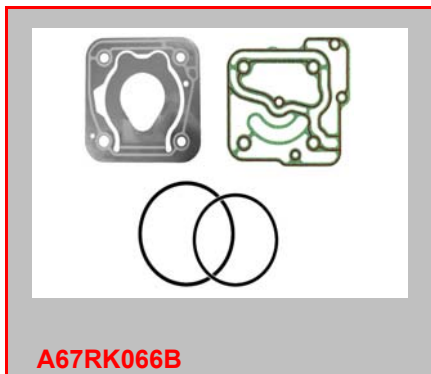

A67RK066B



A67RK062C

COMPRESSORS USING A67RK066
REBUILD

4123520010	
4123520020	67A056R



220093 CHECK APPLICATION



85mm STD.

020023	A69RK028	STD
020024	A69RK054	+0.50
020025	A69RK055	+1.00

2 x 2, 1 x 4mm
PISTONS & RINGS



220151

IN DEVELOPMENT

220178

IN DEVELOPMENT

FRONT 4123520020
050212

CHECK OUR WEB SITE FOR SUITABILITY OF THESE AND OTHER PARTS, OR CONTACT US.
ALL PARTS OFFERED ARE MAJORSELL BRAND AND MAY NOT BE OF AN ORIGINAL SUPPLY.
ORIGINAL PART NUMBERS ARE USED FOR REFERENCE ONLY. **CHECK ALL APPLICATIONS.**



Fax ++44 121 455 0272 sales@majorsell.co.uk www.majorsell.co.uk



W011.1

W
A
B
C
O





A67RK063



A67RK063A



4123520030 TYPICAL TYPE
67A033R

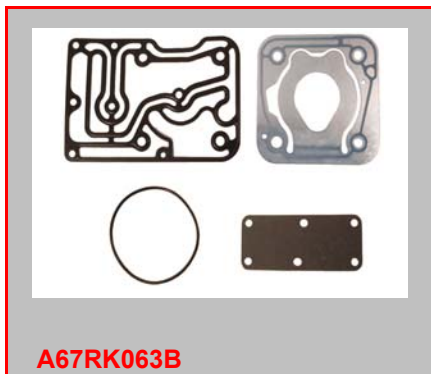

A67RK063B



A67RK063C

COMPRESSORS USING A67RK063
REBUILD

4123520030	67A033R
4123520080	



140143 HEAD BOLDS x 4



220058

160144
IN DEVELOPMENT

140139 HEAD BOLDS x 6
IN DEVELOPMENT



85mm STD.

020023	A69RK028	STD
020024	A69RK054	+0.50
020025	A69RK055	+1.00

2 x 2, 1 x 4mm
PISTONS & RINGS

CHECK OUR WEB SITE FOR SUITABILITY OF THESE AND OTHER PARTS, OR CONTACT US.
ALL PARTS OFFERED ARE MAJORSELL BRAND AND MAY NOT BE OF AN ORIGINAL SUPPLY.
ORIGINAL PART NUMBERS ARE USED FOR REFERENCE ONLY. **CHECK ALL APPLICATIONS.**



Fax ++44 121 455 0272 sales@majorsell.co.uk www.majorsell.co.uk



W012.1

W
A
B
C
O





A67RK067



A67RK067A



UNIT

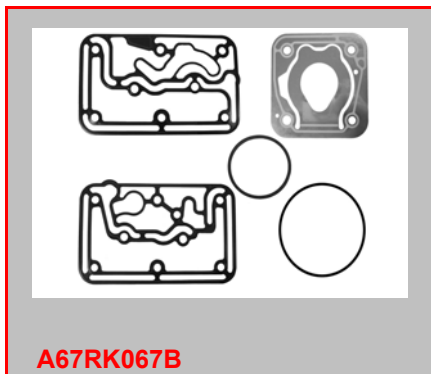

A67RK067B



A67RK067C

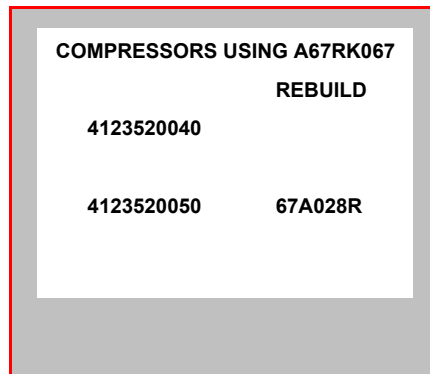

A67RK062D



220058



85mm STD.

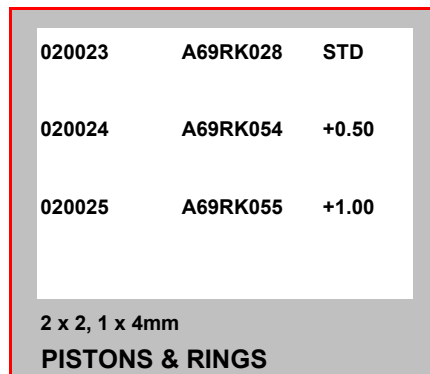

CHECK OUR WEB SITE FOR SUITABILITY OF THESE AND OTHER PARTS, OR CONTACT US.
 ALL PARTS OFFERED ARE MAJORSELL BRAND AND MAY NOT BE OF AN ORIGINAL SUPPLY.
 ORIGINAL PART NUMBERS ARE USED FOR REFERENCE ONLY. **CHECK ALL APPLICATIONS.**



Fax ++44 121 455 0272 sales@majorsell.co.uk www.majorsell.co.uk



W013.1

W
A
B
C
O

140143 x 4
140144 x 4



HEAD BOLTS

220227

IN DEVELOPMENT

220227



FRONT

050158

IN DEVELOPMENT

220226



220224



140016

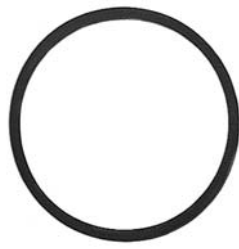

010262

Blank image placeholder.

Blank image placeholder.

Blank image placeholder.

Blank image placeholder.

Blank image placeholder.

Blank image placeholder.

Blank image placeholder.

Blank image placeholder.



A67RK062



A67RK062A



TYPICAL TYPE

67A034R

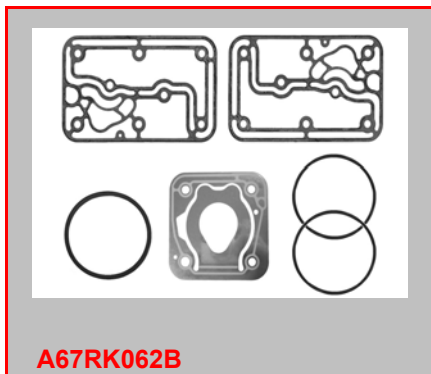

A67RK062B



A67RK062C

COMPRESSORS USING A67RK062 REBUILD

4123520060	
4123520070	
4123520090	
4123520100	67A007R
4123520110	67A034R
4123520130	
4123520140	
4123520150	67A021R
4123520160	



A67RK062D



A67RK062CP



85mm STD.

020023	A69RK028	STD
020024	A69RK054	+0.50
020025	A69RK055	+1.00

2 x 2, 1 x 4mm
PISTONS & RINGS

CHECK OUR WEB SITE FOR SUITABILITY OF THESE AND OTHER PARTS, OR CONTACT US.
ALL PARTS OFFERED ARE MAJORSELL BRAND AND MAY NOT BE OF AN ORIGINAL SUPPLY.
ORIGINAL PART NUMBERS ARE USED FOR REFERENCE ONLY. **CHECK ALL APPLICATIONS.**



Fax ++44 121 455 0272 sales@majorsell.co.uk www.majorsell.co.uk



W014.1

W
A
B
C
O



140128 x 4
140144 x 4

HEAD BOLTS



220058



FRONT

050209 4113520110



220169 MOST TYPES



220093 SOME TYPES



140124

IN DEVELOPMENT

220180



220100 MOST TYPES

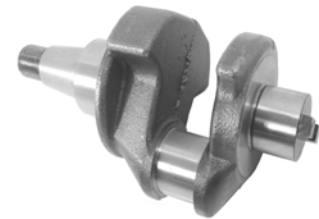

220170 SOME TYPES



140016



A67RK059



A67RK059A



UNIT

TYPICAL TYPE

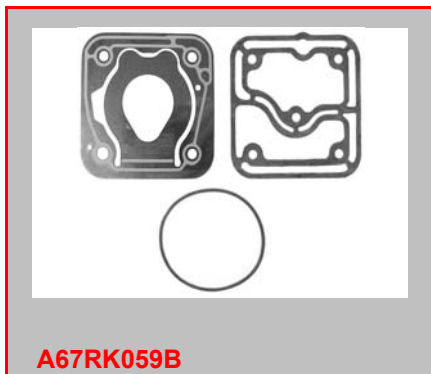

A67RK059B



VALVE KIT
USE HEAD KIT

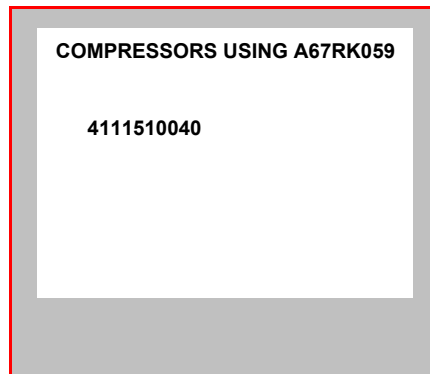

COMPRESSORS USING A67RK059

4111510040



140016



050197



220058



HEAD BOLTS

140144 x 1

140131 x 4



85mm STD.

020023	A69RK028	STD
020024	A69RK054	+0.50
020025	A69RK055	+1.00

2 x 2, 1 x 4mm
PISTONS & RINGS

CHECK OUR WEB SITE FOR SUITABILITY OF THESE AND OTHER PARTS, OR CONTACT US.
ALL PARTS OFFERED ARE MAJORSELL BRAND AND MAY NOT BE OF AN ORIGINAL SUPPLY.
ORIGINAL PART NUMBERS ARE USED FOR REFERENCE ONLY. **CHECK ALL APPLICATIONS.**



Fax ++44 121 455 0272 sales@majorsell.co.uk www.majorsell.co.uk



W015.1

W
A
B
C
O





A67RK069



A67RK069A



IN DEVELOPMENT
TYPICAL TYPE
UNIT

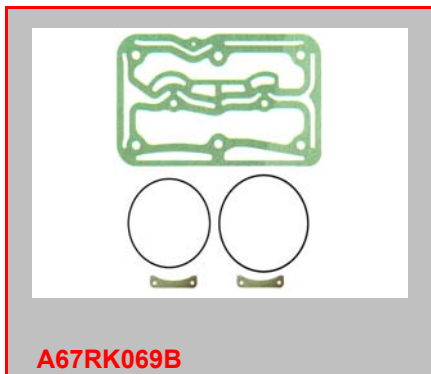

A67RK069B



A67RK069C

COMPRESSORS USING A67RK069
REBUILD
4126360000
9115530000
9115530010



220100

9115530030
9115530010



050209

911 TYPES



220058



4x2, 1x4.75mm OLD STYLE
A69RK010 STD. ONLY



020023

85mm STD.

020023	A69RK028	STD
020024	A69RK054	+0.50
020025	A69RK055	+1.00
2 x 2, 1 x 4mm PISTONS & RINGS		

CHECK OUR WEB SITE FOR SUITABILITY OF THESE AND OTHER PARTS, OR CONTACT US.
ALL PARTS OFFERED ARE MAJORSELL BRAND AND MAY NOT BE OF AN ORIGINAL SUPPLY.
ORIGINAL PART NUMBERS ARE USED FOR REFERENCE ONLY. **CHECK ALL APPLICATIONS.**



Fax ++44 121 455 0272 sales@majorsell.co.uk www.majorsell.co.uk



W016.1

W
A
B
C
O

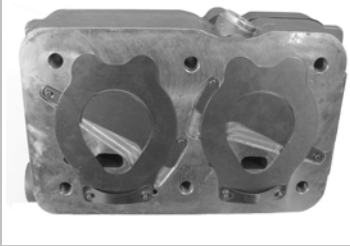

9115530010

9115530030

220101



9115530020

220150



9115530010

9115530030

220163

IN DEVELOPMENT

220179

9115530010

IN DEVELOPMENT

220323

9115530030



4 USED

4 USED

9115530010

140135



4 USED

9115530010

9115530030

140143



911 TYPES

220093



CRANK NUT

Fits 4126360000

9115530030

140203

IN DEVELOPMENT

CRANK PIN

Fits 9115530000

9115530010

TBA



COMPRESSORS USING A67RK068

4127040010	67A027R
4127040040	67A047R
4127040050	67A046R
4127040080	67A041R



020023	A69RK028	STD
020024	A69RK054	+0.50
020025	A69RK055	+1.00

2 x 2, 1 x 4mm
PISTONS & RINGS

CHECK OUR WEB SITE FOR SUITABILITY OF THESE AND OTHER PARTS, OR CONTACT US.
ALL PARTS OFFERED ARE MAJORSELL BRAND AND MAY NOT BE OF AN ORIGINAL SUPPLY.
ORIGINAL PART NUMBERS ARE USED FOR REFERENCE ONLY. **CHECK ALL APPLICATIONS.**



Fax ++44 121 455 0272 sales@majorsell.co.uk www.majorsell.co.uk



W017.1

W
A
B
C
O

IN DEVELOPMENT

220166 4127040010

IN DEVELOPMENT

220228 4127040080



140016 MOST TYPES



MOST TYPES

220224



FRONT

050186

IN DEVELOPMENT

220179 9115530010

IN DEVELOPMENT

220323 9115530030



220229 4127040080

TYPICAL PARTS FOR 85mm TWIN TYPES

W017A

W
A
B
C
O

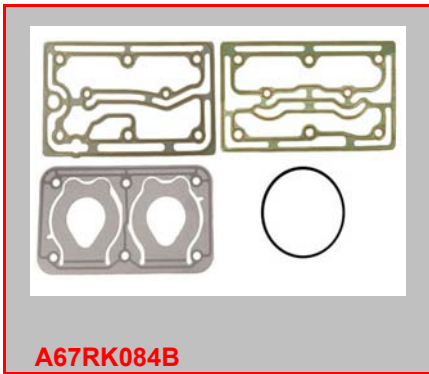
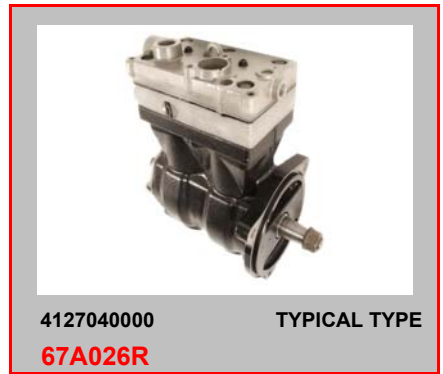

COMPRESSORS USING A67RK084

4127040000	67A026R
4127040020	
4127040070	
4127040100	
4127040110	
4127040120	67A042R
4127040130	
4127040140	67A044R
4127040150	



020023	A69RK028	STD
020024	A69RK054	+0.50
020025	A69RK055	+1.00

2 x 2, 1 x 4mm NEW STYLE
PISTONS & RINGS

CHECK OUR WEB SITE FOR SUITABILITY OF THESE AND OTHER PARTS, OR CONTACT US.
ALL PARTS OFFERED ARE MAJORSELL BRAND AND MAY NOT BE OF AN ORIGINAL SUPPLY.
ORIGINAL PART NUMBERS ARE USED FOR REFERENCE ONLY. **CHECK ALL APPLICATIONS.**



Fax ++44 121 455 0272 sales@majorsell.co.uk www.majorsell.co.uk



W017A.1

W
A
B
C
O

IN DEVELOPMENT

220166

4127040010

IN DEVELOPMENT

220228

4127040080



140016

MOST TYPES



SOME TYPES

220224



220058



FRONT

050186

IN DEVELOPMENT

220179

9115530010

IN DEVELOPMENT

220323

9115530030



220229

4127040080

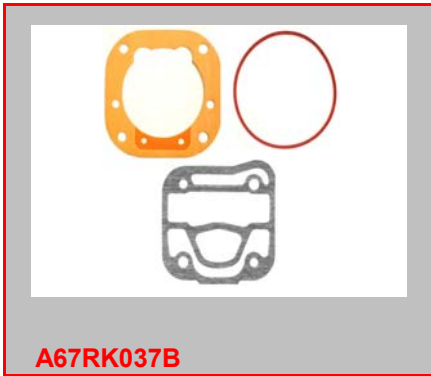

COMPRESSORS USING A67RK037

9111410010	67A025R
9111450020	



020067	A67RK013	STD
020076	A67RK014	+0.50
020095	A67RK023	+1.00

2x2, 1x4mm
PISTONS & RINGS

CHECK OUR WEB SITE FOR SUITABILITY OF THESE AND OTHER PARTS, OR CONTACT US.
ALL PARTS OFFERED ARE MAJORSELL BRAND AND MAY NOT BE OF AN ORIGINAL SUPPLY.
ORIGINAL PART NUMBERS ARE USED FOR REFERENCE ONLY. **CHECK ALL APPLICATIONS.**



Fax ++44 121 455 0272 sales@majorsell.co.uk www.majorsell.co.uk



W018.1

W
A
B
C
O



IN DEVELOPMENT

A67RK036

A67RK036A

9111460030 TYPICAL TYPE
67A055R

A67RK036B

A67RK024C

COMPRESSORS USING A67RK036

9111420000
9111460030 67A055R

PCGA1082
PCGA1085

A67RK036V

A67RK036V

020068 020118 020147

020068	STD	<u>32mm</u>
020069	+0.50mm	CROWN
020070	+1.00mm	HEIGHT
020118	STD	<u>35mm</u>
020119	+0.50mm	CROWN
		HEIGHT

CHECK CROWN HEIGHT

020147	STD	<u>37mm</u>
020148	+0.50mm	CROWN
020149	+1.00mm	HEIGHT

CHECK CROWN HEIGHT

CHECK OUR WEB SITE FOR SUITABILITY OF THESE AND OTHER PARTS, OR CONTACT US.

ALL PARTS OFFERED ARE MAJORSELL BRAND AND MAY NOT BE OF AN ORIGINAL SUPPLY.

ORIGINAL PART NUMBERS ARE USED FOR REFERENCE ONLY. **CHECK ALL APPLICATIONS.**



Fax ++44 121 455 0272 sales@majorsell.co.uk www.majorsell.co.uk



W019.1

W
A
B
C
O

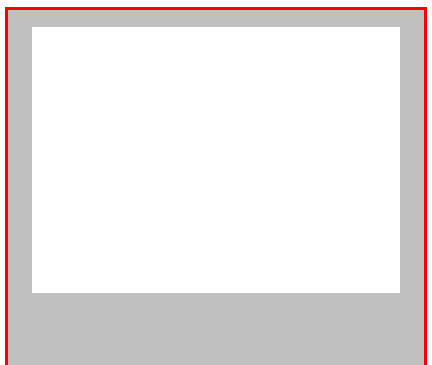
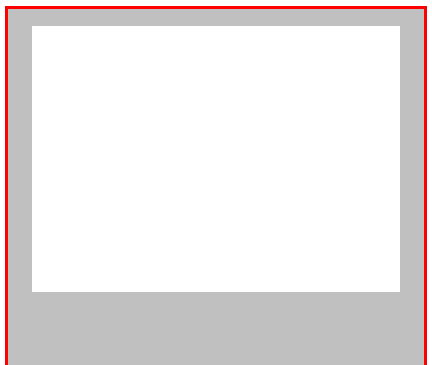



A67RK038



A67RK038A



9111450500 TYPICAL TYPE
67A031R



A67RK038B



A67RK038C

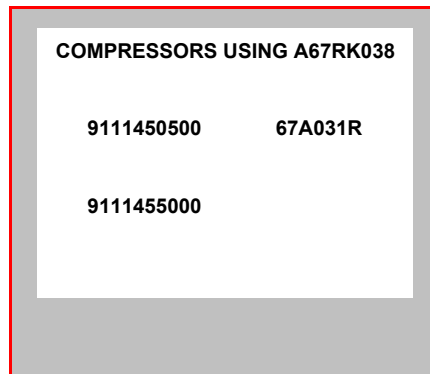

050158



140015

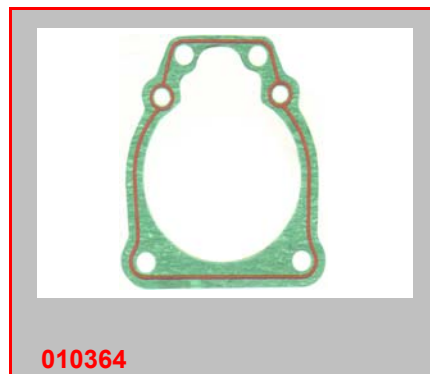

010364



75mm

020067	A67RK013	STD
020076	A67RK014	+0.50
020095	A67RK023	+1.00

2x2, 1x4mm
PISTONS & RINGS



CHECK OUR WEB SITE FOR SUITABILITY OF THESE AND OTHER PARTS, OR CONTACT US.
ALL PARTS OFFERED ARE MAJORSELL BRAND AND MAY NOT BE OF AN ORIGINAL SUPPLY.
ORIGINAL PART NUMBERS ARE USED FOR REFERENCE ONLY. **CHECK ALL APPLICATIONS.**



Fax ++44 121 455 0272 sales@majorsell.co.uk www.majorsell.co.uk



W020.1

W
A
B
C
O





A67RK047



A67RK047A



67A066R

TYPICAL TYPE



A67RK047B



A67RK047C

COMPRESSORS USING A67RK047
REBUILD

9111450600	67A016R
9111455600	67A066R



75mm

020067	A67RK013	STD
020076	A67RK014	+0.50
020095	A67RK023	+1.00

2x2, 1x4mm
PISTONS & RINGS



CHECK OUR WEB SITE FOR SUITABILITY OF THESE AND OTHER PARTS, OR CONTACT US.
ALL PARTS OFFERED ARE MAJORSELL BRAND AND MAY NOT BE OF AN ORIGINAL SUPPLY.
ORIGINAL PART NUMBERS ARE USED FOR REFERENCE ONLY. **CHECK ALL APPLICATIONS.**



Fax ++44 121 455 0272 sales@majorsell.co.uk www.majorsell.co.uk



W021.1

W
A
B
C
O



CORE PLUG

080038



OIL SEAL

110037



MOUNT GASKET

010364



FRONT BUSH

050158

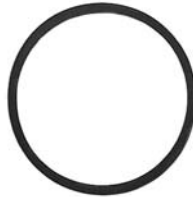

REAR COVER SEAL

010262



CRANKSHAFT NUT

140015



HEAD BOLT

4 used

140128



END COVER BOLT

4 used

140124



CONN ROD

220315

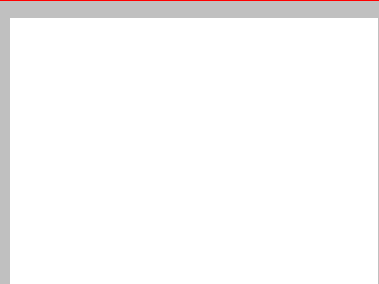
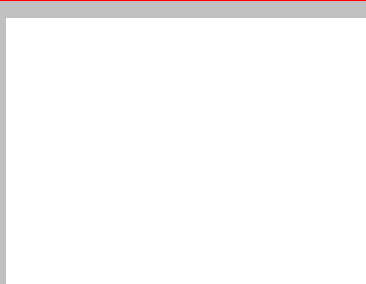
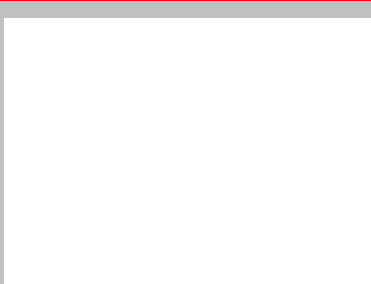
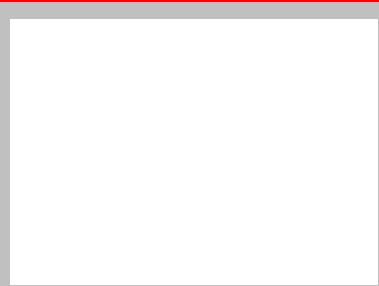
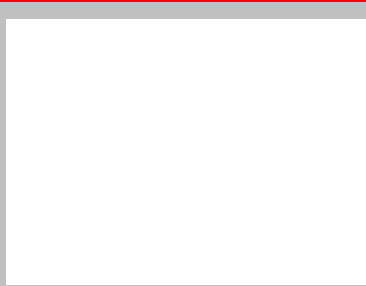
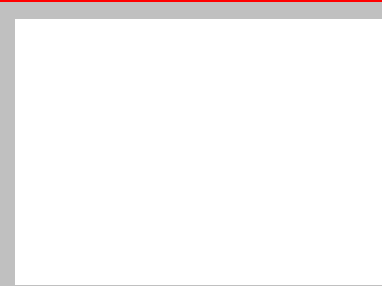



A67RK058



A67RK058A



67A024R

TYPICAL TYPE



A67RK058B



A67RK058C

COMPRESSORS USING A67RK058
REBUILD

9111535100	67A024R
9111535200	



050207 FRONT SOME TYPES



220058



85mm STD.

020023	A69RK028	STD
020024	A69RK054	+0.50
020025	A69RK055	+1.00

2 x 2, 1 x 4mm
PISTONS & RINGS

CHECK OUR WEB SITE FOR SUITABILITY OF THESE AND OTHER PARTS, OR CONTACT US.
ALL PARTS OFFERED ARE MAJORSELL BRAND AND MAY NOT BE OF AN ORIGINAL SUPPLY.
ORIGINAL PART NUMBERS ARE USED FOR REFERENCE ONLY. **CHECK ALL APPLICATIONS.**



Fax ++44 121 455 0272 sales@majorsell.co.uk www.majorsell.co.uk



W022.1

W
A
B
C
O





A67RK070

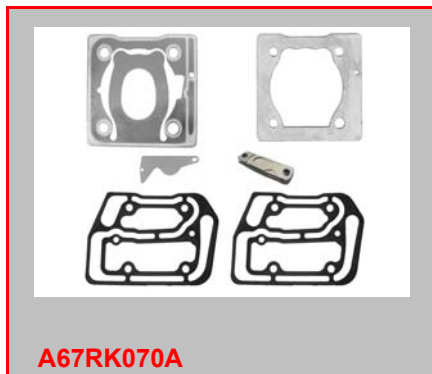

A67RK070A



67A014R

TYPICAL TYPE



A67RK070B



A67RK070C

COMPRESSORS USING A67RK070
REBUILD

9111545000	67A014R
9111545020	
9111545150	



FRONT
050207



REAR
6308

IN DEVELOPMENT



220058



75mm

020067	A67RK013	STD
020076	A67RK014	+0.50
020095	A67RK023	+1.00

2x2, 1x4mm
PISTONS & RINGS

CHECK OUR WEB SITE OR DVD FOR SUITABILITY OF THESE AND OTHER PARTS, OR CONTACT US.
ALL PARTS OFFERED ARE MAJORSELL BRAND AND MAY NOT BE OF AN ORIGINAL SUPPLY.
ORIGINAL PART NUMBERS ARE USED FOR REFERENCE ONLY. **CHECK ALL APPLICATIONS.**



Fax ++44 121 455 0272 sales@majorsell.co.uk www.majorsell.co.uk



W023.1

W
A
B
C
O

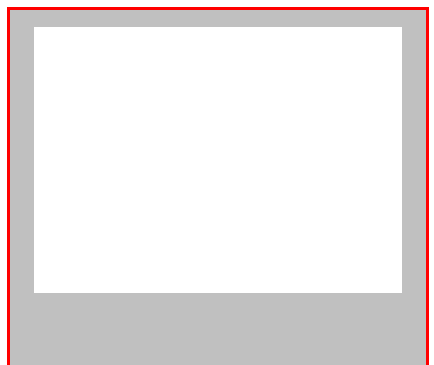
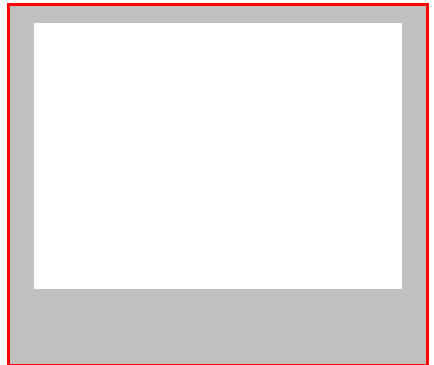



A67RK005



A67RK005A



9115060540 TYPICAL TYPE
67A015R



A67RK005B



A67RK005C

COMPRESSORS USING A67RK005 REBUILD

9115010000	
9115010010	
9115010100	
9115010110	
9115010150	67A003R
9115010160	67A004R
9115010550	
9115010560	
9115010570	
9115010580	
9115010590	67A015R
9115010630	



220068



050102



220305 IN DEVELOPMENT



85mm STD.

020023	A69RK028	STD
020024	A69RK054	+0.50
020025	A69RK055	+1.00

2 x 2, 1 x 4mm
PISTONS & RINGS

CHECK OUR WEB SITE FOR SUITABILITY OF THESE AND OTHER PARTS, OR CONTACT US.
ALL PARTS OFFERED ARE MAJORSELL BRAND AND MAY NOT BE OF AN ORIGINAL SUPPLY.
ORIGINAL PART NUMBERS ARE USED FOR REFERENCE ONLY. **CHECK ALL APPLICATIONS.**



Fax ++44 121 455 0272 sales@majorsell.co.uk www.majorsell.co.uk



W024.1

W
A
B
C
O

140167 x 2
140138 x 2
140169 x 2
140137 x 6
140168 x 4

HEAD BOLTS

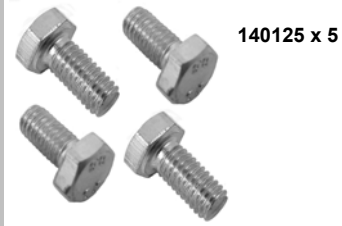

SUMP BOLTS



END COVER BOLTS

IN DEVELOPMENT

9115010000
9115010100
9115010150
9115010620

220303



9115010010
9115010110
9115010160

220067 SOME TYPES



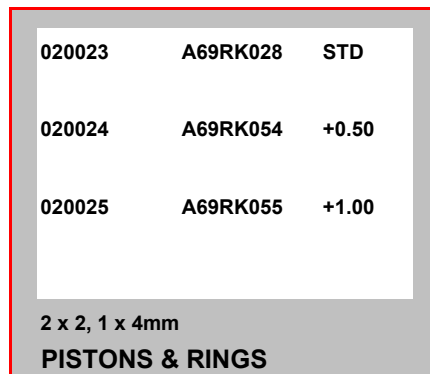
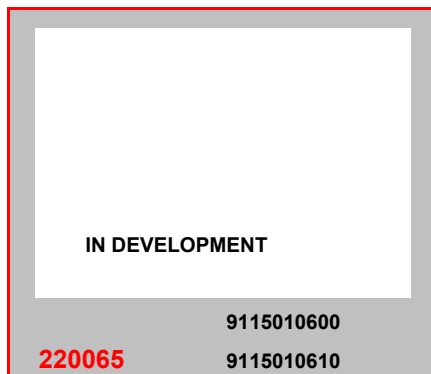
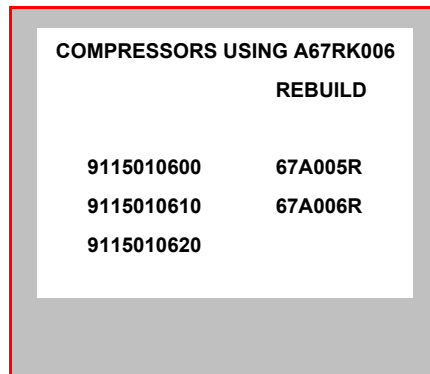

CHECK OUR WEB SITE FOR SUITABILITY OF THESE AND OTHER PARTS, OR CONTACT US.

ALL PARTS OFFERED ARE MAJORSELL BRAND AND MAY NOT BE OF AN ORIGINAL SUPPLY.

ORIGINAL PART NUMBERS ARE USED FOR REFERENCE ONLY. **CHECK ALL APPLICATIONS.**



Fax ++44 121 455 0272 sales@majorsell.co.uk www.majorsell.co.uk



W025.1

W
A
B
C
O



050102

IN DEVELOPMENT

220305



140124 4 USED



140134 8 USED
SUMP



140130 x 2
140171 x 6

9115010600
HEAD BOLTS 9115010610

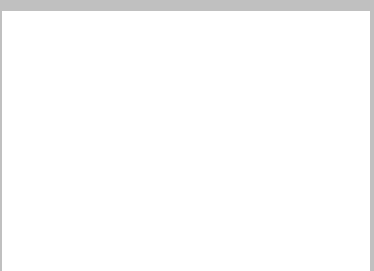
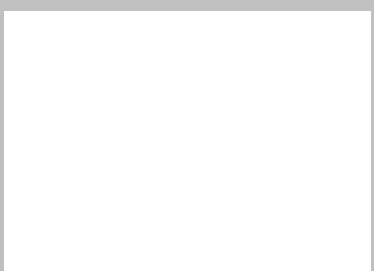
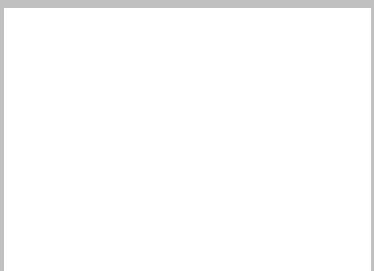
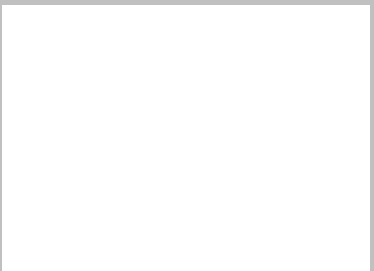
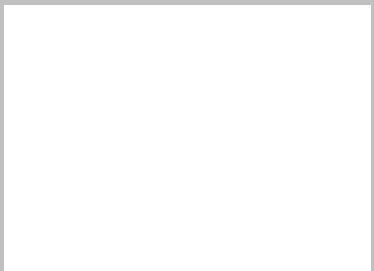
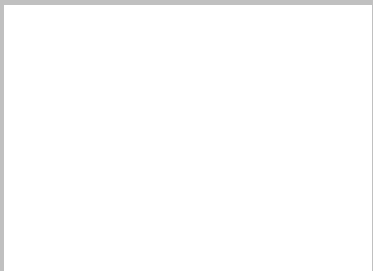



A67RK017

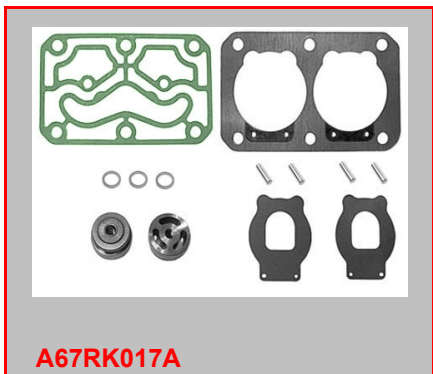

A67RK017A

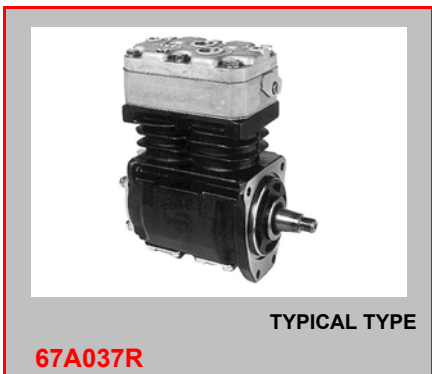

67A037R

TYPICAL TYPE

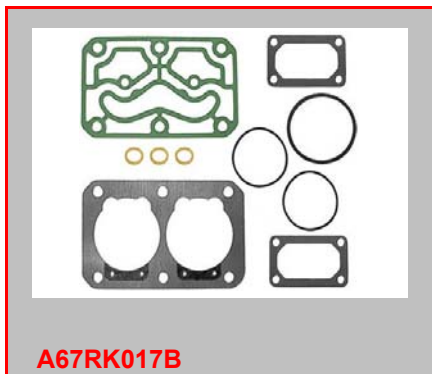

A67RK017B



A67RK017C

COMPRESSORS USING A67RK017
REBUILD

9115030500	
9115030510	67A037R
9115031000	



REAR

050158



75mm

020067	A67RK013	STD
020076	A67RK014	+0.50
020095	A67RK023	+1.00

2 x 2, 1x4mm
PISTONS & RINGS

CHECK OUR WEB SITE FOR SUITABILITY OF THESE AND OTHER PARTS, OR CONTACT US.
ALL PARTS OFFERED ARE MAJORSELL BRAND AND MAY NOT BE OF AN ORIGINAL SUPPLY.
ORIGINAL PART NUMBERS ARE USED FOR REFERENCE ONLY. **CHECK ALL APPLICATIONS.**



Fax ++44 121 455 0272 sales@majorsell.co.uk www.majorsell.co.uk



W026.1

W
A
B
C
O



140127 4 USED



140101 x 2
140132 x 6

HEAD BOLTS





A67RK025



A67RK025A



67A018

TYPICAL TYPE



A67RK025B



A67RK025C

COMPRESSORS USING A67RK025
REBUILD

9115040500	
9115040510	
9115040520	67A018



A67RK025V



A67RK025V

IN DEVELOPMENT

220306



FRONT & REAR

050018



75mm

020067	A67RK013	STD
020076	A67RK014	+0.50
020095	A67RK023	+1.00

2 x 2, 1x4mm
PISTONS & RINGS

CHECK OUR WEB SITE FOR SUITABILITY OF THESE AND OTHER PARTS, OR CONTACT US.
ALL PARTS OFFERED ARE MAJORSELL BRAND AND MAY NOT BE OF AN ORIGINAL SUPPLY.
ORIGINAL PART NUMBERS ARE USED FOR REFERENCE ONLY. **CHECK ALL APPLICATIONS.**



Fax ++44 121 455 0272 sales@majorsell.co.uk www.majorsell.co.uk



W027.1

W
A
B
C
O



140135

4 USED



140134

8 USED

IN DEVELOPMENT

140171

HEAD BOLTS

6 USED

IN DEVELOPMENT

220307



050180

IN DEVELOPMENT

9115040510

220308

9115040520

IN DEVELOPMENT

220309



A67RK056



A67RK056A



67A009R

TYPICAL TYPE

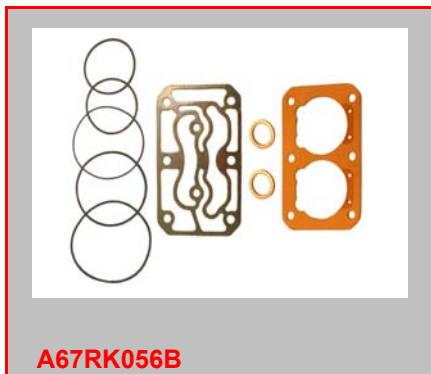

A67RK056B

32 mm Valves no longer available. Use 35mm Valves and machine head to suit.

COMPRESSORS USING A67RK056 REBUILD

9115040560	67A019R
9115040590	
9115040600	67A009R



A67RK056C



A67RK017C ALT DESIGN REED

IN DEVELOPMENT

220310



FRONT & REAR
050018



75mm

020067	A67RK013	STD
020076	A67RK014	+0.50
020095	A67RK023	+1.00

2 x 2, 1x4mm
PISTONS & RINGS

CHECK OUR WEB SITE FOR SUITABILITY OF THESE AND OTHER PARTS, OR CONTACT US.

ALL PARTS OFFERED ARE MAJORSELL BRAND AND MAY NOT BE OF AN ORIGINAL SUPPLY.

ORIGINAL PART NUMBERS ARE USED FOR REFERENCE ONLY. **CHECK ALL APPLICATIONS.**



Fax ++44 121 455 0272 sales@majorsell.co.uk www.majorsell.co.uk



W028.1

W
A
B
C
O



140135 2 USED



140134 8 USED



140130 x 2
140171 x 6

HEAD BOLTS

IN DEVELOPMENT

220307 9115040590



050180 FOR 220307

IN DEVELOPMENT

220309 9115040560

IN DEVELOPMENT

220313 9115040600

IN DEVELOPMENT

220311 9115040560
9115040600

IN DEVELOPMENT

220308 9115040560

IN DEVELOPMENT

220312 9115040590
9115040600



220187 911040590



220058 9115040600
9115040590

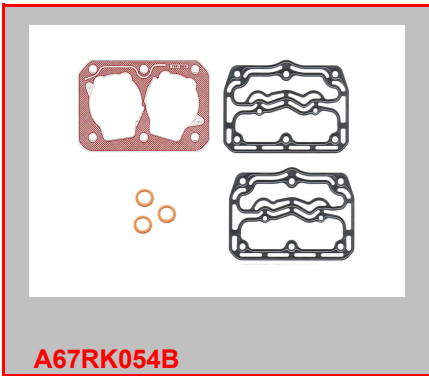
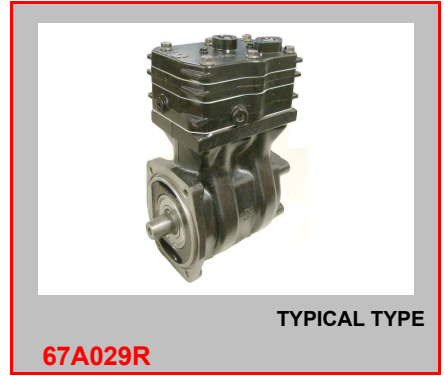
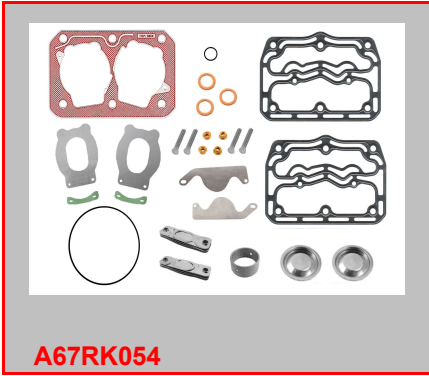

COMPRESSORS USING A67RK054 REBUILD

9115045000	67A010R
9115045010	67A029R
9115045030	67A045R

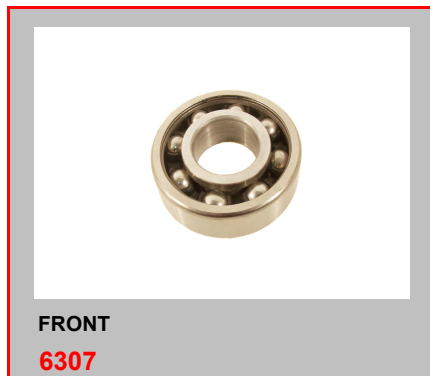

020067	A67RK013	STD
020076	A67RK014	+0.50
020095	A67RK023	+1.00

2 x 2, 1x4mm
PISTONS & RINGS

CHECK OUR WEB SITE FOR SUITABILITY OF THESE AND OTHER PARTS, OR CONTACT US.
ALL PARTS OFFERED ARE MAJORSELL BRAND AND MAY NOT BE OF AN ORIGINAL SUPPLY.
ORIGINAL PART NUMBERS ARE USED FOR REFERENCE ONLY. **CHECK ALL APPLICATIONS.**



Fax ++44 121 455 0272 sales@majorseil.co.uk www.majorseil.co.uk



W029.1

W
A
B
C
O

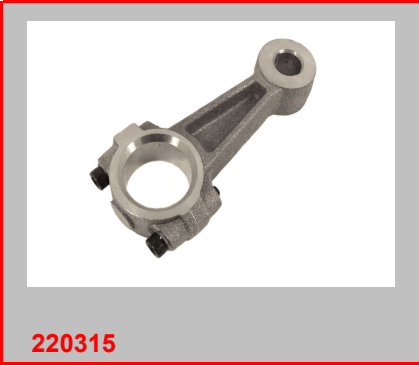
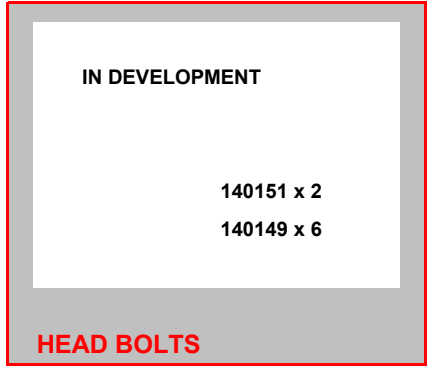



COMPRESSORS USING A67RK034
REBUILD

9115050500
9115051500 67A001R

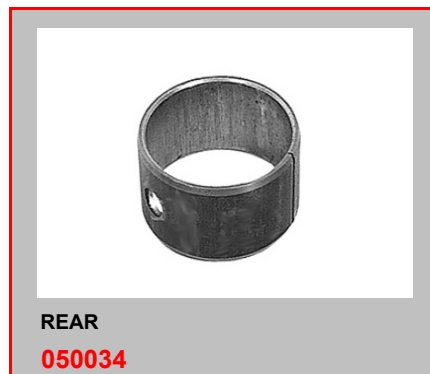

IN DEVELOPMENT

220065



020023	A69RK028	STD
020024	A69RK054	+0.50
020025	A69RK055	+1.00

2 x 2, 1 x 4mm
PISTONS & RINGS

CHECK OUR WEB SITE FOR SUITABILITY OF THESE AND OTHER PARTS, OR CONTACT US.
ALL PARTS OFFERED ARE MAJORSELL BRAND AND MAY NOT BE OF AN ORIGINAL SUPPLY.
ORIGINAL PART NUMBERS ARE USED FOR REFERENCE ONLY. **CHECK ALL APPLICATIONS.**



Fax ++44 121 455 0272 sales@majorsell.co.uk www.majorsell.co.uk



W030.1

W
A
B
C
O



050176

IF REQUIRED



140130 x 2

140171 x 6

HEAD BOLTS



220315



220314



140135

5 USED



REAR

220222



140125

8 USED

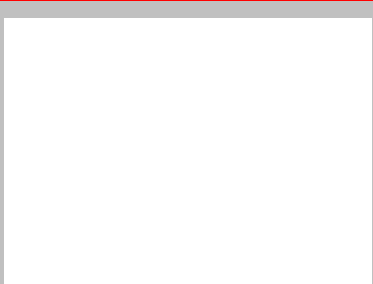
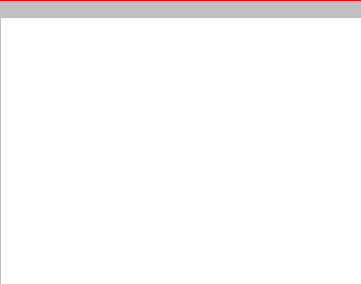
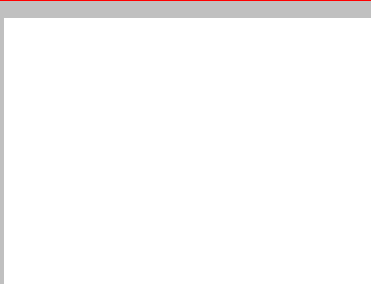
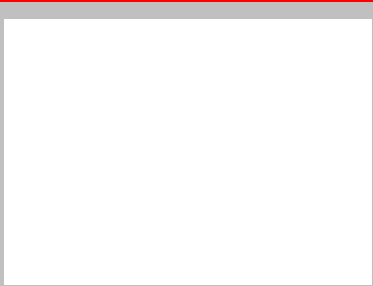
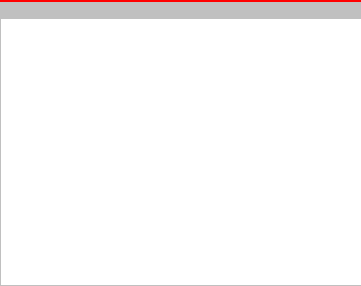
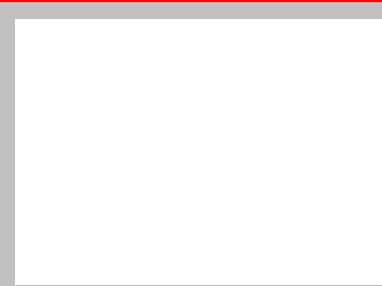



A67RK082



A67RK082A



67A038R

TYPICAL TYPE

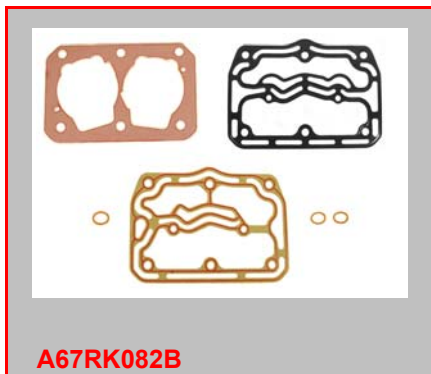

A67RK082B



A67RK054C

COMPRESSORS USING A67RK082
REBUILD

9115045040	67A038R
9115045050	67A039R

WILL INTERCHANGE



A67RK054D



FRONT
6307



REAR
050158



75mm

020067	A67RK013	STD
020076	A67RK014	+0.50
020095	A67RK023	+1.00

2 x 2, 1x4mm
PISTONS & RINGS

CHECK OUR WEB SITE FOR SUITABILITY OF THESE AND OTHER PARTS, OR CONTACT US.
ALL PARTS OFFERED ARE MAJORSELL BRAND AND MAY NOT BE OF AN ORIGINAL SUPPLY.
ORIGINAL PART NUMBERS ARE USED FOR REFERENCE ONLY. **CHECK ALL APPLICATIONS.**



Fax ++44 121 455 0272 sales@majorsell.co.uk www.majorsell.co.uk



W031.1

W
A
B
C
O



220058

IN DEVELOPMENT

140148 x 6

140149 x 6

HEAD BOLTS



220315



220314



REAR

220222

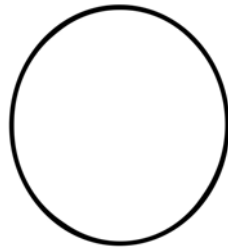

RM1250-30V

FLANGE

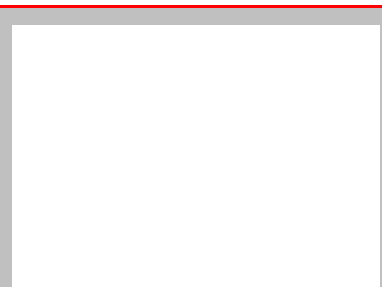
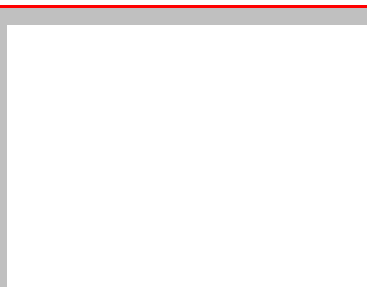
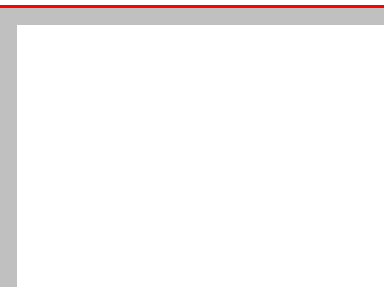
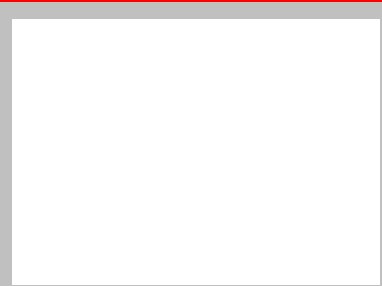
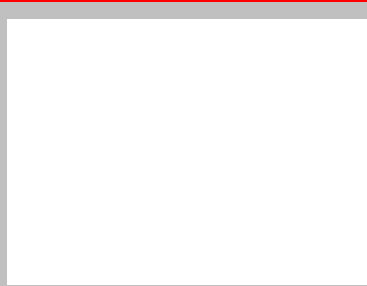
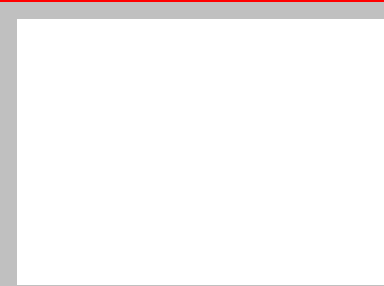

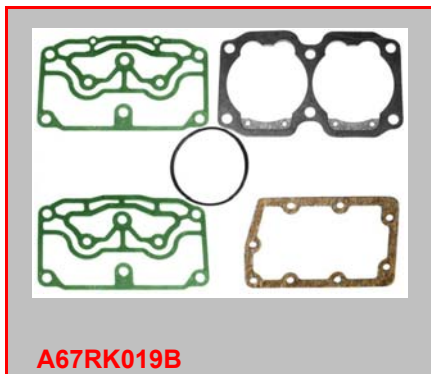

COMPRESSORS USING A67RK019 REBUILD

9115051500	67A001R
9115051510	67A002R
9115051530	
9115051540	67A035R



020023	A69RK028	STD
020024	A69RK054	+0.50
020025	A69RK055	+1.00

2 x 2, 1 x 4mm
PISTONS & RINGS

CHECK OUR WEB SITE FOR SUITABILITY OF THESE AND OTHER PARTS, OR CONTACT US.
 ALL PARTS OFFERED ARE MAJORSELL BRAND AND MAY NOT BE OF AN ORIGINAL SUPPLY.
 ORIGINAL PART NUMBERS ARE USED FOR REFERENCE ONLY. **CHECK ALL APPLICATIONS.**



Fax ++44 121 455 0272 sales@majorsell.co.uk www.majorsell.co.uk



W032.1

W
A
B
C
O



220058



140136 x 6
140132 x 2

HEAD BOLTS



220222



220224

IN DEVELOPMENT

9115051500
9115051510

220131



140135

4 USED



REAR

220222

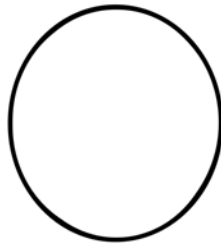

RM1250-30V

FLANGE



140016

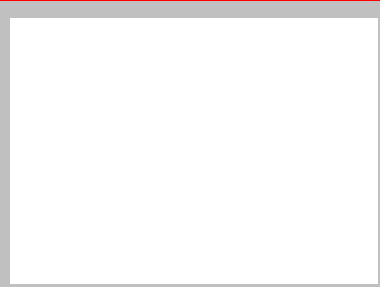
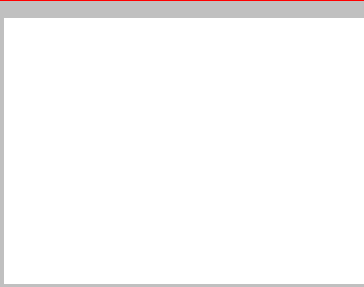
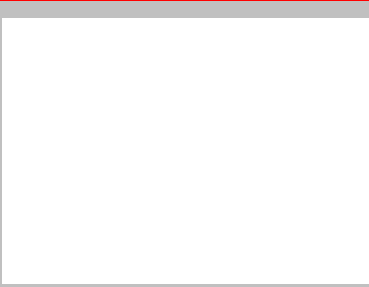
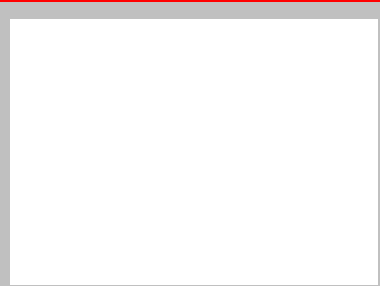
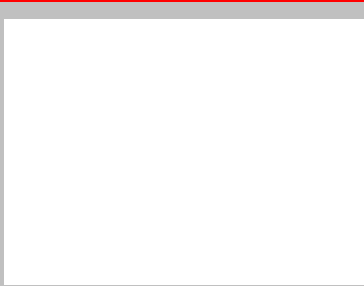
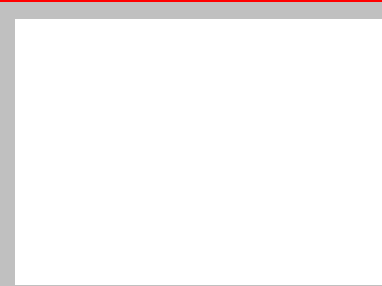



A67RK042



A67RK042A



67A017R

TYPICAL TYPE



A67RK042B



A67RK017C

COMPRESSORS USING A67RK042
REBUILD

9115060500	67A017R
9115060530	



FRONT
050158



HEAD BOLTS

140101 x 2
140131 x 6



140125 4 USED



75mm STD.

020067	A67RK013	STD
020076	A67RK014	+0.50
020095	A67RK023	+1.00

2 x 2, 1 x 4mm
PISTONS & RINGS

CHECK OUR WEB SITE FOR SUITABILITY OF THESE AND OTHER PARTS, OR CONTACT US.
ALL PARTS OFFERED ARE MAJORSELL BRAND AND MAY NOT BE OF AN ORIGINAL SUPPLY.
ORIGINAL PART NUMBERS ARE USED FOR REFERENCE ONLY. **CHECK ALL APPLICATIONS.**



Fax ++44 121 455 0272 sales@majorsell.co.uk www.majorsell.co.uk



W033.1

W
A
B
C
O





A67RK049



A67RK049A



67A058R

TYPICAL TYPE



A67RK049B



A67RK017C

COMPRESSORS USING A67RK049
REBUILD

9115060520	
9115060540	67A058R



FRONT
050158



140127 4 USED



220058



75mm STD.

020067	A67RK013	STD
020076	A67RK014	+0.50
020095	A67RK023	+1.00

2 x 2, 1 x 4mm
PISTONS & RINGS

CHECK OUR WEB SITE FOR SUITABILITY OF THESE AND OTHER PARTS, OR CONTACT US.
ALL PARTS OFFERED ARE MAJORSELL BRAND AND MAY NOT BE OF AN ORIGINAL SUPPLY.
ORIGINAL PART NUMBERS ARE USED FOR REFERENCE ONLY. **CHECK ALL APPLICATIONS.**



Fax ++44 121 455 0272 sales@majorsell.co.uk www.majorsell.co.uk



W034.1

W
A
B
C
O





A67RK039



A67RK039A



9115065000 TYPICAL TYPE
67A050R



A67RK039B



A67RK039C

COMPRESSORS USING A67RK039
REBUILD

9115065000	67A050R
9115065010	



FRONT
050158



140127 4 USED



220058



75mm STD.

020067	A67RK013	STD
020076	A67RK014	+0.50
020095	A67RK023	+1.00

2 x 2, 1 x 4mm
PISTONS & RINGS

CHECK OUR WEB SITE FOR SUITABILITY OF THESE AND OTHER PARTS, OR CONTACT US.
ALL PARTS OFFERED ARE MAJORSELL BRAND AND MAY NOT BE OF AN ORIGINAL SUPPLY.
ORIGINAL PART NUMBERS ARE USED FOR REFERENCE ONLY. **CHECK ALL APPLICATIONS.**



Fax ++44 121 455 0272 sales@majorsell.co.uk www.majorsell.co.uk



W035.1

W
A
B
C
O





A67RK050



A67RK050A



IN DEVELOPMENT

TYPICAL TYPE

UNIT



A67RK050B



A67RK050C

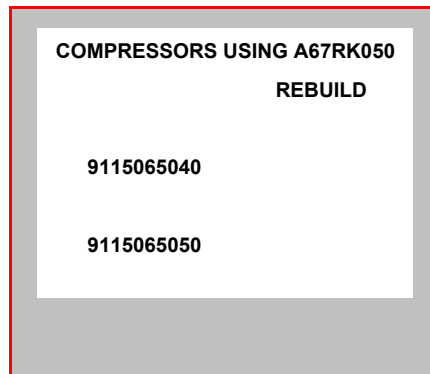

COMPRESSORS USING A67RK050
REBUILD

9115065040

9115065050



FRONT
050158



220058



75mm STD.

020067	A67RK013	STD
020076	A67RK014	+0.50
020095	A67RK023	+1.00

2 x 2, 1 x 4mm
PISTONS & RINGS

CHECK OUR WEB SITE FOR SUITABILITY OF THESE AND OTHER PARTS, OR CONTACT US.
ALL PARTS OFFERED ARE MAJORSELL BRAND AND MAY NOT BE OF AN ORIGINAL SUPPLY.
ORIGINAL PART NUMBERS ARE USED FOR REFERENCE ONLY. **CHECK ALL APPLICATIONS.**



Fax ++44 121 455 0272 sales@majorsell.co.uk www.majorsell.co.uk



W036.1

W
A
B
C
O



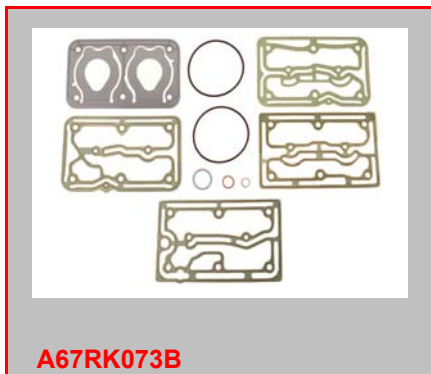
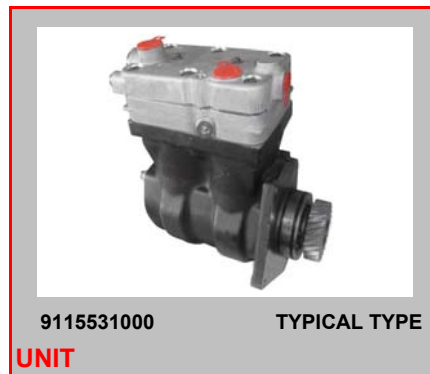

COMPRESSORS USING A67RK073
REBUILD

9115530020
9115531000
9115531010
9115531020
9115531030
9115531040
9115531050



020023	A69RK028	STD
020024	A69RK054	+0.50
020025	A69RK055	+1.00

2 x 2, 1 x 4mm
PISTONS & RINGS

CHECK OUR WEB SITE FOR SUITABILITY OF THESE AND OTHER PARTS, OR CONTACT US.
ALL PARTS OFFERED ARE MAJORSELL BRAND AND MAY NOT BE OF AN ORIGINAL SUPPLY.
ORIGINAL PART NUMBERS ARE USED FOR REFERENCE ONLY. **CHECK ALL APPLICATIONS.**



Fax ++44 121 455 0272 sales@majorsell.co.uk www.majorsell.co.uk



W037.1

W
A
B
C
O

140143 x 6



HEAD BOLTS



220058



9115530020
9115531000
9115531010

220101



9115531030

220162



220093



**FRONT
050209**



220150 **SOME TYPES**

IN DEVELOPMENT

220227 **SOME TYPES**



140016 **SOME TYPES**



A67RK001



A67RK001A



IN DEVELOPMENT

TYPICAL TYPE

UNIT



A67RK001B



A67RK024C

COMPRESSORS USING A67RK001

4110345010	4110435010
4110345310	4110435020
4110345410	4110435220
4110345460	4110435260
4110345470	4110435710
4110345610	4110435720
	4110438000
4110425000	4110438010
4110425010	4110438050
4110425010	4110438070
4110425020	4110438200
4110425120	4110438210
4110425200	4110438440
4110425220	4110438450
4110426000	
4110426010	
4110428000	
4110428050	
4110428070	
4110428080	
4110428200	
4110428450	



A67RK001V



A67RK001V

CHECK OUR WEB SITE FOR SUITABILITY OF THESE AND OTHER PARTS, OR CONTACT US.
 ALL PARTS OFFERED ARE MAJORSELL BRAND AND MAY NOT BE OF AN ORIGINAL SUPPLY.
 ORIGINAL PART NUMBERS ARE USED FOR REFERENCE ONLY. **CHECK ALL APPLICATIONS.**



Fax ++44 121 455 0272 sales@majorsell.co.uk www.majorsell.co.uk



W038.1

W
A
B
C
O

IN DEVELOPMENT

220119

SOME TYPES

IN DEVELOPMENT

220120

SOME TYPES



140131

MOST TYPES



050158

SOME TYPES

IN DEVELOPMENT

6206

ROLLER
SOME TYPES



140015

SOME TYPES



220081

SOME TYPES

IN DEVELOPMENT

220082

SOME TYPES



220080

SOME TYPES



220079

SOME TYPES



050159

SOME TYPES



020068

020118

020147

020068	STD	<u>32mm</u>
020069	+0.50mm	CROWN
020070	+1.00mm	HEIGHT
020118	STD	<u>35mm</u>
020119	+0.50mm	CROWN
		HEIGHT

CHECK CROWN HEIGHT

020147	STD	<u>37mm</u>
020148	+0.50mm	CROWN
020149	+1.00mm	HEIGHT



CHECK CROWN HEIGHT

Majorsell parts for :-

AXOR 1840

Principal users :-
Mercedes

**MAJORSELL
REBUILD**

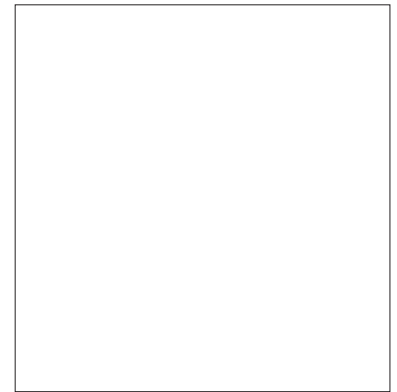

• 85 mm bore.



A67RK62D



A67RK062C

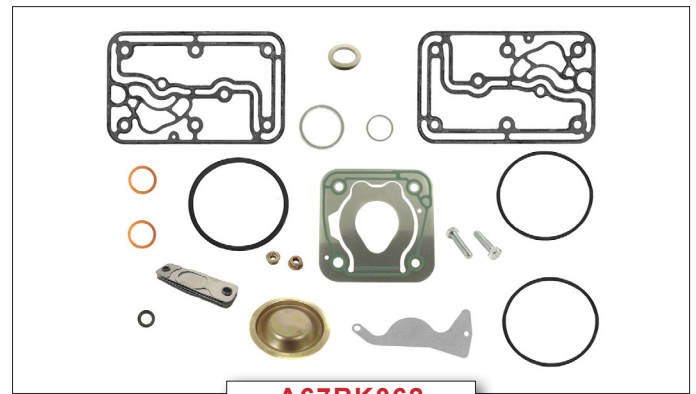

A67RK062



A67RK062CP

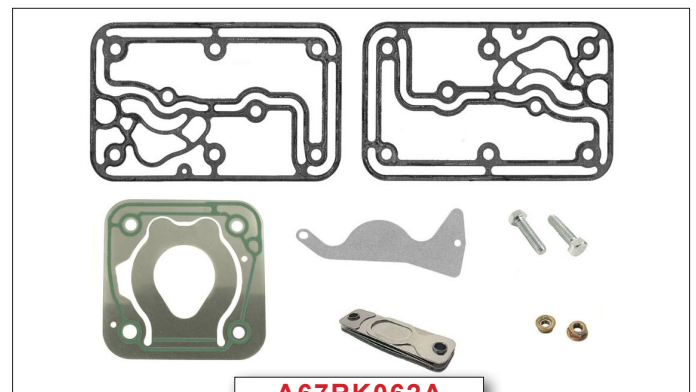

A67RK062A

020023	Std	A67RK028
020024	+0.50 mm	A67RK054
020025	+1.00 mm	A67RK055

	85 mm	
	2 x 2 mm	
	1 x 4 mm	

Piston & Rings	Ring set
---------------------------	-----------------

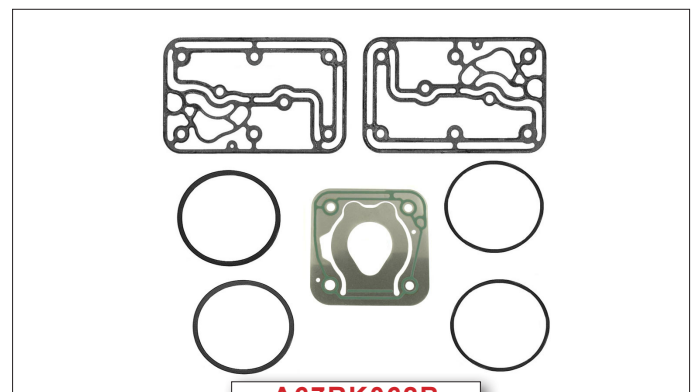

A67RK062B

Check our web site for suitability of these and other parts, or contact us directly.
Original part numbers are used for reference only. Check all applications.
All parts offered are Majorsell brand and may not be of an original supply.
Majorsell kit content and ring sets may be different to the original.



AXOR 1840

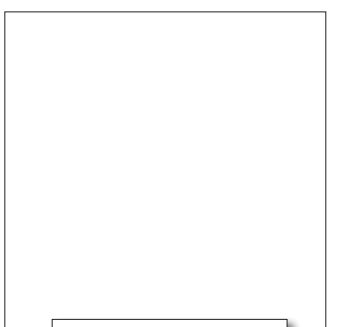
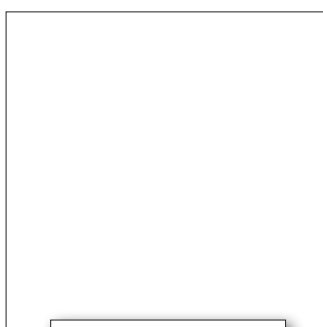
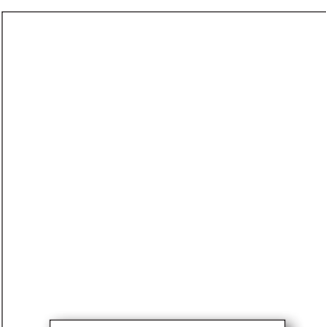
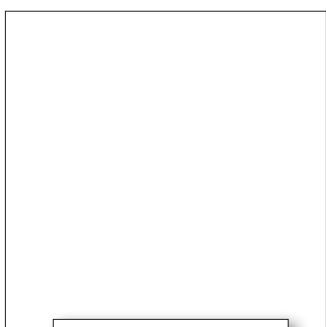
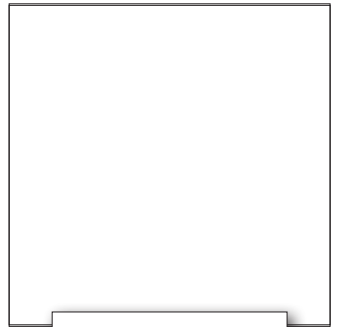
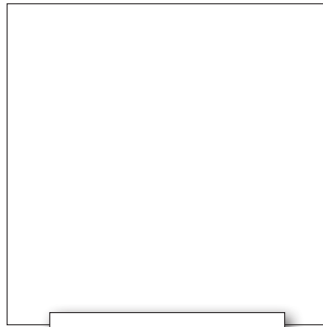
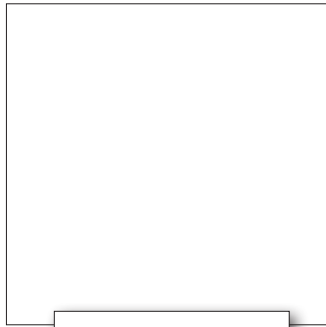
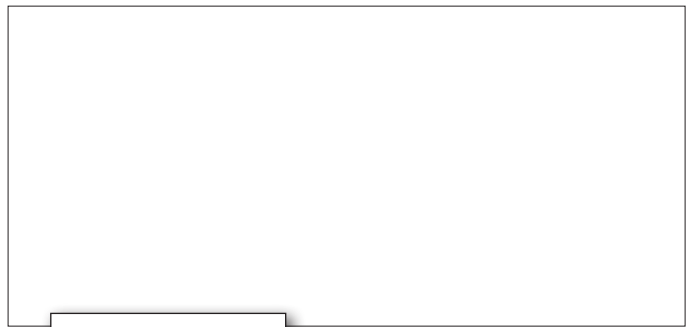
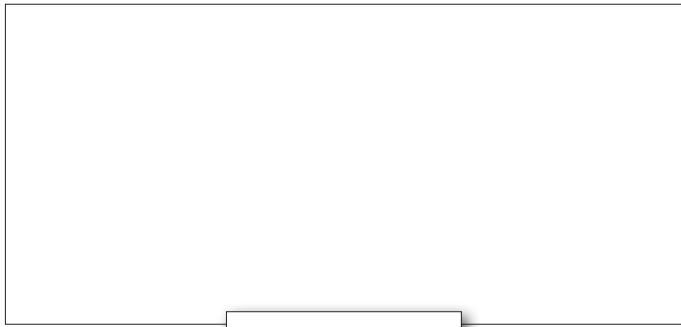
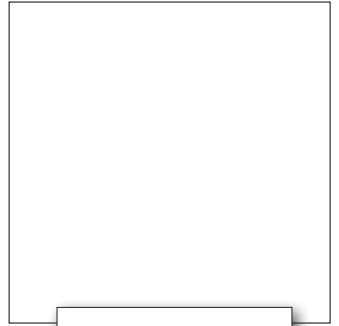
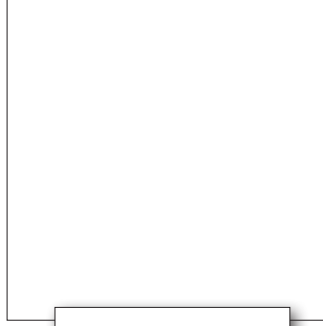
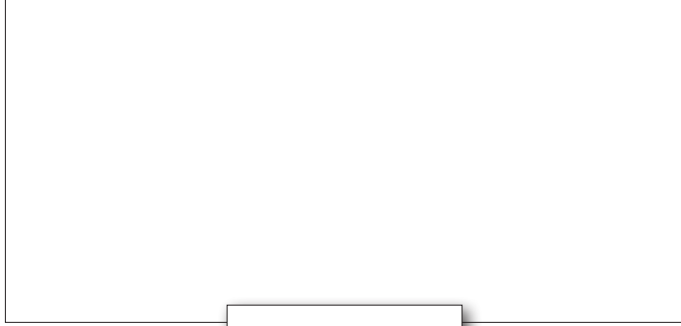

Majorsell parts for :-

AXOR ACTROS

Principal users :-
Mercedes

**MAJORSELL
REBUILD**

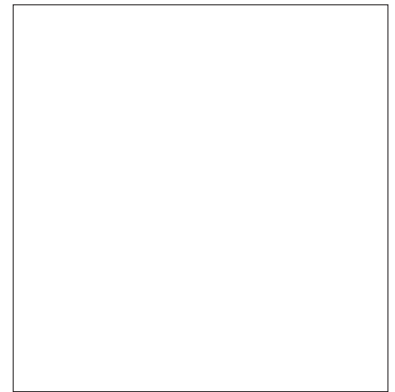

• 85 mm bore.



A67RK073D



A67RK065C

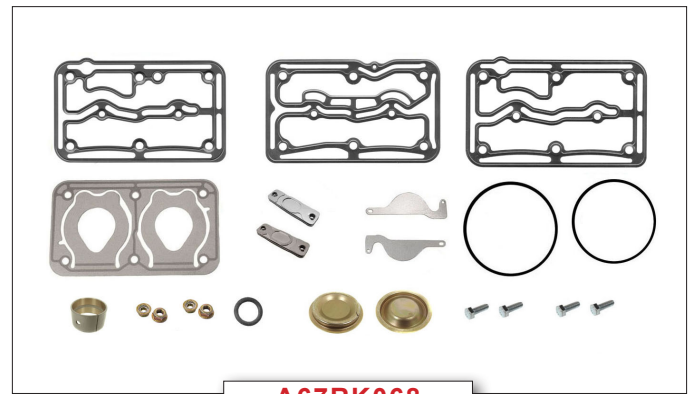

A67RK068



A67RK068CP



A67RK068A

020023	Std	A67RK028
020024	+0.50 mm	A67RK054
020025	+1.00 mm	A67RK055

	85 mm	
	2 x 2 mm	
	1 x 4 mm	

Piston & Rings

Ring set

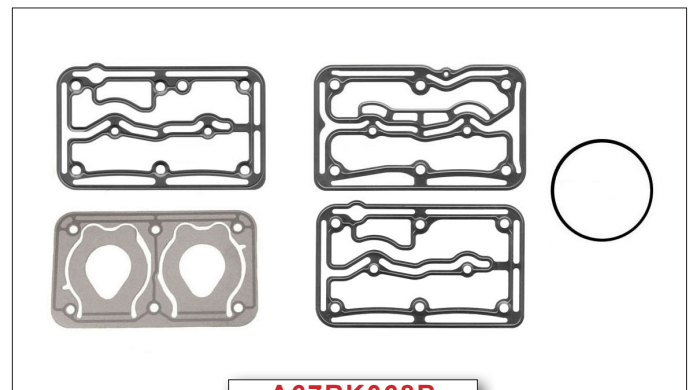

A67RK068B

Check our web site for suitability of these and other parts, or contact us directly.
Original part numbers are used for reference only. Check all applications.
All parts offered are Majorsell brand and may not be of an original supply.
Majorsell kit content and ring sets may be different to the original.



AXOR ACTROS



220229



Front

050186



140016



220224



140143

4 used



140139

2 used



Head

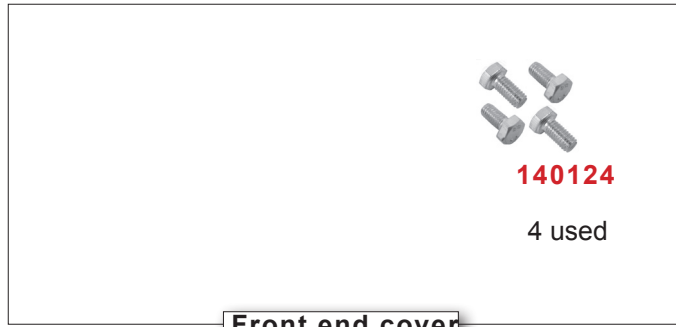
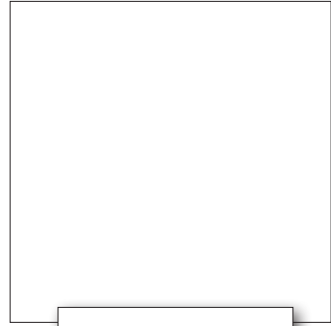
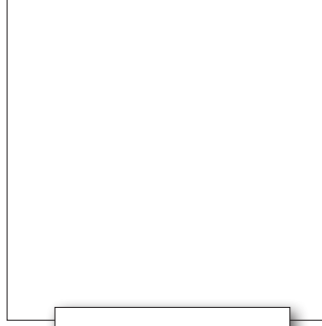

140124

4 used

Front end cover



220227



220058

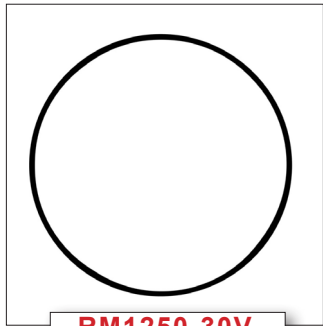
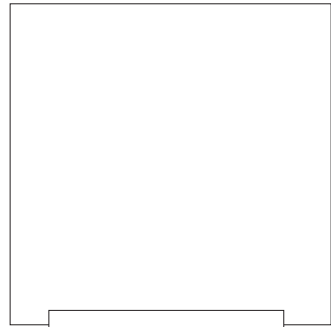
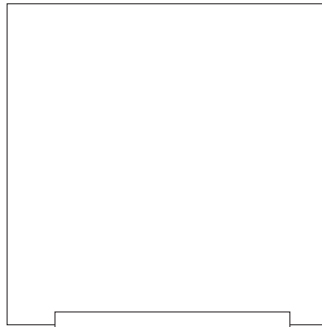
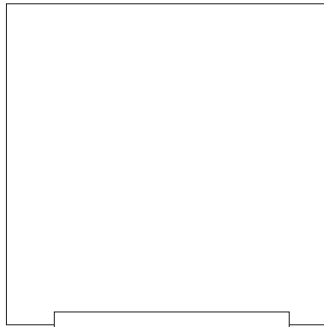

RM1250-30V

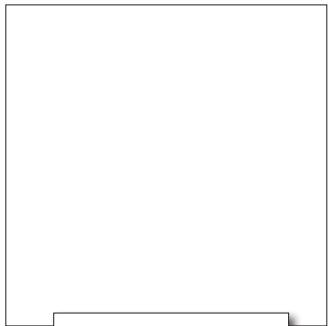
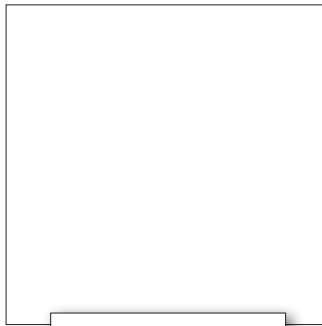
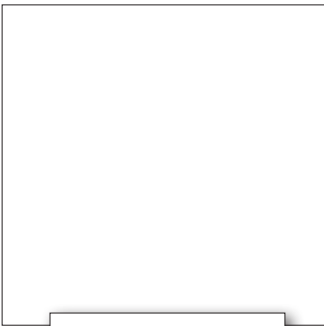

Majorsell parts for :-

AXOR ATEGO

Principal users :-
Mercedes

**MAJORSELL
REBUILD**

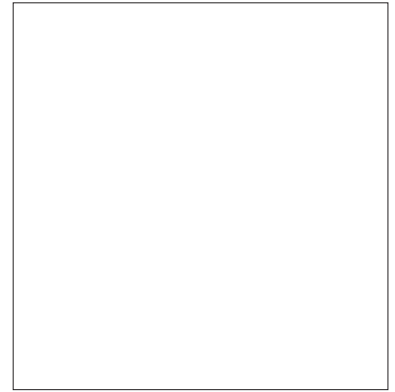

• 85 mm bore.



A67RK057C



A67RK057

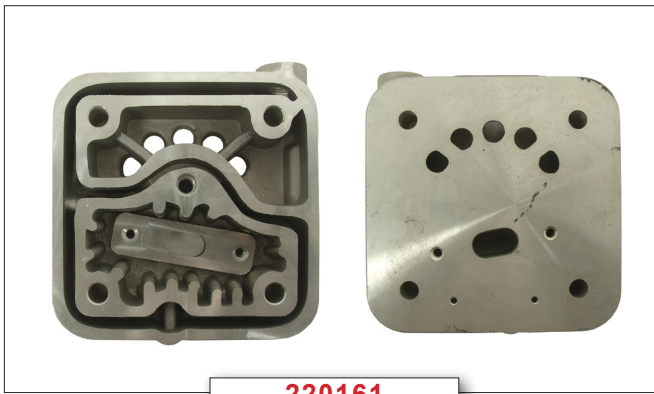

220161



A67RK057A

020023	Std	A67RK028
020024	+0.50 mm	A67RK054
020025	+1.00 mm	A67RK055

85 mm
2 x 2 mm
1 x 4 mm

Piston & Rings

Ring set

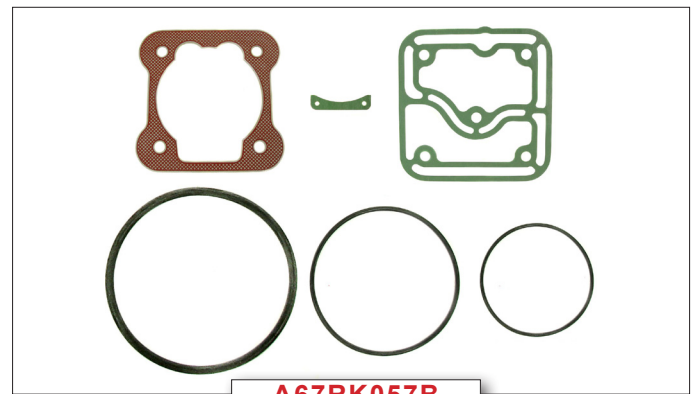

A67RK057B

Check our web site for suitability of these and other parts, or contact us directly.
Original part numbers are used for reference only. Check all applications.
All parts offered are Majorsell brand and may not be of an original supply.
Majorsell kit content and ring sets may be different to the original.



AXOR ATEGO

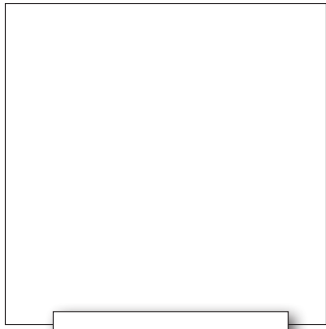

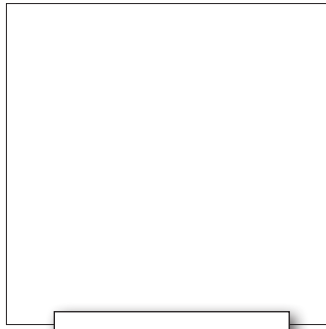



140016

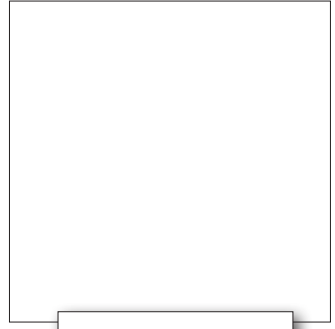



140144
4 used



140131
4 used

220145

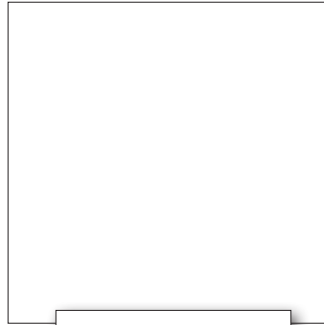

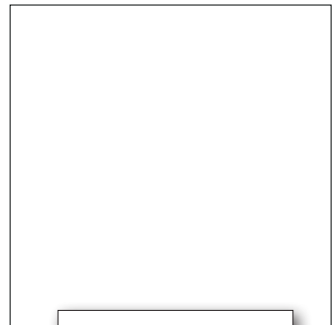

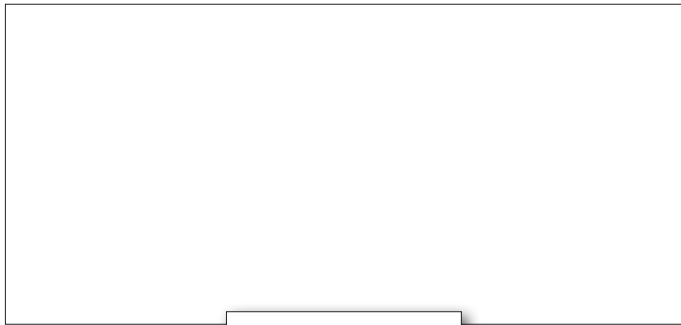

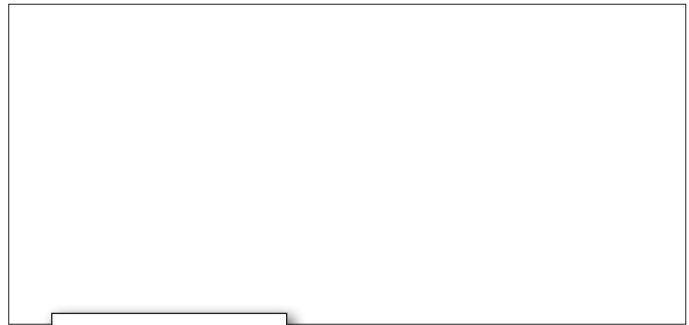

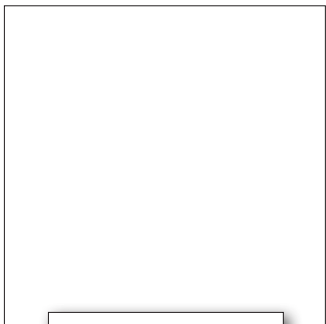

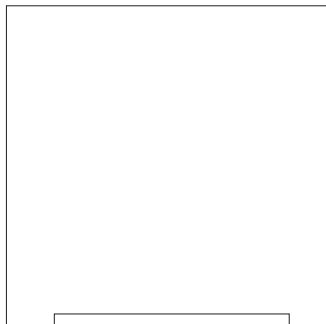

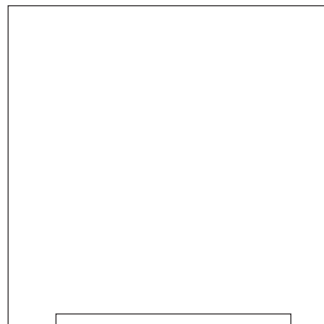

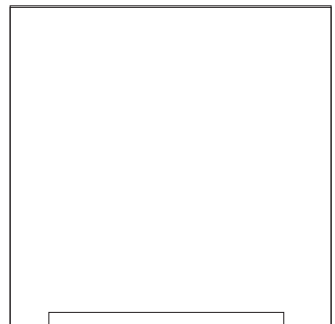

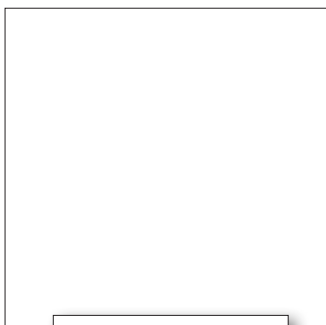

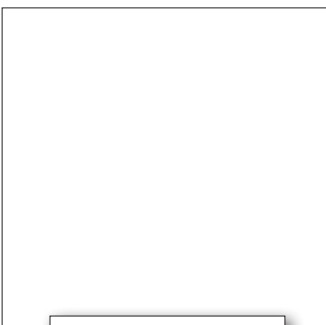

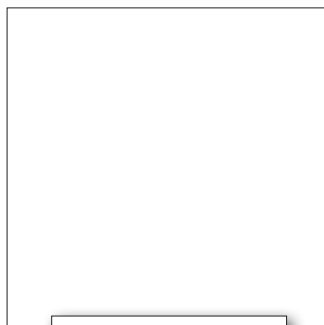

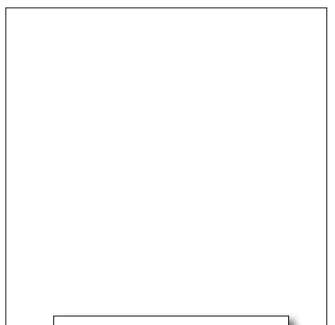

Majorsell parts for :-

AXOR OM457

Principal users :-
Mercedes

**MAJORSELL
REBUILD**

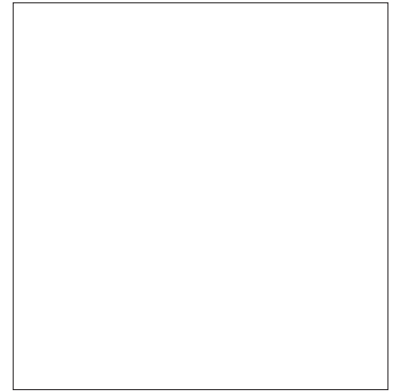

• 85 mm bore.



A67RK069C



A67RK069

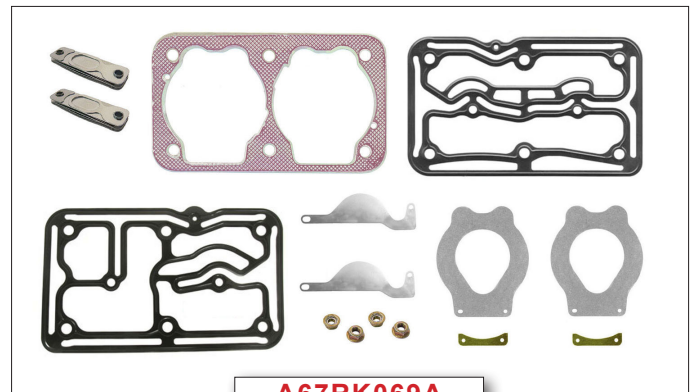
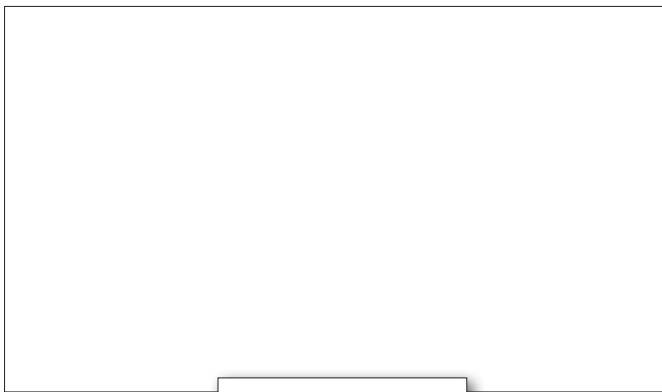

A67RK069A

020023	Std	A67RK028
020024	+0.50 mm	A67RK054
020025	+1.00 mm	A67RK055

85 mm
2 x 2 mm
1 x 4 mm

Piston & Rings

Ring set

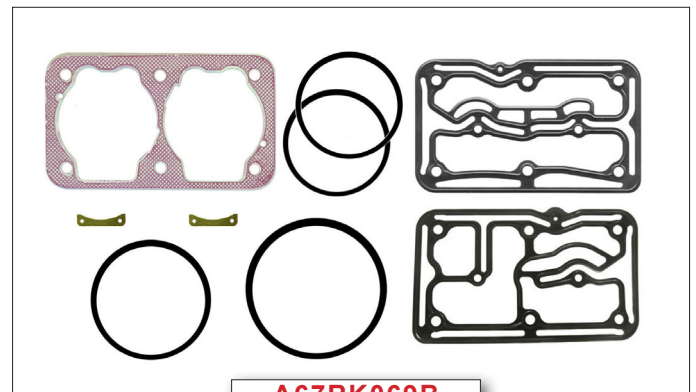

A67RK069B

Check our web site for suitability of these and other parts, or contact us directly.
Original part numbers are used for reference only. Check all applications.
All parts offered are Majorsell brand and may not be of an original supply.
Majorsell kit content and ring sets may be different to the original.



AXOR OM457

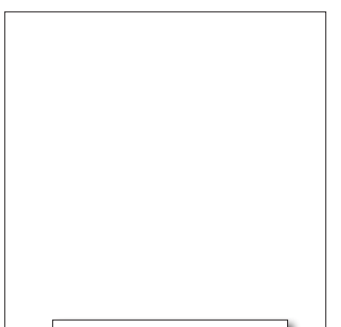
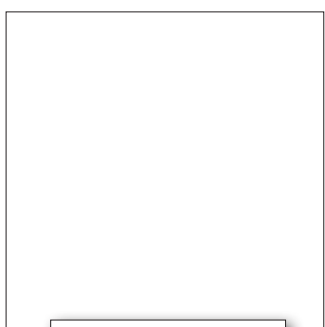
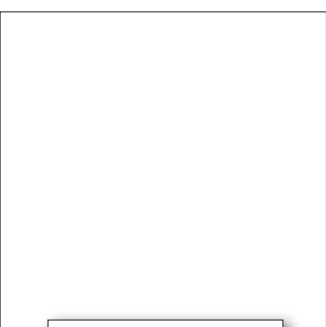
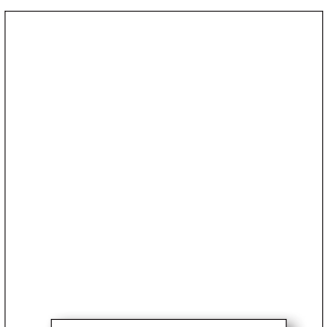
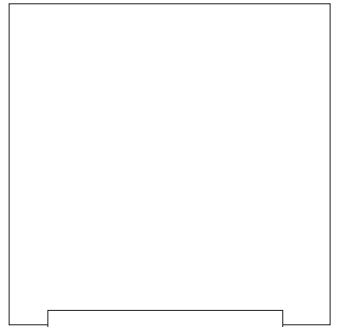
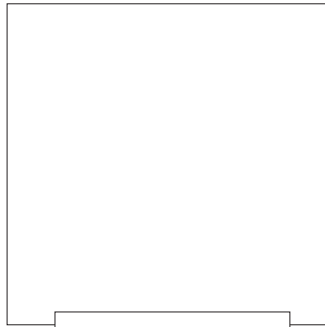
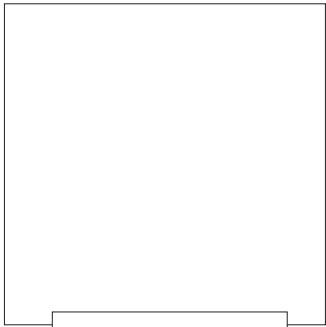
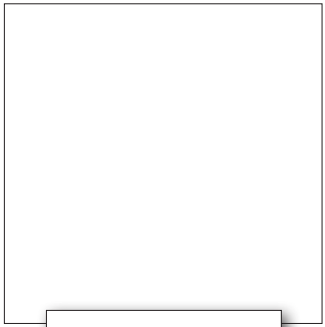
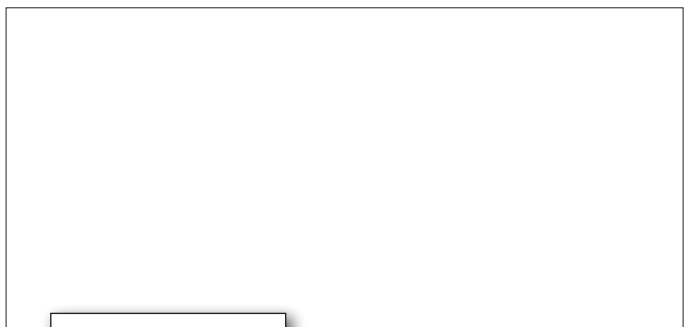
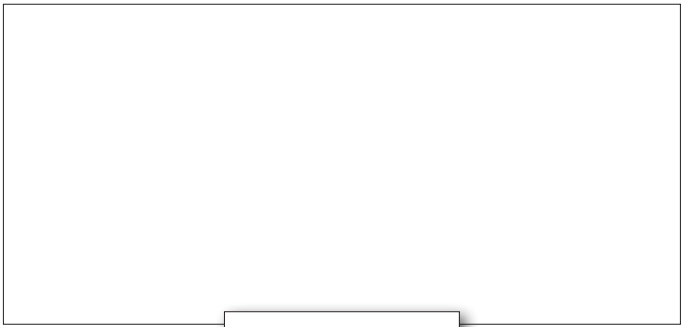
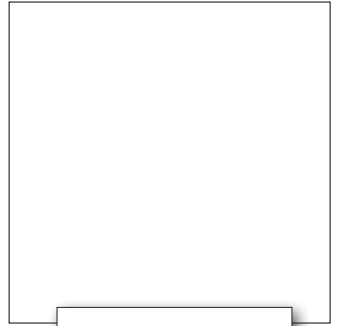
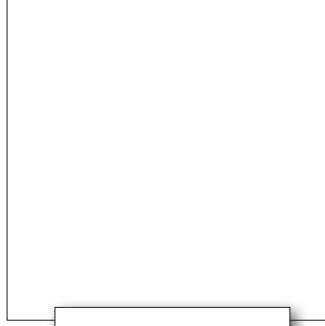
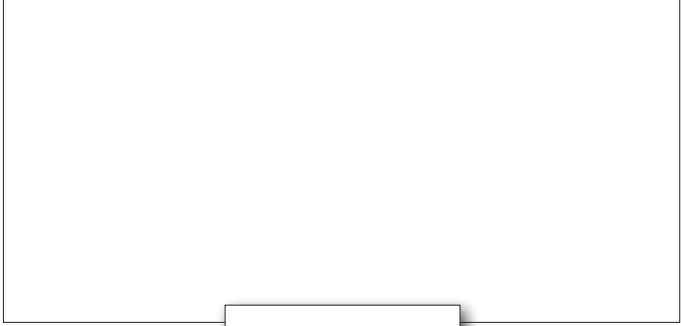
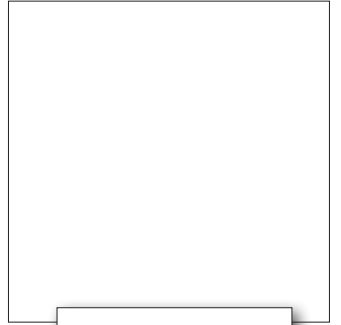
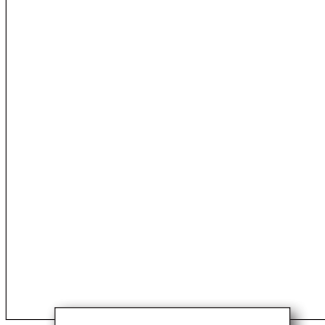
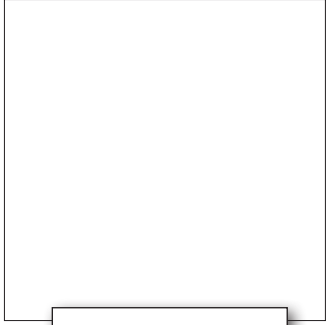
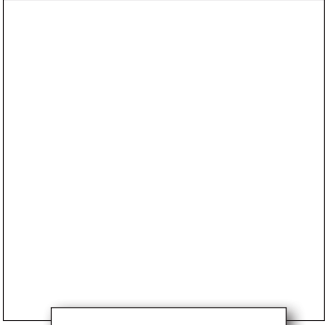

Majorsell parts for :-

OM401 OM401A

Principal users :-
Mercedes

**MAJORSELL
REBUILD**

Water cooled

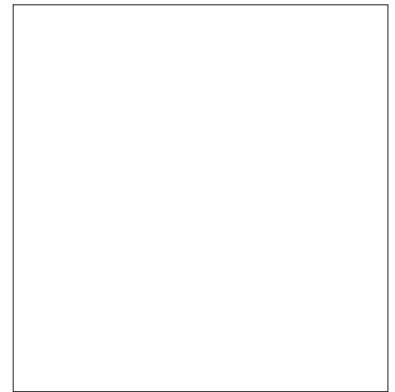

- 90 mm bore.
- Water cooled.

- Side mount.
- Engine oil lubrication.

Check crown height.



A67RK024C



A67RK026



A67RK026V

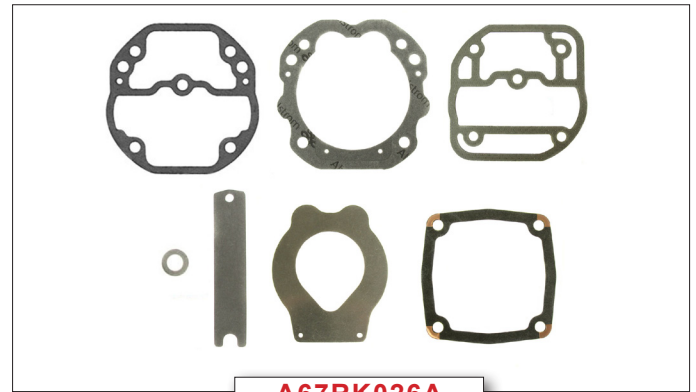

A67RK026A

32 mm crown height	020068	Std	A67RK007
	020069	+0.50 mm	A67RK009
	020070	+1.00 mm	A67RK011
37 mm crown height	020118	Std	A67RK007
	020119	+0.50 mm	A67RK009

	90 mm	
	2 x 2.5 mm	
	1 x 4 mm	

Piston & Rings

Ring set

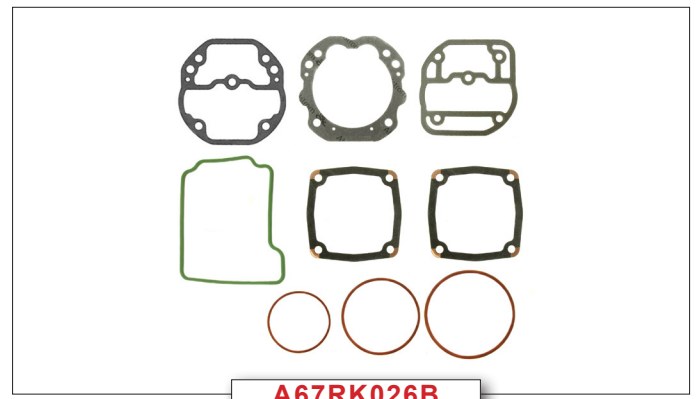

A67RK026B

Check our web site for suitability of these and other parts, or contact us directly.
Original part numbers are used for reference only. Check all applications.
All parts offered are Majorsell brand and may not be of an original supply.
Majorsell kit content and ring sets may be different to the original.



OM401 OM401A



220011



050194

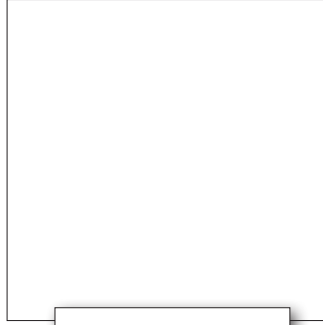

220016



220022

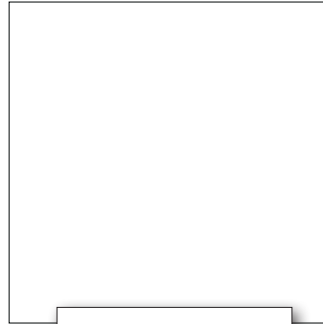
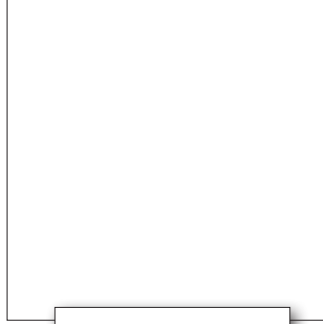

220030

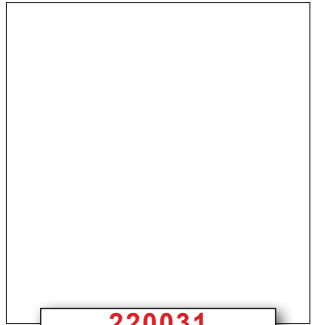

220031

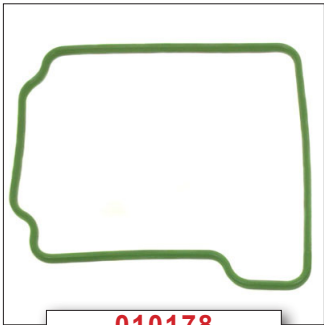
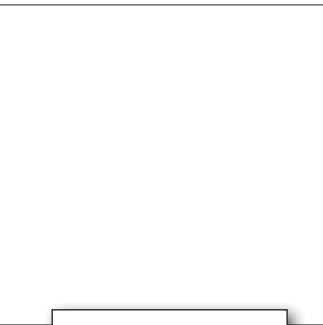
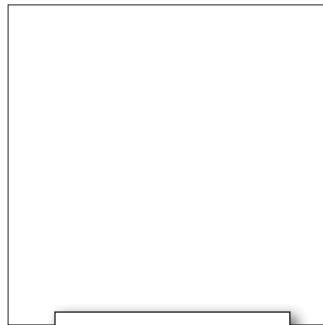

010178

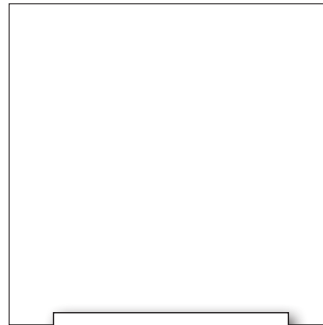
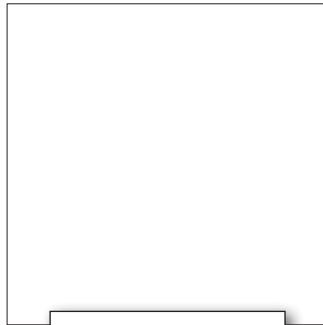
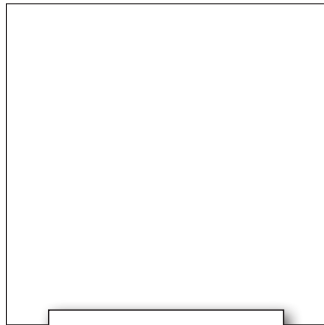

020043



020043L

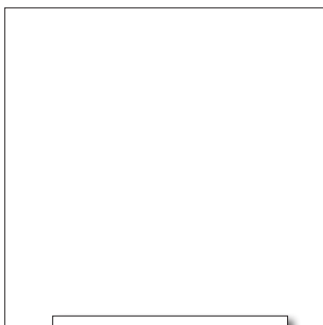
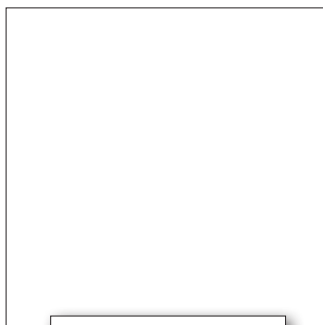

Majorsell parts for :-

OM402 OM403

Principal users :-
Mercedes

**MAJORSELL
REBUILD**

Water cooled

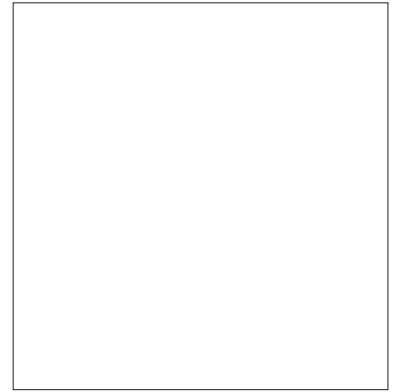

- 90 mm bore.
- Water cooled.
- Side mount.
- Engine oil lubrication.



A67RK040C



A67RK004C



A67RK026



New design

A67RK040V

A67RK004V

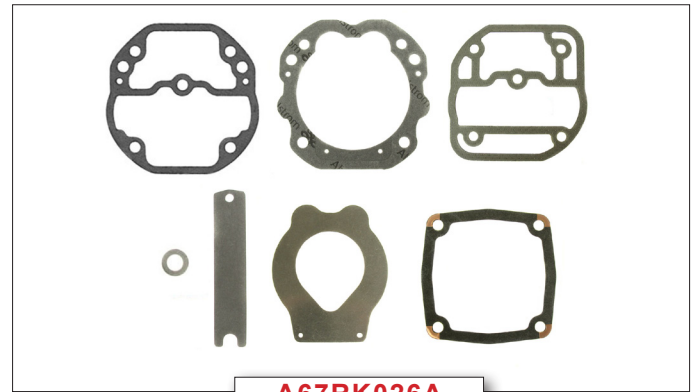

A67RK026A

32 mm crown height 020068 020069 020070	Std	A67RK007
	+0.50 mm	A67RK009
	+1.00 mm	A67RK011
37 mm crown height 020118 020119	Std	A67RK007
	+0.50 mm	A67RK009

	90 mm 2 x 2.5 mm 1 x 4 mm	
--	---------------------------------	--

Piston & Rings

Ring set

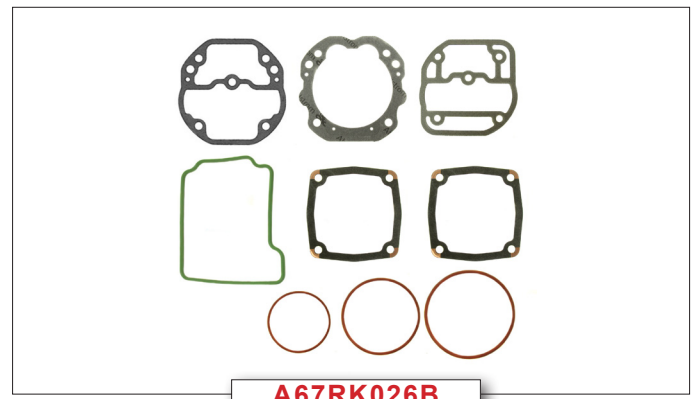

A67RK026B

Check our web site for suitability of these and other parts, or contact us directly. Original part numbers are used for reference only. Check all applications. All parts offered are Majorsell brand and may not be of an original supply. Majorsell kit content and ring sets may be different to the original.



OM402 OM403



220011



050194

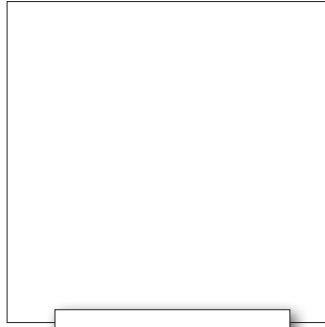

220016

050164

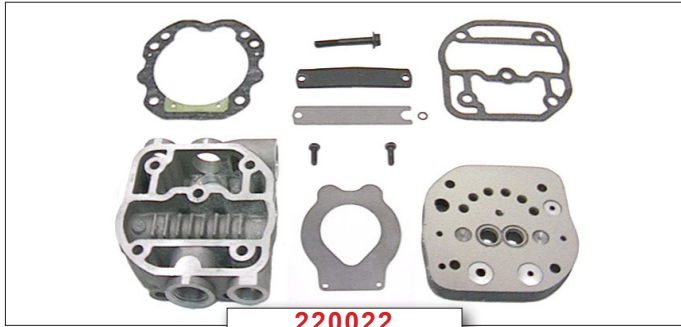

220022

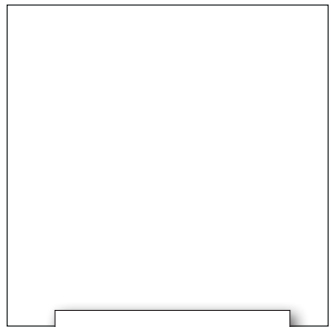
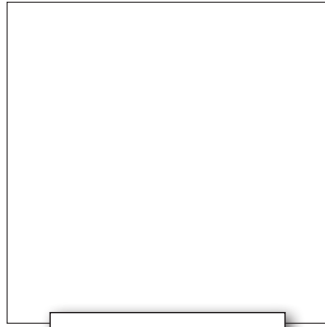

220030



220031

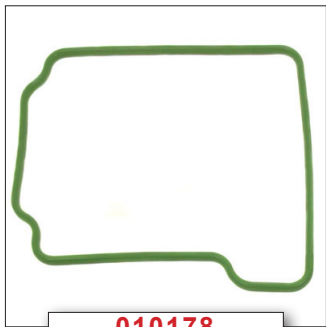
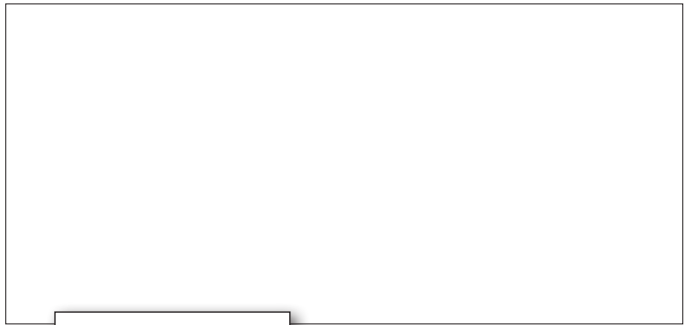

010178

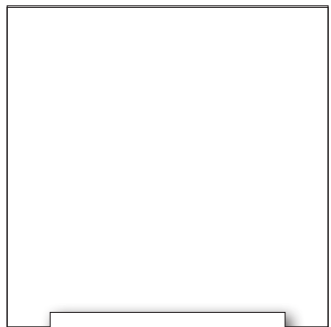
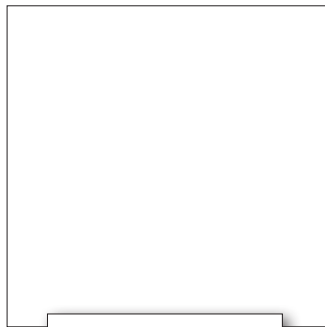
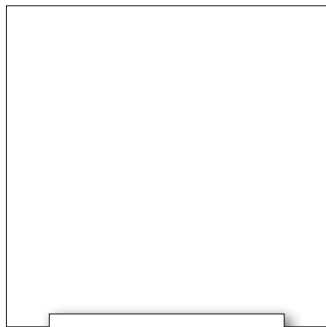

020043



020043L

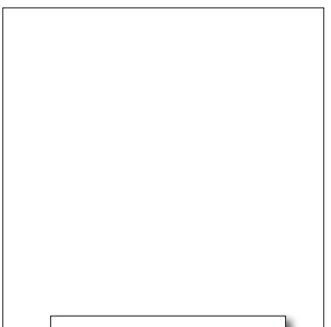
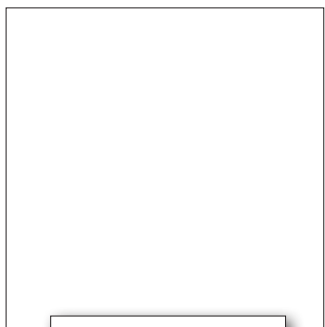

Majorsell parts for :-

OM421 OM422 OM423

Principal users :-
MERCEDES

**MAJORSSELL
REBUILD**

Water cooled

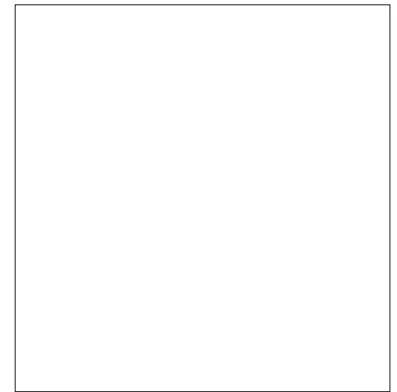

- 90 mm bore.
- Water cooled.
- Side mount.
- Engine oil lubrication.

Check crown height.

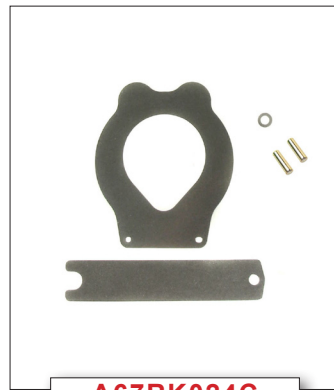

A67RK024C



A67RK026

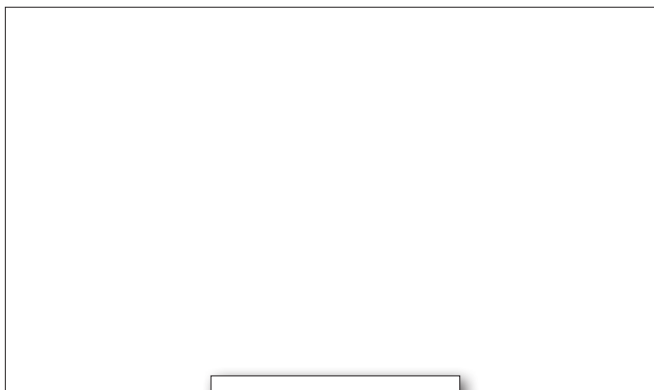

A67RK026A

32 mm crown height	020068	Std	A67RK007
	020069	+0.50 mm	A67RK009
	020070	+1.00 mm	A67RK011
37 mm crown height	020118	Std	A67RK007
	020119	+0.50 mm	A67RK009

	90 mm	
	2 x 2.5 mm	
	1 x 4 mm	

Piston & Rings

Ring set

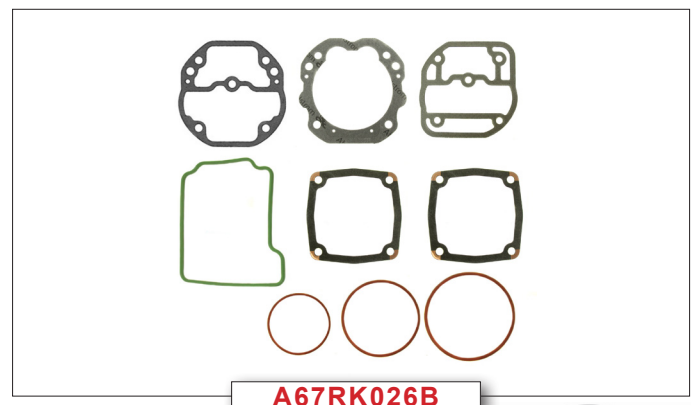

A67RK026B

Check our web site for suitability of these and other parts, or contact us directly.
Original part numbers are used for reference only. Check all applications.
All parts offered are Majorsell brand and may not be of an original supply.
Majorsell kit content and ring sets may be different to the original.



OM421 OM422 OM423



220011



050194

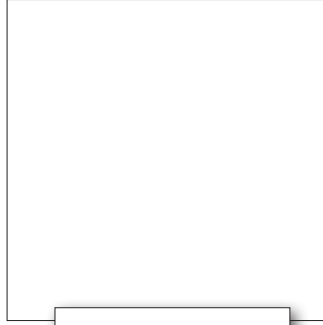

220016

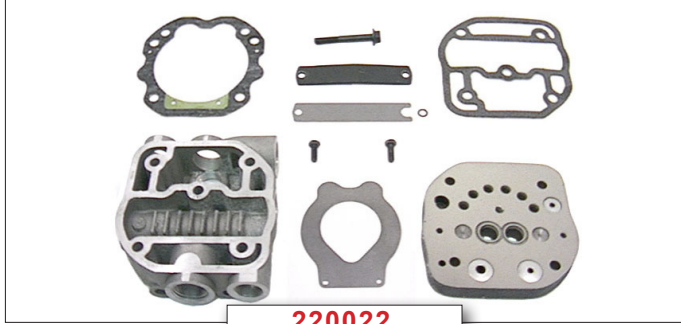

220022

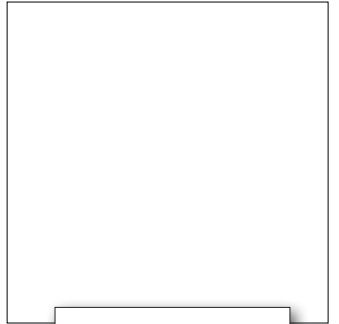
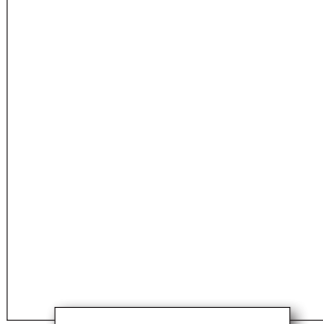

220030

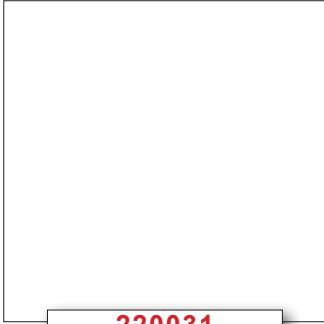

220031

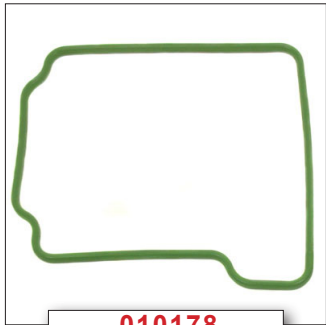
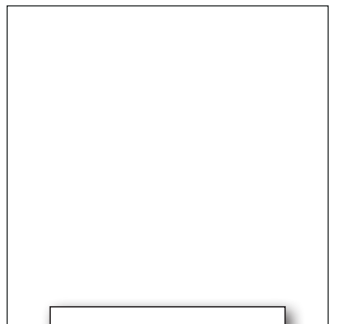
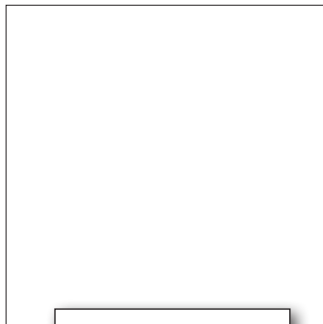

010178

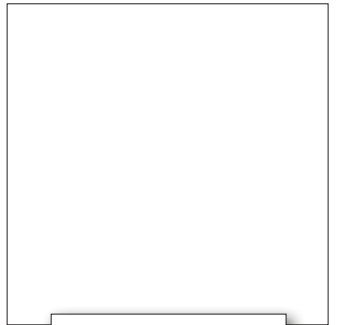
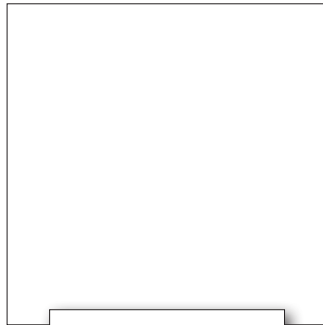
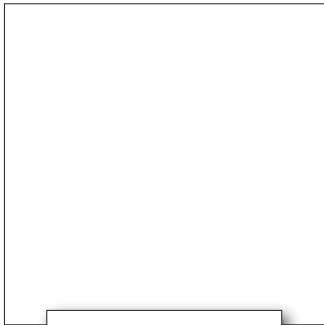

020043



020043L

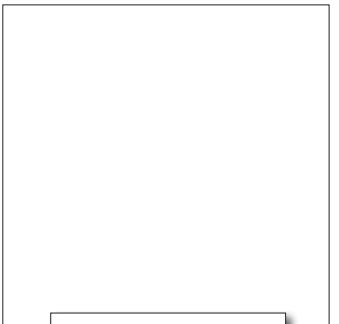
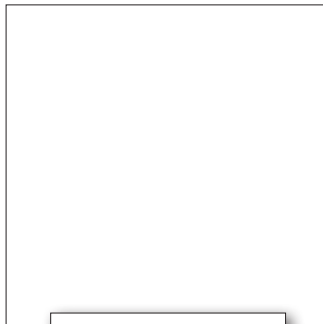

Majorsell parts for :-

OM402 OM422 OM423

Principal users :-
Mercedes new style A.C. head

**MAJORSELL
REBUILD**

Air cooled

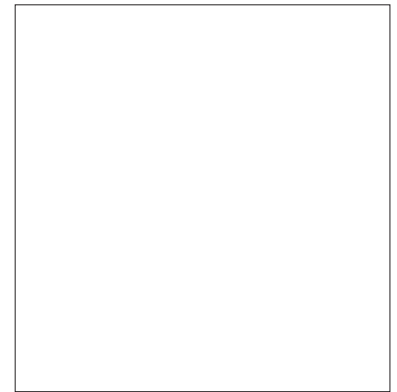

- 90 mm bore.
- Air cooled.
- Side mount.
- Engine oil lubrication.

Check crown height.



A67RK040C



A67RK040



A67RK040V



A67RK040A

32 mm crown height	020068	Std	A67RK007
	020069	+0.50 mm	A67RK009
	020070	+1.00 mm	A67RK011
37 mm crown height	020118	Std	A67RK007
	020119	+0.50 mm	A67RK009

	90 mm	
	2 x 2.5 mm	
	1 x 4 mm	

Piston & Rings

Ring set



A67RK040B

Check our web site for suitability of these and other parts, or contact us directly.
Original part numbers are used for reference only. Check all applications.
All parts offered are Majorsell brand and may not be of an original supply.
Majorsell kit content and ring sets may be different to the original.



OM402 OM422 OM423



220012



050194

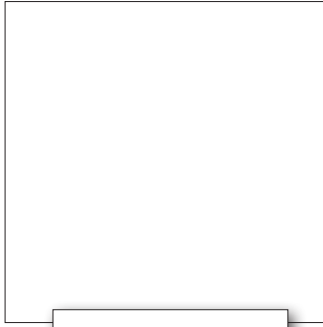

220016



220033



010219

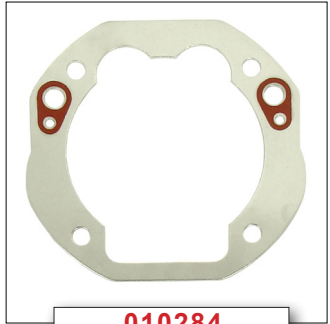

010284



220030

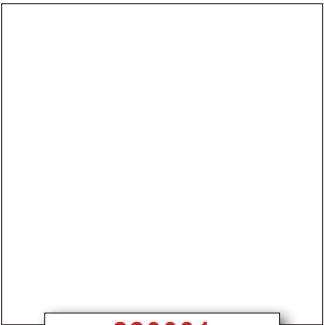

220031

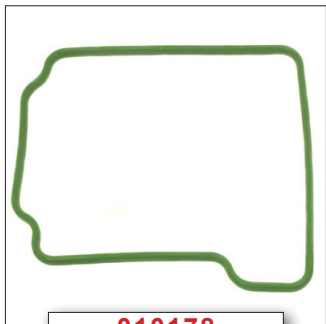
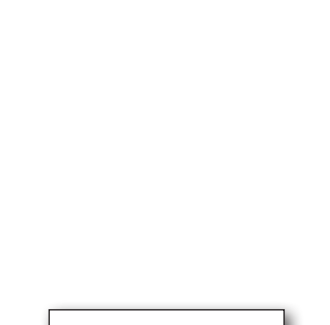

010178

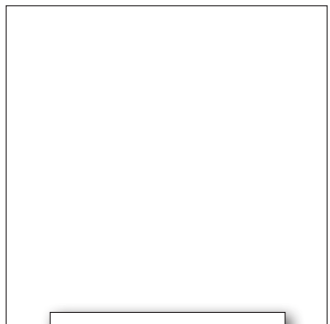
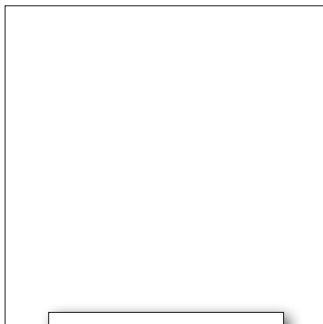
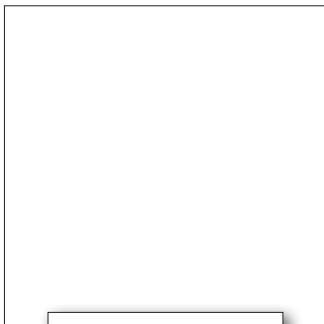

020083



020083L

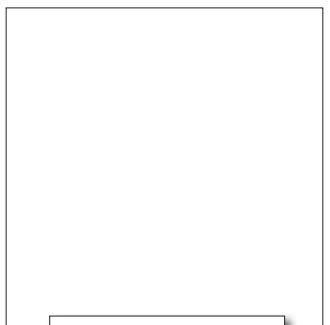
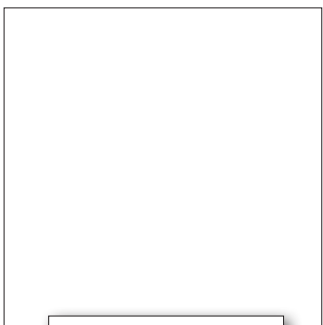

Majorsell parts for :-

OM402 OM422 OM423

Principal users :-
Mercedes old style A.C. head

**MAJORSELL
REBUILD**

Air cooled

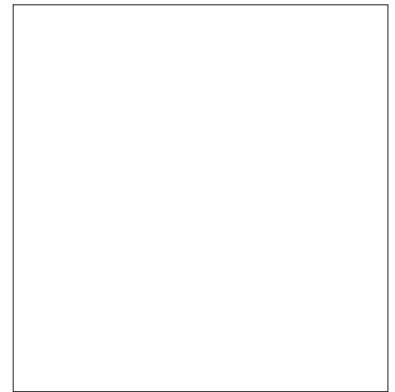

- 90 mm bore.
- Air cooled.
- Side mount.
- Engine oil lubrication.

Check crown height.

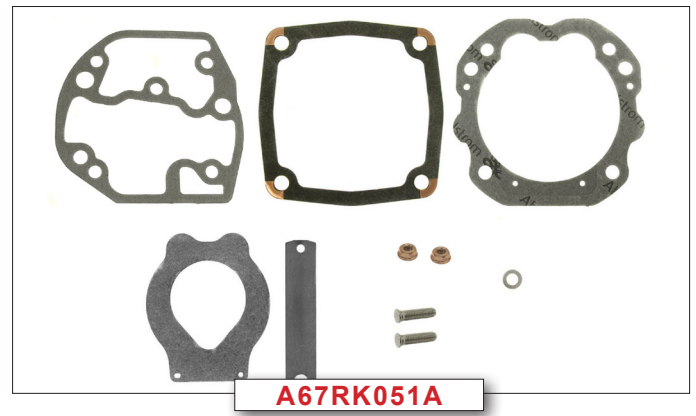
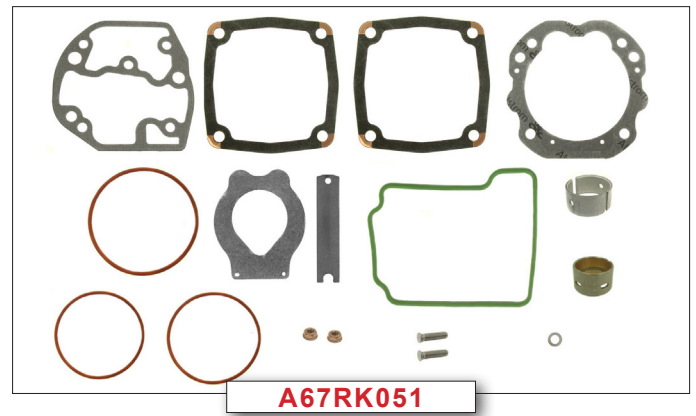
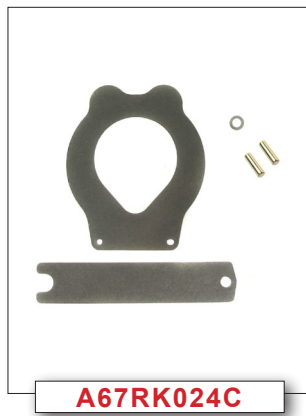

32 mm crown height	020068	Std	A67RK007
	020069	+0.50 mm	A67RK009
	020070	+1.00 mm	A67RK011
37 mm crown height	020118	Std	A67RK007
	020119	+0.50 mm	A67RK009

90 mm
2 x 2.5 mm
1 x 4 mm

Piston & Rings **Ring set**

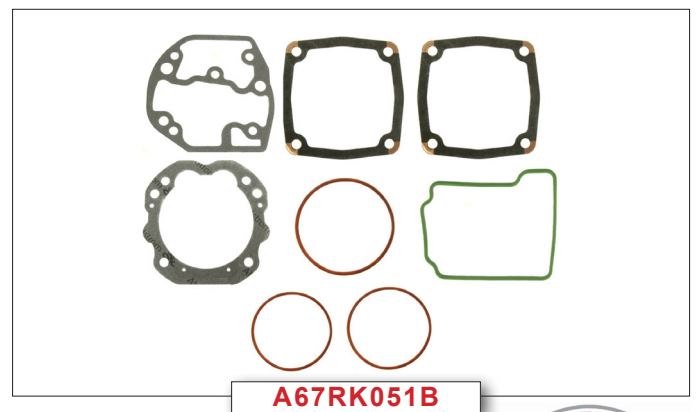

Check our web site for suitability of these and other parts, or contact us directly.
Original part numbers are used for reference only. Check all applications.
All parts offered are Majorsell brand and may not be of an original supply.
Majorsell kit content and ring sets may be different to the original.



OM402 OM422 OM423



220010



050194

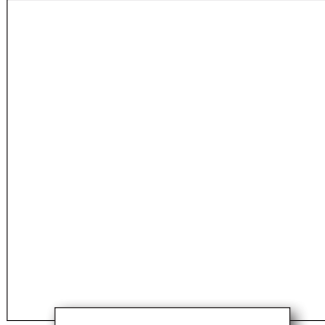

220016

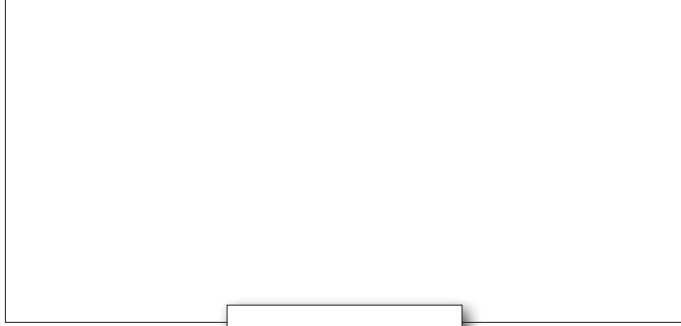

010219

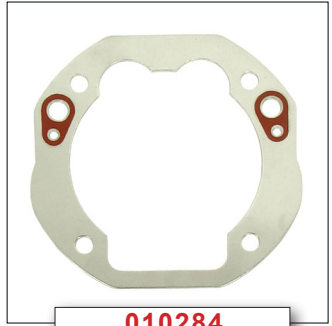

010284



220030



220031

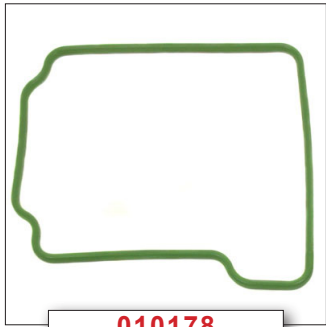
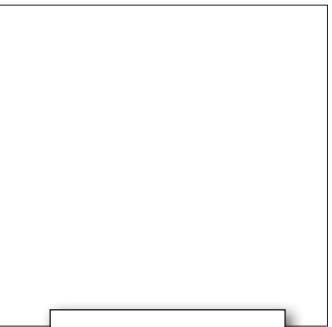
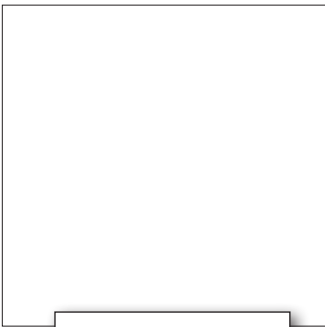

010178

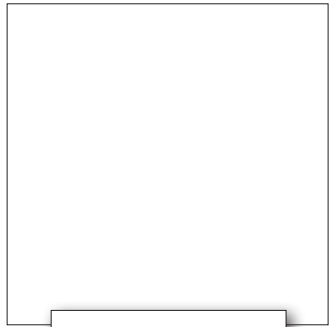
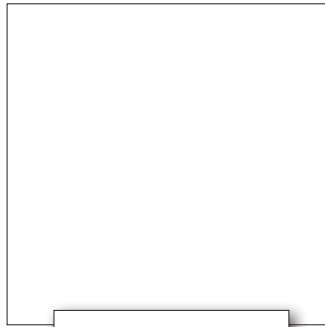
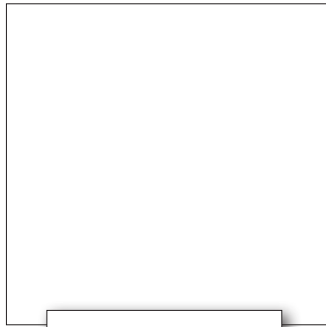

020083



020083L

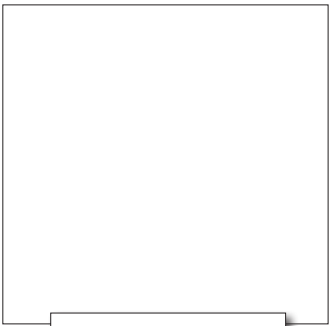
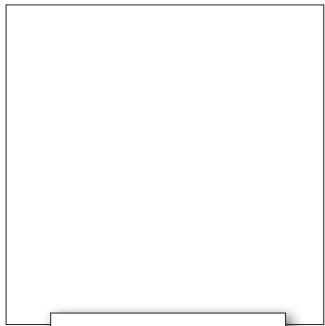

TYPICAL PARTS FOR CUMMINS - HOLSET

CUM001

CUMMINS



SUITABLE FOR SS296

A74RK001A



SUITABLE FOR SS296

A74RK002A



QE296 TYPICAL TYPE

74A002R



SUITABLE FOR SS296

A74RK010



A74RK012

SS296	A74RK001A
SS296	A74RK002A
SS296	A74RK010
ST676	A74RK012
QE296	A74RK017A
QE296	A74RK017B
SS378	A74RK017A
SS378	A74RK017B



A74RK017A



050050 STD
050051 +010"
050052 +020"

FRONT

APPROX O.D. 2.12"



050053 STD
050054 +010"
050055 +020"
050056 +030"

REAR

APPROX O.D. 2.00"



050146

CHECK OUR WEB SITE OR DVD FOR SUITABILITY OF THESE AND OTHER PARTS, OR CONTACT US.

ALL PARTS OFFERED ARE MAJORSELL BRAND AND MAY NOT BE OF AN ORIGINAL SUPPLY.

ORIGINAL PART NUMBERS ARE USED FOR REFERENCE ONLY. **CHECK ALL APPLICATIONS.**



Fax ++44 121 455 0272 sales@majorsell.co.uk www.majorsell.co.uk



CUM001.1

C
U
M
M
I
N
S



ALUMINIUM

3 5/8"

RINGS		
020048	STD	A74RK003
020049	+0.010"	A74RK004
020050	+0.020"	A74RK005
020051	+0.030"	A74RK006
020052	+0.040"	A74RK007

2 x 1/8", 1 x 3/16" FOR 1 PISTON



220024



ALUMINIUM

3 7/8"

RINGS		
020090	STD	A74RK013
020092	+0.020"	A74RK015

2 x 1/8", 1 x 3/16" FOR 1 PISTON

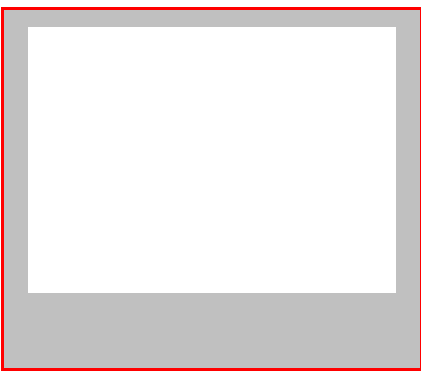

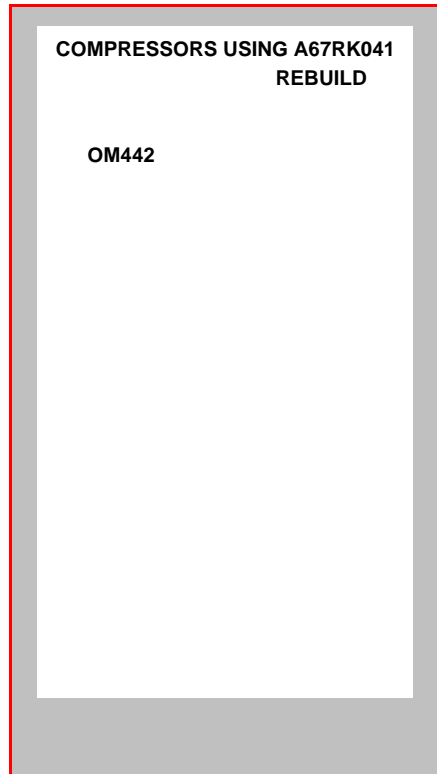
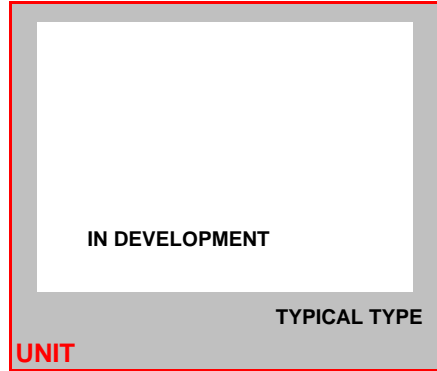

CHECK OUR WEB SITE OR DVD FOR SUITABILITY OF THESE AND OTHER PARTS, OR CONTACT US.

ALL PARTS OFFERED ARE MAJORSELL BRAND AND MAY NOT BE OF AN ORIGINAL SUPPLY.

ORIGINAL PART NUMBERS ARE USED FOR REFERENCE ONLY. **CHECK ALL APPLICATIONS.**



Fax ++44 121 455 0272 sales@majorsell.co.uk www.majorsell.co.uk



MB003.1

M
E
R
C
E
D
E
S



100mm

020143 020144 020145

A67RK043 STD
A67RK044 +0.50mm
A67RK045 +1.00mm

2 x 2.5, 1x 4mm

RING KIT FOR 020068 ETC

A67RK075 STD
A67RK076 +0.50mm
A67RK077 +1.00mm

2 x 2.5, 1x 3mm

**ALTERNATIVE RINGS
NO PISTON AVAILABLE**



220012



050193



IN DEVELOPMENT

220177



220030



TYPICAL PARTS FOR MIDLAND COMPRESSORS

MID001

M
I
D
L
A
N
D



A73RK001



A73RK001A



EL1300

TYPICAL TYPE



A73RK001B



A73RK001S

COMPRESSORS USING A73RK001

EL1300
EL1600

COMPRESSORS USING A73RK015

EL740 OVER PAGE



A73RK001C



5/8" ALTERNATIVE

210054



CUMMINS APPLICATIONS

050137



220037

CHECK OUR WEB SITE OR DVD FOR SUITABILITY OF THESE AND OTHER PARTS, OR CONTACT US.

ALL PARTS OFFERED ARE MAJORSELL BRAND AND MAY NOT BE OF AN ORIGINAL SUPPLY.

ORIGINAL PART NUMBERS ARE USED FOR REFERENCE ONLY. **CHECK ALL APPLICATIONS.**



Fax ++44 121 455 0272 sales@majorsell.co.uk www.majorsell.co.uk



MID001.1

M
I
D
L
A
N
D



ALUMINIUM

2 3/4" BORE

RINGS		
020018	STD	A73RK002
020019	+0.010"	A73RK003
020020	+0.020"	A73RK004
020021	+0.030"	A73RK005
020022	+0.040"	A73RK006

8x3/32", 2x3/16" FOR 2 PISTONS

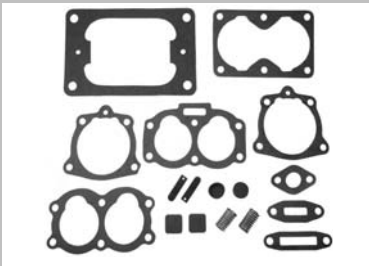

A73RK015



A73RK014

COMPRESSORS USING A73RK015

EL740



EL740



50.4mm BORE

RINGS		
020078	STD	A73RK016
020079	+0.010"	A73RK017
020080	+0.020"	A73RK018
020081	+0.030"	A73RK019
020082	+0.040"	A73RK020

4x2.37, 2x4.73mm FOR 2 PISTONS



050027	STD.
050028	+010"
050029	+020"

INSERTS

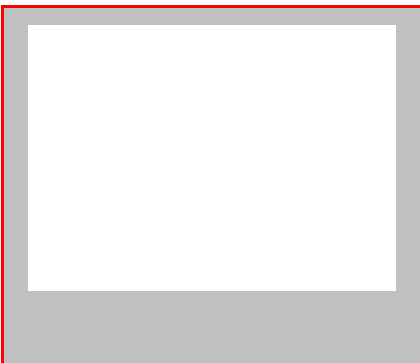



100mm SERVICES VG3213
23F035 KIT F66RK006A



100mm SERVICES VG3208
23F036 KIT F66RK002A

IN DEVELOPMENT

80mm SERVICES VG3204
23F037 KIT F66RK001



80mm SERVICES VG3200
23F038 KIT F66RK001



102mm SERVICES VG3361
23F063 KIT F66RK003



75mm SERVICES VG3265
23F068 KIT F66RK001



100mm SERVICES VG3268
23F069 KIT F66RK002A



75mm SERVICES VG3267
23F072 KIT F66RK007A

IN DEVELOPMENT

100mm SERVICES VG3221
23F078 KIT F66RK008A



106mm SERVICES VG3289
23F079 KIT F66RK008A



100mm SERVICES VG3269
23F093 KIT F66RK008A



75mm SERVICES VG3262
23F123 KIT F66RK011A

CHECK OUR WEB SITE FOR SUITABILITY OF THESE AND OTHER PARTS, OR CONTACT US.

ALL PARTS OFFERED ARE MAJORSELL BRAND AND MAY NOT BE OF AN ORIGINAL SUPPLY.

ORIGINAL PART NUMBERS ARE USED FOR REFERENCE ONLY. **CHECK ALL APPLICATIONS.**



Fax ++44 121 455 0272 sales@majorsell.co.uk www.majorsell.co.uk



KCS001.1

S
E
R
V
O
S



95mm SERVICES VG3261
23F179 KIT F66RK010A

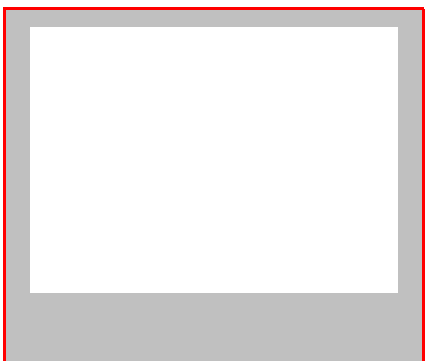
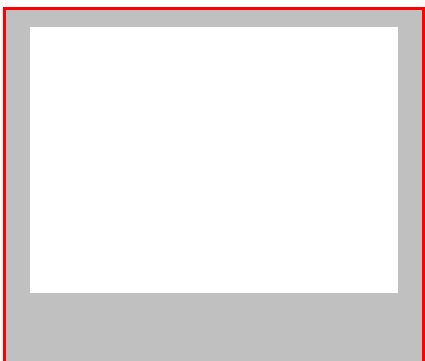
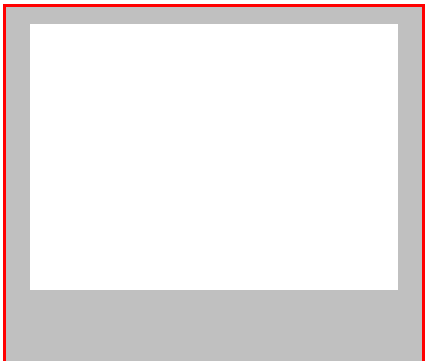
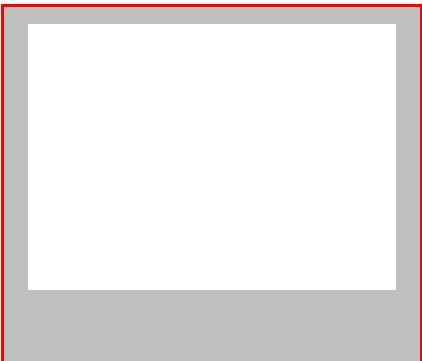
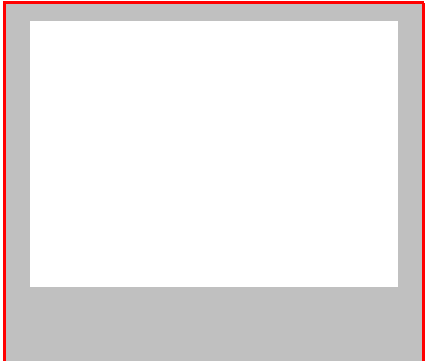
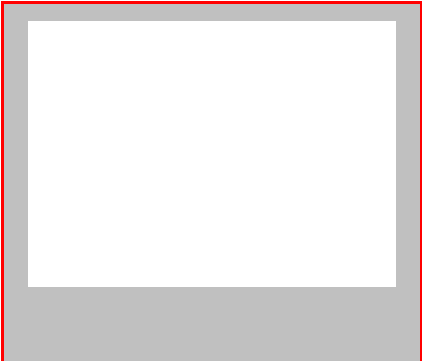



CHECK OUR WEB SITE FOR SUITABILITY OF THESE AND OTHER PARTS, OR CONTACT US.
 ALL PARTS OFFERED ARE MAJORSELL BRAND AND MAY NOT BE OF AN ORIGINAL SUPPLY.
 ORIGINAL PART NUMBERS ARE USED FOR REFERENCE ONLY. **CHECK ALL APPLICATIONS.**



Fax ++44 121 455 0272 sales@majorsell.co.uk www.majorsell.co.uk



KCSK001.1

S
E
R
V
O
S



KGCS001

S
E
R
V
O
S



80mm SERVICES 626392
23F008 KIT F77RK004A



95mm SERVICES 626639
23F009 KIT F77RK031 or 32



100mm SERVICES 622190
23F010 KIT F77RK007



100mm SERVICES 622107
23F011 KIT F77RK005



100mm SERVICES 622199
23F019 KIT F77RK007



100mm SERVICES 625359
23F020 KIT F77RK016



100mm SERVICES 624199
23F021 KIT F77RK007



80mm SERVICES 628277
23F022 KIT F77RK008



100mm SERVICES 628275
23F023 KIT F77RK018



80mm SERVICES 622504
23F024 KIT F77RK011



80mm SERVICES 625290
23F025 KIT F77RK012



80mm SERVICES 627499
23F026 KIT F77RK019

CHECK OUR WEB SITE FOR SUITABILITY OF THESE AND OTHER PARTS, OR CONTACT US.

ALL PARTS OFFERED ARE MAJORSELL BRAND AND MAY NOT BE OF AN ORIGINAL SUPPLY.

ORIGINAL PART NUMBERS ARE USED FOR REFERENCE ONLY. **CHECK ALL APPLICATIONS.**



Fax ++44 121 455 0272 sales@majorsell.co.uk www.majorsell.co.uk



KGCS001.1

S
E
R
V
O
S



80mm SERVICES 627498
23F027 KIT F77RK019



80mm SERVICES 627497
23F028 KIT F77RK019



100mm SERVICES 626162
23F029 KIT F77RK020



100mm SERVICES 625524
23F030 KIT F77RK021



80mm SERVICES 625384
23F031 KIT F77RK019



80mm SERVICES 626853
23F032 KIT F77RK022



100mm SERVICES 628027
23F033 KIT F77RK028



100mm SERVICES 628260
23F042 KIT F77RK018



100mm SERVICES 628448
23F043 KIT F77RK018



100mm SERVICES 628258
23F044 KIT F77RK018



80mm SERVICES 628259
23F045 KIT F77RK008



100mm SERVICES 628449
23F046 KIT F77RK018



100mm SERVICES 628450
23F047 KIT F77RK025



100mm SERVICES 628447
23F048 KIT F77RK025



80mm SERVICES 628276
23F049 KIT F77RK008



80mm SERVICES 626693
23F050 KIT F77RK011

IN DEVELOPMENT

100mm SERVICES 627052
23F052 KIT F77RK027



100mm SERVICES 625671
23F053 KIT F77RK018



100mm SERVICES 625436
23F054 KIT F77RK028



100mm SERVICES 622110
23F055 KIT F77RK002

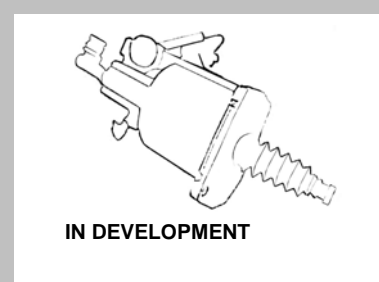

IN DEVELOPMENT

100mm SERVICES 625375
23F056 KIT F77RK029



100mm SERVICES 628494
23F057 KIT F77RK030



100mm SERVICES 628036
23F058 KIT F77RK025



100mm SERVICES 628492
23F059 KIT F77RK030



100mm SERVICES 628493
23F060 KIT F77RK030



80mm SERVICES 626397
23F066 KIT F77RK024

IN DEVELOPMENT

100mm SERVICES 622109
23F075 KIT F77RK002

CHECK OUR WEB SITE FOR SUITABILITY OF THESE AND OTHER PARTS, OR CONTACT US.
ALL PARTS OFFERED ARE MAJORSELL BRAND AND MAY NOT BE OF AN ORIGINAL SUPPLY.
ORIGINAL PART NUMBERS ARE USED FOR REFERENCE ONLY. **CHECK ALL APPLICATIONS.**



Fax ++44 121 455 0272 sales@majorsell.co.uk www.majorsell.co.uk



KGCS002.1

S
E
R
V
O
S



95mm SERVICES 622045
23F080 KIT F77RK010



100mm SERVICES 627612
23F081 KIT F77RK036



KGCSK001

S
E
R
V
O
S

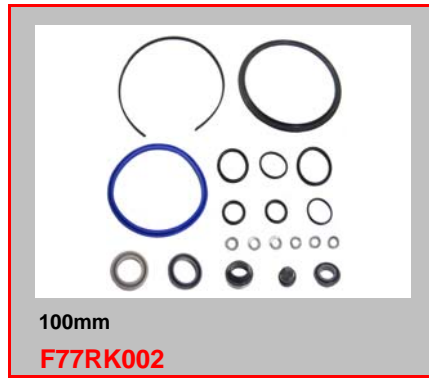

CHECK OUR WEB SITE FOR SUITABILITY OF THESE AND OTHER PARTS, OR CONTACT US.

ALL PARTS OFFERED ARE MAJORSELL BRAND AND MAY NOT BE OF AN ORIGINAL SUPPLY.

ORIGINAL PART NUMBERS ARE USED FOR REFERENCE ONLY. **CHECK ALL APPLICATIONS.**



Fax ++44 121 455 0272 sales@majorsell.co.uk www.majorsell.co.uk



KGCSK001.1

S
E
R
V
O
S





108mm SERVICES 9700511240
23F001 KIT F67RK005



80mm SERVICES 9700511020
23F002 KIT F67RK006A



80mm SERVICES 9700511290
23F003 KIT F67RK013A



108mm SERVICES 9700511320
23F004 KIT F67RK014A



108mm SERVICES 9700511070
23F005 KIT F67RK005



80mm SERVICES 9700511110
23F006 KIT F67RK004



90mm SERVICES 9700511310
23F007 KIT F67RK002A



80mm SERVICES 9700511370
23F012 KIT F67RK013A



108mm SERVICES 9700511280
23F013 KIT F67RK005



75mm SERVICES APGA1605P
23F015 KIT F69RK002A



108mm SERVICES 9700512090
23F016 KIT F67RK016A



108mm SERVICES 9700511640
23F017 KIT X

CHECK OUR WEB SITE FOR SUITABILITY OF THESE AND OTHER PARTS, OR CONTACT US.

ALL PARTS OFFERED ARE MAJORSELL BRAND AND MAY NOT BE OF AN ORIGINAL SUPPLY.

ORIGINAL PART NUMBERS ARE USED FOR REFERENCE ONLY. **CHECK ALL APPLICATIONS.**



Fax ++44 121 455 0272 sales@majorsell.co.uk www.majorsell.co.uk



WCS001.1

S
E
R
V
O
S



90mm SERVICES 9700511510
23F034 KIT F67RK011A



108mm SERVICES 9700511270
23F039 KIT F67RK005



80mm SERVICES 9700511140
23F040 KIT F67RK006A



80mm SERVICES 9700511260
23F041 KIT F67RK006A



108mm SERVICES 9700514070
23F061 KIT F67RK016



108mm SERVICES 9700514050
23F062 KIT F67RK017



80.5mm SERVICES 9700511560
23F065 KIT x



108mm SERVICES 9700511710
23F067 KIT x

IN DEVELOPMENT

108mm SERVICES 9700511580
23F070 KIT F67RK010A

IN DEVELOPMENT

108mm SERVICES 9700511590
23F071 KIT F67RK010A

IN DEVELOPMENT

108mm SERVICES 9700511630
23F073 KIT F67RK014A



108mm SERVICES 9700512180
23F074 KIT F67RK018



108mm SERVICES 9700514220
23F094 KIT F67RK027



80mm SERVICES 9700514290
23F096 KIT F67RK023A



108mm SERVICES 9700514360
23F100 KIT F67RK028



80mm SERVICES 9700514060
23F117 KIT F67RK003A

IN DEVELOPMENT

108mm SERVICES 9700514140
23F118 KIT F67RK021A



108mm SERVICES 9700514240
23F119 KIT F67RK021A

SERVICES
KIT

SERVICES
KIT

SERVICES
KIT

SERVICES
KIT

SERVICES
KIT

SERVICES
KIT

SERVICES
KIT

SERVICES
KIT

SERVICES
KIT

CHECK OUR WEB SITE FOR SUITABILITY OF THESE AND OTHER PARTS, OR CONTACT US.
 ALL PARTS OFFERED ARE MAJORSELL BRAND AND MAY NOT BE OF AN ORIGINAL SUPPLY.
 ORIGINAL PART NUMBERS ARE USED FOR REFERENCE ONLY. **CHECK ALL APPLICATIONS.**



Fax ++44 121 455 0272 sales@majorsell.co.uk www.majorsell.co.uk





CHECK OUR WEB SITE FOR SUITABILITY OF THESE AND OTHER PARTS, OR CONTACT US.
ALL PARTS OFFERED ARE MAJORSELL BRAND AND MAY NOT BE OF AN ORIGINAL SUPPLY.
ORIGINAL PART NUMBERS ARE USED FOR REFERENCE ONLY. **CHECK ALL APPLICATIONS.**



Fax ++44 121 455 0272 sales@majorsell.co.uk www.majorsell.co.uk



WCSK001.1

S
E
R
V
O
S

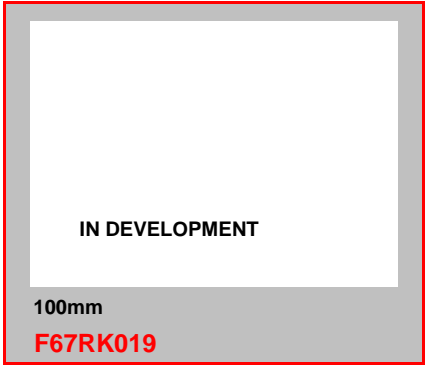



24mm SERVICES 623160
23K001 TO FIT MAN



26mm SERVICES 623109
23K002 TO FIT MAN



23.81mm SERVICES KG2303002
23K003 TO FIT MAN



26mm SERVICES 624502
23K004 TO FIT SCANIA



26mm SERVICES 624503
23K005 TO FIT SCANIA



25.4mm SERVICES KG259615
23K006 TO FIT SCANIA



25.4mm SERVICES KG259514
23K007 TO FIT SCANIA



PLASTIC PISTON AS 23K009
28.57mm SERVICES KG2801411
23K008 TO FIT



ALUMINIUM PISTON AS 23K008
28.57mm SERVICES KG2801411
23K009 TO FIT VOLVO



28.57mm SERVICES KG2801201
23K010 TO FIT VOLVO



26mm SERVICES 626760
23K011 TO FIT DAF



24mm SERVICES 626761
23K012 TO FIT DAF

CHECK OUR WEB SITE FOR SUITABILITY OF THESE AND OTHER PARTS, OR CONTACT US.
ALL PARTS OFFERED ARE MAJORSELL BRAND AND MAY NOT BE OF AN ORIGINAL SUPPLY.
ORIGINAL PART NUMBERS ARE USED FOR REFERENCE ONLY. **CHECK ALL APPLICATIONS.**



Fax ++44 121 455 0272 sales@majorsell.co.uk www.majorsell.co.uk



MC001.1

C
Y
L
I
N
D
E
R
S



22mm SERVICES 626762
23K013 TO FIT DAF



26.99mm SERVICES KG260411
23K014 TO FIT MERCEDES



20.64mm SERVICES KG200801
23K015 TO FIT MERCEDES



26mm SERVICES 623104
23K016 TO FIT R.V.I.



28mm SERVICES 623105
23K017 TO FIT R.V.I.



26mm SERVICES 623106
23K018 TO FIT R.V.I.



28mm SERVICES 624248
23K019 TO FIT R.V.I.



28mm SERVICES 626159
23K020 TO FIT R.V.I.

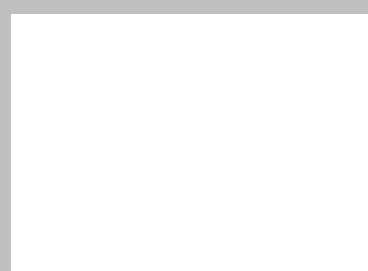

SERVICES
TO FIT

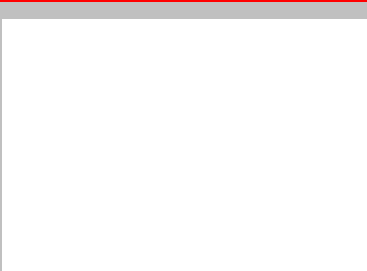

SERVICES
TO FIT

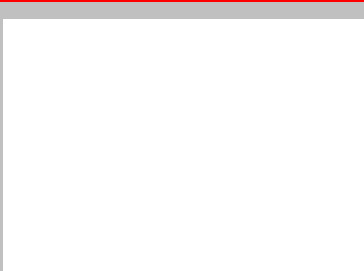

SERVICES
TO FIT

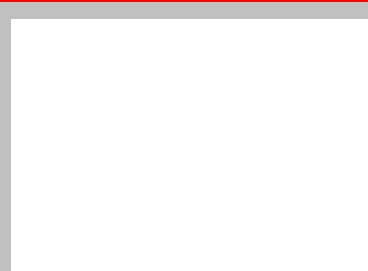

SERVICES
TO FIT

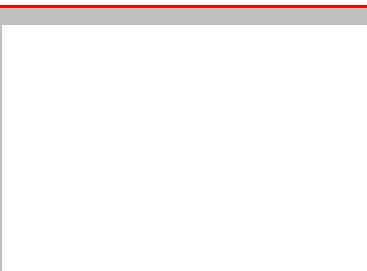

SERVICES
TO FIT

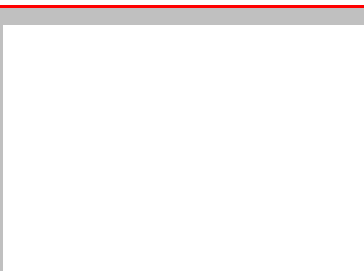

SERVICES
TO FIT

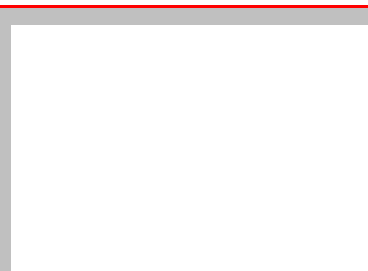

SERVICES
TO FIT

PROTECTION VALVES FOR BENDIX

BXV001

V
A
L
V
E
S



PORTS
1/8"
7.6 BAR

D2 GOVERNOR VALVE SERVICES 275508
23B001 KIT **B68RK003**



PORTS
1/8"

D2 GOVERNOR VALVE SERVICES 275491
23B002 KIT **B68RK003**



PORTS
M10
10 BAR

D2 GOVERNOR VALVE SERVICES 267051,267098
23B013 KIT **B68RK003**

PORTS

SERVICES
KIT



SERVICES SK2612-1
B68RK003 262723



SERVICES SK2615-1
B68RK013A



SERVICES KY1671-20
B68RK014A KY1671-13



SERVICES SK2904-2
B68RK015A

IN DEVELOPMENT

SERVICES 280857
B68RK016A

CHECK OUR WEB SITE FOR SUITABILITY OF THESE AND OTHER PARTS, OR CONTACT US.
ALL PARTS OFFERED ARE MAJORSELL BRAND AND MAY NOT BE OF AN ORIGINAL SUPPLY.
ORIGINAL PART NUMBERS ARE USED FOR REFERENCE ONLY. **CHECK ALL APPLICATIONS.**



Fax ++44 121 455 0272 sales@majorsell.co.uk www.majorsell.co.uk



BV001.1

V
A
L
V
E
S



VALVES FOR BENDIX

BXV002

V
A
L
V
E
S



PORTS

SUPPLY 2 x 1/4"
DEL. 3/8"

RE6 VALVE SERVICES 281672.KY1001
23D016 KIT D68RK003A



PORTS

SUPPLY 1/2"+1/4"
DEL. 3/8"

R6 VALVE SERVICES 280375
23D017 KIT D68RK006A



PORTS

SUPPLY 1/2"+1/4"
DEL. 3/8"

R12 VALVE SERVICES 065104
23D091 KIT D68RK012A



PORTS

SUPPLY 1/2"+1/4"
DEL. 1/2"

R12 VALVE SERVICES 102626
23D093 KIT D68RK012A



PORTS

SUPPLY 1/2"+1/4"
DEL. 1/2"

R12H VALVE SERVICES 065125
23D101 KIT D68RK012A



PORTS

SUPPLY 3/4"+1/4"
DEL. 1/2"

R12 VALVE SERVICES 103009
23D103 KIT D68RK012A



PORTS

SUPPLY 1/2"+1/4"
DEL. 1/2"

R14 VALVE SERVICES 103028
23D105 KIT D68RK012A



PORTS

SUPPLY 1/4"+3/4"
DEL. 1/2"

R14H VALVE SERVICES 103010
23D108 KIT D68RK012A

CHECK OUR WEB SITE FOR SUITABILITY OF THESE AND OTHER PARTS, OR CONTACT US.

ALL PARTS OFFERED ARE MAJORSELL BRAND AND MAY NOT BE OF AN ORIGINAL SUPPLY.

ORIGINAL PART NUMBERS ARE USED FOR REFERENCE ONLY. **CHECK ALL APPLICATIONS.**



Fax ++44 121 455 0272

sales@majorsell.co.uk

www.majorsell.co.uk



BXV002.1

V
A
L
V
E
S



PORTS

SUPPLY 3/4"+1/4"
DEL. 1/2"

R14H VALVE

SERVICES 104574

23D110

KIT D68RK012A



PORTS

SUPPLY 3/4"+1/4"
DEL. 1/2" - 1/4"

R8 VALVE

SERVICES KX-18101

23D112

KIT D68RK002



PORTS

SUPPLY 3/4"+1/4"
DEL. 1/2"

R8 VALVE

SERVICES 286370

23D113

KIT D68RK004



PORTS

SUPPLY 3/4"+1/4"
DEL. 1/2"

R8 VALVE

SERVICES 288221

23D114

KIT D68RK004



PORTS

SUPPLY 1/2"+1/4"
DEL. 1/2"

R8 VALVE

SERVICES 287114

23D116

KIT X



PORTS

SUPPLY 1/2"+1/4"
DEL. 3/8"

VALVE

SERVICES 065476

23D130

KIT X

VALVE KITS FOR BENDIX

BXV003

**V
A
L
V
E
S**

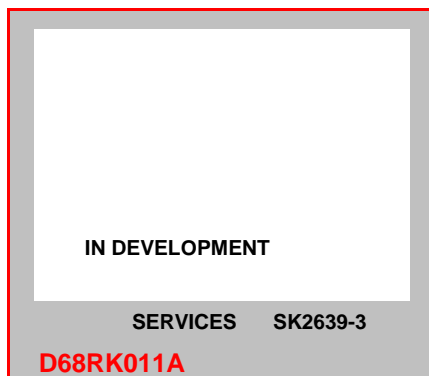

CHECK OUR WEB SITE FOR SUITABILITY OF THESE AND OTHER PARTS, OR CONTACT US.

ALL PARTS OFFERED ARE MAJORSELL BRAND AND MAY NOT BE OF AN ORIGINAL SUPPLY.

ORIGINAL PART NUMBERS ARE USED FOR REFERENCE ONLY. **CHECK ALL APPLICATIONS.**



Fax ++44 121 455 0272 sales@majorsell.co.uk www.majorsell.co.uk



BXV003.1

VALVE KITS FOR BENDIX

V
A
L
V
E
S



VALVES FOR BENDIX

BXV004

V
A
L
V
E
S



PORTS
1/2" x 3/8" x 3/8"

QUICK RELEASE VALVE SERVICES 274999
23E012 KIT E68RK001



PORTS
3/8" x 3/8" x 3/8"

DOUBLE CHECK VALVE SERVICES 295036,280479
23E013 KIT E68RK002



PORTS
3/8"x3/8"x3/8"

QUICK RELEASE VALVE SERVICES 229859,274997
23E017 KIT E68RK001



PORTS
M22

TEST POINT SERVICES KW3731-1
23E040 KIT X



PORTS
M16

TEST POINT SERVICES KW4282-2
23E041 KIT X



PORTS
1/4"

TEST POINT SERVICES KW3405-1
23E042 KIT X



PORTS
M22 X M16 X M22

QUICK RELEASE VALVE SERVICES KW1294-1
23E047 KIT E68RK001



PORTS
M16 X M16 X M16

CHECK VALVE SERVICES 295358
23E055 KIT E68RK002

CHECK OUR WEB SITE FOR SUITABILITY OF THESE AND OTHER PARTS, OR CONTACT US.
ALL PARTS OFFERED ARE MAJORSSELL BRAND AND MAY NOT BE OF AN ORIGINAL SUPPLY.
ORIGINAL PART NUMBERS ARE USED FOR REFERENCE ONLY. **CHECK ALL APPLICATIONS.**



Fax ++44 121 455 0272

sales@majorsell.co.uk

www.majorsell.co.uk



BXV004.1

VALVE KITS FOR BENDIX

V
A
L
V
E
S



FOOTBRAKE VALVES FOR BENDIX

BXV005

**V
A
L
V
E
S**



PORTS

SUPPLY 4 x 3/8"
DEL. 4 x 3/8"

E6 SERVICES 286171,295579
23J005 KIT **J68RK005A**

PORTS

SUPPLY 4 x 3/8"
DEL. 4 x 3/8"

IN DEVELOPMENT

E10 SERVICES 101100
23J015 KIT **J68RK005A**

PORTS

SUPPLY 3/8"
DEL. 3/8"

IN DEVELOPMENT

E10P SERVICES 800632
23J016 KIT **J68RK005A**



PORTS

4 x 1/2"
8 x 1/4"

E7 SERVICES 286773
23J030 KIT **J68RK011A**

PORTS

4 x 1/2"
8 x 1/4"

IN DEVELOPMENT

E7 SERVICES 286775
23J036 KIT **J68RK011A**

PORTS

SUPPLY 2 x 1/2"
DEL. 4 x 1/2"

IN DEVELOPMENT

E2 SERVICES 229501
23J043 KIT **J68RK011A**



PORTS

SUPPLY 2 x 1/2"
DEL. 4 x 1/2"
AUX. 2 x 1/4"

E3 SERVICES 277863
23J044 KIT **J68RK011A**



PORTS

SUPPLY 2 x 1/2"
DEL. 4 x 3/8"

E2 SERVICES 229500
23J052 KIT **J68RK011A**

CHECK OUR WEB SITE FOR SUITABILITY OF THESE AND OTHER PARTS, OR CONTACT US.

ALL PARTS OFFERED ARE MAJORSELL BRAND AND MAY NOT BE OF AN ORIGINAL SUPPLY.

ORIGINAL PART NUMBERS ARE USED FOR REFERENCE ONLY. **CHECK ALL APPLICATIONS.**



Fax ++44 121 455 0272

sales@majorsell.co.uk

www.majorsell.co.uk



BXV005.1

V
A
L
V
E
S



PORTS

SUPPLY 2 x 1/2"
DEL. 4 x 1/2"
AUX. 1/4"

E3 SERVICES 278998
KIT J68RK011A

23J058



PORTS

SUPPLY 1/2"+3/8"
DEL. 1/2"+1/4"

E5 SERVICES 279950
KIT J68RK014A

23J059



PORTS

4 x NO THREAD
2 x 1/4"
10 x 'O' RINGS

E7 SERVICES 284760
KIT J68RK011A

23J060

PORTS

4 x 1/2"
4 x 1/4"
4 x 3/8"
EXH. 1/2"

IN DEVELOPMENT

E7 SERVICES 287411
KIT J68RK011A

23J063

PORTS

4 x 1/2"
6 x 1/4"
2 x 3/8"
EXH. 1/2"

IN DEVELOPMENT

E7 SERVICES 287564
KIT J68RK011A

23J064



PORTS

4 x 1/2"
8x 1/4"

E7 SERVICES 288383
KIT J68RK011A

23J065



PORTS

4 x 1/2"
4 x 1/4"
4 x 3/8"
EXH. 1/2"

E7 SERVICES 101818
KIT J68RK011A

23J066



PORTS

SUPPLY 3/8"
DEL. 3/8"

E8P SERVICES 800629
KIT X

23J067

PORTS

SUPPLY 3/8"
DEL. 3/8"

IN DEVELOPMENT

E8P SERVICES 800630
KIT X

23J068

PORTS

SUPPLY 3/8"
DEL. 3/8"
EXH. 1/2"

IN DEVELOPMENT

E8P SERVICES 800631
KIT X

23J069

FOOTBRAKE VALVES FOR BENDIX

BXV006

V
A
L
V
E
S



PORTS

E7 SERVICES 286771
23J070 KIT J68RK011A

PORTS

SERVICES
KIT

PORTS

SERVICES
KIT

PORTS

SERVICES
KIT

PORTS

SERVICES
KIT

PORTS

SERVICES
KIT

PORTS

SERVICES
KIT

PORTS

SERVICES
KIT

CHECK OUR WEB SITE FOR SUITABILITY OF THESE AND OTHER PARTS, OR CONTACT US.
 ALL PARTS OFFERED ARE MAJORSELL BRAND AND MAY NOT BE OF AN ORIGINAL SUPPLY.
 ORIGINAL PART NUMBERS ARE USED FOR REFERENCE ONLY. **CHECK ALL APPLICATIONS.**



Fax ++44 121 455 0272

sales@majorsell.co.uk

www.majorsell.co.uk



BXV006.1

V
A
L
V
E
S



IN DEVELOPMENT

SERVICES SK2602-1

J68RK001

SERVICES SK2648-1
SK2764-1

J68RK002

SERVICES SK2603-1
KY387-1

J68RK003A

SERVICES SK2814-1
SK2835-1

J68RK005A

SERVICES SK2631-1

J68RK010A

SERVICES 289352

J68RK011A

SERVICES 281084

J68RK014A

SERVICES 105028
281218

J68RK015A

Empty box for part information.

Empty box for part information.

Empty box for part information.

Empty box for part information.

CHECK OUR WEB SITE FOR SUITABILITY OF THESE AND OTHER PARTS, OR CONTACT US.

ALL PARTS OFFERED ARE MAJORSELL BRAND AND MAY NOT BE OF AN ORIGINAL SUPPLY.

ORIGINAL PART NUMBERS ARE USED FOR REFERENCE ONLY. **CHECK ALL APPLICATIONS.**



Fax ++44 121 455 0272 sales@majorsell.co.uk www.majorsell.co.uk



KV001.1

V
A
L
V
E
S

PROTECTION VALVES FOR KNORR



PORTS

IN M22
DEL M16

QUAD PROTECTION VALVE
23B040

SERVICES AE4188
KIT B66RK001A



PORTS

IN M22
DEL M16

QUAD PROTECTION VALVE
23B041

SERVICES AE4190
KIT B66RK001A



PORTS

IN M22
DEL M16

QUAD PROTECTION VALVE
23B048

SERVICES AE4170
KIT B66RK001A



PORTS

IN M22
DEL M16

QUAD PROTECTION VALVE
23B051

SERVICES AE4186
KIT B66RK001A



PORTS

IN M22
DEL M16

PROTECTION VALVE
23B056

SERVICES AE4610
KIT B66RK006A



PORTS

IN M22
DEL M16

QUAD PROTECTION VALVE
23B057

SERVICES AE4613
KIT B66RK006A



PORTS

IN M22
DEL M16

PROTECTION VALVE
23B075

SERVICES AE4612
KIT B66RK006A



PORTS

IN M22
DEL 9mm

QUAD PROTECTION VALVE
23B076

SERVICES AE4440
KIT B66RK011A



PORTS

IN M22
DEL M16

QUAD PROTECTION VALVE
23B089

SERVICES AE4528
KIT B66RK009A



PORTS

IN M22
DEL M16

QUAD PROTECTION VALVE
23B090

SERVICES AE4404
KIT B66RK001A

KV002.1

PROTECTION VALVES KITS FOR KNORR

VALVES



SERVICES I81171, I80448

B66RK001



SERVICES I81171, I78183

B66RK001A



SERVICES I54395, I61090
I75461

B66RK003A



SERVICES I87546, I90314

B66RK004A



SERVICES x

B66RK005A



SERVICES x

B66RK006A



SERVICES x

B66RK008A



SERVICES I137680-008

B66RK009A



SERVICES x

B66RK010A



SERVICES K002435004

B66RK011A

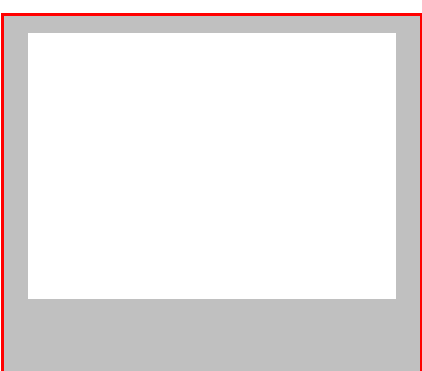

VALVES FOR KNORR

KV003

V
A
L
V
E
S



PORTS
M22

RELAY VALVE SERVICES RE2221
23D001 KIT **D66RK006A**



PORTS
M22

RELAY VALVE SERVICES RE1110
23D008 KIT **D66RK004A**



PORTS
M16

TRAILER CONTROL VALVE SERVICES AB2778
23D013 KIT **I84892**



PORTS
SUPPLY M22
DEL. M16

RELAY VALVE SERVICES RE1115
23D021 KIT **D66RK004A**



PORTS
M12

LEVELLING VALVE SERVICES SV1260
23D025 KIT **D66RK017A**



PORTS
M12

LEVELLING VALVE SERVICES SV1310
23D026 KIT **D66RK017A**



PORTS
M12

LEVELLING VALVE SERVICES SV1313,1278
23D027 KIT **D66RK017A**



PORTS
M12

LEVELLING VALVE SERVICES SV1361
23D028 KIT **D66RK017A**

CHECK OUR WEB SITE FOR SUITABILITY OF THESE AND OTHER PARTS, OR CONTACT US.
ALL PARTS OFFERED ARE MAJORSELL BRAND AND MAY NOT BE OF AN ORIGINAL SUPPLY.
ORIGINAL PART NUMBERS ARE USED FOR REFERENCE ONLY. **CHECK ALL APPLICATIONS.**



Fax ++44 121 455 0272

sales@majorsell.co.uk

www.majorsell.co.uk



KV003.1

VALVES FOR KNORR

VALVES



PORTS
M12

LEVELLING VALVE SERVICES SV1362
23D029 KIT D66RK017A



PORTS
M16
M12

LEVELLING VALVE SERVICES SV1329
23D044 KIT D66RK016A



PORTS
M16
M12

LEVELLING VALVE SERVICES SV1280
23D045 KIT D66RK016A



PORTS
M16
M12

LEVELLING VALVE SERVICES SV1281
23D046 KIT D66RK016A



PORTS
M12

LEVELLING VALVE SERVICES SV1295
23D051 KIT D66RK016A



PORTS
M16
M12

LEVELLING VALVE SERVICES SV1323
23D052 KIT D66RK016A



PORTS
M12

LEVELLING VALVE SERVICES SV1399
23D053 KIT D66RK016A



PORTS
M12

LEVELLING VALVE SERVICES SV1345
23D054 KIT D66RK016A



PORTS
M12

LEVELLING VALVE SERVICES SV1395
23D055 KIT D66RK017A

IN DEVELOPMENT

PORTS
M12

LEVELLING VALVE SERVICES SV1411
23D056 KIT D66RK017A

VALVES FOR KNORR

KV004

V
A
L
V
E
S

PORTS

M12

IN DEVELOPMENT

LEVELLING VALVE SERVICES SV1288
23D057 KIT **D66RK016A**



PORTS

M12

LEVELLING VALVE SERVICES SV1294
23D058 KIT **D66RK017A**



PORTS

M12

LEVELLING VALVE SERVICES SV1412
23D059 KIT **D66RK017A**



PORTS

M12

LEVELLING VALVE SERVICES SV1350
23D087 KIT **D66RK017A**

PORTS

SERVICES
KIT

PORTS

SERVICES
KIT

PORTS

SERVICES
KIT

PORTS

SERVICES
KIT

CHECK OUR WEB SITE FOR SUITABILITY OF THESE AND OTHER PARTS, OR CONTACT US.

ALL PARTS OFFERED ARE MAJORSELL BRAND AND MAY NOT BE OF AN ORIGINAL SUPPLY.

ORIGINAL PART NUMBERS ARE USED FOR REFERENCE ONLY. **CHECK ALL APPLICATIONS.**



Fax ++44 121 455 0272

sales@majorsell.co.uk

www.majorsell.co.uk



KV004.1

V
A
L
V
E
S

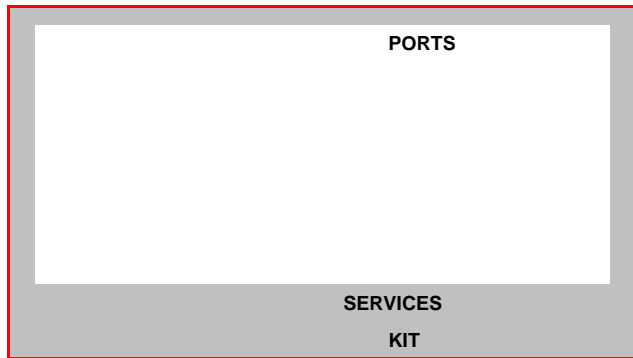
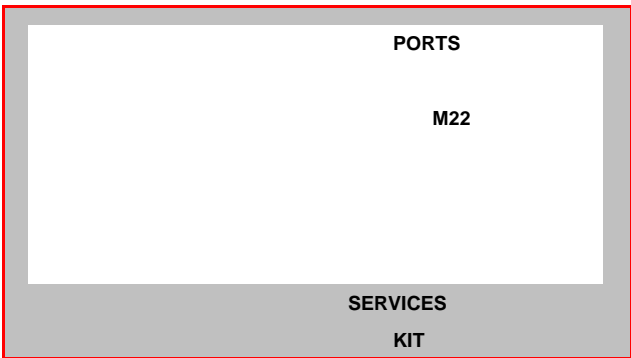
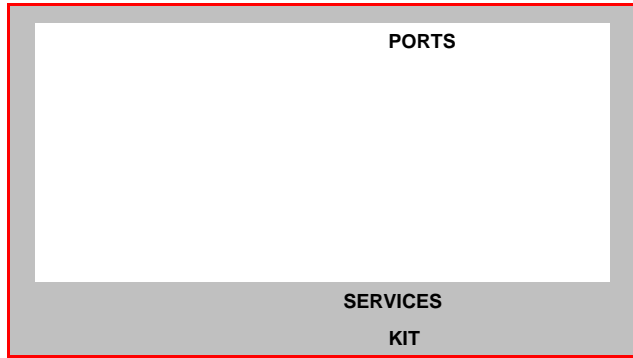
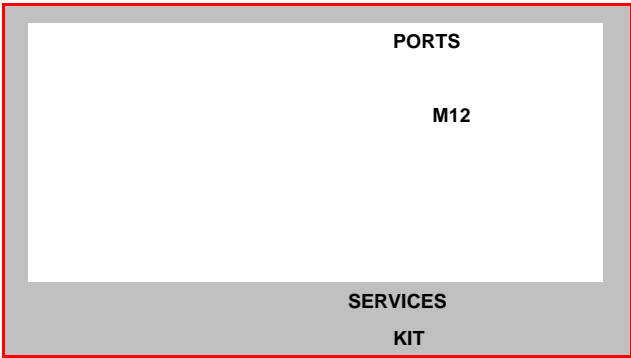
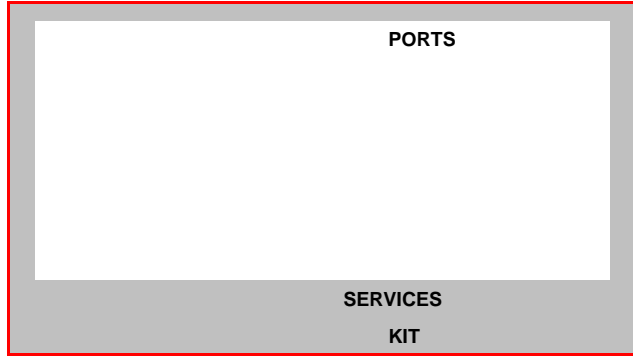
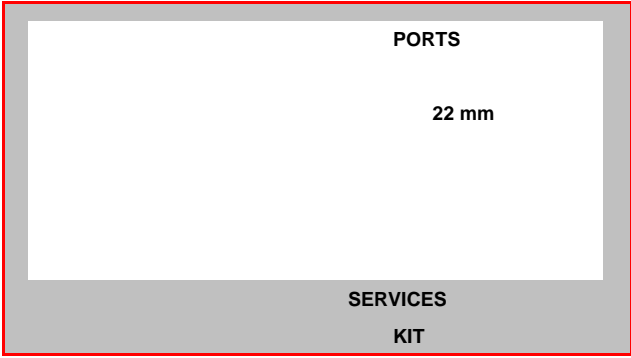
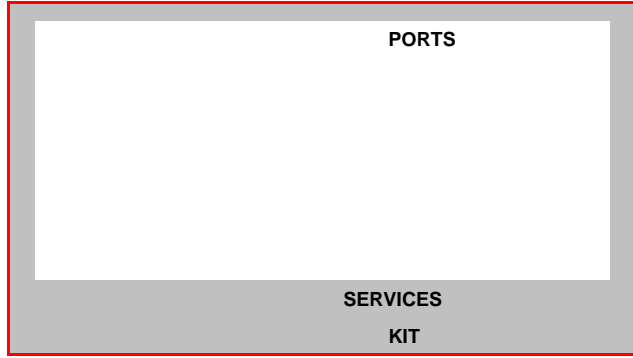
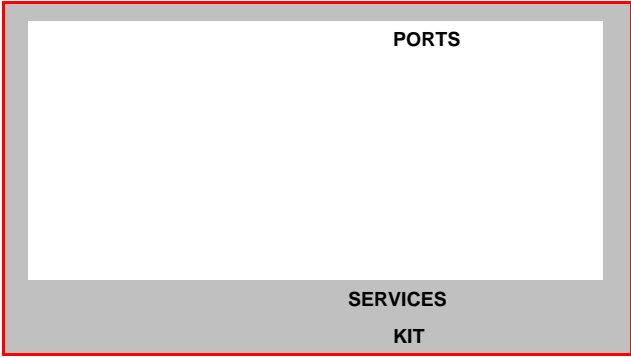
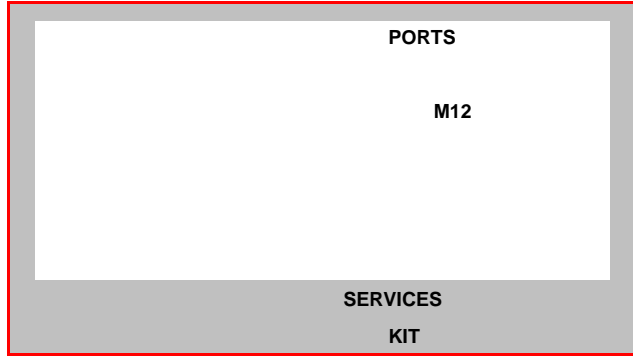
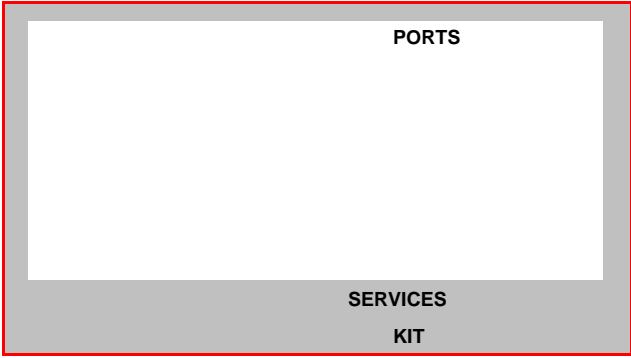

VALVE KITS FOR KNORR

KV005

**V
A
L
V
E
S**



SERVICES I82652
I81234

D66RK001A



SERVICES I85063
I81985

D66RK002A



SERVICES I68094

D66RK004A

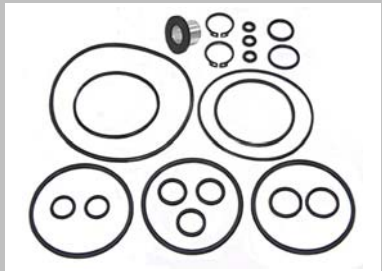

SERVICES I81234

D66RK005A



SERVICES I81594

D66RK006A

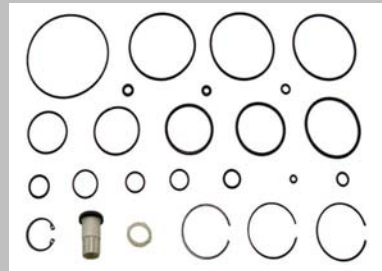

SERVICES I93362-008

D66RK007A



SERVICES I87354-008
I81595-0051

D66RK008A



SERVICES I93262-008

D66RK010A



SERVICES I76992

D66RK011A

IN DEVELOPMENT

SERVICES SEB22187

D66RK013A

IN DEVELOPMENT

SERVICES I76936

D66RK014A



SERVICES I87538

D66RK015A

CHECK OUR WEB SITE FOR SUITABILITY OF THESE AND OTHER PARTS, OR CONTACT US.

ALL PARTS OFFERED ARE MAJORSELL BRAND AND MAY NOT BE OF AN ORIGINAL SUPPLY.

ORIGINAL PART NUMBERS ARE USED FOR REFERENCE ONLY. **CHECK ALL APPLICATIONS.**



Fax ++44 121 455 0272 sales@majorsell.co.uk www.majorsell.co.uk



VALVES FOR KNORR

KV006

V
A
L
V
E
S



PORTS
M22
WITHOUT BACKFLOW

CHARGING VALVE SERVICES DR4345
23E002 KIT E67RK009A



PORTS
M12

AIR ADMISSION VALVE SERVICES AE1206
23E004 KIT E67RK023A



PORTS
M12

AIR ADMISSION VALVE SERVICES AE1207
23E005 KIT E66RK023A



PORTS
M12

GAS PISTON CYLINDER SERVICES SZ1115
23E006 KIT E66RK008



PORTS
M12

GAS PISTON CYLINDER SERVICES SZ1159
23E007 KIT E66RK008



PORTS
M22

QUICK R.V. SERVICES KX9000
23E009 KIT E68RK001



PORTS
M12

OPERATING CYLINDER SERVICES SZ1166
23E010 KIT E66RK009



PORTS
M22

TILT VALVE SERVICES EE1100
23E015 KIT x

CHECK OUR WEB SITE FOR SUITABILITY OF THESE AND OTHER PARTS, OR CONTACT US.
ALL PARTS OFFERED ARE MAJORSELL BRAND AND MAY NOT BE OF AN ORIGINAL SUPPLY.
ORIGINAL PART NUMBERS ARE USED FOR REFERENCE ONLY. **CHECK ALL APPLICATIONS.**



Fax ++44 121 455 0272

sales@majorsell.co.uk

www.majorsell.co.uk



KV006.1

VALVES FOR KNORR

V
A
L
V
E
S

	PORTS
	22 mm
FILTER 23E018	SERVICES LA2103 KIT x

	PORTS
	22 mm
NON RETURN VALVE 23E019	SERVICES AE5115 KIT E67RK022A

	PORTS
	22 mm
STOP COCK 23E021	SERVICES AE2100 KIT x

<p>IN DEVELOPMENT</p>	PORTS
	M12
EXHAUST B. CYLINDER 23E036	SERVICES SZ1114 KIT x

	PORTS
	M12
3 WAY VALVE 23E037	SERVICES AE1208 KIT 180608

<p>IN DEVELOPMENT</p>	PORTS
	M22
ADJ. V 23E039	SERVICES DB2111 KIT x

PORTS
SERVICES
KIT

PORTS
SERVICES
KIT

PORTS
SERVICES
KIT

PORTS
SERVICES
KIT

IN DEVELOPMENT

SERVICES x

E66RK008

IN DEVELOPMENT

SERVICES 194326-008

E66RK009

IN DEVELOPMENT

IN DEVELOPMENT

IN DEVELOPMENT

IN DEVELOPMENT

IN DEVELOPMENT

IN DEVELOPMENT

IN DEVELOPMENT

IN DEVELOPMENT

IN DEVELOPMENT

IN DEVELOPMENT

CHECK OUR WEB SITE FOR SUITABILITY OF THESE AND OTHER PARTS, OR CONTACT US.

ALL PARTS OFFERED ARE MAJORSELL BRAND AND MAY NOT BE OF AN ORIGINAL SUPPLY.

ORIGINAL PART NUMBERS ARE USED FOR REFERENCE ONLY. **CHECK ALL APPLICATIONS.**



Fax ++44 121 455 0272 sales@majorsell.co.uk www.majorsell.co.uk



KV007.1

V
A
L
V
E
S



HANDBRAKE VALVES FOR KNORR

KV008

V
A
L
V
E
S



23H001

SERVICES	HB1258
KIT	H66RK004A



23H003

SERVICES	HB1135
KIT	x



23H004

SERVICES	HB1136
KIT	H66RK004A



23H010

SERVICES	0481016301
KIT	H63RK001 & 2A

IN DEVELOPMENT

23H015

SERVICES	HB1176
KIT	H66RK004

IN DEVELOPMENT

23H029

SERVICES	HB1154
KIT	H66RK002A

IN DEVELOPMENT

23H031

SERVICES	HB1143
KIT	H66RK004A

IN DEVELOPMENT

23H046

SERVICES	HB1142
KIT	H66RK009A

CHECK OUR WEB SITE FOR SUITABILITY OF THESE AND OTHER PARTS, OR CONTACT US.

ALL PARTS OFFERED ARE MAJORSELL BRAND AND MAY NOT BE OF AN ORIGINAL SUPPLY.

ORIGINAL PART NUMBERS ARE USED FOR REFERENCE ONLY. **CHECK ALL APPLICATIONS.**



Fax ++44 121 455 0272

sales@majorsell.co.uk

www.majorsell.co.uk



KV008.1

HANDBRAKE VALVE KITS FOR KNORR

V
A
L
V
E
S



KV009.1

V
A
L
V
E
S



PORTS

5 x NG12

FOOTBRAKE VALVE

23J056

SERVICES MB4694

KIT J66RK012A

FOOTBRAKE VALVES FOR KNORR

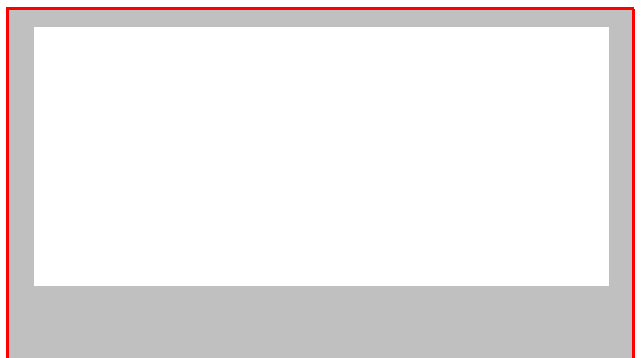
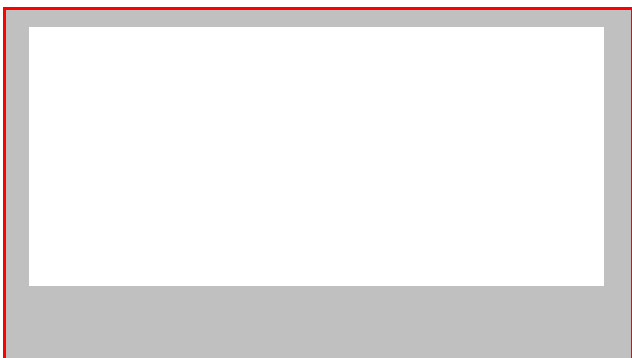
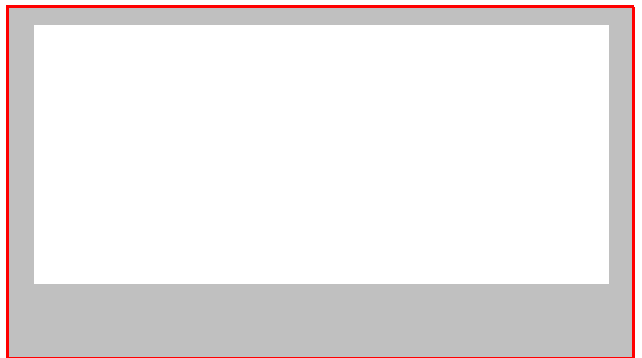
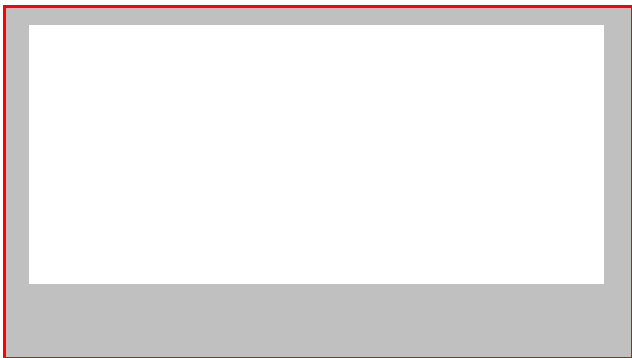

FOOTBRAKE VALVE KITS FOR KNORR

KV010

VALVES



SERVICES 1487010060
J63RK001A 1487010182



SERVICES 1487010035
J63RK002A 1487010178



SERVICES 1487010219
J63RK004A



SERVICES 1487010179
J63RK006A



SERVICES 1487010338
J63RK009A



SERVICES 1487010136
J63RK010A



SERVICES I59347, I67711
J66RK001A



SERVICES I87259
J66RK002A



SERVICES I76535
J66RK004A I74971-0051



SERVICES I93189-008
J66RK005A MB4661



SERVICES : I80450
J66RK008A



SERVICES : I92238
J66RK009A

CHECK OUR WEB SITE FOR SUITABILITY OF THESE AND OTHER PARTS, OR CONTACT US.
 ALL PARTS OFFERED ARE MAJORSELL BRAND AND MAY NOT BE OF AN ORIGINAL SUPPLY.
 ORIGINAL PART NUMBERS ARE USED FOR REFERENCE ONLY. **CHECK ALL APPLICATIONS.**



Fax ++44 121 455 0272 sales@majorsell.co.uk www.majorsell.co.uk



KV010.1

FOOTBRAKE VALVES KITS FOR KNORR

V
A
L
V
E
S



SERVICES : I90694

J66RK010A



SERVICES : I84342

J66RK011A



SERVICES : II14119

J66RK012A



PROTECTION VALVE KITS FOR MARELLI

MARV001

**V
A
L
V
E
S**

IN DEVELOPMENT

SERVICES 76682301

B78RK001A



SERVICES 76624101
76628001

B78RK002A



SERVICES 76671001

B78RK003A



SERVICES 76670901

B78RK004A



SERVICES 76670801

B78RK005A

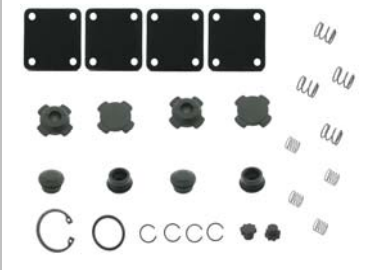

SERVICES 76677701
76624901

B78RK006A

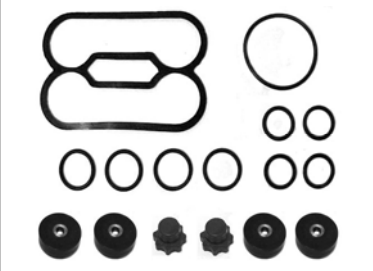

SERVICES 76637201

B78RK007A

IN DEVELOPMENT

SERVICES 76630701

B78RK008A

IN DEVELOPMENT

IN DEVELOPMENT

IN DEVELOPMENT

IN DEVELOPMENT

CHECK OUR WEB SITE FOR SUITABILITY OF THESE AND OTHER PARTS, OR CONTACT US.

ALL PARTS OFFERED ARE MAJORSELL BRAND AND MAY NOT BE OF AN ORIGINAL SUPPLY.

ORIGINAL PART NUMBERS ARE USED FOR REFERENCE ONLY. **CHECK ALL APPLICATIONS.**



Fax ++44 121 455 0272 sales@majorsell.co.uk www.majorsell.co.uk



MARV001.1

VALVE KITS FOR MARELLI

VALVES

PORTS



RELAY VALVE
23D139

SERVICES
KIT

AC574
D78RK006A

PORTS



TRAILER VALVE
23D141

SERVICES
KIT

AC599A
D78RK019A



SERVICES
D78RK005A

76663801
76683401



SERVICES
D78RK006A

76663701
76682701



SERVICES
D78RK007A

76662902
76683202



SERVICES
D78RK010A

76653801
76699601



SERVICES
D78RK011A

76653401
76653701



SERVICES
D78RK012A

76653201
76653501

IN DEVELOPMENT

SERVICES
D78RK013A

76664501
76676101



SERVICES
D78RK019A

76612501



SERVICES
D78RK020A

76664003
93161163



SERVICES
D78RK022A

76665904



23H003 SERVICES DPM42A
KIT x



23H006 SERVICES DPM47A
KIT x



23H009 SERVICES DPM81B
KIT x

IN DEVELOPMENT

23H034 SERVICES DPM90D
KIT H78RK003A

IN DEVELOPMENT

23H038 SERVICES DPM94AAX
KIT H78RK003A

IN DEVELOPMENT

23H039 SERVICES DPM59AAX
KIT x



SERVICES 229666
H78RK001A



SERVICES KZ312-1
H78RK002A



SERVICES KY932-7
H78RK003A

CHECK OUR WEB SITE FOR SUITABILITY OF THESE AND OTHER PARTS, OR CONTACT US.
ALL PARTS OFFERED ARE MAJORSSELL BRAND AND MAY NOT BE OF AN ORIGINAL SUPPLY.
ORIGINAL PART NUMBERS ARE USED FOR REFERENCE ONLY. **CHECK ALL APPLICATIONS.**



Fax ++44 121 455 0272 sales@majorsell.co.uk www.majorsell.co.uk



MARV002.1

V
A
L
V
E
S







PORTS
M16

SERVICES DX75BA
KIT J78RK004A

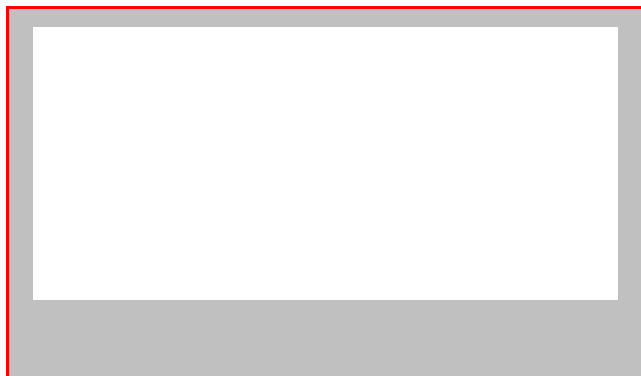
23J061

SERVICES 76636601
76648201

J78RK001A



SERVICES 76640901
76645704, 93161122

J78RK002A



SERVICES 76649001

J78RK003A



SERVICES 76620001
76620002, 76620102

J78RK004A

IN DEVELOPMENT

SERVICES

J78RK004B



SERVICES 76641001
76640405, 93161486

J78RK007A



CHECK OUR WEB SITE FOR SUITABILITY OF THESE AND OTHER PARTS, OR CONTACT US.

ALL PARTS OFFERED ARE MAJORSELL BRAND AND MAY NOT BE OF AN ORIGINAL SUPPLY.

ORIGINAL PART NUMBERS ARE USED FOR REFERENCE ONLY. **CHECK ALL APPLICATIONS.**



Fax ++44 121 455 0272 sales@majorsell.co.uk www.majorsell.co.uk



MARV003.1

V
A
L
V
E
S



PROTECTION VALVES FOR WABCO

WV001

V
A
L
V
E
S



PORTS

M26
M22

UNLOADER VALVE SERVICES 4753042010
23B003 KIT B67RK023A



PORTS

IN M22
DEL M16

PROPORTIONING VALVE SERVICES 4756040110
23B006 KIT B67RK039A



PORTS

IN M22
DEL M16

QUAD VALVE SERVICES 9347022100
23B007 KIT B67RK007A



PORTS

IN M22
DEL M16

QUAD VALVE SERVICES 9347020400
23B009 KIT B67RK002A



PORTS

IN M22
DEL M16

QUAD VALVE SERVICES 9347022500
23B012 KIT B67RK007A



PORTS

IN 1/2"
DEL 3/8"

QUAD VALVE SERVICES 9347140050
23B014 KIT B67RK037A



PORTS

M22
AIR DRYER M12

UNLOADER VALVE SERVICES 9753034740
23B015 KIT B67RK027



PORTS

IN 1/2"
DEL 3/8"

QUAD VALVE SERVICES 9347140060
23B016 KIT B67RK037A

CHECK OUR WEB SITE FOR SUITABILITY OF THESE AND OTHER PARTS, OR CONTACT US.

ALL PARTS OFFERED ARE MAJORSELL BRAND AND MAY NOT BE OF AN ORIGINAL SUPPLY.

ORIGINAL PART NUMBERS ARE USED FOR REFERENCE ONLY. **CHECK ALL APPLICATIONS.**



Fax ++44 121 455 0272

sales@majorsell.co.uk

www.majorsell.co.uk



WV001.1

PROTECTION VALVES FOR WABCO



PORTS

IN	M22
DEL	M16

QUAD VALVE SERVICES 9347020420
23B017 KIT **B67RK002A**



PORTS

IN	1/2"
DEL	3/8"

QUAD VALVE SERVICES 9347140120
23B019 KIT **B67RK037A**



PORTS

IN	M22
DEL	M16

QUAD VALVE SERVICES 9347022200
23B020 KIT **B67RK007A**



PORTS

IN	M22
DEL	M16

QUAD VALVE SERVICES 9347022230
23B021 KIT **B67RK015A**



PORTS

IN	M22
DEL	M16

QUAD VALVE SERVICES 9347022400
23B022 KIT **B67RK002A**



PORTS

IN	1/2"
DEL	3/8"

QUAD VALVE SERVICES 9347140140
23B023 KIT **B67RK037A**



PORTS

IN	M22
DEL	M16

QUAD VALVE SERVICES 9347023220
23B024 KIT **B67RK015A**



PORTS

IN	M22
DEL	M16

QUAD VALVE SERVICES 9347023810
23B025 KIT **B67RK008A**



PORTS

M22

NON RETURN VALVE FITTED

UNLOADER VALVE SERVICES 9753005500
23B026 KIT **B67RK017A**



PORTS

M22

NON RETURN VALVE FITTED WITH TYRE INFLATOR

UNLOADER VALVE SERVICES 9753001110
23B027 KIT **B67RK017A**

PROTECTION VALVES FOR WABCO

WV002

V
A
L
V
E
S



	PORTS
	M22
	M12

UNLOADER VALVE SERVICES 9753030600
23B029 KIT **B67RK027**



	PORTS
	M22

UNLOADER VALVE SERVICES 9753030840
23B031 KIT **B67RK027**



	PORTS
	M22
	M12

COMBINED UNLOADER VALVE SERVICES 9753030850
23B032 KIT **B67RK027**



	PORTS
	M22
	M12

UNLOADER VALVE SERVICES 9753034410
23B033 KIT **B67RK027**



	PORTS
	M22
	M12
AIR DRYER	M12

UNLOADER VALVE SERVICES 9753034780
23B034 KIT **B67RK027**



	PORTS
	M22
	M12
AIR DRYER	M12

UNLOADER VALVE SERVICES 9753035040
23B035 KIT **B67RK027**



	PORTS
IN	M22
DEL	M16
3 CIRCUIT	

PROTECTION VALVE SERVICES 9347010000
23B043 KIT **B67RK014A**



	PORTS
IN	M22
DEL	M16

QUAD VALVE SERVICES 9347022210
23B045 KIT **B67RK011A**

CHECK OUR WEB SITE FOR SUITABILITY OF THESE AND OTHER PARTS, OR CONTACT US.
 ALL PARTS OFFERED ARE MAJORSELL BRAND AND MAY NOT BE OF AN ORIGINAL SUPPLY.
 ORIGINAL PART NUMBERS ARE USED FOR REFERENCE ONLY. **CHECK ALL APPLICATIONS.**



Fax ++44 121 455 0272

sales@majorsell.co.uk

www.majorsell.co.uk



WV002.1

PROTECTION VALVES FOR WABCO

	PORTS	
		M22
UNLOADER VALVE	SERVICES	9753034470
23B046	KIT	B67RK027

	PORTS	
	IN	M22
	DEL	M16
QUAD VALVE	SERVICES	9347140040
23B047	KIT	B67RK037A

	PORTS	
	IN	M22
	DEL	M16
IN DEVELOPMENT		
QUAD VALVE	SERVICES	9347021920
23B049	KIT	B67RK007A

	PORTS	
	IN	M22
	DEL	M16
QUAD VALVE	SERVICES	9347140110
23B052	KIT	B67RK037A

	PORTS	
		M22
		NON RETURN VALVE FITTED
UNLOADER VALVE	SERVICES	9753001100
23B053	KIT	B67RK017A

	PORTS	
	IN	M22
	DEL	M16
PROTECTION VALVE	SERVICES	9347140280
23B054	KIT	B67RK037A

	PORTS	
	IN	1/2"
	DEL	3/8"
PROTECTION VALVE	SERVICES	9347140130
23B055	KIT	B67RK037A

	PORTS	
	IN	1/2"
	DEL	3/8"
PROTECTION VALVE	SERVICES	9347130040
23B058	KIT	B67RK030A

	PORTS	
	IN	1/2"
	DEL	3/8"
PROTECTION VALVE	SERVICES	9347140030
23B059	KIT	B67RK037A

	PORTS	
	IN	1/2"
	DEL	3/8"
IN DEVELOPMENT		
QUAD VALVE	SERVICES	9347022600
23B060	KIT	B67RK007A

PROTECTION VALVES FOR WABCO

WV003

V
A
L
V
E
S



PORTS	
IN	1/2"
DEL	3/8"

PROTECTION VALVE SERVICES 9347140010
23B061 KIT **B67RK037A**



PORTS	
IN	1/2"
DEL	3/8"

PROTECTION VALVE SERVICES 9347140150
23B062 KIT **B67RK037A**



PORTS	
IN	1/2"
DEL	3/8"

PROTECTION VALVE SERVICES 9347140170
23B064 KIT **B67RK037A**



PORTS	
IN	1/2"
DEL	3/8"

PROTECTION VALVE SERVICES 9347140180
23B065 KIT **B67RK037A**



PORTS	
IN	1/2"
DEL	3/8"

PROTECTION VALVE SERVICES 9347140370
23B066 KIT **B67RK037A**



PORTS	
IN	M22
DEL	M16

PROTECTION VALVE SERVICES 9347140090
23B067 KIT **B67RK037A**



PORTS	
IN	M22
DEL	M16

PROTECTION VALVE SERVICES 9347140100
23B068 KIT **B67RK037A**



PORTS	
IN	M22
DEL	M16

PROTECTION VALVE SERVICES 9347140220
23B069 KIT **B67RK037A**

CHECK OUR WEB SITE FOR SUITABILITY OF THESE AND OTHER PARTS, OR CONTACT US.
 ALL PARTS OFFERED ARE MAJORSELL BRAND AND MAY NOT BE OF AN ORIGINAL SUPPLY.
 ORIGINAL PART NUMBERS ARE USED FOR REFERENCE ONLY. **CHECK ALL APPLICATIONS.**



Fax ++44 121 455 0272

sales@majorsell.co.uk

www.majorsell.co.uk



WV003.1

V
A
L
V
E
S

PROTECTION VALVES FOR WABCO



PORTS	
IN	1/2"
DEL	3/8"

PROTECTION VALVE SERVICES 9347140340
23B070 KIT **B67RK037A**



PORTS	
IN	M22
DEL	M16

PROTECTION VALVE SERVICES 9347140400
23B071 KIT **B67RK037A**



PORTS	
IN	M22
DEL	M16

PROTECTION VALVE SERVICES 9347140410
23B072 KIT **B67RK037A**



PORTS	
IN	M22
DEL	M16

PROTECTION VALVE SERVICES 9347141250
23B073 KIT **B67RK037A**



PORTS	
IN	M22
DEL	M16

PROTECTION VALVE SERVICES 9347141260
23B074 KIT **B67RK037A**



PORTS	
IN	M22
DEL	M16

QUAD VALVE SERVICES 9347023000
23B077 KIT **B67RK006A**



PORTS	
IN	M22
DEL	M16

QUAD VALVE SERVICES 9347023200
23B078 KIT **B67RK003A**



PORTS	
IN	M22
DEL	M16

QUAD VALVE SERVICES 9347023400
23B079 KIT **B67RK010A**



PORTS	
IN	M22
DEL	M16

QUAD VALVE SERVICES 9347023800
23B080 KIT **B67RK008A**



PORTS	
IN	M22
DEL	M16

QUAD VALVE SERVICES 9347130350
23B081 KIT **B67RK030A**

PROTECTION VALVES FOR WABCO

WV004

V
A
L
V
E
S



PORTS	
IN	M22
DEL	M16

UNLOADER VALVE SERVICES 9753034730
23B082 KIT **B67RK027**



PORTS	
IN	M22
DEL	M16

QUAD VALVE SERVICES 9347020410
23B083 KIT **B67RK002A**



PORTS	
IN	M22
DEL	M16

QUAD VALVE SERVICES 9347141510
23B084 KIT x



PORTS	
IN	M12
DEL	M22

PROTECTION VALVE SERVICES 9347050050
23B085 KIT **B67RK020A**



PORTS	
IN	M22
DEL	M16

QUAD VALVE SERVICES 9347023020
23B088 KIT **B67RK006A**

IN DEVELOPMENT

PORTS	
IN	M22
DEL	M16

QUAD VALVE SERVICES 9347141100
23B091 KIT **B67RK037A**

IN DEVELOPMENT

PORTS	
IN	M22
DEL	M16

QUAD VALVE SERVICES 9347141090
23B092 KIT **B67RK037A**



PORTS	
IN	M22
DEL	M16

PRESSURE CONTROL VALVE SERVICES 4750154000
23B094 KIT **B67RK036A**

CHECK OUR WEB SITE FOR SUITABILITY OF THESE AND OTHER PARTS, OR CONTACT US.
 ALL PARTS OFFERED ARE MAJORSSELL BRAND AND MAY NOT BE OF AN ORIGINAL SUPPLY.
 ORIGINAL PART NUMBERS ARE USED FOR REFERENCE ONLY. **CHECK ALL APPLICATIONS.**



Fax ++44 121 455 0272

sales@majorsell.co.uk

www.majorsell.co.uk



WV004.1

V
A
L
V
E
S

PORTS	
IN	M22
DEL	M22
IN DEVELOPMENT	
PRESSURE LIMITING VALVE	SERVICES 4750103000
23B095	KIT B67RK004A

	PORTS
	IN M26
	DEL M16
PROTECTION VALVE	SERVICES 9347141230
23B098	KIT B67RK037A

PORTS	
IN	
DEL	
SERVICES	
KIT	

PORTS	
IN	
DEL	
SERVICES	
KIT	

PORTS	
IN	
DEL	
SERVICES	
KIT	

PORTS	
IN	
DEL	
SERVICES	
KIT	

PORTS	
IN	
DEL	
SERVICES	
KIT	

PORTS	
IN	
DEL	
SERVICES	
KIT	

PORTS	
IN	
DEL	
SERVICES	
KIT	

PORTS	
IN	
DEL	
SERVICES	
KIT	

PROTECTION VALVE KITS FOR WABCO

WV005

V
A
L
V
E
S



CHECK OUR WEB SITE FOR SUITABILITY OF THESE AND OTHER PARTS, OR CONTACT US.

ALL PARTS OFFERED ARE MAJORSELL BRAND AND MAY NOT BE OF AN ORIGINAL SUPPLY.

ORIGINAL PART NUMBERS ARE USED FOR REFERENCE ONLY. **CHECK ALL APPLICATIONS.**



Fax ++44 121 455 0272 sales@majorsell.co.uk www.majorsell.co.uk



WV005.1

PROTECTION VALVE KITS FOR WABCO

V
A
L
V
E
S



SERVICES 9349010052

B67RK013A



SERVICES 9347010002

B67RK014A



SERVICES 9347029002

B67RK015A



SERVICES 9347029032

B67RK016A



SERVICES 9753000002

B67RK017A



SERVICES 9347029012

B67RK019A



SERVICES 9347050050

B67RK020A



SERVICES 4729050022

B67RK021A



SERVICES 4729000052

B67RK022A



SERVICES 4753040042

B67RK023A

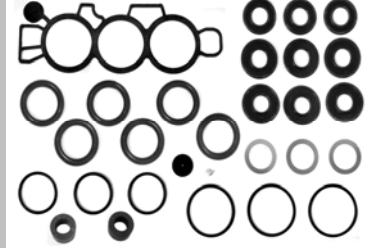

SERVICES 4729050022

B67RK024A



SERVICES 4729050032

B67RK025A

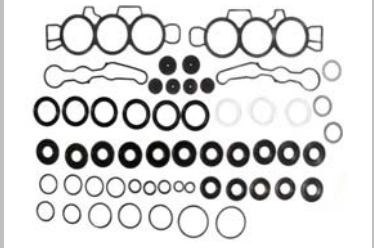

SERVICES 4729050042

B67RK026A



SERVICES 9753030002

B67RK027



SERVICES 934713 series

B67RK030A



CHECK OUR WEB SITE FOR SUITABILITY OF THESE AND OTHER PARTS, OR CONTACT US.
ALL PARTS OFFERED ARE MAJORSELL BRAND AND MAY NOT BE OF AN ORIGINAL SUPPLY.
ORIGINAL PART NUMBERS ARE USED FOR REFERENCE ONLY. **CHECK ALL APPLICATIONS.**



Fax ++44 121 455 0272 sales@majorsell.co.uk www.majorsell.co.uk



WV006.1

PROTECTION VALVE KITS FOR WABCO

V
A
L
V
E
S



VALVES FOR WABCO

WV007

V
A
L
V
E
S



PORTS
M22

RELAY VALVE SERVICES 4730170000
23D001 KIT **D67RK027A**



PORTS
M16
EXH. FLAP

LOAD SENSING VALVE SERVICES 4757100200
23D006 KIT **D67RK004**



PORTS
M22

RELAY VALVE SERVICES 9730010100
23D008 KIT **D67RK001A**



PORTS
M22

TRAILER CONTROL VALVE SERVICES 9730020000
23D009 KIT **D67RK012A**



PORTS
M16
WITH DUMP

TRAILER CONTROL VALVE SERVICES 9730025200
23D010 KIT **D67RK014A**



PORTS
VOSS
M22
M16
EXH. FLAP

RELAY VALVE SERVICES 9730110010
23D011 KIT **D67RK033A**



PORTS
M12

LEVELLING VALVE SERVICES 4640023100
23D012 KIT **D67RK040A**



PORTS
M16

TRAILER CONTROL VALVE SERVICES 9730024020
23D013 KIT **D67RK012A**

CHECK OUR WEB SITE FOR SUITABILITY OF THESE AND OTHER PARTS, OR CONTACT US.
ALL PARTS OFFERED ARE MAJORSELL BRAND AND MAY NOT BE OF AN ORIGINAL SUPPLY.
ORIGINAL PART NUMBERS ARE USED FOR REFERENCE ONLY. **CHECK ALL APPLICATIONS.**



Fax ++44 121 455 0272

sales@majorsell.co.uk

www.majorsell.co.uk



WV007.1

V
A
L
V
E
S

VALVES FOR WABCO



PORTS

M22

PRESSURE LIMITING VALVE SERVICES 4750104000
23D014 KIT D67RK004A



PORTS

M22

M16

RELAY VALVE SERVICES 9730012100
23D020 KIT D67RK001A



PORTS

M22

M16

RELAY VALVE SERVICES 9730010200
23D021 KIT D67RK001A



PORTS

M22

RELAY EMERGENCY VALVE SERVICES 9710021500
23D031 KIT D67RK009A



PORTS

M22

LIGHT LADEN VALVE SERVICES 4756040100
23D032 KIT D67RK039A

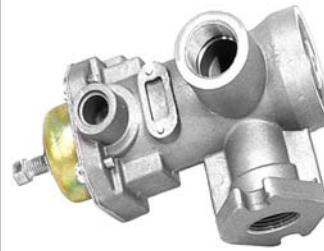

PORTS

M22

PRESSURE LIMITING VALVE SERVICES 4750100260
23D033 KIT D67RK048A

IN DEVELOPMENT

LOAD SENSING VALVE SERVICES 4757155000
23D034 KIT D67RK039A



PORTS

M22

LOAD SENSING VALVE SERVICES 4757010200
23D035 KIT D67RK029A



PORTS

M22

TRAILER CONTROL VALVE SERVICES 4714010100
23D036 KIT D67RK005A



PORTS

M16

TRAILER CONTROL VALVE SERVICES 9730025210
23D042 KIT D67RK014A

VALVES FOR WABCO

WV008

V
A
L
V
E
S



PORTS
M12

LEVELLING VALVE SERVICES 4640060020
23D047 KIT **D67RK046A**

PORTS
M12

IN DEVELOPMENT

LEVELLING VALVE SERVICES 4640061000
23D048 KIT **D67RK046A**



PORTS
M12

LEVELLING VALVE SERVICES 4640060000
23D049 KIT **D67RK046A**



PORTS
PLASTIC QUICK FIT

LEVELLING VALVE SERVICES 4640070010
23D050 KIT **D67RK049A**



PORTS
M12

LEVELLING VALVE SERVICES 4640023320
23D061 KIT **D67RK040A**

PORTS
M12

IN DEVELOPMENT

LEVELLING VALVE SERVICES 4640023380
23D062 KIT **D67RK040A**

PORTS
M12

IN DEVELOPMENT

LEVELLING VALVE SERVICES 4640023390
23D063 KIT **D67RK040A**

PORTS
M12

IN DEVELOPMENT

LEVELLING VALVE SERVICES 4640023600
23D064 KIT **D67RK040A**

CHECK OUR WEB SITE FOR SUITABILITY OF THESE AND OTHER PARTS, OR CONTACT US.

ALL PARTS OFFERED ARE MAJORSELL BRAND AND MAY NOT BE OF AN ORIGINAL SUPPLY.

ORIGINAL PART NUMBERS ARE USED FOR REFERENCE ONLY. **CHECK ALL APPLICATIONS.**



Fax ++44 121 455 0272 sales@majorsell.co.uk www.majorsell.co.uk



WV008.1

V
A
L
V
E
S

VALVES FOR WABCO

PORTS	
M12	
IN DEVELOPMENT	
LEVELLING VALVE	SERVICES 4640024400
23D065	KIT D67RK040A

PORTS	
M12	
IN DEVELOPMENT	
LEVELLING VALVE	SERVICES 4640025300
23D066	KIT D67RK040A

	PORTS
	M22 M16
IN DEVELOPMENT	
TRAILER VALVE	SERVICES 9730090100
23D072	KIT D67RK035A

	PORTS
	M22 M16
IN DEVELOPMENT	
TRAILER VALVE	SERVICES 9730093000
23D073	KIT D67RK045A

PORTS	
M16	
IN DEVELOPMENT	
TRAILER VALVE	SERVICES 9730080020
23D074	KIT D67RK044A

PORTS	
M22 M16	
IN DEVELOPMENT	
LOAD SENSING VALVE	SERVICES 4757130000
23D078	KIT D67RK042A

PORTS	
M22 M16 VOSS M12	
IN DEVELOPMENT	
LOAD SENSING VALVE	SERVICES 4757150000
23D079	KIT D67RK039A

	PORTS
	M22 M16
IN DEVELOPMENT	
LOAD SENSING VALVE	SERVICES 4757120000
23D080	KIT D67RK023

PORTS	
M22	
IN DEVELOPMENT	
LOAD SENSING VALVE	SERVICES 4757010510
23D081	KIT D67RK029A

	PORTS
	M16 M12
IN DEVELOPMENT	
LOAD SENSING VALVE	SERVICES 4757110000
23D082	KIT D67RK030A

VALVES FOR WABCO

WV009

V
A
L
V
E
S



PORTS

M22
M16
EXH. SNAP

RELAY VALVE SERVICES 973011000
23D083 KIT **D67RK033A**



PORTS

M22
M16

RELAY VALVE SERVICES 9730110020
23D084 KIT **D67RK033A**



PORTS

M22 VOSS
M16 VOSS

RELAY VALVE SERVICES 9730110080
23D086 KIT **D67RK033A**



PORTS

M22
M16

RELAY EMERGENCY VALVE SERVICES 9710023000
23D088 KIT x



PORTS

M10

LEVELLING VALVE SERVICES 4640070100
23D090 KIT **D67RK049A**



PORTS

M22
M16

RELAY VALVE SERVICES 9730110500
23D117 KIT 9730110022



PORTS

M22
M16

RELAY VALVE SERVICES 4721950300
23D119 KIT x



PORTS

M22

RELAY VALVE SERVICES 4721950310
23D120 KIT x

CHECK OUR WEB SITE FOR SUITABILITY OF THESE AND OTHER PARTS, OR CONTACT US.

ALL PARTS OFFERED ARE MAJORSELL BRAND AND MAY NOT BE OF AN ORIGINAL SUPPLY.

ORIGINAL PART NUMBERS ARE USED FOR REFERENCE ONLY. **CHECK ALL APPLICATIONS.**



Fax ++44 121 455 0272

sales@majorsell.co.uk

www.majorsell.co.uk



WV009.1

VALVES FOR WABCO

V
A
L
V
E
S



PORTS

M22

RELAY VALVE

SERVICES 4721950410

23D122

KIT D67RK054A



PORTS

M22

M16

RELAY VALVE

SERVICES 9730110090

23D123

KIT D67RK033A



PORTS

M22

M16

RELAY VALVE

SERVICES 9730112000

23D125

KIT D67RK033A



PORTS

M22

RELAY VALVE

SERVICES 9730112050

23D126

KIT D67RK033A



PORTS

1/4 NPTF

LEVELLING VALVE

SERVICES 4640060030

23D127

KIT D67RK041A



PORTS

M10

LEVELLING VALVE

SERVICES 4640070030

23D129

KIT D67RK049A



PORTS

6 x M16

2 x M22

RELAY EMERGENCY VALVE

SERVICES 9710021520

23D132

KIT D67RK010A



PORTS

M22

RELAY EMERGENCY VALVE

SERVICES 9710023040

23D134

KIT D67RK055A



PORTS

M22

M16

TRAILER CONTROL VALVE

SERVICES 9730090010

23D136

KIT D67RK035A



PORTS

M22

VOSS

M16

VOSS

RELAY VALVE

SERVICES 9730112060

23D140

KIT D67RK033A

VALVES FOR WABCO

WV010

V
A
L
V
E
S



PORTS

M16
M22

TRAILER CONTROL VALVE SERVICES 4802040020
23D142 KIT D67RK053A



PORTS

M22 VOSS
M16 VOSS

RELAY VALVE SERVICES 4802020050
23D143 KIT D67RK052A



PORTS

M22 VOSS
M16 VOSS

LOAD SENSING VALVE SERVICES 4757111260
23D144 KIT D67RK030A

PORTS

SERVICES
KIT

PORTS

SERVICES
KIT

PORTS

SERVICES
KIT

PORTS

M22
M16

SERVICES
KIT

PORTS

SERVICES
KIT

CHECK OUR WEB SITE FOR SUITABILITY OF THESE AND OTHER PARTS, OR CONTACT US.
ALL PARTS OFFERED ARE MAJORSELL BRAND AND MAY NOT BE OF AN ORIGINAL SUPPLY.
ORIGINAL PART NUMBERS ARE USED FOR REFERENCE ONLY. **CHECK ALL APPLICATIONS.**



Fax ++44 121 455 0272

sales@majorsell.co.uk

www.majorsell.co.uk



WV010.1

VALVES FOR WABCO

V
A
L
V
E
S

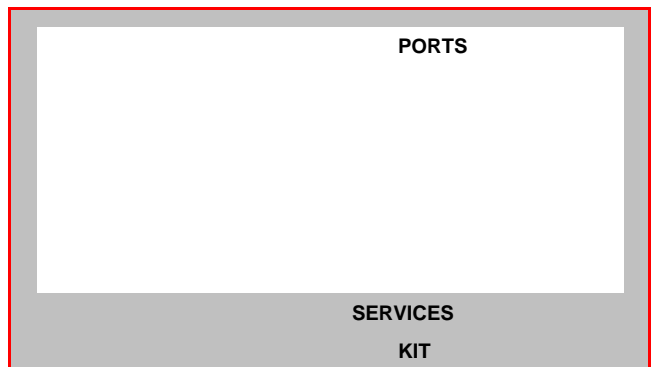
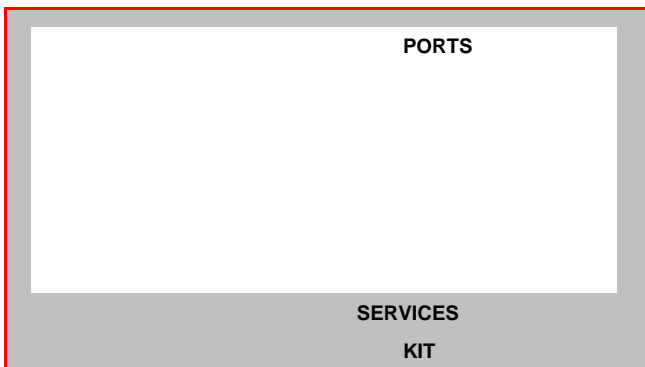
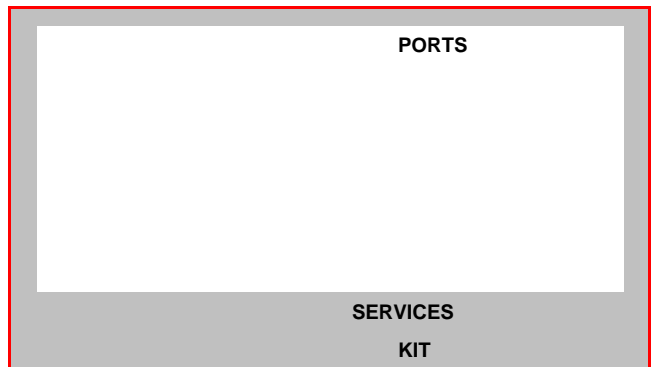
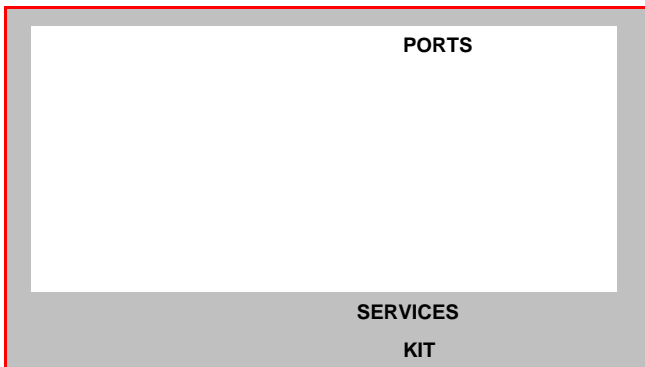
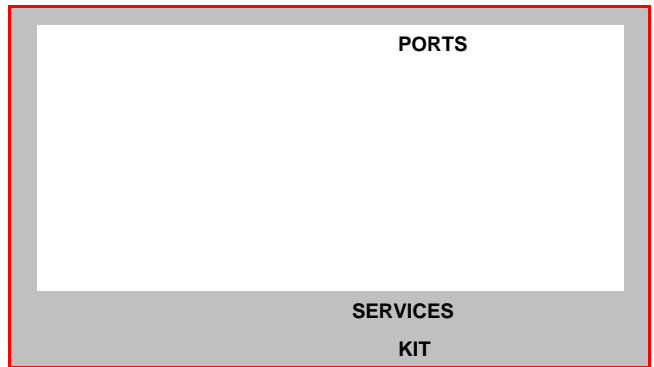
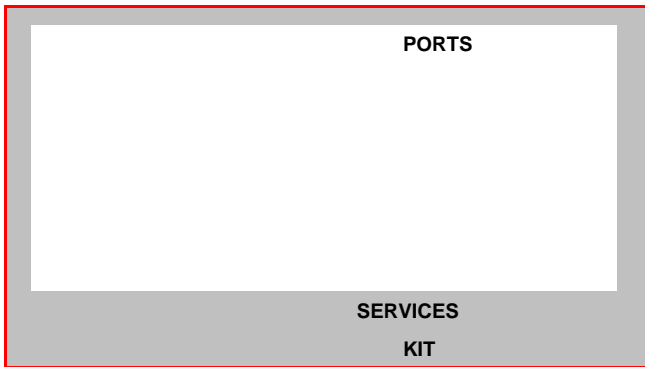
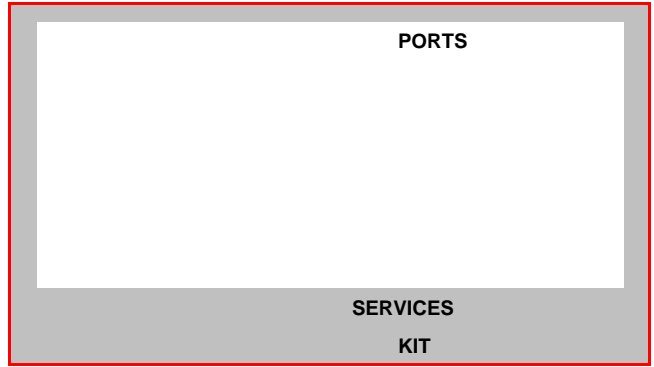
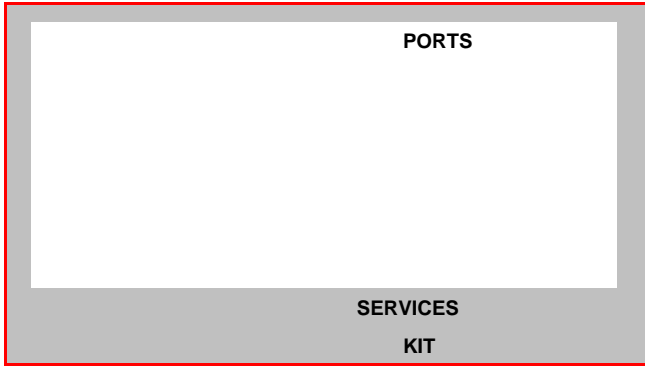
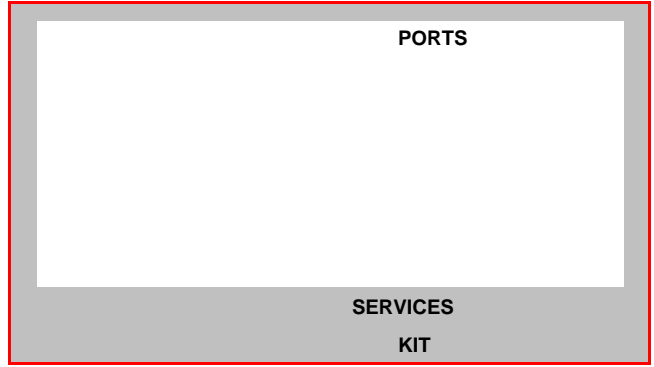
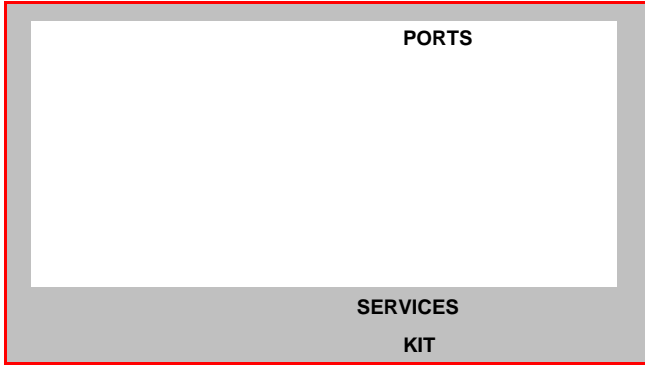



CHECK OUR WEB SITE FOR SUITABILITY OF THESE AND OTHER PARTS, OR CONTACT US.
ALL PARTS OFFERED ARE MAJORSELL BRAND AND MAY NOT BE OF AN ORIGINAL SUPPLY.
ORIGINAL PART NUMBERS ARE USED FOR REFERENCE ONLY. **CHECK ALL APPLICATIONS.**



Fax ++44 121 455 0272 sales@majorsell.co.uk www.majorsell.co.uk



WV011.1

VALVE KITS FOR WABCO

V
A
L
V
E
S



SERVICES 4757120002

D67RK023



SERVICES 4710050092

D67RK024A



SERVICES 9730030002

D67RK026A

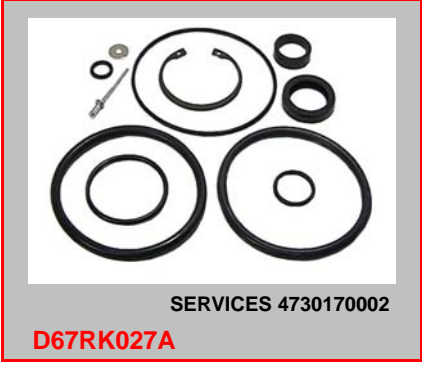

SERVICES 4730170002

D67RK027A



SERVICES 4757010002

D67RK029A



SERVICES 4757110002

D67RK030A



SERVICES 4757000042

D67RK031A



SERVICES 4757140002

D67RK032



SERVICES 9730110002

D67RK033A



SERVICES 9730090002

D67RK035A



SERVICES 4640060082

D67RK037A



SERVICES 4640020022

D67RK038A



SERVICES 4757150002

D67RK039A



SERVICES 4640020052

D67RK040A



SERVICES 4640060002

D67RK041A



CHECK OUR WEB SITE FOR SUITABILITY OF THESE AND OTHER PARTS, OR CONTACT US.
ALL PARTS OFFERED ARE MAJORSELL BRAND AND MAY NOT BE OF AN ORIGINAL SUPPLY.
ORIGINAL PART NUMBERS ARE USED FOR REFERENCE ONLY. **CHECK ALL APPLICATIONS.**



Fax ++44 121 455 0272 sales@majorsell.co.uk www.majorsell.co.uk



WV012.1

VALVE KITS FOR WABCO

V
A
L
V
E
S



SERVICES GA29264
D69RK001A



SERVICES 236945
MAJOR KIT
D69RK002

IN DEVELOPMENT
SERVICES 236945
D69RK002A MINOR KIT



SERVICES 281672
D69RK003A



SERVICES GA29011
D69RK004A

IN DEVELOPMENT

IN DEVELOPMENT

IN DEVELOPMENT

IN DEVELOPMENT

IN DEVELOPMENT

IN DEVELOPMENT

IN DEVELOPMENT

IN DEVELOPMENT

IN DEVELOPMENT

IN DEVELOPMENT

VALVES FOR WABCO

WV013

V
A
L
V
E
S



PORTS
M22
WITH BACK FLOW
CHARGING VALVE SERVICES 434100220
23E001 KIT **E67RK009A**



PORTS
M22
WITHOUT BACK FLOW
CHARGING VALVE SERVICES 4341001240
23E002 KIT **E67RK009A**



PORTS
M12
AUTO DRAIN VALVE SERVICES 434300000
23E003 KIT **E67RK015**



PORTS
M12
BODY LENGTH
37.9 mm
AIR ADMISSION VALVE SERVICES 4630131120
23E004 KIT **E67RK023A**



PORTS
M12
BODY LENGTH
95.6 mm
AIR ADMISSION VALVE SERVICES 4630131140
23E005 KIT **E67RK023A**



PORTS
M22 x M22 x M22
QUICK RELEASE VALVE SERVICES 9735000000
23E009 KIT **E68RK001**



PORTS
1/2" x 3/8" x 3/8"
QUICK RELEASE VALVE SERVICES 9735000140
23E012 KIT **E68RK001**



PORTS
M22
TILT VALVE SERVICES 9343000010
23E015 KIT x

CHECK OUR WEB SITE FOR SUITABILITY OF THESE AND OTHER PARTS, OR CONTACT US.
ALL PARTS OFFERED ARE MAJORSSELL BRAND AND MAY NOT BE OF AN ORIGINAL SUPPLY.
ORIGINAL PART NUMBERS ARE USED FOR REFERENCE ONLY. **CHECK ALL APPLICATIONS.**



Fax ++44 121 455 0272

sales@majorsell.co.uk

www.majorsell.co.uk



WV013.1

VALVES FOR WABCO

V
A
L
V
E
S



PORTS
M22

INLINE FILTER
SERVICES 4325000200
23E018 KIT x



PORTS
M22

NON RETURN VALVE
SERVICES 4340140000
23E019 KIT **E67RK022A**



PORTS
M22

RETURN VALVE
SERVICES 4342080000
23E020 KIT x



PORTS
M22

STOP COCK
SERVICES 4520021070
23E021 KIT 4520020022



PORTS
M22

RED TOP

PALM COUPLING
SERVICES 4522000110
23E022 KIT x



PORTS
M22

YELLOW TOP

PALM COUPLING
SERVICES 4522000120
23E023 KIT x



PORTS
M22

RED TOP

PALM COUPLING
SERVICES 4522002110
23E024 KIT x



PORTS
M22

YELLOW TOP

AUTO PALM COUPLING
SERVICES 4522002120
23E025 KIT x



PORTS
M16

RED TOP

PALM COUPLING
SERVICES 9522000210
23E026 KIT x



PORTS
M16

YELLOW TOP

PALM COUPLING
SERVICES 9522000220
23E027 KIT x

VALVES FOR WABCO

WV014

V
A
L
V
E
S



PORTS
M16
RED TOP

PALM COUPLING SERVICES 9522002210
23E028 KIT x



PORTS
M16
YELLOW TOP

AUTO PALM COUPLING SERVICES 9522002220
23E029 KIT x



PORTS
M10
BODY LENGTH
121 mm

CONTROL VALVE SERVICES 4630220200
23E030 KIT **E67RK006**



PORTS
M22

DOUBLE CHECK VALVE SERVICES 4342020000
23E032 KIT **E68RK001**



PORTS
M22
WITH BYPASS

QUICK RELEASE VALVE SERVICES 4735010000
23E033 KIT **E68RK001**



PORTS
M10x1

3/2 CONTROL VALVE SERVICES 4630360000
23E034 KIT x

PORTS
M22
IN DEVELOPMENT

ADJUSTING VALVE SERVICES 9750010000
23E039 KIT 9750010002



PORTS
M22

TEST POINT SERVICES 4637031000
23E040 KIT x

CHECK OUR WEB SITE FOR SUITABILITY OF THESE AND OTHER PARTS, OR CONTACT US.
ALL PARTS OFFERED ARE MAJORSELL BRAND AND MAY NOT BE OF AN ORIGINAL SUPPLY.
ORIGINAL PART NUMBERS ARE USED FOR REFERENCE ONLY. **CHECK ALL APPLICATIONS.**



Fax ++44 121 455 0272

sales@majorsell.co.uk

www.majorsell.co.uk



WV014.1

VALVES FOR WABCO

V
A
L
V
E
S



PORTS
1/4"

TEST POINT SERVICES 4637051020
23E042 KIT x



PORTS
M16 x M16 x M16

QUICK RELEASE VALVE SERVICES 9735000060
23E046 KIT **E68RK001**



PORTS
M22 x M16 x M22

QUICK RELEASE VALVE SERVICES 9735000180
23E047 KIT **E68RK001**



PORTS
M22

CHARGING VALVE SERVICES 4341002200
23E056 KIT **E67RK009A**

Blank product card

Blank product card

PORTS

SERVICES
KIT

PORTS

SERVICES
KIT

Blank product card

Blank product card

VALVE KITS FOR WABCO

WV015

V
A
L
V
E
S

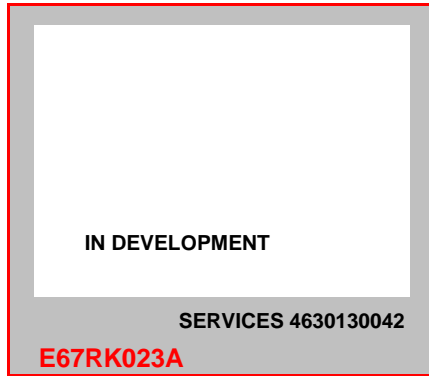

CHECK OUR WEB SITE FOR SUITABILITY OF THESE AND OTHER PARTS, OR CONTACT US.
ALL PARTS OFFERED ARE MAJORSELL BRAND AND MAY NOT BE OF AN ORIGINAL SUPPLY.
ORIGINAL PART NUMBERS ARE USED FOR REFERENCE ONLY. **CHECK ALL APPLICATIONS.**



Fax ++44 121 455 0272 sales@majorsell.co.uk www.majorsell.co.uk



WV015.1

VALVE KITS FOR WABCO

V
A
L
V
E
S



HANDBRAKE VALVE FOR WABCO

WV016

V
A
L
V
E
S



HANDBRAKE VALVE SERVICES 9617223020
23H002 KIT **H67RK012A**



HANDBRAKE VALVE SERVICES 9617011000
23H003 KIT **H67RK019**



HANDBRAKE VALVE SERVICES 9617011100
23H004 KIT **H67RK019**



HANDBRAKE VALVE SERVICES 9617020050
23H005 KIT **H67RK019**



HANDBRAKE VALVE SERVICES 9617020140
23H006 KIT **H67RK019**



HANDBRAKE VALVE SERVICES 9617020110
23H007 KIT **H67RK019**



HANDBRAKE VALVE SERVICES 9617020310
23H008 KIT **H67RK019**



HANDBRAKE VALVE SERVICES 9617221510
23H009 KIT **H67RK014**

CHECK OUR WEB SITE FOR SUITABILITY OF THESE AND OTHER PARTS, OR CONTACT US.
 ALL PARTS OFFERED ARE MAJORSELL BRAND AND MAY NOT BE OF AN ORIGINAL SUPPLY.
 ORIGINAL PART NUMBERS ARE USED FOR REFERENCE ONLY. **CHECK ALL APPLICATIONS.**



Fax ++44 121 455 0272

sales@majorsell.co.uk

www.majorsell.co.uk



WV016.1



HANDBRAKE VALVE SERVICES 9617222520
23H010 KIT **H67RK012A**



HANDBRAKE VALVE SERVICES APGA6635
23H012 KIT **H69RK004**

IN DEVELOPMENT

HANDBRAKE VALVE SERVICES 4630320200
23H014 KIT x

IN DEVELOPMENT

HANDBRAKE VALVE SERVICES 9617221600
23H017 KIT **H67RK014A**



HANDBRAKE VALVE SERVICES 9617230010
23H019 KIT **H67RK017**

HANDBRAKE VALVE FOR WABCO

IN DEVELOPMENT

HANDBRAKE VALVE SERVICES 9617222580
23H011 KIT **H67RK012A**



HANDBRAKE VALVE SERVICES 9617020010
23H013 KIT **H67RK019**

IN DEVELOPMENT

HANDBRAKE VALVE SERVICES 9617221500
23H016 KIT **H67RK014A**



HANDBRAKE VALVE SERVICES 9617222120
23H018 KIT **H67RK012A**



HANDBRAKE VALVE SERVICES 9617221680
23H020 KIT x

HANDBRAKE VALVE FOR WABCO

WV017

V
A
L
V
E
S



HANDBRAKE VALVE SERVICES 9617231040
23H021 KIT **H67RK017**

IN DEVELOPMENT

HANDBRAKE VALVE SERVICES 9617231080
23H022 KIT **H67RK017**



HANDBRAKE VALVE SERVICES 9617231070
23H023 KIT **H67RK017**



HANDBRAKE VALVE SERVICES 9617231180
23H024 KIT **H67RK017**

IN DEVELOPMENT

HANDBRAKE VALVE SERVICES 9617222720
23H025 KIT **H67RK012A**

IN DEVELOPMENT

HANDBRAKE VALVE SERVICES 9617222750
23H026 KIT **H67RK013A**

IN DEVELOPMENT

HANDBRAKE VALVE SERVICES 9617223050
23H027 KIT **H67RK012A**

IN DEVELOPMENT

HANDBRAKE VALVE SERVICES 9617223240
23H028 KIT **H67RK012A**

CHECK OUR WEB SITE FOR SUITABILITY OF THESE AND OTHER PARTS, OR CONTACT US.
ALL PARTS OFFERED ARE MAJORSELL BRAND AND MAY NOT BE OF AN ORIGINAL SUPPLY.
ORIGINAL PART NUMBERS ARE USED FOR REFERENCE ONLY. **CHECK ALL APPLICATIONS.**



Fax ++44 121 455 0272

sales@majorsell.co.uk

www.majorsell.co.uk



V
A
L
V
E
S

WV017.1

HANDBRAKE VALVE FOR WABCO

IN DEVELOPMENT

HANDBRAKE VALVE	SERVICES	961722320
23H030	KIT	H67RK012A

IN DEVELOPMENT

HANDBRAKE VALVE	SERVICES	9617231250
23H032	KIT	x

IN DEVELOPMENT

HANDBRAKE VALVE	SERVICES	9617231220
23H033	KIT	x

IN DEVELOPMENT

HANDBRAKE VALVE	SERVICES	9617223140
23H035	KIT	H67RK012A

IN DEVELOPMENT

HANDBRAKE VALVE	SERVICES	9617231110
23H036	KIT	H67RK017

IN DEVELOPMENT

HANDBRAKE VALVE	SERVICES	9617230380
23H037	KIT	H67RK017

IN DEVELOPMENT

HANDBRAKE VALVE	SERVICES	APSA5890
23H040	KIT	H69RK009A

IN DEVELOPMENT

HANDBRAKE VALVE	SERVICES	9617222640
23H041	KIT	H67RK013A

IN DEVELOPMENT

HANDBRAKE VALVE	SERVICES	9617222690
23H042	KIT	H67RK012A

IN DEVELOPMENT

HANDBRAKE VALVE	SERVICES	9617221560
23H043	KIT	H67RK014

HANDBRAKE VALVE FOR WABCO

WV018

V
A
L
V
E
S

IN DEVELOPMENT

HANDBRAKE VALVE	SERVICES	9617232080
23H044	KIT	H67RK017

IN DEVELOPMENT

HANDBRAKE VALVE	SERVICES	9617232040
23H045	KIT	H67RK017

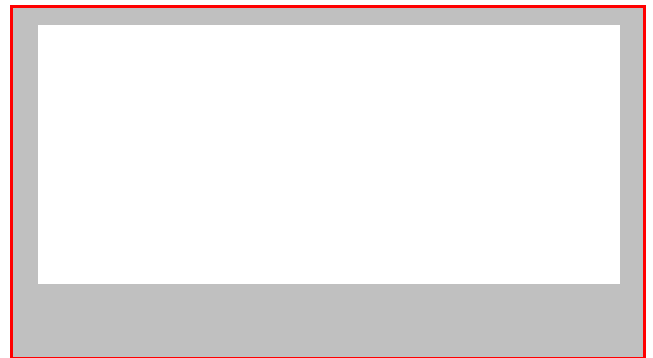

CHECK OUR WEB SITE FOR SUITABILITY OF THESE AND OTHER PARTS, OR CONTACT US.
ALL PARTS OFFERED ARE MAJORSELL BRAND AND MAY NOT BE OF AN ORIGINAL SUPPLY.
ORIGINAL PART NUMBERS ARE USED FOR REFERENCE ONLY. **CHECK ALL APPLICATIONS.**



Fax ++44 121 455 0272

sales@majorsell.co.uk

www.majorsell.co.uk



WV018.1

HANDBRAKE VALVE KITS FOR WABCO

V
A
L
V
E
S

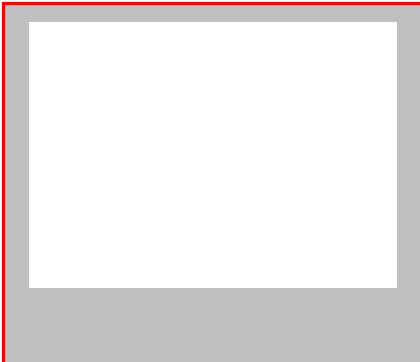
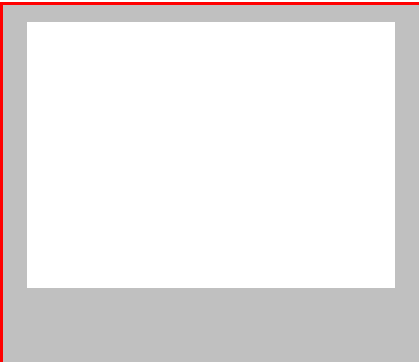

FOOTBRAKE VALVE FOR WABCO

WV019

V
A
L
V
E
S



PORTS

8 x M16
EXH. ELBOW

FOOT BRAKE VALVE SERVICES 4613150080
23J001 KIT **J67RK001A**



PORTS

8 x M22
EXH. FLAP

FOOT BRAKE VALVE SERVICES 4613074790
23J002 KIT **J67RK003A**



PORTS

M16
M12

FOOT BRAKE VALVE SERVICES 4613190080
23J004 KIT **J67RK009A**

PORTS

8 x M16
2 x M12

IN DEVELOPMENT

FOOT BRAKE VALVE SERVICES 4613150360
23J006 KIT **J67RK001A**



PORTS

M22
EXH. FLAP

FOOT BRAKE VALVE SERVICES 4614911020
23J007 KIT **J67RK003**

PORTS

M22
EXH. FLAP

IN DEVELOPMENT

FOOT BRAKE VALVE SERVICES 4613072000
23J008 KIT **J67RK003**



PORTS

M16
M12
EXH. FLAP

FOOT BRAKE VALVE SERVICES 4613154970
23J009 KIT **J67RK001A**

PORTS

8 x M16
2 x M12
EXH. PIPE

IN DEVELOPMENT

FOOT BRAKE VALVE SERVICES 4613190180
23J010 KIT 4613199082

CHECK OUR WEB SITE FOR SUITABILITY OF THESE AND OTHER PARTS, OR CONTACT US.

ALL PARTS OFFERED ARE MAJORSELL BRAND AND MAY NOT BE OF AN ORIGINAL SUPPLY.

ORIGINAL PART NUMBERS ARE USED FOR REFERENCE ONLY. **CHECK ALL APPLICATIONS.**



Fax ++44 121 455 0272

sales@majorsell.co.uk

www.majorsell.co.uk



WV019.1

FOOTBRAKE VALVE FOR WABCO

PORTS	
8 x	M16
EXH.	PIPE
IN DEVELOPMENT	
FOOT BRAKE VALVE	SERVICES 4613190280
23J011	KIT 4613199082

	PORTS	
	8 x	M16
	EXH.	PIPE
IN DEVELOPMENT		
FOOT BRAKE VALVE	SERVICES 4613190320	
23J012	KIT J67RK001A	

PORTS	
M22	
M12	
IN DEVELOPMENT	
FOOT BRAKE VALVE	SERVICES 4614990000
23J014	KIT J67RK005A

PORTS	
	M22
EXH.	FLAP
IN DEVELOPMENT	
FOOT BRAKE VALVE	SERVICES 4613072020
23J017	KIT J67RK003

PORTS	
	M22
EXH.	FLAP
IN DEVELOPMENT	
FOOT BRAKE VALVE	SERVICES 4613072040
23J018	KIT J67RK003

PORTS	
	M22
EXH.	FLAP
IN DEVELOPMENT	
FOOT BRAKE VALVE	SERVICES 4613073700
23J019	KIT J67RK003

PORTS	
	M22
EXH.	FLAP
IN DEVELOPMENT	
FOOT BRAKE VALVE	SERVICES 4613075000
23J020	KIT J67RK003

PORTS	
	M22
EXH.	FLAP
IN DEVELOPMENT	
FOOT BRAKE VALVE	SERVICES 4613075160
23J021	KIT J67RK003

PORTS	
	M22
EXH.	FLAP
IN DEVELOPMENT	
FOOT BRAKE VALVE	SERVICES 4613075200
23J022	KIT J67RK003

PORTS	
	M22
EXH.	FLAP
IN DEVELOPMENT	
FOOT BRAKE VALVE	SERVICES 4613075210
23J023	KIT J67RK003

FOOTBRAKE VALVE FOR WABCO

WV020

V
A
L
V
E
S

PORTS		
		M22
EXH.	FLAP	
IN DEVELOPMENT		
FOOT BRAKE VALVE	SERVICES	4613074000
23J024	KIT	J67RK003

	PORTS	
		M16
	EXH.	FLAP
IN DEVELOPMENT		
FOOT BRAKE VALVE	SERVICES	4613074390
23J025	KIT	J67RK003

PORTS		
		M16
EXH.	FLAP	
IN DEVELOPMENT		
FOOT BRAKE VALVE	SERVICES	4613074590
23J026	KIT	J67RK003

PORTS		
		M22
EXH.	COVER	
IN DEVELOPMENT		
FOOT BRAKE VALVE	SERVICES	4613074670
23J027	KIT	J67RK003

PORTS		
		M22
EXH.	M22	
IN DEVELOPMENT		
FOOT BRAKE VALVE	SERVICES	4613074750
23J028	KIT	J67RK003

PORTS		
		M22
EXH.	FLAP	
IN DEVELOPMENT		
FOOT BRAKE VALVE	SERVICES	4613074760
23J029	KIT	J67RK003

	PORTS	
		M22
	EXH.	FLAP
IN DEVELOPMENT		
FOOT BRAKE VALVE	SERVICES	4614912740
23J031	KIT	J67RK003

	PORTS	
	8 x	M16
	2 x	M12
EXH.	PIPE	
IN DEVELOPMENT		
FOOT BRAKE VALVE	SERVICES	4613150420
23J032	KIT	J67RK014

CHECK OUR WEB SITE FOR SUITABILITY OF THESE AND OTHER PARTS, OR CONTACT US.

ALL PARTS OFFERED ARE MAJORSELL BRAND AND MAY NOT BE OF AN ORIGINAL SUPPLY.

ORIGINAL PART NUMBERS ARE USED FOR REFERENCE ONLY. **CHECK ALL APPLICATIONS.**



Fax ++44 121 455 0272

sales@majorsell.co.uk

www.majorsell.co.uk





WV020.1

	PORTS	
		8 x M16
	EXH. FLAP	
FOOT BRAKE VALVE 23J033	SERVICES KIT	4613150120 J67RK001A

FOOTBRAKE VALVE FOR WABCO

	PORTS	
		4 x M16
		2 x M12
	EXH. FLAP	
IN DEVELOPMENT FOOT BRAKE VALVE 23J034	SERVICES KIT	4613154820 J67RK001A

	PORTS	
		8 x M16
	EXH. FLAP	
IN DEVELOPMENT FOOT BRAKE VALVE 23J035	SERVICES KIT	4613150090 J67RK001A

	PORTS	
		4 x M16
		2 x M12
	EXH. FLAP	
IN DEVELOPMENT FOOT BRAKE VALVE 23J037	SERVICES KIT	4613150170 J67RK001A

	PORTS	
		4 x M22
	EXH. SNAP ON	
IN DEVELOPMENT FOOT BRAKE VALVE 23J038	SERVICES KIT	4613152530 J67RK001A

	PORTS	
		M16+M12
	EXH. FLAP	
IN DEVELOPMENT FOOT BRAKE VALVE 23J039	SERVICES KIT	4613170140 J67RK001A

	PORTS	
		4 x M16
		2 x M12
	EXH. FLAP	
IN DEVELOPMENT FOOT BRAKE VALVE 23J040	SERVICES KIT	4613150470 J67RK001A

	PORTS	
		4 x M16
		2 x M12
	EXH. M22	
IN DEVELOPMENT FOOT BRAKE VALVE 23J041	SERVICES KIT	4614820990 4613159152

	PORTS	
		M22
	EXH. FLAP	
IN DEVELOPMENT FOOT BRAKE VALVE 23J045	SERVICES KIT	APSA7314-1B J69RK006A

	PORTS	
		PUSH IN
FOOT BRAKE VALVE 23J046	SERVICES KIT	4613151800 J67RK017A

WV021.1

V
A
L
V
E
S

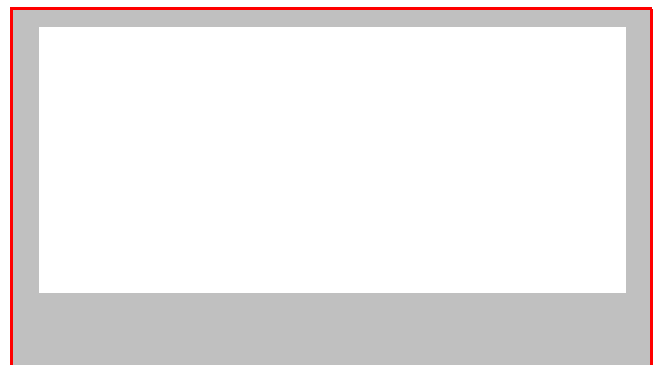
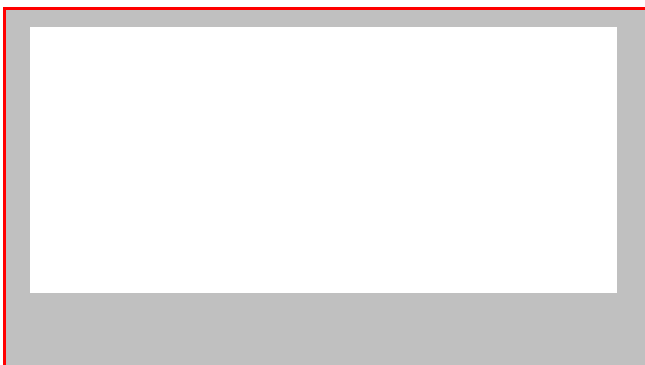
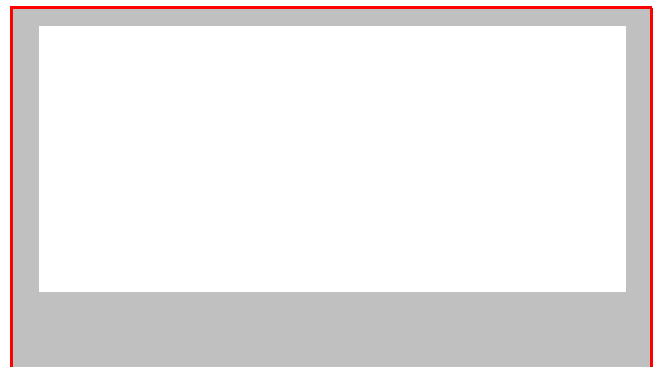
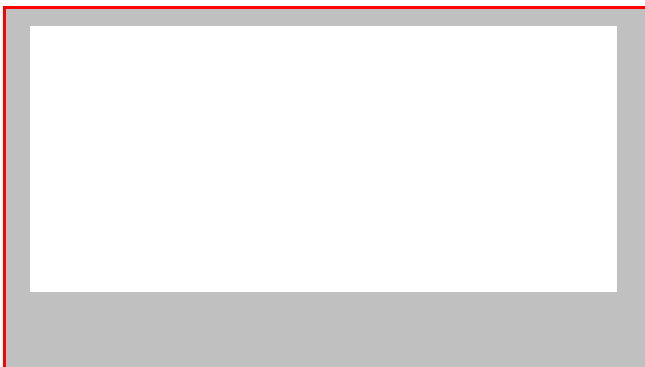

FOOTBRAKE VALVE KITS FOR WABCO

WV022

**V
A
L
V
E
S**

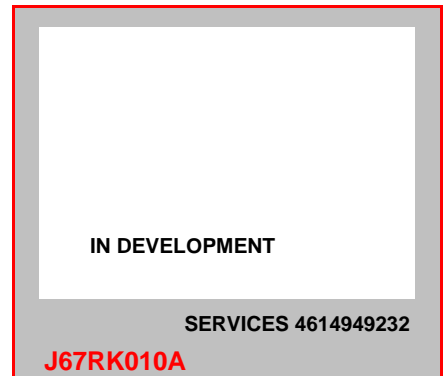

CHECK OUR WEB SITE FOR SUITABILITY OF THESE AND OTHER PARTS, OR CONTACT US.

ALL PARTS OFFERED ARE MAJORSELL BRAND AND MAY NOT BE OF AN ORIGINAL SUPPLY.

ORIGINAL PART NUMBERS ARE USED FOR REFERENCE ONLY. **CHECK ALL APPLICATIONS.**



Fax ++44 121 455 0272 sales@majorsell.co.uk www.majorsell.co.uk



WV022.1

V
A
L
V
E
S

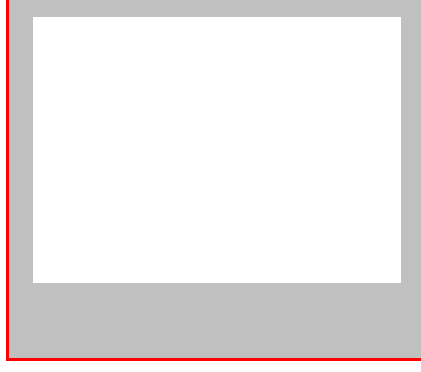
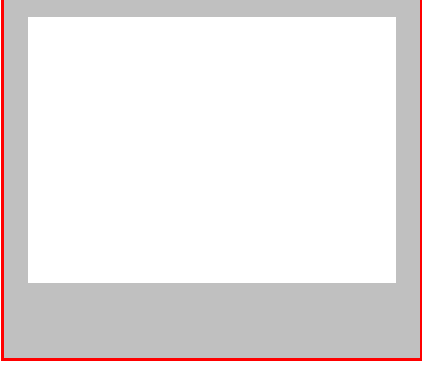
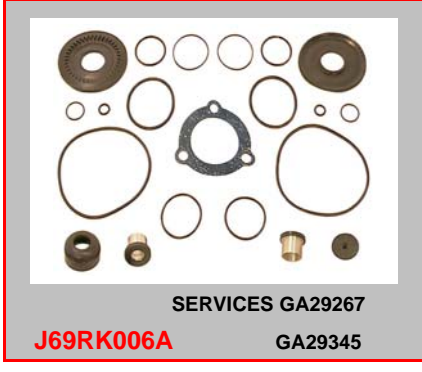



PORTS

M22
M22
M16

HEIGHT SENSOR SERVICES 4410500110
23M001 KIT x



PORTS

M22
M22
M16

HEIGHT SENSOR SERVICES 4410500080
23M002 KIT 4110500002



PORTS

M22
M22
M16

HEIGHT SENSOR SERVICES 4410500100
23M003 KIT x



PORTS

M22

SOLENOID CONTROL VALVE SERVICES 4721950180
23M004 KIT L67RK006A



PORTS

ABS CABLE SERVICES 8946011322
23M005 KIT x

PORTS

M16

IN DEVELOPMENT

SOLENOID CONTROLLER SERVICES 4801020100
23M006 KIT x

PORTS

M22
M16

IN DEVELOPMENT

SOLENOID CONTROLLER SERVICES 4005000810
23M007 KIT x



PORTS

ELECTRICAL FITTING

SOLENOID CONTROLLER SERVICES 4460043100
23M008 KIT x

CHECK OUR WEB SITE FOR SUITABILITY OF THESE AND OTHER PARTS, OR CONTACT US.

ALL PARTS OFFERED ARE MAJORSELL BRAND AND MAY NOT BE OF AN ORIGINAL SUPPLY.

ORIGINAL PART NUMBERS ARE USED FOR REFERENCE ONLY. **CHECK ALL APPLICATIONS.**



Fax ++44 121 455 0272

sales@majorsell.co.uk

www.majorsell.co.uk



WV023.1

V
A
L
V
E
S

PORTS

ELECTRICAL FITTING

IN DEVELOPMENT

ABS SENSOR SERVICES 4410435041
23M009 KIT x

PORTS



ABS SENSOR CABLE SERVICES 4410329222
23M010 KIT x

PORTS



ABS SENSOR CABLE SERVICES 4410329212
23M011 KIT x

PORTS

IN DEVELOPMENT

ABS SENSOR CABLE SERVICES 9710029212
23M012 KIT x

PORTS

1/2" NPTF

IN DEVELOPMENT

SOLENOID CONTROL VALVE SERVICES 4721950050
23M013 KIT L67RK006A

PORTS

1/2" NPTF

IN DEVELOPMENT

SOLENOID CONTROL VALVE SERVICES 4721950520
23M014 KIT L67RK006A

PORTS

ELECTRICAL FITTING



HEIGHT SENSOR SERVICES 4410500120
23M015 KIT L67RK006A

PORTS

M22

IN DEVELOPMENT

ABS MODULAR VALVE SERVICES 4721950110
23M016 KIT L67RK006A

PORTS

M22

IN DEVELOPMENT

ABS MODULAR VALVE SERVICES 4721950000
23M017 KIT L67RK006A

Blank card

PROTECTION VALVES FOR BOSCH

MISCV001

**V
A
L
V
E
S**

PORTS



UNLOADER VALVE SERVICES 0481039202
23B050 KIT **B63RK004A**

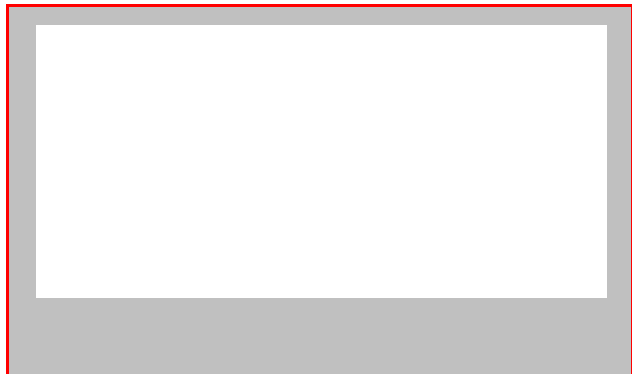

SERVICES 1487010234
B63RK002 1487010237



SERVICES 1487010234
B63RK002A 1487010237



SERVICES 1487010165
B63RK004A 1487010102



SERVICES 1487010163
B63RK005A



SERVICES 1487010162
B63RK008A



SERVICES 1487010245
B63RK009A



SERVICES 1487010221
B63RK012A

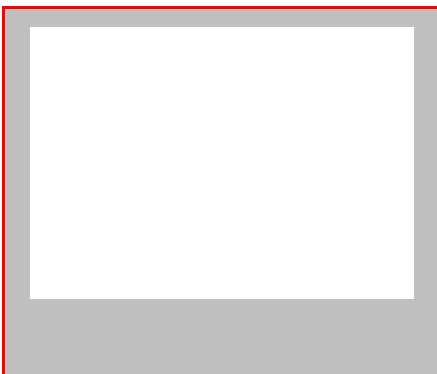

CHECK OUR WEB SITE FOR SUITABILITY OF THESE AND OTHER PARTS, OR CONTACT US.
ALL PARTS OFFERED ARE MAJORSELL BRAND AND MAY NOT BE OF AN ORIGINAL SUPPLY.
ORIGINAL PART NUMBERS ARE USED FOR REFERENCE ONLY. **CHECK ALL APPLICATIONS.**



Fax ++44 121 455 0272 sales@majorsell.co.uk www.majorsell.co.uk



V
A
L
V
E
S



VALVES FOR BOSCH

MISCV002

V
A
L
V
E
S



PORTS
M12

LEVELLING VALVE SERVICES 0500005017
23D002 KIT D63RK016A



PORTS
M12

LEVELLING VALVE SERVICES 0500005018
23D003 KIT D63RK016A



PORTS
M12

LEVELLING VALVE SERVICES 0500005006
23D004 KIT D63RK016A



PORTS
M12

LEVELLING VALVE SERVICES 0500005007
23D005 KIT D63RK016A



PORTS
M12

LEVELLING VALVE SERVICES 0500005001
23D023 KIT D63RK016A



PORTS
M12

LEVELLING VALVE SERVICES 0500005002
23D024 KIT D63RK016A

PORTS
M12

IN DEVELOPMENT

LEVELLING VALVE SERVICES 0500005012
23D068 KIT D63RK016A



PORTS
M12

LEVELLING VALVE SERVICES 0500005104
23D069 KIT D63RK016A

CHECK OUR WEB SITE FOR SUITABILITY OF THESE AND OTHER PARTS, OR CONTACT US.
ALL PARTS OFFERED ARE MAJORSELL BRAND AND MAY NOT BE OF AN ORIGINAL SUPPLY.
ORIGINAL PART NUMBERS ARE USED FOR REFERENCE ONLY. **CHECK ALL APPLICATIONS.**



Fax ++44 121 455 0272

sales@majorsell.co.uk

www.majorsell.co.uk



MISCV002.1

V
A
L
V
E
S



PORTS
M12

LEVELLING VALVE SERVICES 0500005105
23D070 KIT D63RK016A



PORTS
M12

LEVELLING VALVE SERVICES 0500005101
23D075 KIT D63RK016A



PORTS
M12

LEVELLING VALVE SERVICES 0500005102
23D076 KIT D63RK016A



PORTS

RELAY VALVE SERVICES 0481026022
23D085 KIT D63RK002A



PORTS

NON R.V. SERVICES 0500100006
23E011 KIT x

PORTS

SERVICES
KIT

PORTS

SERVICES
KIT

PORTS

SERVICES
KIT

PORTS

SERVICES
KIT

PORTS

SERVICES
KIT

VALVE KITS FOR BOSCH

MISCV003

VALVES



SERVICES 1487010059
D63RK001A 1487010168



SERVICES 1487010101
D63RK002A 1487010066



SERVICES 1487010170
D63RK007A 1487010088



SERVICES 1487010171
D63RK008A 1487010106

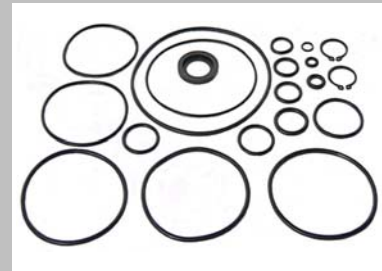

SERVICES 1487010151
D63RK009



SERVICES 1487010239
D63RK010A 1487010146



SERVICES 1487010208
D63RK011A



SERVICES 1487010207
D63RK012A 1487010206



D63RK014A EARLY TYPES



SERVICES 1487010299
D63RK015A 1487010301



SERVICES 1507010007
D63RK016A



CHECK OUR WEB SITE FOR SUITABILITY OF THESE AND OTHER PARTS, OR CONTACT US.
 ALL PARTS OFFERED ARE MAJORSELL BRAND AND MAY NOT BE OF AN ORIGINAL SUPPLY.
 ORIGINAL PART NUMBERS ARE USED FOR REFERENCE ONLY. **CHECK ALL APPLICATIONS.**



Fax ++44 121 455 0272 sales@majorsell.co.uk www.majorsell.co.uk



MISCV003.1

VALVE KITS

V
A
L
V
E
S



SERVICES 75961102

D65RK003A



SERVICES 950351008

D65RK010A



SERVICES 950351004

D65RK011A



SERVICES 950351007

D65RK012A



SERVICES 1111995000

D65RK015A



SERVICES 1487010199

E63RK001A



SERVICES 1487010139

E63RK002A



IN DEVELOPMENT

SERVICES 2J19

H60RK001



IN DEVELOPMENT

SERVICES 2J8

H60RK002



FOOTBRAKE VALVES

MISCV004

V
A
L
V
E
S



PORTS

SERVICES 320060112

23J074 KIT J65RK001



SERVICES 320060***

J65RK001 320062*** 320063***



CHECK OUR WEB SITE FOR SUITABILITY OF THESE AND OTHER PARTS, OR CONTACT US.

ALL PARTS OFFERED ARE MAJORSELL BRAND AND MAY NOT BE OF AN ORIGINAL SUPPLY.

ORIGINAL PART NUMBERS ARE USED FOR REFERENCE ONLY. **CHECK ALL APPLICATIONS.**



Fax ++44 121 455 0272 sales@majorsell.co.uk www.majorsell.co.uk



MISCV004.1

V
A
L
V
E
S





MAJORSELL LIMITED

UNIT E SPRINGHILL BUSINESS PARK

EYRE STREET

BIRMINGHAM B18 7AA

UNITED KINGDOM

tel. ++44 (0) 121 4550200

fax. ++44 (0) 121 4550272

sales@major sell.co.uk