

CARROZZERIA

SETTORE SPECCHI

- * **SPECCHI “DAF”** da pagina 001 a pagina 006;
- * **SPECCHI “MAN”** da pagina 007 a pagina 015;
- * **SPECCHI “MERCEDES”** da pagina 016 a pagina 028;
- * **SPECCHI “RENAULT”** da pagina 029 a pagina 034;
- * **SPECCHI “SCANIA”** da pagina 035 a pagina 038;
- * **SPECCHI “VOLVO”** da pagina 039 a pagina 045;
- * **SETTORE “IVECO”** da pagina 046 a pagina 067.

COPPE DI RICAMBIO ..DAF & VOLVO..







COPPA RICAMBIO VOLVO-FORD-BEDFORD-DAF
COLORE NERO

- 300800760** Coppa termica con MORSETTO 24 V
mm 390x205
- 300800761** Coppa con MORSETTO
mm 390x205
- 300800762** Vetro ricambio **termico** 24 V
mm 376x190
- 300800763** Vetro ricambio
mm 376x190



COPPA RICAMBIO VOLVO-FORD-BEDFORD-DAF
COLORE NERO

- 300800764** Coppa termica con MORSETTO 24 V
mm 207x171 
- 300800765** Coppa con MORSETTO
mm 207x171 
- 300800766** Vetro ricambio **termico** 24 V
mm 195x157 
- 300800767** Vetro ricambio
mm 195x157 



COPPA RICAMBIO UNIVERSALE
COLORE NERO

- 300800768** Coppa termica con MORSETTO
UNIVERSALE 24V 
∅ mm 10-20 e mm 260x148
- 300800769** Coppa con MORSETTO
∅ mm 10-20 e mm 260x148

DAF

65 CF, 75 CF,
85 CF, 95 XF
alternativ: 75, 85, 95
03/00 - 04/06
09/92 →



CODICE		II e1 02★0423 II E1 010423	Truck II	ABS	Ø 28 mm		
				DESCRIZIONE			
300800110					24 V	384 x 205 x 120	specchio completo DX/SX riscaldato c/cavo MAN XF 95
300800112		1800	24 V	PTC		368 x 189 x 40	vetro riscaldato DAF XF95/NEOMAN
300800113						367 x 187 x 60	calotta XF95/NEOMAN
300800111					24 V	384 x 205 x 120	completo SX/DX riscaldato elettrico con cavo
300800112		1800	24 V	PTC		368 x 189 x 40	vetro riscaldato DAF XF95/NEOMAN
300800113						367 x 187 x 60	calotta XF95/NEOMAN

65 CF, 75 CF,
85 CF, 95 XF
alternativ: 75, 85, 95
03/00 - 04/06
09/92 →



CODICE		IV e1 02★0424 IV E1 010424 IV e1 03★0023	Truck IV	ABS	Ø 28 mm		
				DESCRIZIONE			
300800121					24 V	219 x 170 x 120	grandangolo manuale DX/SX riscaldato c/cavo
300800123		300	24 V	17 W		203 x 154 x 36	vetro grandangolo riscaldato
300800124						210	cavo bipolare attacco 90° rotondo
300800125						203 x 154 x 60	calotta grandangolo SX/DX
300800120					24 V	219 x 170 x 120	grandangolo manuale DX/SX riscaldato c/cavo
300800122		400	24 V	17 W		203 x 154 x 36	vetro grandangolo riscaldato
300800124						210	cavo bipolare attacco 90° rotondo
300800125						203 x 154 x 60	calotta grandangolo SX/DX

65 CF, 75 CF,
85 CF, 95 XF
alternativ: 75, 85, 95
03/00 →
09/92 →



CODICE		IV e1 03★0014	Truck IV	ABS	Ø 28 mm		
				DESCRIZIONE			
300800130				24 V	300	209 x 218 x 136	grandangolo manuale DX/SX riscaldato
300800131		300	24 V	R		204 x 195 x 58	vetro grandangolo riscaldato
300800124						210	cavo bipolare, attacco 90° rotondo
300800132						202 x 194 x 55	calotta grandangolo

S Specchio secondo la direttiva CEE 2003/97 o CEE 2007/38

DAF

NEW
XF 105 / XC
CF

01/2006 →
05/2006 →



DAF			
CODICE	II e1 03★0007		ABS Ø 40 mm
		DESCRIZIONE	
300800375		411 x 228 x 140	specchio manuale DX/SX riscaldato DAF XF/CF
300800376		411 x 228 x 140	specchio elettrico DX/SX riscaldato DAF XF/CF
300800377		363 x 177 x 15	vetro riscaldato DX/SX CF/XF 105 (CE/97)
300800378		411 x 228 x 110	calotta DX/SX DAF CF/XF 105

NEW



DAF			
CODICE	IV e1 03★0008		ABS Ø 40 mm
		DESCRIZIONE	
300800380		239 x 221 x 140	grandangolo manuale DX/SX riscaldato DAF CF/XF
300800381		239 x 221 x 140	grandangolo elettrico DX/SX riscaldato DAF CF/XF
300800382		207 x 161 x 15	vetro grandangolo riscaldato DX/SX CF/XF 105 (CE/97)
300800383		239 x 221 x 118	calotta grandangolo DAF CF/XF 105

LF 45 / 55
03/00 - 05/06



1

DAF			
CODICE	II e3 02★56297 II E3 0156297 ECE		ABS Ø 22 mm
		DESCRIZIONE	
300800140		395 x 205 x 145	specchio completo DX/SX manuale DAF
300800141		380 x 190 x 35	vetro DAF
300800142		395 x 205 x 145	specchio completo riscaldato manuale DX/SX
300800143		380 x 190 x 35	vetro riscaldato
300800144		395 x 205 x 145	specchio completo riscaldato elettrico DX/SX
300800143		380 x 190 x 35	vetro riscaldato
300800147		382 x 193 x 85	specchio completo manuale riscaldato DX/SX



2









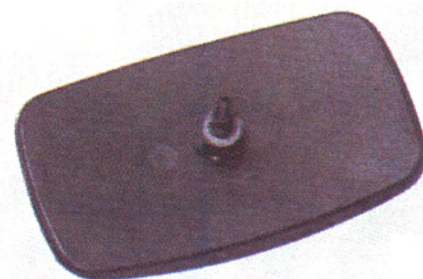













Specchio secondo la direttiva CEE 2003/97 o CEE 2007/38

300800419 SPECCHIO COMPLETO MAN 420x220 mm



300800420 COPPA DAF 257x152



					
				DESCRIZIONE	
300800415	   	373 x 190 x 3	vetro DX/SX DAF/FORD/VOLVO		
300800416	    	373 x 190 x 3	vetro riscaldato DX/SX DAF/FORD/VOLVO		
					
				DESCRIZIONE	
300800417	   	193 x 156 x 3	vetro grandangolo DX/SX DAF/FORD/VOLVO		
300800418	    	193 x 156 x 3	vetro grandangolo DX/SX DAF/FORD/VOLVO		

*FA 1700 - FA 3300 1987 →
75 / 85 / 95 09/92 - 02/00*

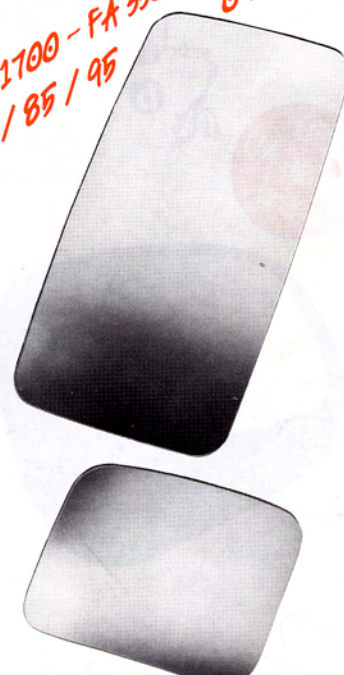

		V VI e1 03★0033 V VI (E1) 020894		Truck	ABS
CODICE		DESCRIZIONE			
XF XC	300800385		319 x 187 x 50	guardaruota manuale DX/SX XF105	
CF	300800387		319 x 187 x 50	guardaruota manuale DX/SX DAF CF '06>	

XF 105 / XC
CF
01/2006 →
05/2006 →

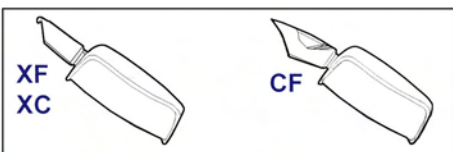
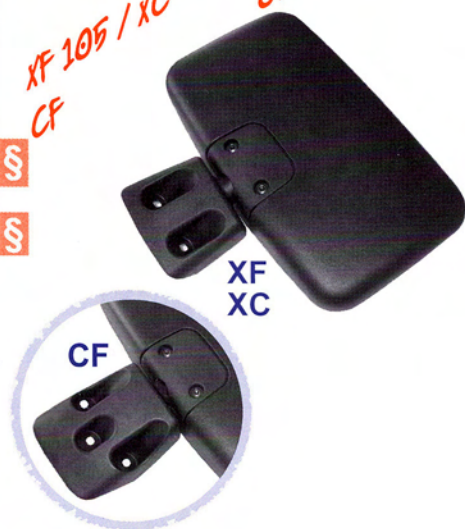

		V VI e1 03★0033 V VI (E1) 020894		Truck	ABS
CODICE		DESCRIZIONE			
XF	59.5525.235H		321 x 405 x 431	**NON ANCORA IN PRODUZIONE**	
	59.5525.236H		321 x 405 x 431	**NON ANCORA IN PRODUZIONE**	
XC	59.5525.331H		256 x 340 x 1037	**NON ANCORA IN PRODUZIONE**	
	59.5525.332H		256 x 340 x 1037	**NON ANCORA IN PRODUZIONE**	
CF	59.5525.131H		419 x 453 x 466	**NON ANCORA IN PRODUZIONE**	
	59.5525.132H		419 x 453 x 466	**NON ANCORA IN PRODUZIONE**	
	59.5525.133H		419 x 343 x 466	**NON ANCORA IN PRODUZIONE**	
	59.5525.134H		419 x 343 x 466	**NON ANCORA IN PRODUZIONE**	
	59.5525.135H		336 x 492 x 466	**NON ANCORA IN PRODUZIONE**	
	59.5525.136H		336 x 492 x 466	**NON ANCORA IN PRODUZIONE**	

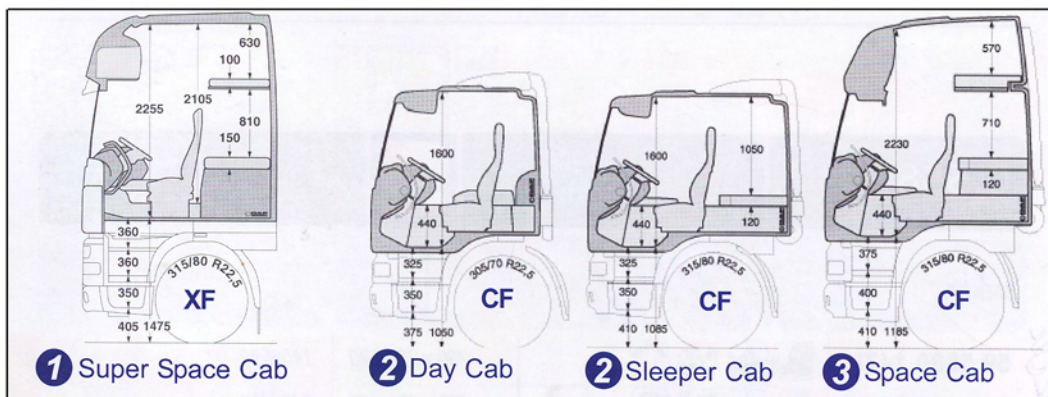

per veicoli ... **a** con aletta parasole **b** senza aletta parasole

§ Specchio secondo la direttiva CEE 2003/97 o CEE 2007/38

DAF

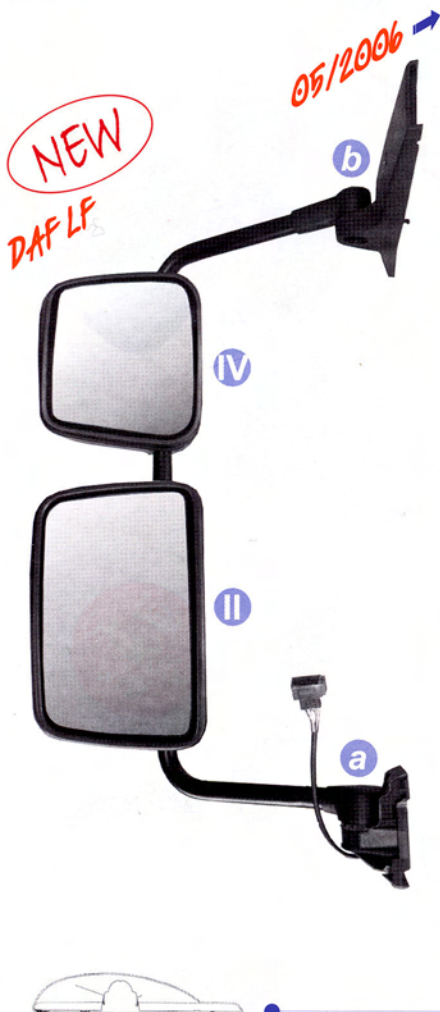

CODICE		II e1 03★0009 IV e1 03★0037	II E1 020914 IV E1 020916	Truck II+IV	ABS	DESCRIZIONE
1	300800750	[Icons]	ca. 880 x 340 x 155	specchio completo c/braccio SX manuale termico		
	300800390	[Icons]	ca. 880 x 340 x 155	completo SX elettrico termico DAF/VOLVO RENAULT '06>		
2	300800751	[Icons]	ca. 880 x 440 x 155	specchio completo c/braccio SX manuale termico		
	300800752	[Icons]	ca. 880 x 440 x 155	specchio completo c/braccio SX termico elettrico II		
	300800391	[Icons]	370 x 245 x 105	coppa principale DX/SX manuale		
	300800392	[Icons]	370 x 245 x 105	coppa principale SX elettrica		
	300800393	[Icons]	230 x 245 x 105	coppa grandangolo SX manuale		
	300800394	[Icons]	337 x 202	vetro principale DX/SX riscaldato		
	300800395	[Icons]	197 x 200	vetro grandangolo SX riscaldato		
	300800396	[Icons]	370 x 247 x 80	calotta principale DAF/RENAULT/VOLVO '06>		
	300800397	[Icons]	244 x 225 x 75	calotta grandangolo DAF/RENAULT/VOLVO '06>		
	300800398	[Icons]	518 x 98	calotta ricambio		

CODICE		V e1 03★0011 V E1 020912	Truck V	ABS	DESCRIZIONE
	300800399	[Icons]	260 x 229 x 70	specchio c/supporto DAF/RENAULT/VOLVO '06>	
	300800400	[Icons]	260 x 229 x 70	guardaruota c/supporto DAF/RENAULT/VOLVO '06>	

Specchio secondo la direttiva CEE 2003/97 o CEE 2007/38

DAF

NEW

05/2006 →

DAF LF

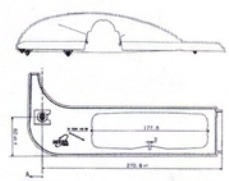
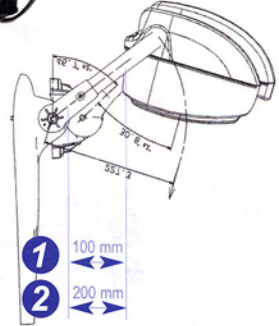
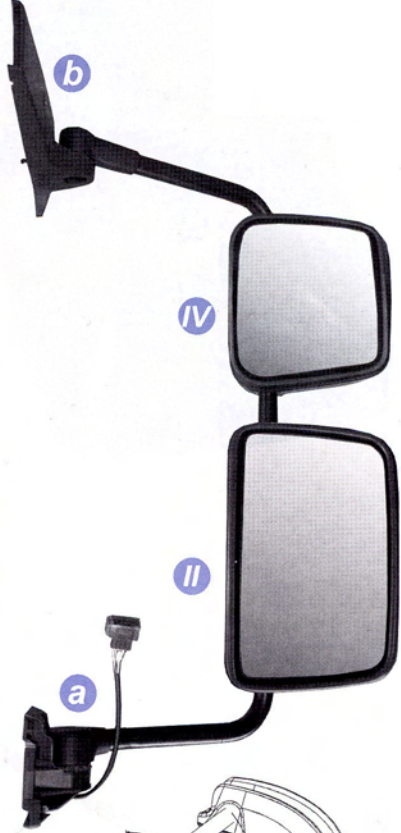

CODICE		II E1 03★0009 II E1 020914 IV E1 03★0037 IV E1 020916	Truck I+IV	ABS	DESCRIZIONE	
1	300800741	[Icons]	24 V	II	ca. 880 x 340 x 155	specchio completo + braccio DX manuale termico
	300800401	[Icons]	24 V	II	ca. 880 x 340 x 155	specchio completo DX elettrico riscaldato DAF
2	300800742	[Icons]	24 V	II	ca. 880 x 440 x 155	specchio completo + braccio DX manuale termico
	300800743	[Icons]	24 V	II	ca. 880 x 440 x 155	specchio completo + braccio DX termico elettrico II
	300800391	[Icons]		II	370 x 245 x 105	coppa principale DX/SX manuale
	300800405	[Icons]		II	370 x 245 x 105	coppa DX elettrica
	300800406	[Icons]	300	IV	230 x 245 x 105	coppa grandangolo DX manuale
	300800394	[Icons]	1200 24 V	II	337 x 202	vetro principale DX/SX riscaldato
	300800407	[Icons]	300 24 V	IV	197 x 200	vetro grandangolo DX riscaldato
	300800396	[Icons]		II	370 x 247 x 80	calotta principale DAF/RENAULT/VOLVO '06>
	300800397	[Icons]		IV	244 x 225 x 75	calotta grandangolo DAF/RENAULT/VOLVO '06>
1	300800744	[Icons]			800 x 270 x Ø 28	braccio DX per veicoli c/guida a SX
	300800745	[Icons]			800 x 270 x Ø 28	braccio DX per veicoli c/guida a DX
2	300800746	[Icons]			800 x 350 x Ø 28	braccio DX per veicoli c/guida a SX
	300800747	[Icons]			800 x 350 x Ø 28	braccio DX per veicoli c/guida a DX
	300800408	[Icons]		a	518 x 98	calotta ricambio DX
	300800409	[Icons]		b	293 x 76	calotta ricambio DX
	300800410	[Icons]		b	293 x 76	calotta ricambio DX

CODICE		V VI E1 03★0033 V VI E1 020894	Truck VI	ABS	DESCRIZIONE	
	300800411	[Icons]			725 x 319 x 126	specchio frontale completo DX/SX manuale
	300800412	[Icons]			319 x 187 x 50	specchio universale DX/SX manuale
	300800413	[Icons]			---	calotta ricambio DX/SX

Specchio secondo la direttiva CEE 2003/97 o CEE 2007/38

MAN / VW 9 90
(6-9+) 10/75 - 07/88



MAN			
0.251 K	II e1 01★14050	Truck II	ABS Ø 14 - 20 mm
		DESCRIZIONE	
300800270		318 x 186 x 26	specchio SX-DX manuale MAN TGA
300800271		308 x 176 x 3	vetro MAN
300800272		312 x 180 x 3	vetro 312x180 MAN
300800274		318 x 186 x 26	specchio MAN SX-DX manuale riscaldato
300800275		308 x 176 x 3	vetro riscaldato MAN
300800276		312 x 180 x 3	vetro 312x180 MAN

10/75 - 07/88

FB, FA



0.364			
II e1 02★14082	II (E1) 0114082	Truck II	PP Ø 14 - 20 mm
		DESCRIZIONE	
300800280		376 x 187 x 28	specchio DX-SX manuale MAN
300800281		364 x 175 x 3	vetro ricambio MAN
300800282		364 x 175 x 3	vetro riscaldato MAN
300800284		376 x 187 x 28	specchio MAN DX-SX riscaldato manuale
300800285		364 x 175 x 3	vetro MAN riscaldato

MAN					
0.267	IV [e1] 02★11014			Ø 14 - 20 mm	
				DESCRIZIONE	
300800290		225 x 172 x 35	coppa guardaruota MAN DX-SX manuale		
300800291		225 x 172 x 35	grandangolo MAN DX-SX manuale riscaldato		

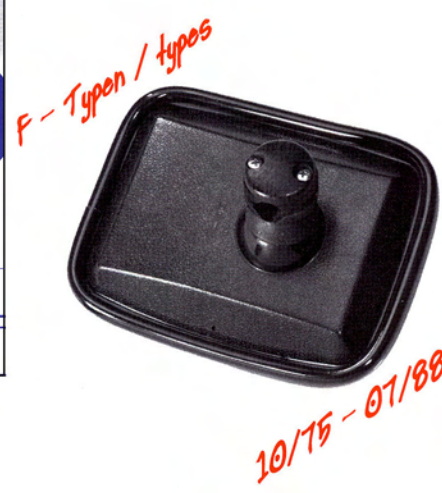

0.268	IV [e1] 02★11013			Ø 10 mm	
				DESCRIZIONE	
300800292		225 x 172 x 33	grandangolo F8/F9 DX-SX manuale		

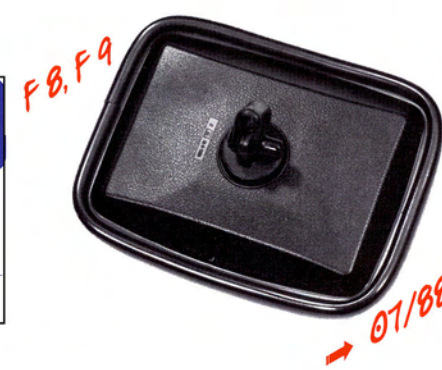

0.260	IV [e1] 02★11001			Ø 14-20 mm	
				DESCRIZIONE	
300800293		205 x 158 x 70	grandangolo MAN M90/F90 DX-SX manuale		
300800294		190 x 143 x 3	vetro grandangolo MAN		
300800295		205 x 158 x 70	grandangolo MAN DX-SX manuale riscaldato		
300800296		190 x 143 x 3	vetro riscaldato grandangolo MAN		



0.156/5 BO	V [e1] 02★12012			Türrahmen • doorframe portière à feuillure • moldura intelaiaitura porta marco de puerta dörram • rám dveří дверная рама • kapi cercevesi	
				DESCRIZIONE	
300800297		250 x 158 x 41	guardaruota MAN UNIVERS. c/supporto, DX-SX manuale		



0.156/2 BO				Türrahmen • doorframe portière à feuillure • moldura intelaiaitura porta marco de puerta dörram • rám dveří дверная рама • kapi cercevesi	
				DESCRIZIONE	
300800298		250 x 150 x 25	guardaruota MAN completo di supporto DX-SX manuale		



MAN						
0.266		IV 02★11008 IV 0111008		① Ø 14 - 20 mm ② Ø 20 - 30 mm		
					DESCRIZIONE	
1	300800365			215 x 165 x 55	grandangolo MAN M90-F90 '88> manuale DX-SX	
	300800367			200 x 150 x 3	vetro grandangolo MAN	
1	300800368			215 x 165 x 55	specchio MAN DX-SX riscaldato manuale	
	300800369			200 x 150 x 3	vetro riscaldato grandangolo MAN	

M 90, F 90
08/88 - 09/94





		MAN		0.300/0.310 0.320		II e1 02★14054 II e1 02★14053 II E1 0114053	Truck II	ABS	① Ø 14 - 20 mm ② Ø 18 - 30 mm	
								DESCRIZIONE		
1	300800310								380 x 190 x 100	coppa DX-SX manuale
	300800311								366 x 176 x 3	vetro IVECO/MAN/VOLVO
	300800312								380 x 190 x 100	coppa termica DX-SX riscaldata manuale
	300800313								366 x 176 x 3	vetro riscaldata IVECO/MAN/VOLVO
	300800314								380 x 190 x 100	coppa elettrica termica DX-SX
	300800315								366 x 176 x 3	specchio MAN riscaldata
	300800316						→ 95		---	set di cavi per uno specchio elettrico
	300800317						→ 95		---	set di cavi per 2 specchi elettrici (cavo, interruttore)
2	300800318								380 x 190 x 100	specchio MAN DX-SX elettrico riscaldata
	300800315								366 x 176 x 3	specchio MAN riscaldata
	300800316						→ 95		---	set di cavi per uno specchio elettrico
	300800317						→ 95		---	set di cavi per 2 specchi elettrici (cavo, interruttore)



		0.340 0.341		II e1 02★14098 II E1 0114098	Truck II	ABS	① Ø 14 - 20 mm ② Ø 20 - 30 mm	
						DESCRIZIONE		
1	300800320						377 x 189 x 65	specchio MAN DX-SX manuale
2	300800281						364 x 175 x 3	vetro ricambio MAN
1	300800321						377 x 189 x 65	specchio MAN DX-SX termico manuale
2	300800285						364 x 175 x 3	specchio MAN riscaldata
1	300800323						377 x 189 x 65	coppa elettrica DX-SX riscaldata
	300800285						364 x 175 x 3	specchio MAN riscaldata
	300800316						→ 77	set di cavi per uno specchio elettrico
	300800317						→ 77	set di cavi per 2 specchi elettrici (cavo, interruttore)

F 2000, L 2000,
M 2000
09/94
09/97



● specchio principale & coppa grandangolo:
vista superiore della carcassa e sezione del vetro

		II E1 02★0524 II E1 010524 03★0022 010423 02★0423 020923 03★0088 020905		Truck II	ABS	Ø 22 mm
				mm		DESCRIZIONE
300800210		b	384 x 205 x 120			specchio SX MAN F2000 manuale
300800211			368 x 189 x 40			vetro MAN F2000
300800212		a	384 x 205 x 120			specchio SX MAN F2000 manuale
300800213			368 x 189 x 40			vetro MAN F2000
300800214		b	384 x 205 x 120			specchio DX MAN F2000 manuale
300800211			368 x 189 x 40			vetro MAN F2000
300800215		a	384 x 205 x 120			specchio DX MAN F2000 manuale
300800213			368 x 189 x 40			vetro MAN F2000
300800216		b	384 x 205 x 120			specchio SX RISCALDATO manuale MAN F2000
300800217			368 x 189 x 40			vetro riscaldato MAN F2000
300800218		a	384 x 205 x 120			specchio SX MAN F2000 riscaldato manuale
300800219			368 x 189 x 40			vetro riscaldato MAN F2000
300800220		b	384 x 205 x 120			specchio DX MAN F2000 riscaldato manuale
300800217			368 x 189 x 40			vetro riscaldato MAN F2000
300800221		a	384 x 205 x 120			specchio DX MAN F2000 riscaldato manuale
300800219			368 x 189 x 40			vetro riscaldato MAN F2000
300800222		b	384 x 205 x 120			specchio SX riscaldato elettrico MAN F2000
300800217			368 x 189 x 40			vetro riscaldato MAN F2000
300800223		a	384 x 205 x 120			specchio SX riscaldato elettrico MAN F2000
300800219			368 x 189 x 40			vetro riscaldato MAN F2000
300800224		b	384 x 205 x 120			specchio DX riscaldato elettrico MAN F2000
300800217			368 x 189 x 40			vetro riscaldato MAN F2000
300800225		a	384 x 205 x 120			specchio DX riscaldato elettrico MAN F2000
300800219			368 x 189 x 40			vetro riscaldato MAN F2000
300800226		a	374 x 196 x 40			calotta MAN F2000
300800227		b	367 x 187 x 60			calotta specchio MAN F2000



● versione OEM



● versione libera

§ **Specchio secondo la direttiva CEE 2003/97 o CEE 2007/38**

03/00
2005
04/06

TGA
TEL
TEM

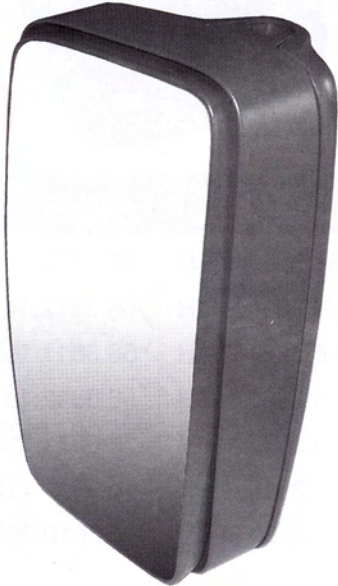

2 + 2

il dispositivo di bloccaggio deve essere ordinato separatamente.

b

0.373
0.386

● versione libera

*
altre larghezze su richiesta

200
760
880

MAN			
0.392 0.392-1	II e1 02★0646 II E1 010646 II e1 03★0024	Truck II ABS	Ø 28 mm
		DESCRIZIONE	
300800327		399 x 207 x 137	completo TGA SX elettrico riscaldato
300800328		379 x 176 x 47	vetro TGA SX riscaldato
300800326		399 x 222 x 138	completo TGA DX elettrico riscaldato
300800328		379 x 176 x 47	vetro TGA DX riscaldato
300800330	für for pour &	57 x 23 x 30	staffa per MAN TGA
300800331		Ø 6 x 30	viti per staffa MAN TGA
300800332		399 x 196 x 52	calotta TGA SX
300800333		399 x 210 x 52	calotta TGA DX

alt previous neu current

392		St	Ø 28 mm
		DESCRIZIONE	
300800334		880 x 200 x Ø 28	braccio SX MAN
300800335		880 x 200 x Ø 28	braccio DX MAN

§ Specchio secondo la direttiva CEE 2003/97 o CEE 2007/38

0.393
0.393-1

IV [e1] 02★0647
IV [E1] 010647
IV [e1] 03★0025



Ø 28 mm



DESCRIZIONE

§	300800820					a	188 x 207 x 129	specchio completo SX manuale termico
	300800342					b	188 x 207 x 129	grandangolo TGA SX elettrico riscaldato
	300800343						177 x 167 x 38	vetro grandangolo DX/SX riscaldato TGA/TGM
§	300800821					a	188 x 220 x 130	specchio completo DX manuale termico
	300800346					b	188 x 220 x 130	grandangolo TGA DX elettrico riscaldato
	300800343						177 x 167 x 38	vetro grandangolo DX/SX riscaldato TGA/TGM
	300800330						57 x 23 x 30	staffa per MAN TGA
	300800822						117 x 62 x 9	staffa per MAN TGA
	300800331						Ø 6 x 30	viti per staffa MAN TGA
	300800347						187 x 197 x 52	calotta grandangolo TGA SX
	300800348						187 x 209 x 52	calotta grandangolo TGA DX

TGA
TEL
TGM

03/00
2005
04/06



0.394
0.394-1

V [e1] 02★12015
V [E1] 0112015
V [e1] 03★0015



Türrahmen • doorframe
portière à feuillure • moldura
intelaiaura porta
marco de puerta
dórram • rám dveří
дверная рама • kapi çerçevesi



DESCRIZIONE

§	300800350						324 x 185 x 80	specchio completo c/supporto DX/SX manuale
	300800351						324 x 185 x 15	vetro di ricambio c/supporto plastico
§	300800353						324 x 185 x 80	specchio completo c/supporto DX/SX elettrico termico
	300800354						324 x 185 x 15	vetro guardaruota riscaldato TGA/TGL/TGM

TGA
TEL
TGM

03/00
2005
04/06



§ Specchio secondo la direttiva CEE 2003/97 o CEE 2007/38

MAN

NEW
TQ-L, TQ-M (TQ-A)
L2000
06/2005
06/2005



MAN			
0.572	II [e1] 03★0031 II (E1) 020918	Truck C	ABS 1 Ø 22 mm 2 Ø 28 mm
		mm	
1			426 x 200 x 135
2			426 x 200 x 135
			412 x 188 x 3
1	300800355		426 x 200 x 135
	300800356		412 x 188 x 3
	300800357		426 x 200 x 135
	300800358		426 x 200 x 135
	300800359		412 x 188 x 3
			426 x 200 x 135
			426 x 200 x 135
			412 x 188 x 3

NEW
TQ-L, TQ-M (TQ-A)
L2000
07/2005
06/2005



0.573			
IV [e1] 03★0032 IV (E1) 020917	Truck IV	ABS	1 Ø 22 mm 2 Ø 28 mm
	mm		
1	300800370		202 x 198 x 126
2	300800371		202 x 198 x 126
	300800360		190 x 184
1	300800361		202 x 198 x 126
	300800362		190 x 184

NEW
TQ-L, TQ-M (TQ-A)
07/2005



0.389			
IV [e1] 03★0016	Truck VI	ABS	INTEGR.
	mm		
			520 x 259 x 92
	300800363		520 x 259 x 92
			Ø 259 x 92
			Ø 259 x 2

Specchio secondo la direttiva CEE 2003/97 o CEE 2007/38

*SK (NG 90/I)
08/88 - 12/90*

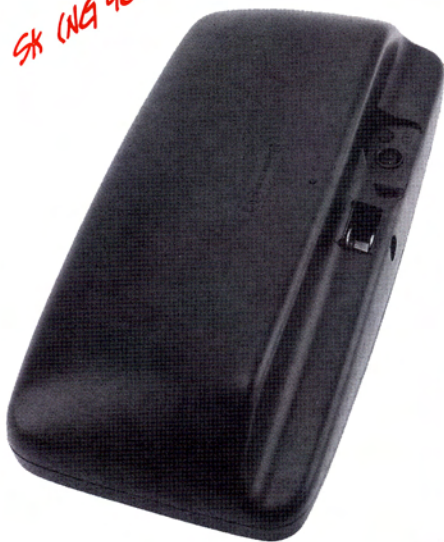

MERCEDES			
0.282	II e1 02★14083 II E1 0114083	Truck II ABS	Ø 22 mm
		DESCRIZIONE	
300800525		430 x 216 x 105	specchio MERCEDES DX/SX manuale
300800526		417 x 197 x 3	vetro ricambio
300800527		430 x 216 x 105	specchio MERCEDES DX/SX termico manuale
300800528		417 x 197 x 3	vetro ricambio termico
300800529		430 x 216 x 105	specchio MERCEDES DX/SX elettrico termico
300800530		402 x 181 x 2	vetro ricambio termico
300800531		---	dispositivo di bloccaggio c/vite

*Transporter 207 D - 410 (T1, TN)
08/81 - 02/95*



1
0.249 L



2
0.249 L (14-20)

MERCEDES			
0.249 L 0.249 L (14-20)	II e1 02★14035 II E1 0114035	Truck II PP	① Ø 10 mm ② Ø 14 - 20 mm
		DESCRIZIONE	
300800500		247 x 157 x 61	specchio MERCEDES DX/SX manuale
300800501		247 x 157 x 61	specchio MERCEDES DX/SX manuale termico
300800502		247 x 157 x 61	specchio MERCEDES DX/SX manuale
300800503		247 x 157 x 61	specchio MERCEDES DX/SX manuale termico



Specchio secondo la direttiva CEE 2003/97 o CEE 2007/38

MERCEDES

0.253

II e1 02★14067
II E1 0114067



Ø 18 mm



DESCRIZIONE

300800504		370 x 182 x 64	specchio MERCEDES DX/SX manuale
300800505		356 x 170 x 3	vetro ricambio
300800506		370 x 182 x 64	specchio MERCEDES DX/SX manuale termico
300800507		356 x 170	vetro ricambio

1013-2644
EvoBus
0 303. 404, 405, 407

08/73 - 12/86



0.254

II e1 01★14068



Ø 18 mm



DESCRIZIONE

300800508		305 x 183 x 60	specchio MERCEDES DX/SX manuale
300800509		293 x 172 x 3	vetro ricambio
300800510		305 x 183 x 60	specchio MERCEDES DX/SX manuale termico
300800511		293 x 172 x 3	vetro termico di ricambio
300800512		305 x 183 x 60	specchio MERCEDES DX/SX manuale termico
300800513		293 x 172 x 3	vetro termico di ricambio

LK08 - 1113
LN 2 (LK)

11/77 →
→ 12/98



Specchio secondo la direttiva CEE 2003/97 o CEE 2007/38

MERCEDES

0.258		II 02★14069 II 0114069		Ø 18 mm
		DESCRIZIONE		
300800514		423 x 203 x 72	specchio MERCEDES DX/SX manuale	
300800515		408 x 186 x 3	vetro ricambio	
300800516		423 x 203 x 72	specchio MERCEDES DX/SX manuale termico	
300800517		408 x 186 x 3	vetro ricambio termico	
300800518		423 x 203 x 72	specchio MERCEDES DX/SX elettrico termico	

*2422 - 2635
Evolbus 0 303 / 0 304
05/82 - 08/94
02/83 - 06/93*



0.285		IV 02★11012 IV 0111012		Ø 18 mm
		DESCRIZIONE		
300800519		184 x 184 x 54	specchio MERCEDES DX/SX manuale	
300800520		171 x 171 x 3	vetro ricambio	
300800521		184 x 184 x 54	specchio MERCEDES DX/SX manuale termico	
300800522		171 x 171 x 3	vetro termico ricambio	

*Lk B14
Evolbus 0 303 / 0 304
11/87 →
02/83 - 06/93*



Specchio secondo la direttiva CEE 2003/97 o CEE 2007/38

MERCEDES				
0.283	IV (E1) 010392		ABS	Ø 22 mm
				DESCRIZIONE
300800532		216 x 196 x 64	specchio MERCEDES DX/SX manuale	
300800533		206 x 188 x 3	vetro ricambio	
300800534		216 x 196 x 64	specchio MERCEDES DX/SX manuale termico	
300800535		206 x 188 x 3	vetro ricambio termico	
300800536		---	dispositivo di bloccaggio v/vite	

08/88 - 12/90
SK (NG 90/I)



für Normalkabine
for normal cabin
pour cabine normale
para cabine normale
per cabina normale
für normal kabin
pro normalní kabiny
для нормальной кабины
normal kabinler için

0.284				
V (E1) 02★12003 V (E1) 0112003		ABS	Türrahmen • doorframe portière à feuillure • moldura intelaiaura porta marco de puerta dörram • rám dveří дверная рама • kabin çerçevesi	
				DESCRIZIONE
300800537		340 x 173 x 80	specchio MERCEDES DX/SX manuale	
300800538		319 x 163 x 3	vetro ricambio	

08/88 - 12/90
SK (NG 90/I)



§ Specchio secondo la direttiva CEE 2003/97 o CEE 2007/38

SK (NG 90/II)

01/91 - 08/96

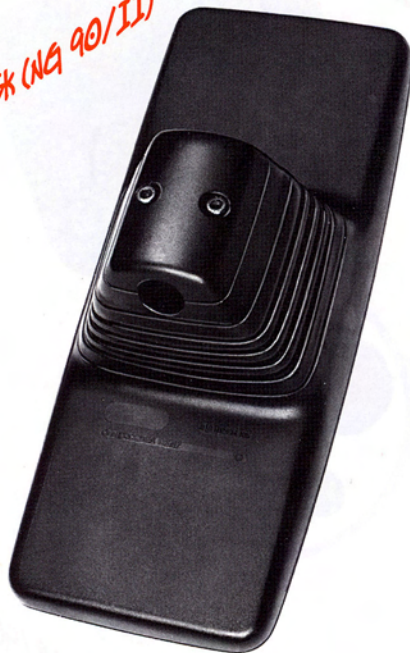

<h1>MERCEDES</h1>			
0.368	II e1 02★14123 II (E1) 0114123	Truck II	ABS
			Ø 28 mm
			DESCRIZIONE
300800540		440 x 182 x 132	specchio MERCEDES DX/SX manuale termico
300800541		427 x 169 x 3	vetro ricambio
300800542		427 x 169 x 3	vetro ricambio termico
300800543		440 x 182 x 132	specchio MERCEDES DX/SX elettrico termico
300800541		427 x 169 x 3	vetro ricambio
300800542		427 x 169 x 3	vetro ricambio termico

EvoBus O 404

07/93 - 08/99

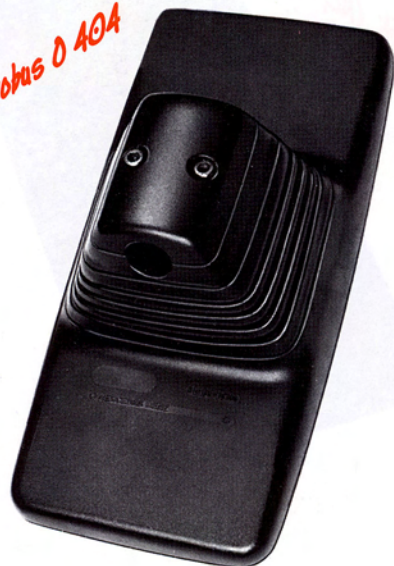

<h1>MERCEDES</h1>			
0.366	II e1 02★14121	Truck II	ABS
			Ø 28 mm
			DESCRIZIONE
300800544		369 x 184 x 132	specchio MERCEDES DX/SX manuale termico
300800545		355 x 170 x 3	vetro ricambio termico
300800546		369 x 184 x 132	specchio MERCEDES DX/SX elettrico termico
300800545		355 x 170 x 3	vetro ricambio termico

MERCEDES					
0.367	IV 02★0394 IV 010394			Ø 28 mm	
				DESCRIZIONE	
300800552		225 x 185 x 129	specchio MERCEDES DX/SX manuale termico		
300800547		209 x 169 x 3	vetro ricambio		
300800548		209 x 169 x 3	vetro termico ricambio		

*SK (NG 90/II)
Evobus 0 404
01/91 - 08/96
07/93 - 08/99*



0.269	V 02★12010 V 0112010			Türrahmen • doorframe portière à feuillure • moldura intelaiaura porta marco de puerta dörram • rám dveří дверная рама • kapi çerçevesi	
				DESCRIZIONE	
1 300800549		294 x 164 x 45	specchio c/supporto MERCEDES DX/SX manuale		
300800550		282 x 152 x 3	vetro ricambio		
2 300800551		294 x 164 x 45	specchio c/supporto MERCEDES DX/SX manuale		
300800550		282 x 152 x 3	vetro ricambio		

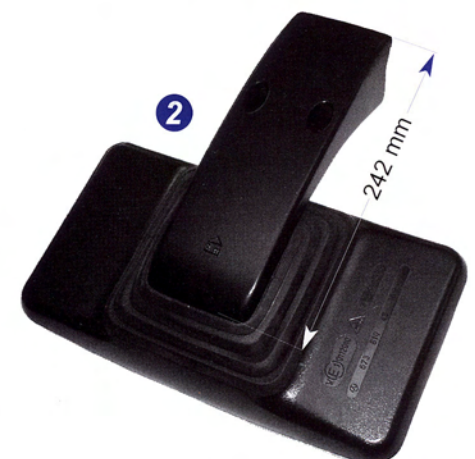

*Actros (SKL) I+II
Econic*

*09/96 →
03/98 →*



<h1>MERCEDES</h1>			
0.378 0.378-1	II 02★0463 II 010463 II 03★0018	II 	Ø 28 mm
		mm	DESCRIZIONE
300800555		433 x 188 x 85	specchio MERCEDES DX/SX manuale termico
300800556		433 x 188 x 68	calotta DX/SX manuale
300800557		433 x 188 x 15	vetro ricambio termico
300800558		74 x 65 x 14	dispositivo di bloccaggio c/vite + calotta
300800559		433 x 188 x 68	specchio MERCEDES DX/SX manuale
300800558		74 x 65 x 14	dispositivo di bloccaggio c/vite + calotta
300800561		433 x 188 x 68	calotta DX/SX elettrica
300800557		433 x 188 x 15	vetro ricambio termico
300800558		74 x 65 x 14	dispositivo di bloccaggio c/vite + calotta
300800562		433 x 188 x 68	specchio MERCEDES DX/SX elettrico
300800558		74 x 65 x 14	dispositivo di bloccaggio c/vite + calotta



0.377 0.377-1			
	IV 02★0462 IV 010462 IV 03★0019	IV 	Ø 28 mm
		mm	DESCRIZIONE
300800564		200 x 200 x 68	calotta DX/SX manuale
300800558		74 x 65 x 14	dispositivo di bloccaggio c/vite + calotta
300800566		200 x 200	specchio MERCEDES DX/SX manuale termico
300800567		200 x 200 x 15	vetro ricambio termico
300800558		74 x 65 x 14	dispositivo di bloccaggio c/vite + calotta

Actros (SKL) I+II 09/96 - 05/07



0.379 0.379-1			
	V 02★0464 V 010464 V 03★0013	V 	Türrahmen • doorframe portière à feuillure • moldura intelaiatura porta marco de puerta dörram • ram dveří дворяная рама • kapı çerçevesi
		mm	DESCRIZIONE
300800432		310 x 170 x 83	specchio c/supporto DX/SX manuale
300800433		310 x 170 x 15	vetro ricambio

Specchio secondo la direttiva CEE 2003/97 o CEE 2007/38

MERCEDES

0.579	V [e1] 03★0109			<small>Türrahmen • doorframe portière à feuillure • moldura intelaiaura porta marco de puerta dórram • rám dveří дверная рама • karp çerçevesi</small>
--------------	----------------	--	--	--

DESCRIZIONE

300800434			303 x 163	specchio c/supporto DX/SX manuale
300800576			303 x 163	vetro ricambio



0.360 0.360-1	V [e1] 02★12013 V [E1] 0112013 03★0039 020973			INTEGR.
--------------------------------	--	--	--	----------------

DESCRIZIONE

300790087			284 x 174 x 62	specchio MERCEDES DX/SX manuale
300790088			284 x 174 x 64	specchio MERCEDES DX/SX manuale termico
300790083			272 x 162 x 3	vetro ricambio termico



378				Ø 28 mm
------------	--	--	--	----------------

DESCRIZIONE

1	300800581		983 x 197 x Ø 28	braccio SX
	300800582		983 x 197 x Ø 28	braccio DX
2	300800583		983 x 227 x Ø 28	braccio SX
	300800584		983 x 227 x Ø 28	braccio DX
	300800585		---	calotta DX/SX

La calotta di plastica per il supporto inferiore del braccio deve essere ordinata separatamente.

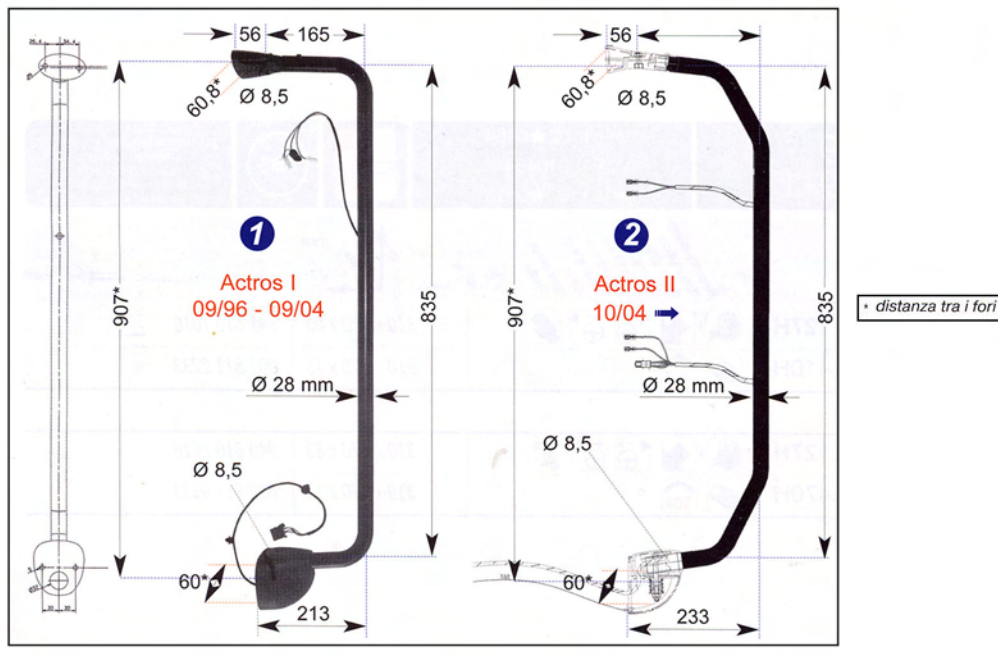

§ Specchio secondo la direttiva CEE 2003/97 o CEE 2007/38

MERCEDES			
0.375	II 02★0505 II 010505		Ø 28 mm
			DESCRIZIONE
300800586		380 x 170 x 68	calotta MERCEDES DX/SX manuale
300800587		380 x 170 x 15	vetro ricambio termico
300800558		74 x 65 x 14	dispositivo di bloccaggio c/vite + calotta
300800589		380 x 170 x 68	calotta MERCEDES DX/SX elettrica
300800587		380 x 170 x 15	vetro ricambio termico
300800558		74 x 65 x 14	dispositivo di bloccaggio c/vite + calotta

0.377 0.377-1			
IV 02★0462 IV 010462 IV 03★0019			Ø 28 mm
			DESCRIZIONE
300800563		200 x 200	specchio MERCEDES SX manuale termico
300800564		200 x 200 x 68	calotta SX manuale
300800558		74 x 65 x 14	dispositivo di bloccaggio c/vite + calotta
300800566		200 x 200	specchio MERCEDES DX manuale termico
300800567		200 x 200 x 15	vetro ricambio termico
300800558		74 x 65 x 14	dispositivo di bloccaggio c/vite + calotta

0.379 0.379-1			
V 02★0464 V 010464 V 03★0013			Türrahmen • doorframe portière à feuillure • moldura intelaiaura porta marco de puerta dörram • rám dveří дверная рама • Kapı çerçevesi
			DESCRIZIONE
300800432		310 x 170 x 83	specchio c/supporto DX/SX manuale
300800433		310 x 170 x 15	vetro ricambio

*Atogo (LKW)
Axor*

*01/98 - 09/04
09/01 - 09/04*



Specchio secondo la direttiva CEE 2003/97 o CEE 2007/38

MERCEDES

0.575

II [e1] 03★0002



Ø 28 mm



DESCRIZIONE

*Atogo II (Lkn)
Axor II
10/04 →
10/04 →*



*10/04 - 05/07
10/04 - 05/07*

*Atogo II (Lkn)
Axor II*



*06/07 →
06/07 →*

**NEU
NOUVEAU
NEW**

*Atogo II (Lkn)
Axor II*



\$	300800590				435 x 215 x 129	specchio MERCEDES SX manuale termico
	300800591				435 x 215 x 129	specchio MERCEDES SX elettrico termico
\$	300800592				435 x 215 x 129	specchio MERCEDES DX manuale termico
	300800593				435 x 215 x 129	specchio MERCEDES DX elettrico termico
\$	300800594				431 x 186 x 15	vetro ricambio termico
	300800595					dispositivo di bloccaggio c/vite + calotta

0.577

IV [e1] 03★0003



Ø 28 mm



DESCRIZIONE

\$	300800596					215 x 199 x 129	specchio MERCEDES DX/SX manuale termico
	300800597					192 x 186 x 15	vetro termico ricambio
	300800595						dispositivo di bloccaggio c/vite + calotta

0.379
0.379-1

V [e1] 02★0464
V [E1] 010464
V [e1] 03★0013



Türrahmen • doorframe
portière à feuillure • moldura
intelaiatura porta
marco de puerta
dörram • rám dveří
дверная рама • kapi çerçevesi



DESCRIZIONE

\$	300800432				310 x 170 x 83	specchio c/supporto DX/SX manuale
	300800433				310 x 170 x 15	vetro ricambio

0.579

V [e1] 03★0109



Türrahmen • doorframe
portière à feuillure • moldura
intelaiatura porta
marco de puerta
dörram • rám dveří
дверная рама • kapi çerçevesi



DESCRIZIONE

\$	300800434				303 x 163	specchio c/supporto DX/SX manuale
	300800576				303 x 163	vetro ricambio

\$ **Specchio secondo la direttiva CEE 2003/97 o CEE 2007/38**

MERCEDES

375



Ø 28 mm



DESCRIZIONE

300800600		639 x 325 x Ø 28	braccio SX per veicoli con guida SX
300800601		639 x 325 x Ø 28	braccio DX per veicoli con guida SX
300800602		639 x 325 x Ø 28	braccio SX per veicoli con guida a DX
300800603		639 x 325 x Ø 28	braccio DX per veicoli con guida DX
300800604		---	calotta SX per veicoli con guida DX/SX
300800605		---	calotta DX per veicoli con guida DX/SX

* La calotta di plastica per il supporto inferiore del braccio deve essere ordinata separatamente.

*Atogo (Lkn)
Axor*

*01/98 - 09/04
09/01 - 09/04*

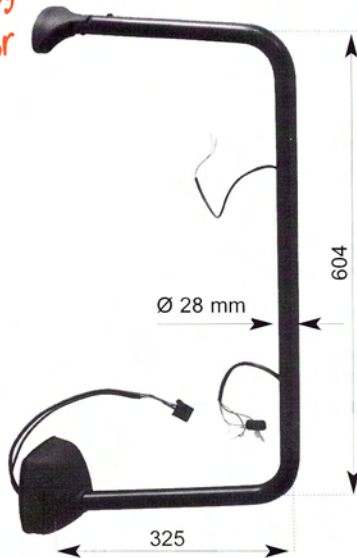

575



Ø 28 mm



DESCRIZIONE

300800606		795 x 410 x Ø 28	braccio SX per veicoli con guida SX
300800607		795 x 410 x Ø 28	braccio DX per veicoli con guida SX
300800608		795 x 410 x Ø 28	braccio SX per veicoli con guida DX
300800609		795 x 410 x Ø 28	braccio DX per veicoli con guida DX

*Atogo II (Lkn)
Axor II*

*10/04 →
10/04 →*

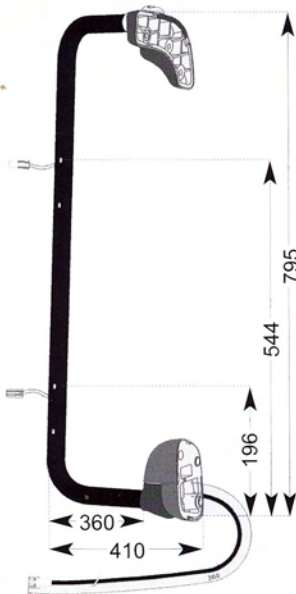

MERCEDES

0.396

VI 03★0017



INTEGR.



DESCRIZIONE

1	300800610		1261 x 303 x ø 250	guardavanti c/braccio DX riscaldato	§
	300800611		1261 x 303 x ø 250	guardaruota c/braccio SX riscaldato	
2	300800612		1145 x 265 x ø 250	guardavanti c/braccio DX riscaldato	§
	300800613		1145 x 265 x ø 250	guardaruota c/braccio SX riscaldato	
3	300800614		1219 x 303 x ø 250	guardavanti c/braccio DX riscaldato	§
	300800615		1219 x 303 x ø 250	guardaruota c/braccio SX riscaldato	
1-3	300800616		ø 250 x 130	specchio DX/SX termico	§
	300800617		ø 250 x 85	coppa ricambio DX/SX	
	300800618		ø 250 x 45	vetro ricambio termico	
	300800558		---	dispositivo di bloccaggio c/vite + calotta	
4	300800620		1217 x 285 x ø 259	guardavanti c/braccio DX	§
	300800621		92 x ø 259	specchio completo	

NEU
NOUVEAU
NEW

Atego (LKW) / Axor 01/98 - 09/04
Atego II / Axor II 10/04
Actros (SKL) 09/96 - 09/04
Actros II 10/04

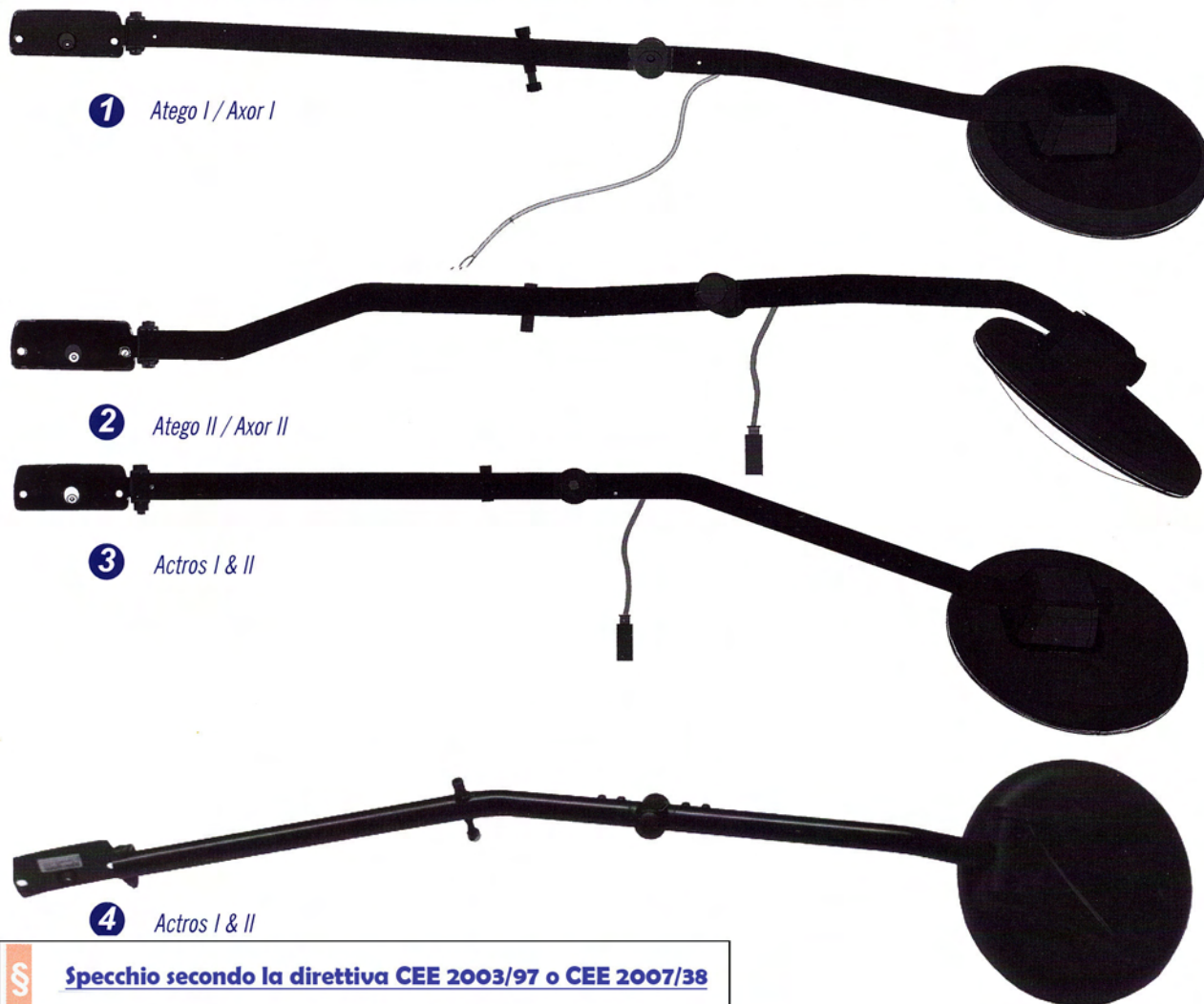

§ Specchio secondo la direttiva CEE 2003/97 o CEE 2007/38

01/95 - 09/05

Sprinter (T1N)



1 KK



2



MERCEDES

0.349
0.349 TW

1 II E1 02★0384
II E 010384
3 II E1 02★0418
II E 010418



1 INTEGR.
3 Ø 18 mm



DESCRIZIONE

1	300800625					283 x 177 x 80	specchio MERCEDES SX manuale
	300800626		1800			238 x 142 x 6	vetro ricambio
	300800627					283 x 177 x 80	specchio MERCEDES DX manuale
	300800628		1800			238 x 142 x 6	vetro ricambio
	300800629					12V	specchio MERCEDES SX elettrico termico
	300800630		1800	12V	PTC	238 x 142 x 6	vetro termico ricambio
	300800631		1800	12V	PTC	238 x 142 x 6	vetro termico asferico
	300800632					12V	specchio MERCEDES DX elettrico termico
	300800633		1800	12V	PTC	238 x 142 x 6	vetro termico ricambio
	300800634		1800	12V	PTC	238 x 142 x 6	vetro termico asferico
2	300800635					175 x 116 x 70	specchio MERCEDES SX manuale
	300800636		240			165 x 93 x 15	vetro ricambio
	300800637					175 x 116 x 70	specchio MERCEDES DX manuale
	300800636		240			165 x 93 x 15	vetro ricambio
3	300800638					PK 1	specchio c/braccio SX manuale
	300800626		1800			238 x 142 x 6	vetro ricambio
	300800639					PK 1	specchio c/braccio DX manuale
	300800628		1800			238 x 142 x 6	vetro ricambio
	300800640					PK 2	specchio c/braccio SX manuale
	300800626		1800			238 x 142 x 6	vetro ricambio
	300800641					PK 2	specchio c/braccio DX manuale
	300800628		1800			238 x 142 x 6	vetro ricambio



Specchio secondo la direttiva CEE 2003/97 o CEE 2007/38

**NEU
NOUVEAU
NEW**

*Midlam 1818
Premium Distribution
Korax*

05/2006
05/2006
05/2006

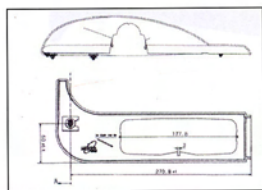
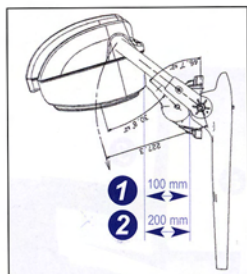

**NEU
NOUVEAU
NEW**



RENAULT

0.390

II e1 03★0009 II E1 020914
IV e1 03★0037 IV E1 020916



II+IV

ABS

INTEGR.



DESCRIZIONE

1	300800770		ca. 880 x 340 x 155	specchio completo SX manuale termico GRIGIO
	300800750		ca. 880 x 340 x 155	specchio completo SX manuale termico NERO
	300800771		ca. 880 x 340 x 155	specchio completo SX termico elettrico II GRIGIO
	300800390		ca. 880 x 340 x 155	specchio completo SX termico elettrico II NERO
2	300800772		ca. 880 x 440 x 155	specchio completo SX manuale termico GRIGIO
	300800751		ca. 880 x 440 x 155	specchio completo SX manuale termico NERO
	300800773		ca. 880 x 440 x 155	specchio completo SX termico elettrico II GRIGIO
	300800752		ca. 880 x 440 x 155	specchio completo SX termico elettrico II NERO
	300800391		370 x 245 x 105	coppa DX/SX termica manuale
	300800392		370 x 245 x 105	coppa SX elettrica termica
	300800393		230 x 245 x 105	coppa SX termica manuale
	300800394		337 x 202	vetro ricambio c/supporto plastico DX/SX termico
	300800395		197 x 200	vetro ricambio c/supporto plastico SX termico
	300800396		370 x 247 x 80	calotta ricambio NERA
	300800774		370 x 247 x 80	calotta ricambio GRIGIA
	300800397		244 x 225 x 75	calotta ricambio NERA
	300800775		244 x 225 x 75	calotta ricambio GRIGIA
1	300800753		800 x 270 x Ø 28	braccio SX per veicoli c/guida a SX
	300800754		800 x 270 x Ø 28	braccio SX per veicoli c/guida a DX
2	300800755		800 x 350 x Ø 28	braccio SX per veicoli c/guida a SX
	300800756		800 x 350 x Ø 28	braccio SX per veicoli c/guida a DX
	300800398		518 x 98	calotta ricambio per braccio SX per veicoli c/guida DX/SX
	300800757		293 x 76	calotta ricambio per braccio SX per veicoli c/guida a SX
	300800758		293 x 76	calotta ricambio per braccio SX per veicoli c/guida a DX

0.558

V e1 03★0011
V E1 020912



ABS

Türrahmen • doorframe
portière à feuillure • moldura
intelaiaura porta
marco de puerta
dörram • rám dveří
дверная рама • karp çerçevesi



DESCRIZIONE

300800400		260 x 229 x 70	specchio completo DX per veicoli c/guida a SX
300800399		260 x 229 x 70	specchio completo SX per veicoli c/guida a DX

Specchio secondo la direttiva CEE 2003/97 o CEE 2007/38

RENAULT

0.390

II e1 03★0009 II E1 020914
IV e1 03★0037 IV E1 020916



INTEGR.



DESCRIZIONE

1	300800776		ca. 880 x 340 x 155	specchio completo DX termico manuale GRIGIO
	300800741		ca. 880 x 340 x 155	specchio completo DX termico manuale NERO
	300800777		ca. 880 x 340 x 155	specchio completo DX termico elettrico II GRIGIO
	300800401		ca. 880 x 340 x 155	specchio completo DX termico elettrico II NERO
2	300800778		ca. 880 x 440 x 155	specchio completo DX termico manuale GRIGIO
	300800742		ca. 880 x 440 x 155	specchio completo DX termico manuale NERO
	300800779		ca. 880 x 440 x 155	specchio completo DX termico elettrico II GRIGIO
	300800743		ca. 880 x 440 x 155	specchio completo DX termico elettrico II NERO
	300800391		370 x 245 x 105	coppa DX/SX termica manuale
	300800405		370 x 245 x 105	coppa DX termica elettrica
	300800406		230 x 245 x 105	coppa DX termica manuale
	300800394		337 x 202	vetro ricambio c/supporto plastico DX/SX termico
	300800407		197 x 200	vetro ricambio c/supporto plastico DX termico
	300800396		370 x 247 x 80	calotta ricambio NERA
	300800774		370 x 247 x 80	calotta ricambio GRIGIA
	300800397		244 x 225 x 75	calotta ricambio NERA
	300800775		244 x 225 x 75	calotta ricambio GRIGIA
1	300800744		800 x 270 x Ø 28	braccio DX per veicoli c/guida a SX
	300800745		800 x 270 x Ø 28	braccio DX per veicoli c/guida a DX
2	300800746		800 x 350 x Ø 28	braccio DX per veicoli c/guida a SX
	300800747		800 x 350 x Ø 28	braccio DX per veicoli c/guida a DX
	300800408		518 x 98	calotta ricambio per braccio DX per veicoli c/guida DX/SX
	300800409		293 x 76	calotta ricambio per braccio DX per veicoli c/guida a SX
	300800410		293 x 76	calotta ricambio per braccio DX per veicoli c/guida a DX

NEU
NOUVEAU
NEW

Midlam 1818
Premium Distribution
Korax

05/2006
05/2006
05/2006

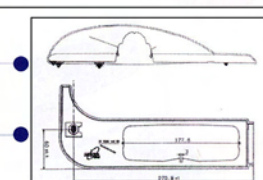
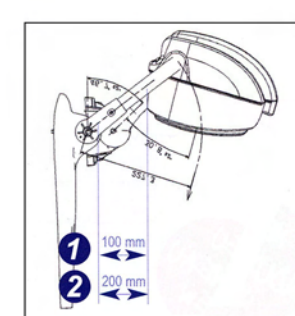
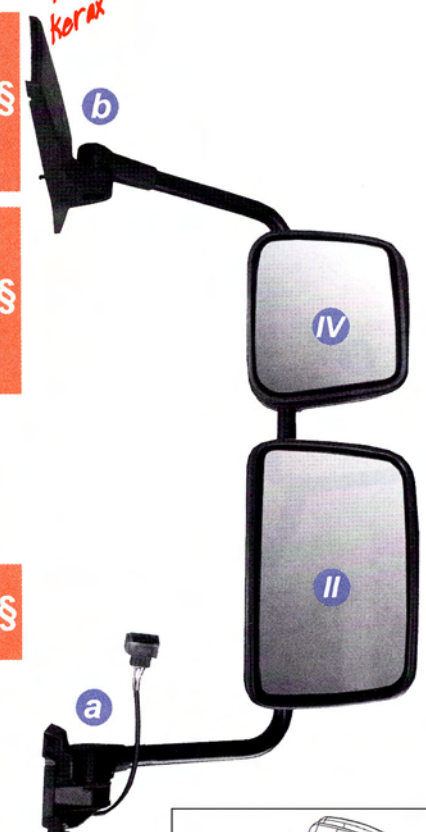

§ Specchio secondo la direttiva CEE 2003/97 o CEE 2007/38

NEU NOUVEAU NEW
Premium Route 2711
10/2005

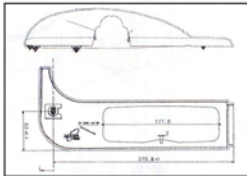
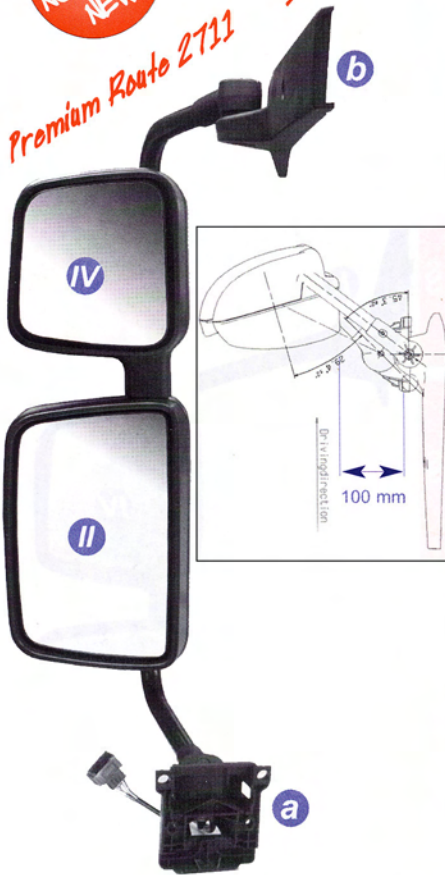

RENAULT			
0.390	II E1 03★0009 IV E1 03★0010	II E1 020914 IV E1 020913	II+IV Truck ABS INTEGR.
DESCRIZIONE			
300800780	II+IV C 24V ca. 880 x 340 x 155	ca. 880 x 340 x 155	specchio completo SX manuale termico GRIGIO
300800781	II+IV C 24V ca. 880 x 340 x 155	ca. 880 x 340 x 155	specchio completo SX termico elettrico II NERO
300800392	II 300 24V 370 x 245 x 105	370 x 245 x 105	coppa SX termica elettrica
300800782	IV 300 24V 300 x 230 x 105	300 x 230 x 105	coppa SX termica elettrica
300800394	II 1200 24V 337 x 202	337 x 202	vetro ricambio c/supporto plastico DX/SX termico
300800783	IV 300 24V 203 x 189	203 x 189	vetro ricambio c/supporto plastico SX termico
300800784	II 371 x 244 x 80	371 x 244 x 80	coppa ricambio DX/SX NERA
300800785	II 371 x 244 x 80	371 x 244 x 80	coppa ricambio DX/SX GRIGIA
300800786	IV 303 x 244 x 75	303 x 244 x 75	coppa ricambio SX NERA
300800787	IV 303 x 244 x 75	303 x 244 x 75	coppa ricambio SX GRIGIA
300800753	C 800 x 270 x Ø 28	800 x 270 x Ø 28	braccio SX per veicoli c/guida a SX
300800754	C 800 x 270 x Ø 28	800 x 270 x Ø 28	braccio SX per veicoli c/guida a DX
300800398	für for pour C a 518 x 98	518 x 98	calotta ricambio per braccio SX per veicoli c/guida DX/SX
300800757	für for pour C b 293 x 76	293 x 76	calotta ricambio per braccio SX per veicoli c/guida a SX
300800758	für for pour C b 293 x 76	293 x 76	calotta ricambio per braccio SX per veicoli c/guida a DX

0.558			
V E1 03★0011 V E1 020912	V E1 020912	V Truck ABS	Türrahmen • doorframe portière à feuillure • moldura intelaiatura porta marco de puerta dorram • ram dveri дверная рама • kapi çerçevesi
DESCRIZIONE			
300800400	300 260 x 229 x 77	260 x 229 x 77	specchio completo DX per veicoli c/guida a SX
300800399	300 260 x 229 x 77	260 x 229 x 77	specchio completo SX per veicoli c/guida a DX

Specchio secondo la direttiva CEE 2003/97 o CEE 2007/38

RENAULT

0.390

II E1 03★0009 II E1 020914
IV E1 03★0010 IV E1 020913



ABS

INTEGR.

DESCRIZIONE

NEU NOUVEAU NEW
Premium Route 2711 10/2005 →

300800788		ca. 880 x 340 x 155	specchio completo DX manuale termico GRIGIO
300800789		ca. 880 x 340 x 155	specchio completo DX termico elettrico II NERO

300800405		370 x 245 x 105	coppa ricambio DX termica elettrica
300800790		300 x 230 x 105	coppa ricambio DX termica elettrica

300800394		337 x 202	vetro ricambio c/supporto plastico DX/SX termico
300800791		203 x 189	vetro ricambio c/supporto plastico DX termico

300800784		371 x 244 x 80	calotta ricambio DX/SX NERA
300800785		371 x 244 x 80	calotta ricambio DX/SX GRIGIA
300800792		303 x 244 x 75	calotta ricambio DX NERA
300800793		303 x 244 x 75	calotta ricambio DX GRIGIA

300800744		800 x 270 x Ø 28	braccio ricambio DX per veicoli c/guida a SX
300800746		800 x 270 x Ø 28	braccio ricambio DX per veicoli c/guida a DX

300800408		518 x 98	calotta ricambio per braccio DX per veicoli c/guida DX/SX
300800409		293 x 76	calotta ricambio per braccio DX per veicoli c/guida a SX
300800410		293 x 76	calotta ricambio per braccio DX per veicoli c/guida a DX



RENAULT Bisonte a
300800810 Specchio mm. 400x200
RENAULT Messenger b
300800811 Specchio curvo mm. 253x150



§ Specchio secondo la direttiva CEE 2003/97 o CEE 2007/38

**NEU
NOUVEAU
NEW**

*Renault Midlum 1818
& Premium Distribution
kerax*

*05/2006
05/2006
05/2006*

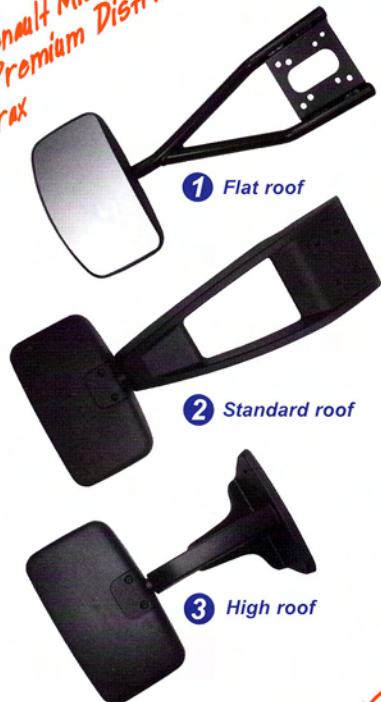

1 Flat roof

2 Standard roof

3 High roof

Premium, Gamme R/G → 9/2005



1

2

RENAULT

0.552

V VI e1 03★0033
V VI (E1) 020894



INTEGR.



DESCRIZIONE

1	300800794		644 x 319 x 203	specchio completo c/supporto DX/SX manuale
	300800412		319 x 187 x 50	specchio completo manuale
2	300800411		725 x 319 x 126	specchio completo c/supporto DX/SX manuale
	300800412		319 x 187 x 50	specchio completo manuale
	300800413		---	calotta ricambio per braccio
3	300800795		437 x 319 x 103	specchio completo c/supporto DX/SX manuale
	300800412		319 x 187 x 50	specchio completo manuale
	300800796		245 x 259 x 96	calotta ricambio per braccio

0.470
0.348

II e3 02★56297
II (E3) 0156297
ECE



Ø 22 mm



DESCRIZIONE

1	300800140		395 x 205 x 145	specchio completo DX/SX manuale
	300800141		380 x 190 x 35	vetro ricambio c/supporto plastico
	300800142		395 x 205 x 145	specchio completo DX/SX manuale termico
	300800143		380 x 190 x 35	vetro ricambio c/supporto plastico termico
	300800144		395 x 205 x 145	specchio completo DX/SX termico elettrico
	300800143		380 x 190 x 35	vetro ricambio c/supporto plastico termico
2	300800147		382 x 193 x 85	specchio completo DX/SX termico manuale
	300800151		370 x 185	vetro ricambio c/supporto plastico termico
	300800149		380 x 185	specchio completo DX/SX
	300800150		370 x 185	vetro di ricambio DX/SX

0.348

IV e1 03★0185
IV (E1) 021023



Ø 22 mm

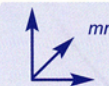

DESCRIZIONE

	300800797		199 x 199 x 97	specchio completo DX/SX termico manuale
	300800798		189 x 189 x 3	vetro ricambio termico
	300800808		199 x 199 x 97	specchio completo DX/SX manuale
	300800809		189 x 189 x 3	vetro ricambio

Specchio secondo la direttiva CEE 2003/97 o CEE 2007/38

02/192 →

RENAULT				
0.286	II E2 02★752 II E2 00752	Truck II	ABS	INTEGR.
		DESCRIZIONE		
300800799		480 x 240 x 90	specchio completo SX elettrico termico	
300800800		460 x 187 x 30	vetro ricambio c/supporto plastico termico	
300800801		480 x 240 x 90	specchio completo DX elettrico termico	
300800800		460 x 187 x 30	vetro ricambio c/supporto plastico termico	
300800806		480 x 240 x 90	specchio completo DX/SX manuale	
300800807		460 x 187 x 30	vetro di ricambio DX/SX	

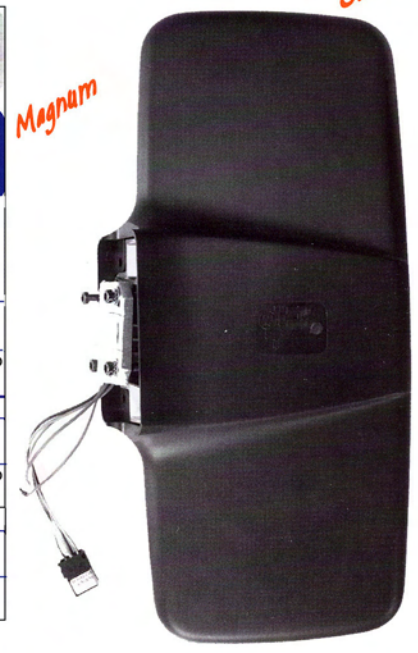

0.287				
IV / V E2 00753	Truck IV	ABS	INTEGR.	
		DESCRIZIONE		
a) 300800802		220 x 230 x 90	guardaruota DX manuale termico	
300800803		200 x 151 x 3	vetro ricambio termico	
b) 300800812		240 x 215 x 120	grandangolo SX termico manuale 5001873672	
b) 300800813		240 x 215 x 120	grandangolo DX termico manuale 5001873673	
c) 300800814		310 x 215 x 140	guardaruota DX manuale termico 5010646159	

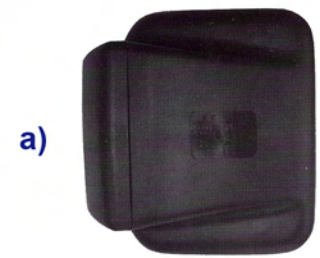

0.552				
V VI E1 03★0033 V VI E1 020894	Truck VI	ABS	INTEGR.	
		DESCRIZIONE		
300800804		---	specchio completo c/braccio DX/SX manuale	
300800412		319 x 187 x 50	specchio completo manuale	
300800805		---	calotta ricambio per braccio	

NEU NOUVEAU NEW



S Specchio secondo la direttiva CEE 2003/97 o CEE 2007/38

alte Braereiho / old series → 10/81



R 93, R 113, R 143 10/81 - 1996

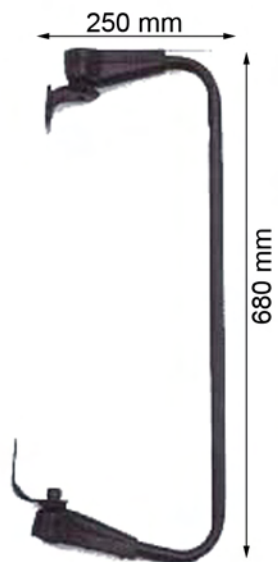

SCANIA			
0.259	II e4 02★2069 II E4 012069	Truck II st	Ø 16 - 18 mm
		DESCRIZIONE	
300800650		264 x 162 x 20	specchio DX/SX manuale SCANIA
300800651	 1800	257 x 155	vetro di ricambio

0.257			
II e1 01★14059	Truck II st	Ø 22 mm	
		DESCRIZIONE	
300800652		426 x 231 x 75	specchio DX/SX manuale SCANIA
300800653	 1800	417 x 221 x 3	vetro ricambio
300800654		404 x 206 x 120	calotta ricambio
300800655	 24 V	426 x 231 x 75	specchio DX/SX manuale termico SCANIA
300800656	 1800 24 V	417 x 221 x 3	vetro ricambio termico
300800654		404 x 206 x 120	calotta ricambio

300800663	BRACCIO PER SCANIA 142/143 DX/SX mm 250x680 Ø 28mm
------------------	--

<h1>SCANIA</h1>				
0.156/6 BO	IV ^e 02★0003 IV(E5) 01019	IV Truck	st	A Ø 22 mm B Ø 16-20 mm
		mm		DESCRIZIONE
300790076		400	258 x 152 x 30	specchio DX/SX manuale SCANIA
300800651		400	253 x 150 x 3	vetro ricambio
300800704		300	258 x 152 x 30	specchio DX/SX manuale SCANIA
300800706		300	253 x 150 x 3	vetro ricambio
300800657			235 x 145 x 88	calotta ricambio
300800658			73 x 58 x 23	dispositivo di bloccaggio senza VITE
300800659			---	dispositivo di bloccaggio senza VITE

(1) carcassa (2) manopola

R 93, R 113, R 143 10/81 - 12/96



10/81 - 1996

1996 - 07/04

<h1>SCANIA</h1>				
0.156/6 BO	V ^e 02★0004 V(E5) 01020	V Truck	st	Türrahmen • doorframe portière à feuillure • moldura intelaiaitura porta marco de puerta dörram • rám dveří дверная рама • kapi çerçevesi
		mm		DESCRIZIONE
300790076		400	258 x 152 x 30	specchio DX/SX manuale SCANIA
300800651		400	253 x 150 x 3	vetro ricambio
300800704		300	258 x 152 x 30	*NON ANCORA DISPONIBILE*
300800706		300	253 x 150 x 3	*NON ANCORA DISPONIBILE*
300800660			41 x 80 x 20	supporto SCANIA
300800661			235 x 75 (Ø 16)	supporto SCANIA

R 93, R 113, R 143 10/81 - 1996
12A/14A (Serie 400) 1996 - 07/04



12A/14A (Serie 400) 1996 - 07/04

<h1>SCANIA</h1>				
0.558	V ^e 03★0011 V(E1) 020912	V Truck	ABS	Türrahmen • doorframe portière à feuillure • moldura intelaiaitura porta marco de puerta dörram • rám dveří дверная рама • kapi çerçevesi
		mm		DESCRIZIONE
300800662		300	260 x 229 x 77	specchio c/supporto DX/SX manuale SCANIA

§ Specchio secondo la direttiva CEE 2003/97 o CEE 2007/38

NEU
NOUVEAU
NEW

12A/14A (Serie 400) 1996 - 07/04
Serie AR/P/T 08/04 →

SCANIA

0.400 ECE II+IV
Truck ABS INTEGR.

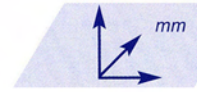

II	300800665		ca. 530 x 340 x 120	specchio completo c/supporto SX elettrico termico
	300800666		ca. 530 x 340 x 120	specchio completo c/supporto SX manuale termico
	300800667		ca. 530 x 340 x 120	specchio completo c/supporto DX elettrico termico
	300800668		ca. 530 x 340 x 120	specchio completo c/supporto DX manuale termico
	300800687	Calotta ricambio con braccio SX - Modello: 94-114-124-144-164 II		
	300800688	Calotta ricambio con braccio DX - Modello: 94-114-124-144-164 II		
IV	300800711	Calotta ricambio SENZA braccio SX - Modello: 94-114-124-144-164 II		
	300800712	Calotta ricambio SENZA braccio DX - Modello: 94-114-124-144-164 II		
II	300800670		432 x 200 x 18	vetro ricambio c/supporto in plastica DX/SX
	300800671		432 x 200 x 18	vetro ricambio c/supporto in plastica DX/SX termico
IV	300800672		ca. 250 x 190 x 130	specchio completo SX manuale termico
	300800673		ca. 250 x 190 x 130	specchio completo DX manuale termico
	300800674		184 x 160 x 20	vetro ricambio c/supporto in plastica DX/SX termico



300800664 **KIT MONTAGGIO SPECCHIO DX/SX PER NOSTRI SPECCHI CON CODICE: 300800687 E 300800688**
Modello: 94-114-124-144-164-166

§ Specchio secondo la direttiva CEE 2003/97 o CEE 2007/38

GUARDARUOTA

0.552 0.552-1	V e1 02★0742 V (E1) 010742 03★0033 020894			Türrahmen • doorframe portière à feuillure • moldura inteliatura porta marco de puerta dörram • rám dveří дверная рама • kapı çerçevesi
300800677		319 x 187 x 75	specchio completo c/supporto DX/SX manuale	
300800678		319 x 187 x 75	specchio completo c/supporto DX/SX manuale termico	

Serie 4 R/P/T 08/04 →



GUARDAVANTI

SCANIA				
0.552	V VI e1 03★0033 V VI (E1) 020894			INTEGR.
DESCRIZIONE				
1 300800680		---	specchio c/supporto DX manuale SCANIA	
300800412		306 x 186 x 50	specchio DX/SX manuale SCANIA	
300800681		---	braccio DX per veicoli c/guida SX	
300800682		---	specchio c/supporto SX manuale SCANIA	
300800412		306 x 186 x 50	specchio DX/SX manuale SCANIA	
300800683		---	braccio SX per veicoli c/guida DX	
2 300800684		---	specchio c/supporto DX manuale SCANIA	
300800412		306 x 186 x 50	specchio DX/SX manuale SCANIA	
300800685		---	braccio DX per veicoli c/guida SX	
300800412		306 x 186 x 50	specchio DX/SX manuale SCANIA	
300800686		---	braccio SX per veicoli c/guida DX	

NEU NOUVEAU NEW

R/P/T - Serie 440 - 470 - 500 - 620 03/05 →

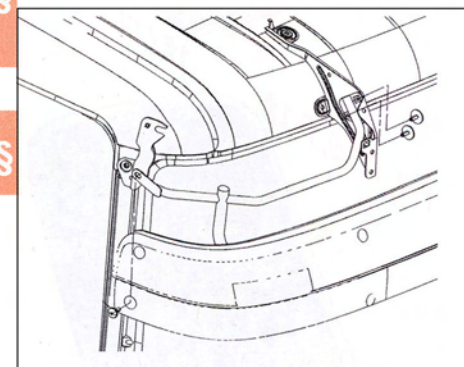

1				
	CR 16 / CR 19 Low Cab Flachdachkabine (Flat roof)	CR 19 Normal Cab Basiskabine (Standard roof)	CR 19 Highline High Cab Fernverkehrs- Fahrerhaus	CR 19 Topline High Cab Fernverkehrs- Fahrerhaus

S

Specchio secondo la direttiva CEE 2003/97 o CEE 2007/38

COPPE DI RICAMBIO ..DAF & VOLVO..







COPPA RICAMBIO VOLVO-FORD-BEDFORD-DAF COLORE NERO

- 300800760** Coppa termica con MORSETTO 24 V
mm 390x205
- 300800761** Coppa con MORSETTO
mm 390x205
- 300800762** Vetro ricambio **termico** 24 V
mm 376x190
- 300800763** Vetro ricambio
mm 376x190



COPPA RICAMBIO VOLVO-FORD-BEDFORD-DAF COLORE NERO

- 300800764** Coppa termica con MORSETTO 24 V
mm 207x171 
- 300800765** Coppa con MORSETTO
mm 207x171 
- 300800766** Vetro ricambio **termico** 24 V
mm 195x157 
- 300800767** Vetro ricambio
mm 195x157 



COPPA RICAMBIO UNIVERSALE COLORE NERO

- 300800768** Coppa termica con MORSETTO
24V UNIVERSALE 
∅ mm 10-20 e mm 260x148
- 300800769** Coppa con MORSETTO 
∅ mm 10-20 e mm 260x148

*N-Serie
F 86, F 88, F 89
12/77 - 08/85
08/85 - 06/77*



*F 7, F 10, F 12
12/77 - 08/85*



*FL 4, FL 6
09/85 - 09/93*



VOLVO			
0.255	II e1 01★14071	Truck II	st Ø 16 - 18 mm
		DESCRIZIONE	
300800700		315 x 224 x 27	specchio completo DX/SX manuale
300800701		298 x 208 x 3	vetro ricambio

0.250			
II e1 01★14002	Truck II	ABS	Ø 14 - 20 mm
		DESCRIZIONE	
300800702		375 x 183 x 26	specchio completo DX/SX manuale
300800311		366 x 176 x 3	vetro ricambio
300800703		375 x 183 x 26	specchio completo DX/SX manuale termico
300800313		366 x 176 x 3	vetro ricambio termico

0.253			
II e1 02★14067 II E1 0114067	Truck II	ABS	Ø 18 mm
		DESCRIZIONE	
300800504		370 x 182 x 64	specchio completo DX/SX manuale
300800505		356 x 170 x 3	vetro ricambio
300800705		55 x 43 x 36	dispositivo di bloccaggio c/vite
300800506		370 x 182 x 64	specchio completo DX/SX manuale termico
300800507		356 x 170 x 3	vetro ricambio termico
300800705		55 x 43 x 36	dispositivo di bloccaggio c/vite

VOLVO				
0.252	II e1 02★14089 II E1 0114089			Ø 14 - 20 mm
		DESCRIZIONE		
300800707		444 x 208 x 84	specchio completo DX/SX manuale	
300800708		430 x 191 x 3	vetro ricambio	
300800709		444 x 208 x 84	specchio completo DX/SX manuale termico	
300800710		430 x 191 x 3	vetro ricambio termico	

*FL 4, FL 6, FL 7, FL 10
F 10, F 12, F 16
NL 10, NL 12
9/85 - 9/94
9/85 - 9/93
1972 - 8/85*

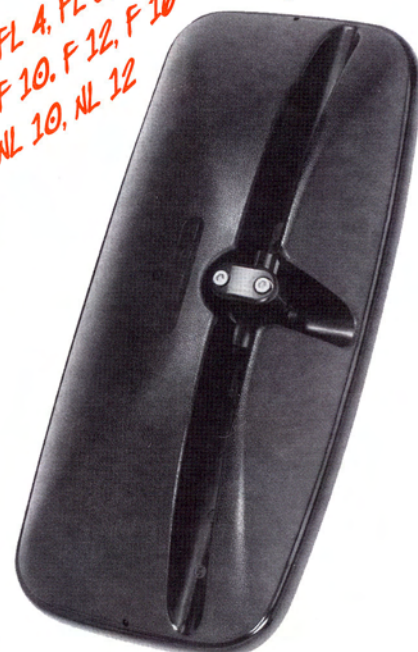

0.261	IV e6 02★6565			Ø 14 - 20 mm
		DESCRIZIONE		
300790084		230 x 230 x 100	specchio completo DX/SX manuale	
300790086		215 x 215 x 3	vetro ricambio	
300790085		230 x 230 x 100	specchio completo DX/SX manuale termico	
300790086		215 x 215 x 3	vetro ricambio	



0.156/6 BO	V e5 02★0004 V E5 01020			Türrahmen • doorframe portière à feuillure • moldura intelaiatura porta marco de puerta dörram • rám dveří дверная рама • kapi çerçevesi
		DESCRIZIONE		
300790076		260 x 155 x 30	specchio completo DX/SX manuale	
300800651		253 x 150 x 3	vetro ricambio	
300800660		41 x 80 x 20	supporto	



10/95 - 03/02
08/98 - 03/02
05/99 →

FH
FM
NH



VOLVO		0.370		II E1 02★14125 II E1 0114125	Truck II	ABS	INTEGR.
							DESCRIZIONE
300800713					469 x 249 x 117	specchio completo SX manuale termico	
300800714					469 x 249 x 117	specchio completo SX elettrico termico	
300800716					469 x 249 x 117	specchio completo SX	
300800717					240 x 250 x 45	braccio SX	
300800718					240 x 250 x 45	braccio DX	
300800719					PTC	433 x 198 x 16	vetro ricambio c/supporto plastico termico DX/SX
300800720						433 x 198 x 16	vetro ricambio c/supporto plastico DX/SX

10/95 - 03/02
08/98 - 03/02
05/99 →

FH
FM
NH



VOLVO		0.371		II E1 02★14126 II E1 0114126 IV E1 02★11016 IV E1 0111016	Truck II+IV	ABS	INTEGR.
							DESCRIZIONE
300800715					665 x 251 x 117	specchio completo DX	
300800723					665 x 251 x 117	specchio completo DX manuale termico	
300800724					665 x 251 x 117	specchio completo DX elettrico termico	
300800717					240 x 250 x 45	braccio SX	
300800718					240 x 250 x 45	braccio DX	
300800719					PTC	433 x 198 x 16	vetro ricambio c/supporto plastico DX/SX termico
300800720						433 x 198 x 16	vetro ricambio c/supporto plastico DX/SX
300800728						181 x 175 x 24	vetro ricambio c/supporto plastico DX/SX
300800729					PTC	181 x 175 x 27	vetro ricambio c/supporto plastico DX/SX termico

S Specchio secondo la direttiva CEE 2003/97 o CEE 2007/38

VOLVO

0.224



INTEGR.



DESCRIZIONE

II	a) 300800730		ca. 530 x 420 x 110	specchio completo + braccio SX elettrico termico	§
	300800731		ca. 530 x 420 x 110	specchio completo + braccio SX manuale termico	
	a) 300800732		ca. 530 x 420 x 110	specchio completo + braccio DX elettrico termico	
	300800733		ca. 530 x 420 x 110	specchio completo + braccio DX manuale termico	
	300800735		200 x 435	vetro di ricambio c/supporto plastico DX/SX termico	
IV	b) 300800736		ca. 200 x 250 x 70	specchio completo SX manuale termico	§
	b) 300800737		ca. 200 x 250 x 70	specchio completo DX manuale termico	
	300800738		176 x 188	vetro di ricambio c/supporto plastico DX/SX termico	
	300800739		180 x 200	vetro di ricambio c/supporto plastico DX/SX termico	

RICAMBI:

a)		300792097	Calotta specchio DX-SX A.B.S. - NERO	Adattabile agli articoli: * 300800730 * 300800732
b)		300792098	Calotta specchio DX-SX grandangolo A.B.S. - NERO	Adattabile agli articoli: * 300800736 * 300800737

NEU
NOUVEAU
NEW

0A/02 →
0A/02 →

FH II
FM II



0.360	V e1 02★12013 V E1 0112013			INTEGR.	
0.360-1	03★0039 020973				
			DESCRIZIONE		
1	300790080		284 x 174 x 64	specchio completo DX/SX manuale	§
	300790081		272 x 162 x 3	vetro ricambio	
	300790082		284 x 174 x 64	specchio completo DX/SX manuale termico	§
	300790083		272 x 162 x 3	vetro ricambio termico	
2	300790088		284 x 174 x 64	specchio completo DX/SX manuale termico	§
	300790083		272 x 162 x 3	vetro ricambio termico	

10/95 - 03/02
08/98 - 03/02
05/99 →
0A/02 →

FH
FM
NH
FH II, FM II



§ Specchio secondo la direttiva CEE 2003/97 o CEE 2007/38

VOLVO

0.390

II E1 03★0009 II E1 020914
IV E1 03★0037 IV E1 020916



INTEGR.



DESCRIZIONE

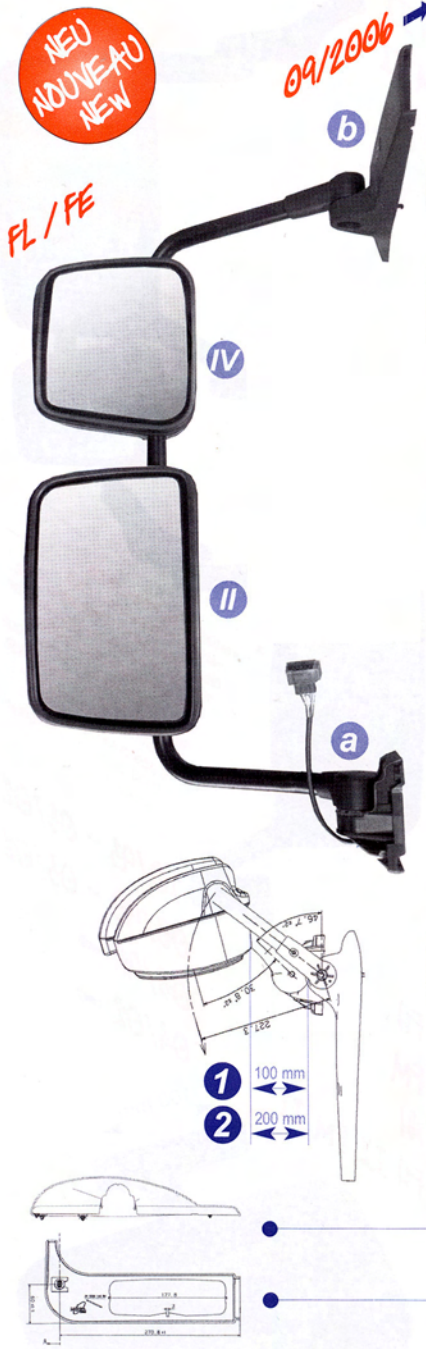

1	300800750		ca. 880 x 340 x 155	specchio completo c/braccio SX manuale termico
	300800390		ca. 880 x 340 x 155	specchio completo + braccio SX termico elettrico II
2	300800751		ca. 880 x 440 x 155	specchio completo + braccio SX manuale termico
	300800752		ca. 880 x 440 x 155	specchio completo + braccio SX termico elettrico II
	300800391		370 x 245 x 105	coppa DX/SX manuale termica
	300800392		370 x 245 x 105	coppa SX termica elettrica
	300800393		230 x 245 x 105	coppa SX manuale termica
	300800394		337 x 202	vetro di ricambio c/supporto plastico DX termico
	300800395		197 x 200	vetro di ricambio c/supporto plastico SX termico
	300800396		370 x 247 x 80	calotta ricambio
	300800397		244 x 225 x 75	calotta ricambio
1	300800753		800 x 270 x Ø 28	braccio SX per veicoli c/guida a SX
	300800754		800 x 270 x Ø 28	braccio SX per veicoli c/guida a DX
2	300800755		800 x 350 x Ø 28	braccio SX per veicoli c/guida a SX
	300800756		800 x 350 x Ø 28	braccio SX per veicoli c/guida a DX
	300800398		518 x 98	calotta per braccio SX per veicoli c/guida DX/SX
	300800757		293 x 76	calotta per braccio SX per veicoli c/guida SX
	300800758		293 x 76	calotta per braccio SX per veicoli c/guida DX

0.558

V E1 03★0011
V E1 020912



Turrahmen • doorframe
portière à feuillure • moldura
intelaiaitura porta
marco de puerta
dörram • rám dveří
дверная рама • капі сарцевесі



DESCRIZIONE



	300800400		260 x 229 x 70	specchio completo DX per veicoli c/guida a SX
	300800399		260 x 229 x 70	specchio completo SX per veicoli c/guida a DX

Specchio secondo la direttiva CEE 2003/97 o CEE 2007/38

VOLVO

0.390

II e1 03★0009 II E1 020914
IV e1 03★0037 IV E1 020916



ABS

INTEGR.



DESCRIZIONE

1	300800741		ca. 880 x 340 x 155	specchio completo + braccio DX manuale termico
	300800401		ca. 880 x 340 x 155	specchio completo + braccio DX termico elettrico II
2	300800742		ca. 880 x 440 x 155	specchio completo + braccio DX manuale termico
	300800743		ca. 880 x 440 x 155	specchio completo + braccio DX termico elettrico II
	300800391		370 x 245 x 105	coppa DX/SX manuale termica
	300800405		370 x 245 x 105	coppa DX elettrica termica
	300800406		230 x 245 x 105	coppa DX manuale termica
	300800394		337 x 202	vetro di ricambio c/supporto plastico DX/SX termico
	300800407		197 x 200	vetro di ricambio c/supporto plastico DX termico
	300800396		370 x 247 x 80	calotta ricambio
	300800397		244 x 225 x 75	calotta ricambio
1	300800744		800 x 270 x Ø 28	braccio DX per veicoli c/guida a SX
	300800745		800 x 270 x Ø 28	braccio DX per veicoli c/guida a DX
2	300800746		800 x 350 x Ø 28	braccio DX per veicoli c/guida a SX
	300800747		800 x 350 x Ø 28	braccio DX per veicoli c/guida a DX
	300800408		518 x 98	calotta per braccio DX per veicoli c/guida a DX/SX
	300800409		293 x 76	calotta per braccio DX per veicoli c/guida SX
	300800410		293 x 76	calotta per braccio DX per veicoli c/guida DX

FL/FE

09/2006 →

NEU NOUVEAU NEW

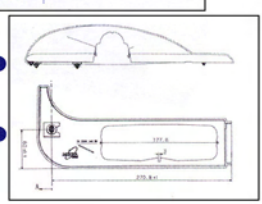
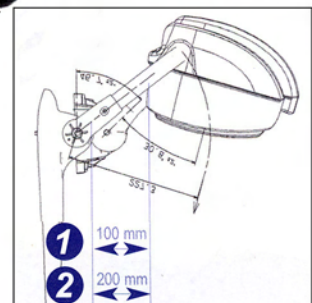
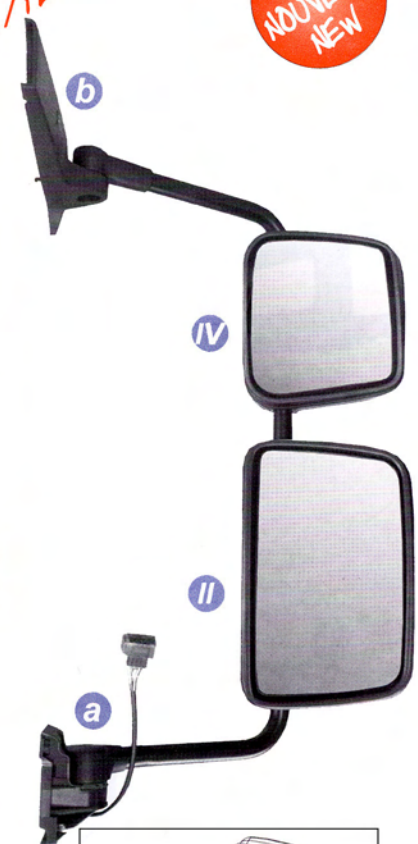

NEU NOUVEAU NEW



0.552

V VI e1 03★0033
V VI E1 020894



ABS

INTEGR.



DESCRIZIONE

	300800411		725 x 319 x 126	specchio completo c/supporto DX/SX manuale
	300800412		319 x 187 x 50	specchio completo manuale
	300800413		---	calotta per braccio

§

Specchio secondo la direttiva CEE 2003/97 o CEE 2007/38

CODICE

DESCRIZIONE

**RETROVISORE COMPLETO
PIAGGIO - PORTER
COLORE NERO**

300793409000

COMPLETO DESTRO

300793409001

COMPLETO SINISTRO



**RETROVISORE COMPLETO
FIAT "DAILY" - OM "GRINTA"
F.L.40 - ALFA ROMEO "8A.R."
AUTOCARRI**

300793431000

COMPLETO DESTRO (mm239x207)

300793431001

COMPLETO SINISTRO (mm239X207)

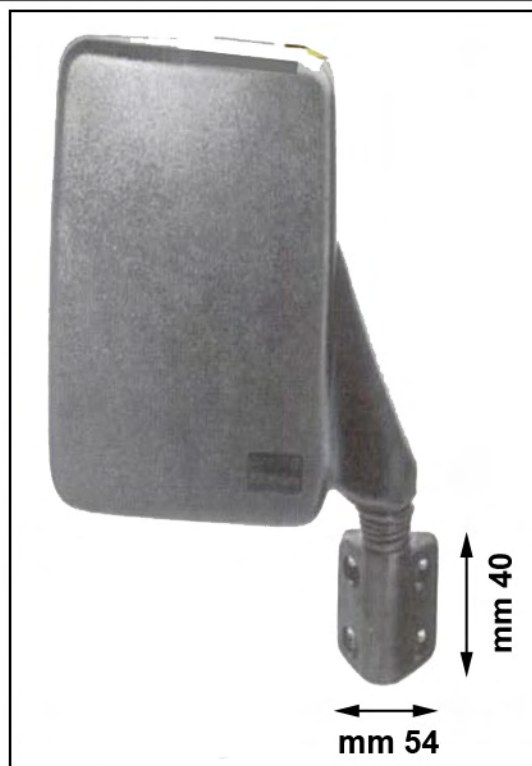

**RETROVISORE COMPLETO
FIAT FURGONI
900 T - MARENGO (1980 →)
FIORINO (1991 →)**

300793419000

COMPLETO DESTRO

300793419001

COMPLETO SINISTRO



CODICE

DESCRIZIONE

RETROVISORE COMPLETO

FIAT FURGONI 238 (1980→) - DAILY
OM "GRINTA" FL3035 - 35 - DUCATO
ALFA ROMEO 35 AR - PEUGEOT J5-J9
CITROEN C25

300793420000

COMPLETO DESTRO

300793420001

COMPLETO SINISTRO



RETROVISORE COMPLETO

FIAT 242/E FURGONE
CITROEN C35L (1980→) FURGONE

300793421000

COMPLETO DESTRO

300793421001

COMPLETO SINISTRO



RETROVISORE COMPLETO

FIAT "DAILY" - OM "GRINTA" F.L. 40 -
ALFA ROMEO "8 A.R."
AUTOCARRI

300793430000

COMPLETO DESTRO (mm.195x150)

300793430001

COMPLETO SINISTRO (mm.195x150)



CODICE

DESCRIZIONE

RETROVISORE COMPLETO
IVECO DAILY GAMMA S Restyling
35-8 - 35-10 - 35-12 (6/96 →)
COLORE GRIGIO SCURO
BRACCIO CORTO

300793434000

COMPLETO DESTRO

300793434001

COMPLETO SINISTRO

300793434200

COMPLETO DESTRO C/VETRO
TERMICO 12V

300793434201

COMPLETO SINISTRO C/VETRO
TERMICO 12V

300793434300

COMPLETO DESTRO ELETTRICO
C/VETRO TERMICO 12V

300793434301

COMPLETO SINISTRO ELETTRICO
C/VETRO TERMICO 12V



RETROVISORE COMPLETO
IVECO DAILY GAMMA S Restyling
35-8 - 35-10 - 35-12 (6/96 →)
COLORE GRIGIO SCURO
BRACCIO LUNGO

300793435000

COMPLETO DESTRO

300793435001

COMPLETO SINISTRO

300793435200

COMPLETO DESTRO C/VETRO
TERMICO 12V

300793435201

COMPLETO SINISTRO C/VETRO
TERMICO 12V

300793435300

COMPLETO DESTRO ELETTRICO
C/VETRO TERMICO 12V

300793435301

COMPLETO SINISTRO ELETTRICO
C/VETRO TERMICO 12V

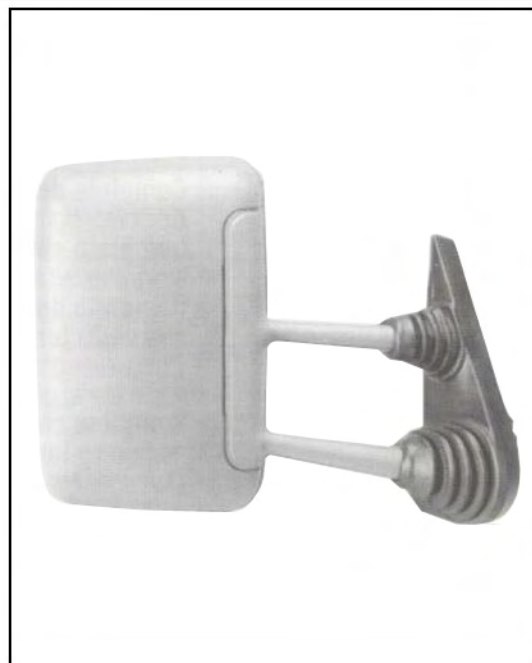

RETROVISORE COMPLETO
FIAT TALENTO Restyling
FIAT DUCATO Restyling
J 5 PEUGEOT (← 1994)
CITROEN C25 (← 1994)
COLORE NERO
BRACCIO CORTO

300793436000

COMPLETO DESTRO

300793436001

COMPLETO SINISTRO



CODICE

DESCRIZIONE

RETROVISORE COMPLETO

FIAT - DUCATO (1994 →)
CITROEN JUMPER
PEUGEOT BOXER
COLORE NERO
BRACCIO CORTO

300793437000

COMPLETO DESTRO

300793437001

COMPLETO SINISTRO

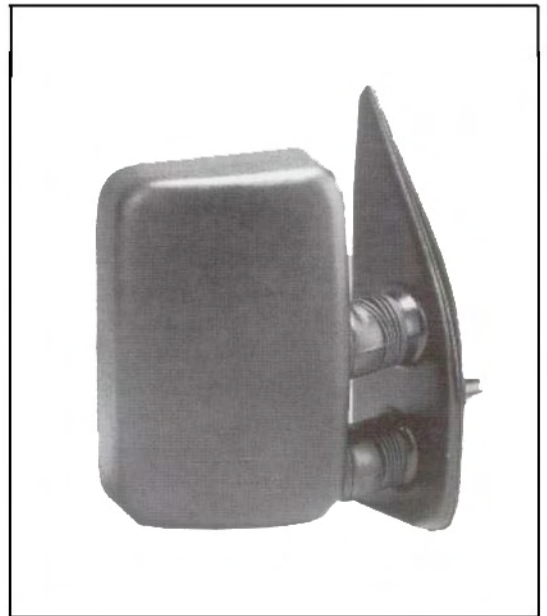

RETROVISORE COMPLETO

FIAT - SCUDO
PEUGEOT EXPERT
COLORE NERO

300793438000

COMPLETO DESTRO

300793438001

COMPLETO SINISTRO



RETROVISORE COMPLETO
Con regolazione meccanica

FIAT - SCUDO
PEUGEOT EXPERT
COLORE NERO

300793438010

COMPLETO DESTRO

300793438011

COMPLETO SINISTRO



CODICE

DESCRIZIONE

RETROVISORE COMPLETO

FIAT - DUCATO (1999 →)
COLORE NERO
BRACCIO CORTO

300793439000

COMPLETO DESTRO

300793439001

COMPLETO SINISTRO



RETROVISORE COMPLETO

FORD TRANSIT
COLORE NERO

300793451000

COMPLETO DESTRO BRACCIO LUNGO
(mm.90)

300793451001

COMPLETO SINISTRO BRACCIO
LUNGO (mm.90)

300793450004

COPPA DI RICAMBIO DESTRA

300793450005

COPPA DI RICAMBIO SINISTRA

300793450008

VETRO DI RICAMBIO

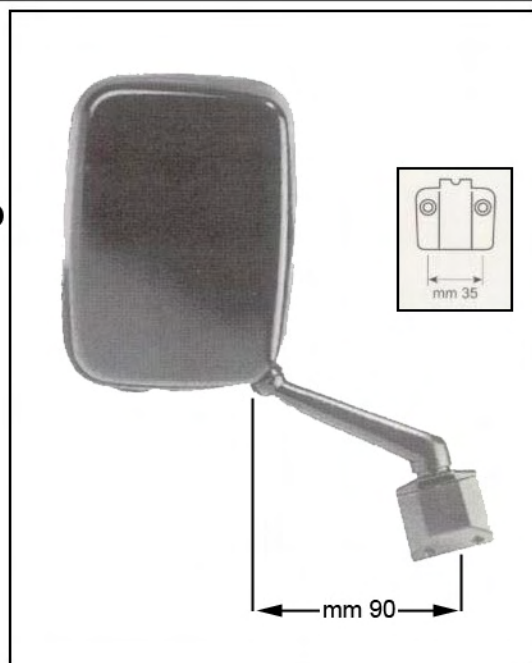

RETROVISORE COMPLETO

FORD - TRANSIT (8/'91 → '95)
COLORE NERO
BRACCIO CORTO

300793452000

COMPLETO DESTRO

300793452001

COMPLETO SINISTRO



CODICE

DESCRIZIONE

RETROVISORE COMPLETO

FORD TRANSIT ('95 → '99)
COLORE NERO

300793453000

COMPLETO DESTRO

300793453001

COMPLETO SINISTRO



RETROVISORE COMPLETO

FORD TRANSIT II Serie (1986 → '92)
COLORE NERO
BRACCIO CORTO

300793460000

COMPLETO DESTRO

300793460001

COMPLETO SINISTRO



RETROVISORE COMPLETO

FORD TRANSIT II Serie
COLORE NERO
BRACCIO LUNGO

300793461000

COMPLETO DESTRO

300793461001

COMPLETO SINISTRO



DAILY - versione braccio corto normale

dal 1999 .. 	CODICE	DESCRIZIONE
	3007931020	Retrovisore completo DX
	3007931021	Retrovisore completo SX
	3007931022	260x160 - vetro c/piattello



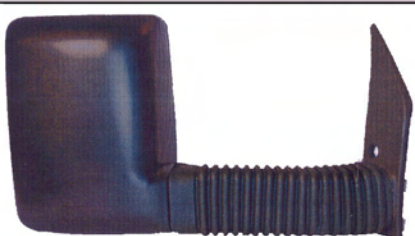

DAILY - versione braccio medio normale

dal 1999 ... 	3007931023	Retrovisore completo DX
	3007931024	Retrovisore completo SX
	3007931022	260x160 - vetro c/piattello





DAILY - versione braccio lungo normale

dal 1999 ... 	3007931025	Retrovisore completo DX
	3007931026	Retrovisore completo SX
	3007931022	260x160 - vetro c/piattello





DAILY - versione braccio corto elettrico termico 12V

dal 1999 ... 	3007931027 	Retrovisore completo DX
	3007931028 	Retrovisore completo SX
	3007931029 	Retrovisore completo SX
	3007931030 	260x160 - vetro c/piattello

DAILY - versione braccio medio elettrico termico 12V

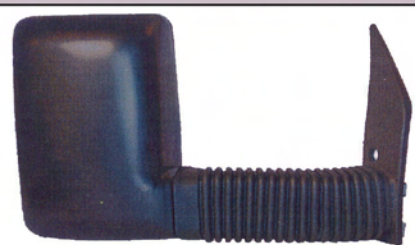
dal 1999 ... 	3007931031 	Retrovisore completo DX
	3007931032 	Retrovisore completo SX
	3007931030 	260x160 - vetro c/piattello

DAILY - versione braccio lungo elettrico termico 12V

dal 1999 ... 	3007931034 	Retrovisore completo DX
	3007931035 	Retrovisore completo SX
	3007931030 	260x160 - vetro c/piattello

CODICE

DESCRIZIONE

RETROVISORE COMPLETO

VOLKSWAGEN TRANSPORTER
COLORE NERO

300793462000

COMPLETO DESTRO

300793462001

COMPLETO SINISTRO

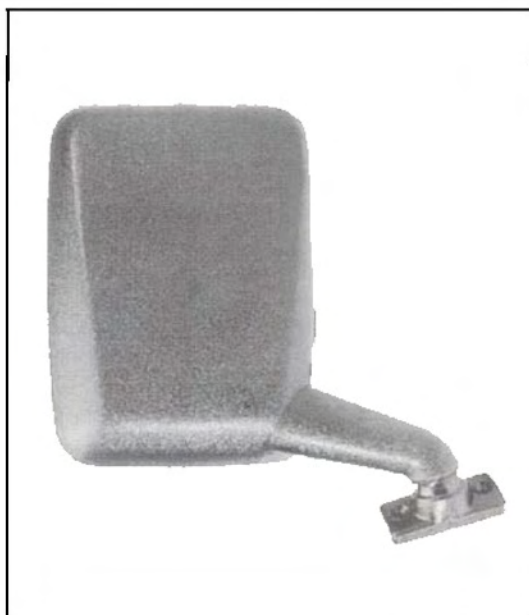

RETROVISORE COMPLETO

MERCEDES SPRINTER ('95 →)
VOLKSWAGEN LT 40 ('97 →)
COLORE NERO

300793464000

COMPLETO DESTRO

300793464001

COMPLETO SINISTRO



IVECO DAILY (2000....)

300793580008

PIASTRA COMPLETA DI VETRO
438x193

300793580308

PIASTRA COMPLETA DI VETRO
TERMICO
24V - 438x193



CODICE

DESCRIZIONE

RETROVISORE COMPLETO

IVECO TURBOSTAR 190.33
190.36PT

COLORE GRIGIO

300793532306

ASTA DESTRA C/CAVI
ELETTRICI

300793532307

ASTA SINISTRA C/CAVI
ELETTRICI

300793532309

COPPA RICAMBIO C/COMANDO
ELETTRICO A VETRO TERMICO
CROMATO

300793532308

PIASTRA COMPLETA DI VETRO
TERMICO CROMATO
(mm.400x195)

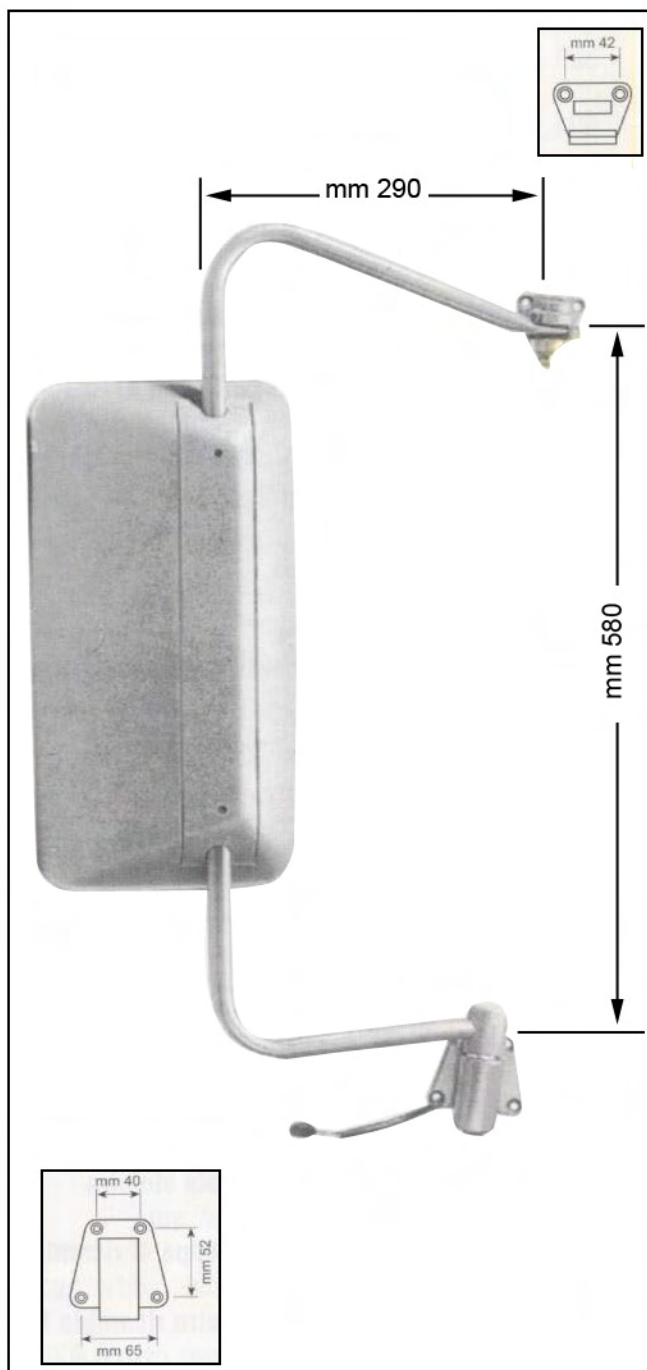

CODICE

DESCRIZIONE

RETROVISORE COMPLETO

**IVECO EUROCARGO T.T
(Guida Sinistra)**

COLORE GRIGIO

300793568006

**ASTA DESTRA
(Sporg. ext. mm 350)**

300793568007

**ASTA SINISTRA
(Sporg. ext mm 283)**

300793568206

**ASTA DESTRA TERMICA
(Sporg. ext. mm 350)**

300793568207

**ASTA SINISTRA TERMICA
(Sporg. ext. mm 283)**

300793500004

**COPPA RICAMBIO C/MORSETTO
(mm. 348x164)**

300793500009

**COPPA RICAMBIO TERMICA
(mm. 348x164)**

300793534000

**GRANDANGOLARE
(mm. 270x160)**

300793501008

**VETRO RICAMBIO
(mm. 157x336)**

300793501018

**VETRO RICAMBIO TERMICO
(mm. 336x157)**

300793501026

**MORSETTO GRIGIO
(Ø mm. 20)**



CODICE

DESCRIZIONE

RETROVISORE COMPLETO

IVECO EUROCARGO T.T
(Guida Sinistra)

COLORE GRIGIO

300793569006

ASTA DESTRA
(Sporg. ext. mm. 462)

300793569007

ASTA SINISTRA
(Sporg. ext. mm. 385)

300793569206

ASTA TERMICA DESTRA
(Sporg. ext. mm. 462)

300793569207

ASTA TERMICA SINISTRA
(Sporg. ext. mm. 385)

300793508004

COPPA RICAMBIO C/MORSETTO
(mm. 359x209)

300793508009

COPPA RICAMBIO TERMICA
(mm. 359x209)

300793506008

VETRO RICAMBIO
(mm. 345x195)

300793506018

VETRO RICAMBIO TERMICO
(mm. 345x195)

300793501026

MORSETTO GRIGIO
(Ø mm. 20)



CODICE

DESCRIZIONE

RETROVISORE COMPLETO

IVECO EUROCARGO T.T

COLORE GRIGIO

300793570006

ASTA DESTRA
(Sporg. ext. mm.350)

300793570206

ASTA TERMICA DESTRA
(Sporg. ext. mm. 350)

300793568007

ASTA SINISTRA
(Sporg. ext. mm. 283)

300793568207

ASTA TERMICA SINISTRA
(Sporg. ext. mm. 283)

300793574006

ASTA DESTRA
(Sporg. ext. mm. 462)

300793574206

ASTA TERMICA DESTRA
(Sporg. ext. mm. 462)

300793569007

ASTA SINISTRA
(Sporg. ext. mm. 385)

300793569207

ASTA TERMICA SINISTRA
(Sporg. ext. mm. 385)

300793508004

COPPA RICAMBIO C/MORSETTO
(mm. 359x209)

300793508009

COPPA RICAMBIO TERMICA
(mm. 359x209)

300793534000

SPECCHIO
"GUARDA RIMORCHIO"
(mm. 270x160)

300793506008

VETRO RICAMBIO
(mm. 345x195)

300793506018

VETRO RICAMBIO TERMICO
(mm. 345x195)

300793501026

MORSETTO GRIGIO
(Ø mm. 20)



RETROVISORE COMPLETO - COLORE GRIGIO





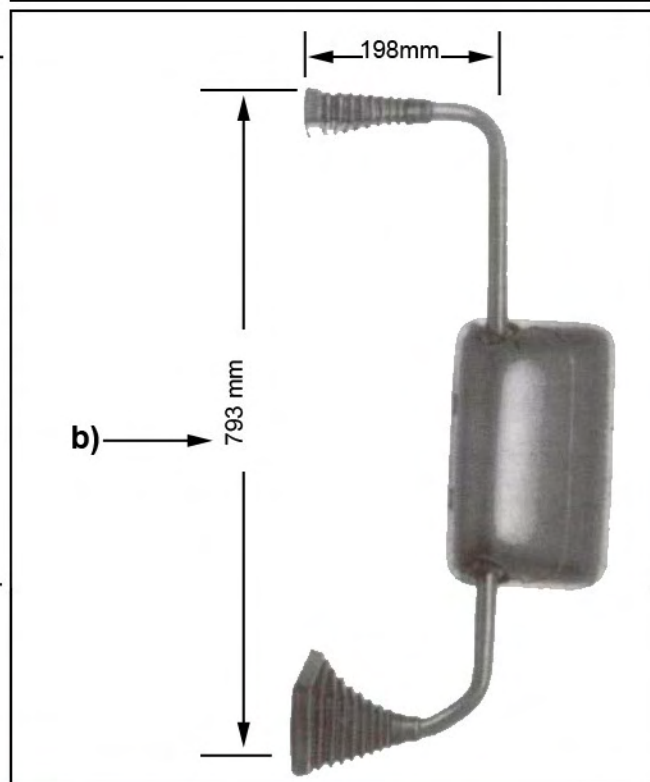
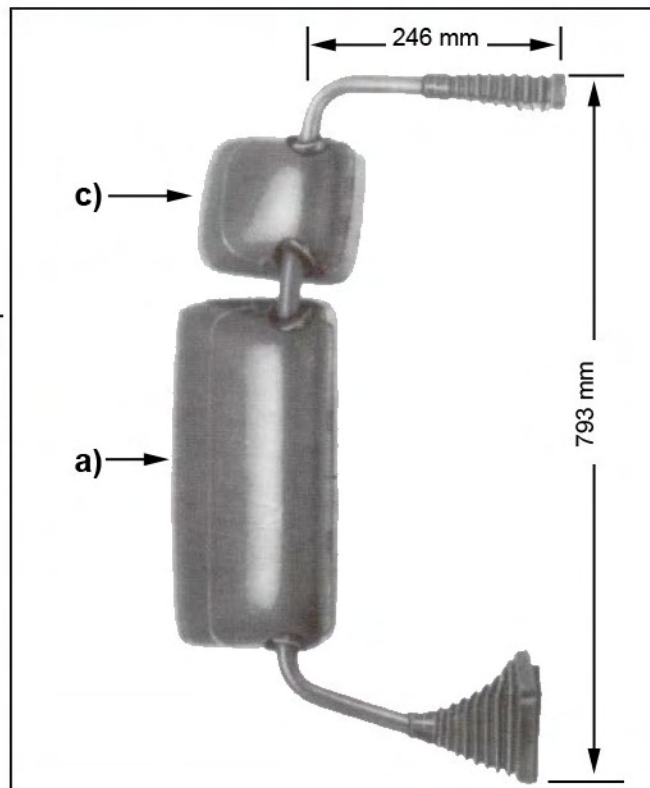

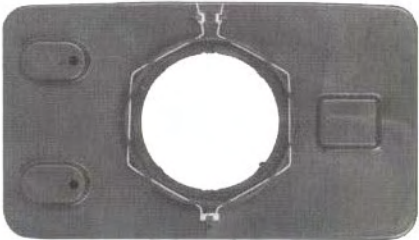

IVECO - EUROTECH - EUROSTAR - STRALIS 1° SERIE - ASTRA

CODICE	DESCRIZIONE
300793573006	ASTA DESTRA
300793573007	ASTA SINISTRA
300793573206	ASTA TERMICA DESTRA
300793573207	ASTA TERMICA SINISTRA
300793573306	ASTA DESTRA ELETTRICA TERMICA
300793573307	ASTA SINISTRA ELETTRICA TERMICA
a) 300793576309	COPPA RICAMBIO C/MOTORINO E VETRO ELETTRICO 24V
300793576309/1	COPPA EL. TERMICA DONELLI
300793576009	COPPA C/VETRO TERMICO 24V
300793576004	COPPA MANUALE DX/SX (mm. 457x215)
300793576008	PIASTRA COMPLETA DI VETRO (mm. 440x200)
300793576308	PIASTRA COMPLETA DI VETRO TERMICO (mm. 440x200)
300793576/AT	CALOTTA COPRIASTA
300793576/AT/1	CALOTTA PER SPECCHIO DONELLI GRANDE
b) 300793573004	COPPA MOVIMENTO MANUALE DX/SX (mm. 355x215)
300793573309/1	COPPA EL. TERMICA DONELLI
300793573009	COPPA C/VETRO TERMICO 24V
300793573309	COPPA RICAMBIO C/MOTORINO E VETRO ELETTRICO 24V
300793573008	PIASTRA COMPLETA DI VETRO (mm. 340x200)
300793573308	PIASTRA COMPLETA DI VETRO TERMICO (mm. 340x200)
300793573/AT	CALOTTA COPRIASTA
300793573/AT/1	CALOTTA PER SPECCHIO DONELLI MEDIO
c) 300793577004	COPPA MANUALE DX/SX (mm. 189x215)
300793577009	COPPA C/VETRO TERMICO 24V
300793577309	COPPA C/MOTORINO E VETRO ELETTRICO 24V
300793577309/1	COPPA EL. TERMICA DONELLI
300793577008	PIASTRA COMPLETA DI VETRO
300793577308	PIASTRA COMPLETA DI VETRO TERMICO (mm. 200x175)
300793577/AT	CALOTTA COPRIASTA
300793577/AT/1	CALOTTA PER SPECCHIO DONELLI PICCOLO

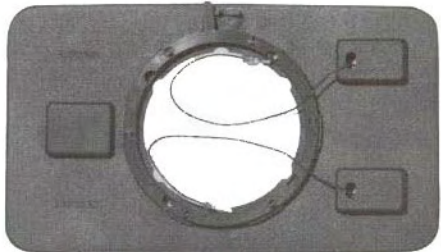
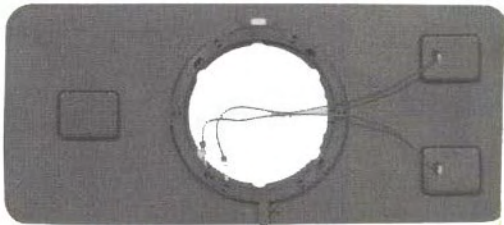

300793576308	300793573308	300793577308



PIASTRE COMPLETE DI VETRO EUROTECH, EUROSTAR, STRALIS

ILLUSTRAZIONE	CODICE	DESCRIZIONE
 ATTACCO A MOLLA	300793573008	IVECO, EUROTECH, EUROSTAR, STRALIS PIASTRA COMPLETA DI VETRO 340 x 200
	300793573308	PIASTRA COMPLETA DI VETRO TERMICO 24V 340 x 200
 ATTACCO A MOLLA	300793576008	IVECO, EUROTECH, EUROSTAR, STRALIS PIASTRA COMPLETA DI VETRO 440 x 200
	300793576308	PIASTRA COMPLETA DI VETRO TERMICO 24V 440 x 200
 ATTACCO A GHIERA DONELLI	300793578008	IVECO, EUROTECH, EUROSTAR, STRALIS PIASTRA COMPLETA DI VETRO 340 x 200
	300793578308	PIASTRA COMPLETA DI VETRO TERMICO 24V 340 x 200
 ATTACCO A GHIERA DONELLI	300793579008	IVECO, EUROTECH, EUROSTAR, STRALIS PIASTRA COMPLETA DI VETRO 440 x 200
	300793579308	PIASTRA COMPLETA DI VETRO TERMICO 24V 440 x 200
	300793577008	IVECO, EUROTECH, EUROSTAR, STRALIS PIASTRA COMPLETA DI VETRO 200 x175 ATTACCO A MOLLA 
	300793577308	PIASTRA COMPLETA DI VETRO TERMICO 24V 200 x175 ATTACCO A MOLLA 
	300793577310	PIASTRA COMPLETA DI VETRO TERMICO 24V 200 x175 ATTACCO A GHIERA DONELLI 
	300793577311	PIASTRA COMPLETA DI VETRO 200 x175 ATTACCO A GHIERA DONELLI 

IVECO

EUROCARGO - EUROTECH - EUROSTAR



<p>300841502610 <u>ATTACCO A MOLLA</u> <u>MARELLI</u></p>	<p>GUARDARUOTA DX/SX  <u>284x185</u></p>
<p>300841932995 <u>ATTACCO A MOLLA</u> <u>MARELLI</u></p>	<p>GUARDARUOTA DX/SX  <u>284x185 Manuale - Termico</u></p>
<p>300841932996 <u>ATTACCO A MOLLA</u> <u>MARELLI</u></p>	<p>GUARDARUOTA DX/SX  <u>284x185 Elettrico - Termico</u></p>





<p>300841932983 <u>ATTACCO A MOLLA</u> <u>MARELLI</u></p>	<p>VETRO RICAMBIO  <u>260x160</u></p>
<p>300841932984 <u>ATTACCO A MOLLA</u> <u>MARELLI</u></p>	<p>VETRO RICAMBIO  <u>260x160 Termico</u></p>
<p>300841932987</p>	<p>VETRO RICAMBIO  <u>260x160 Termico</u> <u>ATTACO A GHIERA DONELLI</u></p>
<p>300841932985 <u>ATTACCO A MOLLA</u> <u>MARELLI</u></p>	<p>VETRO RICAMBIO  <u>260x160</u> (OMOLOGAZIONE FINO AL 2000)</p>
<p>300841932986 <u>ATTACCO A MOLLA</u> <u>MARELLI</u></p>	<p>VETRO RICAMBIO  <u>260x160 Termico</u> (OMOLOGAZIONE FINO AL 2000)</p>



RETROVISORE COMPLETO STRALIS ULTIMA SERIE / EUROCARGO TECTOR

	<p>30079310001</p> <p>30079310002</p> <p>30079310004</p> <p>30079310003</p> <p>30079310008</p> <p>30079310007</p> <p>30079310005 <u>OMOLOGAZIONE 2009</u></p> <p>30079310006</p> <p>3007931013</p>	<p>RETROVISORE COMPLETO DX (braccio + coppa sup+coppa inf.) TERMICO ELETTRICO</p> <p>RETROVISORE COMPLETO SX (braccio + coppa sup+coppa inf.) TERMICO ELETTRICO</p> <p>CALOTTA POSTERIORE DX PER COPPA SUPERIORE</p> <p>CALOTTA POSTERIORE SX PER COPPA SUPERIORE</p> <p>CALOTTA POSTERIORE DX PER COPPA INFERIORE</p> <p>CALOTTA POSTERIORE SX PER COPPA INFERIORE</p> <p>SPECCHIO RICAMBIO TERMICO-ELETTRICO X COPPA SUPERIORE DX/SX </p> <p>SPECCHIO RICAMBIO TERMICO-ELETTRICO X COPPA INFERIORE DX/SX</p> <p>SPECCHIO RICAMBIO PER COPPA INFERIORE DX/SX (NO TERMICO)</p>
	<p>30079310009 <u>OMOLOGAZIONE 2009</u></p>	<p>GUARDARUOTA COMPLETO,  SENZA CALOTTA COPRISUPPORTO</p>
	<p>30079310009/1</p>	<p>CALOTTA COPRI SUPPORTO GUARDARUOTA STRALIS</p>
	<p>3007931016 <u>OMOLOGAZIONE 2009</u></p>	<p>SPECCHIO GUARDAVANTI STRALIS </p>

GUARDAVANTI UNIVERSALE ROTONDO

	CODICE	DESCRIZIONE
	3007931012	RETROVISORE GUARDAVANTI C/ATTACCO UNIVERSALE DX/SX ROTONDO 
	3007931014	COPPA RICAMBIO ROTONDA PER ART. 3007931012 

GUARDAVANTI UNIVERSALE RETTANGOLARE

	CODICE	DESCRIZIONE
	3007931011	RETROVISORE GUARDAVANTI C/ATTACCO UNIVERSALE DX/SX RETTANGOLARE 
	3007931015	COPPA RICAMBIO RETTANGOLARE PER ART. 3007931011 

CODICE

DESCRIZIONE

COPPA RICAMBIO

FIAT 900 T
COLORE NERO

300793410005

COPPA RICAMBIO (mm. 190x140)

300793409008

VETRO RICAMBIO (mm. 179x131)



COPPA RICAMBIO

OM 40/35 - FIAT 242 - CITROEN 35

300793412005

COPPA GRIGIA SENZA MORSETTO
(mm. 230x180)

300793619004

COPPA NERA C/MORSETTO
(Ø mm. 18 e mm. 230x180)

300793617004

COPPA NERA C/MORSETTO
(Ø mm. 20 e mm. 230x180)

300793617008

VETRO RICAMBIO (mm. 174x229)

300793501016

MORSETTO NERO (Ø mm. 20)



COPPA RICAMBIO

OM 30 SC - DAILY - GRINTA
COLORE NERO

300793422004

COPPA CON MORSETTO (mm.235x140)

300793422008

VETRO RICAMBIO (mm. 223x128)

300793501016

MORSETTO NERO (Ø mm.20)



COPPA RICAMBIO

OM 40 SC
COLORE NERO

300793424004

COPPA CON MORSETTO (mm. 290x168)

300793424008

VETRO RICAMBIO (mm. 282x155)

300793501016

MORSETTO NERO (Ø mm.20)



CODICE
DESCRIZIONE

COPPA RICAMBIO
IVECO DAILY GAMMA S
RESTYLING
35-8 - 35-10 - 35-12

300793432004

COPPA GRIGIO CHIARO

300793434004

COPPA GRIGIO SCURO

300793434009

COPPA TERMICA 12V

300793436008

PIASTRA C/VETRO

300793436308

PIASTRA C/VETRO TERMICO 12V



COPPA RICAMBIO
FORD TRANSIT
COLORE NERO

300793450004

COPPA DESTRA (mm. 200x145)

300793450005

COPPA SINISTRA (mm. 200x145)

300793450008

VETRO RICAMBIO (mm. 192x134)



COPPA RICAMBIO
FIAT - OM - 50 - 50 NC

300793500004

COPPA GRIGIA C/MORSETTO

300793500009

COPPA GRIGIA C/MORSETTO E VETRO TERMICO

300793501004

COPPA NERA C/MORSETTO

300793501009

COPPA NERA C/MORSETTO E VETRO TERMICO

300793501008

VETRO RICAMBIO (mm. 157x336)

300793501018

VETRO RICAMBIO TERMICO 24V

300793501016

MORSETTO NERO (Ø mm. 20)

300793501026

MORSETTO GRIGIO (Ø mm. 20)



COPPA RICAMBIO
FIAT 50NC-F9-F10-65 F10-70 F10
80NC-F13-90NC-100 F13-OM 50-
55-60-65-70-75-80-90-100
MAGIRUS DEUTZ 90 M 5.3

300793503004

COPPA C/MORSETTO (mm. 354x169)

300793503008

VETRO RICAMBIO (mm. 342x157)

300793501016

MORSETTO NERO (Ø mm. 20)



CODICE
DESCRIZIONE

COPPA RICAMBIO
OM-UNIC FRANZIA-MAGIRUS
DEUTZ-FIAT u.s. 170-170NT-
190NC-190NT-170NT 33/E
COLORE NERO

300793504004

COPPA C/MORSETTO (mm. 354x199)

300793504009

 COPPA NERA C/MORSETTO E VETRO
 TERMICO 24V (mm. 354x199)

300793504008

VETRO RICAMBIO (mm. 342x187)

300793504018

VETRO RICAMBIO TERMICO 24V

300793501016

MORSETTO NERO (Ø mm.20)



COPPA RICAMBIO
FIAT 190/F35T - 170/NT35 - 130NC
150N520 OM 170/35-190/35-150/20
110-159NC20-682N4 e derivati

300793506004

COPPA NERA C/MORSETTO

300793506009

 COPPA NERA C/MORSETTO E VETRO
 TERMICO 24V

300793508004

COPPA GRIGIA C/MORSETTO

300793508009

 COPPA GRIGIA C/MORSETTO E VETRO
 TERMICO 24V

300793506008

VETRO RICAMBIO (mm. 345x195)

300793506018

VETRO RICAMBIO TERMICO 24V

300793501016

MORSETTO NERO (Ø mm.20)

300793501026

MORSETTO GRIGIO (Ø mm.20)



COPPA RICAMBIO
SERIE AUTOCARRO TURBO FIAT
OM-MAGIRUS DEUTZ 190 TURBO

300793507004

COPPA NERA C/MORSETTO

300793507009

 COPPA NERA C/MORSETTO E VETRO
 TERMICO 24V

300793523004

COPPA GRIGIA C/MORSETTO

300793523009

 COPPA GRIGIA C/MORSETTO E VETRO
 TERMICO 24V

300793507008

VETRO RICAMBIO (mm. 345x195)

300793507018

VETRO RICAMBIO TERMICO 24V

300793501016

MORSETTO NERO (Ø mm.20)

300793501026

MORSETTO GRIGIO (Ø mm.20)



CODICE

DESCRIZIONE

300793534000

**SPECCHIO "GUARDA
RIMORCHIO" UNIVERSALE
ADATTABILE SU ASTE
∅ DA 16 A 20 mm.**

COLORE GRIGIO (mm. 270x160)



300793535000

**SPECCHIO "GUARDARUOTA"
UNIVERSALE ADATTABILE ALLE
CABINE DI TUTTI GLI
AUTOCARRI**

**COMPLETO COLORE GRIGIO
(mm. 270x160)**



CODICE	DESCRIZIONE	
300793522004	COPPA RICAMBIO <u>FIAT 682-690 643-650 e derivati</u> <u>COLORE NERO</u>	
300793522008	COPPA C/MORSETTO (mm. 250x170)	
300793509016	VETRO RICAMBIO R.500 (mm. 245x168)	
300793509016	MORSETTO NERO (Ø mm.18)	
300793550004	COPPA RICAMBIO <u>FIAT - OM - AUTOBUS</u> <u>COLORE NERO</u>	
300793550008	COPPA C/MORSETTO (mm. 325x185)	
300793501016	VETRO RICAMBIO (mm. 176x314)	
300793501016	MORSETTO NERO (Ø mm. 20)	
300793436008	FIAT DUCATO IVECO DAILY (1990 →) <u>ATTACCO A MOLLA</u>	
300793436308	PIASTRA COMPLETA DI VETRO PIASTRA COMPLETA DI VETRO TERMICO 24V	
300793439208	DUCATO 2000 PIASTRA COMPLETA DI VETRO CURVO SUPERIORE <u>ATTACCO A MOLLA</u>	
300793439408	DESTRO	
300793439108	DESTRO TERMICO 12V	
300793439508	SINISTRO	
300793439508	SINISTRO TERMICO 12V	