

EMMEDE



CERTIFICATO

Nr 50 100 6553

Si attesta che / Hiermit wird bescheinigt, dass

**IL SISTEMA QUALITÀ DI
DAS QUALITÄTSMANAGEMENTSYSTEM DES UNTERNEHMENS**



EMMERRE S.r.l.

SEDE PRINCIPALE:

VIA VERGA 82

I-10036 SETTIMO TORINESE (TO)

MAGAZZINO:

VIA VERGA 64

I-10036 SETTIMO TORINESE (TO)

È CONFORME AI REQUISITI DELLA NORMA
DEN ANFORDERUNGEN FOLGENDER NORM ENTSPRICHT

UNI EN ISO 9001:2000

Riferirsi al manuale della qualità per i dettagli delle esclusioni
ai requisiti della norma ISO 9001:2000

*Bezugnahme auf das Qualitätshandbuch für die Einzelheiten der Ausnahmen der
Anforderungen der Norm ISO 9001:2000*

Questo certificato è valido per il seguente campo di applicazione
Dieses Zertifikat gilt für den Geltungsbereich

**Commercializzazione di ricambi e preparazione kit di
ricambi meccanici per veicoli commerciali, industriali e
rimorchi (EA 29a)**

**Vertrieb von Ersatzteilen und Zusammenstellung von
mechanischen Ersatzgruppen für Nutz- und
Handelsfahrzeuge und Anhänger (EA 29a)**

Data/ Datum

2007-02-20

SINCERT

ACCREDITED TO THE SCHEME OF CERTIFICATION BY UNIFORM

SGQ N° 049A
SGA N° 018D
SCR N° 006F
SSI N° 005G
PRD N° 061B

Membro degli Accordi di Mutuo Riconoscimento EA e IAF
Signatory of EA and IAF Mutual Recognition Agreements

Per l'Organismo di Certificazione
Für die Zertifizierungsstelle
TÜV Italia S.r.l.

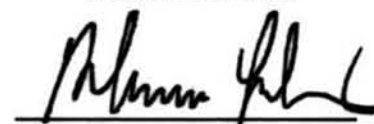

Alessio Galfazzo
Technical Responsible



"La validità del presente certificato è subordinata a sorveglianza periodica a 12 mesi e al riesame completo del sistema di gestione aziendale con periodicità triennale"

"Die Gültigkeit dieses Zertifikates unterliegt der regelmäßigen jährlichen Überwachung und der dreijährigen vollständigen Prüfung des Managementsystems der Gesellschaft"

TECHNO BRAKE®

LINEA DISCHI E PASTIGLIE FRENO
BRAKE DISC AND BRAKE PADS LINE

30
EMMERRE
anniversary

Ministero delle Infrastrutture e dei Trasporti

RAMO TRASPORTI (D.P.R. 8.12.2007, n.271)
Direzione Generale Territoriale del Nord-Ovest
CENTRO PROVA AUTOVEICOLI TORINO

COMUNICAZIONE

Riguardante:
OMOLOGAZIONE CONCESSA

Del complesso guarnizioni freno di ricambio
in applicazione del Regolamento n° 90

Omologazione n°: E3 90R-01101/001
Estensione n°: 00

1. Marchio (Denominazione commerciale data dal costruttore):
TECHNOBRAKE

2. Tipo e descrizione commerciale generale:
960944

3. Mezzi di identificazione del tipo, se marchiati sul componente:
TECHNOBRAKE - 960944 mediante penna laser

4. Posizione della marcatura:
sul retro della piastra metallica

5. Categoria veicolo:
N3 - M3 - O4 vedi elenco allegato I

6. Nome e indirizzo del costruttore:
EMMERRE s.r.l. - 10036 Settimo Tse (TO) - Via Verga, 82

**IL MARCHIO PER LA
VOSTRA SICUREZZA
THE TRADEMARK FOR YOUR
SAFETY
DISTRIBUITO DA:
DISTRIBUTED BY:**

EMMERRE

BANCO PER DETERMINAZIONE DEL COEFFICIENTE D'ATTRITO BENCH TO DETERMINE FRICTION COEFFICIENT

Normative di riferimento: E/ECE R90, annesso 8 - SAE J6661
Standard reference: E/ECE R90, annex 8 - SAE J6661



Sul banco viene montato un provino di 6,5 cm che, dopo essere stato adattato alla controparte rotante, viene sottoposto a cicli di frenatura con intermittenza o continuità, velocità di strisciamento, pressione e temperatura variabili in funzione del test impostato. I risultati consentono di valutare il coefficiente d'attrito nelle diverse condizioni di frenatura e l'usura del materiale a fine prova.

A sample of 6,5 cm gets on the bench, and it is subjected to many intermittent cycles of braking. The results allow to value the friction coefficient in different braking conditions and the wear of the material at the end of the test.

BANCO PER LA PROVA DI COMPRIMIBILITA' BENCH FOR THE TEST OF COMPESSIBILITY

Standard di riferimento: UNI EN ISO 6310-2-2001
Standard reference: UNI EN ISO 6310-2-2001



Il banco consente di valutare la comprimibilità del materiale frenante a temperatura ambiente o a 400°C, secondo la normativa.

The bench allows to value the compressibility of the braking material at a room temperature or at 400°C in accordance with the standard reference UNI EN ISO 6310-2-2001

M,ACCHINA PER LA PROVA DI DISTACCO A TAGLIO MACHINE FOR THE TEST OF CUTTING SEPARATION

Standard di riferimento: UNI EN ISO 6312-2-2001
Standard reference: UNI EN ISO 6312-2-2001

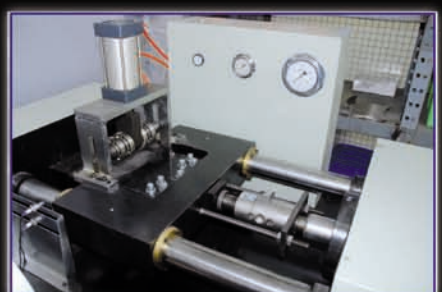

Il banco consente di valutare la forza da applicare alla pastiglia freno per staccare la parte frenante dal relativo supporto metallico. Il carico di punta rilevato viene diviso per la superficie frenante per ottenere il carico di distacco specifico (N/cm²)

The bench allows to value the strenght that we have to put on the brake pad, in order to remove the braking part to the metal support. The load found will be divided with the braking surface to obtain the specific separation load (N/cm²).

EMMERDE

EDIZIONE 2009
EDITION 2009



TECHNO
BRAKE®



TECHNO
BRAKE®

LINEA FRENO
BRAKE SYSTEM
SYSTEME DE FREINAGE
LINEA DE FRENO
BREMSYSTEM
ТОРМОЗНАЯ СИСТЕМА
نظام الفرامل

LINEA STERZO
STEERING LINE
DE DIRECTION
DE DIRECCION
LENKSYSTEM
система управления
نظام القيادة

LINEA VARIE
VARIABLES PARTS
CHANGES DIVERS
LOS RECAMBIOS
HOER ARTIKELN
в КОМПОНЕНТЫ
ة وعون سام را ي غ ع ط و

FREDDAMENTO
COOLING SYSTEM
FROIDISSEMENT
REFRIGERACION
KUHLSYSTEM
охлаждения
نظام التبريد

DI COMMERCIAL
COMMERCIAL VEHICLES
VEHICULES UTILITAIRES
VEHICULOS COMERCIALES
NUTZFAHRZEUGE
грузовый транспорт
النقل الخفيف



EMMERDE

TECHNO
BRAKE®

ECE-R90 (E3)



**TECHNO
BRAKE®**



*HQ
High Quality Line...
E3 - 90R*



**LINEA FRENO
BRAKE SYSTEM
SYSTEME DE FREINAGE
LINEA DE FRENOS
BREMSSYSTEM
ТОРМОЗНАЯ СИСТЕМА
نظام الفرامل**

EMMEDE



2009

EMMERRE**TECHNO
BRAKE®**
**ARTICOLI NUOVI INSERITI
NEL CATALOGO FRENI
2009**
**NEW ARTICLES INCLUDED IN
BRAKE CATALOGUE
2009**
DISCHI FRENO - BRAKE DISCS

EMMERRE	Adattabile - Adaptable	Applicazione - Application	Pagina - Page
960188	71740118	FIAT	23
960189	71740117	FIAT	24
960221	5001860184	IVECO BUS	180
960222	2994031	IVECO BUS	178
960224	2994084	IVECO BUS	179
960225	050018644980	RENAULT	161
960227	5010260102-5010216932	RENAULT	142
960256	80500001043	GASOLONE	30
960317	9434210312	MERCEDES	119
960350	MBR 9001 - 68323233	ROR	202
960397	120015000188	LECINENA	197
960399	120015000005.V	LECINENA	198
960404	2996327	IVECO	78
960405	2996328 - 2995812	IVECO	79
960406	2996329	IVECO	80
960407	3095673	VOLVO	169
960409	1908179	IVECO	64
960422	9064230112	MERCEDES	106
960564	9064210012	MERCEDES	104
960565	9064230012	MERCEDES	105
960694	2996028	IVECO	53
960695	2996027	IVECO	52
960696	2996131	IVECO	49
960697	2996122	IVECO	54
960698	2996049	IVECO	55

EMMERRE**TECHNO
BRAKE®**
**ARTICOLI NUOVI INSERITI
NEL CATALOGO FRENI
2009**
**NEW ARTICLES INCLUDED IN
BRAKE CATALOGUE
2009**
PASTIGLIE FRENO - BRAKE PADS

WVA	EMMERRE	Rif. Or. / Ref. O.E.	Applicazione - Application	Pagina - Page
23858	960428	77362216	FIAT	20-21-22
23919	960190	77362274	FIAT	23-24
23920	960190	77362274	FIAT	23-24
29068	960897	1906353	IVECO	64
29059	960944/C	Adattabile SB7	DAF-IVECO-MERCEDES-SCANIA-BPW ASSALI MERCEDES-LECINENA-SAF-SMB	11-74-76-118-120-162 190-192-193-196-197 198-208-210-215
29061	960944/C	Adattabile SB7	DAF-IVECO-MERCEDES-SCANIA-BPW ASSALI MERCEDES-LECINENA-SAF-SMB	11-74-76-118-120-162 190-192-193-196-197 198-208-210-215
29077	960943	AMPA694	DAF	5
29087	960944/C	Adattabile SB7	DAF-IVECO-MERCEDES-SCANIA-BPW ASSALI MERCEDES-LECINENA-SAF-SMB	11-74-76-118-120-162 190-192-193-196-197 198-208-210-215
29092	960943	AMPA694	DAF	5
29095	960948/C	Adattabile SB6	MAN-MERCEDES-BPW-SAF-SMB	91-115-116-185-186-187 188-189-205-207-214
29105	960944/C	Adattabile SB7	DAF-IVECO-MERCEDES-SCANIA BPW-ASSALI MERCEDES-LECINENA SAF-SMB	11-74-76-118-120-162 190-192-193-196-197 198-208-210-215
29108	960944/C	Adattabile SB7	DAF-IVECO-MERCEDES-SCANIA BPW-ASSALI MERCEDES-LECINENA SAF-SMB	11-74-76-118-120-162 190-192-193-196-197 198-208-210-215
29122	961015	42555669	IVECO	54
29142	960945	1440504	DAF	9-10
29150	960901	2995552	IVECO BUS	178-179
29167	960997/C	-	BPW	195
29171	960996/C	-	BPW	194
29173	960270	5001864365	RENAULT	146-148-150-152-154
29173	960271	20568712	VOLVO	169
29174	970006	20568711	VOLVO	172-173
29192	960890	0054205220	MERCEDES	104-105
29200	960427	0044208220	MERCEDES	104
29204	970006	20568711	VOLVO	172-173
29122	960896	0044208120	MERCEDES	106
29142	960272	5001855902	RENAULT	149-151-153-155
-	960410	8973292660	ISUZU	31
-	960411	8971686340	ISUZU	32-33
-	960412	8970947100	ISUZU	32
-	960895	42555633	IVECO	55

EMMERRE**TECHNO
BRAKE®**
**ARTICOLI NUOVI INSERITI
NEL CATALOGO FRENI
2009**
**NEW ARTICLES INCLUDED IN
BRAKE CATALOGUE
2009**
INDICATORI USURA - BRAKE INDICATOR

EMMERRE	Adattabile - Adaptable	Applicazione - Application	Pagina - Page
960434	68325408	RENAULT-VOLVO	159-160-161-172-173
960435	9015400317	MERCEDES	105
960440	-	RENAULT	147-149-151-153-155
960529	-	BPW	191
960530	-	ROR	203
960531	-	ROR	203
960532	-	ROR	203
960551	68323004	DAF	9
960553	81508226015	MAN	84-86-88-90-96
960676	2995553	IVECO BUS	178-179
960702	68321484	RENAULT	145
960824	9065401417 - 9065401517	MERCEDES	104

EMMERRE



TECHNO BRAKE®

**ARTICOLI NUOVI INSERITI
NEL CATALOGO FRENI
2009**

**NEW ARTICLES INCLUDED IN
BRAKE CATALOGUE
2009**

PINZE E KIT REVISIONE - BRAKE CALIPER AND BRAKE REPAIRING

EMMERRE	Adatt. - Adaptable	Applicazione - Application	Pagina - Page
960004	93191658	IVECO	236
960005	93191659	IVECO	237
960009	93162033	IVECO	236
960013	42555635	IVECO	230
960014	42555637	IVECO	230
960015	42555636	IVECO	229
960016	42555417	IVECO	229
960017	93161181	IVECO	229
960026	93160387	IVECO	229
960077	93161429	IVECO	237
960079	93159285	IVECO	237
960080	93161244	IVECO	238
960081	42538003	IVECO	238
960082	8124735	IVECO	238
960083	93161471	IVECO	238
960084	93161475	IVECO	239
960085	93161908	IVECO	239
960086	93161559	IVECO	239
960087	93161192	IVECO	239
960088	93161189	IVECO	240
960090	93160388	IVECO	230
960091	93160389	IVECO	230
960157	3092329	VOLVO	250
960257	3092261	VOLVO	250
960258	85102095	VOLVO	250
960259	85102096	VOLVO	249
960260	85102093	VOLVO	249
960261	3092267	VOLVO	249
960262	3092262	MERITOR - VOLVO	249
960263	3092263	MERITOR - VOLVO	248
960264	3095626	MERITOR	248
960265	85102094	MERITOR-ROR-VOLVO	248
960266	85102092	MERITOR-RENAULT-VOLVO	248
960267	3092264	MERITOR-VOLVO-ROR	247
960268	-	MERITOR-MAN-RENAULT-ROR	247
960269	-	MERITOR-MAN-MAN BUS	247
960273	-	MERITOR-MAN-RENAULT-ROR	247
960274	-	MERITOR-MAN	246
960275	-	MERITOR-MAN-MAN BUS-RENAULT-ROR	246
960276	-	MERITOR-MAN-MAN BUS-RENAULT-ROR	246
960277	-	MERITOR-RENAULT-VOLVO BUS	246
960278	-	MERITOR-MERCEDES-MAN-RENAULT-VOLVO BUS	245
960279	-	MERITOR-MERCEDES-MAN-RENAULT-VOLVO BUS	245
960280	-	KNORR	241
960281	-	KNORR	241
960282	-	KNORR	241
960283	-	KNORR	241

EMMERRE**TECHNO
BRAKE®**
**ARTICOLI NUOVI INSERITI
NEL CATALOGO FRENI
2009**
**NEW ARTICLES INCLUDED IN
BRAKE CATALOGUE
2009**
PINZE E KIT REVISIONE - BRAKE CALIPER AND BRAKE REPAIRING

EMMERRE	Adatt. - Adaptable	Applicazione - Application	Pagina - Page
960283	-	KNORR	241
960284	-	KNORR SB6 BPW-DAF-IVECO	242
960285	-	MAN-MERCEDES-SAF-SCANIA KNORR SB6 BPW-DAF-IVECO	242
960286	-	MAN-MERCEDES-SAF-SCANIA KNORR SB6 BPW-DAF-IVECO	242
960287	-	MAN-MERCEDES-SAF-SCANIA KNORR SB7 BPW-DAF-IVECO	242
960288	-	WABCO-SAF-DAF	243
960289	-	WABCO-SAF-DAF	243
960290	-	WABCO	243
960291	-	MERITOR-LUCAS-MAN-MERCEDES-RENAULT	243
960292	-	MERITOR-MAN-MERCEDES	244
960293	-	MERITOR-MAN-MERCEDES	244
960294	-	MERITOR-MAN MERCEDES-RENAULT	244
960295	-	MERITOR-MAN MERCEDES-RENAULT	244
960296	-	MERITOR-LUCAS-RENAULT	245
960297	-	MERITOR-LUCAS-RENAULT	245
960302	-	KNORR-SCANIA	251
960340	-	KNORR-SCANIA	251
960400	3092270	MERITOR-VOLVO	251
960401	3095669	MERITOR-VOLVO	251
960403	3092269	MERITOR-ROR-VOLVO	252
960415	-	WABCO-SAF	252
960416	-	MERITOR-MAN-MERCEDES	252
960420	-	MERITOR-MAN-MERCEDES	252
961001	-	MERITOR-MAN-MAN BUS-RENAULT-ROR	253
961002	3090997	VOLVO	253
961003	3090998	VOLVO	253
975084	99465472	IVECO	221
975085	99465473	IVECO	221
975086	42534119	IVECO	222
975087	42534120	IVECO	222
975088	42534121	IVECO	222
975089	42534122	IVECO	222
975090	42554990	IVECO	221
975091	42554991	IVECO	221
960999/C	-	SAF	240

EMMERRE



TECHNO BRAKE®

**ARTICOLI NUOVI INSERITI
NEL CATALOGO FRENI
2009**

**NEW ARTICLES INCLUDED IN
BRAKE CATALOGUE
2009**

MOZZI RUOTA - WHEEL HUB

EMMERRE	Adatt. - Adaptable	Applicazione - Application	Pagina - Page
931021	BTH1053	IVECO	262
931023	7182032	IVECO	266
931030	7168586	IVECO	263
931031	7168464	IVECO	263
931032	42104691	IVECO	263
931033	7173747	IVECO	264
931034	7173314	IVECO	264
931035	7173696	IVECO	264
931036	7182040	IVECO	264
931037	42115016	IVECO	265
931038	7180909	IVECO	265
931039	7172993	IVECO	265
931040	42101362	IVECO	263
931041	7180797	IVECO	265
931042	7179929	IVECO	266
931043	7179777	IVECO	266
931044	42101918	IVECO	266
931200	59520004	CARDI	272
931201	59510104	CARDI	272
931250	23114100	O/CAVA	273
931251	23115100	O/CAVA	273
931300	125699112	ADIGE VIBERTI	269
931400	0327248460	BPW	270
931401	0327230410	BPW	270
931402	0980106050	BPW	271
931403	0980106580	BPW	271
931404	0980106030	BPW	270
931406	0980106070	BPW	270
931500	14204562	ROR	275
931501	14225425	ROR	275
931502	14224748	ROR	275
931503	14219784	ROR	276
931504	14203219	ROR	276
931505	14210885	ROR	276
931506	14226121	ROR	277
931507	14227483	ROR	277
931508	14226120	ROR	277
931600	3434365000	SAF	278
931601	1146200402	SAF	278
931700	402029X100	NISSAN	267
931701	43202F3903	NISSAN	267
931750	1697346	DAF	255
931751	1391617	DAF	255
931800	1382884	SCANIA	268
931801	1480933	SCANIA	268
931802	1414154	SCANIA	268
931820	0003500535	ASSALI MERCEDES	274
962000	7180039	IVECO	260

EMMERRE



TECHNO BRAKE®

**ARTICOLI NUOVI INSERITI
NEL CATALOGO FRENI
2009**

**NEW ARTICLES INCLUDED IN
BRAKE CATALOGUE
2009**

MASSE -GANASCE- WHEEL BRAKE-SHOE SET-BRAKE REPAIRING-BRAKE DRUM

	Adatt. - Adaptable	Applicazione - Application	Pagina - Page
960511	42537942	IVECO	307
960561	2992448	IVECO	341
960601	42538062	IVECO	307
960603	42538066	IVECO	307
960858	8547781	IVECO	356
960951	42538063	IVECO	306
960965	42538064	IVECO	306
961043	93161954	IVECO	306
961050	77363479	FIAT	348
962501	42064491	IVECO	345
962504	4756032	IVECO	345
962505	93163852	IVECO	345
963028	42063178	IVECO	345
963029	-	IVECO	345
963090	5010145932	RENAULT	346
963091	5010145933	RENAULT	346
963092	5010145930	RENAULT	346
963093	5010145931	RENAULT	346
963096	5001829350	RENAULT	346
963502	-	ASTRA	281
963503	-	ASTRA	281
963518	42550957	IVECO	340
963907	98464849	IVECO	300
963908	98464850	IVECO	300
970120	2995817	IVECO	290
970131	504093276	IVECO	289
970132	504093277	IVECO	289

EMMERRE**TECHNO
BRAKE®**
**ARTICOLI NUOVI INSERITI
NEL CATALOGO FRENI
2009**
**NEW ARTICLES INCLUDED IN
BRAKE CATALOGUE
2009**
ANELLI PARAOLIO - OIL SEAL

EMMERRE	Adatt. - Adaptable	Applicazione - Application	Pagina - Page
101027	40101113	IVECO	371
101512	42127773	IVECO	373

IMPIANTO IDRAULICO - HYDRAULIC SYSTEM

EMMERRE	Adatt. - Adaptable	Applicazione - Application	Pagina - Page
908799	42063311	IVECO	416
908800	42100180	IVECO	416
908810	4726714	IVECO	421
908811	4853409	IVECO	416
908813	41211005	IVECO	421
908823	41211006	IVECO	421
964003	-	IVECO	411
964035	4817854	IVECO	413
964011	4844302	IVECO	411
964223	-06902317-0	NISSAN	414

EMMERDE

TECHNO
BRAKE®

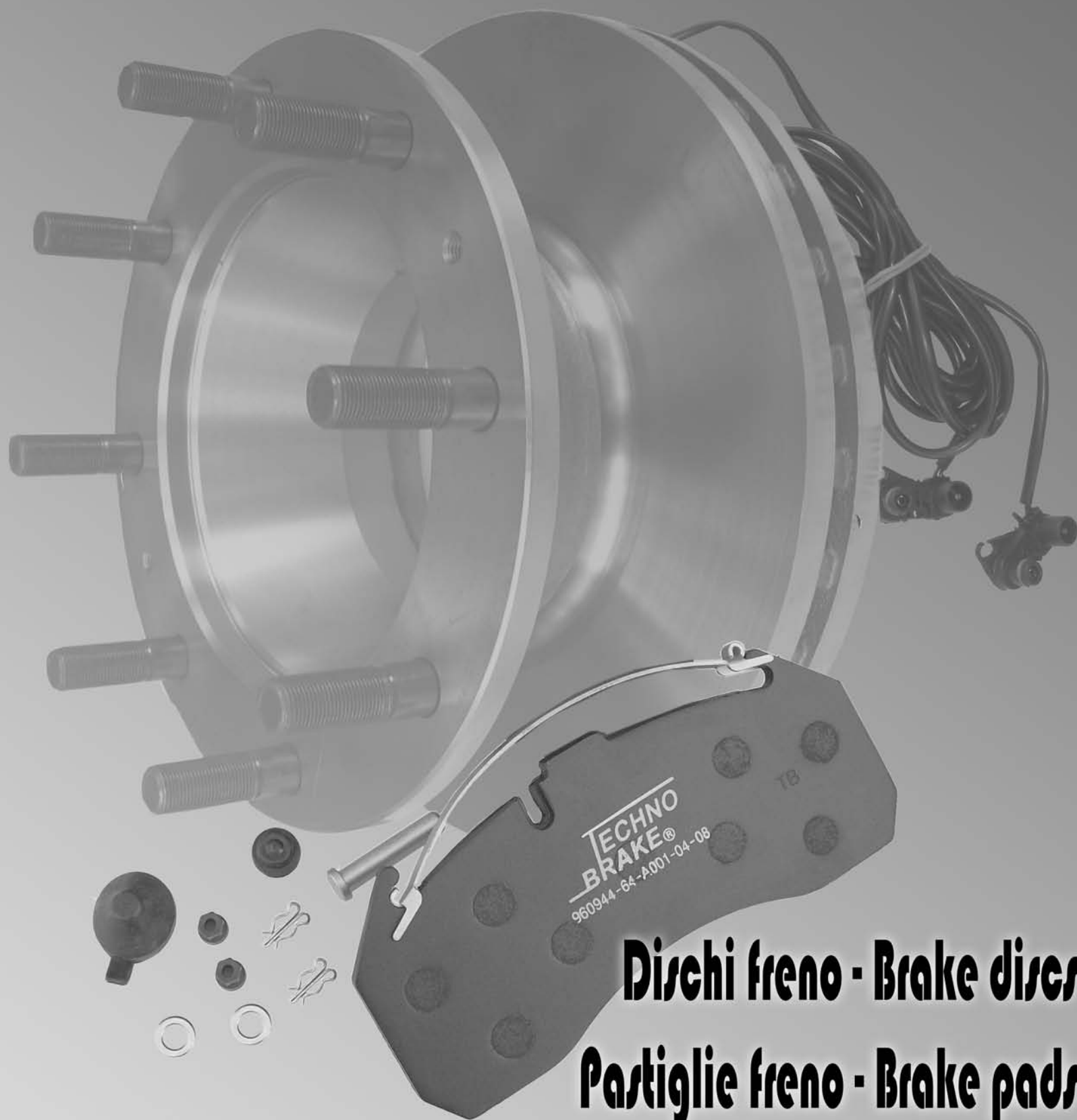

Dischi freno - Brake discs

Pastiglie freno - Brake pads

Indicatori usura - Brake wear indicators

TIPO DI VEICOLO / VEHICLE TYPE

DAF (Impianto PERROT - PERROT system)

FA 45 (05/91-12/00)

FA 500 (12/77-12/79)

FA 600 (12/86-12/92)

FA 700 (12/75-12/79)

FA 800 (05/87-08/91)

FA 900 (01/75-11/88)

FA 1000 (12/86-12/92)

FA 1100 (11/81-11/90)



ILLUSTRAZIONE / ILLUSTRATION	NOSTRO RIFERIMENTO OUR REFERENCE	RIFERIMENTO COSTRUTTORE O.E. REFERENCE
<p>TH min. 24,50 mm.</p> <p>10 fori - 10 Holes</p> <p>Ø 119 mm.</p>  <p>122 mm.</p> <p>26 mm.</p> <p>Ø 315 mm.</p>	960304	PAK 3545
DESCRIZIONE / DESCRIPTION		
<p>Disco freno assale anteriore Brake disc front axle</p> <p>Fascia AUTOVENTILANTE SELF-VENTILATED Band</p> 		



ILLUSTRAZIONE / ILLUSTRATION	NOSTRO RIFERIMENTO OUR REFERENCE	RIFERIMENTO COSTRUTTORE O.E. REFERENCE								
 <p>E3 90R</p>	960942	BBU 8177								
DESCRIZIONE / DESCRIPTION										
<p>Serie pastiglie freno anteriori - Set of brake pads front</p> <table border="1"> <thead> <tr> <th>WVA</th> <th>Larghezza Width - mm.</th> <th>Altezza Height - mm.</th> <th>Spessore Thickness - mm.</th> </tr> </thead> <tbody> <tr> <td>29024 29017</td> <td>191</td> <td>87</td> <td>23</td> </tr> </tbody> </table> 			WVA	Larghezza Width - mm.	Altezza Height - mm.	Spessore Thickness - mm.	29024 29017	191	87	23
WVA	Larghezza Width - mm.	Altezza Height - mm.	Spessore Thickness - mm.							
29024 29017	191	87	23							

ILLUSTRAZIONE / ILLUSTRATION	NOSTRO RIFERIMENTO OUR REFERENCE	RIFERIMENTO COSTRUTTORE O.E. REFERENCE
DESCRIZIONE / DESCRIPTION		

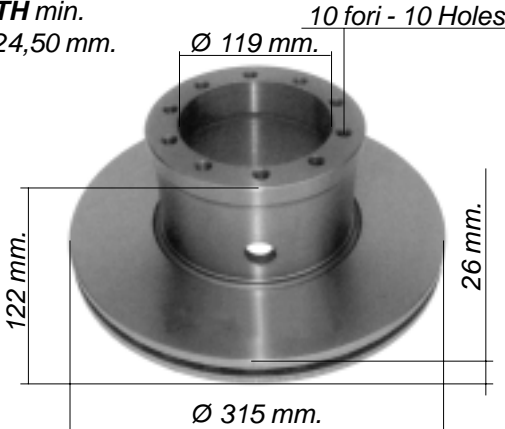
TIPO DI VEICOLO / VEHICLE TYPE

DAF (Impianto PERROT - PERROT system)

FA 45 (05/91-12/00)

FA 1000 (12/86-12/92)

ILLUSTRAZIONE / ILLUSTRATION

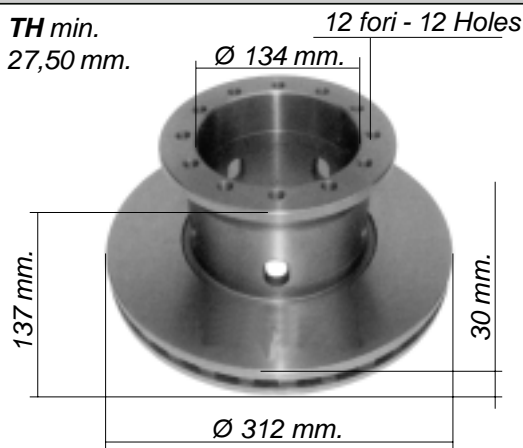

NOSTRO RIFERIMENTO OUR REFERENCE

960303

RIFERIMENTO COSTRUTTORE O.E. REFERENCE

PAK 3546 - PAK 5513

DESCRIZIONE / DESCRIPTION

Disco freno assale anteriore
Brake disc front axle

Fascia AUTOVENTILANTE
SELF-VENTILATED Band



ILLUSTRAZIONE / ILLUSTRATION



NOSTRO RIFERIMENTO OUR REFERENCE

960942

RIFERIMENTO COSTRUTTORE O.E. REFERENCE

BBU 8177

DESCRIZIONE / DESCRIPTION

Serie pastiglie freno anteriori - Set of brake pads front

WVA	Larghezza Width - mm.	Altezza Height - mm.	Spessore Thickness - mm.
29024 29017	191	87	23



ILLUSTRAZIONE / ILLUSTRATION

NOSTRO RIFERIMENTO OUR REFERENCE



RIFERIMENTO COSTRUTTORE O.E. REFERENCE

DESCRIZIONE / DESCRIPTION

TIPO DI VEICOLO / VEHICLE TYPE

DAF (Impianto PERROT - PERROT system)

FA 55 (11/95-12/00)

ILLUSTRAZIONE / ILLUSTRATION	NOSTRO RIFERIMENTO OUR REFERENCE	RIFERIMENTO COSTRUTTORE O.E. REFERENCE								
<p>TH min. 38,00 mm.</p> <p>10 fori - 10 Holes</p> <p>Ø 155 mm.</p> <p>128 mm.</p> <p>44 mm.</p> <p>Ø 375 mm.</p> 	960389	AMPA014 - AMPB860 NJK2785								
DESCRIZIONE / DESCRIPTION										
<p>Disco freno assale anteriore Brake disc front axle</p> <p>Fascia AUTOVENTILANTE SELF-VENTILATED Band</p> 										
ILLUSTRAZIONE / ILLUSTRATION	NOSTRO RIFERIMENTO OUR REFERENCE	RIFERIMENTO COSTRUTTORE O.E. REFERENCE								
	960943	AMPA 694								
DESCRIZIONE / DESCRIPTION										
<p>Serie pastiglie freno anteriori - Set of brake pads front</p> <table border="1" data-bbox="646 1451 1236 1624"> <thead> <tr> <th>WVA</th> <th>Larghezza Width - mm.</th> <th>Altezza Height - mm.</th> <th>Spessore Thickness - mm.</th> </tr> </thead> <tbody> <tr> <td>29077 29092</td> <td>204,50</td> <td>106</td> <td>27</td> </tr> </tbody> </table> 			WVA	Larghezza Width - mm.	Altezza Height - mm.	Spessore Thickness - mm.	29077 29092	204,50	106	27
WVA	Larghezza Width - mm.	Altezza Height - mm.	Spessore Thickness - mm.							
29077 29092	204,50	106	27							
ILLUSTRAZIONE / ILLUSTRATION	NOSTRO RIFERIMENTO OUR REFERENCE	RIFERIMENTO COSTRUTTORE O.E. REFERENCE								
DESCRIZIONE / DESCRIPTION										

TIPO DI VEICOLO / VEHICLE TYPE

DAF (Impianto KNORR - KNORR system)
(Ruote da 17,5" - Wheels from 17,5")

LF 45 (escluso 12 ton. da 01/01 - Excluded 12 ton. from 01/01)

ILLUSTRAZIONE / ILLUSTRATION	NOSTRO RIFERIMENTO OUR REFERENCE	RIFERIMENTO COSTRUTTORE O.E. REFERENCE								
	960368	1408670 1408252 - 1400163								
DESCRIZIONE / DESCRIPTION										
<p>Disco freno assale anteriore Brake disc front axle</p> <p>Fascia AUTOVENTILANTE SELF-VENTILATED Band</p>										
ILLUSTRAZIONE / ILLUSTRATION	NOSTRO RIFERIMENTO OUR REFERENCE	RIFERIMENTO COSTRUTTORE O.E. REFERENCE								
	960969	1436901								
DESCRIZIONE / DESCRIPTION										
<p>Serie pastiglie freno anteriore e posteriore Set of brake pads front and rear</p> <table border="1"> <thead> <tr> <th>WVA</th> <th>Larghezza Width - mm.</th> <th>Altezza Height - mm.</th> <th>Spessore Thickness - mm.</th> </tr> </thead> <tbody> <tr> <td>29088</td> <td>175,50</td> <td>85,60</td> <td>26</td> </tr> </tbody> </table>			WVA	Larghezza Width - mm.	Altezza Height - mm.	Spessore Thickness - mm.	29088	175,50	85,60	26
WVA	Larghezza Width - mm.	Altezza Height - mm.	Spessore Thickness - mm.							
29088	175,50	85,60	26							
ILLUSTRAZIONE / ILLUSTRATION	NOSTRO RIFERIMENTO OUR REFERENCE	RIFERIMENTO COSTRUTTORE O.E. REFERENCE								
<p>Lunghezza / Length 290 mm.</p>	960801	-								
DESCRIZIONE / DESCRIPTION										
<p>Kit segnalatori usura freno anteriore e posteriore completi di supporti (pz. 2) Set of brake wear indicators front and rear with supports (2 pcs.)</p>										

TIPO DI VEICOLO / VEHICLE TYPE

DAF (Impianto KNORR - KNORR system)
(Ruote da 17,5" - Wheels from 17,5")

LF 45 (escluso 12 ton. da 01/01 - Excluded 12 ton. from 01/01)

ILLUSTRAZIONE / ILLUSTRATION	NOSTRO RIFERIMENTO OUR REFERENCE	RIFERIMENTO COSTRUTTORE O.E. REFERENCE								
 <p>TH min. 31,00 mm.</p> <p>Ø 149 mm.</p> <p>12 fori - 12 Holes</p> <p>120 mm.</p> <p>35 mm.</p> <p>Ø 329 mm.</p>	960369	1408672 1408254 - 1400273								
DESCRIZIONE / DESCRIPTION										
<p>Disco freno assale posteriore Brake disc rear axle</p> <p>Fascia AUTOVENTILANTE SELF-VENTILATED Band</p> 										
ILLUSTRAZIONE / ILLUSTRATION	NOSTRO RIFERIMENTO OUR REFERENCE	RIFERIMENTO COSTRUTTORE O.E. REFERENCE								
 <p>E3 90R</p>	960969	1436901								
DESCRIZIONE / DESCRIPTION										
<p>Serie pastiglie freno anteriore e posteriore Set of brake pads front and rear</p> <table border="1"> <thead> <tr> <th>WVA</th> <th>Larghezza Width - mm.</th> <th>Altezza Height - mm.</th> <th>Spessore Thickness - mm.</th> </tr> </thead> <tbody> <tr> <td>29088</td> <td>175,50</td> <td>85,60</td> <td>26</td> </tr> </tbody> </table> 			WVA	Larghezza Width - mm.	Altezza Height - mm.	Spessore Thickness - mm.	29088	175,50	85,60	26
WVA	Larghezza Width - mm.	Altezza Height - mm.	Spessore Thickness - mm.							
29088	175,50	85,60	26							
ILLUSTRAZIONE / ILLUSTRATION	NOSTRO RIFERIMENTO OUR REFERENCE	RIFERIMENTO COSTRUTTORE O.E. REFERENCE								
 <p>Lunghezza / Length 290 mm.</p>	960801	-								
DESCRIZIONE / DESCRIPTION										
<p>Kit segnalatori usura freno anteriore e posteriore completi di supporti (pz. 2) Set of brake wear indicators front and rear with supports (2 pcs.)</p>										

TIPO DI VEICOLO / VEHICLE TYPE

DAF (Impianto KNORR - KNORR system)
(Ruote da 17,5" - Wheels from 17,5")





LF 45 (12 ton. da 01/01 - 12 ton. from 01/01)

ILLUSTRAZIONE / ILLUSTRATION	NOSTRO RIFERIMENTO OUR REFERENCE	RIFERIMENTO COSTRUTTORE O.E. REFERENCE								
	960375	1403758 1408253								
DESCRIZIONE / DESCRIPTION										
<p>Disco freno assale anteriore Brake disc front axle</p> <p>Fascia AUTOVENTILANTE SELF VENTILATED Band</p>										
ILLUSTRAZIONE / ILLUSTRATION	NOSTRO RIFERIMENTO OUR REFERENCE	RIFERIMENTO COSTRUTTORE O.E. REFERENCE								
	960969	1436901								
DESCRIZIONE / DESCRIPTION										
<p>Serie pastiglie freno anteriore e posteriore Set of brake pads front and rear</p> <table border="1"> <thead> <tr> <th>WVA</th> <th>Larghezza Width - mm.</th> <th>Altezza Height - mm.</th> <th>Spessore Thickness - mm.</th> </tr> </thead> <tbody> <tr> <td>29088</td> <td>175,50</td> <td>85,60</td> <td>26</td> </tr> </tbody> </table>			WVA	Larghezza Width - mm.	Altezza Height - mm.	Spessore Thickness - mm.	29088	175,50	85,60	26
WVA	Larghezza Width - mm.	Altezza Height - mm.	Spessore Thickness - mm.							
29088	175,50	85,60	26							
ILLUSTRAZIONE / ILLUSTRATION	NOSTRO RIFERIMENTO OUR REFERENCE	RIFERIMENTO COSTRUTTORE O.E. REFERENCE								
<p>Lunghezza / Length 290 mm.</p>	960801	-								
DESCRIZIONE / DESCRIPTION										
<p>Kit segnalatori usura freno anteriore e posteriore completi di supporti (pz. 2) Set of brake wear indicators front and rear with supports (2 pcs.)</p>										

TIPO DI VEICOLO / VEHICLE TYPE

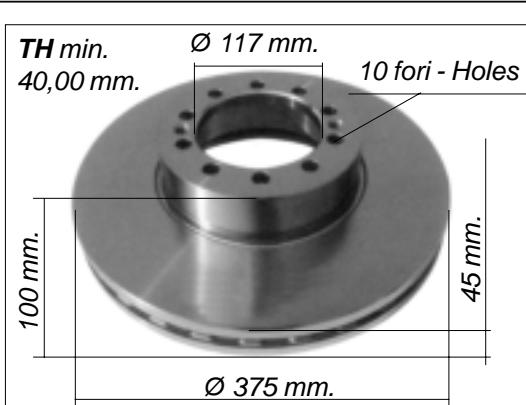
DAF (Impianto WABCO - WABCO system)
(Ruote da 19,5" - Wheels from 19,5")

LF 55 (12-15 ton. da 01/01 - 12-15 ton. from 01/01)

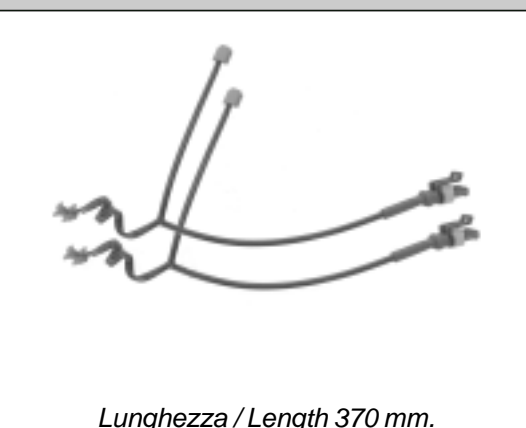
ILLUSTRAZIONE / ILLUSTRATION	NOSTRO RIFERIMENTO OUR REFERENCE	RIFERIMENTO COSTRUTTORE O.E. REFERENCE								
	960376	1400069								
DESCRIZIONE / DESCRIPTION										
<p>Disco freno assale anteriore Brake disc front axle</p> <p>Fascia AUTOVENTILANTE SELF-VENTILATED Band</p> 										
ILLUSTRAZIONE / ILLUSTRATION	NOSTRO RIFERIMENTO OUR REFERENCE	RIFERIMENTO COSTRUTTORE O.E. REFERENCE								
	960945	1440504								
DESCRIZIONE / DESCRIPTION										
<p>Serie pastiglie freno anteriore e posteriore Set of brake pads front and rear</p> <table border="1"> <thead> <tr> <th>WVA</th> <th>Larghezza Width - mm.</th> <th>Altezza Height - mm.</th> <th>Spessore Thickness - mm.</th> </tr> </thead> <tbody> <tr> <td>29142</td> <td>204,60</td> <td>99,60</td> <td>30</td> </tr> </tbody> </table> 			WVA	Larghezza Width - mm.	Altezza Height - mm.	Spessore Thickness - mm.	29142	204,60	99,60	30
WVA	Larghezza Width - mm.	Altezza Height - mm.	Spessore Thickness - mm.							
29142	204,60	99,60	30							
ILLUSTRAZIONE / ILLUSTRATION	NOSTRO RIFERIMENTO OUR REFERENCE	RIFERIMENTO COSTRUTTORE O.E. REFERENCE								
 <p>Lunghezza / Length 370 mm.</p>	960551	68323004								
DESCRIZIONE / DESCRIPTION										
<p>Kit segnalatori usura freno anteriore e posteriore senza supporti (pz. 2) Set of brake wear indicators front and rear without supports (2 pcs.)</p>										

TIPO DI VEICOLO / VEHICLE TYPE

DAF (Impianto WABCO - WABCO system)
(Ruote da 19,5" - Wheels from 19,5")

LF 55 (12-15 ton. da 01/01 - 12-15 ton. from 01/01)

ILLUSTRAZIONE / ILLUSTRATION	NOSTRO RIFERIMENTO OUR REFERENCE	RIFERIMENTO COSTRUTTORE O.E. REFERENCE								
	960377	1400284								
DESCRIZIONE / DESCRIPTION										
<p>Disco freno assale posteriore Brake disc rear axle</p> <p>Fascia AUTOVENTILANTE SELF-VENTILATED Band</p>										
ILLUSTRAZIONE / ILLUSTRATION	NOSTRO RIFERIMENTO OUR REFERENCE	RIFERIMENTO COSTRUTTORE O.E. REFERENCE								
	960945	1440504								
DESCRIZIONE / DESCRIPTION										
<p>Serie pastiglie freno anteriore e posteriore Set of brake pads front and rear</p> <table border="1"> <thead> <tr> <th>WVA</th> <th>Larghezza Width - mm.</th> <th>Altezza Height - mm.</th> <th>Spessore Thickness - mm.</th> </tr> </thead> <tbody> <tr> <td>29142</td> <td>204,60</td> <td>99,60</td> <td>30</td> </tr> </tbody> </table>			WVA	Larghezza Width - mm.	Altezza Height - mm.	Spessore Thickness - mm.	29142	204,60	99,60	30
WVA	Larghezza Width - mm.	Altezza Height - mm.	Spessore Thickness - mm.							
29142	204,60	99,60	30							
ILLUSTRAZIONE / ILLUSTRATION	NOSTRO RIFERIMENTO OUR REFERENCE	RIFERIMENTO COSTRUTTORE O.E. REFERENCE								
<p>Lunghezza / Length 370 mm.</p>	960551	68323004								
DESCRIZIONE / DESCRIPTION										
<p>Kit segnalatori usura freno anteriore e posteriore senza supporti (pz. 2) Set of brake wear indicators front and rear without supports (2 pcs.)</p>										

TIPO DI VEICOLO / VEHICLE TYPE

DAF (Impianto Knorr - Knorr system)

CF 65 - CF 75

CF 85 (da 01/01 - from 01/01)

LF 55 (da 01/01 - from 01/01)

XF 95 (da 09/02 - from 09/02)

XF 105 (da 10/05 - from 10/05)

ILLUSTRAZIONE / ILLUSTRATION

NOSTRO RIFERIMENTO
OUR REFERENCERIFERIMENTO COSTRUTTORE
O.E. REFERENCE**960299**

016405610

DESCRIZIONE / DESCRIPTION

Disco freno assale anteriore e posteriore
Brake disc front and rear axleFascia AUTOVENTILANTE
SELF-VENTILATED BandDISPONIBILE A MAGAZZINO
AVAILABLE ON STOCK

ILLUSTRAZIONE / ILLUSTRATION

NOSTRO RIFERIMENTO
OUR REFERENCERIFERIMENTO COSTRUTTORE
O.E. REFERENCE**960944**

1617343 - 1439324

DESCRIZIONE / DESCRIPTION

Serie pastiglie freno anteriore e posteriore completa di molle,
kit accessori **SENZA** piastre
Set of brake pads front and rear with springs,
kit accessories without plates**BREVETTO PENDENTE**
PENDING PATENT

WVA	Larghezza Width - mm.	Altezza Height - mm.	Spessore Thickness - mm.
29087	247,2	109,7	30
29105			
29108			
29059			



ILLUSTRAZIONE / ILLUSTRATION

NOSTRO RIFERIMENTO
OUR REFERENCERIFERIMENTO COSTRUTTORE
O.E. REFERENCE**960944/C**

-

DESCRIZIONE / DESCRIPTION

Serie pastiglie freno anteriore e posteriore **completa** di
molle, kit accessori e piastre
Set of brake pads front and rear with springs,
kit accessories and plates**BREVETTO PENDENTE**
PENDING PATENT

WVA	Larghezza Width - mm.	Altezza Height - mm.	Spessore Thickness - mm.
29087	247,2	109,7	30
29105			
29108			
29059			
29061			



TIPO DI VEICOLO / VEHICLE TYPE

DAF (Impianto Knorr / Wabco - Knorr / Wabco system)

ILLUSTRAZIONE / ILLUSTRATION



Lunghezza / Length 300 mm.
Tipo Ovale - Oval type

NOSTRO RIFERIMENTO
OUR REFERENCE

960523

RIFERIMENTO COSTRUTTORE
O.E. REFERENCE

-

DESCRIZIONE / DESCRIPTION

Kit segnalatori usura freno (pz. 2)
Set of brake wear indicators (2 pcs.)

ILLUSTRAZIONE / ILLUSTRATION

NOSTRO RIFERIMENTO
OUR REFERENCE

RIFERIMENTO COSTRUTTORE
O.E. REFERENCE

DESCRIZIONE / DESCRIPTION

WVA	Larghezza Width - mm.	Altezza Height - mm.	Spessore Thickness - mm.

ILLUSTRAZIONE / ILLUSTRATION

NOSTRO RIFERIMENTO
OUR REFERENCE

RIFERIMENTO COSTRUTTORE
O.E. REFERENCE

DESCRIZIONE / DESCRIPTION

TIPO DI VEICOLO / VEHICLE TYPE

DUCATO (Impianto Lucas - Lucas system) - **TALENTO** - **PEUGEOT J5** - **CITROEN C25**
(14 q.li - da telaio 155247 - Autobus - Furgonato e pianale piatto)

1.8 (07/82-12/88) - 1.9D (02/87-08/90) - 1.9D (07/90-03/94) - 1.9TD (03/89-08/90)
1.9TD (07/90-03/94) - 2.0 (07/82-08/90) - 2.0 (07/90-03/94) - 2.4D (07/82-12/85)
2.4D (07/90-03/94) - 2.5D (01/86-08/90) - 2.5D (07/90-03/94) - 2.5D 4X4 (01/87-08/90)
2.5TD 4X4 (07/90-03/94) - 2.5TD (01/87-08/90) - 2.5TD 4X4 (01/86-08/90)

ILLUSTRAZIONE / ILLUSTRATION	NOSTRO RIFERIMENTO OUR REFERENCE	RIFERIMENTO COSTRUTTORE O.E. REFERENCE								
	960378	4450931 - 7568501								
DESCRIZIONE / DESCRIPTION										
Disco freno assale anteriore Brake disc front axle										
										
ILLUSTRAZIONE / ILLUSTRATION	NOSTRO RIFERIMENTO OUR REFERENCE	RIFERIMENTO COSTRUTTORE O.E. REFERENCE								
Connettore tondo - Round connector 	960862	9945070 9941207								
DESCRIZIONE / DESCRIPTION										
Serie pastiglie freno anteriore - Set of brake pads front										
<table border="1"> <thead> <tr> <th>WVA</th> <th>Larghezza Width - mm.</th> <th>Altezza Height - mm.</th> <th>Spessore Thickness - mm.</th> </tr> </thead> <tbody> <tr> <td>20741 20787</td> <td>130</td> <td>71,5</td> <td>19</td> </tr> </tbody> </table>			WVA	Larghezza Width - mm.	Altezza Height - mm.	Spessore Thickness - mm.	20741 20787	130	71,5	19
WVA	Larghezza Width - mm.	Altezza Height - mm.	Spessore Thickness - mm.							
20741 20787	130	71,5	19							
										
ILLUSTRAZIONE / ILLUSTRATION	NOSTRO RIFERIMENTO OUR REFERENCE	RIFERIMENTO COSTRUTTORE O.E. REFERENCE								
Connettore tondo - Round connector 	960867	9945076								
DESCRIZIONE / DESCRIPTION										
Serie pastiglie freno anteriore - Set of brake pads front										
<table border="1"> <thead> <tr> <th>WVA</th> <th>Larghezza Width - mm.</th> <th>Altezza Height - mm.</th> <th>Spessore Thickness - mm.</th> </tr> </thead> <tbody> <tr> <td>21205 21206</td> <td>145</td> <td>71,50</td> <td>19,40</td> </tr> </tbody> </table>			WVA	Larghezza Width - mm.	Altezza Height - mm.	Spessore Thickness - mm.	21205 21206	145	71,50	19,40
WVA	Larghezza Width - mm.	Altezza Height - mm.	Spessore Thickness - mm.							
21205 21206	145	71,50	19,40							
										

TIPO DI VEICOLO / VEHICLE TYPE

DUCATO (Impianto Lucas - Lucas system)
(14 q.li - da telaio 154462 - Autobus - Furgonato e pianale piatto)







1.8 (07/82-12/88) - 1.9D (02/87-08/90) - 1.9D (07/90-03/94) - 1.9TD (03/89-08/94)
2.0 (07/82-03/94) - 2.4D (07/82-12/85) - 2.4D (07/90-03/94) - 2.5D (01/86-08/90)
2.5D (07/90-03/94) - 2.5D-TD 4X4 (01/87-03/94) - 2.5TD (01/87-08/90) - 2.5TD 4X4 (01/86-08/90)
TALENTO (14q.li) 1.9D (03/89-03/94)

ILLUSTRAZIONE / ILLUSTRATION	NOSTRO RIFERIMENTO OUR REFERENCE	RIFERIMENTO COSTRUTTORE O.E. REFERENCE								
	960379	7531819								
DESCRIZIONE / DESCRIPTION										
<p>Disco freno assale anteriore Brake disc front axle</p>										
ILLUSTRAZIONE / ILLUSTRATION	NOSTRO RIFERIMENTO OUR REFERENCE	RIFERIMENTO COSTRUTTORE O.E. REFERENCE								
<p>Connettore tondo - Round connector</p>	960862	9945070 9941207								
DESCRIZIONE / DESCRIPTION										
<p>Serie pastiglie freno anteriore - Set of brake pads front</p> <table border="1"> <thead> <tr> <th>WVA</th> <th>Larghezza Width - mm.</th> <th>Altezza Height - mm.</th> <th>Spessore Thickness - mm.</th> </tr> </thead> <tbody> <tr> <td>20741 20787</td> <td>130</td> <td>71,5</td> <td>19</td> </tr> </tbody> </table>			WVA	Larghezza Width - mm.	Altezza Height - mm.	Spessore Thickness - mm.	20741 20787	130	71,5	19
WVA	Larghezza Width - mm.	Altezza Height - mm.	Spessore Thickness - mm.							
20741 20787	130	71,5	19							
ILLUSTRAZIONE / ILLUSTRATION	NOSTRO RIFERIMENTO OUR REFERENCE	RIFERIMENTO COSTRUTTORE O.E. REFERENCE								
<p>Connettore tondo - Round connector</p>	960867	9945076								
DESCRIZIONE / DESCRIPTION										
<p>Serie pastiglie freno anteriore - Set of brake pads front</p> <table border="1"> <thead> <tr> <th>WVA</th> <th>Larghezza Width - mm.</th> <th>Altezza Height - mm.</th> <th>Spessore Thickness - mm.</th> </tr> </thead> <tbody> <tr> <td>21205 21206</td> <td>145</td> <td>71,50</td> <td>19,40</td> </tr> </tbody> </table>			WVA	Larghezza Width - mm.	Altezza Height - mm.	Spessore Thickness - mm.	21205 21206	145	71,50	19,40
WVA	Larghezza Width - mm.	Altezza Height - mm.	Spessore Thickness - mm.							
21205 21206	145	71,50	19,40							

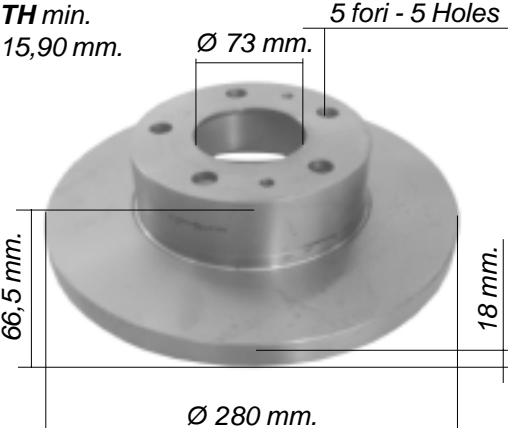
TIPO DI VEICOLO / VEHICLE TYPE

DUCATO (Impianto Lucas - Lucas system)
(14 q.li - Autobus - Furgonato e pianale piatto)

1.9D (04/98-04/02) - 1.9D COMBINATO (06/95-04/02) - 1.9TD (04/98-04/02)
 AUTOBUS - 1.9TD COMBI (08/94-04/02) - 2.0 (03/94-04/02) - 2.5D COMBI (08/94-04/02)
 2.5TDI 4X4(04/97-04/02) - 2.5TDI COMBINATO (08/94-04/02) - 2.5TDI (03/94-04/02)
 2.8D (02/98-04/02) - 2.8TDI (10/97-04/02) - 2.8TDI 4X4 (07/99-04/02) - 2.0 (04/02) - 2.8 JTD (04/02)

ILLUSTRAZIONE / ILLUSTRATION	NOSTRO RIFERIMENTO OUR REFERENCE	RIFERIMENTO COSTRUTTORE O.E. REFERENCE								
<p>TH min. 15,90 mm.</p> <p>5 fori - 5 Holes</p> <p>Ø 73 mm.</p> <p>66,5 mm.</p> <p>18 mm.</p> <p>Ø 280 mm.</p> 	960380	1300500080								
DESCRIZIONE / DESCRIPTION										
<p>Disco freno assale anteriore Brake disc front axle</p> 										
ILLUSTRAZIONE / ILLUSTRATION	NOSTRO RIFERIMENTO OUR REFERENCE	RIFERIMENTO COSTRUTTORE O.E. REFERENCE								
<p>Connettore quadro - Square connector</p> 	960929	77362212 9948626								
DESCRIZIONE / DESCRIPTION										
<p>Serie pastiglie freno anteriore - Set of brake pads front</p> <table border="1"> <thead> <tr> <th>WVA</th> <th>Larghezza Width - mm.</th> <th>Altezza Height - mm.</th> <th>Spessore Thickness - mm.</th> </tr> </thead> <tbody> <tr> <td>21797 21798</td> <td>145</td> <td>61</td> <td>19,7</td> </tr> </tbody> </table> 			WVA	Larghezza Width - mm.	Altezza Height - mm.	Spessore Thickness - mm.	21797 21798	145	61	19,7
WVA	Larghezza Width - mm.	Altezza Height - mm.	Spessore Thickness - mm.							
21797 21798	145	61	19,7							
ILLUSTRAZIONE / ILLUSTRATION	NOSTRO RIFERIMENTO OUR REFERENCE	RIFERIMENTO COSTRUTTORE O.E. REFERENCE								
<p>Connettore tondo - Round connector</p> 	960935	9945810 9948629								
DESCRIZIONE / DESCRIPTION										
<p>Serie pastiglie freno anteriore - Set of brake pads front</p> <table border="1"> <thead> <tr> <th>WVA</th> <th>Larghezza Width - mm.</th> <th>Altezza Height - mm.</th> <th>Spessore Thickness - mm.</th> </tr> </thead> <tbody> <tr> <td>21799 21800</td> <td>160</td> <td>64</td> <td>19,70</td> </tr> </tbody> </table> 			WVA	Larghezza Width - mm.	Altezza Height - mm.	Spessore Thickness - mm.	21799 21800	160	64	19,70
WVA	Larghezza Width - mm.	Altezza Height - mm.	Spessore Thickness - mm.							
21799 21800	160	64	19,70							

TIPO DI VEICOLO / VEHICLE TYPE

DUCATO (Impianto Lucas - Lucas system)
(10-14 q.li dal 03/94 - 04/02 Autobus - Furgonato e pianale piatto)





1.9D - 1.9TD - 2.0 - 2.5D - 2.5TDI - 2.8TDI

ILLUSTRAZIONE / ILLUSTRATION	NOSTRO RIFERIMENTO OUR REFERENCE	RIFERIMENTO COSTRUTTORE O.E. REFERENCE								
	960201	1300501080								
DESCRIZIONE / DESCRIPTION										
<p>Disco freno assale anteriore Brake disc front axle</p> <p>Fascia AUTOVENTILANTE SELF-VENTILATED Band</p>										
ILLUSTRAZIONE / ILLUSTRATION	NOSTRO RIFERIMENTO OUR REFERENCE	RIFERIMENTO COSTRUTTORE O.E. REFERENCE								
<p>Connettore quadro - Square connector</p>	960929	77362212 9948626								
DESCRIZIONE / DESCRIPTION										
<p>Serie pastiglie freno anteriore - Set of brake pads front</p> <table border="1"> <thead> <tr> <th>WVA</th> <th>Larghezza Width - mm.</th> <th>Altezza Height - mm.</th> <th>Spessore Thickness - mm.</th> </tr> </thead> <tbody> <tr> <td>21797 21798</td> <td>145</td> <td>61</td> <td>19,70</td> </tr> </tbody> </table>			WVA	Larghezza Width - mm.	Altezza Height - mm.	Spessore Thickness - mm.	21797 21798	145	61	19,70
WVA	Larghezza Width - mm.	Altezza Height - mm.	Spessore Thickness - mm.							
21797 21798	145	61	19,70							
ILLUSTRAZIONE / ILLUSTRATION	NOSTRO RIFERIMENTO OUR REFERENCE	RIFERIMENTO COSTRUTTORE O.E. REFERENCE								
<p>Connettore tondo - Round connector</p>	960935	9945810 9948629								
DESCRIZIONE / DESCRIPTION										
<p>Serie pastiglie freno anteriore - Set of brake pads front</p> <table border="1"> <thead> <tr> <th>WVA</th> <th>Larghezza Width - mm.</th> <th>Altezza Height - mm.</th> <th>Spessore Thickness - mm.</th> </tr> </thead> <tbody> <tr> <td>21799 21800</td> <td>160</td> <td>64</td> <td>19,70</td> </tr> </tbody> </table>			WVA	Larghezza Width - mm.	Altezza Height - mm.	Spessore Thickness - mm.	21799 21800	160	64	19,70
WVA	Larghezza Width - mm.	Altezza Height - mm.	Spessore Thickness - mm.							
21799 21800	160	64	19,70							

TIPO DI VEICOLO / VEHICLE TYPE

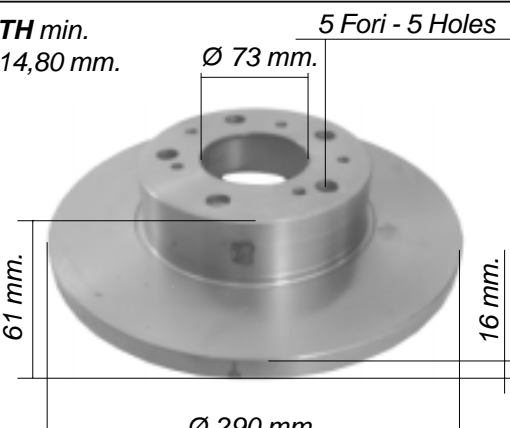
DUCATO (Impianto Lucas - Lucas system)
(18 q.li Autobus - Furgonato e pianale piatto)

1.8 (07/82-12/88) - 1.9D (02/87-08/90) - 1.9D (07/90-03/94) - 1.9TD (03/89-08/90)
 1.9TD (07/90-03/94) - 2.0 (07/82-05/85) - 2.0 (07/90-03/94) - 2.4D (07/82-12/85)
 2.4D (07/90-03/94) - 2.5D (01/86-08/90) - 2.5D (07/90-03/94) - 2.5D 4x4 (01/87-08/90)
 2.5 TD 4x4 (07/90-03/94) - 2.5TD (01/87-08/90) - 2.5TD 4x4 (01/86-08/90)

ILLUSTRAZIONE / ILLUSTRATION	NOSTRO RIFERIMENTO OUR REFERENCE	RIFERIMENTO COSTRUTTORE O.E. REFERENCE								
<p>TH min. 14,80 mm.</p> <p>5 Fori - 5 Holes</p> <p>Ø 73 mm.</p> <p>61 mm.</p> <p>16 mm.</p> <p>Ø 290 mm.</p> 	960381	7538682 - 93500521								
DESCRIZIONE / DESCRIPTION										
Disco freno assale anteriore Brake disc front axle										
										
ILLUSTRAZIONE / ILLUSTRATION	NOSTRO RIFERIMENTO OUR REFERENCE	RIFERIMENTO COSTRUTTORE O.E. REFERENCE								
<p>Connettore quadro - Square connector</p>  <p>E3 90R</p>	960929	77362212 9948626								
DESCRIZIONE / DESCRIPTION										
Serie pastiglie freno anteriore - Set of brake pads front										
<table border="1"> <thead> <tr> <th>WVA</th> <th>Larghezza Width - mm.</th> <th>Altezza Height - mm.</th> <th>Spessore Thickness - mm.</th> </tr> </thead> <tbody> <tr> <td>21797 21798</td> <td>145</td> <td>61</td> <td>19,70</td> </tr> </tbody> </table>			WVA	Larghezza Width - mm.	Altezza Height - mm.	Spessore Thickness - mm.	21797 21798	145	61	19,70
WVA	Larghezza Width - mm.	Altezza Height - mm.	Spessore Thickness - mm.							
21797 21798	145	61	19,70							
										
ILLUSTRAZIONE / ILLUSTRATION	NOSTRO RIFERIMENTO OUR REFERENCE	RIFERIMENTO COSTRUTTORE O.E. REFERENCE								
<p>Connettore tondo - Round connector</p>  <p>E3 90R</p>	960935	9945810 9948629								
DESCRIZIONE / DESCRIPTION										
Serie pastiglie freno anteriore - Set of brake pads front										
<table border="1"> <thead> <tr> <th>WVA</th> <th>Larghezza Width - mm.</th> <th>Altezza Height - mm.</th> <th>Spessore Thickness - mm.</th> </tr> </thead> <tbody> <tr> <td>21799 21800</td> <td>160</td> <td>64</td> <td>19,70</td> </tr> </tbody> </table>			WVA	Larghezza Width - mm.	Altezza Height - mm.	Spessore Thickness - mm.	21799 21800	160	64	19,70
WVA	Larghezza Width - mm.	Altezza Height - mm.	Spessore Thickness - mm.							
21799 21800	160	64	19,70							
										

TIPO DI VEICOLO / VEHICLE TYPE

DUCATO

(18 q.li - Autobus - Furgonato e pianale piatto)

2.0 (03/94-04/02) - 2.5D Combinato (08/94-04/02)

2.5TDi Combinato (08/94-04/02) - 2.5TDi (03/94-04/02)

2.8D (02/98-04/02) - 2.8Jtd (11/00-04/02) - 2.8 Jtd 4x4 (11/00-04/02)

2.8TDi (11/97-04/02) - 2.8TDi 4x4 (07/99-04/02)

ILLUSTRAZIONE / ILLUSTRATION	NOSTRO RIFERIMENTO OUR REFERENCE	RIFERIMENTO COSTRUTTORE O.E. REFERENCE								
	960202	1307356080								
DESCRIZIONE / DESCRIPTION										
<p>Disco freno assale anteriore Brake disc front axle</p> <p>Fascia AUTOVENTILANTE SELF-VENTILATED Band</p>										
ILLUSTRAZIONE / ILLUSTRATION	NOSTRO RIFERIMENTO OUR REFERENCE	RIFERIMENTO COSTRUTTORE O.E. REFERENCE								
<p>Connettore quadro - Square connector</p>	960929	77362212 9948626								
DESCRIZIONE / DESCRIPTION										
<p>Serie pastiglie freno anteriore - Set of brake pads front</p> <table border="1"> <thead> <tr> <th>WVA</th> <th>Larghezza Width - mm.</th> <th>Altezza Height - mm.</th> <th>Spessore Thickness - mm.</th> </tr> </thead> <tbody> <tr> <td>21797 21798</td> <td>145</td> <td>61</td> <td>19,70</td> </tr> </tbody> </table>			WVA	Larghezza Width - mm.	Altezza Height - mm.	Spessore Thickness - mm.	21797 21798	145	61	19,70
WVA	Larghezza Width - mm.	Altezza Height - mm.	Spessore Thickness - mm.							
21797 21798	145	61	19,70							
ILLUSTRAZIONE / ILLUSTRATION	NOSTRO RIFERIMENTO OUR REFERENCE	RIFERIMENTO COSTRUTTORE O.E. REFERENCE								
<p>Connettore tondo - Round connector</p>	960935	9945810 9948629								
DESCRIZIONE / DESCRIPTION										
<p>Serie pastiglie freno anteriore - Set of brake pads front</p> <table border="1"> <thead> <tr> <th>WVA</th> <th>Larghezza Width - mm.</th> <th>Altezza Height - mm.</th> <th>Spessore Thickness - mm.</th> </tr> </thead> <tbody> <tr> <td>21799 21800</td> <td>160</td> <td>64</td> <td>19,70</td> </tr> </tbody> </table>			WVA	Larghezza Width - mm.	Altezza Height - mm.	Spessore Thickness - mm.	21799 21800	160	64	19,70
WVA	Larghezza Width - mm.	Altezza Height - mm.	Spessore Thickness - mm.							
21799 21800	160	64	19,70							

TIPO DI VEICOLO / VEHICLE TYPE

DUCATO 2006 - 17 qli - H
(Autobus - Furgonato e pianale piatto)
Multijet
 2.2D - 2.3D - 3.0D

ILLUSTRAZIONE / ILLUSTRATION	NOSTRO RIFERIMENTO OUR REFERENCE	RIFERIMENTO COSTRUTTORE O.E. REFERENCE								
	960180	51728378								
DESCRIZIONE / DESCRIPTION										
<p>Disco freno assale anteriore Brake disc front axle</p> <p>Fascia AUTOVENTILANTE SELF-VENTILATED Band</p> 										
ILLUSTRAZIONE / ILLUSTRATION	NOSTRO RIFERIMENTO OUR REFERENCE	RIFERIMENTO COSTRUTTORE O.E. REFERENCE								
<p>Connettore quadro - Square connector</p> 	960181	77364014								
DESCRIZIONE / DESCRIPTION										
<p>Serie pastiglie freno anteriore - Set of brake pads front</p> <table border="1"> <thead> <tr> <th>WVA</th> <th>Larghezza Width - mm.</th> <th>Altezza Height - mm.</th> <th>Spessore Thickness - mm.</th> </tr> </thead> <tbody> <tr> <td>24468</td> <td>169</td> <td>61,6</td> <td>19</td> </tr> </tbody> </table> 			WVA	Larghezza Width - mm.	Altezza Height - mm.	Spessore Thickness - mm.	24468	169	61,6	19
WVA	Larghezza Width - mm.	Altezza Height - mm.	Spessore Thickness - mm.							
24468	169	61,6	19							
ILLUSTRAZIONE / ILLUSTRATION	NOSTRO RIFERIMENTO OUR REFERENCE	RIFERIMENTO COSTRUTTORE O.E. REFERENCE								
<p>Connettore quadro - Square connector</p> 	960182	77364318								
DESCRIZIONE / DESCRIPTION										
<p>Serie pastiglie freno anteriore - Set of brake pads front</p> <table border="1"> <thead> <tr> <th>WVA</th> <th>Larghezza Width - mm.</th> <th>Altezza Height - mm.</th> <th>Spessore Thickness - mm.</th> </tr> </thead> <tbody> <tr> <td>24466</td> <td>169</td> <td>69,3</td> <td>19</td> </tr> </tbody> </table> 			WVA	Larghezza Width - mm.	Altezza Height - mm.	Spessore Thickness - mm.	24466	169	69,3	19
WVA	Larghezza Width - mm.	Altezza Height - mm.	Spessore Thickness - mm.							
24466	169	69,3	19							

TIPO DI VEICOLO / VEHICLE TYPE

DUCATO 2006 - 17 qli - H
(Autobus - Furgonato e pianale piatto)
Multijet
2.2D - 2.3D - 3.0D

ILLUSTRAZIONE / ILLUSTRATION

Connettore - Connector



NOSTRO RIFERIMENTO OUR REFERENCE

960428

RIFERIMENTO COSTRUTTORE O.E. REFERENCE

77362216 - 9949517

DESCRIZIONE / DESCRIPTION

Serie pastiglie freno anteriore **DUCATO (U.T.)**
Set of brake pads front **DUCATO (L.M.)**

WVA	Larghezza Width - mm.	Altezza Height - mm.	Spessore Thickness - mm.
23858	164,80	69,30	19



ILLUSTRAZIONE / ILLUSTRATION

NOSTRO RIFERIMENTO OUR REFERENCE

RIFERIMENTO COSTRUTTORE O.E. REFERENCE

DESCRIZIONE / DESCRIPTION

WVA	Larghezza Width - mm.	Altezza Height - mm.	Spessore Thickness - mm.

ILLUSTRAZIONE / ILLUSTRATION

NOSTRO RIFERIMENTO OUR REFERENCE

RIFERIMENTO COSTRUTTORE O.E. REFERENCE

DESCRIZIONE / DESCRIPTION

TIPO DI VEICOLO / VEHICLE TYPE

DUCATO 2006 - 17 q.li L
(Autobus - Furgonato e pianale piatto)
Multijet
 2.2D - 2.3D - 3.0D

ILLUSTRAZIONE / ILLUSTRATION	NOSTRO RIFERIMENTO OUR REFERENCE	RIFERIMENTO COSTRUTTORE O.E. REFERENCE								
<p>TH min. 25,90 mm.</p> <p>5 fori - 5 holes</p> <p>Ø 73 mm.</p> <p>70 mm.</p> <p>28 mm.</p> <p>Ø 280 mm.</p> 	960183	51705749								
DESCRIZIONE / DESCRIPTION										
<p>Disco freno assale anteriore Brake disc front axle</p> <p>Fascia AUTOVENTILANTE SELF-VENTILATED Band</p> 										
ILLUSTRAZIONE / ILLUSTRATION	NOSTRO RIFERIMENTO OUR REFERENCE	RIFERIMENTO COSTRUTTORE O.E. REFERENCE								
<p>Connettore quadro - Square connector</p>  <p>E3 90R</p>	960184	77364160								
DESCRIZIONE / DESCRIPTION										
<p>Serie pastiglie freno anteriore - Set of brake pads front</p> <table border="1"> <thead> <tr> <th>WVA</th> <th>Larghezza Width - mm.</th> <th>Altezza Height - mm.</th> <th>Spessore Thickness - mm.</th> </tr> </thead> <tbody> <tr> <td>24469</td> <td>169</td> <td>61,60</td> <td>19</td> </tr> </tbody> </table> 			WVA	Larghezza Width - mm.	Altezza Height - mm.	Spessore Thickness - mm.	24469	169	61,60	19
WVA	Larghezza Width - mm.	Altezza Height - mm.	Spessore Thickness - mm.							
24469	169	61,60	19							
ILLUSTRAZIONE / ILLUSTRATION	NOSTRO RIFERIMENTO OUR REFERENCE	RIFERIMENTO COSTRUTTORE O.E. REFERENCE								
<p>Connettore - connector</p>  <p>E3 90R</p>	960428	77362216 - 9949517								
DESCRIZIONE / DESCRIPTION										
<p>Serie pastiglie freno anteriore DUCATO (U.T.) Set of brake pads front DUCATO (L.M.)</p> <table border="1"> <thead> <tr> <th>WVA</th> <th>Larghezza Width - mm.</th> <th>Altezza Height - mm.</th> <th>Spessore Thickness - mm.</th> </tr> </thead> <tbody> <tr> <td>23858</td> <td>164,80</td> <td>69,30</td> <td>19</td> </tr> </tbody> </table> 			WVA	Larghezza Width - mm.	Altezza Height - mm.	Spessore Thickness - mm.	23858	164,80	69,30	19
WVA	Larghezza Width - mm.	Altezza Height - mm.	Spessore Thickness - mm.							
23858	164,80	69,30	19							

TIPO DI VEICOLO / VEHICLE TYPE

DUCATO 2006 - 20 q.li
(Autobus - Furgonato e pianale piatto)
Multijet
2.2D - 2.3D - 3.0D

ILLUSTRAZIONE / ILLUSTRATION

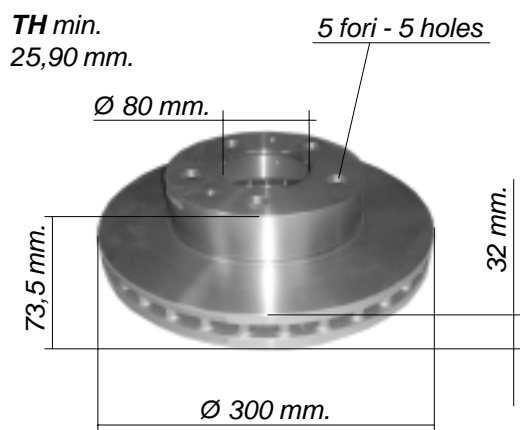

NOSTRO RIFERIMENTO OUR REFERENCE

960185

RIFERIMENTO COSTRUTTORE O.E. REFERENCE

51705758

DESCRIZIONE / DESCRIPTION

Disco freno assale anteriore
Brake disc front axle

Fascia AUTOVENTILANTE
SELF-VENTILATED Band



ILLUSTRAZIONE / ILLUSTRATION

Connettore quadro - Square connector



NOSTRO RIFERIMENTO OUR REFERENCE

960186

RIFERIMENTO COSTRUTTORE O.E. REFERENCE

77364319

DESCRIZIONE / DESCRIPTION

Serie pastiglie freno anteriore - Set of brake pads front

WVA	Larghezza Width - mm.	Altezza Height - mm.	Spessore Thickness - mm.
24467	169	69	19



ILLUSTRAZIONE / ILLUSTRATION

Connettore - connector



NOSTRO RIFERIMENTO OUR REFERENCE

960428

RIFERIMENTO COSTRUTTORE O.E. REFERENCE

77362216 - 9949517

DESCRIZIONE / DESCRIPTION





Serie pastiglie freno anteriore **DUCATO (U.T.)**
Set of brake pads front **DUCATO (L.M.)**

WVA	Larghezza Width - mm.	Altezza Height - mm.	Spessore Thickness - mm.
23858	164,80	69,30	19

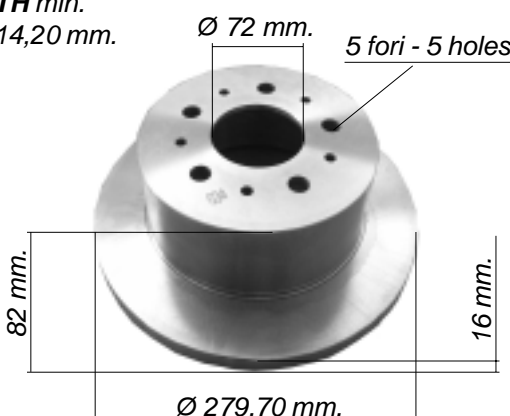

TIPO DI VEICOLO / VEHICLE TYPE

DUCATO 2008 JTD - 11 q.li

ILLUSTRAZIONE / ILLUSTRATION	NOSTRO RIFERIMENTO OUR REFERENCE	RIFERIMENTO COSTRUTTORE O.E. REFERENCE								
<p>TH min. 14,20 mm.</p> <p>Ø 72 mm.</p> <p>5 fori - 5 holes</p>  <p>82 mm.</p> <p>16 mm.</p> <p>Ø 279,70 mm.</p>	960188	71740118								
DESCRIZIONE / DESCRIPTION										
<p>Disco freno assale posteriore Brake disc rear axle</p> <p>Fascia AUTOVENTILANTE SELF-VENTILATED Band</p> 										
ILLUSTRAZIONE / ILLUSTRATION	NOSTRO RIFERIMENTO OUR REFERENCE	RIFERIMENTO COSTRUTTORE O.E. REFERENCE								
 <p>E3 90R</p>	960190	77362274								
DESCRIZIONE / DESCRIPTION										
<p>Serie pastiglie freno posteriore - Set of brake pads rear</p> <table border="1" data-bbox="646 1451 1236 1624"> <thead> <tr> <th>WVA</th> <th>Larghezza Width - mm.</th> <th>Altezza Height - mm.</th> <th>Spessore Thickness - mm.</th> </tr> </thead> <tbody> <tr> <td>23919 23920</td> <td>165</td> <td>69,3</td> <td>19,10</td> </tr> </tbody> </table> 			WVA	Larghezza Width - mm.	Altezza Height - mm.	Spessore Thickness - mm.	23919 23920	165	69,3	19,10
WVA	Larghezza Width - mm.	Altezza Height - mm.	Spessore Thickness - mm.							
23919 23920	165	69,3	19,10							
ILLUSTRAZIONE / ILLUSTRATION	NOSTRO RIFERIMENTO OUR REFERENCE	RIFERIMENTO COSTRUTTORE O.E. REFERENCE								
DESCRIZIONE / DESCRIPTION										

TIPO DI VEICOLO / VEHICLE TYPE

DUCATO 2008 JTD - 18 q.li

ILLUSTRAZIONE / ILLUSTRATION

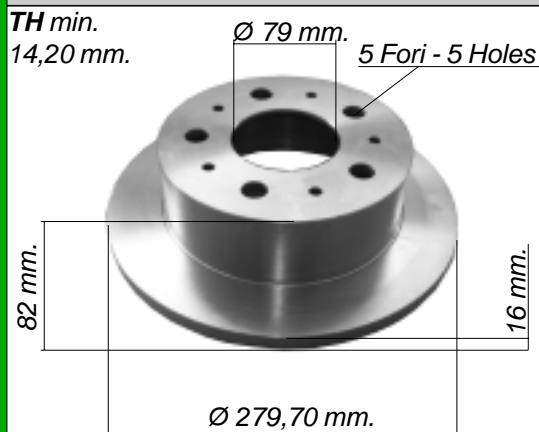

**NOSTRO RIFERIMENTO
OUR REFERENCE**

960189

**RIFERIMENTO COSTRUTTORE
O.E. REFERENCE**

71740117

DESCRIZIONE / DESCRIPTION

Disco freno assale posteriore
Brake disc rear axle

Fascia AUTOVENTILANTE
SELF-VENTILATED Band



ILLUSTRAZIONE / ILLUSTRATION



**NOSTRO RIFERIMENTO
OUR REFERENCE**

960190

**RIFERIMENTO COSTRUTTORE
O.E. REFERENCE**

77362274

DESCRIZIONE / DESCRIPTION

Serie pastiglie freno posteriore - Set of brake pads rear

WVA	Larghezza Width - mm.	Altezza Height - mm.	Spessore Thickness - mm.
23919 23920	165	69,3	19,10



ILLUSTRAZIONE / ILLUSTRATION

**NOSTRO RIFERIMENTO
OUR REFERENCE**

**RIFERIMENTO COSTRUTTORE
O.E. REFERENCE**

DESCRIZIONE / DESCRIPTION

TIPO DI VEICOLO / VEHICLE TYPE

TRANSIT (Impianto Bendix - Bendix system)
(Cerchi da 14" - Wheels 14" Autobus - Furgonato e pianale piatto)

2.0 - 2.5D - 2.5TD - 2.5TDI (09/91-03/00)

ILLUSTRAZIONE / ILLUSTRATION	NOSTRO RIFERIMENTO OUR REFERENCE	RIFERIMENTO COSTRUTTORE O.E. REFERENCE								
	960382	5025610 5029815								
DESCRIZIONE / DESCRIPTION										
Disco freno assale anteriore Brake disc front axle										
										
ILLUSTRAZIONE / ILLUSTRATION	NOSTRO RIFERIMENTO OUR REFERENCE	RIFERIMENTO COSTRUTTORE O.E. REFERENCE								
	960868	6965579 7018202								
DESCRIZIONE / DESCRIPTION										
Serie pastiglie freno anteriore - Set of brake pads front										
<table border="1"> <thead> <tr> <th>WVA</th> <th>Larghezza Width - mm.</th> <th>Altezza Height - mm.</th> <th>Spessore Thickness - mm.</th> </tr> </thead> <tbody> <tr> <td>21470</td> <td>139</td> <td>65</td> <td>19</td> </tr> </tbody> </table>			WVA	Larghezza Width - mm.	Altezza Height - mm.	Spessore Thickness - mm.	21470	139	65	19
WVA	Larghezza Width - mm.	Altezza Height - mm.	Spessore Thickness - mm.							
21470	139	65	19							
										
ILLUSTRAZIONE / ILLUSTRATION	NOSTRO RIFERIMENTO OUR REFERENCE	RIFERIMENTO COSTRUTTORE O.E. REFERENCE								
	960869	6197739 6965580 - 7018203								
DESCRIZIONE / DESCRIPTION										
Serie pastiglie freno anteriore - Set of brake pads front										
<table border="1"> <thead> <tr> <th>WVA</th> <th>Larghezza Width - mm.</th> <th>Altezza Height - mm.</th> <th>Spessore Thickness - mm.</th> </tr> </thead> <tbody> <tr> <td>21469</td> <td>139</td> <td>72</td> <td>19</td> </tr> </tbody> </table>			WVA	Larghezza Width - mm.	Altezza Height - mm.	Spessore Thickness - mm.	21469	139	72	19
WVA	Larghezza Width - mm.	Altezza Height - mm.	Spessore Thickness - mm.							
21469	139	72	19							
										

TIPO DI VEICOLO / VEHICLE TYPE

TRANSIT (Impianto Bendix - Bendix system)
(Cerchi da 15" - Autobus - Furgonato e pianale piatto)
(Wheels 15" - Autobus - Van and Flat platform)

2.0 - 2.5D - 2.5TD - 2.5TDI (09/91-03/00)

ILLUSTRAZIONE / ILLUSTRATION	NOSTRO RIFERIMENTO OUR REFERENCE	RIFERIMENTO COSTRUTTORE O.E. REFERENCE							
	<h2>960383</h2>	5025611 5029816							
			DESCRIZIONE / DESCRIPTION Disco freno assale anteriore Brake disc front axle 						
	<h2>960868</h2>	6965579 7018202							
			DESCRIZIONE / DESCRIPTION Serie pastiglie freno anteriore - Set of brake pads front <table border="1" style="width: 100%; border-collapse: collapse;"> <thead> <tr> <th>WVA</th> <th>Larghezza Width - mm.</th> <th>Altezza Height - mm.</th> <th>Spessore Thickness - mm.</th> </tr> </thead> <tbody> <tr> <td style="text-align: center;">21470</td> <td style="text-align: center;">139</td> <td style="text-align: center;">65</td> <td style="text-align: center;">19</td> </tr> </tbody> </table>		WVA	Larghezza Width - mm.	Altezza Height - mm.	Spessore Thickness - mm.	21470
WVA	Larghezza Width - mm.	Altezza Height - mm.	Spessore Thickness - mm.						
21470	139	65	19						
	<h2>960869</h2>	6197739 6965580 - 7018203							
			DESCRIZIONE / DESCRIPTION Serie pastiglie freno anteriore - Set of brake pads front <table border="1" style="width: 100%; border-collapse: collapse;"> <thead> <tr> <th>WVA</th> <th>Larghezza Width - mm.</th> <th>Altezza Height - mm.</th> <th>Spessore Thickness - mm.</th> </tr> </thead> <tbody> <tr> <td style="text-align: center;">21469</td> <td style="text-align: center;">139</td> <td style="text-align: center;">72</td> <td style="text-align: center;">19</td> </tr> </tbody> </table>		WVA	Larghezza Width - mm.	Altezza Height - mm.	Spessore Thickness - mm.	21469
WVA	Larghezza Width - mm.	Altezza Height - mm.	Spessore Thickness - mm.						
21469	139	72	19						

TIPO DI VEICOLO / VEHICLE TYPE

TRANSIT (Impianto Bendix - Bendix system)

Autobus	(da 08/00 from 08/00)
Furgonato	2.0DI - 2.0TDCI - 2.3 16v - 2.4DI (da 08/00 from 08/00)
Pianale piatto	2.0 - 2.3 - 2.4 (da 08/00 from 08/00)

ILLUSTRAZIONE / ILLUSTRATION	NOSTRO RIFERIMENTO OUR REFERENCE	RIFERIMENTO COSTRUTTORE O.E. REFERENCE																				
	960384	4041427 4395257																				
DESCRIZIONE / DESCRIPTION																						
Disco freno assale anteriore Brake disc front axle 																						
ILLUSTRAZIONE / ILLUSTRATION	NOSTRO RIFERIMENTO OUR REFERENCE	RIFERIMENTO COSTRUTTORE O.E. REFERENCE																				
	960870	1135167 - 1144288 4095132 - 4114749																				
DESCRIZIONE / DESCRIPTION																						
Serie pastiglie freno anteriore - Set of brake pads front <table border="1" data-bbox="646 1444 1236 1624"> <thead> <tr> <th>WVA</th> <th>Larghezza Width - mm.</th> <th>Altezza Height - mm.</th> <th>Spessore Thickness - mm.</th> </tr> </thead> <tbody> <tr> <td>23840</td> <td>168,9</td> <td>65</td> <td>18,4</td> </tr> <tr> <td>23841</td> <td></td> <td></td> <td></td> </tr> <tr> <td>23434</td> <td></td> <td></td> <td></td> </tr> <tr> <td>23435</td> <td></td> <td></td> <td></td> </tr> </tbody> </table> 			WVA	Larghezza Width - mm.	Altezza Height - mm.	Spessore Thickness - mm.	23840	168,9	65	18,4	23841				23434				23435			
WVA	Larghezza Width - mm.	Altezza Height - mm.	Spessore Thickness - mm.																			
23840	168,9	65	18,4																			
23841																						
23434																						
23435																						
ILLUSTRAZIONE / ILLUSTRATION	NOSTRO RIFERIMENTO OUR REFERENCE	RIFERIMENTO COSTRUTTORE O.E. REFERENCE																				
DESCRIZIONE / DESCRIPTION																						

TIPO DI VEICOLO / VEHICLE TYPE



TRANSIT (Impianto Bendix - Bendix system)

Autobus	(da 01/00 from 01/00)
Furgonato	2.3 16v - 2.4DI (da 01/00 from 01/00)
Pianale piatto	2.3 - 2.4 (da 01/00 from 01/00)

ILLUSTRAZIONE / ILLUSTRATION	NOSTRO RIFERIMENTO OUR REFERENCE	RIFERIMENTO COSTRUTTORE O.E. REFERENCE																				
	960385	4041428																				
DESCRIZIONE / DESCRIPTION																						
<p>Disco freno assale anteriore Brake disc front axle</p>																						
ILLUSTRAZIONE / ILLUSTRATION	NOSTRO RIFERIMENTO OUR REFERENCE	RIFERIMENTO COSTRUTTORE O.E. REFERENCE																				
	960871	4077636																				
DESCRIZIONE / DESCRIPTION																						
<p>Serie pastiglie freno anteriore - Set of brake pads front</p> <table border="1"> <thead> <tr> <th>WVA</th> <th>Larghezza Width - mm.</th> <th>Altezza Height - mm.</th> <th>Spessore Thickness - mm.</th> </tr> </thead> <tbody> <tr> <td>23577</td> <td>168,9</td> <td>65</td> <td>18,4</td> </tr> <tr> <td>23578</td> <td></td> <td></td> <td></td> </tr> <tr> <td>23579</td> <td></td> <td></td> <td></td> </tr> <tr> <td>23580</td> <td></td> <td></td> <td></td> </tr> </tbody> </table>			WVA	Larghezza Width - mm.	Altezza Height - mm.	Spessore Thickness - mm.	23577	168,9	65	18,4	23578				23579				23580			
WVA	Larghezza Width - mm.	Altezza Height - mm.	Spessore Thickness - mm.																			
23577	168,9	65	18,4																			
23578																						
23579																						
23580																						
ILLUSTRAZIONE / ILLUSTRATION	NOSTRO RIFERIMENTO OUR REFERENCE	RIFERIMENTO COSTRUTTORE O.E. REFERENCE																				
DESCRIZIONE / DESCRIPTION																						

TIPO DI VEICOLO / VEHICLE TYPE

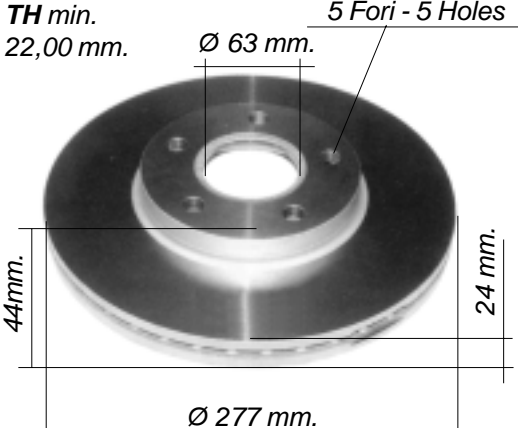
TOURNEO Connect 1.8 16v - 1.8 Turbo DI (da 09/02 from 09/02)**TRANSIT Connect** 1.8 16v - 1.8 Turbo DI (da 09/02 from 09/02)

ILLUSTRAZIONE / ILLUSTRATION	NOSTRO RIFERIMENTO OUR REFERENCE	RIFERIMENTO COSTRUTTORE O.E. REFERENCE								
 <p>TH min. 22,00 mm.</p> <p>Ø 63 mm.</p> <p>5 Fori - 5 Holes</p> <p>44mm.</p> <p>24 mm.</p> <p>Ø 277 mm.</p>	960386	4455980 4457985								
DESCRIZIONE / DESCRIPTION										
<p>Disco freno assale anteriore e posteriore Brake disc front and rear axle</p> 										
ILLUSTRAZIONE / ILLUSTRATION	NOSTRO RIFERIMENTO OUR REFERENCE	RIFERIMENTO COSTRUTTORE O.E. REFERENCE								
DESCRIZIONE / DESCRIPTION										
<table border="1" data-bbox="646 1451 1236 1624"> <thead> <tr> <th data-bbox="646 1451 758 1505">WVA</th> <th data-bbox="758 1451 917 1505">Larghezza Width - mm.</th> <th data-bbox="917 1451 1061 1505">Altezza Height - mm.</th> <th data-bbox="1061 1451 1236 1505">Spessore Thickness - mm.</th> </tr> </thead> <tbody> <tr> <td data-bbox="646 1505 758 1624"></td> <td data-bbox="758 1505 917 1624"></td> <td data-bbox="917 1505 1061 1624"></td> <td data-bbox="1061 1505 1236 1624"></td> </tr> </tbody> </table>			WVA	Larghezza Width - mm.	Altezza Height - mm.	Spessore Thickness - mm.				
WVA	Larghezza Width - mm.	Altezza Height - mm.	Spessore Thickness - mm.							
ILLUSTRAZIONE / ILLUSTRATION	NOSTRO RIFERIMENTO OUR REFERENCE	RIFERIMENTO COSTRUTTORE O.E. REFERENCE								
DESCRIZIONE / DESCRIPTION										

TIPO DI VEICOLO / VEHICLE TYPE

GASOLONE

TS27 - TS28 (1°SERIE)

TSH35 - TSHT35 (U.T.)

ILLUSTRAZIONE / ILLUSTRATION

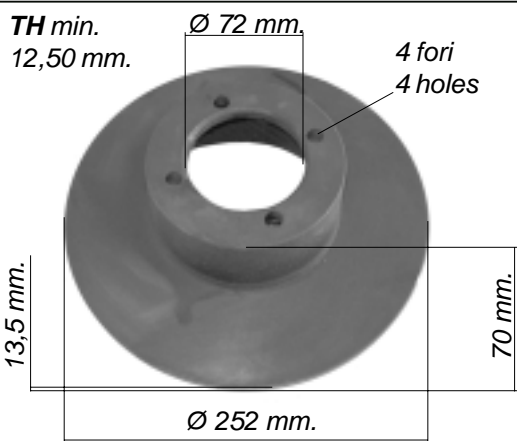

NOSTRO RIFERIMENTO OUR REFERENCE

960243

RIFERIMENTO COSTRUTTORE O.E. REFERENCE

60500015000

DESCRIZIONE / DESCRIPTION

Disco freno assale anteriore
Brake disc front axle



ILLUSTRAZIONE / ILLUSTRATION



NOSTRO RIFERIMENTO OUR REFERENCE

960256

RIFERIMENTO COSTRUTTORE O.E. REFERENCE

80500001043

DESCRIZIONE / DESCRIPTION

Disco freno assale anteriore (U.T.)
Brake disc front axle (L.M.)



ILLUSTRAZIONE / ILLUSTRATION



NOSTRO RIFERIMENTO OUR REFERENCE

960244

RIFERIMENTO COSTRUTTORE O.E. REFERENCE

R1410920100

DESCRIZIONE / DESCRIPTION

Serie pastiglie freno anteriorie - Set of brake pads front

WVA	Larghezza Width - mm.	Altezza Height - mm.	Spessore Thickness - mm.
-	110	73	18,30

E3 90R



TIPO DI VEICOLO / VEHICLE TYPE

ISUZU NKR 3.0D - NPR
(35 TON. RUOTA SINGOLA - 1998)

ILLUSTRAZIONE / ILLUSTRATION

TH min.
37,00 mm.

Ø 110 mm.

12 fori
12 holes

Ø 290 mm.

NOSTRO RIFERIMENTO
OUR REFERENCE**960519**RIFERIMENTO COSTRUTTORE
O.E. REFERENCE8971686311
8973718760

DESCRIZIONE / DESCRIPTION

Disco freno assale anteriore
Brake disc front axle

ILLUSTRAZIONE / ILLUSTRATION



E3 90R

NOSTRO RIFERIMENTO
OUR REFERENCE**960410**RIFERIMENTO COSTRUTTORE
O.E. REFERENCE

8973292660

DESCRIZIONE / DESCRIPTION

Serie pastiglie freno anteriore
Set of brake pads front

WVA	Larghezza Width - mm.	Altezza Height - mm.	Spessore Thickness - mm.
-	206.10	74.80	20



ILLUSTRAZIONE / ILLUSTRATION

Ø 100 mm.

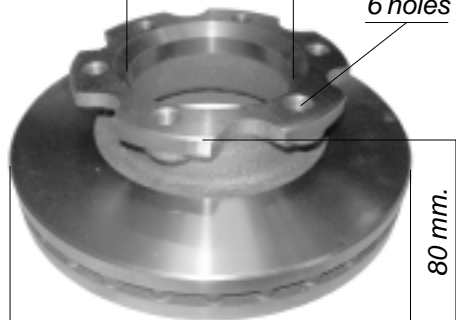
6 fori
6 holes

Ø 265 mm.

NOSTRO RIFERIMENTO
OUR REFERENCE**960518**RIFERIMENTO COSTRUTTORE
O.E. REFERENCE

897031007

DESCRIZIONE / DESCRIPTION

Disco freno assale posteriore
Brake disc rear axle

TIPO DI VEICOLO / VEHICLE TYPE

ISUZU NPR 4.8 D
ISUZU NQR (60/70 Q.LI)

ILLUSTRAZIONE / ILLUSTRATION

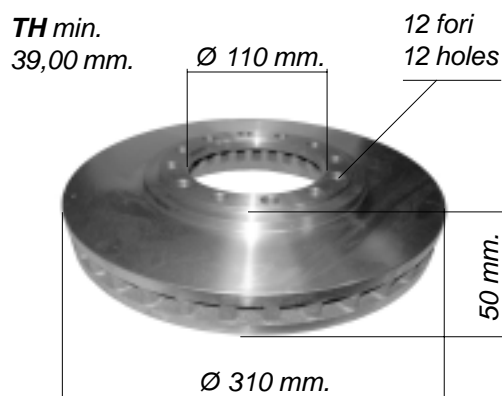

NOSTRO RIFERIMENTO OUR REFERENCE

960520

RIFERIMENTO COSTRUTTORE O.E. REFERENCE

8973872280
8971686321

DESCRIZIONE / DESCRIPTION

Disco freno assale anteriore
Brake disc front axle
Isuzu NPR 4.8D - NQR (60-70q.)



ILLUSTRAZIONE / ILLUSTRATION



NOSTRO RIFERIMENTO OUR REFERENCE

960411

RIFERIMENTO COSTRUTTORE O.E. REFERENCE

8971686340

DESCRIZIONE / DESCRIPTION

Serie pastiglie freno anteriore
Set of brake pads front

WVA	Larghezza Width - mm.	Altezza Height - mm.	Spessore Thickness - mm.
-	206.10	80.10	20



ILLUSTRAZIONE / ILLUSTRATION



NOSTRO RIFERIMENTO OUR REFERENCE

960412

RIFERIMENTO COSTRUTTORE O.E. REFERENCE

8970947100

DESCRIZIONE / DESCRIPTION

WVA	Larghezza Width - mm.	Altezza Height - mm.	Spessore Thickness - mm.
-	183.20 238.20	69.80 93.40	21.70



TIPO DI VEICOLO / VEHICLE TYPE

ISUZU NQR 4.7 D
(7.5 TON - 1998)

ILLUSTRAZIONE / ILLUSTRATION

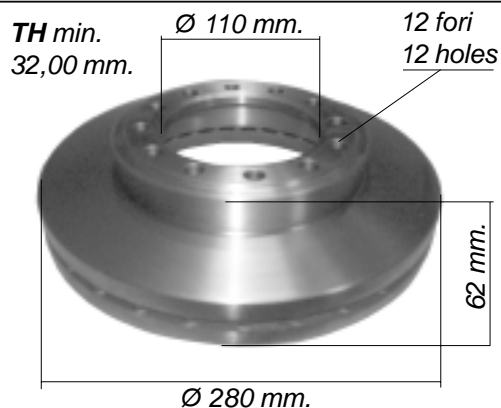
NOSTRO RIFERIMENTO
OUR REFERENCE**960521**RIFERIMENTO COSTRUTTORE
O.E. REFERENCE

8970158571

DESCRIZIONE / DESCRIPTION

Disco freno assale anteriore
Brake disc front axle
Isuzu NQR 4.7 D
(7.5 ton 1998)



ILLUSTRAZIONE / ILLUSTRATION

NOSTRO RIFERIMENTO
OUR REFERENCE**960411**RIFERIMENTO COSTRUTTORE
O.E. REFERENCE

8971686340

DESCRIZIONE / DESCRIPTION

Serie pastiglie freno anteriore
Set of brake pads front

WVA	Larghezza Width - mm.	Altezza Height - mm.	Spessore Thickness - mm.
-	206.10	80.10	20



ILLUSTRAZIONE / ILLUSTRATION

NOSTRO RIFERIMENTO
OUR REFERENCERIFERIMENTO COSTRUTTORE
O.E. REFERENCE

DESCRIZIONE / DESCRIPTION

TIPO DI VEICOLO / VEHICLE TYPE

DAILY RESTYLING 30.8
NEW DAILY 30.8
TURBODAILY 30.10
 (impianto BREMBO - BREMBO system)

ILLUSTRAZIONE / ILLUSTRATION

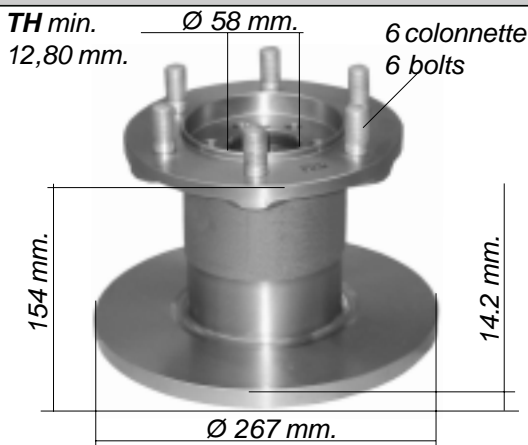

NOSTRO RIFERIMENTO OUR REFERENCE

960021

RIFERIMENTO COSTRUTTORE O.E. REFERENCE

1904528
8582290

DESCRIZIONE / DESCRIPTION

Serie dischi freno assale anteriore
Set of brake discs front axle



ILLUSTRAZIONE / ILLUSTRATION

Connettore tondo - Round connector



E3 90R

NOSTRO RIFERIMENTO OUR REFERENCE

960913

RIFERIMENTO COSTRUTTORE O.E. REFERENCE

1906158

DESCRIZIONE / DESCRIPTION

Serie pastiglie freno anteriore - Set of brake pads front

WVA	Larghezza Width - mm.	Altezza Height - mm.	Spessore Thickness - mm.
29038 29037	110	73	18,3



ILLUSTRAZIONE / ILLUSTRATION







NOSTRO RIFERIMENTO OUR REFERENCE

RIFERIMENTO COSTRUTTORE O.E. REFERENCE

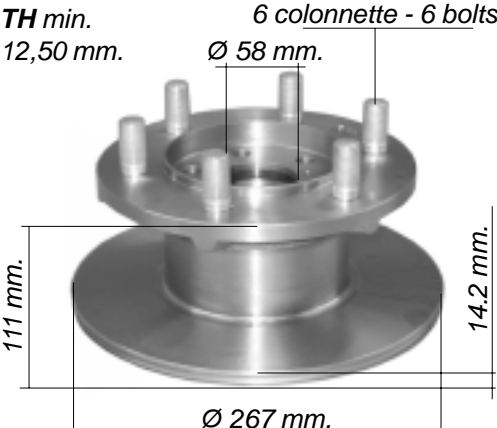
DESCRIZIONE / DESCRIPTION

TIPO DI VEICOLO / VEHICLE TYPE

DAILY RESTYLING 35.8 - 35.10
NEW DAILY 35.8 - 40.8 - 35.10
TURBODAILY 35.10 - 35.12

ILLUSTRAZIONE / ILLUSTRATION	NOSTRO RIFERIMENTO OUR REFERENCE	RIFERIMENTO COSTRUTTORE O.E. REFERENCE								
<p>TH min. 12,50 mm.</p> <p>6 colonnette - 6 bolts Ø 58 mm.</p>  <p>111 mm.</p> <p>14.2 mm.</p> <p>Ø 267 mm.</p>	960022	1904529 93800492								
DESCRIZIONE / DESCRIPTION										
<p>Serie dischi freno assale anteriore Set of brake discs front axle</p> 										
ILLUSTRAZIONE / ILLUSTRATION	NOSTRO RIFERIMENTO OUR REFERENCE	RIFERIMENTO COSTRUTTORE O.E. REFERENCE								
<p>Connettore tondo - Round connector</p>  <p>E3 90R</p>	960894	1906159								
DESCRIZIONE / DESCRIPTION										
<p>Serie pastiglie freno anteriore - Set of brake pads front (impianto BREMBO 16" - BREMBO 16" system)</p> <table border="1"> <thead> <tr> <th>WVA</th> <th>Larghezza Width - mm.</th> <th>Altezza Height - mm.</th> <th>Spessore Thickness - mm.</th> </tr> </thead> <tbody> <tr> <td>21048 29041</td> <td>110</td> <td>73</td> <td>18,30</td> </tr> </tbody> </table> 			WVA	Larghezza Width - mm.	Altezza Height - mm.	Spessore Thickness - mm.	21048 29041	110	73	18,30
WVA	Larghezza Width - mm.	Altezza Height - mm.	Spessore Thickness - mm.							
21048 29041	110	73	18,30							
ILLUSTRAZIONE / ILLUSTRATION	NOSTRO RIFERIMENTO OUR REFERENCE	RIFERIMENTO COSTRUTTORE O.E. REFERENCE								
<p>Connettore tondo - Round connector</p>  <p>E3 90R</p>	960898	1906157								
DESCRIZIONE / DESCRIPTION										
<p>Serie pastiglie freno anteriore - Set of brake pads front (impianto LOCKEED - LOCKEED system)</p> <table border="1"> <thead> <tr> <th>WVA</th> <th>Larghezza Width - mm.</th> <th>Altezza Height - mm.</th> <th>Spessore Thickness - mm.</th> </tr> </thead> <tbody> <tr> <td>21160 20359</td> <td>105</td> <td>75</td> <td>18</td> </tr> </tbody> </table> 			WVA	Larghezza Width - mm.	Altezza Height - mm.	Spessore Thickness - mm.	21160 20359	105	75	18
WVA	Larghezza Width - mm.	Altezza Height - mm.	Spessore Thickness - mm.							
21160 20359	105	75	18							

TIPO DI VEICOLO / VEHICLE TYPE

DAILY RESTYLING 35.8 - 35.10

NEW DAILY 35.8 - 40.8 - 35.10

TURBODAILY 35.10 - 35.12

ILLUSTRAZIONE / ILLUSTRATION

Connettore Tondo + Ovale
Round + Oval connector



E3 90R

NOSTRO RIFERIMENTO OUR REFERENCE

960893

RIFERIMENTO COSTRUTTORE O.E. REFERENCE

1906206

DESCRIZIONE / DESCRIPTION

Serie pastiglie freno anteriore - Set of brake pads front
(impianto BREMBO 16" - BREMBO 16" system)

WVA	Larghezza Width - mm.	Altezza Height - mm.	Spessore Thickness - mm.
21188 21048	110	73	18.3



ILLUSTRAZIONE / ILLUSTRATION

Connettore Tondo + Ovale
Round + Oval connector



E3 90R

NOSTRO RIFERIMENTO OUR REFERENCE

960892

RIFERIMENTO COSTRUTTORE O.E. REFERENCE

1906207

DESCRIZIONE / DESCRIPTION

Serie pastiglie freno anteriore - Set of brake pads front
(impianto LOCKEED - LOCKEED system)

WVA	Larghezza Width - mm.	Altezza Height - mm.	Spessore Thickness - mm.
20359 20653	105	75	18



ILLUSTRAZIONE / ILLUSTRATION

NOSTRO RIFERIMENTO OUR REFERENCE

RIFERIMENTO COSTRUTTORE O.E. REFERENCE

DESCRIZIONE / DESCRIPTION

TIPO DI VEICOLO / VEHICLE TYPE

DAILY RESTYLING 49.10
NEW DAILY 35.10 - 45.10 - 49.10
TURBODAILY 35.12 - 49.12

ILLUSTRAZIONE / ILLUSTRATION	NOSTRO RIFERIMENTO OUR REFERENCE	RIFERIMENTO COSTRUTTORE O.E. REFERENCE								
<p>TH min. 14,00 mm. Ø 58 mm. 6 colonnette 6 bolts</p> 	960023	1904531 - 8584182								
DESCRIZIONE / DESCRIPTION										
<p>Serie dischi freno assale anteriore Set of brake discs front axle</p> 										
ILLUSTRAZIONE / ILLUSTRATION	NOSTRO RIFERIMENTO OUR REFERENCE	RIFERIMENTO COSTRUTTORE O.E. REFERENCE								
<p>Connettore tondo - Round connector</p> 	960900	1906040								
DESCRIZIONE / DESCRIPTION										
<p>Serie pastiglie freno anteriore - Set of brake pads front (impianto PERROT - PERROT system)</p> <table border="1"> <thead> <tr> <th>WVA</th> <th>Larghezza Width - mm.</th> <th>Altezza Height - mm.</th> <th>Spessore Thickness - mm.</th> </tr> </thead> <tbody> <tr> <td>20465 29012</td> <td>149</td> <td>69</td> <td>18</td> </tr> </tbody> </table>  			WVA	Larghezza Width - mm.	Altezza Height - mm.	Spessore Thickness - mm.	20465 29012	149	69	18
WVA	Larghezza Width - mm.	Altezza Height - mm.	Spessore Thickness - mm.							
20465 29012	149	69	18							
ILLUSTRAZIONE / ILLUSTRATION	NOSTRO RIFERIMENTO OUR REFERENCE	RIFERIMENTO COSTRUTTORE O.E. REFERENCE								
<p>Connettore tondo - Round connector</p> 	960941	1906243								
DESCRIZIONE / DESCRIPTION										
<p>Serie pastiglie freno anteriore - Set of brake pads front (impianto PERROT - PERROT system)</p> <table border="1"> <thead> <tr> <th>WVA</th> <th>Larghezza Width - mm.</th> <th>Altezza Height - mm.</th> <th>Spessore Thickness - mm.</th> </tr> </thead> <tbody> <tr> <td>20465 29040</td> <td>149</td> <td>69</td> <td>18</td> </tr> </tbody> </table>  			WVA	Larghezza Width - mm.	Altezza Height - mm.	Spessore Thickness - mm.	20465 29040	149	69	18
WVA	Larghezza Width - mm.	Altezza Height - mm.	Spessore Thickness - mm.							
20465 29040	149	69	18							
ILLUSTRAZIONE / ILLUSTRATION	NOSTRO RIFERIMENTO OUR REFERENCE	RIFERIMENTO COSTRUTTORE O.E. REFERENCE								
 <p>Lunghezza/Length mm 190</p>	960876	42530912 - 8198933								
DESCRIZIONE / DESCRIPTION										
<p>Indicatore usura freno anteriore (pz 1) Brake wear indicator front (1 pc)</p>										

TIPO DI VEICOLO / VEHICLE TYPE

TURBODAILY 59.12

ILLUSTRAZIONE / ILLUSTRATION

**NOSTRO RIFERIMENTO
OUR REFERENCE**

**RIFERIMENTO COSTRUTTORE
O.E. REFERENCE**

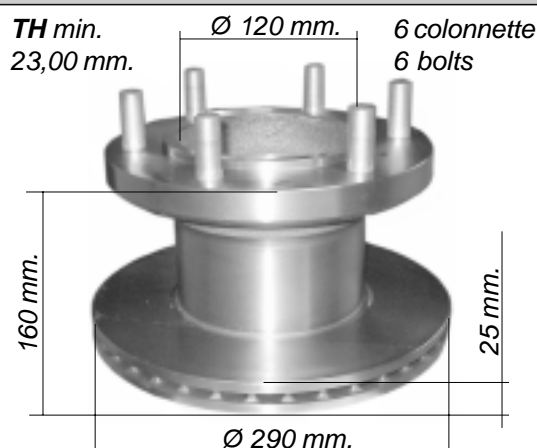

960039

1904693

DESCRIZIONE / DESCRIPTION

Serie dischi freno assale anteriore
Set of brake discs front axle

Fascia AUTOVENTILANTE
SELF-VENTILATED Band



ILLUSTRAZIONE / ILLUSTRATION

**NOSTRO RIFERIMENTO
OUR REFERENCE**

**RIFERIMENTO COSTRUTTORE
O.E. REFERENCE**

Connettore ovale - Oval connector



960974

1906427

DESCRIZIONE / DESCRIPTION

Serie pastiglie freno anteriore - Set of brake pads front
(impianto PERROT - PERROT system)

WVA	Larghezza Width - mm.	Altezza Height - mm.	Spessore Thickness - mm.
29001	174	69	20
29107			



ILLUSTRAZIONE / ILLUSTRATION

**NOSTRO RIFERIMENTO
OUR REFERENCE**

**RIFERIMENTO COSTRUTTORE
O.E. REFERENCE**

Connettore tondo - Round connector



960940

1906183

DESCRIZIONE / DESCRIPTION

Serie pastiglie freno anteriore - Set of brake pads front
(impianto PERROT - PERROT system) - (fino al 1995)

WVA	Larghezza Width - mm.	Altezza Height - mm.	Spessore Thickness - mm.
29001	174,7	69	20
29003			



ILLUSTRAZIONE / ILLUSTRATION

**NOSTRO RIFERIMENTO
OUR REFERENCE**

**RIFERIMENTO COSTRUTTORE
O.E. REFERENCE**



960876

42530912 - 8198933

DESCRIZIONE / DESCRIPTION

Indicatore usura freno anteriore (pz 1)
Brake wear indicator front (1 pc)

Connettore tondo - Lungh. mm 190
Round connector - Length mm 190

TIPO DI VEICOLO / VEHICLE TYPE

DAILY CITY 2000

35S9-35S11-35S13-35S15 (RUOTA SINGOLA)

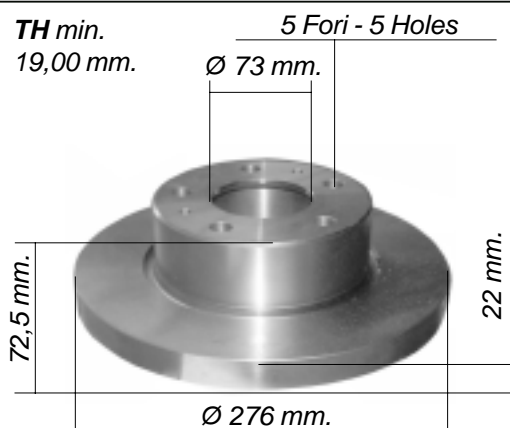
ILLUSTRAZIONE / ILLUSTRATION	NOSTRO RIFERIMENTO OUR REFERENCE	RIFERIMENTO COSTRUTTORE O.E. REFERENCE								
<p>TH min. 19,00 mm.</p> <p>5 Fori - 5 Holes</p> <p>Ø 73 mm.</p> <p>72,5 mm.</p> <p>Ø 276 mm.</p> <p>22 mm.</p> 	960923	42470836								
DESCRIZIONE / DESCRIPTION										
<p>Serie dischi freno assale anteriore Set of brake discs front axle</p> 										
ILLUSTRAZIONE / ILLUSTRATION	NOSTRO RIFERIMENTO OUR REFERENCE	RIFERIMENTO COSTRUTTORE O.E. REFERENCE								
 <p>E3 90R</p>	960910	42470835								
DESCRIZIONE / DESCRIPTION										
<p>Serie pastiglie freno anteriore - Set of brake pads front (impianto BREMBO - BREMBO system)</p> <table border="1"> <thead> <tr> <th>WVA</th> <th>Larghezza Width - mm.</th> <th>Altezza Height - mm.</th> <th>Spessore Thickness - mm.</th> </tr> </thead> <tbody> <tr> <td>29212 29121</td> <td>164,8</td> <td>66,5</td> <td>18</td> </tr> </tbody> </table> 			WVA	Larghezza Width - mm.	Altezza Height - mm.	Spessore Thickness - mm.	29212 29121	164,8	66,5	18
WVA	Larghezza Width - mm.	Altezza Height - mm.	Spessore Thickness - mm.							
29212 29121	164,8	66,5	18							
ILLUSTRAZIONE / ILLUSTRATION	NOSTRO RIFERIMENTO OUR REFERENCE	RIFERIMENTO COSTRUTTORE O.E. REFERENCE								
<p>Connettore ovale - Lungh. mm. 295 Oval connector - Length mm. 295</p> <p>1</p>  <p>Connettore ovale - Lungh. mm. 190 Oval connector - Length mm. 190</p> <p>2</p> 	<p>960879</p> <p>960864</p>	<p>42548208 - 1908407 (1)</p> <p>42548195 - 2992393 (2)</p>								
DESCRIZIONE / DESCRIPTION										
<p>Kit segnalatori usura freno anteriore e posteriore (2 pz.) Set of brake wear indicators front and rear (2 pcs)</p> <p>Kit segnalatori usura freno anteriore e posteriore (2 pz.) Set of brake wear indicators front and rear (2 pcs)</p>										

TIPO DI VEICOLO / VEHICLE TYPE

DAILY CITY 2000

35S9-35S11-35S13-S15 (RUOTA SINGOLA)







ILLUSTRAZIONE / ILLUSTRATION	NOSTRO RIFERIMENTO OUR REFERENCE	RIFERIMENTO COSTRUTTORE O.E. REFERENCE								
	960924	2991646								
DESCRIZIONE / DESCRIPTION										
<p>Serie dischi freno assale posteriore Set of brake discs rear axle</p>										
ILLUSTRAZIONE / ILLUSTRATION	NOSTRO RIFERIMENTO OUR REFERENCE	RIFERIMENTO COSTRUTTORE O.E. REFERENCE								
	960911	42470841								
DESCRIZIONE / DESCRIPTION										
<p>Serie pastiglie freno posteriore - Set of brake pads rear (impianto BREMBO - BREMBO system)</p> <table border="1"> <thead> <tr> <th>WVA</th> <th>Larghezza Width - mm.</th> <th>Altezza Height - mm.</th> <th>Spessore Thickness - mm.</th> </tr> </thead> <tbody> <tr> <td>29123</td> <td>107</td> <td>61</td> <td>20</td> </tr> </tbody> </table>			WVA	Larghezza Width - mm.	Altezza Height - mm.	Spessore Thickness - mm.	29123	107	61	20
WVA	Larghezza Width - mm.	Altezza Height - mm.	Spessore Thickness - mm.							
29123	107	61	20							
ILLUSTRAZIONE / ILLUSTRATION	NOSTRO RIFERIMENTO OUR REFERENCE	RIFERIMENTO COSTRUTTORE O.E. REFERENCE								
<p>Connettore ovale - Lungh. mm. 150 Oval connector - Length mm. 150</p> <p>1</p> <p>2</p> <p>Connettore ovale - Lungh. mm. 150 Oval connector - Length mm. 150</p>	<p>960979</p> <p>960863</p>	<p>42548209 - 2991854 (1)</p> <p>42548196 - 2992394 (2)</p>								
DESCRIZIONE / DESCRIPTION										
<p>Kit segnalatori usura freno posteriore (2 pz.) Set of brake wear indicators rear (2 pcs)</p> <p>Kit segnalatori usura freno posteriore (2 pz.) Set of brake wear indicators rear (2 pcs)</p>										

TIPO DI VEICOLO / VEHICLE TYPE

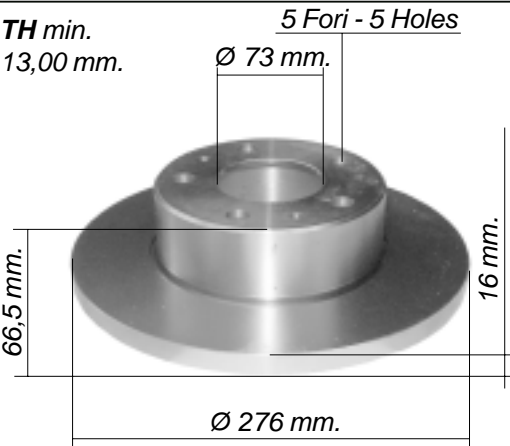
DAILY CITY 2000

35S9-35S11-35S13-S15 (RUOTA SINGOLA)

(PER VEICOLI **CON ABS** - VEHICLES **WITH ABS**)

ILLUSTRAZIONE / ILLUSTRATION	NOSTRO RIFERIMENTO OUR REFERENCE	RIFERIMENTO COSTRUTTORE O.E. REFERENCE								
<p>TH min. 13,00 mm.</p> <p>5 Fori - 5 Holes Ø 73 mm.</p> <p>66,5 mm.</p> <p>16 mm.</p> <p>Ø 276 mm.</p> 	960925	2994066 42471034								
DESCRIZIONE / DESCRIPTION										
Serie dischi freno assale posteriore Set of brake discs rear axle										
										
ILLUSTRAZIONE / ILLUSTRATION	NOSTRO RIFERIMENTO OUR REFERENCE	RIFERIMENTO COSTRUTTORE O.E. REFERENCE								
 <p>E3 90R</p>	960911	42470841								
DESCRIZIONE / DESCRIPTION										
Serie pastiglie freno posteriore - Set of brake pads rear (impianto BREMBO - BREMBO system)										
<table border="1"> <thead> <tr> <th>WVA</th> <th>Larghezza Width - mm.</th> <th>Altezza Height - mm.</th> <th>Spessore Thickness - mm.</th> </tr> </thead> <tbody> <tr> <td>29123</td> <td>107</td> <td>61</td> <td>20</td> </tr> </tbody> </table>			WVA	Larghezza Width - mm.	Altezza Height - mm.	Spessore Thickness - mm.	29123	107	61	20
WVA	Larghezza Width - mm.	Altezza Height - mm.	Spessore Thickness - mm.							
29123	107	61	20							
										
ILLUSTRAZIONE / ILLUSTRATION	NOSTRO RIFERIMENTO OUR REFERENCE	RIFERIMENTO COSTRUTTORE O.E. REFERENCE								
<p>Connettore ovale - Lungh. mm. 150 Oval connector - Length mm. 150</p> <p>1</p>  <p>2</p>  <p>Connettore ovale - Lungh. mm. 150 Oval connector - Length mm. 150</p>	960979 960863	42548209 - 2991854 (1) 42548196 - 2992394 (2)								
DESCRIZIONE / DESCRIPTION										
Kit segnalatori usura freno posteriore (2 pz.) Set of brake wear indicators rear (2 pcs)										
Kit segnalatori usura freno posteriore (2 pz.) Set of brake wear indicators rear (2 pcs)										

TIPO DI VEICOLO / VEHICLE TYPE

NEW DAILY (96) 35.8
TURBODAILY (96) 35.10-49.10-35.12-49.12
DAILY CITY 2000 35C9-35C11-35C13 - 50C11-50C13

ILLUSTRAZIONE / ILLUSTRATION	NOSTRO RIFERIMENTO OUR REFERENCE	RIFERIMENTO COSTRUTTORE O.E. REFERENCE								
	960050	42470842 - 1908772								
DESCRIZIONE / DESCRIPTION										
<p>Serie dischi freno assale anteriore Set of brake discs front axle</p>										
ILLUSTRAZIONE / ILLUSTRATION	NOSTRO RIFERIMENTO OUR REFERENCE	RIFERIMENTO COSTRUTTORE O.E. REFERENCE								
	960051	42471111 - 1908773								
DESCRIZIONE / DESCRIPTION										
<p>Serie dischi freno assale posteriore Set of brake discs rear axle</p>										
ILLUSTRAZIONE / ILLUSTRATION	NOSTRO RIFERIMENTO OUR REFERENCE	RIFERIMENTO COSTRUTTORE O.E. REFERENCE								
<p>(impianto BREMBO - BREMBO system)</p>	960909	1906401								
DESCRIZIONE / DESCRIPTION										
<p>Serie pastiglie freno anteriore e posteriore Set of brake pads front and rear</p> <table border="1"> <thead> <tr> <th>WVA</th> <th>Larghezza Width - mm.</th> <th>Altezza Height - mm.</th> <th>Spessore Thickness - mm.</th> </tr> </thead> <tbody> <tr> <td>29121</td> <td>164,8</td> <td>66,5</td> <td>20.3</td> </tr> </tbody> </table>			WVA	Larghezza Width - mm.	Altezza Height - mm.	Spessore Thickness - mm.	29121	164,8	66,5	20.3
WVA	Larghezza Width - mm.	Altezza Height - mm.	Spessore Thickness - mm.							
29121	164,8	66,5	20.3							

TIPO DI VEICOLO / VEHICLE TYPE

NEW DAILY (96) 35.8**TURBODAILY (96) 35.10-49.10-35.12-49.12****DAILY CITY 2000 35C9-35C11-35C13 - 50C11-50C13**

ILLUSTRAZIONE / ILLUSTRATION

NOSTRO RIFERIMENTO
OUR REFERENCERIFERIMENTO COSTRUTTORE
O.E. REFERENCE

(impianto BREMBO - BREMBO system)

**E3 90R****960992**

2992339

DESCRIZIONE / DESCRIPTION

Serie pastiglie freno anteriore e posteriore
Set of brake pads front and rear

WVA	Larghezza Width - mm.	Altezza Height - mm.	Spessore Thickness - mm.
29121	164,8	66,5	20



ILLUSTRAZIONE / ILLUSTRATION

NOSTRO RIFERIMENTO
OUR REFERENCERIFERIMENTO COSTRUTTORE
O.E. REFERENCEConnettore ovale - Lungh. mm. 295
Oval connector - Length mm. 295**960879**

42548208 - 1908407

DESCRIZIONE / DESCRIPTION

Kit segnalatori usura freno anteriore e posteriore (2 pz.)
Set of brake wear indicators front and rear (2 pcs)

ILLUSTRAZIONE / ILLUSTRATION

NOSTRO RIFERIMENTO
OUR REFERENCERIFERIMENTO COSTRUTTORE
O.E. REFERENCEConnettore ovale - Lungh. mm. 190
Oval connector - Length mm. 190**960864**

42548195 - 2992393

DESCRIZIONE / DESCRIPTION

Kit segnalatori usura freno anteriore e posteriore (2 pz.)
Set of brake wear indicators front and rear (2 pcs)

TIPO DI VEICOLO / VEHICLE TYPE

DAILY CITY 2000

35S9-35S11-35S13

35C9-35C11-35C13-35C15

35S10-35S12

35C10-35C12

(dal telaio n° 5484645/D239463)

(from chassis n° 5484645/D239463)

ILLUSTRAZIONE / ILLUSTRATION

NOSTRO RIFERIMENTO OUR REFERENCE

RIFERIMENTO COSTRUTTORE O.E. REFERENCE

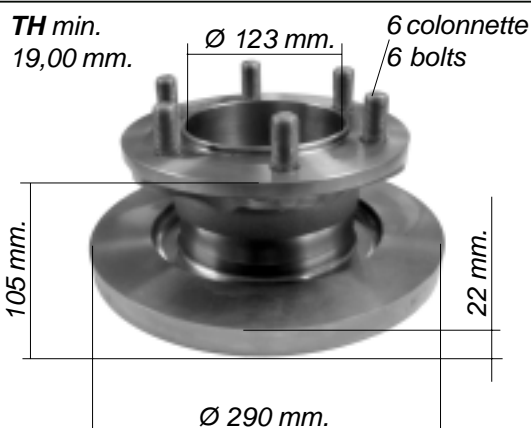

960501

42546401

DESCRIZIONE / DESCRIPTION

Serie dischi freno assale anteriore
Set of brake discs front axle



ILLUSTRAZIONE / ILLUSTRATION

NOSTRO RIFERIMENTO OUR REFERENCE

RIFERIMENTO COSTRUTTORE O.E. REFERENCE

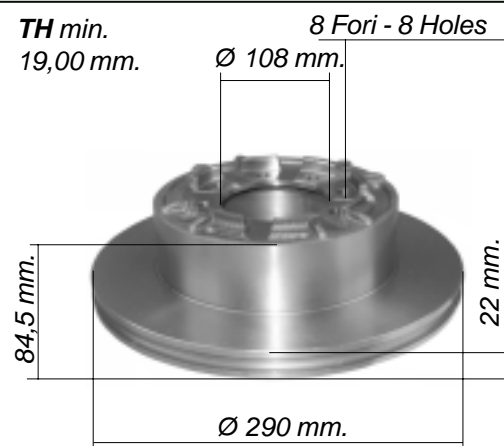

960051

42471111 - 1908773

DESCRIZIONE / DESCRIPTION

Serie dischi freno assale posteriore
Set of brake discs rear axle



ILLUSTRAZIONE / ILLUSTRATION

NOSTRO RIFERIMENTO OUR REFERENCE

RIFERIMENTO COSTRUTTORE O.E. REFERENCE



960502

2995632

DESCRIZIONE / DESCRIPTION

Serie pastiglie freno anteriore e posteriore
Set of brake pads front and rear

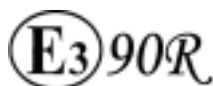

WVA	Larghezza Width - mm.	Altezza Height - mm.	Spessore Thickness - mm.
29160	164,50	69,80	20



TIPO DI VEICOLO / VEHICLE TYPE

DAILY CITY 2000

35S9-35S11-35S13

35C9-35C11-35C13-35C15

35S10-35S12

35C10-35C12

(dal telaio n° 5484645/D239463)

(from chassis n° 5484645/D239463)

ILLUSTRAZIONE / ILLUSTRATION



E3 90R

NOSTRO RIFERIMENTO
OUR REFERENCE**960503**RIFERIMENTO COSTRUTTORE
O.E. REFERENCE

2995633

DESCRIZIONE / DESCRIPTION

Serie pastiglie freno anteriore e posteriore
Set of brake pads front and rear

WVA	Larghezza Width - mm.	Altezza Height - mm.	Spessore Thickness - mm.
29121	165	67	20



ILLUSTRAZIONE / ILLUSTRATION



E3 90R

NOSTRO RIFERIMENTO
OUR REFERENCE**960504**RIFERIMENTO COSTRUTTORE
O.E. REFERENCE

2995693

DESCRIZIONE / DESCRIPTION

Serie pastiglie freno anteriore e posteriore
Set of brake pads front and rear

WVA	Larghezza Width - mm.	Altezza Height - mm.	Spessore Thickness - mm.
29121	164,80	66,50	20,30



ILLUSTRAZIONE / ILLUSTRATION

NOSTRO RIFERIMENTO
OUR REFERENCERIFERIMENTO COSTRUTTORE
O.E. REFERENCE

DESCRIZIONE / DESCRIPTION



TIPO DI VEICOLO / VEHICLE TYPE

DAILY CITY 2000 65C11 - 65C13 - 65C15

ILLUSTRAZIONE / ILLUSTRATION	NOSTRO RIFERIMENTO OUR REFERENCE	RIFERIMENTO COSTRUTTORE O.E. REFERENCE								
<p>TH min. 23,00 mm.</p> <p>9 Fori - 9 Holes</p> <p>Ø 80 mm.</p> <p>53 mm.</p> <p>26 mm.</p> <p>Ø 290 mm.</p>	960107	42471214								
DESCRIZIONE / DESCRIPTION										
<p>Serie dischi freno assale anteriore Set of brake discs front axle</p> <p>Fascia AUTOVENTILANTE SELF-VENTILATED Band</p>										
ILLUSTRAZIONE / ILLUSTRATION	NOSTRO RIFERIMENTO OUR REFERENCE	RIFERIMENTO COSTRUTTORE O.E. REFERENCE								
<p>E3 90R</p>	960973	42536101								
DESCRIZIONE / DESCRIPTION										
<p>Serie pastiglie freno anteriore - Set of brake pads front (impianto BREMBO - BREMBO system)</p> <table border="1"> <thead> <tr> <th>WVA</th> <th>Larghezza Width - mm.</th> <th>Altezza Height - mm.</th> <th>Spessore Thickness - mm.</th> </tr> </thead> <tbody> <tr> <td>29160</td> <td>164,50</td> <td>67,80</td> <td>20</td> </tr> </tbody> </table>			WVA	Larghezza Width - mm.	Altezza Height - mm.	Spessore Thickness - mm.	29160	164,50	67,80	20
WVA	Larghezza Width - mm.	Altezza Height - mm.	Spessore Thickness - mm.							
29160	164,50	67,80	20							
ILLUSTRAZIONE / ILLUSTRATION	NOSTRO RIFERIMENTO OUR REFERENCE	RIFERIMENTO COSTRUTTORE O.E. REFERENCE								
<p>Connettore ovale - Lungh. mm. 295 Oval connector - Length mm. 295</p> <p>1</p> <p>Connettore ovale - Lungh. mm. 190 Oval connector - Length mm. 190</p> <p>2</p>	960879 960864	42548208 - 1908407 (1) 42548195 - 2992393 (2)								
DESCRIZIONE / DESCRIPTION										
<p>Kit segnalatori usura freno anteriore e posteriore (2 pz.) Set of brake wear indicators front and rear (2 pcs)</p> <p>Kit segnalatori usura freno anteriore e posteriore (2 pz.) Set of brake wear indicators front and rear (2 pcs)</p>										

TIPO DI VEICOLO / VEHICLE TYPE

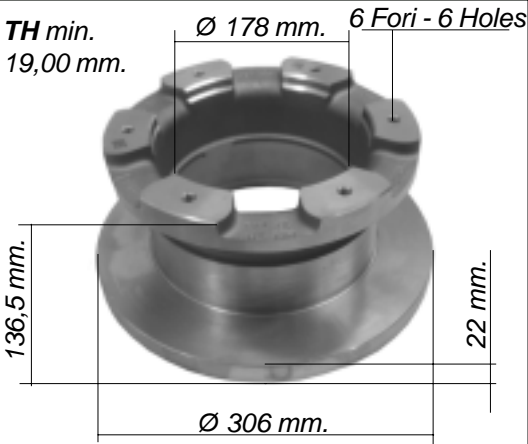
DAILY CITY 2000 65C11 - 65C13 - 65C15

ILLUSTRAZIONE / ILLUSTRATION	NOSTRO RIFERIMENTO OUR REFERENCE	RIFERIMENTO COSTRUTTORE O.E. REFERENCE								
<p>TH min. 19,00 mm.</p> <p>Ø 178 mm. 6 Fori - 6 Holes</p> 	960108	42471150								
DESCRIZIONE / DESCRIPTION										
Serie dischi freno assale posteriore Set of brake discs rear axle										
										
ILLUSTRAZIONE / ILLUSTRATION	NOSTRO RIFERIMENTO OUR REFERENCE	RIFERIMENTO COSTRUTTORE O.E. REFERENCE								
	960899	42535791								
DESCRIZIONE / DESCRIPTION										
Serie pastiglie freno posteriore - Set of brake pads rear										
<table border="1"> <thead> <tr> <th>WVA</th> <th>Larghezza Width - mm.</th> <th>Altezza Height - mm.</th> <th>Spessore Thickness - mm.</th> </tr> </thead> <tbody> <tr> <td>29121 29357</td> <td>164,8</td> <td>66,5</td> <td>20,3</td> </tr> </tbody> </table>			WVA	Larghezza Width - mm.	Altezza Height - mm.	Spessore Thickness - mm.	29121 29357	164,8	66,5	20,3
WVA	Larghezza Width - mm.	Altezza Height - mm.	Spessore Thickness - mm.							
29121 29357	164,8	66,5	20,3							
										
ILLUSTRAZIONE / ILLUSTRATION	NOSTRO RIFERIMENTO OUR REFERENCE	RIFERIMENTO COSTRUTTORE O.E. REFERENCE								
<p>Connettore ovale - Lungh. mm. 295 Oval connector - Length mm. 295</p> <p>1</p> 	960879	42548208 - 1908407 (1)								
<p>Connettore ovale - Lungh. mm 190 Oval connector - Length mm. 190</p> <p>2</p> 	960864	42548195 - 2992393 (2)								
DESCRIZIONE / DESCRIPTION										
Kit segnalatori usura freno anteriore e posteriore (2 pz.) Set of brake wear indicators front and rear (2 pcs)										
Kit segnalatori usura freno anteriore e posteriore (2 pz.) Set of brake wear indicators front and rear (2 pcs)										

TIPO DI VEICOLO / VEHICLE TYPE

DAILY 2006 M.Y.
35C10/C12/C15/C18
35S14
50C15/C18

ILLUSTRAZIONE / ILLUSTRATION

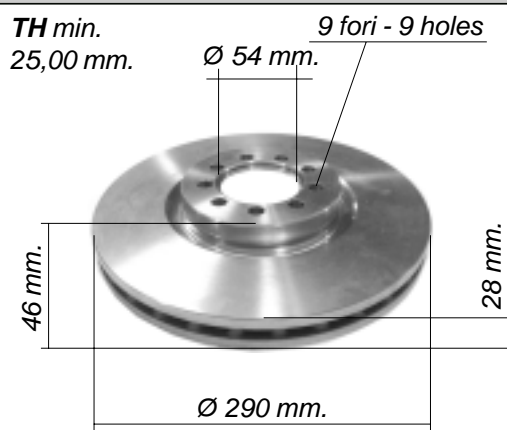

NOSTRO RIFERIMENTO OUR REFERENCE

960512

RIFERIMENTO COSTRUTTORE O.E. REFERENCE

2996121

DESCRIZIONE / DESCRIPTION

Serie dischi freno assale anteriore
Set of brake discs front axle



ILLUSTRAZIONE / ILLUSTRATION



NOSTRO RIFERIMENTO OUR REFERENCE

960513

RIFERIMENTO COSTRUTTORE O.E. REFERENCE

42555881

DESCRIZIONE / DESCRIPTION

Serie pastiglie freno anteriore - Set of brake pads front

WVA	Larghezza Width - mm.	Altezza Height - mm.	Spessore Thickness - mm.
29229	163,10	66,70	20,80



ILLUSTRAZIONE / ILLUSTRATION



Connettore ovale - Lungh. mm. 145
Oval connector - Length mm. 145

NOSTRO RIFERIMENTO OUR REFERENCE

960514

RIFERIMENTO COSTRUTTORE O.E. REFERENCE

42555634

DESCRIZIONE / DESCRIPTION

Kit indicatori usura freno anteriore (Pz. 2)
Set of brake wear indicators front (2 pcs.)

TIPO DI VEICOLO / VEHICLE TYPE

DAILY 2006 M.Y. (dal 05/2006 - from 05/2006)

29L10/L12/L14

35C10/C12/C14/C18

35S14

ILLUSTRAZIONE / ILLUSTRATION

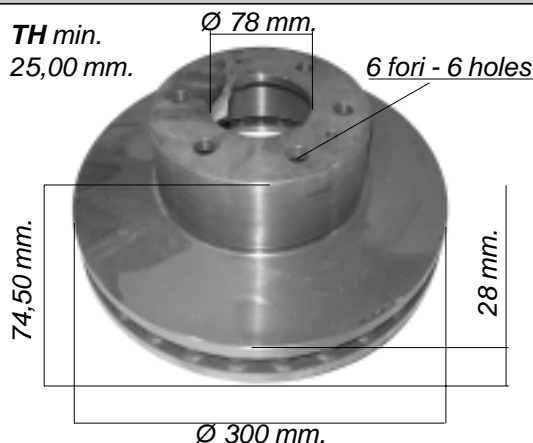
NOSTRO RIFERIMENTO
OUR REFERENCE**960696**RIFERIMENTO COSTRUTTORE
O.E. REFERENCE

2996131

DESCRIZIONE / DESCRIPTION

Serie dischi freno assale anteriore
Set of brake discs front axle

ILLUSTRAZIONE / ILLUSTRATION

NOSTRO RIFERIMENTO
OUR REFERENCE**960513**RIFERIMENTO COSTRUTTORE
O.E. REFERENCE

42555881

DESCRIZIONE / DESCRIPTION

Serie pastiglie freno anteriore - Set of brake pads front

WVA	Larghezza Width - mm.	Altezza Height - mm.	Spessore Thickness - mm.
29229	163,10	66,70	20,80



ILLUSTRAZIONE / ILLUSTRATION

Connettore ovale - Lungh. mm 145
Oval connector - Length mm. 145NOSTRO RIFERIMENTO
OUR REFERENCE**960514**RIFERIMENTO COSTRUTTORE
O.E. REFERENCE

42555634

DESCRIZIONE / DESCRIPTION

Kit indicatori usura freno anteriore (Pz. 2)
Set of brake wear indicators front (2 pcs.)

TIPO DI VEICOLO / VEHICLE TYPE

DAILY 2006 M.Y.
35C14/C16/C18

CON ABS - WITH ABS

ILLUSTRAZIONE / ILLUSTRATION

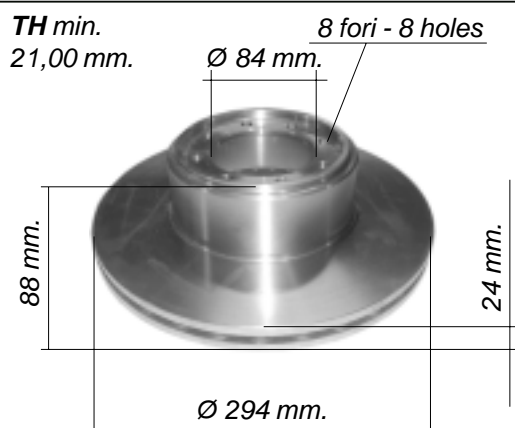

NOSTRO RIFERIMENTO OUR REFERENCE

960515

RIFERIMENTO COSTRUTTORE O.E. REFERENCE

2996043

DESCRIZIONE / DESCRIPTION

Serie dischi freno assale posteriore
Set of brake discs rear axle



ILLUSTRAZIONE / ILLUSTRATION



NOSTRO RIFERIMENTO OUR REFERENCE

960516

RIFERIMENTO COSTRUTTORE O.E. REFERENCE

42555917

DESCRIZIONE / DESCRIPTION

Serie pastiglie freno posteriore - Set of brake pads rear

WVA	Larghezza Width - mm.	Altezza Height - mm.	Spessore Thickness - mm.
29232	141,10	72,75	21



ILLUSTRAZIONE / ILLUSTRATION



Connettore ovale - Lungh. mm.295
Oval connector - Length mm. 295

NOSTRO RIFERIMENTO OUR REFERENCE

960517

RIFERIMENTO COSTRUTTORE O.E. REFERENCE

42556205

DESCRIZIONE / DESCRIPTION

Kit indicatori usura freno posteriore (Pz. 2)
Set of brake wear indicators rear (2 pcs.)

TIPO DI VEICOLO / VEHICLE TYPE

DAILY 2006 M.Y.
35C14/C16/C18

SENZA ABS - WITHOUT ABS

ILLUSTRAZIONE / ILLUSTRATION

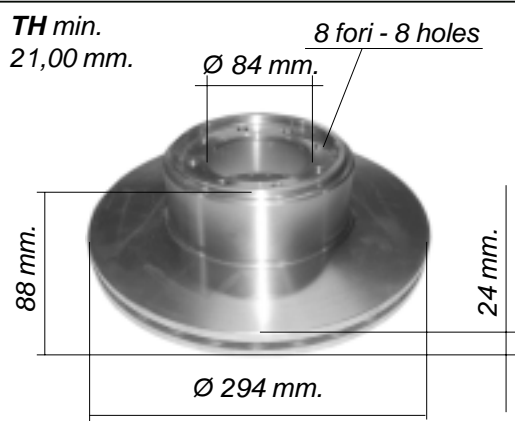
NOSTRO RIFERIMENTO
OUR REFERENCE

960498

RIFERIMENTO COSTRUTTORE
O.E. REFERENCE

2996033

DESCRIZIONE / DESCRIPTION

Serie dischi freno assale posteriore
Set of brake discs rear axle

ILLUSTRAZIONE / ILLUSTRATION

NOSTRO RIFERIMENTO
OUR REFERENCE

960516

RIFERIMENTO COSTRUTTORE
O.E. REFERENCE

42555917

DESCRIZIONE / DESCRIPTION

Serie pastiglie freno posteriore - Set of brake pads rear

WVA	Larghezza Width - mm.	Altezza Height - mm.	Spessore Thickness - mm.
29232	141,10	72,75	21



ILLUSTRAZIONE / ILLUSTRATION

Connettore ovale - Lungh. mm.295
Oval connector - Length mm. 295NOSTRO RIFERIMENTO
OUR REFERENCE

960517

RIFERIMENTO COSTRUTTORE
O.E. REFERENCE

42556205

DESCRIZIONE / DESCRIPTION

Kit indicatori usura freno posteriore (Pz. 2)
Set of brake wear indicators rear (2 pcs.)

TIPO DI VEICOLO / VEHICLE TYPE

DAILY 2006 M.Y. (dal 05/2006 - from 05/2006)
35C10/C12/C14/C18
35S14

CON ABS - WITH ABS

ILLUSTRAZIONE / ILLUSTRATION

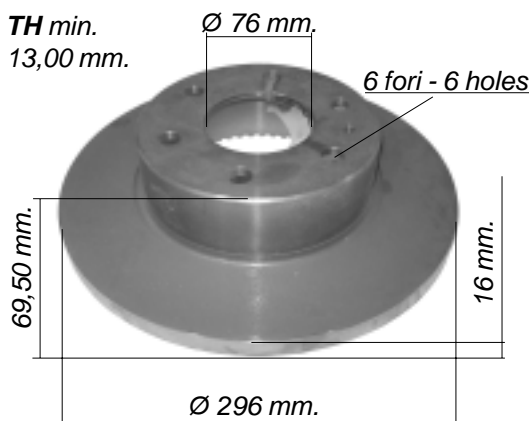

NOSTRO RIFERIMENTO OUR REFERENCE

960695

RIFERIMENTO COSTRUTTORE O.E. REFERENCE

2996027

DESCRIZIONE / DESCRIPTION

Serie dischi freno assale posteriore
Set of brake discs rear axle



ILLUSTRAZIONE / ILLUSTRATION



NOSTRO RIFERIMENTO OUR REFERENCE

960516

RIFERIMENTO COSTRUTTORE O.E. REFERENCE

42555917

DESCRIZIONE / DESCRIPTION

Serie pastiglie freno posteriore - Set of brake pads rear

WVA	Larghezza Width - mm.	Altezza Height - mm.	Spessore Thickness - mm.
29232	141,10	72,75	21



ILLUSTRAZIONE / ILLUSTRATION



Connettore ovale - Lungh. mm.295
Oval connector - Length mm. 295

NOSTRO RIFERIMENTO OUR REFERENCE

960517

RIFERIMENTO COSTRUTTORE O.E. REFERENCE

42556205

DESCRIZIONE / DESCRIPTION

Kit indicatori usura freno posteriore (Pz. 2)
Set of brake wear indicators rear (2 pcs.)

TIPO DI VEICOLO / VEHICLE TYPE

DAILY 2006 M.Y. (dal 05/2006 - from 05/2006)

29L10/L12/L14

35C10/C12/C14/C18

35S10/S12/S14/S18

SENZA ABS - WITHOUT ABS

ILLUSTRAZIONE / ILLUSTRATION

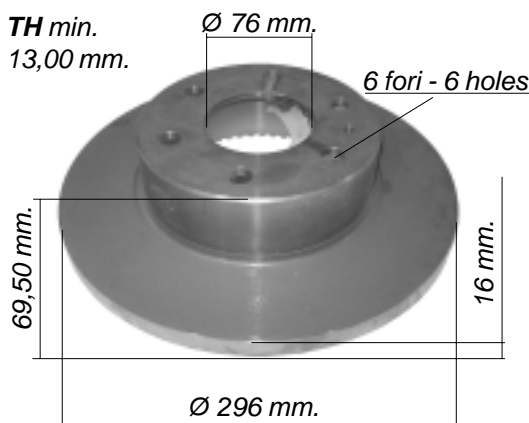
NOSTRO RIFERIMENTO
OUR REFERENCE**960694**RIFERIMENTO COSTRUTTORE
O.E. REFERENCE

2996028

DESCRIZIONE / DESCRIPTION

Serie dischi freno assale posteriore
Set of brake discs rear axle

ILLUSTRAZIONE / ILLUSTRATION

NOSTRO RIFERIMENTO
OUR REFERENCE**960516**RIFERIMENTO COSTRUTTORE
O.E. REFERENCE

42555917

DESCRIZIONE / DESCRIPTION

Serie pastiglie freno posteriore - Set of brake pads rear

WVA	Larghezza Width - mm.	Altezza Height - mm.	Spessore Thickness - mm.
29232	141,10	72,75	21



ILLUSTRAZIONE / ILLUSTRATION

Connettore ovale - Lungh. mm.295
Oval connector - Length mm. 295NOSTRO RIFERIMENTO
OUR REFERENCE**960517**RIFERIMENTO COSTRUTTORE
O.E. REFERENCE

42556205

DESCRIZIONE / DESCRIPTION

Kit indicatori usura freno posteriore (Pz. 2)
Set of brake wear indicators rear (2 pcs.)

TIPO DI VEICOLO / VEHICLE TYPE

DAILY 2006
50C15/C18
60C15/C18
65C15/C18

ILLUSTRAZIONE / ILLUSTRATION

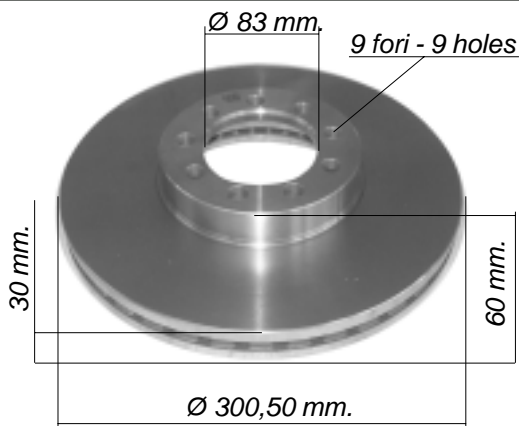

NOSTRO RIFERIMENTO OUR REFERENCE

960697

RIFERIMENTO COSTRUTTORE O.E. REFERENCE

2996122

DESCRIZIONE / DESCRIPTION

Serie dischi freno assale anteriore
Set of brake discs front axle

Fascia AUTOVENTILANTE
SELF-VENTILATED Band



ILLUSTRAZIONE / ILLUSTRATION



NOSTRO RIFERIMENTO OUR REFERENCE

961015

RIFERIMENTO COSTRUTTORE O.E. REFERENCE

42555669

DESCRIZIONE / DESCRIPTION

Serie pastiglie freno anteriore - Set of brake pads front

WVA	Larghezza Width - mm.	Altezza Height - mm.	Spessore Thickness - mm.
29122	174.60	85.40	22.00



ILLUSTRAZIONE / ILLUSTRATION



Connettore ovale - Lungh. mm. 190
Oval connector - Length mm. 190

NOSTRO RIFERIMENTO OUR REFERENCE

960864

RIFERIMENTO COSTRUTTORE O.E. REFERENCE

42548195 - 2992393

DESCRIZIONE / DESCRIPTION

Kit indicatori usura freno anteriore (Pz. 2)
Set of brake wear indicators front (2 pcs.)

TIPO DI VEICOLO / VEHICLE TYPE

DAILY 2006
50C15/C18
60C15/C18
65C15/C18

ILLUSTRAZIONE / ILLUSTRATION

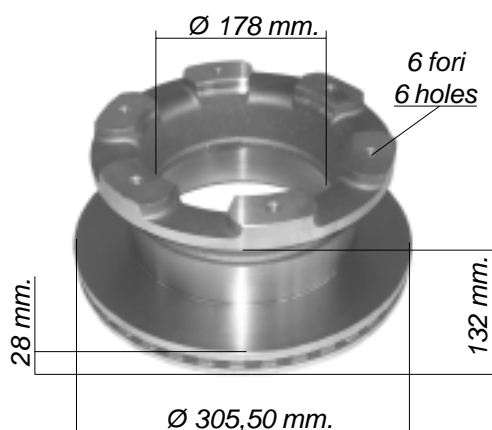
NOSTRO RIFERIMENTO
OUR REFERENCE**960698**RIFERIMENTO COSTRUTTORE
O.E. REFERENCE

2996049

DESCRIZIONE / DESCRIPTION

Serie dischi freno assale posteriore
Set of brake discs rear axle

Fascia AUTOVENTILANTE
SELF-VENTILATED Band



ILLUSTRAZIONE / ILLUSTRATION

NOSTRO RIFERIMENTO
OUR REFERENCE**960895**RIFERIMENTO COSTRUTTORE
O.E. REFERENCE

42555633

DESCRIZIONE / DESCRIPTION

Serie pastiglie freno posteriore - Set of brake pads rear

WVA	Larghezza Width - mm.	Altezza Height - mm.	Spessore Thickness - mm.
-	184.20	64.70	22.70



ILLUSTRAZIONE / ILLUSTRATION



Connettore ovale - Lungh. mm. 130
Oval connector - Length mm. 130

NOSTRO RIFERIMENTO
OUR REFERENCE**960514**RIFERIMENTO COSTRUTTORE
O.E. REFERENCE

42555634

DESCRIZIONE / DESCRIPTION

Kit indicatori usura freno posteriore (Pz. 2)
Set of brake wear indicators rear (2 pcs.)

TIPO DI VEICOLO / VEHICLE TYPE

TURBOZETA 65.12 - 79.12
ZETA 79.14
(IMPIANTO WABCO / WABCO SYSTEM)

ILLUSTRAZIONE / ILLUSTRATION

NOSTRO RIFERIMENTO OUR REFERENCE

RIFERIMENTO COSTRUTTORE O.E. REFERENCE

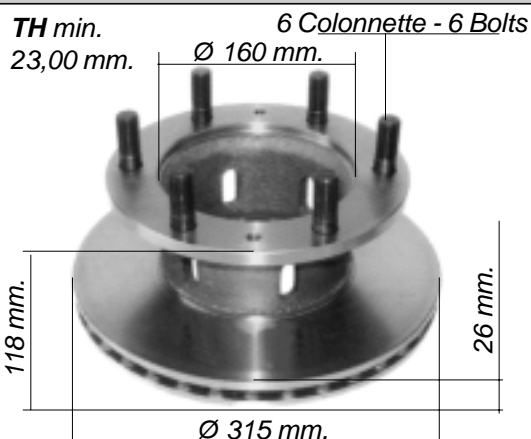

960024

1904532
7171274

DESCRIZIONE / DESCRIPTION

Serie dischi freno assale anteriore
Set of brake discs front axle

**Fascia AUTOVENTILANTE
SELF-VENTILATED Band**



ILLUSTRAZIONE / ILLUSTRATION

NOSTRO RIFERIMENTO OUR REFERENCE

RIFERIMENTO COSTRUTTORE O.E. REFERENCE

Connettore tondo - Round connector



960904

1906345

DESCRIZIONE / DESCRIPTION

Serie pastiglie freno anteriore - Set of brake pads front
(impianto PERROT - PERROT system) - **contatto aperto / opened contact**

TURBOZETA
65.12- (fino/tin chassis 351018) - 79.12
ZETA 79.14 (fino/tin chassis 363403)

WVA	Larghezza Width - mm.	Altezza Height - mm.	Spessore Thickness - mm.
29017 29024	191	87	23



ILLUSTRAZIONE / ILLUSTRATION

NOSTRO RIFERIMENTO OUR REFERENCE

RIFERIMENTO COSTRUTTORE O.E. REFERENCE

Connettore tondo - Round connector



960903

1906070

DESCRIZIONE / DESCRIPTION

Serie pastiglie freno anteriore - Set of brake pads front
(impianto PERROT - PERROT system) - (fino/tin 1995)

TURBOZETA
65.12- (da/from chassis 351019) - 79.12
ZETA 79.14 (da/from chassis 363404)

WVA	Larghezza Width - mm.	Altezza Height - mm.	Spessore Thickness - mm.
29024 29029	191	87	23

**contatto chiuso
closed contact**



TIPO DI VEICOLO / VEHICLE TYPE

ZETA 79.14 - 109.14

(impianto GIRLING - GIRLING system)

EUROCARGO 80E15/E17/E18/E21**EUROCARGO 100E17/E18/E21****EUROCARGO TECTOR 180E21**

ILLUSTRAZIONE / ILLUSTRATION

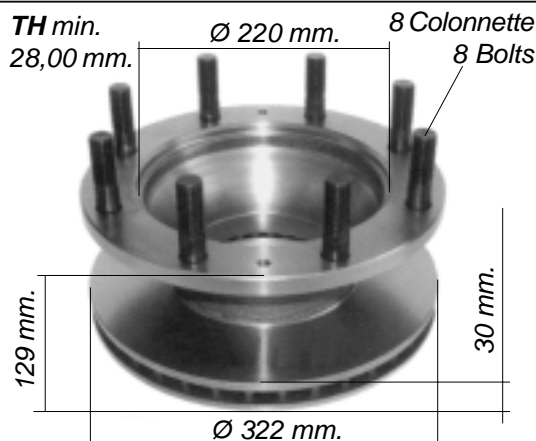
NOSTRO RIFERIMENTO
OUR REFERENCERIFERIMENTO COSTRUTTORE
O.E. REFERENCE**960032**

1907765 - 7171255

DESCRIZIONE / DESCRIPTION

Serie dischi freno assale anteriore
Set of brake discs front axleFascia
AUTOVENTILANTE

ILLUSTRAZIONE / ILLUSTRATION

NOSTRO RIFERIMENTO
OUR REFERENCERIFERIMENTO COSTRUTTORE
O.E. REFERENCE

(impianto PERROT - PERROT system)

**960939**

1906297

DESCRIZIONE / DESCRIPTION

Serie pastiglie freno anteriore e posteriore
Set of brake pads front and rear

WVA	Larghezza Width - mm.	Altezza Height - mm.	Spessore Thickness - mm.
29067	176	78	22



ILLUSTRAZIONE / ILLUSTRATION

NOSTRO RIFERIMENTO
OUR REFERENCERIFERIMENTO COSTRUTTORE
O.E. REFERENCEConnettore tondo - Lungh. mm. 440
Round connector - Length mm. 440**960932**

1907942

DESCRIZIONE / DESCRIPTION

Kit segnalatori usura freno anteriore e posteriore (2 pz.)
Set of brake wear indicators front and rear (2 pcs)

TIPO DI VEICOLO / VEHICLE TYPE

EUROCARGO

60E10-60E12-60E14
65E10-65E12-65E14
75E12-75E14-75E15

EUROCARGO TECTOR

65E13-65E15
75E13-75E15-75E17-75E18

ILLUSTRAZIONE / ILLUSTRATION

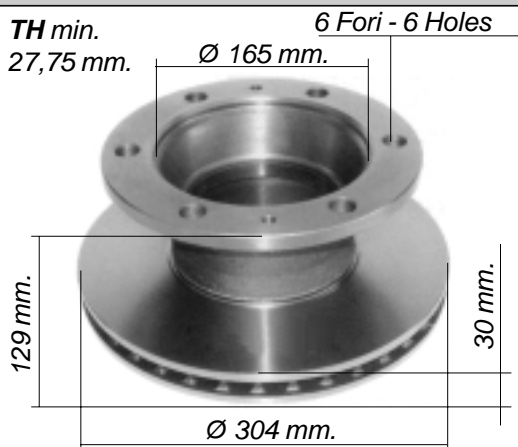

NOSTRO RIFERIMENTO OUR REFERENCE

960036

RIFERIMENTO COSTRUTTORE O.E. REFERENCE

1908577
1907725

DESCRIZIONE / DESCRIPTION

Serie dischi freno assale anteriore e posteriore
Set of brake discs front and rear axle

Fascia AUTOVENTILANTE
SELF-VENTILATED Band



ILLUSTRAZIONE / ILLUSTRATION

Impianto BREMBO - BREMBO system 1996



NOSTRO RIFERIMENTO OUR REFERENCE

960912

RIFERIMENTO COSTRUTTORE O.E. REFERENCE

1906416

DESCRIZIONE / DESCRIPTION

Serie pastiglie freno anteriore e posteriore
Set of brake pads front and rear

WVA	Larghezza Width - mm.	Altezza Height - mm.	Spessore Thickness - mm.
29122	175	85,5	22



ILLUSTRAZIONE / ILLUSTRATION

Connettore tondo - Round connector



NOSTRO RIFERIMENTO OUR REFERENCE

960029

RIFERIMENTO COSTRUTTORE O.E. REFERENCE

1906298

DESCRIZIONE / DESCRIPTION

Serie pastiglie freno anteriore e posteriore
Set of brake pads front and rear





WVA	Larghezza Width - mm.	Altezza Height - mm.	Spessore Thickness - mm.
29065 29835	175	85	22



(impianto PERROT - PERROT system)
1991-1996

TIPO DI VEICOLO / VEHICLE TYPE

EUROCARGO60E10-60E12-60E14
65E10-65E12-65E14
75E12-75E14-75E15**EUROCARGO TECTOR**65E13-65E15
75E13-75E15-75E17-75E18

ILLUSTRAZIONE / ILLUSTRATION	NOSTRO RIFERIMENTO OUR REFERENCE	RIFERIMENTO COSTRUTTORE O.E. REFERENCE
 <p>Connettore ovale - Lungh. mm. 295 Oval connector - Length mm. 295</p>	960879	42548208 - 1908407
ILLUSTRAZIONE / ILLUSTRATION	NOSTRO RIFERIMENTO OUR REFERENCE	RIFERIMENTO COSTRUTTORE O.E. REFERENCE
 <p>Connettore tondo - Lungh. mm. 440 Round connector - Length mm. 440</p>	960877	1908825
ILLUSTRAZIONE / ILLUSTRATION	NOSTRO RIFERIMENTO OUR REFERENCE	RIFERIMENTO COSTRUTTORE O.E. REFERENCE
 <p>Connettore tondo - Lungh. mm. 440 Round connector - Length mm. 440</p>	960932	1907942
ILLUSTRAZIONE / ILLUSTRATION	NOSTRO RIFERIMENTO OUR REFERENCE	RIFERIMENTO COSTRUTTORE O.E. REFERENCE
 <p>Connettore ovale - Lungh. mm. 150 Oval connector - Length mm. 150</p>	960888	1906462

TIPO DI VEICOLO / VEHICLE TYPE

EUROCARGO

80E15-80E18-80E21

85E15-85E18

100E15-100E18-100E21

180E21

(impianto GIRLING - GIRLING system)

EUROCARGO TECTOR

80E17-80E18-80E21

90E17-90E18-90E21

100E17-100E18-100E21

ILLUSTRAZIONE / ILLUSTRATION



NOSTRO RIFERIMENTO OUR REFERENCE

960037

RIFERIMENTO COSTRUTTORE O.E. REFERENCE

1908578
1907726

DESCRIZIONE / DESCRIPTION

Serie dischi freno assale anteriore e posteriore
Set of brake discs front and rear axle

Fascia AUTOVENTILANTE
SELF-VENTILATED Band



ILLUSTRAZIONE / ILLUSTRATION



NOSTRO RIFERIMENTO OUR REFERENCE

960939

RIFERIMENTO COSTRUTTORE O.E. REFERENCE

1906297

DESCRIZIONE / DESCRIPTION

Serie pastiglie freno anteriore e posteriore
Set of brake pads front and rear

WVA	Larghezza Width - mm.	Altezza Height - mm.	Spessore Thickness - mm.
29067	176	78	22



ILLUSTRAZIONE / ILLUSTRATION

Connettore tondo - Round connector



NOSTRO RIFERIMENTO OUR REFERENCE

960902

RIFERIMENTO COSTRUTTORE O.E. REFERENCE

1906043

DESCRIZIONE / DESCRIPTION

Serie pastiglie freno anteriore e posteriore
Set of brake pads front and rear

WVA	Larghezza Width - mm.	Altezza Height - mm.	Spessore Thickness - mm.
29302 29033	175,5	78	21



TIPO DI VEICOLO / VEHICLE TYPE

EUROCARGO60E10-60E12-60E14
65E10-65E12-65E14
75E12-75E14-75E15**EUROCARGO TECTOR**65E13-65E15
75E13-75E15-75E17-75E18

ILLUSTRAZIONE / ILLUSTRATION

Connettore ovale - Lungh.mm. 295
Oval connector - Length mm. 295NOSTRO RIFERIMENTO
OUR REFERENCE**960879**RIFERIMENTO COSTRUTTORE
O.E. REFERENCE

42548208 - 1908407

DESCRIZIONE / DESCRIPTION

Kit segnalatori usura freno anteriore e posteriore (2 pz.)
Set of brake wear indicators front and rear (2 pcs)

ILLUSTRAZIONE / ILLUSTRATION

Connettore tondo - Lungh.mm. 440
Round connector - Length mm. 440NOSTRO RIFERIMENTO
OUR REFERENCE**960877**RIFERIMENTO COSTRUTTORE
O.E. REFERENCE

1908825

DESCRIZIONE / DESCRIPTION

Kit segnalatori usura freno anteriore (2 pz.)
Set of brake wear indicators front (2 pcs)

ILLUSTRAZIONE / ILLUSTRATION

Connettore tondo - Lungh.mm. 440
Round connector - Length mm. 440NOSTRO RIFERIMENTO
OUR REFERENCE**960932**RIFERIMENTO COSTRUTTORE
O.E. REFERENCE

1907942

DESCRIZIONE / DESCRIPTION

Kit segnalatori usura freno anteriore e posteriore (2 pz.)
Set of brake wear indicators front and rear (2 pcs)

ILLUSTRAZIONE / ILLUSTRATION

Connettore ovale - Lungh.mm. 150
Oval connector - Length mm. 150NOSTRO RIFERIMENTO
OUR REFERENCE**960888**RIFERIMENTO COSTRUTTORE
O.E. REFERENCE

1906462

DESCRIZIONE / DESCRIPTION

Kit segnalatori usura freno anteriore (2 pz.)
Set of brake wear indicators front (2 pcs)

TIPO DI VEICOLO / VEHICLE TYPE

EUROCARGO

120E15-120E18-120E23 - 150E18/E23E27

130E15-130E18-130E23 - 260E23 - 280E23 - 320E27

(impianto BENDIX - BENDIX system)

ILLUSTRAZIONE / ILLUSTRATION	NOSTRO RIFERIMENTO OUR REFERENCE	RIFERIMENTO COSTRUTTORE O.E. REFERENCE								
	960048	1907568								
DESCRIZIONE / DESCRIPTION										
<p>Serie dischi freno assale anteriore Set of brake discs front axle</p> <p>Fascia AUTOVENTILANTE SELF-VENTILATED Band</p>										
ILLUSTRAZIONE / ILLUSTRATION	NOSTRO RIFERIMENTO OUR REFERENCE	RIFERIMENTO COSTRUTTORE O.E. REFERENCE								
	960938	1906170								
DESCRIZIONE / DESCRIPTION										
<p>Serie pastiglie freno anteriore Set of brake pads front</p> <table border="1"> <thead> <tr> <th>WVA</th> <th>Larghezza Width - mm.</th> <th>Altezza Height - mm.</th> <th>Spessore Thickness - mm.</th> </tr> </thead> <tbody> <tr> <td>29032</td> <td>206</td> <td>107</td> <td>25</td> </tr> </tbody> </table>			WVA	Larghezza Width - mm.	Altezza Height - mm.	Spessore Thickness - mm.	29032	206	107	25
WVA	Larghezza Width - mm.	Altezza Height - mm.	Spessore Thickness - mm.							
29032	206	107	25							
ILLUSTRAZIONE / ILLUSTRATION	NOSTRO RIFERIMENTO OUR REFERENCE	RIFERIMENTO COSTRUTTORE O.E. REFERENCE								
<p>Connettore ovale - Lungh. mm. 150 Oval connector - Length mm. 150</p>	960878	1908231								
DESCRIZIONE / DESCRIPTION										
<p>Kit segnalatori usura freno anteriore (2 pz.) Set of brake wear indicators front (2 pcs)</p>										
ILLUSTRAZIONE / ILLUSTRATION	NOSTRO RIFERIMENTO OUR REFERENCE	RIFERIMENTO COSTRUTTORE O.E. REFERENCE								
<p>Connettore tondo - Lungh. mm. 300 Round connector - Length mm. 300</p>	960880	1907956								
DESCRIZIONE / DESCRIPTION										
<p>Kit segnalatori usura freno anteriore (2 pz.) Set of brake wear indicators front (2 pcs)</p>										

TIPO DI VEICOLO / VEHICLE TYPE

EUROCARGO

130E18 - 150E15-150E18-150E23-150E27

280E23-320E27

(impianto BENDIX - BENDIX system)

ILLUSTRAZIONE / ILLUSTRATION

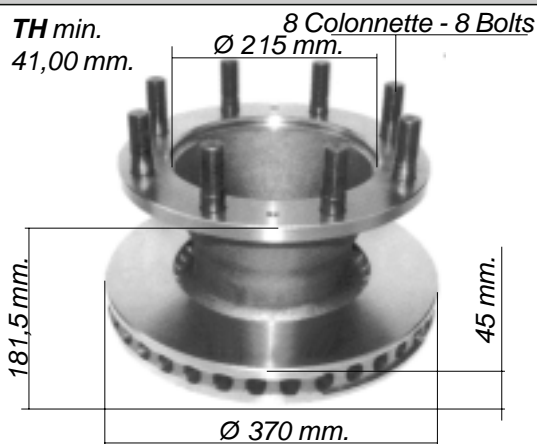
NOSTRO RIFERIMENTO
OUR REFERENCERIFERIMENTO COSTRUTTORE
O.E. REFERENCE**960049**

1907569

DESCRIZIONE / DESCRIPTION

Serie dischi freno assale anteriore
Set of brake discs front axleFascia AUTOVENTILANTE
SELF-VENTILATED Band

ILLUSTRAZIONE / ILLUSTRATION

NOSTRO RIFERIMENTO
OUR REFERENCERIFERIMENTO COSTRUTTORE
O.E. REFERENCE**960938**

1906170

DESCRIZIONE / DESCRIPTION

Serie pastiglie freno anteriore
Set of brake pads front

WVA	Larghezza Width - mm.	Altezza Height - mm.	Spessore Thickness - mm.
29032	206	107	25



ILLUSTRAZIONE / ILLUSTRATION

NOSTRO RIFERIMENTO
OUR REFERENCERIFERIMENTO COSTRUTTORE
O.E. REFERENCEConnettore ovale - Lungh. mm. 150
Oval connector - Length mm. 150**960878**

1908231

DESCRIZIONE / DESCRIPTION

Kit segnalatori usura freno anteriore (2 pz.)
Set of brake wear indicators front (2 pcs)

ILLUSTRAZIONE / ILLUSTRATION

NOSTRO RIFERIMENTO
OUR REFERENCERIFERIMENTO COSTRUTTORE
O.E. REFERENCEConnettore tondo - Lungh. mm. 300
Round connector - Length mm. 300**960880**

1907956

DESCRIZIONE / DESCRIPTION

Kit segnalatori usura freno anteriore (2 pz.)
Set of brake wear indicators front (2 pcs)

TIPO DI VEICOLO / VEHICLE TYPE

EUROCARGO TECTOR 95E15 - 95E18W
EUROFIRE 95E21
EUROCARGO TECTOR 100E18 - 100E21
EUROFIRE TECTOR 100E21
EUROCARGO RESTYLING 100E18

ILLUSTRAZIONE / ILLUSTRATION

NOSTRO RIFERIMENTO OUR REFERENCE

RIFERIMENTO COSTRUTTORE O.E. REFERENCE

960409

1908179

DESCRIZIONE / DESCRIPTION

Serie dischi freno assale anteriore
Set of brake discs front axle

**Fascia AUTOVENTILANTE
SELF-VENTILATED Band**



ILLUSTRAZIONE / ILLUSTRATION

NOSTRO RIFERIMENTO OUR REFERENCE

RIFERIMENTO COSTRUTTORE O.E. REFERENCE

960897

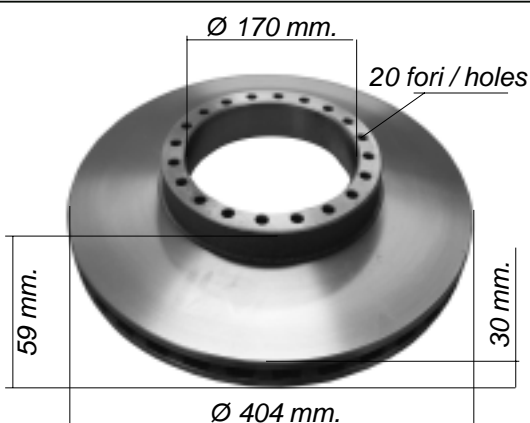
1906353

DESCRIZIONE / DESCRIPTION

Serie pastiglie freno con indicatore
Set of brake pads with wear indicator

WVA	Larghezza Width - mm.	Altezza Height - mm.	Spessore Thickness - mm.
29068	190	95	20



ILLUSTRAZIONE / ILLUSTRATION

NOSTRO RIFERIMENTO OUR REFERENCE

RIFERIMENTO COSTRUTTORE O.E. REFERENCE

960852

42552778 - 42538068

DESCRIZIONE / DESCRIPTION

Indicatore usura freno
Brake wear indicator
EUROCARGO 120E15/E18/E21/E23
150E15/E18/E23/E27
EUROCARGO TECTOR 130E15/E18/E23/E24/E28
170E15/E23



TIPO DI VEICOLO / VEHICLE TYPE

EUROCARGO TECTOR

120E17 - 120E18 - 120E21

120EL15-120EL18-120EL21

(impianto WABCO - WABCO system)

ILLUSTRAZIONE / ILLUSTRATION

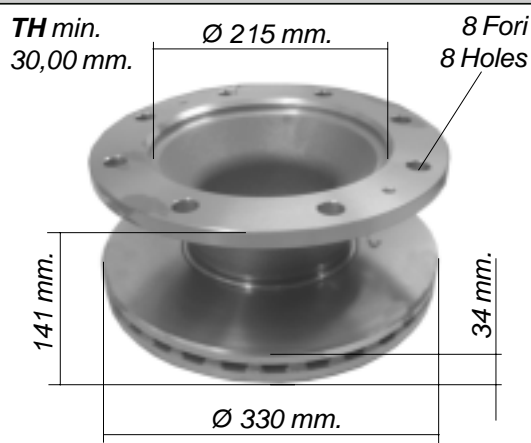
NOSTRO RIFERIMENTO
OUR REFERENCERIFERIMENTO COSTRUTTORE
O.E. REFERENCE**960232**1906466
7183632

DESCRIZIONE / DESCRIPTION

Serie dischi freno assale anteriore e posteriore
Set of brake discs front and rear axleFascia AUTOVENTILANTE
SELF-VENTILATED Band

ILLUSTRAZIONE / ILLUSTRATION

NOSTRO RIFERIMENTO
OUR REFERENCERIFERIMENTO COSTRUTTORE
O.E. REFERENCE**960969**

1906467

DESCRIZIONE / DESCRIPTION

Serie pastiglie freno anteriore e posteriore
Set of brake pads front and rear

WVA	Larghezza Width - mm.	Altezza Height - mm.	Spessore Thickness - mm.
29088	175,5	85,6	26



ILLUSTRAZIONE / ILLUSTRATION

NOSTRO RIFERIMENTO
OUR REFERENCERIFERIMENTO COSTRUTTORE
O.E. REFERENCEConnettore ovale - Lungh. mm.290
Oval connector - Length mm. 290

1

**960881**

1906468 (1)

960805

42536956 (2)

DESCRIZIONE / DESCRIPTION

Kit segnalatori usura freno anteriore e posteriore (2 pz.)
Set of brake wear indicators front and rear (2 pcs)

2

Connettore ovale - Lungh. mm.290
Oval connector - Length mm. 290Kit segnalatori usura freno ant. e post. con supporto (2 pz.)
Set of brake wear indicators front and rear with support (2 pcs)

TIPO DI VEICOLO / VEHICLE TYPE

EUROCARGO TECTOR

130E18 - 130E24 - 130E28 (2000)
150E21/E24/E28 - 320E28

ILLUSTRAZIONE / ILLUSTRATION

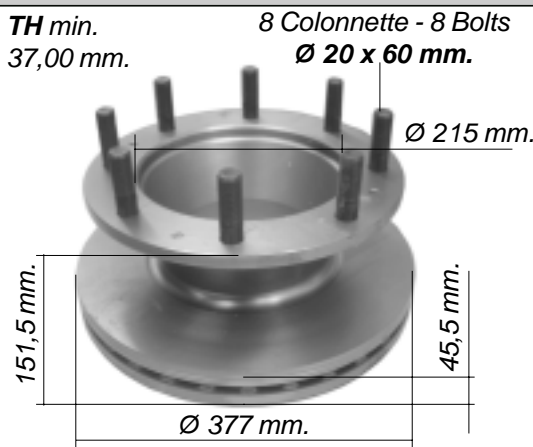

NOSTRO RIFERIMENTO OUR REFERENCE

960104

RIFERIMENTO COSTRUTTORE O.E. REFERENCE

2992271

DESCRIZIONE / DESCRIPTION

Serie dischi freno assale anteriore
Set of brake discs front axle

Fascia AUTOVENTILANTE
SELF-VENTILATED Band



ILLUSTRAZIONE / ILLUSTRATION



NOSTRO RIFERIMENTO OUR REFERENCE

960970

RIFERIMENTO COSTRUTTORE O.E. REFERENCE

2992336

DESCRIZIONE / DESCRIPTION

Serie pastiglie freno anteriore e posteriore
Set of brake pads front and rear

WVA	Larghezza Width - mm.	Altezza Height - mm.	Spessore Thickness - mm.
29095	211	92.5	30



ILLUSTRAZIONE / ILLUSTRATION

Connettore ovale - Lungh. mm. 150
Oval connector - Length mm. 150

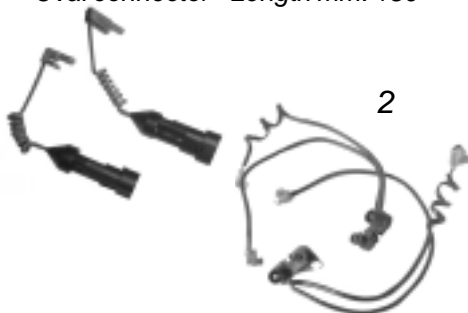

Connettore Klips - Lungh. mm. 270
Klips connector - Length mm. 270

NOSTRO RIFERIMENTO OUR REFERENCE

960878

960821

RIFERIMENTO COSTRUTTORE O.E. REFERENCE

1908231 (1)

42537941 (2)

DESCRIZIONE / DESCRIPTION

Kit segnalatori usura freno anteriore (2 pz.)
Set of brake wear indicators front (2 pcs)

Kit segnalatori usura freno anteriore (2 pz.)
Set of brake wear indicators front (2 pcs)

TIPO DI VEICOLO / VEHICLE TYPE

EUROCARGO TECTOR

150E18 - 150E24 - 150E28

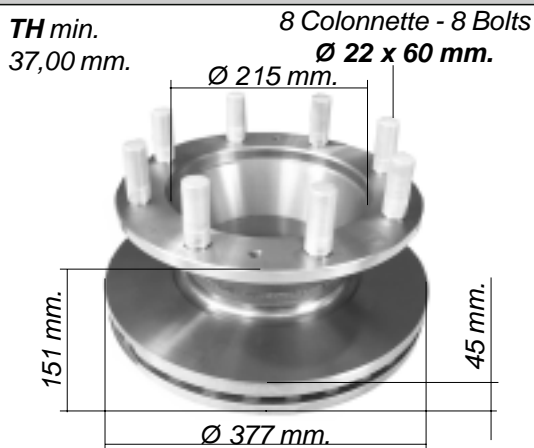
ILLUSTRAZIONE / ILLUSTRATION**NOSTRO RIFERIMENTO
OUR REFERENCE****960020****RIFERIMENTO COSTRUTTORE
O.E. REFERENCE**

2992291

DESCRIZIONE / DESCRIPTIONSerie dischi freno assale anteriore
Set of brake discs front axleFascia AUTOVENTILANTE
SELF-VENTILATED Band**ILLUSTRAZIONE / ILLUSTRATION****NOSTRO RIFERIMENTO
OUR REFERENCE****960970****RIFERIMENTO COSTRUTTORE
O.E. REFERENCE**

2992336

DESCRIZIONE / DESCRIPTIONSerie pastiglie freno anteriore e posteriore
Set of brake pads front and rear

WVA	Larghezza Width - mm.	Altezza Height - mm.	Spessore Thickness - mm.
29095	211	92.5	30

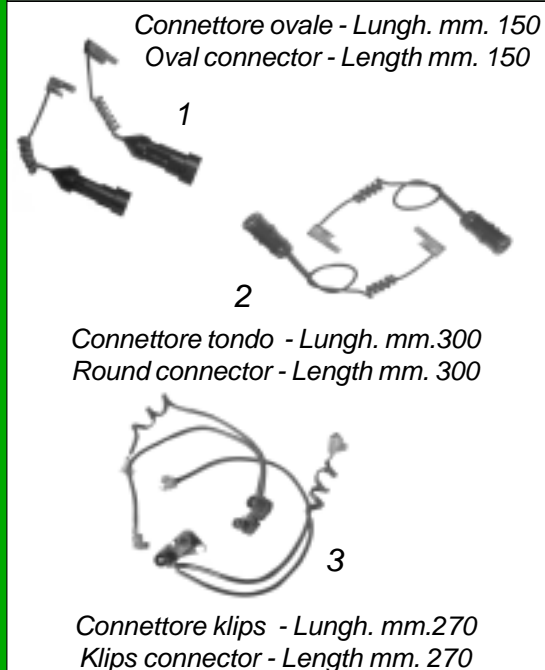
**ILLUSTRAZIONE / ILLUSTRATION****NOSTRO RIFERIMENTO
OUR REFERENCE****960878****RIFERIMENTO COSTRUTTORE
O.E. REFERENCE**

1908231 (1)

960880

1907956 (2)

960821

42537941 (3)

DESCRIZIONE / DESCRIPTIONKit segnalatori usura freno anteriore (2 pz.)
Set of brake wear indicators front (2 pcs)Kit segnalatori usura freno anteriore (2 pz.)
Set of brake wear indicators front (2 pcs)Kit segnalatori usura freno anteriore (2 pz.)
Set of brake wear indicators front (2 pcs)

TIPO DI VEICOLO / VEHICLE TYPE

EUROCARGO TECTOR

130E15/E18/E24/E28

150E15/E18/E24/E28

(da 07/2005 - from 07/2005)

ILLUSTRAZIONE / ILLUSTRATION

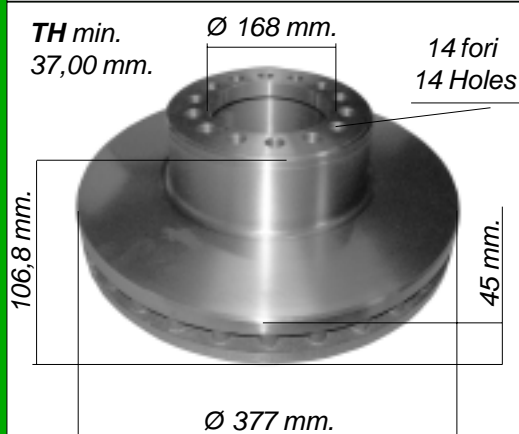

NOSTRO RIFERIMENTO OUR REFERENCE

960402

RIFERIMENTO COSTRUTTORE O.E. REFERENCE

2995894

DESCRIZIONE / DESCRIPTION

Serie dischi freno assale anteriore
Set of brake discs front axle

Fascia AUTOVENTILANTE
SELF-VENTILATED Band



ILLUSTRAZIONE / ILLUSTRATION



NOSTRO RIFERIMENTO OUR REFERENCE

960970

RIFERIMENTO COSTRUTTORE O.E. REFERENCE

2992336

DESCRIZIONE / DESCRIPTION

Serie pastiglie freno assale posteriore
Set of brake pads rear axle

WVA	Larghezza Width - mm.	Altezza Height - mm.	Spessore Thickness - mm.
29095	211	92.5	30



ILLUSTRAZIONE / ILLUSTRATION

Connettore ovale - Lungh. mm. 150
Oval connector - Length mm. 150



Connettore Klips - Lungh. mm. 270
Klips connector - Length mm. 270

NOSTRO RIFERIMENTO OUR REFERENCE

960878

960821

RIFERIMENTO COSTRUTTORE O.E. REFERENCE

1908231 (1)

42537941 (2)

DESCRIZIONE / DESCRIPTION

Kit segnalatori usura freno anteriore (2 pz.)
Set of brake wear indicators front (2 pcs)

Kit segnalatori usura freno anteriore (2 pz.)
Set of brake wear indicators front (2 pcs)

TIPO DI VEICOLO / VEHICLE TYPE

EUROCARGO TECTOR
TECTOR RESTYLING
130E18-130E21-130E24-130E28

ILLUSTRAZIONE / ILLUSTRATION

NOSTRO RIFERIMENTO
OUR REFERENCERIFERIMENTO COSTRUTTORE
O.E. REFERENCETH min.
37,00 mm. \varnothing 225 mm. 8 Colonnette - 8 Bolts
 \varnothing 20 x 72,5 mm.**960506**

2992635

DESCRIZIONE / DESCRIPTION

Serie dischi freno assale posteriore
Set of brake discs rear axleFascia AUTOVENTILANTE
SELF-VENTILATED Band

ILLUSTRAZIONE / ILLUSTRATION

NOSTRO RIFERIMENTO
OUR REFERENCERIFERIMENTO COSTRUTTORE
O.E. REFERENCE**960970**

2992336

DESCRIZIONE / DESCRIPTION

Serie pastiglie freno assale posteriore
Set of brake pads rear axle

WVA	Larghezza Width - mm.	Altezza Height - mm.	Spessore Thickness - mm.
29095	211	92.5	30



ILLUSTRAZIONE / ILLUSTRATION

NOSTRO RIFERIMENTO
OUR REFERENCERIFERIMENTO COSTRUTTORE
O.E. REFERENCEConnettore Klips - Lungh. mm.270
Klips connector - Length mm. 270**960839**

2992666

960821

42537941

DESCRIZIONE / DESCRIPTION

Segnalatori usura freno (2 pz.)
Brake wear indicators (2 pcs)

TIPO DI VEICOLO / VEHICLE TYPE

EUROCARGO TECTOR
TECTOR RESTYLING
150E18-150E24-150E28

ILLUSTRAZIONE / ILLUSTRATION



NOSTRO RIFERIMENTO OUR REFERENCE

960507

RIFERIMENTO COSTRUTTORE O.E. REFERENCE

2992636

DESCRIZIONE / DESCRIPTION

Serie dischi freno assale posteriore
Set of brake discs rear axle

Fascia AUTOVENTILANTE
SELF-VENTILATED Band



ILLUSTRAZIONE / ILLUSTRATION



NOSTRO RIFERIMENTO OUR REFERENCE

960970

RIFERIMENTO COSTRUTTORE O.E. REFERENCE

2992336

DESCRIZIONE / DESCRIPTION

Serie pastiglie freno anteriore e posteriore
Set of brake pads front and rear

WVA	Larghezza Width - mm.	Altezza Height - mm.	Spessore Thickness - mm.
29095	211	92.5	30



ILLUSTRAZIONE / ILLUSTRATION

Connettore Klips - Lungh. mm.270
Klips connector - Length mm. 270



NOSTRO RIFERIMENTO OUR REFERENCE

960839
960821

RIFERIMENTO COSTRUTTORE O.E. REFERENCE

2992666

42537941

DESCRIZIONE / DESCRIPTION

Segnalatori usura freno (2 pz.)
Brake wear indicator (2 pcs)

TIPO DI VEICOLO / VEHICLE TYPE

EUROCARGO 170E15/E18/E23/E27**EUROTECH** 180E24/E27/E30/E34/E38/E42 - 190E24E27E30/E34/E38/E42

240E34/E38/E42 - 260E38/E42 - 325E27 - 400E30/E34/E38/E42 - 440E34/E38/E42

EUROSTAR 190E38/E42/E47/E52 - 240E38/E42/E47/E52

260E42/E47/E52 - 400E38/E42/E47/E52 - 440E38/E42/E47/E52

(impianto BENDIX - BENDIX system)

(impianto KNORR - KNORR system)

ILLUSTRAZIONE / ILLUSTRATION

TH min.
46,00 mm.

12 Pezzi - 12 Pieces

12 Fori - 12 Holes

NOSTRO RIFERIMENTO
OUR REFERENCE**960033**RIFERIMENTO COSTRUTTORE
O.E. REFERENCE

2991979

1908729

DESCRIZIONE / DESCRIPTION

Serie dischi freno assale anteriore **con colonnette**
Set of brake discs front axle **with bolts**Fascia AUTOVENTILANTE
SELF-VENTILATED BandNOSTRO RIFERIMENTO
OUR REFERENCE**960034**RIFERIMENTO COSTRUTTORE
O.E. REFERENCE

2991979.0001

DESCRIZIONE / DESCRIPTION

Disco freno assale anteriore **senza colonnette**
Brake disc front axle **without bolts**Fascia AUTOVENTILANTE
SELF-VENTILATED Band

ILLUSTRAZIONE / ILLUSTRATION

**E3** 90RNOSTRO RIFERIMENTO
OUR REFERENCE**960937**RIFERIMENTO COSTRUTTORE
O.E. REFERENCE

2992479

1906459 - 1906191

DESCRIZIONE / DESCRIPTION

Serie pastiglie freno anteriore
Set of brake pads front

WVA	Larghezza Width - mm.	Altezza Height - mm.	Spessore Thickness - mm.
29011	241	125	25



TIPO DI VEICOLO / VEHICLE TYPE

EUROCARGO 170E15/E18/E23/E27

EUROTECH 180E24/E27/E30/E34/E38/E42 - 190E24E27E30/E34/E38/E42
240E34/E38/E42 - 260E38/E42 - 325E27 - 400E30/E34/E38/E42 - 440E34/E38/E42

EUROSTAR 190E38/E42/E47/E52 - 240E38/E42/E47/E52
260E42/E47/E52 - 400E38/E42/E47/E52 - 440E38/E42/E47/E52
(impianto BENDIX - BENDIX system)
(impianto KNORR - KNORR system)

ILLUSTRAZIONE / ILLUSTRATION

Connettore ovale - Lungh. mm. 150
Oval Connector - Length mm. 150



NOSTRO RIFERIMENTO OUR REFERENCE

960878

RIFERIMENTO COSTRUTTORE O.E. REFERENCE

1908231

DESCRIZIONE / DESCRIPTION

Kit segnalatori usura freno anteriore (2 pz.)
Set of brake wear indicators front (2 pcs)

ILLUSTRAZIONE / ILLUSTRATION

Connettore tondo - Lungh. mm. 300
Round connector - Length mm. 300



NOSTRO RIFERIMENTO OUR REFERENCE

960880

RIFERIMENTO COSTRUTTORE O.E. REFERENCE

1907956

DESCRIZIONE / DESCRIPTION

Kit segnalatori usura freno anteriore (2 pz.)
Set of brake wear indicators front (2 pcs)

ILLUSTRAZIONE / ILLUSTRATION

Connettore Klips - Klips connector
2 - Lunghezza / Length mm. 1300
2 - Lunghezza / Length mm. 270



NOSTRO RIFERIMENTO OUR REFERENCE

960908

RIFERIMENTO COSTRUTTORE O.E. REFERENCE

1903651 (1)

960839

2992666 (2)

DESCRIZIONE / DESCRIPTION

Kit segnalatori usura freno anteriore e posteriore (4 pz.)
Set of brake wear indicators front and rear (4 pcs)

Kit segnalatori usura freno anteriore e posteriore (2 pz.)
Set of brake wear indicators front and rear (2 pcs)

Connettore Klips - Lungh. mm. 270
Klips connector - Length mm. 270

TIPO DI VEICOLO / VEHICLE TYPE

EUROCARGO 170E18/E23/E27
EUROTRAKKER CURSOR 260E38/E44 - 340E38/E44 - 380E38/E44 - 410E38/E44
EUROSTAR CURSOR 440E39/E43/E46/E48
EUROTECH CURSOR 440E39/E43
STRALIS
 (impianto KNORR SB7 - KNORR SB7 system)





ILLUSTRAZIONE / ILLUSTRATION	NOSTRO RIFERIMENTO OUR REFERENCE	RIFERIMENTO COSTRUTTORE O.E. REFERENCE
<p>TH min. 37,00 mm.</p> 	960053	1906461 1906438
DESCRIZIONE / DESCRIPTION		
<p>Serie dischi freno assale anteriore/posteriore Set of brake discs front/rear axle</p> <p>Fascia AUTOVENTILANTE SELF-VENTILATED Band</p> 		

ILLUSTRAZIONE / ILLUSTRATION	NOSTRO RIFERIMENTO OUR REFERENCE	RIFERIMENTO COSTRUTTORE O.E. REFERENCE																				
 <p>E3 90R</p>	960944	1906439																				
DESCRIZIONE / DESCRIPTION																						
<p>Serie pastiglie freno anteriore e posteriore completa di molle, kit accessori SENZA piastre Set of brake pads front and rear with springs, kit accessories without plates</p> <p style="text-align: right;">BREVETTO PENDENTE PENDING PATENT</p> <table border="1" data-bbox="651 1966 1236 2145"> <thead> <tr> <th>WVA</th> <th>Larghezza Width - mm.</th> <th>Altezza Height - mm.</th> <th>Spessore Thickness - mm.</th> </tr> </thead> <tbody> <tr> <td>29087</td> <td>247,2</td> <td>109,7</td> <td>30</td> </tr> <tr> <td>29105</td> <td></td> <td></td> <td></td> </tr> <tr> <td>29108</td> <td></td> <td></td> <td></td> </tr> <tr> <td>29059</td> <td></td> <td></td> <td></td> </tr> </tbody> </table> 			WVA	Larghezza Width - mm.	Altezza Height - mm.	Spessore Thickness - mm.	29087	247,2	109,7	30	29105				29108				29059			
WVA	Larghezza Width - mm.	Altezza Height - mm.	Spessore Thickness - mm.																			
29087	247,2	109,7	30																			
29105																						
29108																						
29059																						

TIPO DI VEICOLO / VEHICLE TYPE

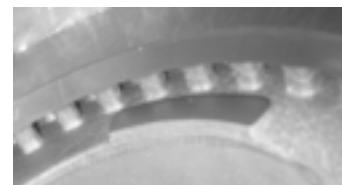
EUROCARGO 170E18/E23/E27
EUROTRAKKER CURSOR 260E38/E44 - 340E38/E44 - 380E38/E44 - 410E38/E44
EUROSTAR CURSOR 440E39/E43/E46/E48
EUROTECH CURSOR 440E39/E43
STRALIS
 (impianto KNORR SB7 - KNORR SB7 system)

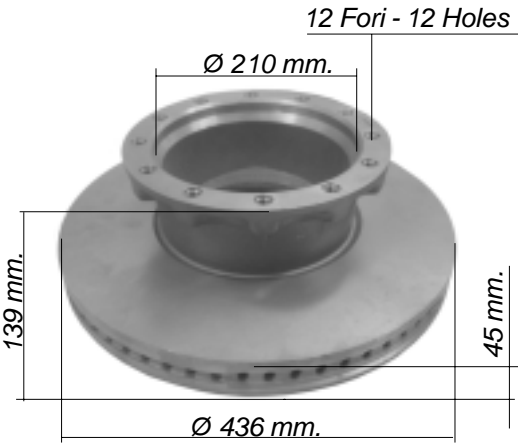
ILLUSTRAZIONE / ILLUSTRATION



E3 90R

NOSTRO RIFERIMENTO OUR REFERENCE

960944/C

RIFERIMENTO COSTRUTTORE O.E. REFERENCE

-

DESCRIZIONE / DESCRIPTION

Serie pastiglie freno anteriore e posteriore completa di molle, kit accessori e piastra
 Set of brake pads front and rear with springs, kit accessories and plates

**BREVETTO PENDENTE
PENDING PATENT**

WVA	Larghezza Width - mm.	Altezza Height - mm.	Spessore Thickness - mm.
29087	247,2	109,7	30
29105			
29108			
29059			
29061			



ILLUSTRAZIONE / ILLUSTRATION

Connettore Klips / Klips connector
 2 - Lunghezza / Length mm. 1300
 2 - Lunghezza / Length mm. 270

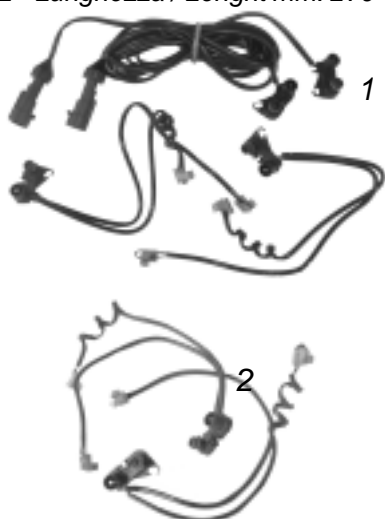

Connettore Klips - Lungh. mm. 270
 Klips connector - Length mm. 270

NOSTRO RIFERIMENTO OUR REFERENCE

960908

960839

RIFERIMENTO COSTRUTTORE O.E. REFERENCE

1903651 (1)

2992666 (2)

DESCRIZIONE / DESCRIPTION

Kit segnalatori usura freno anteriore e posteriore (4 pz.)
 Set of brake wear indicators front and rear (4 pcs)

Kit segnalatori usura freno anteriore e posteriore (2 pz.)
 Set of brake wear indicators front and rear (2 pcs)

TIPO DI VEICOLO / VEHICLE TYPE

STRALIS 190S31/S35/S40/S43/S48 - 260S31/S40/S43/S48/S54 - 440S35/S40/S43/S48/54
(impianto KNORR SB7 - KNORR SB7 system)

DISCO FRENO CON AGGIUNTA DI MOLIBDENO
BRAKE DISC WITH MOLIBDENO



ILLUSTRAZIONE / ILLUSTRATION

TH min.
37,00 mm.

NOSTRO RIFERIMENTO
OUR REFERENCE

960038

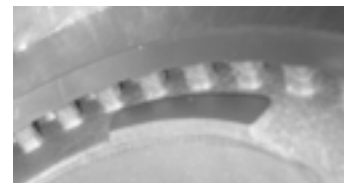
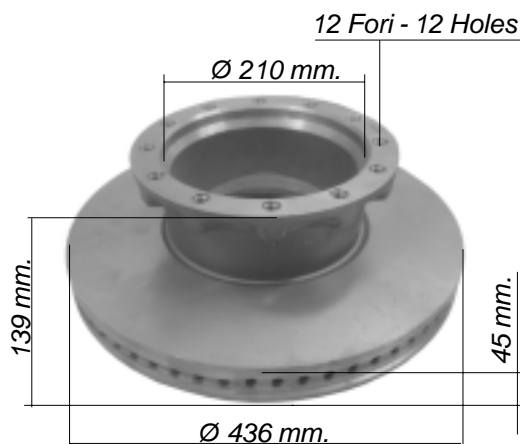
RIFERIMENTO COSTRUTTORE
O.E. REFERENCE

2992470

DESCRIZIONE / DESCRIPTION

Serie dischi freno assale anteriore/posteriore
Set of brake discs front/rear axle

Fascia AUTOVENTILANTE
SELF-VENTILATED Band



ILLUSTRAZIONE / ILLUSTRATION

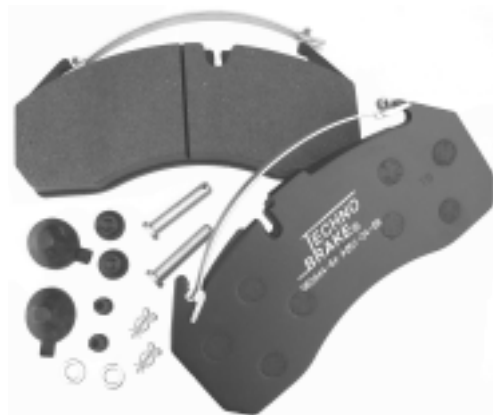

E3 90R

NOSTRO RIFERIMENTO
OUR REFERENCE

960944

RIFERIMENTO COSTRUTTORE
O.E. REFERENCE

1906439

DESCRIZIONE / DESCRIPTION

Serie pastiglie freno anteriore e posteriore completa di molle, kit accessori **SENZA** piastre
Set of brake pads front and rear with springs
kit accessories without plates

BREVETTO PENDENTE
PENDING PATENT

WVA	Larghezza Width - mm.	Altezza Height - mm.	Spessore Thickness - mm.
29087	247,2	109,7	30
29105			
29108			
29059			



TIPO DI VEICOLO / VEHICLE TYPE

STRALIS 190S31/S35/S40/S43/S48 - 260S31/S40/S43/S48/S54 - 440S35/S40/S43/S48/54
(impianto KNORR SB7 - KNORR SB7 system)

DISCO FRENO CON AGGIUNTA DI MOLIBDENO BRAKE DISC WITH MOLIBDENO

ILLUSTRAZIONE / ILLUSTRATION



E3 90R

NOSTRO RIFERIMENTO OUR REFERENCE

960944/C

RIFERIMENTO COSTRUTTORE O.E. REFERENCE

-

DESCRIZIONE / DESCRIPTION

Serie pastiglie freno anteriore e posteriore completa di molle, kit accessori e piastra
Set of brake pads front and rear with springs, kit accessories and plates

**BREVETTO PENDENTE
PENDING PATENT**

WVA	Larghezza Width - mm.	Altezza Height - mm.	Spessore Thickness - mm.
29087	247,2	109,7	30
29105			
29108			
29059			
29061			



ILLUSTRAZIONE / ILLUSTRATION

Connettore Klips - Klips connector
2 - Lunghezza / Length mm. 1300
2 - Lunghezza / Length mm. 270

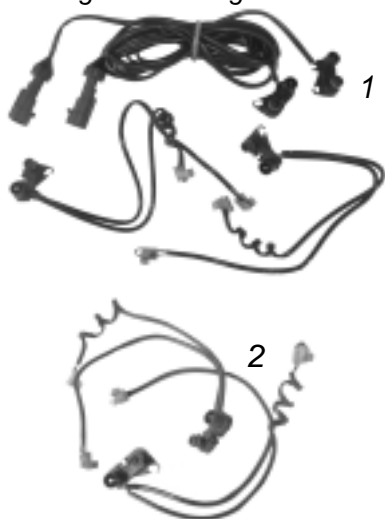

Connettore Klips - Lungh. mm. 270
Klips connector - Length mm. 270

NOSTRO RIFERIMENTO OUR REFERENCE

960908

960839

RIFERIMENTO COSTRUTTORE O.E. REFERENCE

1903651 (1)

2992666 (2)

DESCRIZIONE / DESCRIPTION

Kit segnalatori usura freno anteriore e posteriore (4 pz.)
Set of brake wear indicators front and rear (4 pcs)

Kit segnalatori usura freno anteriore e posteriore (2 pz.)
Set of brake wear indicators front and rear (2 pcs)

TIPO DI VEICOLO / VEHICLE TYPE

STRALIS

190S31/S35/S40/S43/S48 - 260S31/S40/S43/S48/S54

440S35/S40/S43/S48/54 (impianto KNORR SB7 - KNORR SB7 system)

EUROCARGO TECTOR 180 - 320 (dal 2000 - to 2000)

EUROTECH - EUROTRAKKER



ILLUSTRAZIONE / ILLUSTRATION

NOSTRO RIFERIMENTO
OUR REFERENCERIFERIMENTO COSTRUTTORE
O.E. REFERENCE**960019**

2992477

DESCRIZIONE / DESCRIPTION

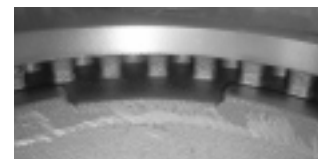
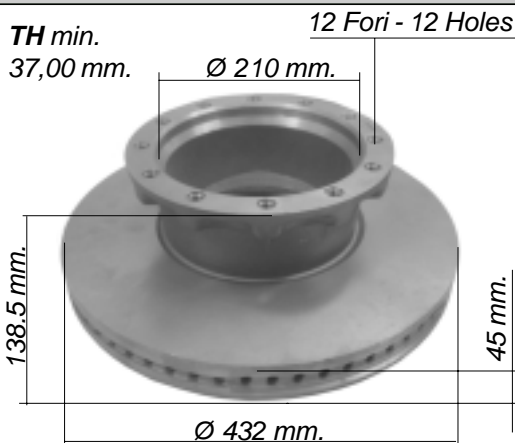
Serie dischi freno assale anteriore e posteriore
Set of brake discs front and rear axleFascia AUTOVENTILANTE
SELF-VENTILATED Band

ILLUSTRAZIONE / ILLUSTRATION

NOSTRO RIFERIMENTO
OUR REFERENCERIFERIMENTO COSTRUTTORE
O.E. REFERENCE**E3 90R****960971**2995637 - 2992476
2992348 - 2995819
2996378

DESCRIZIONE / DESCRIPTION

Serie pastiglie freno anteriore e posteriore
Set of brake pads front and rear**BREVETTO PENDENTE**
PENDING PATENT

WVA	Larghezza Width - mm.	Altezza Height - mm.	Spessore Thickness - mm.
29087	247.2	109.7	30
29105			
29108			
29061	29059		

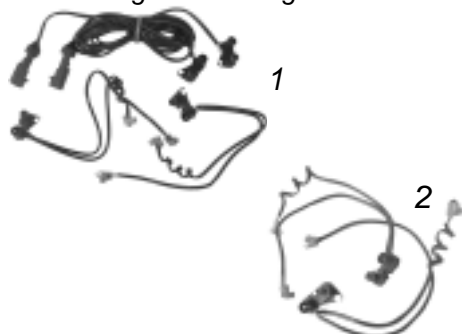

ILLUSTRAZIONE / ILLUSTRATION

NOSTRO RIFERIMENTO
OUR REFERENCERIFERIMENTO COSTRUTTORE
O.E. REFERENCEConnettore Klips / Klips connector
2 - Lunghezza / Length mm. 1300
2 - Lunghezza / Length mm. 270Connettore Klips - Lungh. mm. 270
Klips connector - Length mm. 270**960908**

1903651 (1)

960839

2992666 (2)

Kit segnalatori usura freno anteriore e posteriore (4 pz.)
Set of brake wear indicators front and rear (4 pcs)Kit segnalatori usura freno anteriore e posteriore (2 pz.)
Set of brake wear indicators front and rear (2 pcs)

TIPO DI VEICOLO / VEHICLE TYPE

STRALIS U.T.

**CON VENTILAZIONE
INTERNA MODIFICATA
WITH INTERNAL
VENTILATION MODIFIED**



ILLUSTRAZIONE / ILLUSTRATION



NOSTRO RIFERIMENTO OUR REFERENCE

960404

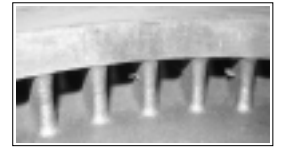
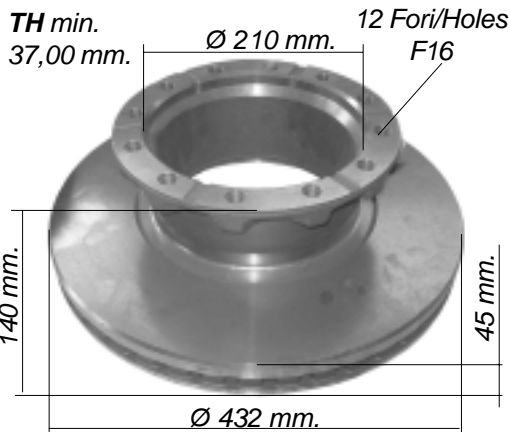
RIFERIMENTO COSTRUTTORE O.E. REFERENCE

2996327

DESCRIZIONE / DESCRIPTION

Serie dischi freno assale anteriore e posteriore
Set of brake discs front and rear axle

Fascia AUTOVENTILANTE
SELF-VENTILATED Band



ILLUSTRAZIONE / ILLUSTRATION



E3 90R

NOSTRO RIFERIMENTO OUR REFERENCE

960971

RIFERIMENTO COSTRUTTORE O.E. REFERENCE

2995637 - 2992476
2992348 - 2995819
2996378

DESCRIZIONE / DESCRIPTION

Serie pastiglie freno anteriore e posteriore
Set of brake pads front and rear

**BREVETTO PENDENTE
PATENT PENDING**

WVA	Larghezza Width - mm.	Altezza Height - mm.	Spessore Thickness - mm.
29087	247.2	109.7	30
29105			
29108			
29061	29059		



ILLUSTRAZIONE / ILLUSTRATION

Connettore Klips / Klips connector
2 - Lunghezza / Length mm. 1300
2 - Lunghezza / Length mm. 270

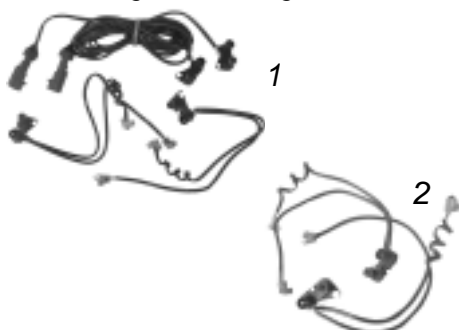

Connettore Klips - Lungh. mm. 270
Klips connector - Length mm. 270

NOSTRO RIFERIMENTO OUR REFERENCE

960908

RIFERIMENTO COSTRUTTORE O.E. REFERENCE

1903651 (1)

960839

2992666 (2)

Kit segnalatori usura freno anteriore e posteriore (4 pz.)
Set of brake wear indicators front and rear (4 pcs)

Kit segnalatori usura freno anteriore e posteriore (2 pz.)
Set of brake wear indicators front and rear (2 pcs)

TIPO DI VEICOLO / VEHICLE TYPE

STRALIS U.T.

CON ABS - WITH ABS**CON VENTILAZIONE
INTERNA MODIFICATA
WITH INTERNAL
VENTILATION MODIFIED**

ILLUSTRAZIONE / ILLUSTRATION

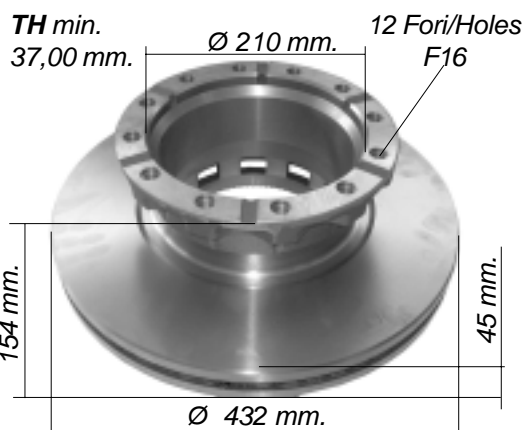
NOSTRO RIFERIMENTO
OUR REFERENCERIFERIMENTO COSTRUTTORE
O.E. REFERENCE**960405**2996328
2995812

DESCRIZIONE / DESCRIPTION

Serie dischi freno assale anteriore e posteriore
Set of brake discs front and rear axle**CON ABS - WITH ABS**Fascia
AUTOVENTILANTE

ILLUSTRAZIONE / ILLUSTRATION

NOSTRO RIFERIMENTO
OUR REFERENCERIFERIMENTO COSTRUTTORE
O.E. REFERENCE**E3 90R****960971**2995637 - 2992476
2992348 - 2995819
2996378

DESCRIZIONE / DESCRIPTION

Serie pastiglie freno anteriore e posteriore
Set of brake pads front and rear**BREVETTO PENDENTE
PENDING PATENT**

WVA	Larghezza Width - mm.	Altezza Height - mm.	Spessore Thickness - mm.
29087	247.2	109.7	30
29105			
29108			
29061			

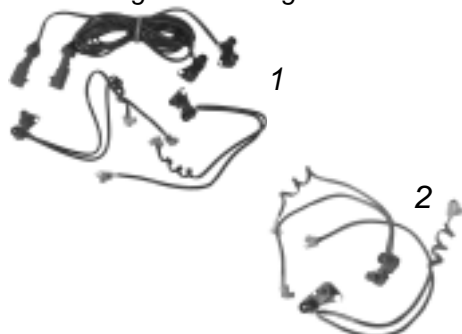

ILLUSTRAZIONE / ILLUSTRATION

NOSTRO RIFERIMENTO
OUR REFERENCERIFERIMENTO COSTRUTTORE
O.E. REFERENCEConnettore Klips / Klips connector
2 - Lunghezza / Length mm. 1300
2 - Lunghezza / Length mm. 270Connettore Klips - Lungh. mm. 270
Klips connector - Length mm. 270**960908**

1903651 (1)

960839

2992666 (2)

Kit segnalatori usura freno anteriore e posteriore (4 pz.)
Set of brake wear indicators front and rear (4 pcs)Kit segnalatori usura freno anteriore e posteriore (2 pz.)
Set of brake wear indicators front and rear (2 pcs)

TIPO DI VEICOLO / VEHICLE TYPE

STRALIS U.T.

**CON VENTILAZIONE
INTERNA MODIFICATA
WITH INTERNAL
VENTILATION MODIFIED**



ILLUSTRAZIONE / ILLUSTRATION



NOSTRO RIFERIMENTO OUR REFERENCE

960406

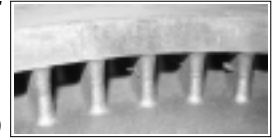
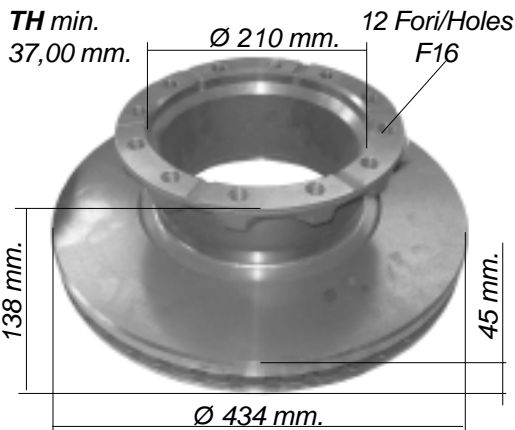
RIFERIMENTO COSTRUTTORE O.E. REFERENCE

2996329

DESCRIZIONE / DESCRIPTION

Serie dischi freno assale anteriore e posteriore
Set of brake discs front and rear axle

Fascia
AUTOVENTILANTE



ILLUSTRAZIONE / ILLUSTRATION



E3 90R

NOSTRO RIFERIMENTO OUR REFERENCE

960971

RIFERIMENTO COSTRUTTORE O.E. REFERENCE

2995637 - 2992476
2992348 - 2995819
2996378

DESCRIZIONE / DESCRIPTION

Serie pastiglie freno anteriore e posteriore
Set of brake pads front and rear

**BREVETTO PENDENTE
PENDING PATENT**

WVA	Larghezza Width - mm.	Altezza Height - mm.	Spessore Thickness - mm.
29087	247.2	109.7	30
29105			
29108			
29061	29059		



ILLUSTRAZIONE / ILLUSTRATION

Connettore Klips / Klips connector
2 - Lunghezza / Length mm. 1300
2 - Lunghezza / Length mm. 270

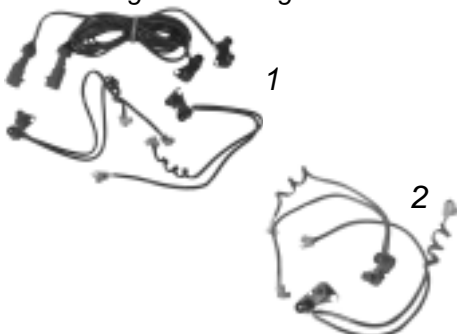

Connettore Klips - Lungh. mm. 270
Klips connector - Length mm. 270

NOSTRO RIFERIMENTO OUR REFERENCE

960908

RIFERIMENTO COSTRUTTORE O.E. REFERENCE

1903651 (1)

960839

2992666 (2)

Kit segnalatori usura freno anteriore e posteriore (4 pz.)
Set of brake wear indicators front and rear (4 pcs)

Kit segnalatori usura freno anteriore e posteriore (2 pz.)
Set of brake wear indicators front and rear (2 pcs)

TIPO DI VEICOLO / VEHICLE TYPE

EUROCARGO (impianto PERROT - PERROT system)120E15/E18/E23 - 130E15/E18/E23
150E15/E18/E23/E27 - 170E15/E18/E23
260E23 - 280E23 - 320E27
EUROCARGO BUS

ILLUSTRAZIONE / ILLUSTRATION

Connettore ovale - Lungh. mm. 570
Oval connector - Length mm. 570NOSTRO RIFERIMENTO
OUR REFERENCE**960886**RIFERIMENTO COSTRUTTORE
O.E. REFERENCE

42532204

DESCRIZIONE / DESCRIPTION

Segnalatore usura freno posteriore
Brake wear indicator rear

TIPO DI VEICOLO / VEHICLE TYPE

EUROCARGO

135E18/E23 - 150E21/E23 - 170E18/E23/E27

EUROTECH

180E24/E27/E30/E34 - 190E24/E27/E30 - 400E30/E34

ILLUSTRAZIONE / ILLUSTRATION

Connettore ovale - Lungh. mm. 955
Oval connector - Length mm. 955NOSTRO RIFERIMENTO
OUR REFERENCE**960887**RIFERIMENTO COSTRUTTORE
O.E. REFERENCE42539438
93193778

DESCRIZIONE / DESCRIPTION

Segnalatore usura freno posteriore
Brake wear indicator rear

TIPO DI VEICOLO / VEHICLE TYPE

EUROCARGO
EUROTECH - EUROSTAR - EUROTRAKKER
EUROTECH CURSOR - EUROTRAKKER CURSOR

(impianto PERROT - PERROT system)

ILLUSTRAZIONE / ILLUSTRATION

Connettore ovale - Lungh.mm. 1320
 Oval connector - Length mm. 1320

NOSTRO RIFERIMENTO
OUR REFERENCE**960905**RIFERIMENTO COSTRUTTORE
O.E. REFERENCE

42530550

DESCRIZIONE / DESCRIPTION

Segnalatore usura freno posteriore
 Brake wear indicator rear

TIPO DI VEICOLO / VEHICLE TYPE

EUROCARGO - EUROCARGO TECTOR
EUROTECH - EUROSTAR - EUROTRAKKER
BUS 370SE 27 - SE29 - SE35
 330.30

ILLUSTRAZIONE / ILLUSTRATION

NOSTRO RIFERIMENTO
OUR REFERENCE**960907**RIFERIMENTO COSTRUTTORE
O.E. REFERENCE

42530551

DESCRIZIONE / DESCRIPTION

Boccolina per indicatore usura freno
 Bush for brake wear indicator

TIPO DI VEICOLO / VEHICLE TYPE

MAN L 2000 - L 2100

ILLUSTRAZIONE / ILLUSTRATION

NOSTRO RIFERIMENTO
OUR REFERENCERIFERIMENTO COSTRUTTORE
O.E. REFERENCE**960320**81508030010
81508030001

DESCRIZIONE / DESCRIPTION

Disco freno assale anteriore
Brake disc front axleFascia AUTOVENTILANTE
SELF-VENTILATED Band

ILLUSTRAZIONE / ILLUSTRATION

NOSTRO RIFERIMENTO
OUR REFERENCERIFERIMENTO COSTRUTTORE
O.E. REFERENCE**960969**81508206020
81508205029

DESCRIZIONE / DESCRIPTION

Serie pastiglie freno ant./post. - Set of brake pads front and rear

WVA	Larghezza Width - mm.	Altezza Height - mm.	Spessore Thickness - mm.
29088	175.5	85.6	26



ILLUSTRAZIONE / ILLUSTRATION

NOSTRO RIFERIMENTO
OUR REFERENCERIFERIMENTO COSTRUTTORE
O.E. REFERENCE**960955**

81508206011

DESCRIZIONE / DESCRIPTION

Serie pastiglie freno ant./post. - Set of brake pads front and rear

WVA	Larghezza Width - mm.	Altezza Height - mm.	Spessore Thickness - mm.
29055	175,8	82,5	22



TIPO DI VEICOLO / VEHICLE TYPE

MAN L 2000 - L 2100

ILLUSTRAZIONE / ILLUSTRATION



Connettore tondo - Lungh. mm. 295
Round connector - Length mm. 295

NOSTRO RIFERIMENTO OUR REFERENCE

960803

RIFERIMENTO COSTRUTTORE O.E. REFERENCE

81508226014

DESCRIZIONE / DESCRIPTION

Kit segnalatori usura freno anteriore e posteriore
con supporti (2 pz.)
Set of brake wear indicators front and rear
with supports (2 pcs)

ILLUSTRAZIONE / ILLUSTRATION



Connettore ovale - Lungh. mm. 320
Oval connector - Length mm. 320

NOSTRO RIFERIMENTO OUR REFERENCE

960553

RIFERIMENTO COSTRUTTORE O.E. REFERENCE

81508226015

DESCRIZIONE / DESCRIPTION

Kit segnalatori usura freno anteriore e posteriore
senza supporti (2 pz.)
Set of brake wear indicators front and rear
without supports (2 pcs)

ILLUSTRAZIONE / ILLUSTRATION

NOSTRO RIFERIMENTO OUR REFERENCE

RIFERIMENTO COSTRUTTORE O.E. REFERENCE

DESCRIZIONE / DESCRIPTION



TIPO DI VEICOLO / VEHICLE TYPE

MAN L 2000 8.150 - 8.153 - 8.220 - 8.223
9.223
10.150 - 10.153 - 10.220 - 10.223

ILLUSTRAZIONE / ILLUSTRATION	NOSTRO RIFERIMENTO OUR REFERENCE	RIFERIMENTO COSTRUTTORE O.E. REFERENCE								
<p>TH min. 30,00 mm.</p> <p>10 Fori - 10 Holes Ø 135 mm.</p>  <p>104 mm.</p> <p>34 mm.</p> <p>Ø 330 mm.</p>	960328	81508030026								
DESCRIZIONE / DESCRIPTION										
<p>Disco freno assale anteriore Brake disc front axle</p> <p>Fascia AUTOVENTILANTE SELF-VENTILATED Band</p> 										
ILLUSTRAZIONE / ILLUSTRATION	NOSTRO RIFERIMENTO OUR REFERENCE	RIFERIMENTO COSTRUTTORE O.E. REFERENCE								
 <p>TECHNO BRAKE</p> <p>E3 90R</p>	960969	81508206020 81508205029								
DESCRIZIONE / DESCRIPTION										
<p>Serie pastiglie freno ant./post. - Set of brake pads front and rear</p> <table border="1"> <thead> <tr> <th>WVA</th> <th>Larghezza Width - mm.</th> <th>Altezza Height - mm.</th> <th>Spessore Thickness - mm.</th> </tr> </thead> <tbody> <tr> <td>29088</td> <td>175.5</td> <td>85.6</td> <td>26</td> </tr> </tbody> </table> 			WVA	Larghezza Width - mm.	Altezza Height - mm.	Spessore Thickness - mm.	29088	175.5	85.6	26
WVA	Larghezza Width - mm.	Altezza Height - mm.	Spessore Thickness - mm.							
29088	175.5	85.6	26							
ILLUSTRAZIONE / ILLUSTRATION	NOSTRO RIFERIMENTO OUR REFERENCE	RIFERIMENTO COSTRUTTORE O.E. REFERENCE								
 <p>TECHNO BRAKE</p> <p>E3 90R</p>	960955	81508206011								
DESCRIZIONE / DESCRIPTION										
<p>Serie pastiglie freno ant./post. - Set of brake pads front and rear</p> <table border="1"> <thead> <tr> <th>WVA</th> <th>Larghezza Width - mm.</th> <th>Altezza Height - mm.</th> <th>Spessore Thickness - mm.</th> </tr> </thead> <tbody> <tr> <td>29055</td> <td>175,8</td> <td>82,5</td> <td>22</td> </tr> </tbody> </table> 			WVA	Larghezza Width - mm.	Altezza Height - mm.	Spessore Thickness - mm.	29055	175,8	82,5	22
WVA	Larghezza Width - mm.	Altezza Height - mm.	Spessore Thickness - mm.							
29055	175,8	82,5	22							

TIPO DI VEICOLO / VEHICLE TYPE

MAN L 2000 8.150 - 8.153 - 8.220 - 8.223
9.223
10.150 - 10.153 - 10.220 - 10.223

ILLUSTRAZIONE / ILLUSTRATION	NOSTRO RIFERIMENTO OUR REFERENCE	RIFERIMENTO COSTRUTTORE O.E. REFERENCE
 <p>Connettore tondo - Lungh.mm. 295 Round connector - Length mm. 295</p>	<h3>960803</h3>	<p>81508226014</p>
DESCRIZIONE / DESCRIPTION		
<p><i>Kit segnalatori usura freno anteriore e posteriore con supporti (2 pz.) Set of brake wear indicators front and rear with supports (2 pcs)</i></p>		
ILLUSTRAZIONE / ILLUSTRATION	NOSTRO RIFERIMENTO OUR REFERENCE	RIFERIMENTO COSTRUTTORE O.E. REFERENCE
 <p>Connettore ovale - Lungh.mm. 320 Oval connector - Length mm. 320</p>	<h3>960553</h3>	<p>81508226015</p>
DESCRIZIONE / DESCRIPTION		
<p><i>Kit segnalatori usura freno anteriore e posteriore senza supporti (2 pz.) Set of brake wear indicators front and rear without supports (2 pcs)</i></p>		
ILLUSTRAZIONE / ILLUSTRATION	NOSTRO RIFERIMENTO OUR REFERENCE	RIFERIMENTO COSTRUTTORE O.E. REFERENCE
DESCRIZIONE / DESCRIPTION		

TIPO DI VEICOLO / VEHICLE TYPE

MAN
L 2000

Assale anteriore - Front axle Ns Rif. 960328

CON ABS - WITH ABS)

ILLUSTRAZIONE / ILLUSTRATION

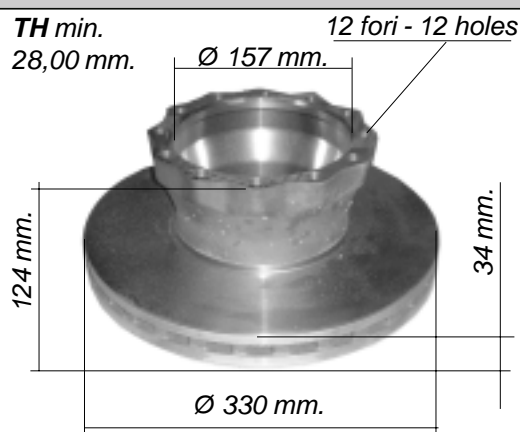
NOSTRO RIFERIMENTO
OUR REFERENCE**960343**RIFERIMENTO COSTRUTTORE
O.E. REFERENCE81508030061
81508030022

DESCRIZIONE / DESCRIPTION

Disco freno assale posteriore
Brake disc rear axleFascia AUTOVENTILANTE
SELF-VENTILATED Band

ILLUSTRAZIONE / ILLUSTRATION

NOSTRO RIFERIMENTO
OUR REFERENCE**960969**RIFERIMENTO COSTRUTTORE
O.E. REFERENCE81508206020
81508205029

DESCRIZIONE / DESCRIPTION

Serie pastiglie freno ant./post. - Set of brake pads front and rear

WVA	Larghezza Width - mm.	Altezza Height - mm.	Spessore Thickness - mm.
29088	175.5	85.6	26



ILLUSTRAZIONE / ILLUSTRATION

NOSTRO RIFERIMENTO
OUR REFERENCE**960955**RIFERIMENTO COSTRUTTORE
O.E. REFERENCE

81508206011

DESCRIZIONE / DESCRIPTION

Serie pastiglie freno ant./post. - Set of brake pads front and rear

WVA	Larghezza Width - mm.	Altezza Height - mm.	Spessore Thickness - mm.
29055	175,8	82,5	22



TIPO DI VEICOLO / VEHICLE TYPE

MAN
L 2000

Assale anteriore - Front axle Ns Rif. 960328

CON ABS - WITH ABS

ILLUSTRAZIONE / ILLUSTRATION

NOSTRO RIFERIMENTO
OUR REFERENCE

RIFERIMENTO COSTRUTTORE
O.E. REFERENCE



Connettore tondo - Lungh.mm. 295
Round connector - Length mm. 295

960803

81508226014

DESCRIZIONE / DESCRIPTION

Kit segnalatori usura freno anteriore e posteriore
con supporti (2 pz.)
Set of brake wear indicators front and rear
with supports (2 pcs)

ILLUSTRAZIONE / ILLUSTRATION

NOSTRO RIFERIMENTO
OUR REFERENCE

RIFERIMENTO COSTRUTTORE
O.E. REFERENCE



Connettore ovale - Lungh.mm. 320
Oval connector - Length mm. 320

960553

81508226015

DESCRIZIONE / DESCRIPTION

Kit segnalatori usura freno anteriore e posteriore
senza supporti (2 pz.)
Set of brake wear indicators front and rear
without supports (2 pcs)

ILLUSTRAZIONE / ILLUSTRATION

NOSTRO RIFERIMENTO
OUR REFERENCE

RIFERIMENTO COSTRUTTORE
O.E. REFERENCE

DESCRIZIONE / DESCRIPTION

TIPO DI VEICOLO / VEHICLE TYPE

MAN - L 2000

8.103-8.113-8.145-8.150-8.153-8.163-8.185-8.220-8.223-8.224-8.225

9.145-9.153-9.163-9.185-9.223-9.224

10.145-10.150-10.153-10.163-10.185-10.220-10.223-10.224-10.225 - 12.185-12.225

ILLUSTRAZIONE / ILLUSTRATION

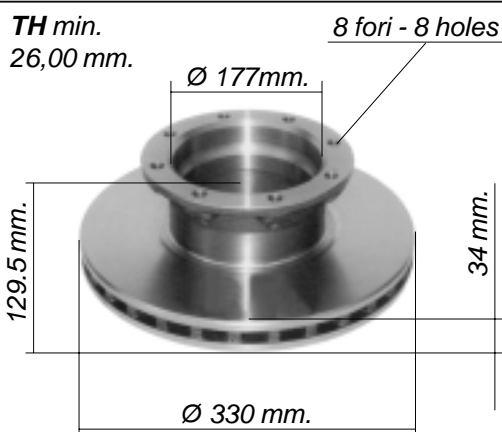
NOSTRO RIFERIMENTO
OUR REFERENCERIFERIMENTO COSTRUTTORE
O.E. REFERENCE**960345**

81508030039

DESCRIZIONE / DESCRIPTION

Disco freno assale posteriore
Brake disc rear axleFascia AUTOVENTILANTE
SELF-VENTILATED Band

ILLUSTRAZIONE / ILLUSTRATION

NOSTRO RIFERIMENTO
OUR REFERENCERIFERIMENTO COSTRUTTORE
O.E. REFERENCE**960969**81508206020
81508205029

DESCRIZIONE / DESCRIPTION

Serie pastiglie freno ant./post. - Set of brake pads front and rear

WVA	Larghezza Width - mm.	Altezza Height - mm.	Spessore Thickness - mm.
29088	175.5	85.6	26



ILLUSTRAZIONE / ILLUSTRATION

NOSTRO RIFERIMENTO
OUR REFERENCERIFERIMENTO COSTRUTTORE
O.E. REFERENCE**960955**

81508206011

DESCRIZIONE / DESCRIPTION

Serie pastiglie freno ant./post. - Set of brake pads front and rear

WVA	Larghezza Width - mm.	Altezza Height - mm.	Spessore Thickness - mm.
29055	175,8	82,5	22



TIPO DI VEICOLO / VEHICLE TYPE

MAN - L 2000

8.103-8.113-8.145-8.150-8.153-8.163-8.185-8.220-8.223-8.224-8.225



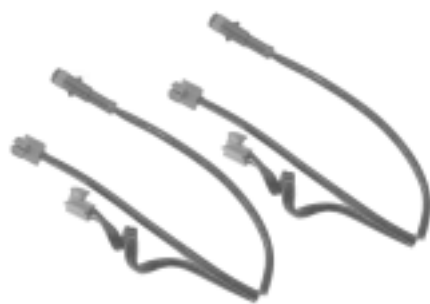
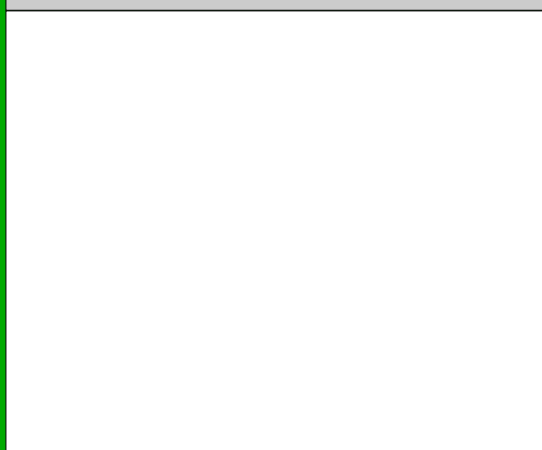

9.145-9.153-9.163-9.185-9.223-9.224

10.145-10.150-10.153-10.163-10.185-10.220-10.223-10.224-10.225 - 12.185-12.225

ILLUSTRAZIONE / ILLUSTRATION	NOSTRO RIFERIMENTO OUR REFERENCE	RIFERIMENTO COSTRUTTORE O.E. REFERENCE
 <p>Connettore tondo - Lungh.mm. 295 Round connector - Length mm. 295</p>	<p>960803</p>	<p>81508226014</p>
 <p>Connettore ovale - Lungh.mm. 320 Oval connector - Length mm. 320</p>	<p>960553</p>	<p>81508226015</p>
		

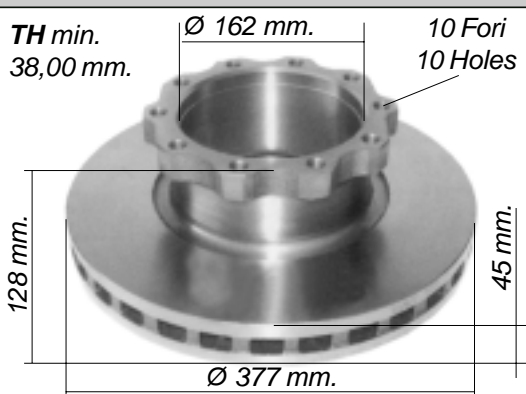
TIPO DI VEICOLO / VEHICLE TYPE

MAN M 2000
(Impianto KNORR SB6000 - KNORR SB6000 system)

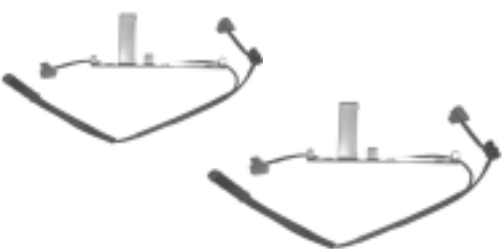
ILLUSTRAZIONE / ILLUSTRATION	NOSTRO RIFERIMENTO OUR REFERENCE	RIFERIMENTO COSTRUTTORE O.E. REFERENCE							
	960329	81508030057 81508030027							
		DESCRIZIONE / DESCRIPTION Disco freno assale anteriore Brake disc front axle Fascia AUTOVENTILANTE SELF-VENTILATED Band 							
	960948	81508206022							
		DESCRIZIONE / DESCRIPTION Serie pastiglie freno anteriore completa di molle, kit accessori SENZA piastre Set of brake pads front with springs kit accessories withot plates							
		960948/C	-						
Serie pastiglie freno anteriore completa di molle, kit accessori e piastre Set of brake pads front with springs, kit accessories and plates <table border="1" data-bbox="646 1579 1236 1713"> <thead> <tr> <th>WVA</th> <th>Larghezza Width - mm.</th> <th>Altezza Height - mm.</th> <th>Spessore Tickness - mm.</th> </tr> </thead> <tbody> <tr> <td>29095</td> <td>211</td> <td>92.5</td> <td>30</td> </tr> </tbody> </table> 			WVA	Larghezza Width - mm.	Altezza Height - mm.	Spessore Tickness - mm.	29095	211	92.5
WVA	Larghezza Width - mm.	Altezza Height - mm.	Spessore Tickness - mm.						
29095	211	92.5	30						
ILLUSTRAZIONE / ILLUSTRATION Connettore tondo - Lungh. mm. 338 Round connector - Length mm. 338 	960811	81508226016 81508226011 81508226017							
		DESCRIZIONE / DESCRIPTION Kit segnalatori usura freno anteriore (2 pz.) Set of brake wear indicators front (2 pcs)							

TIPO DI VEICOLO / VEHICLE TYPE

MAN F 90	19.242/262/272/292/322/332/342/362/372/402/422/462/502 24.242/262/272/292/302/322/332/342/362/402/422/462/502 25.272/302/322/372/422/502 - 26.242/262/272/292/302/322/332/342
MAN F 2000	19.273/293/343/403/463 - 26.273/293/323/343/373/403 26.423/463/603 - 27.273/293/323/343/373/403/423/603 33.323/343/373/403/423/463/603
MAN BUS	422 FRH LIONS STAR
MAN M 2000 -TGA	

ILLUSTRAZIONE / ILLUSTRATION	NOSTRO RIFERIMENTO OUR REFERENCE	RIFERIMENTO COSTRUTTORE O.E. REFERENCE																				
	960322	81508030009 81508030014																				
DESCRIZIONE / DESCRIPTION																						
<p>Disco freno assale anteriore Brake disc front axle</p> <p>Fascia AUTOVENTILANTE SELF-VENTILATED Band</p>																						
ILLUSTRAZIONE / ILLUSTRATION	NOSTRO RIFERIMENTO OUR REFERENCE	RIFERIMENTO COSTRUTTORE O.E. REFERENCE																				
	960956	81508206014																				
DESCRIZIONE / DESCRIPTION																						
<p>Serie pastiglie freno anteriore - Set of brake pads front</p> <table border="1"> <thead> <tr> <th>WVA</th> <th>Larghezza Width - mm.</th> <th>Altezza Height - mm.</th> <th>Spessore Thickness - mm.</th> </tr> </thead> <tbody> <tr> <td>29113</td> <td>250</td> <td>118</td> <td>28</td> </tr> <tr> <td>29114</td> <td></td> <td></td> <td></td> </tr> <tr> <td>29030</td> <td></td> <td></td> <td></td> </tr> <tr> <td>29083</td> <td></td> <td></td> <td></td> </tr> </tbody> </table>			WVA	Larghezza Width - mm.	Altezza Height - mm.	Spessore Thickness - mm.	29113	250	118	28	29114				29030				29083			
WVA	Larghezza Width - mm.	Altezza Height - mm.	Spessore Thickness - mm.																			
29113	250	118	28																			
29114																						
29030																						
29083																						
ILLUSTRAZIONE / ILLUSTRATION	NOSTRO RIFERIMENTO OUR REFERENCE	RIFERIMENTO COSTRUTTORE O.E. REFERENCE																				
<p>Connettore ovale - Lungh. mm. 340 Oval connector - Length mm. 340</p> <p>1</p> <p>Connettore ovale - Lungh. mm. 194 Oval connector - Length mm. 194</p> <p>2</p>	960976	81508110004 (1)																				
	960822	81259376012 (2) 81259376011																				
<p>Kit segnalatori usura freno anteriore e posteriore (2 pz.) Set of brake wear indicators front and rear (2 pcs)</p>																						

TIPO DI VEICOLO / VEHICLE TYPE

MAN

F 2000 (01/94-06/98)

Assale anteriore - Front axle

M 2000 (08/95-09/99)

Assale anteriore - Front axle

TGA (dal 12/00 - from 12/00)

Assale anteriore e posteriore - Front and rear axle

TGX (dal 2007 - from 2007)

Assale anteriore - Front axle

ILLUSTRAZIONE / ILLUSTRATION	NOSTRO RIFERIMENTO OUR REFERENCE	RIFERIMENTO COSTRUTTORE O.E. REFERENCE		
	960321	81508030040 - 81508030023 81508030038 - 81508030031		
DESCRIZIONE / DESCRIPTION				
Disco freno assale anteriore e posteriore Brake disc front and rear axle				
				
Fascia AUTOVENTILANTE SELF-VENTILATED Band				
ILLUSTRAZIONE / ILLUSTRATION	NOSTRO RIFERIMENTO OUR REFERENCE	RIFERIMENTO COSTRUTTORE O.E. REFERENCE		
	960956	81508206014		
DESCRIZIONE / DESCRIPTION				
Serie pastiglie freno anteriore e posteriore Set of brake pads front and rear				
	WVA	Larghezza Width - mm.	Altezza Height - mm.	Spessore Thickness - mm.
	29113 29030 29083	250	118	28
				
ILLUSTRAZIONE / ILLUSTRATION	NOSTRO RIFERIMENTO OUR REFERENCE	RIFERIMENTO COSTRUTTORE O.E. REFERENCE		
Connettore ovale - Lungh.mm. 289 Oval connector - Length mm. 289  Connettore ovale - Lungh.mm. 194 Oval connector - Length mm. 194	960807	68324072 (1)		
	960822	81259376012 (2) 81259376011		
Kit segnalatori usura freno anteriore e posteriore (2 pz.) Set of brake wear indicators front and rear (2 pcs)				

TIPO DI VEICOLO / VEHICLE TYPE

MAN

F 2000 (01/94-06/98)

Assale anteriore - Front axle

TGA (dal 04/00 - from 04/00)

Assale posteriore - Rear axle

TGX (dal 2007 - from 2007)

Assale posteriore - Rear axle

(SENZA ABS - WITHOUT ABS)

ILLUSTRAZIONE / ILLUSTRATION	NOSTRO RIFERIMENTO OUR REFERENCE	RIFERIMENTO COSTRUTTORE O.E. REFERENCE								
	960100	81508030041 81508030021								
DESCRIZIONE / DESCRIPTION										
<p>Disco freno assale anteriore e posteriore Brake disc front and rear axle</p> <p>Fascia AUTOVENTILANTE SELF-VENTILATED Band</p>										
ILLUSTRAZIONE / ILLUSTRATION	NOSTRO RIFERIMENTO OUR REFERENCE	RIFERIMENTO COSTRUTTORE O.E. REFERENCE								
	960984	81508206041 81508205072								
DESCRIZIONE / DESCRIPTION										
<p>Serie pastiglie freno anteriore e posteriore Set of brake pads front and rear</p> <table border="1"> <thead> <tr> <th>WVA</th> <th>Larghezza Width - mm.</th> <th>Altezza Height - mm.</th> <th>Spessore Thickness - mm.</th> </tr> </thead> <tbody> <tr> <td>29131</td> <td>250</td> <td>118</td> <td>30</td> </tr> </tbody> </table>			WVA	Larghezza Width - mm.	Altezza Height - mm.	Spessore Thickness - mm.	29131	250	118	30
WVA	Larghezza Width - mm.	Altezza Height - mm.	Spessore Thickness - mm.							
29131	250	118	30							
ILLUSTRAZIONE / ILLUSTRATION	NOSTRO RIFERIMENTO OUR REFERENCE	RIFERIMENTO COSTRUTTORE O.E. REFERENCE								
<p>Connettore ovale - Lungh. mm. 289 Oval connector - Length mm. 289</p> <p>1</p>	960807	68324072 (1)								
<p>Connettore ovale - Lungh. mm. 194 Oval connector - Length mm. 194</p> <p>Ø 17 mm. 2</p>	960822	81259376012 (2) 81259376011								
<p>Kit segnalatori usura freno anteriore e posteriore (2 pz.) Set of brake wear indicators front and rear (2 pcs)</p>										

TIPO DI VEICOLO / VEHICLE TYPE

MAN
TG-A (dal 04/00 - from 04/00) **Assale posteriore - Rear axle**
MAN Bus **Assale posteriore**

(CON ABS - WITH ABS)

ILLUSTRAZIONE / ILLUSTRATION	NOSTRO RIFERIMENTO OUR REFERENCE	RIFERIMENTO COSTRUTTORE O.E. REFERENCE								
<p>TH min. 35,00 mm.</p> <p>10 Fori - 10 Holes</p> <p>Ø 208 mm.</p> <p>135 mm.</p> <p>45 mm.</p> <p>Ø 432 mm.</p> 	960393	81508030048 81508030028								
DESCRIZIONE / DESCRIPTION										
<p>Disco freno assale posteriore Brake disc rear axle</p> <p>Fascia AUTOVENTILANTE SELF-VENTILATED Band</p> 										
ILLUSTRAZIONE / ILLUSTRATION	NOSTRO RIFERIMENTO OUR REFERENCE	RIFERIMENTO COSTRUTTORE O.E. REFERENCE								
	960984	81508206041 81508205072								
DESCRIZIONE / DESCRIPTION										
<p>Serie pastiglie freno anteriore e posteriore Set of brake pads front and rear</p> <table border="1"> <thead> <tr> <th>WVA</th> <th>Larghezza Width - mm.</th> <th>Altezza Height - mm.</th> <th>Spessore Thickness - mm.</th> </tr> </thead> <tbody> <tr> <td>29131</td> <td>250</td> <td>118</td> <td>30</td> </tr> </tbody> </table> 			WVA	Larghezza Width - mm.	Altezza Height - mm.	Spessore Thickness - mm.	29131	250	118	30
WVA	Larghezza Width - mm.	Altezza Height - mm.	Spessore Thickness - mm.							
29131	250	118	30							
ILLUSTRAZIONE / ILLUSTRATION	NOSTRO RIFERIMENTO OUR REFERENCE	RIFERIMENTO COSTRUTTORE O.E. REFERENCE								
<p>Connettore ovale - Lungh.mm. 289 Oval connector - Length mm. 289</p> <p>1</p> <p>Ø 17 mm.</p> <p>2</p> <p>Connettore ovale - Lungh.mm. 194 Oval connector - Length mm. 194</p> 	960807 960822	68324072 (1) 81259376012 (2) 81259376011								
<p>Kit segnalatori usura freno anteriore e posteriore (2 pz.) Set of brake wear indicators front and rear (2 pcs)</p>										

TIPO DI VEICOLO / VEHICLE TYPE

MAN

TGL 7.150 - 7.180

TGL 8.180 - 8.210 - 8.240

TGL 10.180 - 10.210 - 10.240

TGL 12.180 - 12.210 - 12.240

(dal 04/2005 - from 04/2005)

ILLUSTRAZIONE / ILLUSTRATION

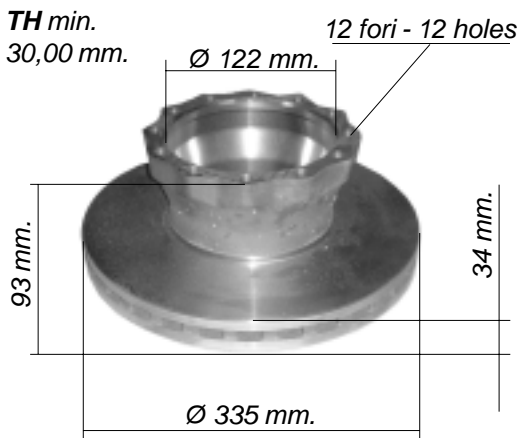

NOSTRO RIFERIMENTO OUR REFERENCE

960344

RIFERIMENTO COSTRUTTORE O.E. REFERENCE

81508030042

DESCRIZIONE / DESCRIPTION

Disco freno assale anteriore
Brake disc front axle

Fascia AUTOVENTILANTE
SELF-VENTILATED Band



ILLUSTRAZIONE / ILLUSTRATION

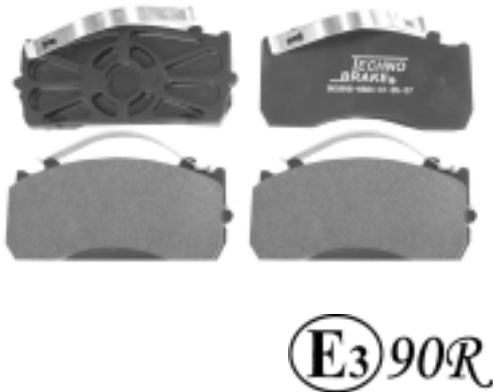

NOSTRO RIFERIMENTO OUR REFERENCE

960998

RIFERIMENTO COSTRUTTORE O.E. REFERENCE

81508206043
81508206054

DESCRIZIONE / DESCRIPTION

Serie pastiglie freno anteriore
Set of brake pads front

WVA	Larghezza Width - mm.	Altezza Height - mm.	Spessore Thickness - mm.
29115 29148	173.60	84	27/34



ILLUSTRAZIONE / ILLUSTRATION



Connettore ovale - Lungh. mm. 320
Oval connector - Length mm. 320

NOSTRO RIFERIMENTO OUR REFERENCE

960553

RIFERIMENTO COSTRUTTORE O.E. REFERENCE

81508226015

DESCRIZIONE / DESCRIPTION

Kit segnalatori usura freno anteriore e posteriore **SENZA**
supporti (2 pz.)
Set of brake wear indicators front and rear **WITHOUT**
supports (2 pcs)

TIPO DI VEICOLO / VEHICLE TYPE

MERCEDES VITO 108CDI 2.2 - 108D 2.3
(Autobus e Furgonato) 110CDI 2.2 - 110TD 2.3
 112CDI 2.2
 113 2.0
 114 2.3

ILLUSTRAZIONE / ILLUSTRATION

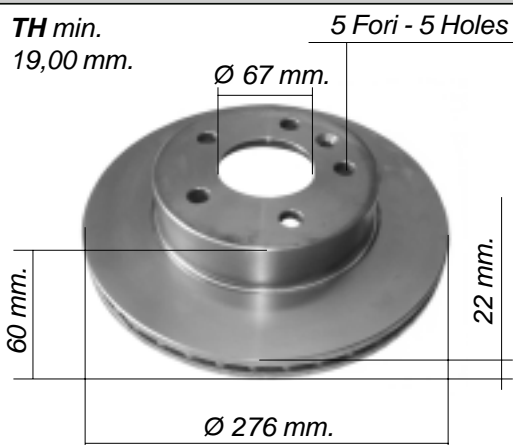
NOSTRO RIFERIMENTO
OUR REFERENCE**960333**RIFERIMENTO COSTRUTTORE
O.E. REFERENCE

6384210112

DESCRIZIONE / DESCRIPTION

Disco freno assale anteriore
 Brake disc front axle

Fascia AUTOVENTILANTE
 SELF-VENTILATED Band



ILLUSTRAZIONE / ILLUSTRATION

NOSTRO RIFERIMENTO
OUR REFERENCE**960921**RIFERIMENTO COSTRUTTORE
O.E. REFERENCE

0024203920
 0024209920

DESCRIZIONE / DESCRIPTION

Serie pastiglie freno anteriore - Set of brake pads front

WVA	Larghezza Width - mm.	Altezza Height - mm.	Spessore Thickness - mm.
21576 21577	156	64	20



ILLUSTRAZIONE / ILLUSTRATION

Tondo - Round

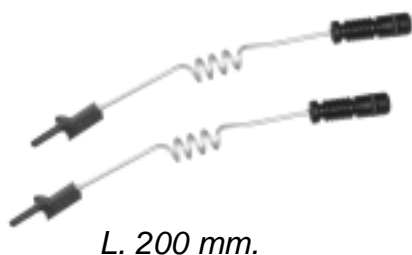
NOSTRO RIFERIMENTO
OUR REFERENCE**960915**RIFERIMENTO COSTRUTTORE
O.E. REFERENCE

9015400017
 9015400117

DESCRIZIONE / DESCRIPTION

Kit segnalatori usura freno anteriore e posteriore (2 pz)
 Set of brake wear indicators front and rear (2 pcs)

TIPO DI VEICOLO / VEHICLE TYPE

MERCEDES VITO 108CDI 2.2 - 108D 2.3
(Autobus e Furgonato) 110CDI 2.2 - 110TD 2.3
 112CDI 2.2
 113 2.0
 114 2.3

ILLUSTRAZIONE / ILLUSTRATION

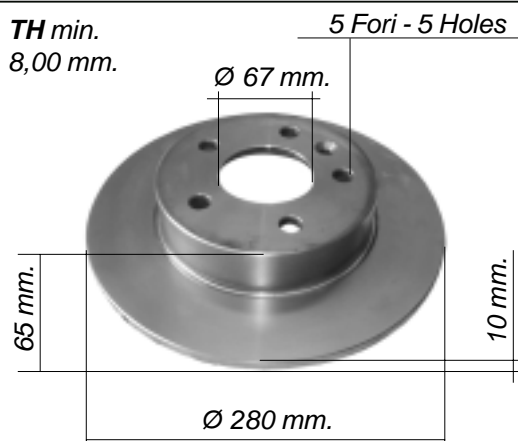

NOSTRO RIFERIMENTO OUR REFERENCE

960334

RIFERIMENTO COSTRUTTORE O.E. REFERENCE

6384230112

DESCRIZIONE / DESCRIPTION

Disco freno assale posteriore
 Brake disc rear axle



ILLUSTRAZIONE / ILLUSTRATION



NOSTRO RIFERIMENTO OUR REFERENCE

960926

RIFERIMENTO COSTRUTTORE O.E. REFERENCE

0024204820 - 003420020
 6384230110

DESCRIZIONE / DESCRIPTION

Serie pastiglie freno posteriore- Set of brake pads rear

WVA	Larghezza Width - mm.	Altezza Height -mm.	Spessore Thickness - mm.
21904 21278	63	57	17



ILLUSTRAZIONE / ILLUSTRATION

Tondo - Round

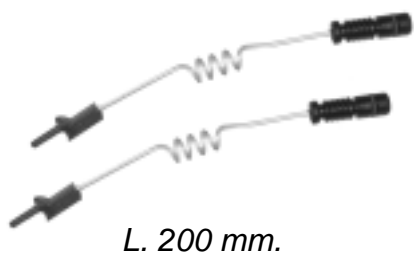

L. 200 mm.

NOSTRO RIFERIMENTO OUR REFERENCE

960915

RIFERIMENTO COSTRUTTORE O.E. REFERENCE

9015400017
 9015400117

DESCRIZIONE / DESCRIPTION

Kit segnalatori usura freno anteriore e posteriore (2 pz)
 Set of brake wear indicators front and rear (2 pcs)

TIPO DI VEICOLO / VEHICLE TYPE

SPRINTER (Autobus - Furgonato e pianale piatto)

208CDI - 211CDI - 213CDI - 216CDI (dal 04/2000 - from 04/2000) - 308CDI - 311CDI - 313CDI
316CDI (dal 04/2000 - from 04/2000) - 411CDI - 413CDI - 416CDI (dal 04/2000 - from 04/2000)
214 - 314 - 414 (da 02/95 - from 02/95) - 408 - 411 - 413 - 414 - 416 (dal 04/00 - from 04/00)

ILLUSTRAZIONE / ILLUSTRATION	NOSTRO RIFERIMENTO OUR REFERENCE	RIFERIMENTO COSTRUTTORE O.E. REFERENCE												
	960324	9024210612 - 9024210412 9024210312 - 9024210712												
DESCRIZIONE / DESCRIPTION														
Disco freno assale anteriore Brake disc front axle														
Fascia AUTOVENTILANTE SELF-VENTILATED Band														
ILLUSTRAZIONE / ILLUSTRATION	NOSTRO RIFERIMENTO OUR REFERENCE	RIFERIMENTO COSTRUTTORE O.E. REFERENCE												
	960921	0024203920 - 0024209920												
DESCRIZIONE / DESCRIPTION														
Serie pastiglie freno anteriore - Set of brake pads front														
<table border="1"> <thead> <tr> <th>WVA</th> <th>Larghezza Width - mm.</th> <th>Altezza Height - mm.</th> <th>Spessore Thickness - mm.</th> </tr> </thead> <tbody> <tr> <td>21576</td> <td>156</td> <td>64</td> <td>20</td> </tr> <tr> <td>21577</td> <td></td> <td></td> <td></td> </tr> </tbody> </table>			WVA	Larghezza Width - mm.	Altezza Height - mm.	Spessore Thickness - mm.	21576	156	64	20	21577			
WVA	Larghezza Width - mm.	Altezza Height - mm.	Spessore Thickness - mm.											
21576	156	64	20											
21577														
ILLUSTRAZIONE / ILLUSTRATION	NOSTRO RIFERIMENTO OUR REFERENCE	RIFERIMENTO COSTRUTTORE O.E. REFERENCE												
	960920	0004237110 - 0024204120 0024204220 - 0034201720 9024210110												
DESCRIZIONE / DESCRIPTION														
Serie pastiglie freno anteriore e posteriore Set of brake pads front and rear														
<table border="1"> <thead> <tr> <th>WVA</th> <th>Larghezza Width - mm.</th> <th>Altezza Height - mm.</th> <th>Spessore Thickness - mm.</th> </tr> </thead> <tbody> <tr> <td>29076</td> <td>165</td> <td>73</td> <td>20</td> </tr> </tbody> </table>			WVA	Larghezza Width - mm.	Altezza Height - mm.	Spessore Thickness - mm.	29076	165	73	20				
WVA	Larghezza Width - mm.	Altezza Height - mm.	Spessore Thickness - mm.											
29076	165	73	20											
ILLUSTRAZIONE / ILLUSTRATION	NOSTRO RIFERIMENTO OUR REFERENCE	RIFERIMENTO COSTRUTTORE O.E. REFERENCE												
<p>Tondo - Round</p> <p>L. 200 mm.</p>	960915	9015400017 - 9015400117												
DESCRIZIONE / DESCRIPTION														
Kit segnalatori usura freno anteriore e posteriore (2 pz) Set of brake wear indicators front and rear (2 pcs)														

TIPO DI VEICOLO / VEHICLE TYPE

SPRINTER (Autobus - Furgonato e pianale piatto)

208CDI - 211CDI - 213CDI - 216CDI (dal 04/2000 - from 04/2000)

308CDI - 311CDI - 313CDI - 316CDI (dal 04/2000 - from 04/2000)

411CDI - 413CDI - 416CDI (dal 04/2000 - from 04/2000)

214 - 314 - 414 (da 02/95 - from 02/95)

408 - 411 - 413 - 414 - 416 (dal 04/00 - from 04/00)

310D - 312D - 408D - 410D (05/97-08/02)

ILLUSTRAZIONE / ILLUSTRATION

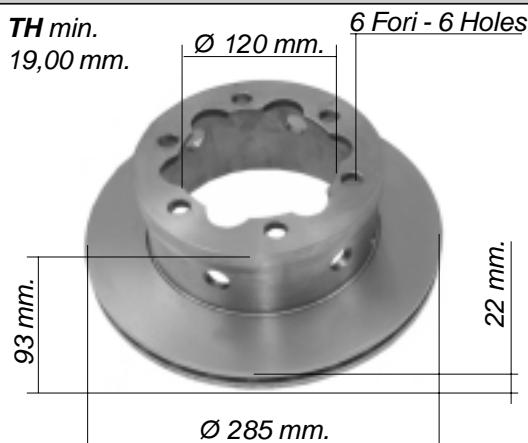

NOSTRO RIFERIMENTO OUR REFERENCE

960323

RIFERIMENTO COSTRUTTORE O.E. REFERENCE

9044230312
9044230212

DESCRIZIONE / DESCRIPTION

Disco freno assale posteriore
Brake disc rear axle

Fascia AUTOVENTILANTE
SELF-VENTILATED Band



ILLUSTRAZIONE / ILLUSTRATION



NOSTRO RIFERIMENTO OUR REFERENCE

960920

RIFERIMENTO COSTRUTTORE O.E. REFERENCE

0004237110 - 0024204120
0024204220 - 0034201720
9024210110

DESCRIZIONE / DESCRIPTION

Serie pastiglie freno anteriore e posteriore
Set of brake pads front and rear

WVA	Larghezza Width - mm.	Altezza Height - mm.	Spessore Thickness - mm.
29076	165	73	20



ILLUSTRAZIONE / ILLUSTRATION

Tondo - Round



L. 200 mm.

NOSTRO RIFERIMENTO OUR REFERENCE

960915

RIFERIMENTO COSTRUTTORE O.E. REFERENCE

9015400017
9015400117

DESCRIZIONE / DESCRIPTION

Kit segnalatori usura freno anteriore e posteriore (2 pz)
Set of brake wear indicators front and rear (2 pcs)

TIPO DI VEICOLO / VEHICLE TYPE

SPRINTER (Autobus - Furgonato e pianale piatto)

208CDI - 211CDI - 213CDI - 216CDI (dal 04/2000 - from 04/2000)

308CDI - 311CDI - 313CDI - 316CDI (dal 04/2000 - from 04/2000)

411CDI - 413CDI - 416CDI (dal 04/2000 - from 04/2000)

214 - 314 - 414 (da 02/95 - from 02/95)

408 - 411 - 413 - 414 - 416 (dal 04/00 - from 04/00)

310D - 312D - 408D - 410D (05/97-08/02)

ILLUSTRAZIONE / ILLUSTRATION

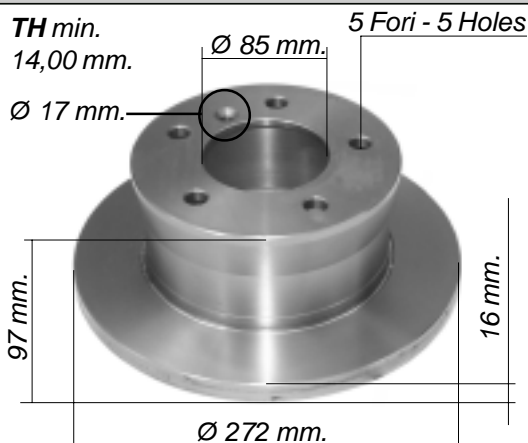
NOSTRO RIFERIMENTO
OUR REFERENCERIFERIMENTO COSTRUTTORE
O.E. REFERENCE**960325**

9024230312 - 9024230112

DESCRIZIONE / DESCRIPTION

Disco freno assale posteriore
Brake disc rear axle

ILLUSTRAZIONE / ILLUSTRATION

NOSTRO RIFERIMENTO
OUR REFERENCERIFERIMENTO COSTRUTTORE
O.E. REFERENCE**E3 90R****960922**0024204020 - 0024206020
9024230510

DESCRIZIONE / DESCRIPTION

Serie pastiglie freno posteriore - Set of brake pads rear

WVA	Larghezza Width - mm.	Altezza Height - mm.	Spessore Thickness - mm.
21592 21593	156	55	18



ILLUSTRAZIONE / ILLUSTRATION

NOSTRO RIFERIMENTO
OUR REFERENCERIFERIMENTO COSTRUTTORE
O.E. REFERENCE

Tondo-Round

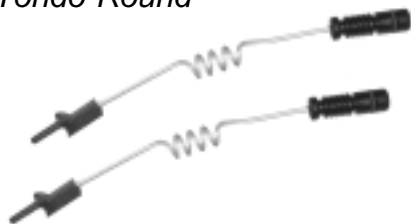

L. 200 mm.

9609159015400017
9015400117

DESCRIZIONE / DESCRIPTION

Kit segnalatori usura freno anteriore e posteriore (2 pz)
Set of brake wear indicators front and rear (2 pcs)

TIPO DI VEICOLO / VEHICLE TYPE

SPRINTER (Autobus - Furgonato e pianale piatto)

208CDI - 211CDI - 213CDI - 216CDI (dal 04/2000 - from 04/2000)

308CDI - 311CDI - 313CDI - 316CDI (dal 04/2000 - from 04/2000)

411CDI - 413CDI - 416CDI (dal 04/2000 - from 04/2000)

214 - 314 - 414 (da 02/95 - from 02/95)

408 - 411 - 413 - 414 - 416 (dal 04/00 - from 04/00)

310D - 312D - 408D - 410D (05/97-08/02)

ILLUSTRAZIONE / ILLUSTRATION

NOSTRO RIFERIMENTO OUR REFERENCE

RIFERIMENTO COSTRUTTORE O.E. REFERENCE

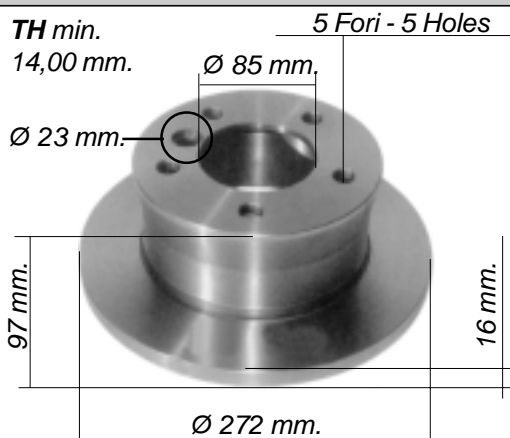

960390

9024230412
2D0615601D

DESCRIZIONE / DESCRIPTION

Disco freno assale posteriore
Brake disc rear axle



ILLUSTRAZIONE / ILLUSTRATION

NOSTRO RIFERIMENTO OUR REFERENCE

RIFERIMENTO COSTRUTTORE O.E. REFERENCE



E3 90R

960922

0024204020 - 0024206020
9024230510

DESCRIZIONE / DESCRIPTION

Serie pastiglie freno posteriore - Set of brake pads rear

WVA	Larghezza Width - mm.	Altezza Height - mm.	Spessore Thickness - mm.
21592 21593	156	55	18



ILLUSTRAZIONE / ILLUSTRATION

NOSTRO RIFERIMENTO OUR REFERENCE

RIFERIMENTO COSTRUTTORE O.E. REFERENCE

Tondo-Round



L. 200 mm.

960915

9015400017
9015400117

DESCRIZIONE / DESCRIPTION

Kit segnalatori usura freno anteriore e posteriore (2 pz)
Set of brake wear indicators front and rear (2 pcs)

TIPO DI VEICOLO / VEHICLE TYPE

MERCEDES SPRINTER

208CDI - 211CDI - 213CDI - 214 - 214NGT - 216CDI

308CDI - 310D - 311CDI - 312CDI - 313CDI - 314CDI - 316CDI

408D - 410D - 411CDI - 412D - 413CDI - 414CDI - 416CDI

VOLKSWAGEN

LT 28-35 2.5 SDI-TDI - LT 28-46 2.5-2.8 TDI

ILLUSTRAZIONE / ILLUSTRATION

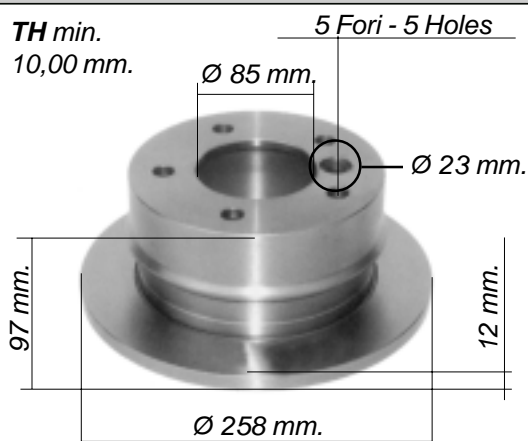
NOSTRO RIFERIMENTO
OUR REFERENCE**960391**RIFERIMENTO COSTRUTTORE
O.E. REFERENCE9014230812
2D0615601C

DESCRIZIONE / DESCRIPTION

Disco freno assale posteriore
Brake disc rear axle

ILLUSTRAZIONE / ILLUSTRATION

NOSTRO RIFERIMENTO
OUR REFERENCE**960922**RIFERIMENTO COSTRUTTORE
O.E. REFERENCE0024204020 - 0024206020
9024230510

DESCRIZIONE / DESCRIPTION

Serie pastiglie freno posteriore - Set of brake pads rear

WVA	Larghezza Width - mm.	Altezza Height - mm.	Spessore Thickness - mm.
21592 21593	156	55	18



ILLUSTRAZIONE / ILLUSTRATION

Tondo - Round

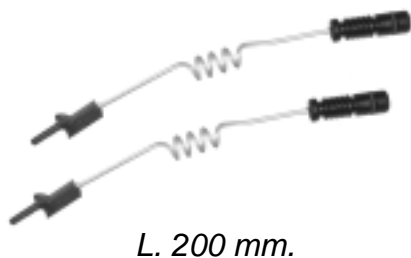

L. 200 mm.

NOSTRO RIFERIMENTO
OUR REFERENCE**960915**RIFERIMENTO COSTRUTTORE
O.E. REFERENCE9015400017
9015400117

DESCRIZIONE / DESCRIPTION

Kit segnalatori usura freno anteriore e posteriore (2 pz)
Set of brake wear indicators front and rear (2 pcs)

TIPO DI VEICOLO / VEHICLE TYPE

MERCEDES SPRINTER U.T.

209CDI - 211CDI - 215CDI - 218CDI - 309CDI - 311D - 315CDI - 318CDI
509CDI - 511CDI - 515CDI - 518CDI
(DAL 06/2006 - FROM 06/2006)

ILLUSTRAZIONE / ILLUSTRATION

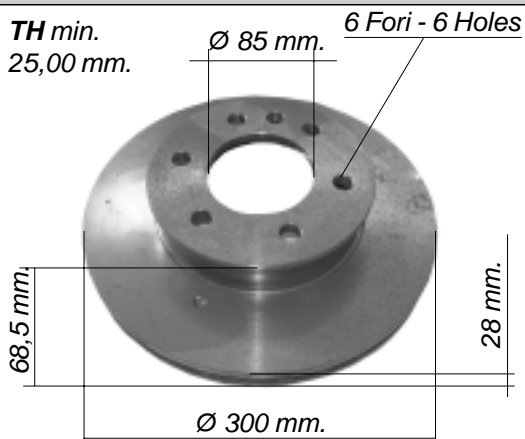

NOSTRO RIFERIMENTO OUR REFERENCE

960564

RIFERIMENTO COSTRUTTORE O.E. REFERENCE

9064210012

DESCRIZIONE / DESCRIPTION

Disco freno assale anteriore
Brake disc front axle

Fascia AUTOVENTILANTE
SELF-VENTILATED Band



ILLUSTRAZIONE / ILLUSTRATION



NOSTRO RIFERIMENTO OUR REFERENCE

960890

RIFERIMENTO COSTRUTTORE O.E. REFERENCE

0054205220 - 0044208320

DESCRIZIONE / DESCRIPTION

Serie pastiglie freno anteriore - Set of brake pads front

WVA	Larghezza Width - mm.	Altezza Height - mm.	Spessore Thickness - mm.
29192	163.30	67.10	20.9



ILLUSTRAZIONE / ILLUSTRATION



PER VERSIONE - FOR VERSION
509CDI - 511CDI - 515CDI - 518CDI (2006)

NOSTRO RIFERIMENTO OUR REFERENCE

960427

RIFERIMENTO COSTRUTTORE O.E. REFERENCE

0044208220

DESCRIZIONE / DESCRIPTION

Serie pastiglie freno anteriore
Set of brake pads front

WVA	Larghezza Width - mm.	Altezza Height - mm.	Spessore Thickness - mm.
29200	169,10	73,20	20,80



ILLUSTRAZIONE / ILLUSTRATION



NOSTRO RIFERIMENTO OUR REFERENCE

960824

RIFERIMENTO COSTRUTTORE O.E. REFERENCE







9065401417 - 9065401517

DESCRIZIONE / DESCRIPTION

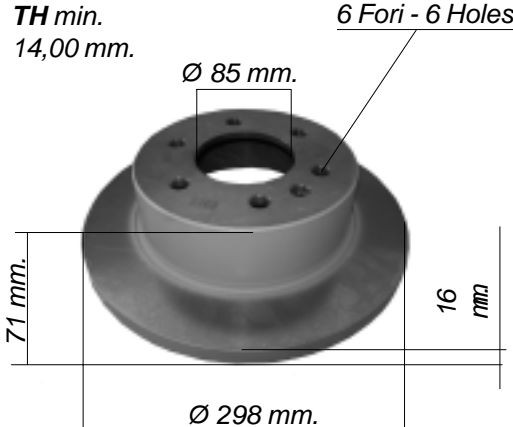
Kit segnalatori usura freno anteriore (2 pz)
Set of brake wear indicator front (2 pcs)

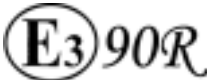
TIPO DI VEICOLO / VEHICLE TYPE

MERCEDES SPRINTER U.T.
209CDI - 211CDI - 215CDI - 218CDI
309CDI - 311D - 315CDI - 318CDI

ILLUSTRAZIONE / ILLUSTRATION	NOSTRO RIFERIMENTO OUR REFERENCE	RIFERIMENTO COSTRUTTORE O.E. REFERENCE								
	960565	9064230012								
DESCRIZIONE / DESCRIPTION										
<p>Disco freno assale posteriore Brake disc rear axle</p> 										
ILLUSTRAZIONE / ILLUSTRATION	NOSTRO RIFERIMENTO OUR REFERENCE	RIFERIMENTO COSTRUTTORE O.E. REFERENCE								
	960890	0054205220 - 0044208320								
DESCRIZIONE / DESCRIPTION										
<p>Serie pastiglie freno anteriore - Set of brake pads front</p> <table border="1" data-bbox="638 1254 1236 1377"> <thead> <tr> <th>WVA</th> <th>Larghezza Width - mm.</th> <th>Altezza Height - mm.</th> <th>Spessore Thickness - mm.</th> </tr> </thead> <tbody> <tr> <td>29192</td> <td>163.30</td> <td>67.10</td> <td>20.9</td> </tr> </tbody> </table>  			WVA	Larghezza Width - mm.	Altezza Height - mm.	Spessore Thickness - mm.	29192	163.30	67.10	20.9
WVA	Larghezza Width - mm.	Altezza Height - mm.	Spessore Thickness - mm.							
29192	163.30	67.10	20.9							
ILLUSTRAZIONE / ILLUSTRATION	NOSTRO RIFERIMENTO OUR REFERENCE	RIFERIMENTO COSTRUTTORE O.E. REFERENCE								
	960825	6395401417 6395401517								
DESCRIZIONE / DESCRIPTION										
<p>Kit segnalatori usura freno posteriore (2 pz) Set of brake wear indicators rear (2 pcs)</p>										
ILLUSTRAZIONE / ILLUSTRATION	NOSTRO RIFERIMENTO OUR REFERENCE	RIFERIMENTO COSTRUTTORE O.E. REFERENCE								
	960435	9015400317								
DESCRIZIONE / DESCRIPTION										
<p>Kit segnalatori usura freno (2 pz) Set of brake wear indicators (2 pcs)</p>										

TIPO DI VEICOLO / VEHICLE TYPE

MERCEDES SPRINTER U.T.
509CDI - 511CDI - 515CDI - 518CDI
(DAL 06/2006 - FROM 06/2006)

ILLUSTRAZIONE / ILLUSTRATION

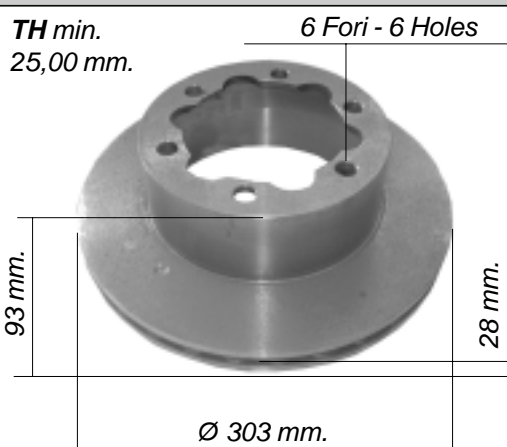

NOSTRO RIFERIMENTO
OUR REFERENCE

960422

RIFERIMENTO COSTRUTTORE
O.E. REFERENCE

9064230112

DESCRIZIONE / DESCRIPTION

Disco freno assale posteriore
Brake disc rear axle



ILLUSTRAZIONE / ILLUSTRATION



NOSTRO RIFERIMENTO
OUR REFERENCE

960896

RIFERIMENTO COSTRUTTORE
O.E. REFERENCE

0044208120

DESCRIZIONE / DESCRIPTION

Serie pastiglie freno posteriore - Set of brake pads rear

WVA	Larghezza Width - mm.	Altezza Height - mm.	Spessore Thickness - mm.
29122	165	79	20,80



ILLUSTRAZIONE / ILLUSTRATION



NOSTRO RIFERIMENTO
OUR REFERENCE

960825

RIFERIMENTO COSTRUTTORE
O.E. REFERENCE

6395401417
6395401517

DESCRIZIONE / DESCRIPTION

Kit segnalatori usura freno posteriore (2 pz)
Set of brake wear indicators rear (2 pcs)

TIPO DI VEICOLO / VEHICLE TYPE

MERCEDES (Autobus - Furgonato e pianale piatto)

207D 2.4 - 208 2.3 - 208D 2.3 - 210 2.3 - 210D 2.8 (05/77-02/96)

308D 2.3 - 310D 2.9 (06/89-02/96)

ILLUSTRAZIONE / ILLUSTRATION

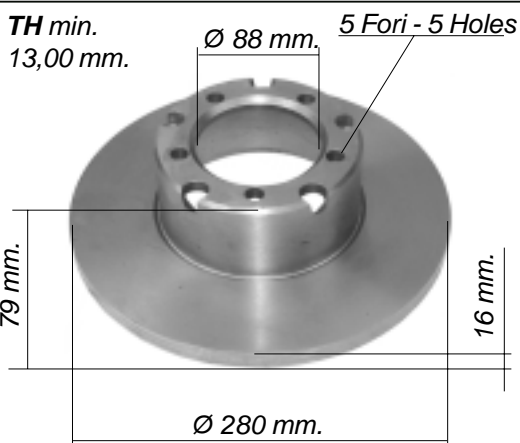
NOSTRO RIFERIMENTO
OUR REFERENCERIFERIMENTO COSTRUTTORE
O.E. REFERENCE**960326**6014200272 - 6014200072
6014215112

DESCRIZIONE / DESCRIPTION

Disco freno assale anteriore
Brake disc front axle

ILLUSTRAZIONE / ILLUSTRATION

NOSTRO RIFERIMENTO
OUR REFERENCERIFERIMENTO COSTRUTTORE
O.E. REFERENCE**960967**

6694210008 - 6015860042

DESCRIZIONE / DESCRIPTION

Serie pastiglie freno anteriore - Set of brake pads front

WVA	Larghezza Width - mm.	Altezza Height - mm.	Spessore Thickness - mm.
20784	149	75	18

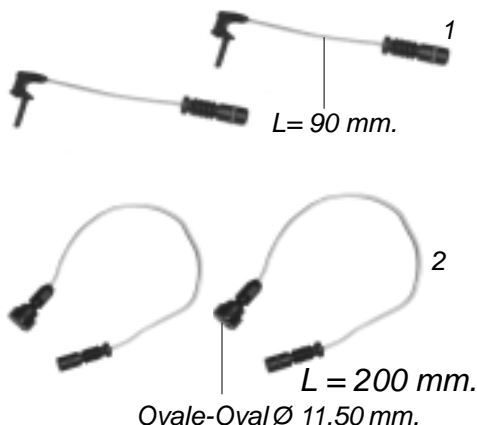

ILLUSTRAZIONE / ILLUSTRATION

NOSTRO RIFERIMENTO
OUR REFERENCERIFERIMENTO COSTRUTTORE
O.E. REFERENCE**960842**

0005400217 - 1405401217 (1)

960813

6015400617 (2)

DESCRIZIONE / DESCRIPTION

Kit segnalatori usura freno anteriore (2 pz.)
Set of brake wear indicators front (2 pcs)Kit segnalatori usura freno a tamburo posteriore (2 pz.)
Set of brake wear indicators rear for brake drum (2 pcs)

TIPO DI VEICOLO / VEHICLE TYPE

MERCEDES

508D (03/89-12/94)

510 (04/86-12/94)

L 608D (01/70-12/88)

L 613D (04/77-12/88)

ILLUSTRAZIONE / ILLUSTRATION

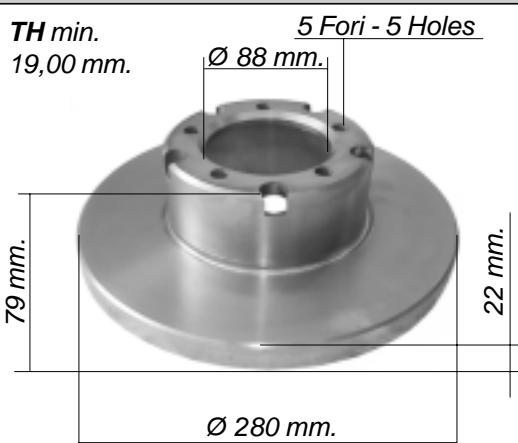

NOSTRO RIFERIMENTO OUR REFERENCE

960335

RIFERIMENTO COSTRUTTORE O.E. REFERENCE

6014200372 - 6014200172
6014210312

DESCRIZIONE / DESCRIPTION

Disco freno assale anteriore
Brake disc front axle



ILLUSTRAZIONE / ILLUSTRATION



NOSTRO RIFERIMENTO OUR REFERENCE

960967

RIFERIMENTO COSTRUTTORE O.E. REFERENCE

6694210008

DESCRIZIONE / DESCRIPTION

Serie pastiglie freno anteriore - Set of brake pads front

WVA	Larghezza Width - mm.	Altezza Height - mm.	Spessore Thickness - mm.
20784	149	75	18



ILLUSTRAZIONE / ILLUSTRATION

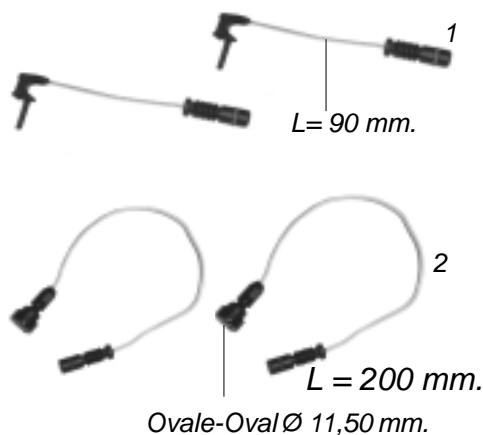

NOSTRO RIFERIMENTO OUR REFERENCE

960842

960813

RIFERIMENTO COSTRUTTORE O.E. REFERENCE

0005400217 - 1405401217 (1)

6015400617 (2)

DESCRIZIONE / DESCRIPTION

Kit segnalatori usura freno anteriore (2 pz.)
Set of brake wear indicators front (2 pcs)

Kit segnalatori usura freno a tamburo posteriore (2 pz.)
Set of brake wear indicators rear for brake drum (2 pcs)

TIPO DI VEICOLO / VEHICLE TYPE

MERCEDES

609D - 709D - 711D (03/1985)

ILLUSTRAZIONE / ILLUSTRATION

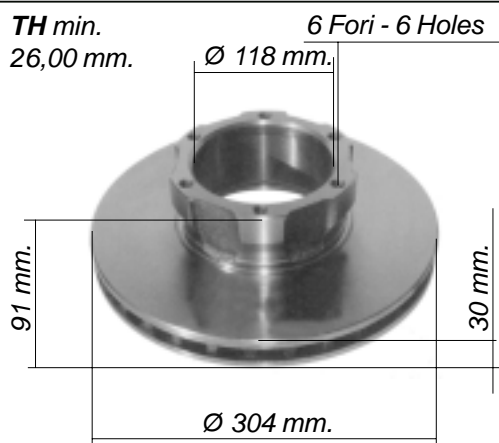
NOSTRO RIFERIMENTO
OUR REFERENCE**960319**RIFERIMENTO COSTRUTTORE
O.E. REFERENCE6694210612
6694210112

DESCRIZIONE / DESCRIPTION

Disco freno assale anteriore
Brake disc front axleFascia AUTOVENTILANTE
SELF-VENTILATED Band

ILLUSTRAZIONE / ILLUSTRATION

NOSTRO RIFERIMENTO
OUR REFERENCE**960946**RIFERIMENTO COSTRUTTORE
O.E. REFERENCE6704202820 - 6694200020
6694200120

DESCRIZIONE / DESCRIPTION

Serie pastiglie freno anteriore - Set of brake pads front

WVA	Larghezza Width - mm.	Altezza Height - mm.	Spessore Thickness - mm.
29835	175	85	22

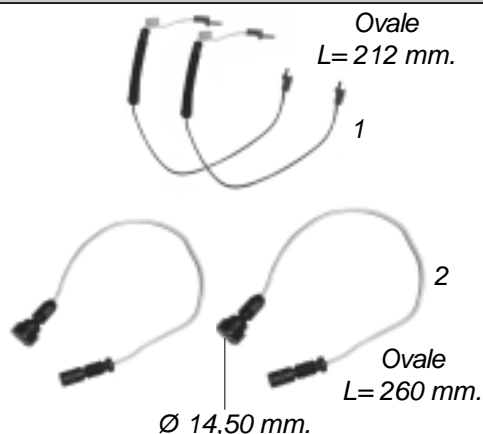

ILLUSTRAZIONE / ILLUSTRATION

NOSTRO RIFERIMENTO
OUR REFERENCE**960916****960809**RIFERIMENTO COSTRUTTORE
O.E. REFERENCE

6695400417 (1)

6705400017 (2)

DESCRIZIONE / DESCRIPTION

Kit segnalatori usura freno anteriore (2 pz.)
Set of brake wear indicators front (2 pcs)Kit segnalatori usura freno a tamburo posteriore (2 pz.)
Set of brake wear indicators rear for brake drum (2 pcs)

TIPO DI VEICOLO / VEHICLE TYPE

MERCEDES
809D - 811D (03/1985)

ILLUSTRAZIONE / ILLUSTRATION

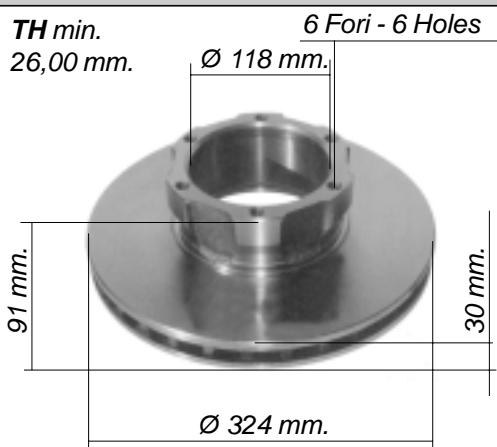

NOSTRO RIFERIMENTO
OUR REFERENCE

960318

RIFERIMENTO COSTRUTTORE
O.E. REFERENCE

6704210312
6704210112 - 6684210212

DESCRIZIONE / DESCRIPTION

Disco freno assale anteriore
Brake disc front axle

Fascia AUTOVENTILANTE
SELF-VENTILATED Band



ILLUSTRAZIONE / ILLUSTRATION



NOSTRO RIFERIMENTO
OUR REFERENCE

960946

RIFERIMENTO COSTRUTTORE
O.E. REFERENCE

6704202820 - 6694200020
6694200120

DESCRIZIONE / DESCRIPTION

Serie pastiglie freno anteriore - Set of brake pads front

WVA	Larghezza Width - mm.	Altezza Height - mm.	Spessore Thickness - mm.
29835	175	85	22



ILLUSTRAZIONE / ILLUSTRATION

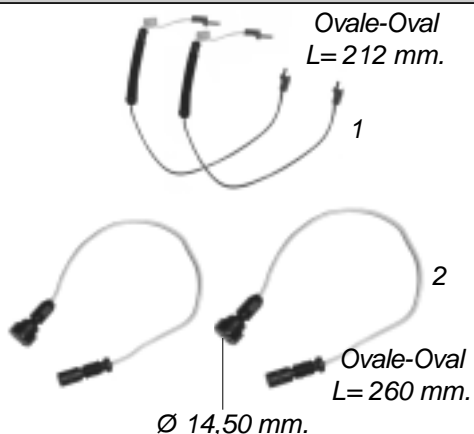

NOSTRO RIFERIMENTO
OUR REFERENCE

960916

RIFERIMENTO COSTRUTTORE
O.E. REFERENCE

6695400417 (1)

960809

6705400017 (2)

DESCRIZIONE / DESCRIPTION





Kit segnalatori usura freno anteriore (2 pz.)
Set of brake wear indicators front (2 pcs)

Kit segnalatori usura freno a tamburo posteriore (2 pz.)
Set of brake wear indicators rear for brake drum (2 pcs)

TIPO DI VEICOLO / VEHICLE TYPE

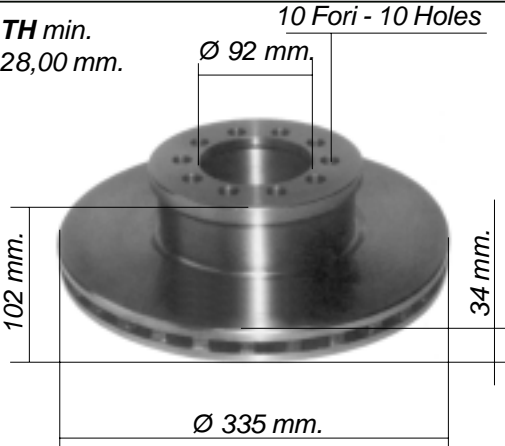
MERCEDES

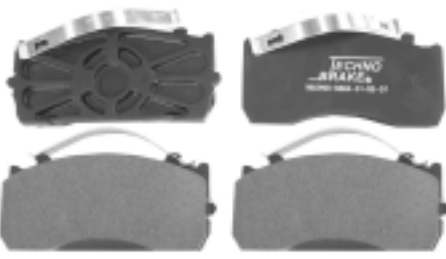
ATEGO I	712 - 715 - 812 - 815 - 817 - 823 (01/98)
ATEGO I	917 - 923 (01/98)
ATEGO I	1017 - 1023 (01/98)
MAN TGL	10/12

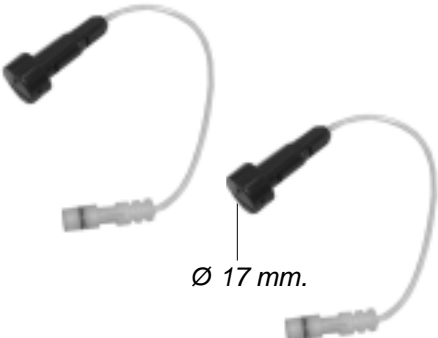
ILLUSTRAZIONE / ILLUSTRATION	NOSTRO RIFERIMENTO OUR REFERENCE	RIFERIMENTO COSTRUTTORE O.E. REFERENCE								
<p>TH min. 28,00 mm.</p> <p>10 Fori - 10 Holes</p> <p>Ø 92 mm.</p> <p>102 mm.</p> <p>34 mm.</p> <p>Ø 335 mm.</p> 	960336	9704210612 9704210112								
DESCRIZIONE / DESCRIPTION										
<p>Disco freno assale anteriore Brake disc front axle</p> <p>Fascia AUTOVENTILANTE SELF-VENTILATED Band</p> 										
ILLUSTRAZIONE / ILLUSTRATION	NOSTRO RIFERIMENTO OUR REFERENCE	RIFERIMENTO COSTRUTTORE O.E. REFERENCE								
 <p>E3 90R</p>	960998	0034201120 0034201220								
DESCRIZIONE / DESCRIPTION										
<p>Serie pastiglie freno anteriore e posteriore Set of brake pads front and rear</p> <table border="1"> <thead> <tr> <th>WVA</th> <th>Larghezza Width - mm.</th> <th>Altezza Height - mm.</th> <th>Spessore Thickness - mm.</th> </tr> </thead> <tbody> <tr> <td>29115 29148</td> <td>173,60</td> <td>84</td> <td>27/34</td> </tr> </tbody> </table> 			WVA	Larghezza Width - mm.	Altezza Height - mm.	Spessore Thickness - mm.	29115 29148	173,60	84	27/34
WVA	Larghezza Width - mm.	Altezza Height - mm.	Spessore Thickness - mm.							
29115 29148	173,60	84	27/34							
ILLUSTRAZIONE / ILLUSTRATION	NOSTRO RIFERIMENTO OUR REFERENCE	RIFERIMENTO COSTRUTTORE O.E. REFERENCE								
<p>Ovale - Oval L = 200 mm.</p> <p>Ø 17 mm.</p> 	960810	6775400817								
DESCRIZIONE / DESCRIPTION										
<p>Kit segnalatori usura freno anteriore e posteriore (2 pz.) Set of brake wear indicators front and rear (2 pcs)</p>										

TIPO DI VEICOLO / VEHICLE TYPE

MERCEDES (ASSALE 5 TON.)

ATEGO I 712 - 715 - 812 - 815 - 817 - 823 (01/98)

ATEGO I 917 - 923 (01/98)

ATEGO I 1017 - 1023 (01/98)

ILLUSTRAZIONE / ILLUSTRATION	NOSTRO RIFERIMENTO OUR REFERENCE	RIFERIMENTO COSTRUTTORE O.E. REFERENCE								
	960337	9704230612 (ex 9704230412)								
DESCRIZIONE / DESCRIPTION										
<p>Disco freno assale posteriore Brake disc rear axle</p> <p>Fascia AUTOVENTILANTE SELF-VENTILATED Band</p>										
ILLUSTRAZIONE / ILLUSTRATION	NOSTRO RIFERIMENTO OUR REFERENCE	RIFERIMENTO COSTRUTTORE O.E. REFERENCE								
	960998	0034201120 0034201220								
DESCRIZIONE / DESCRIPTION										
<p>Serie pastiglie freno anteriore e posteriore Set of brake pads front and rear</p> <table border="1"> <thead> <tr> <th>WVA</th> <th>Larghezza Width - mm.</th> <th>Altezza Height - mm.</th> <th>Spessore Thickness - mm.</th> </tr> </thead> <tbody> <tr> <td>29115 29148</td> <td>173,60</td> <td>84</td> <td>27/34</td> </tr> </tbody> </table>			WVA	Larghezza Width - mm.	Altezza Height - mm.	Spessore Thickness - mm.	29115 29148	173,60	84	27/34
WVA	Larghezza Width - mm.	Altezza Height - mm.	Spessore Thickness - mm.							
29115 29148	173,60	84	27/34							
ILLUSTRAZIONE / ILLUSTRATION	NOSTRO RIFERIMENTO OUR REFERENCE	RIFERIMENTO COSTRUTTORE O.E. REFERENCE								
	960810	6775400817								
DESCRIZIONE / DESCRIPTION										
<p>Kit segnalatori usura freno anteriore e posteriore (2 pz.) Set of brake wear indicators front and rear (2 pcs)</p>										

TIPO DI VEICOLO / VEHICLE TYPE

MERCEDES (ASSALE 7 TON.)

ATEGO I 712 - 715 - 812 - 815 - 817 - 823 (01/98)

ATEGO I 917 - 923 (01/98)

ATEGO I 1017 - 1023 (01/98)

ILLUSTRAZIONE / ILLUSTRATION

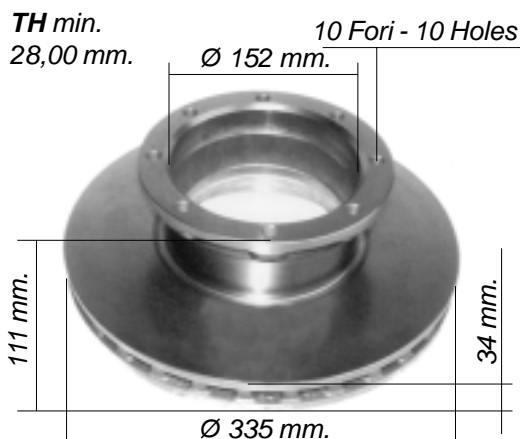
NOSTRO RIFERIMENTO
OUR REFERENCE**960338**RIFERIMENTO COSTRUTTORE
O.E. REFERENCE9704230712
9704230512

DESCRIZIONE / DESCRIPTION

Disco freno assale posteriore
Brake disc rear axleFascia AUTOVENTILANTE
SELF-VENTILATED Band

ILLUSTRAZIONE / ILLUSTRATION

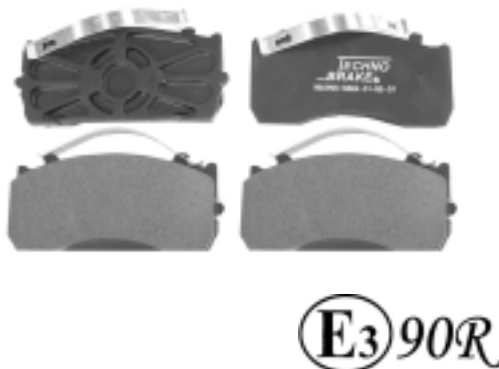
NOSTRO RIFERIMENTO
OUR REFERENCE**960998**RIFERIMENTO COSTRUTTORE
O.E. REFERENCE0034201120
0034201220

DESCRIZIONE / DESCRIPTION

Serie pastiglie freno anteriore e posteriore
Set of brake pads front and rear

WVA	Larghezza Width - mm.	Altezza Height - mm.	Spessore Thickness - mm.
29115 29148	173,60	84	27/34

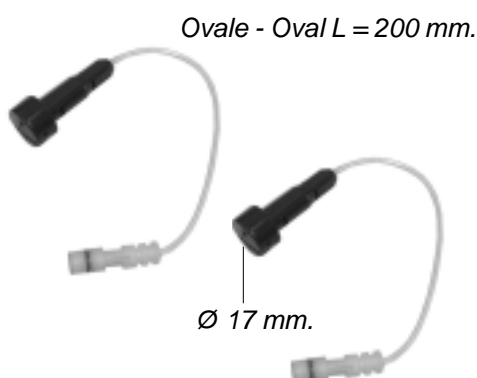

ILLUSTRAZIONE / ILLUSTRATION

NOSTRO RIFERIMENTO
OUR REFERENCE**960810**RIFERIMENTO COSTRUTTORE
O.E. REFERENCE

6775400817

DESCRIZIONE / DESCRIPTION

Kit segnalatori usura freno anteriore e posteriore (2 pz.)
Set of brake wear indicators front and rear (2 pcs)

TIPO DI VEICOLO / VEHICLE TYPE

MERCEDES

ATEGO I 917-923-1017-1023

ATEGO II 915-918-922-923 - 1016-1018-1022-1023

ILLUSTRAZIONE / ILLUSTRATION	NOSTRO RIFERIMENTO OUR REFERENCE	RIFERIMENTO COSTRUTTORE O.E. REFERENCE								
	960346	9704230212								
DESCRIZIONE / DESCRIPTION										
<p>Disco freno assale posteriore Brake disc rear axle</p> <p>Fascia AUTOVENTILANTE SELF-VENTILATED Band</p>										
ILLUSTRAZIONE / ILLUSTRATION	NOSTRO RIFERIMENTO OUR REFERENCE	RIFERIMENTO COSTRUTTORE O.E. REFERENCE								
	960998	0034201120 0034201220								
DESCRIZIONE / DESCRIPTION										
<p>Serie pastiglie freno anteriore e posteriore Set of brake pads front and rear</p> <table border="1"> <thead> <tr> <th>WVA</th> <th>Larghezza Width - mm.</th> <th>Altezza Height - mm.</th> <th>Spessore Thickness - mm.</th> </tr> </thead> <tbody> <tr> <td>29115 29148</td> <td>173,60</td> <td>84</td> <td>27/34</td> </tr> </tbody> </table>			WVA	Larghezza Width - mm.	Altezza Height - mm.	Spessore Thickness - mm.	29115 29148	173,60	84	27/34
WVA	Larghezza Width - mm.	Altezza Height - mm.	Spessore Thickness - mm.							
29115 29148	173,60	84	27/34							
ILLUSTRAZIONE / ILLUSTRATION	NOSTRO RIFERIMENTO OUR REFERENCE	RIFERIMENTO COSTRUTTORE O.E. REFERENCE								
	960810	6775400817								
DESCRIZIONE / DESCRIPTION										
<p>Kit segnalatori usura freno anteriore e posteriore (2 pz.) Set of brake wear indicators front and rear (2 pcs)</p>										

TIPO DI VEICOLO / VEHICLE TYPE

MERCEDES

ATEGO I 1215 - 1217 - 1223 - 1225 - 1228 (01/98)

ATEGO I 1317 - 1323 - 1325 - 1328 (01/98)

ATEGO I 1517 - 1523 - 1525 - 1528 (01/98)

ILLUSTRAZIONE / ILLUSTRATION	NOSTRO RIFERIMENTO OUR REFERENCE	RIFERIMENTO COSTRUTTORE O.E. REFERENCE								
	960339	9754210112								
DESCRIZIONE / DESCRIPTION										
<p>Disco freno assale anteriore Brake disc front axle</p> <p>Fascia AUTOVENTILANTE SELF-VENTILATED Band</p> 										
ILLUSTRAZIONE / ILLUSTRATION	NOSTRO RIFERIMENTO OUR REFERENCE	RIFERIMENTO COSTRUTTORE O.E. REFERENCE								
 <p style="text-align: right;">E3 90R</p>	960948	0024207820 - 0004210710								
DESCRIZIONE / DESCRIPTION										
<p>Serie pastiglie freno anteriore completa di molle, kit accessori SENZA piastre Set of brake pads front with springs Kit accessories WITHOUT plates</p>										
<p>Serie pastiglie freno anteriore completa di molle, kit accessori e piastre Set of brake pads front with springs, kit accessories and plates</p> <table border="1" data-bbox="646 1583 1236 1720"> <thead> <tr> <th>WVA</th> <th>Larghezza Width - mm.</th> <th>Altezza Height - mm.</th> <th>Spessore Thickness - mm.</th> </tr> </thead> <tbody> <tr> <td>29095</td> <td>211</td> <td>92.5</td> <td>30</td> </tr> </tbody> </table> 			WVA	Larghezza Width - mm.	Altezza Height - mm.	Spessore Thickness - mm.	29095	211	92.5	30
WVA	Larghezza Width - mm.	Altezza Height - mm.	Spessore Thickness - mm.							
29095	211	92.5	30							
ILLUSTRAZIONE / ILLUSTRATION	NOSTRO RIFERIMENTO OUR REFERENCE	RIFERIMENTO COSTRUTTORE O.E. REFERENCE								
	960810	6775400817								
DESCRIZIONE / DESCRIPTION										
<p>Kit segnalatori usura freno anteriore e posteriore (2 pz.) Set of brake wear indicators front and rear (2 pcs)</p>										

TIPO DI VEICOLO / VEHICLE TYPE

MERCEDES

ATEGO I 1215 - 1217 - 1223 - 1225 - 1228 (01/98)

ATEGO I 1317 - 1323 - 1325 - 1328 (01/98)

ATEGO I 1517 - 1523 - 1525 - 1528 (01/98)

ILLUSTRAZIONE / ILLUSTRATION	NOSTRO RIFERIMENTO OUR REFERENCE	RIFERIMENTO COSTRUTTORE O.E. REFERENCE								
	960341	9754230612 (ex 9754230312)								
DESCRIZIONE / DESCRIPTION										
<p>Disco freno assale posteriore Brake disc rear axle</p> <p>Fascia AUTOVENTILANTE SELF-VENTILATED Band</p>										
ILLUSTRAZIONE / ILLUSTRATION	NOSTRO RIFERIMENTO OUR REFERENCE	RIFERIMENTO COSTRUTTORE O.E. REFERENCE								
	960948	0024207820 - 0004210710								
DESCRIZIONE / DESCRIPTION										
<p>Serie pastiglie freno anteriore completa di molle, kit accessori SENZA piastre Set of brake pads front with springs, kit accessories without plates</p>										
960948/C										
<p>Serie pastiglie freno anteriore completa di molle, kit accessori e piastre Set of brake pads front with springs, kit accessories and plates</p> <table border="1"> <thead> <tr> <th>WVA</th> <th>Larghezza Width - mm.</th> <th>Altezza Height - mm.</th> <th>Spessore Thickness - mm.</th> </tr> </thead> <tbody> <tr> <td>29095</td> <td>211</td> <td>92.5</td> <td>30</td> </tr> </tbody> </table>			WVA	Larghezza Width - mm.	Altezza Height - mm.	Spessore Thickness - mm.	29095	211	92.5	30
WVA	Larghezza Width - mm.	Altezza Height - mm.	Spessore Thickness - mm.							
29095	211	92.5	30							
ILLUSTRAZIONE / ILLUSTRATION	NOSTRO RIFERIMENTO OUR REFERENCE	RIFERIMENTO COSTRUTTORE O.E. REFERENCE								
	960810	6775400817								
DESCRIZIONE / DESCRIPTION										
<p>Kit segnalatori usura freno anteriore e posteriore (2 pz.) Set of brake wear indicators front and rear (2 pcs)</p>										

TIPO DI VEICOLO / VEHICLE TYPE

MERCEDES ACTROS 22,5''

1831 - 1835 - 1840 - 1843 - 1848 - 1853 - 1857
 2031 - 2035 - 2040 - 2053
 2531 - 2535 - 2540 - 2543 - 2548 - 2553 - 2557
 2631 - 2635 - 2640 - 2643 - 2648 - 2653
 3331 - 3335 - 3340 - 3343 - 3348 - 3353 - 3357

MERCEDES ATEGO

1823 - 1828 - 2523 - 2528 - 2628

MERCEDES AXOR

2543 - 2540 - 2535 - 1843 - 1840
 1835





ILLUSTRAZIONE / ILLUSTRATION	NOSTRO RIFERIMENTO OUR REFERENCE	RIFERIMENTO COSTRUTTORE O.E. REFERENCE
	960316	9424212112 9424211212
DESCRIZIONE / DESCRIPTION		
<p>Disco freno assale anteriore e posteriore Brake disc front and rear axle</p> <p>Fascia AUTOVENTILANTE SELF-VENTILATED Band</p> 		

ILLUSTRAZIONE / ILLUSTRATION	NOSTRO RIFERIMENTO OUR REFERENCE	RIFERIMENTO COSTRUTTORE O.E. REFERENCE																				
	960944	0034201620 - 0034202220																				
DESCRIZIONE / DESCRIPTION																						
<p>Serie pastiglie freno anteriore e posteriore completa di molle, kit accessori SENZA piastre Set of brake pads front and rear with springs, kit accessories without plates</p>																						
BREVETTO PENDENTE PENDING PATENT																						
	<table border="1"> <thead> <tr> <th>WVA</th> <th>Larghezza Width - mm.</th> <th>Altezza Height - mm.</th> <th>Spessore Thickness - mm.</th> </tr> </thead> <tbody> <tr> <td>29087</td> <td>247,2</td> <td>109,7</td> <td>30</td> </tr> <tr> <td>29105</td> <td></td> <td></td> <td></td> </tr> <tr> <td>29108</td> <td></td> <td></td> <td></td> </tr> <tr> <td>29059</td> <td></td> <td></td> <td></td> </tr> </tbody> </table>	WVA	Larghezza Width - mm.	Altezza Height - mm.	Spessore Thickness - mm.	29087	247,2	109,7	30	29105				29108				29059				
WVA	Larghezza Width - mm.	Altezza Height - mm.	Spessore Thickness - mm.																			
29087	247,2	109,7	30																			
29105																						
29108																						
29059																						
																						

E3 90R

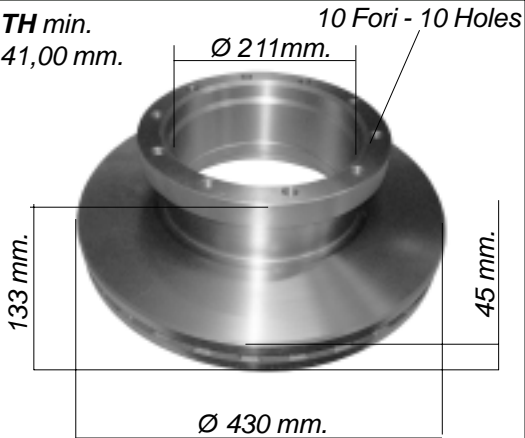
TIPO DI VEICOLO / VEHICLE TYPE

MERCEDES ACTROS 22,5"

1831 - 1835 - 1840 - 1843 - 1848 - 1853 - 1857
2031 - 2035 - 2040 - 2053
2531 - 2535 - 2540 - 2543 - 2548 - 2553 - 2557
2631 - 2635 - 2640 - 2643 - 2648 - 2653
3331 - 3335 - 3340 - 3343 - 3348 - 3353 - 3357

MERCEDES ATEGO

1823 - 1828 - 2523 - 2528 - 2628

MERCEDES AXOR

2543 - 2540 - 2535 - 1843 - 1840
1835

ILLUSTRAZIONE / ILLUSTRATION



E3 90R

NOSTRO RIFERIMENTO OUR REFERENCE

960944/C

RIFERIMENTO COSTRUTTORE O.E. REFERENCE

-

DESCRIZIONE / DESCRIPTION

Serie pastiglie freno anteriore e posteriore **completa** di molle, kit accessori e piastre
Set of brake pads front and rear with springs, kit accessories and plates

**BREVETTO PENDENTE
PENDING PATENT**

WVA	Larghezza Width - mm.	Altezza Height - mm.	Spessore Thickness - mm.
29087	247,2	109,7	30
29105			
29108			
29059			
29061			



ILLUSTRAZIONE / ILLUSTRATION

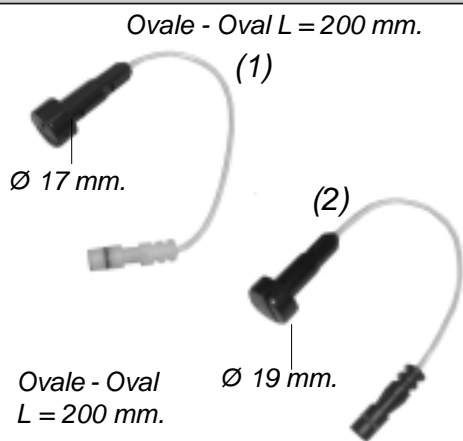

NOSTRO RIFERIMENTO OUR REFERENCE

960810

960808

RIFERIMENTO COSTRUTTORE O.E. REFERENCE

6775400817 (1)

6775400717 (2)

DESCRIZIONE / DESCRIPTION

Kit segnalatori usura freno anteriore e posteriore (2 pz.)
Set of brake wear indicators front and rear (2 pcs)

TIPO DI VEICOLO / VEHICLE TYPE

MERCEDES ACTROS
 NUOVO MODELLO DAL 2008
 NEW MODEL FROM 2008

ILLUSTRAZIONE / ILLUSTRATION

NOSTRO RIFERIMENTO
OUR REFERENCERIFERIMENTO COSTRUTTORE
O.E. REFERENCE**960317**

9434210312

DESCRIZIONE / DESCRIPTION

Disco freno assale anteriore e posteriore
 Brake disc front and rear axle

Fascia AUTOVENTILANTE
 SELF-VENTILATED Band



ILLUSTRAZIONE / ILLUSTRATION

NOSTRO RIFERIMENTO
OUR REFERENCERIFERIMENTO COSTRUTTORE
O.E. REFERENCE**960944**

0034201620 - 0034202220

DESCRIZIONE / DESCRIPTION

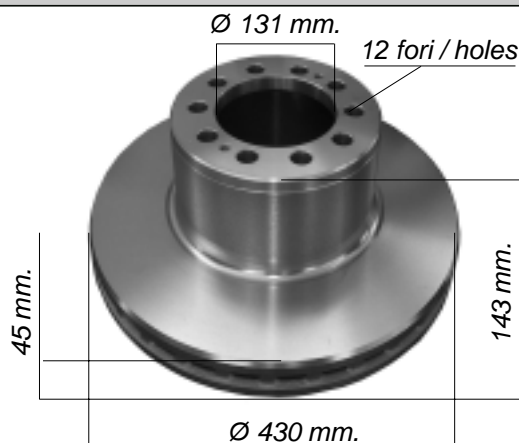
Serie pastiglie freno anteriore e posteriore completa di molle,
 kit accessori **SENZA** piastre
 Set of brake pads front and rear with springs,
 kit accessories without plates



BREVETTO PENDENTE
PENDING PATENT

WVA	Larghezza Width - mm.	Altezza Height - mm.	Spessore Thickness - mm.
29087	247,2	109,7	30
29105			
29108			
29059			
29061			

E3 90R



TIPO DI VEICOLO / VEHICLE TYPE

MERCEDES ACTROS
NUOVO MODELLO DAL 2008
NEW MODEL FROM 2008

ILLUSTRAZIONE / ILLUSTRATION

NOSTRO RIFERIMENTO
OUR REFERENCE

RIFERIMENTO COSTRUTTORE
O.E. REFERENCE

960944/C

-

DESCRIZIONE / DESCRIPTION

Serie pastiglie freno anteriore e posteriore **completa di molle, kit accessori e piastre**
Set of brake pads front and rear with springs, kit accessories and plates



E3 90R

BREVETTO PENDENTE

PENDING PATENT

WVA	Larghezza Width - mm.	Altezza Height - mm.	Spessore Thickness - mm.
29087	247,2	109,7	30
29105			
29108			
29059			
29061			



ILLUSTRAZIONE / ILLUSTRATION

NOSTRO RIFERIMENTO
OUR REFERENCE

RIFERIMENTO COSTRUTTORE
O.E. REFERENCE

Ovale - Oval L = 200 mm.

(1)

960810

6775400817 (1)

Ø 17 mm.

(2)

960808

6775400717 (2)

Ovale - Oval
L = 200 mm.





Ø 19 mm.

DESCRIZIONE / DESCRIPTION

Kit segnalatori usura freno anteriore e posteriore (2 pz.)
Set of brake wear indicators front and rear (2 pcs)

TIPO DI VEICOLO / VEHICLE TYPE

NISSAN
TRADE - CABSTAR

ILLUSTRAZIONE / ILLUSTRATION	NOSTRO RIFERIMENTO OUR REFERENCE	RIFERIMENTO COSTRUTTORE O.E. REFERENCE																
<p>TH min. 22,40 mm.</p> <p>5 Fori - 5 Holes</p> <p>Ø 96 mm.</p> <p>53 mm.</p> <p>24 mm.</p> <p>Ø 263 mm.</p> 	960055	40206F3902																
DESCRIZIONE / DESCRIPTION																		
<p>Disco freno assale anteriore Brake disc front axle</p> <p>Fascia AUTOVENTILANTE SELF-VENTILATED Band</p> 																		
ILLUSTRAZIONE / ILLUSTRATION	NOSTRO RIFERIMENTO OUR REFERENCE	RIFERIMENTO COSTRUTTORE O.E. REFERENCE																
	960872	-06903100-0																
DESCRIZIONE / DESCRIPTION																		
<p>Serie pastiglie freno anteriore Set of brake pads front</p> <table border="1" data-bbox="646 1456 1236 1624"> <thead> <tr> <th>WVA</th> <th>Larghezza Width - mm.</th> <th>Altezza Height - mm.</th> <th>Spessore Thickness - mm</th> </tr> </thead> <tbody> <tr> <td>29034</td> <td>166</td> <td>62</td> <td>17</td> </tr> <tr> <td>29035</td> <td></td> <td></td> <td></td> </tr> <tr> <td>29706</td> <td></td> <td></td> <td></td> </tr> </tbody> </table> 			WVA	Larghezza Width - mm.	Altezza Height - mm.	Spessore Thickness - mm	29034	166	62	17	29035				29706			
WVA	Larghezza Width - mm.	Altezza Height - mm.	Spessore Thickness - mm															
29034	166	62	17															
29035																		
29706																		
ILLUSTRAZIONE / ILLUSTRATION	NOSTRO RIFERIMENTO OUR REFERENCE	RIFERIMENTO COSTRUTTORE O.E. REFERENCE																
DESCRIZIONE / DESCRIPTION																		

TIPO DI VEICOLO / VEHICLE TYPE

NISSAN
CABSTAR
ECO T100 - ATLEON 100-120

ILLUSTRAZIONE / ILLUSTRATION

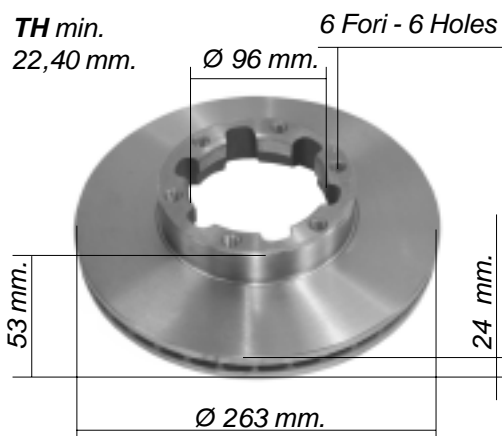

NOSTRO RIFERIMENTO
OUR REFERENCE

960056

RIFERIMENTO COSTRUTTORE
O.E. REFERENCE

40206F3901

DESCRIZIONE / DESCRIPTION

Disco freno assale anteriore
Brake disc front axle

Fascia AUTOVENTILANTE
SELF-VENTILATED Band



ILLUSTRAZIONE / ILLUSTRATION



NOSTRO RIFERIMENTO
OUR REFERENCE

960872

RIFERIMENTO COSTRUTTORE
O.E. REFERENCE

-06903100-0

DESCRIZIONE / DESCRIPTION

Serie pastiglie freno anteriore
Set of brake pads front

WVA	Larghezza Width - mm.	Altezza Height - mm.	Spessore Thickness - mm
29034	166	62	17
29035			
29706			



ILLUSTRAZIONE / ILLUSTRATION

NOSTRO RIFERIMENTO
OUR REFERENCE

RIFERIMENTO COSTRUTTORE
O.E. REFERENCE

DESCRIZIONE / DESCRIPTION

TIPO DI VEICOLO / VEHICLE TYPE

NISSAN
CABSTAR 120 U.T.

ILLUSTRAZIONE / ILLUSTRATION

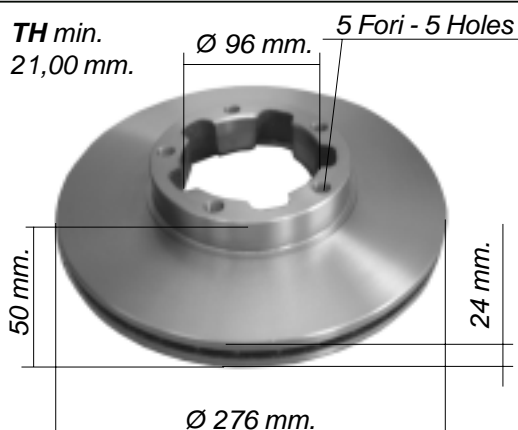
NOSTRO RIFERIMENTO
OUR REFERENCE

960059

RIFERIMENTO COSTRUTTORE
O.E. REFERENCE

402069X200

DESCRIZIONE / DESCRIPTION

Disco freno assale anteriore
Brake disc front axleFascia AUTOVENTILANTE
SELF-VENTILATED Band

ILLUSTRAZIONE / ILLUSTRATION

NOSTRO RIFERIMENTO
OUR REFERENCE

960874

RIFERIMENTO COSTRUTTORE
O.E. REFERENCE

410609X226

DESCRIZIONE / DESCRIPTION

Serie pastiglie freno anteriore e posteriore
Set of brake pads front and rear

WVA	Larghezza Width - mm.	Altezza Height - mm.	Spessore Thickness - mm
23435	169	65	18



ILLUSTRAZIONE / ILLUSTRATION

NOSTRO RIFERIMENTO
OUR REFERENCERIFERIMENTO COSTRUTTORE
O.E. REFERENCE

DESCRIZIONE / DESCRIPTION

TIPO DI VEICOLO / VEHICLE TYPE

NISSAN
ATLEON 120 (DAL / FROM 05-2003)

ILLUSTRAZIONE / ILLUSTRATION

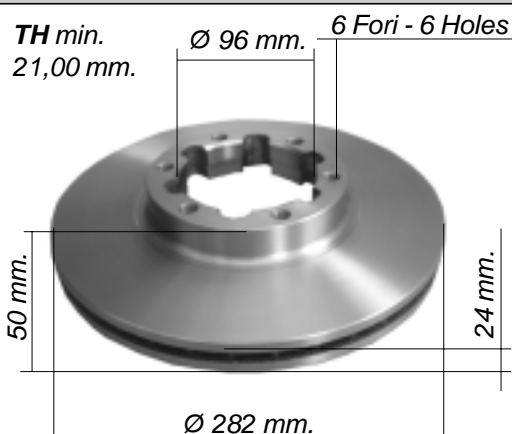

**NOSTRO RIFERIMENTO
OUR REFERENCE**

960057

**RIFERIMENTO COSTRUTTORE
O.E. REFERENCE**

432069X401

DESCRIZIONE / DESCRIPTION

Disco freno assale anteriore
Brake disc front axle

Fascia AUTOVENTILANTE
SELF-VENTILATED Band



ILLUSTRAZIONE / ILLUSTRATION



**NOSTRO RIFERIMENTO
OUR REFERENCE**

960875

**RIFERIMENTO COSTRUTTORE
O.E. REFERENCE**

410609X126

DESCRIZIONE / DESCRIPTION

Serie pastiglie freno anteriore e posteriore
Set of brake pads front and rear

WVA	Larghezza Width - mm.	Altezza Height - mm.	Spessore Thickness - mm
29121	164,8	66,5	20,3



ILLUSTRAZIONE / ILLUSTRATION

**NOSTRO RIFERIMENTO
OUR REFERENCE**

**RIFERIMENTO COSTRUTTORE
O.E. REFERENCE**

DESCRIZIONE / DESCRIPTION

TIPO DI VEICOLO / VEHICLE TYPE

NISSAN
ATLEON 120 (DAL / FROM 05-2003)

ILLUSTRAZIONE / ILLUSTRATION	NOSTRO RIFERIMENTO OUR REFERENCE	RIFERIMENTO COSTRUTTORE O.E. REFERENCE								
<p>TH min. 19,00 mm.</p> <p>Ø 110 mm.</p> <p>8 Fori - 8 Holes</p>  <p>78 mm.</p> <p>22 mm.</p> <p>Ø 290 mm.</p>	960058	402079X100								
DESCRIZIONE / DESCRIPTION										
<p>Disco freno posteriore Brake disc rear</p> <p>Fascia AUTOVENTILANTE SELF-VENTILATED Band</p> 										
ILLUSTRAZIONE / ILLUSTRATION	NOSTRO RIFERIMENTO OUR REFERENCE	RIFERIMENTO COSTRUTTORE O.E. REFERENCE								
 <p>TECHNO BRAKE</p> <p>E3 90R</p>	960875	410609X126								
DESCRIZIONE / DESCRIPTION										
<p>Serie pastiglie freno anteriore e posteriore Set of brake pads front and rear</p> <table border="1"> <thead> <tr> <th>WVA</th> <th>Larghezza Width - mm.</th> <th>Altezza Height - mm.</th> <th>Spessore Thickness - mm</th> </tr> </thead> <tbody> <tr> <td>29121</td> <td>164,8</td> <td>66,5</td> <td>20,3</td> </tr> </tbody> </table> 			WVA	Larghezza Width - mm.	Altezza Height - mm.	Spessore Thickness - mm	29121	164,8	66,5	20,3
WVA	Larghezza Width - mm.	Altezza Height - mm.	Spessore Thickness - mm							
29121	164,8	66,5	20,3							
ILLUSTRAZIONE / ILLUSTRATION	NOSTRO RIFERIMENTO OUR REFERENCE	RIFERIMENTO COSTRUTTORE O.E. REFERENCE								
DESCRIZIONE / DESCRIPTION										

TIPO DI VEICOLO / VEHICLE TYPE

NISSAN
ATLEON 120 DAL / FROM 2004

ILLUSTRAZIONE / ILLUSTRATION

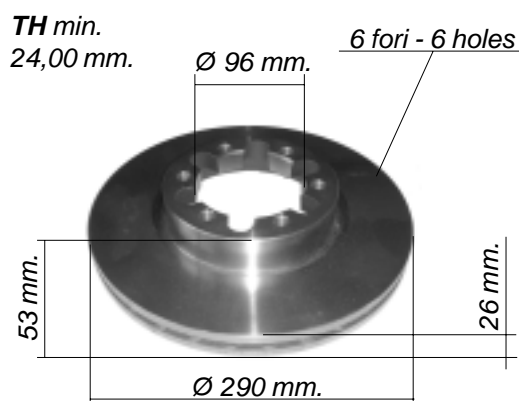

NOSTRO RIFERIMENTO
OUR REFERENCE

960522

RIFERIMENTO COSTRUTTORE
O.E. REFERENCE

402069X403

DESCRIZIONE / DESCRIPTION

Disco freno anteriore
Brake disc front

Fascia AUTOVENTILANTE
SELF-VENTILATED Band



ILLUSTRAZIONE / ILLUSTRATION



NOSTRO RIFERIMENTO
OUR REFERENCE

960875

RIFERIMENTO COSTRUTTORE
O.E. REFERENCE

410609X126

DESCRIZIONE / DESCRIPTION

Serie pastiglie freno anteriore e posteriore
Set of brake pads front and rear

WVA	Larghezza Width - mm.	Altezza Height - mm.	Spessore Thickness - mm
29121	164,8	66,5	20,3



ILLUSTRAZIONE / ILLUSTRATION

NOSTRO RIFERIMENTO
OUR REFERENCE

RIFERIMENTO COSTRUTTORE
O.E. REFERENCE

DESCRIZIONE / DESCRIPTION

TIPO DI VEICOLO / VEHICLE TYPE

NISSAN
ATLEON 140 U.T.

(CON ABS - WITH ABS)

ILLUSTRAZIONE / ILLUSTRATION

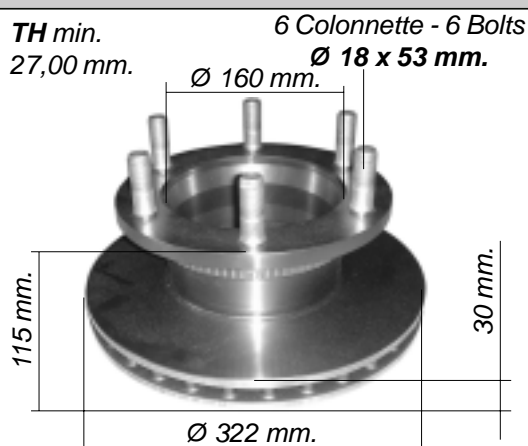
NOSTRO RIFERIMENTO
OUR REFERENCE

960526

RIFERIMENTO COSTRUTTORE
O.E. REFERENCE

402069X407

DESCRIZIONE / DESCRIPTION

Disco freno anteriore
Brake disc frontFascia AUTOVENTILANTE
SELF-VENTILATED Band

ILLUSTRAZIONE / ILLUSTRATION

NOSTRO RIFERIMENTO
OUR REFERENCE

960947

RIFERIMENTO COSTRUTTORE
O.E. REFERENCE

-06902964-0

DESCRIZIONE / DESCRIPTION

Serie pastiglie freno anteriore e posteriore
Set of brake pads front and rear

WVA	Larghezza Width - mm.	Altezza Height - mm.	Spessore Thickness - mm
29039	175	78	22
21302			
29302			



ILLUSTRAZIONE / ILLUSTRATION

NOSTRO RIFERIMENTO
OUR REFERENCERIFERIMENTO COSTRUTTORE
O.E. REFERENCE

DESCRIZIONE / DESCRIPTION

TIPO DI VEICOLO / VEHICLE TYPE

NISSAN

ATLEON 140 U.T. (POSTERIORE - REAR)

NISSAN ATLEON 160 - 165 - 210 (DAL 09/99 - FROM 09/99)

(CON ABS - WITH ABS)

ILLUSTRAZIONE / ILLUSTRATION

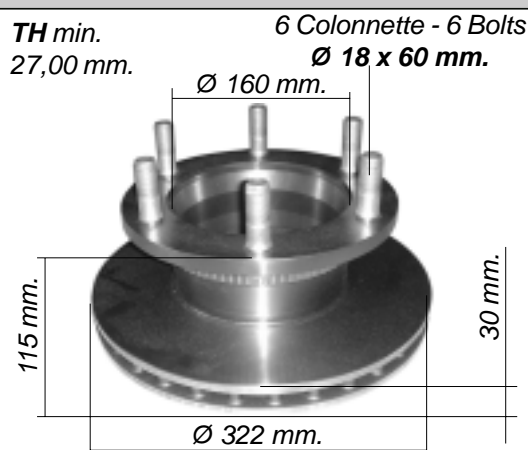

NOSTRO RIFERIMENTO
OUR REFERENCE

960527

RIFERIMENTO COSTRUTTORE
O.E. REFERENCE

402069X001

DESCRIZIONE / DESCRIPTION

Disco freno anteriore e posteriore
Brake disc front and rear axle

Fascia AUTOVENTILANTE
SELF-VENTILATED Band



ILLUSTRAZIONE / ILLUSTRATION



NOSTRO RIFERIMENTO
OUR REFERENCE

960947

RIFERIMENTO COSTRUTTORE
O.E. REFERENCE

-06902964-0

DESCRIZIONE / DESCRIPTION

Serie pastiglie freno anteriore e posteriore
Set of brake pads front and rear

WVA	Larghezza Width - mm.	Altezza Height - mm.	Spessore Thickness - mm
29039	175	78	22
21302			
29302			



ILLUSTRAZIONE / ILLUSTRATION

NOSTRO RIFERIMENTO
OUR REFERENCE

RIFERIMENTO COSTRUTTORE
O.E. REFERENCE

DESCRIZIONE / DESCRIPTION

TIPO DI VEICOLO / VEHICLE TYPE

NISSAN

ECO T135 - ATLEON 140 - ECO L60 - ECO L70

(SENZA ABS - WITHOUT ABS)

ILLUSTRAZIONE / ILLUSTRATION

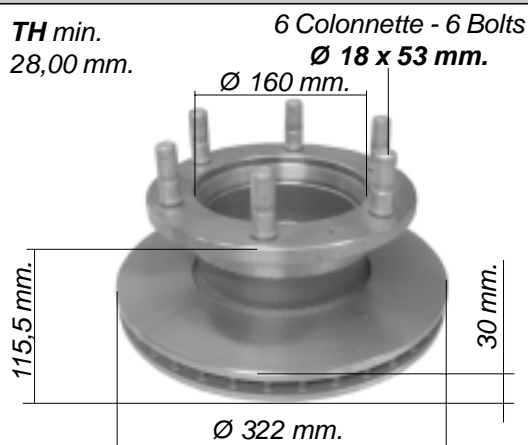
NOSTRO RIFERIMENTO
OUR REFERENCE**960235**RIFERIMENTO COSTRUTTORE
O.E. REFERENCE

-06100420-0

DESCRIZIONE / DESCRIPTION

Disco freno anteriore
Brake disc frontFascia AUTOVENTILANTE
SELF-VENTILATED Band

ILLUSTRAZIONE / ILLUSTRATION

NOSTRO RIFERIMENTO
OUR REFERENCE**960947**RIFERIMENTO COSTRUTTORE
O.E. REFERENCE

-06902964-0

DESCRIZIONE / DESCRIPTION

Serie pastiglie freno anteriore e posteriore
Set of brake pads front and rear

WVA	Larghezza Width - mm.	Altezza Height - mm.	Spessore Thickness - mm
29039	175	78	22
21302			
29302			



ILLUSTRAZIONE / ILLUSTRATION

NOSTRO RIFERIMENTO
OUR REFERENCERIFERIMENTO COSTRUTTORE
O.E. REFERENCE

DESCRIZIONE / DESCRIPTION

TIPO DI VEICOLO / VEHICLE TYPE

NISSAN

ECO T135 - ATLEON 140 - ECO L60 - ECO L70

(SENZA ABS - WITHOUT ABS)

ILLUSTRAZIONE / ILLUSTRATION

NOSTRO RIFERIMENTO OUR REFERENCE

RIFERIMENTO COSTRUTTORE O.E. REFERENCE

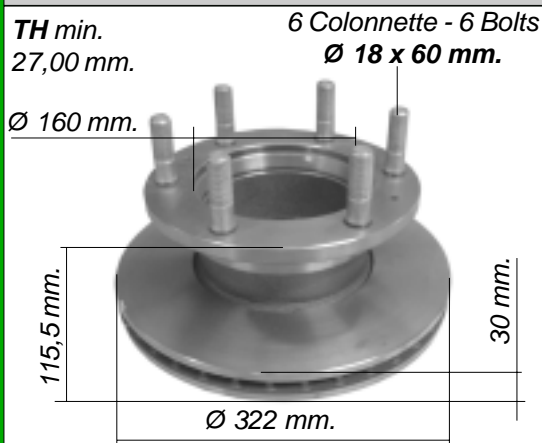

960236

-06200438-0

DESCRIZIONE / DESCRIPTION

Disco freno posteriore
Brake disc rear

Fascia AUTOVENTILANTE
SELF-VENTILATED Band



ILLUSTRAZIONE / ILLUSTRATION

NOSTRO RIFERIMENTO OUR REFERENCE

RIFERIMENTO COSTRUTTORE O.E. REFERENCE



960947

-06902964-0

DESCRIZIONE / DESCRIPTION

Serie pastiglie freno anteriore e posteriore
Set of brake pads front and rear

WVA	Larghezza Width - mm.	Altezza Height - mm.	Spessore Thickness - mm
29039	175	78	22
21302			
29302			



ILLUSTRAZIONE / ILLUSTRATION

NOSTRO RIFERIMENTO OUR REFERENCE

RIFERIMENTO COSTRUTTORE O.E. REFERENCE

DESCRIZIONE / DESCRIPTION

TIPO DI VEICOLO / VEHICLE TYPE

NISSAN
ECO T 160

ILLUSTRAZIONE / ILLUSTRATION

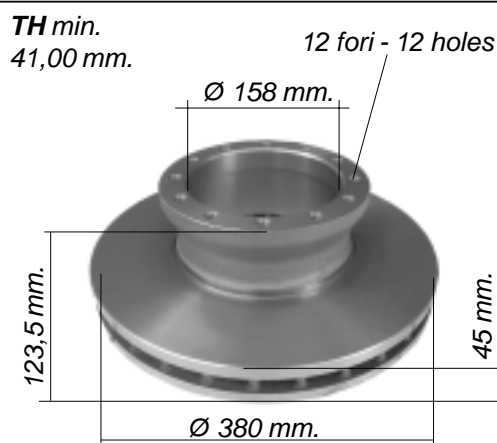
NOSTRO RIFERIMENTO
OUR REFERENCERIFERIMENTO COSTRUTTORE
O.E. REFERENCE**960054**

40206D9200

DESCRIZIONE / DESCRIPTION

Disco freno anteriore
Brake disc frontFascia AUTOVENTILANTE
SELF-VENTILATED Band

ILLUSTRAZIONE / ILLUSTRATION

NOSTRO RIFERIMENTO
OUR REFERENCERIFERIMENTO COSTRUTTORE
O.E. REFERENCE**960947**

-06902964-0

DESCRIZIONE / DESCRIPTION

Serie pastiglie freno anteriore e posteriore
Set of brake pads front and rear

WVA	Larghezza Width - mm.	Altezza Height - mm.	Spessore Thickness - mm
29039	175	78	22
21302			
29302			



ILLUSTRAZIONE / ILLUSTRATION

NOSTRO RIFERIMENTO
OUR REFERENCERIFERIMENTO COSTRUTTORE
O.E. REFERENCE

DESCRIZIONE / DESCRIPTION

TIPO DI VEICOLO / VEHICLE TYPE

MOVANO	(Ruota da 16")
COMBI	1.9DTI - 2.2DTI - 2.5DTI - 2.5D
FURGONATO	1.9DTI - 2.2DTI - 2.5DTI - 2.8DTI - 2.5D
PIANALE PIATTO	2.2DTI - 2.5DTI - 2.8DTI

ILLUSTRAZIONE / ILLUSTRATION	NOSTRO RIFERIMENTO OUR REFERENCE	RIFERIMENTO COSTRUTTORE O.E. REFERENCE								
	960233	4403038								
DESCRIZIONE / DESCRIPTION										
<p>Disco freno assale anteriore Brake disc front axle</p> <p>Fascia AUTOVENTILANTE SELF-VENTILATED Band</p>										
ILLUSTRAZIONE / ILLUSTRATION	NOSTRO RIFERIMENTO OUR REFERENCE	RIFERIMENTO COSTRUTTORE O.E. REFERENCE								
	960986	4502797 4501150								
DESCRIZIONE / DESCRIPTION										
<p>Serie pastiglie freno anteriore Set of brake pads front</p> <table border="1"> <thead> <tr> <th>WVA</th> <th>Larghezza Width - mm.</th> <th>Altezza Height - mm.</th> <th>Spessore Thickness - mm</th> </tr> </thead> <tbody> <tr> <td>23302</td> <td>139</td> <td>68</td> <td>18</td> </tr> </tbody> </table>			WVA	Larghezza Width - mm.	Altezza Height - mm.	Spessore Thickness - mm	23302	139	68	18
WVA	Larghezza Width - mm.	Altezza Height - mm.	Spessore Thickness - mm							
23302	139	68	18							
ILLUSTRAZIONE / ILLUSTRATION	NOSTRO RIFERIMENTO OUR REFERENCE	RIFERIMENTO COSTRUTTORE O.E. REFERENCE								
DESCRIZIONE / DESCRIPTION										

TIPO DI VEICOLO / VEHICLE TYPE

MOVANO

COMBI	1.9DTI - 2.2DTI - 2.5DTI - 2.5D
FURGONATO	1.9DTI - 2.2DTI - 2.5DTI - 2.8DTI - 2.5D
PIANALE PIATTO	2.2DTI - 2.5DTI - 2.8DTI

ILLUSTRAZIONE / ILLUSTRATION	NOSTRO RIFERIMENTO OUR REFERENCE	RIFERIMENTO COSTRUTTORE O.E. REFERENCE								
	960231	4403045								
DESCRIZIONE / DESCRIPTION										
Disco freno assale posteriore Brake disc rear axle 										
ILLUSTRAZIONE / ILLUSTRATION	NOSTRO RIFERIMENTO OUR REFERENCE	RIFERIMENTO COSTRUTTORE O.E. REFERENCE								
	960985	4403467								
DESCRIZIONE / DESCRIPTION										
Serie pastiglie freno posteriore Set of brake pads rear <table border="1" data-bbox="644 1451 1233 1621"> <thead> <tr> <th>WVA</th> <th>Larghezza Width - mm.</th> <th>Altezza Height - mm.</th> <th>Spessore Thickness - mm</th> </tr> </thead> <tbody> <tr> <td>23669</td> <td>115.8</td> <td>51.3</td> <td>16.8</td> </tr> </tbody> </table>  			WVA	Larghezza Width - mm.	Altezza Height - mm.	Spessore Thickness - mm	23669	115.8	51.3	16.8
WVA	Larghezza Width - mm.	Altezza Height - mm.	Spessore Thickness - mm							
23669	115.8	51.3	16.8							
ILLUSTRAZIONE / ILLUSTRATION	NOSTRO RIFERIMENTO OUR REFERENCE	RIFERIMENTO COSTRUTTORE O.E. REFERENCE								
DESCRIZIONE / DESCRIPTION										

TIPO DI VEICOLO / VEHICLE TYPE

MASTER
DAL / FROM 11-1997

ILLUSTRAZIONE / ILLUSTRATION

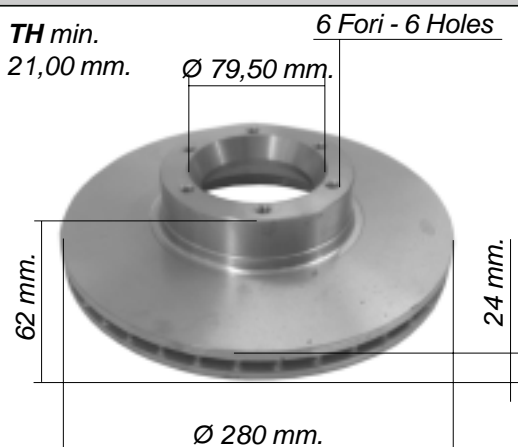

NOSTRO RIFERIMENTO
OUR REFERENCE

960234

RIFERIMENTO COSTRUTTORE
O.E. REFERENCE

7700302128

DESCRIZIONE / DESCRIPTION

Disco freno assale anteriore
Brake disc front axle

Fascia AUTOVENTILANTE
SELF-VENTILATED Band



ILLUSTRAZIONE / ILLUSTRATION

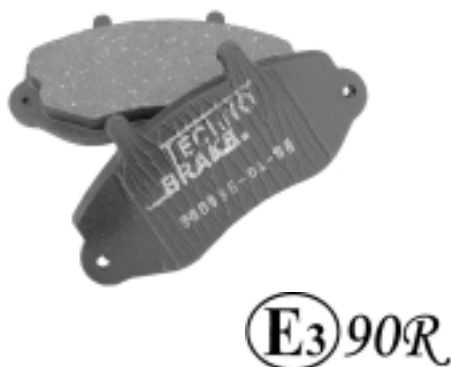

NOSTRO RIFERIMENTO
OUR REFERENCE

960986

RIFERIMENTO COSTRUTTORE
O.E. REFERENCE

7701207166

DESCRIZIONE / DESCRIPTION

Serie pastiglie freno anteriore
Set of brake pads front

WVA	Larghezza Width - mm.	Altezza Height - mm.	Spessore Thickness - mm.
23302	139	68	18



ILLUSTRAZIONE / ILLUSTRATION

NOSTRO RIFERIMENTO
OUR REFERENCE

RIFERIMENTO COSTRUTTORE
O.E. REFERENCE

DESCRIZIONE / DESCRIPTION

TIPO DI VEICOLO / VEHICLE TYPE

MASTER DAL / FROM 11-1997
MASTER II DAL / FROM 10-2003

ILLUSTRAZIONE / ILLUSTRATION

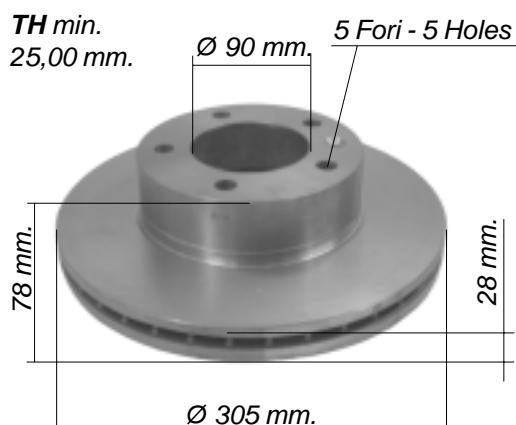
NOSTRO RIFERIMENTO
OUR REFERENCE

960233

RIFERIMENTO COSTRUTTORE
O.E. REFERENCE

7700314064

DESCRIZIONE / DESCRIPTION

Disco freno assale anteriore
Brake disc front axle

Fascia AUTOVENTILANTE
SELF-VENTILATED Band



ILLUSTRAZIONE / ILLUSTRATION

NOSTRO RIFERIMENTO
OUR REFERENCE

960988

RIFERIMENTO COSTRUTTORE
O.E. REFERENCE

7701207339

DESCRIZIONE / DESCRIPTION

Serie pastiglie freno anteriore
Set of brake pads front

WVA	Larghezza Width - mm.	Altezza Height - mm.	Spessore Thickness - mm.
23613	138,8	79,7	17,6



ILLUSTRAZIONE / ILLUSTRATION

NOSTRO RIFERIMENTO
OUR REFERENCERIFERIMENTO COSTRUTTORE
O.E. REFERENCE

DESCRIZIONE / DESCRIPTION

TIPO DI VEICOLO / VEHICLE TYPE

MASTER DAL / FROM 11-1997
MASTER II DAL / FROM 10-2003

ILLUSTRAZIONE / ILLUSTRATION

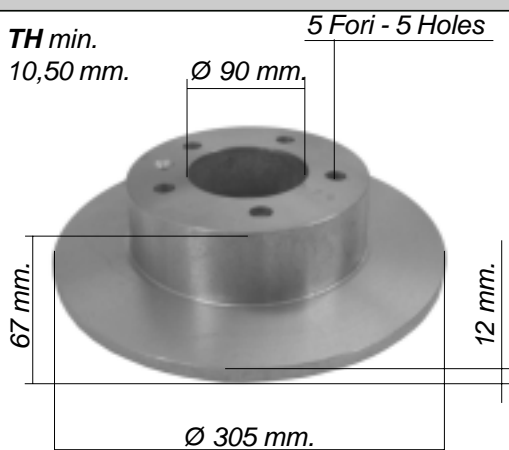

NOSTRO RIFERIMENTO
OUR REFERENCE

960231

RIFERIMENTO COSTRUTTORE
O.E. REFERENCE

7700314107

DESCRIZIONE / DESCRIPTION

Disco freno assale posteriore
Brake disc rear axle



ILLUSTRAZIONE / ILLUSTRATION



NOSTRO RIFERIMENTO
OUR REFERENCE

960985

RIFERIMENTO COSTRUTTORE
O.E. REFERENCE

7701206763

DESCRIZIONE / DESCRIPTION

Serie pastiglie freno posteriore
Set of brake pads rear

WVA	Larghezza Width - mm.	Altezza Height - mm.	Spessore Thickness - mm.
23669	115,8	51,3	16,8



ILLUSTRAZIONE / ILLUSTRATION

NOSTRO RIFERIMENTO
OUR REFERENCE



RIFERIMENTO COSTRUTTORE
O.E. REFERENCE

DESCRIZIONE / DESCRIPTION

TIPO DI VEICOLO / VEHICLE TYPE

MASCOTT

90.35 - 110.35 - 110.50 - 130.35 - 150.35 (01/99)

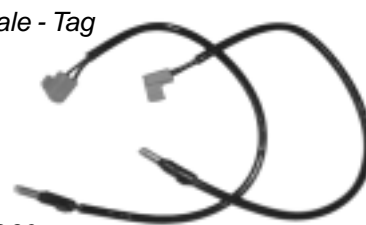
ILLUSTRAZIONE / ILLUSTRATION	NOSTRO RIFERIMENTO OUR REFERENCE	RIFERIMENTO COSTRUTTORE O.E. REFERENCE								
	960230	5010260604								
DESCRIZIONE / DESCRIPTION										
Disco freno assale anteriore Brake disc front axle										
Fascia AUTOVENTILANTE SELF-VENTILATED Band										
										
ILLUSTRAZIONE / ILLUSTRATION	NOSTRO RIFERIMENTO OUR REFERENCE	RIFERIMENTO COSTRUTTORE O.E. REFERENCE								
	960987	5001850859 5001844747								
DESCRIZIONE / DESCRIPTION										
Serie pastiglie freno anteriore e posteriore Set of brake pads front and rear										
<table border="1"> <thead> <tr> <th>WVA</th> <th>Larghezza Width - mm.</th> <th>Altezza Height - mm.</th> <th>Spessore Thickness - mm.</th> </tr> </thead> <tbody> <tr> <td>29121</td> <td>164,80</td> <td>66,50</td> <td>20</td> </tr> </tbody> </table>			WVA	Larghezza Width - mm.	Altezza Height - mm.	Spessore Thickness - mm.	29121	164,80	66,50	20
WVA	Larghezza Width - mm.	Altezza Height - mm.	Spessore Thickness - mm.							
29121	164,80	66,50	20							
										
ILLUSTRAZIONE / ILLUSTRATION	NOSTRO RIFERIMENTO OUR REFERENCE	RIFERIMENTO COSTRUTTORE O.E. REFERENCE								
	960972	5001844748								
DESCRIZIONE / DESCRIPTION										
Serie pastiglie freno anteriore e posteriore Set of brake pads front and rear										
<table border="1"> <thead> <tr> <th>WVA</th> <th>Larghezza Width - mm.</th> <th>Altezza Height - mm.</th> <th>Spessore Thickness - mm.</th> </tr> </thead> <tbody> <tr> <td>29160</td> <td>164,5</td> <td>67,80</td> <td>20</td> </tr> </tbody> </table>			WVA	Larghezza Width - mm.	Altezza Height - mm.	Spessore Thickness - mm.	29160	164,5	67,80	20
WVA	Larghezza Width - mm.	Altezza Height - mm.	Spessore Thickness - mm.							
29160	164,5	67,80	20							
										
ILLUSTRAZIONE / ILLUSTRATION	NOSTRO RIFERIMENTO OUR REFERENCE	RIFERIMENTO COSTRUTTORE O.E. REFERENCE								
Puntale - Tag  L = 260 mm.	960819	5001850859/A 5001844747/A								
DESCRIZIONE / DESCRIPTION										
Kit segnalatori usura freno anteriore e posteriore (2 pz.) Set of brake wear indicators front and rear (2 pcs)										

TIPO DI VEICOLO / VEHICLE TYPE

MASCOTT

90.35 - 110.35 - 110.50 - 130.35 - 150.35 (01/99)

ILLUSTRAZIONE / ILLUSTRATION	NOSTRO RIFERIMENTO OUR REFERENCE	RIFERIMENTO COSTRUTTORE O.E. REFERENCE								
	960229	5010260609								
DESCRIZIONE / DESCRIPTION										
<p>Disco freno assale posteriore Brake disc rear axle</p> <p>Fascia AUTOVENTILANTE SELF-VENTILATED Band</p>										
ILLUSTRAZIONE / ILLUSTRATION	NOSTRO RIFERIMENTO OUR REFERENCE	RIFERIMENTO COSTRUTTORE O.E. REFERENCE								
	960987	5001850859 5001844747								
DESCRIZIONE / DESCRIPTION										
<p>Serie pastiglie freno anteriore e posteriore Set of brake pads front and rear</p> <table border="1"> <thead> <tr> <th>WVA</th> <th>Larghezza Width - mm.</th> <th>Altezza Height - mm.</th> <th>Spessore Thickness - mm.</th> </tr> </thead> <tbody> <tr> <td>29121</td> <td>164,80</td> <td>66,50</td> <td>20</td> </tr> </tbody> </table>			WVA	Larghezza Width - mm.	Altezza Height - mm.	Spessore Thickness - mm.	29121	164,80	66,50	20
WVA	Larghezza Width - mm.	Altezza Height - mm.	Spessore Thickness - mm.							
29121	164,80	66,50	20							
ILLUSTRAZIONE / ILLUSTRATION	NOSTRO RIFERIMENTO OUR REFERENCE	RIFERIMENTO COSTRUTTORE O.E. REFERENCE								
	960972	5001844748								
DESCRIZIONE / DESCRIPTION										
<p>Serie pastiglie freno anteriore e posteriore Set of brake pads front and rear</p> <table border="1"> <thead> <tr> <th>WVA</th> <th>Larghezza Width - mm.</th> <th>Altezza Height - mm.</th> <th>Spessore Thickness - mm.</th> </tr> </thead> <tbody> <tr> <td>29160</td> <td>164,5</td> <td>67,80</td> <td>20</td> </tr> </tbody> </table>			WVA	Larghezza Width - mm.	Altezza Height - mm.	Spessore Thickness - mm.	29160	164,5	67,80	20
WVA	Larghezza Width - mm.	Altezza Height - mm.	Spessore Thickness - mm.							
29160	164,5	67,80	20							
ILLUSTRAZIONE / ILLUSTRATION	NOSTRO RIFERIMENTO OUR REFERENCE	RIFERIMENTO COSTRUTTORE O.E. REFERENCE								
<p>Puntale - Tag</p> <p>L = 260 mm.</p>	960819	5001850859/A 5001844747/A								
DESCRIZIONE / DESCRIPTION										
<p>Kit segnalatori usura freno anteriore e posteriore (2 pz.) Set of brake wear indicators front and rear (2 pcs)</p>										

TIPO DI VEICOLO / VEHICLE TYPE

MASCOTT

110.55 - 110.60 - 130.55 - 130.65 - 140.55 - 140.65 (01/99)

ILLUSTRAZIONE / ILLUSTRATION	NOSTRO RIFERIMENTO OUR REFERENCE	RIFERIMENTO COSTRUTTORE O.E. REFERENCE								
	960392	5010260603								
DESCRIZIONE / DESCRIPTION										
Disco freno assale anteriore Brake disc front axle Fascia AUTOVENTILANTE SELF-VENTILATED Band										
ILLUSTRAZIONE / ILLUSTRATION	NOSTRO RIFERIMENTO OUR REFERENCE	RIFERIMENTO COSTRUTTORE O.E. REFERENCE								
	960987	5001850859 5001844747								
DESCRIZIONE / DESCRIPTION										
Serie pastiglie freno anteriore e posteriore Set of brake pads front and rear <table border="1" style="width: 100%; margin-top: 10px;"> <thead> <tr> <th>WVA</th> <th>Larghezza Width - mm.</th> <th>Altezza Height - mm.</th> <th>Spessore Thickness - mm.</th> </tr> </thead> <tbody> <tr> <td>29121</td> <td>164,80</td> <td>66,50</td> <td>20</td> </tr> </tbody> </table>			WVA	Larghezza Width - mm.	Altezza Height - mm.	Spessore Thickness - mm.	29121	164,80	66,50	20
WVA	Larghezza Width - mm.	Altezza Height - mm.	Spessore Thickness - mm.							
29121	164,80	66,50	20							
ILLUSTRAZIONE / ILLUSTRATION	NOSTRO RIFERIMENTO OUR REFERENCE	RIFERIMENTO COSTRUTTORE O.E. REFERENCE								
	960972	5001844748								
DESCRIZIONE / DESCRIPTION										
Serie pastiglie freno anteriore e posteriore Set of brake pads front and rear <table border="1" style="width: 100%; margin-top: 10px;"> <thead> <tr> <th>WVA</th> <th>Larghezza Width - mm.</th> <th>Altezza Height - mm.</th> <th>Spessore Thickness - mm.</th> </tr> </thead> <tbody> <tr> <td>29160</td> <td>164,5</td> <td>67,80</td> <td>20</td> </tr> </tbody> </table>			WVA	Larghezza Width - mm.	Altezza Height - mm.	Spessore Thickness - mm.	29160	164,5	67,80	20
WVA	Larghezza Width - mm.	Altezza Height - mm.	Spessore Thickness - mm.							
29160	164,5	67,80	20							
ILLUSTRAZIONE / ILLUSTRATION	NOSTRO RIFERIMENTO OUR REFERENCE	RIFERIMENTO COSTRUTTORE O.E. REFERENCE								
Puntale - Tag L = 260 mm.	960819	5001850859/A 5001844747/A								
DESCRIZIONE / DESCRIPTION										
Kit segnalatori usura freno anteriore e posteriore (2 pz.) Set of brake wear indicators front and rear (2 pcs)										

TIPO DI VEICOLO / VEHICLE TYPE

MIDLINER 1993

MESSENGER BUS

B70 - B80 - B90 - B110 - B120 (4X2) (4X4)

ILLUSTRAZIONE / ILLUSTRATION

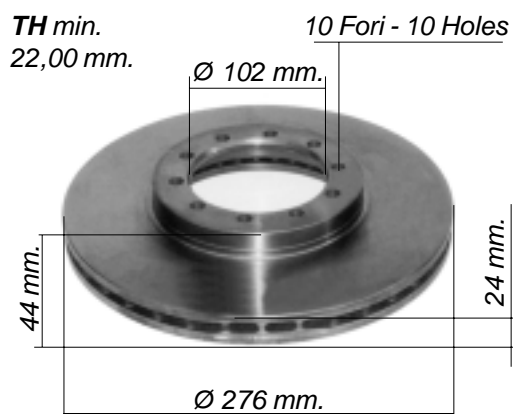

NOSTRO RIFERIMENTO OUR REFERENCE

960342

RIFERIMENTO COSTRUTTORE O.E. REFERENCE

5010216433

DESCRIZIONE / DESCRIPTION

Disco freno assale anteriore
Brake disc front axle

Fascia AUTOVENTILANTE
SELF-VENTILATED Band



ILLUSTRAZIONE / ILLUSTRATION



NOSTRO RIFERIMENTO OUR REFERENCE

960959

RIFERIMENTO COSTRUTTORE O.E. REFERENCE

5000295329

DESCRIZIONE / DESCRIPTION

Serie pastiglie freno anteriore
Set of brake pads front

WVA	Larghezza Width - mm.	Altezza Height - mm.	Spessore Thickness - mm.
29706 29947	166,6	62	17



ILLUSTRAZIONE / ILLUSTRATION

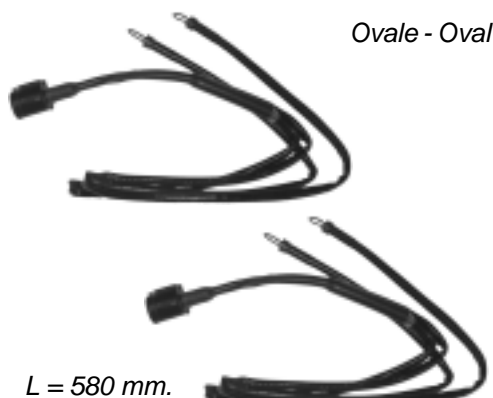

NOSTRO RIFERIMENTO OUR REFERENCE

960919

RIFERIMENTO COSTRUTTORE O.E. REFERENCE

5001822897

DESCRIZIONE / DESCRIPTION

Kit segnalatori usura freno anteriore (2 pz.)
Set of brake wear indicators front (2 pcs)

TIPO DI VEICOLO / VEHICLE TYPE

MIDLINER 1993

MESSENGER

B70 - B80 - B90 - B110 - B120 (1982-1992) (4X2) - (4X4)

ILLUSTRAZIONE / ILLUSTRATION

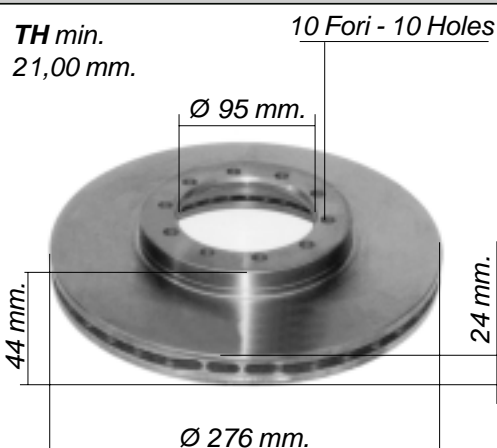
NOSTRO RIFERIMENTO
OUR REFERENCE**960305**RIFERIMENTO COSTRUTTORE
O.E. REFERENCE

5000396612

DESCRIZIONE / DESCRIPTION

Disco freno assale anteriore
Brake disc front axleFascia AUTOVENTILANTE
SELF-VENTILATED Band

ILLUSTRAZIONE / ILLUSTRATION

NOSTRO RIFERIMENTO
OUR REFERENCE**960959**RIFERIMENTO COSTRUTTORE
O.E. REFERENCE

5000295329

DESCRIZIONE / DESCRIPTION

Serie pastiglie freno anteriore
Set of brake pads front

WVA	Larghezza Width - mm.	Altezza Height - mm.	Spessore Thickness - mm.
29706	166,6	62	17
29947			

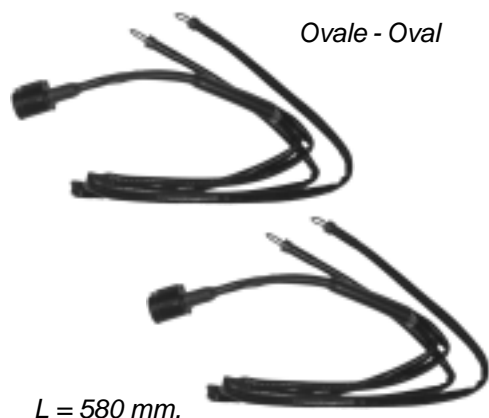

ILLUSTRAZIONE / ILLUSTRATION

NOSTRO RIFERIMENTO
OUR REFERENCE**960919**RIFERIMENTO COSTRUTTORE
O.E. REFERENCE

5001822897

DESCRIZIONE / DESCRIPTION

Kit segnalatori usura freno anteriore (2 pz.)
Set of brake wear indicators front (2 pcs)

TIPO DI VEICOLO / VEHICLE TYPE

MIDLINER

M140 - M150 - M160

S135 - S150 - S180 - S210

ILLUSTRAZIONE / ILLUSTRATION



NOSTRO RIFERIMENTO
OUR REFERENCE

960227

RIFERIMENTO COSTRUTTORE
O.E. REFERENCE

5010260102
5010216932

DESCRIZIONE / DESCRIPTION

Disco freno assale anteriore
Brake disc front axle

Fascia AUTOVENTILANTE
SELF-VENTILATED Band



ILLUSTRAZIONE / ILLUSTRATION



NOSTRO RIFERIMENTO
OUR REFERENCE

960939

RIFERIMENTO COSTRUTTORE
O.E. REFERENCE

1906297

DESCRIZIONE / DESCRIPTION

Serie pastiglie freno anteriore e posteriore
Set of brake pads front and rear

WVA	Larghezza Width - mm.	Altezza Height - mm.	Spessore Thickness - mm.
29067	176	78	22



ILLUSTRAZIONE / ILLUSTRATION

Ovale - Oval



L = 885 mm.

NOSTRO RIFERIMENTO
OUR REFERENCE

960918

RIFERIMENTO COSTRUTTORE
O.E. REFERENCE

68320909
68320874

DESCRIZIONE / DESCRIPTION

Kit segnalatori usura freno anteriore (2 pz.)
Set of brake wear indicators front (2 pcs)

TIPO DI VEICOLO / VEHICLE TYPE

MIDLINER

S120 - S130 - S150 - S170 - S180 (1986)

M120 - M140 - M150 - M160 - M180 - M200 - M210 - M230 (1994)

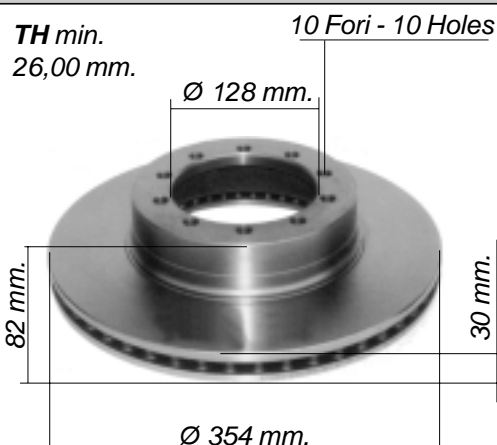
ILLUSTRAZIONE / ILLUSTRATION**NOSTRO RIFERIMENTO
OUR REFERENCE****960308****RIFERIMENTO COSTRUTTORE
O.E. REFERENCE**5000450158
5000545242**DESCRIZIONE / DESCRIPTION**Disco freno assale anteriore
Brake disc front axleFascia AUTOVENTILANTE
SELF-VENTILATED Band**ILLUSTRAZIONE / ILLUSTRATION**Connettore a Puntale
Tag connector**NOSTRO RIFERIMENTO
OUR REFERENCE****960957****RIFERIMENTO COSTRUTTORE
O.E. REFERENCE**

5000297808

DESCRIZIONE / DESCRIPTIONSerie pastiglie freno anteriore
Set of brake pads front

WVA	Larghezza Width - mm.	Altezza Height - mm.	Spessore Thickness - mm.
29013 29014	180	86	20,5

**ILLUSTRAZIONE / ILLUSTRATION**

Ovale - Oval



L = 885 mm.

**NOSTRO RIFERIMENTO
OUR REFERENCE****960918****RIFERIMENTO COSTRUTTORE
O.E. REFERENCE**68320909
68320874**DESCRIZIONE / DESCRIPTION**Kit segnalatori usura freno anteriore (2 pz.)
Set brake wear indicators front (2 pcs)

TIPO DI VEICOLO / VEHICLE TYPE

MIDLINER

S120 - S140 - S150 - S180

M210 - M230 - M250

ILLUSTRAZIONE / ILLUSTRATION

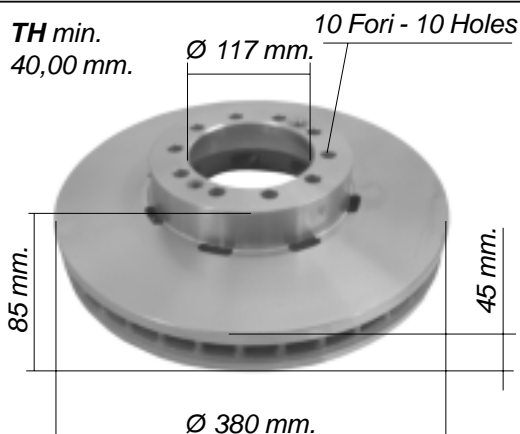

NOSTRO RIFERIMENTO OUR REFERENCE

960228

RIFERIMENTO COSTRUTTORE O.E. REFERENCE

5010260218

DESCRIZIONE / DESCRIPTION

Disco freno assale anteriore
Brake disc front axle

Fascia AUTOVENTILANTE
SELF-VENTILATED Band



ILLUSTRAZIONE / ILLUSTRATION



NOSTRO RIFERIMENTO OUR REFERENCE

960990

RIFERIMENTO COSTRUTTORE O.E. REFERENCE

5001014704

DESCRIZIONE / DESCRIPTION

Serie pastiglie freno anteriore
Set of brake pads front

WVA	Larghezza Width - mm.	Altezza Height - mm.	Spessore Thickness - mm.
29067	176	78	22



ILLUSTRAZIONE / ILLUSTRATION

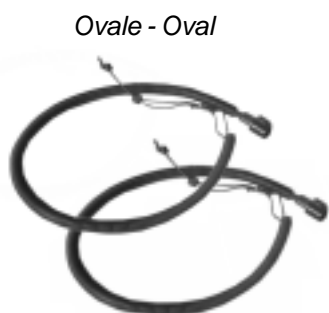

L = 885 mm.

NOSTRO RIFERIMENTO OUR REFERENCE

960918

RIFERIMENTO COSTRUTTORE O.E. REFERENCE

68320909
68320874

DESCRIZIONE / DESCRIPTION

Kit segnalatori usura freno anteriore (2 pz.)
Set of brake wear indicators front (2 pcs)

TIPO DI VEICOLO / VEHICLE TYPE

MIDLINERS120 - S140 - S150 - S180
M210 - M230 - M250**MIDLUM**

210 - 250

ILLUSTRAZIONE / ILLUSTRATION

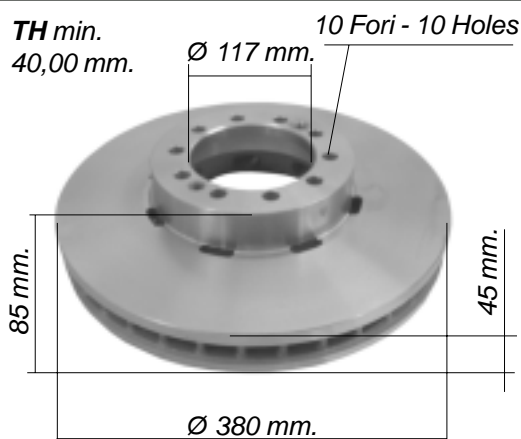
NOSTRO RIFERIMENTO
OUR REFERENCE**960228**RIFERIMENTO COSTRUTTORE
O.E. REFERENCE

5010260218

DESCRIZIONE / DESCRIPTION

Disco freno assale anteriore
Brake disc front axleFascia AUTOVENTILANTE
SELF-VENTILATED Band

ILLUSTRAZIONE / ILLUSTRATION

NOSTRO RIFERIMENTO
OUR REFERENCE**960991**RIFERIMENTO COSTRUTTORE
O.E. REFERENCE

5001857615

DESCRIZIONE / DESCRIPTION

Serie pastiglie freno anteriore
Set of brake pads front

WVA	Larghezza Width - mm.	Altezza Height - mm.	Spessore Thickness - mm.
29100	214	112	25
29099			



ILLUSTRAZIONE / ILLUSTRATION

Connettore Quadro
Square connector

L = 235 mm.

NOSTRO RIFERIMENTO
OUR REFERENCE**960702**RIFERIMENTO COSTRUTTORE
O.E. REFERENCE

68321484

DESCRIZIONE / DESCRIPTION

Kit segnalatori usura freno anteriore (2 pz.)
Set of brake wear indicators front (2 pcs)

TIPO DI VEICOLO / VEHICLE TYPE

MIDLUM

135-150-180 (dal 01/2000 - from 01/2000)

190-210-220-240-250 (dal 05/2006 - from 05/2006)

270-280

ILLUSTRAZIONE / ILLUSTRATION

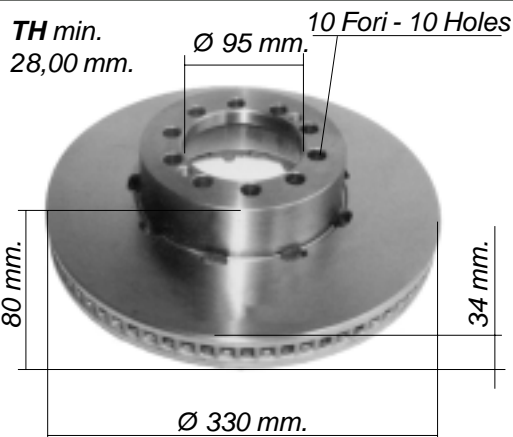

NOSTRO RIFERIMENTO OUR REFERENCE

960237

RIFERIMENTO COSTRUTTORE O.E. REFERENCE

5010525308
5010422262

DESCRIZIONE / DESCRIPTION

Disco freno assale anteriore
Brake disc front axle

Fascia AUTOVENTILANTE
SELF-VENTILATED Band



ILLUSTRAZIONE / ILLUSTRATION



NOSTRO RIFERIMENTO OUR REFERENCE

960241

RIFERIMENTO COSTRUTTORE O.E. REFERENCE

5010848607

DESCRIZIONE / DESCRIPTION

Serie pastiglie freno anteriore
Set of brake pads front

WVA	Larghezza Width - mm.	Altezza Height - mm.	Spessore Thickness - mm.
29088	175,50	85,60	26



ILLUSTRAZIONE / ILLUSTRATION



NOSTRO RIFERIMENTO OUR REFERENCE

960270

RIFERIMENTO COSTRUTTORE O.E. REFERENCE

5001864365

DESCRIZIONE / DESCRIPTION

Serie pastiglie freno anteriore e posteriore
Set of brake pads front and rear

WVA	Larghezza Width - mm.	Altezza Height - mm.	Spessore Thickness - mm.
29173	216,20	97	29,20



TIPO DI VEICOLO / VEHICLE TYPE

MIDLUM

135.08/B - 135.09/B - 135.10/B (01/00)

150.08/B - 150.09/B - 150.10/B - 150.12/B (01/00)

ILLUSTRAZIONE / ILLUSTRATION

NOSTRO RIFERIMENTO
OUR REFERENCE**960272**RIFERIMENTO COSTRUTTORE
O.E. REFERENCE

5001855902

DESCRIZIONE / DESCRIPTION

Serie pastiglie freno anteriore e posteriore
Set of brake pads front and rear

WVA	Larghezza Width - mm.	Altezza Height - mm.	Spessore Thickness - mm.
29142	204,60	99,60	30



ILLUSTRAZIONE / ILLUSTRATION

Connettore Quadro - Lungh. 300 mm.
Square connector - Length 300 mm.NOSTRO RIFERIMENTO
OUR REFERENCE**960806**RIFERIMENTO COSTRUTTORE
O.E. REFERENCE

5010848607/A

DESCRIZIONE / DESCRIPTION

Kit segnalatori usura freno ant. / post. con supporti (2 pz.)
Set of brake wear indicators front and rear
with supports (2 pz.)

ILLUSTRAZIONE / ILLUSTRATION

Connettore Quadro - Lungh. 399 mm.
Square connector - Length 399 mm.NOSTRO RIFERIMENTO
OUR REFERENCE**960440**RIFERIMENTO COSTRUTTORE
O.E. REFERENCE

-

DESCRIZIONE / DESCRIPTION

Kit segnalatori usura freno ant. / post. senza supporti (2p.)
Set brake front / rear wear indicator without supports (2 pcs)

TIPO DI VEICOLO / VEHICLE TYPE

MIDLUM

135-150-180 (dal 01/2000 - from 01/2000)
190-210-220-240-250 (dal 05/2006 - from 05/2006)
270-280

ILLUSTRAZIONE / ILLUSTRATION

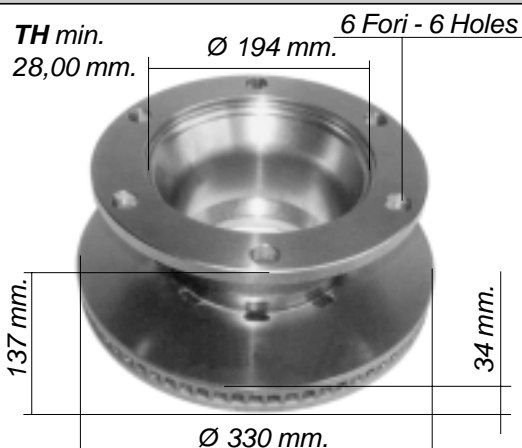

NOSTRO RIFERIMENTO OUR REFERENCE

960238

RIFERIMENTO COSTRUTTORE O.E. REFERENCE

5010422263

DESCRIZIONE / DESCRIPTION

Disco freno assale posteriore
Brake disc rear axle

Fascia AUTOVENTILANTE
SELF-VENTILATED Band



ILLUSTRAZIONE / ILLUSTRATION

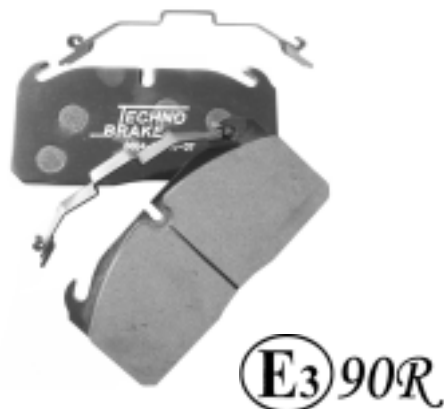

NOSTRO RIFERIMENTO OUR REFERENCE

960241

RIFERIMENTO COSTRUTTORE O.E. REFERENCE

5010848607

DESCRIZIONE / DESCRIPTION

Serie pastiglie freno anteriore
Set of brake pads front

WVA	Larghezza Width - mm.	Altezza Height - mm.	Spessore Thickness - mm.
29088	175,50	85,60	26



ILLUSTRAZIONE / ILLUSTRATION

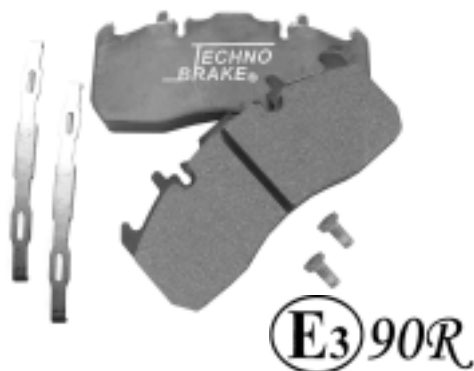

NOSTRO RIFERIMENTO OUR REFERENCE

960270

RIFERIMENTO COSTRUTTORE O.E. REFERENCE

5001864365

DESCRIZIONE / DESCRIPTION

Serie pastiglie freno anteriore e posteriore
Set of brake pads front and rear

WVA	Larghezza Width - mm.	Altezza Height - mm.	Spessore Thickness - mm.
29173	216,20	97	29,20



TIPO DI VEICOLO / VEHICLE TYPE

MIDLUM

135.08/B - 135.09/B - 135.10/B (01/00)

150.08/B - 150.09/B - 150.10/B - 150.12/B (01/00)

ILLUSTRAZIONE / ILLUSTRATION

NOSTRO RIFERIMENTO
OUR REFERENCE**960272**RIFERIMENTO COSTRUTTORE
O.E. REFERENCE

5001855902

DESCRIZIONE / DESCRIPTION

Serie pastiglie freno anteriore e posteriore
Set of brake pads front and rear

WVA	Larghezza Width - mm.	Altezza Height - mm.	Spessore Thickness - mm.
29142	204,60	99,60	30



ILLUSTRAZIONE / ILLUSTRATION

Connettore Quadro - Lungh. 300 mm.
Square connector - Length 300 mm.NOSTRO RIFERIMENTO
OUR REFERENCE**960806**RIFERIMENTO COSTRUTTORE
O.E. REFERENCE

5010848607/A

DESCRIZIONE / DESCRIPTION

Kit segnalatori usura freno ant. / post. con supporti (2 pz.)
Set of brake wear indicators front and rear
with supports (2 pz.)

ILLUSTRAZIONE / ILLUSTRATION

Connettore Quadro - Lungh. 399 mm.
Square connector - Length 399 mm.NOSTRO RIFERIMENTO
OUR REFERENCE**960440**RIFERIMENTO COSTRUTTORE
O.E. REFERENCE

-

DESCRIZIONE / DESCRIPTION

Kit segnalatori usura freno ant. / post. senza supporti (2p.)
Set brake front / rear wear indicator without supports (2 pcs)

TIPO DI VEICOLO / VEHICLE TYPE

MIDLUM

135-150-180 (dal 01/2000 - from 01/2000)
190-210-220-240-250 (dal 05/2006 - from 05/2006)
270-280

ILLUSTRAZIONE / ILLUSTRATION

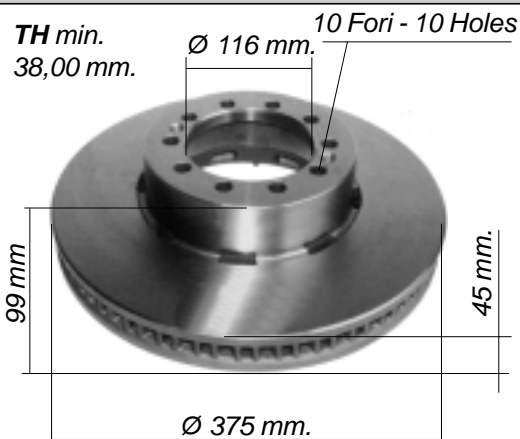

NOSTRO RIFERIMENTO OUR REFERENCE

960239

RIFERIMENTO COSTRUTTORE O.E. REFERENCE

5010525014

DESCRIZIONE / DESCRIPTION

Disco freno assale anteriore
Brake disc front axle

Fascia AUTOVENTILANTE
SELF-VENTILATED Band



ILLUSTRAZIONE / ILLUSTRATION

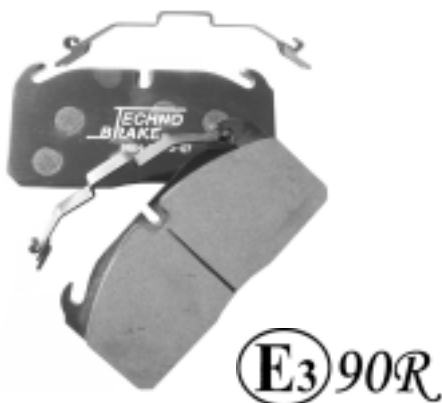

NOSTRO RIFERIMENTO OUR REFERENCE

960241

RIFERIMENTO COSTRUTTORE O.E. REFERENCE

5010848607

DESCRIZIONE / DESCRIPTION

Serie pastiglie freno anteriore
Set of brake pads front

WVA	Larghezza Width - mm.	Altezza Height - mm.	Spessore Thickness - mm.
29088	175,50	85,60	26



ILLUSTRAZIONE / ILLUSTRATION

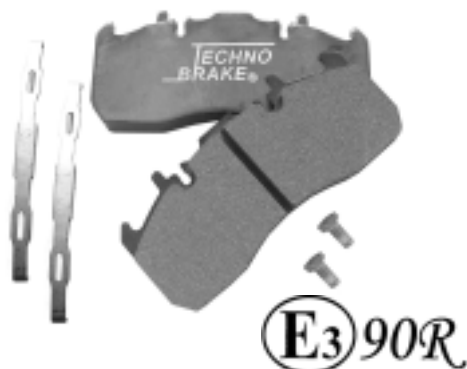

NOSTRO RIFERIMENTO OUR REFERENCE

960270

RIFERIMENTO COSTRUTTORE O.E. REFERENCE

5001864365

DESCRIZIONE / DESCRIPTION

Serie pastiglie freno anteriore e posteriore
Set of brake pads front and rear

WVA	Larghezza Width - mm.	Altezza Height - mm.	Spessore Thickness - mm.
29173	216,20	97	29,20



TIPO DI VEICOLO / VEHICLE TYPE

MIDLUM

135.08/B - 135.09/B - 135.10/B (01/00)

150.08/B - 150.09/B - 150.10/B - 150.12/B (01/00)

ILLUSTRAZIONE / ILLUSTRATION

NOSTRO RIFERIMENTO
OUR REFERENCE**960272**RIFERIMENTO COSTRUTTORE
O.E. REFERENCE

5001855902

DESCRIZIONE / DESCRIPTION

Serie pastiglie freno anteriore e posteriore
Set of brake pads front and rear

WVA	Larghezza Width - mm.	Altezza Height - mm.	Spessore Thickness - mm.
29142	204,60	99,60	30



ILLUSTRAZIONE / ILLUSTRATION

Connettore Quadro - Lungh. 300 mm.
Square connector - Length 300 mm.NOSTRO RIFERIMENTO
OUR REFERENCE**960806**RIFERIMENTO COSTRUTTORE
O.E. REFERENCE

5010848607/A

DESCRIZIONE / DESCRIPTION

Kit segnalatori usura freno ant. / post. con supporti (2 pz.)
Set of brake wear indicators front and rear
with supports (2 pz.)

ILLUSTRAZIONE / ILLUSTRATION

Connettore Quadro - Lungh. 399 mm.
Square connector - Length 399 mm.NOSTRO RIFERIMENTO
OUR REFERENCE**960440**RIFERIMENTO COSTRUTTORE
O.E. REFERENCE

-

DESCRIZIONE / DESCRIPTION

Kit segnalatori usura freno ant. / post. senza supporti (2p.)
Set brake front / rear wear indicator without supports (2 pcs)

TIPO DI VEICOLO / VEHICLE TYPE

MIDLUM

135-150-180 (dal 01/2000 - from 01/2000)
190-210-220-240-250 (dal 05/2006 - from 05/2006)
270-280

ILLUSTRAZIONE / ILLUSTRATION	NOSTRO RIFERIMENTO OUR REFERENCE	RIFERIMENTO COSTRUTTORE O.E. REFERENCE								
	960240	5010525362								
DESCRIZIONE / DESCRIPTION										
<p>Disco freno assale posteriore Brake disc rear axle</p> <p>Fascia AUTOVENTILANTE SELF-VENTILATED Band</p>										
ILLUSTRAZIONE / ILLUSTRATION	NOSTRO RIFERIMENTO OUR REFERENCE	RIFERIMENTO COSTRUTTORE O.E. REFERENCE								
	960241	5010848607								
DESCRIZIONE / DESCRIPTION										
<p>Serie pastiglie freno anteriore Set of brake pads front</p> <table border="1" data-bbox="644 1451 1238 1621"> <thead> <tr> <th>WVA</th> <th>Larghezza Width - mm.</th> <th>Altezza Height - mm.</th> <th>Spessore Thickness - mm.</th> </tr> </thead> <tbody> <tr> <td>29088</td> <td>175,50</td> <td>85,60</td> <td>26</td> </tr> </tbody> </table>			WVA	Larghezza Width - mm.	Altezza Height - mm.	Spessore Thickness - mm.	29088	175,50	85,60	26
WVA	Larghezza Width - mm.	Altezza Height - mm.	Spessore Thickness - mm.							
29088	175,50	85,60	26							
ILLUSTRAZIONE / ILLUSTRATION	NOSTRO RIFERIMENTO OUR REFERENCE	RIFERIMENTO COSTRUTTORE O.E. REFERENCE								
	960270	5001864365								
DESCRIZIONE / DESCRIPTION										
<p>Serie pastiglie freno anteriore e posteriore Set of brake pads front and rear</p> <table border="1" data-bbox="644 1998 1238 2145"> <thead> <tr> <th>WVA</th> <th>Larghezza Width - mm.</th> <th>Altezza Height - mm.</th> <th>Spessore Thickness - mm.</th> </tr> </thead> <tbody> <tr> <td>29173</td> <td>216,20</td> <td>97</td> <td>29,20</td> </tr> </tbody> </table>			WVA	Larghezza Width - mm.	Altezza Height - mm.	Spessore Thickness - mm.	29173	216,20	97	29,20
WVA	Larghezza Width - mm.	Altezza Height - mm.	Spessore Thickness - mm.							
29173	216,20	97	29,20							

TIPO DI VEICOLO / VEHICLE TYPE

MIDLUM

135.08/B - 135.09/B - 135.10/B (01/00)

150.08/B - 150.09/B - 150.10/B - 150.12/B (01/00)

ILLUSTRAZIONE / ILLUSTRATION

NOSTRO RIFERIMENTO
OUR REFERENCE**960272**RIFERIMENTO COSTRUTTORE
O.E. REFERENCE

5001855902

DESCRIZIONE / DESCRIPTION

Serie pastiglie freno anteriore e posteriore
Set of brake pads front and rear

WVA	Larghezza Width - mm.	Altezza Height - mm.	Spessore Thickness - mm.
29142	204,60	99,60	30



ILLUSTRAZIONE / ILLUSTRATION

Connettore Quadro - Lungh. 300 mm.
Square connector - Length 300 mm.NOSTRO RIFERIMENTO
OUR REFERENCE**960806**RIFERIMENTO COSTRUTTORE
O.E. REFERENCE

5010848607/A

DESCRIZIONE / DESCRIPTION

Kit segnalatori usura freno ant. / post. con supporti (2 pz.)
Set of brake wear indicators front and rear
with supports (2 pz.)

ILLUSTRAZIONE / ILLUSTRATION

Connettore Quadro - Lungh. 399 mm.
Square connector - Length 399 mm.NOSTRO RIFERIMENTO
OUR REFERENCE**960440**RIFERIMENTO COSTRUTTORE
O.E. REFERENCE

-

DESCRIZIONE / DESCRIPTION

Kit segnalatori usura freno ant. / post. senza supporti (2p.)
Set brake front / rear wear indicator without supports (2 pcs)

TIPO DI VEICOLO / VEHICLE TYPE

MIDLUM

135-150-180 (dal 01/2000 - from 01/2000)
190-210-220-240-250 (dal 05/2006 - from 05/2006)
270-280

ILLUSTRAZIONE / ILLUSTRATION

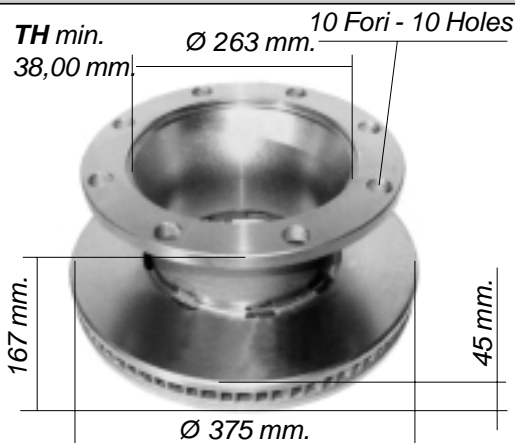

NOSTRO RIFERIMENTO OUR REFERENCE

960242

RIFERIMENTO COSTRUTTORE O.E. REFERENCE

5010525364

DESCRIZIONE / DESCRIPTION

Disco freno assale posteriore
Brake disc rear axle

Fascia AUTOVENTILANTE
SELF-VENTILATED Band



ILLUSTRAZIONE / ILLUSTRATION

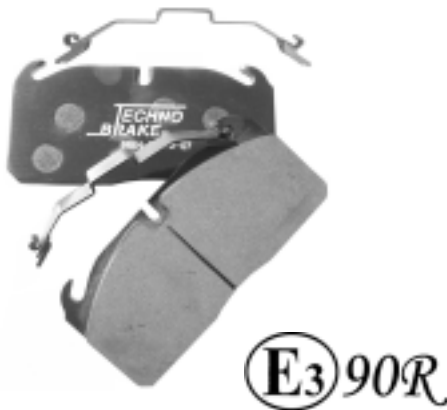

NOSTRO RIFERIMENTO OUR REFERENCE

960241

RIFERIMENTO COSTRUTTORE O.E. REFERENCE

5010848607

DESCRIZIONE / DESCRIPTION

Serie pastiglie freno anteriore
Set of brake pads front

WVA	Larghezza Width - mm.	Altezza Height - mm.	Spessore Thickness - mm.
29088	175,50	85,60	26



ILLUSTRAZIONE / ILLUSTRATION

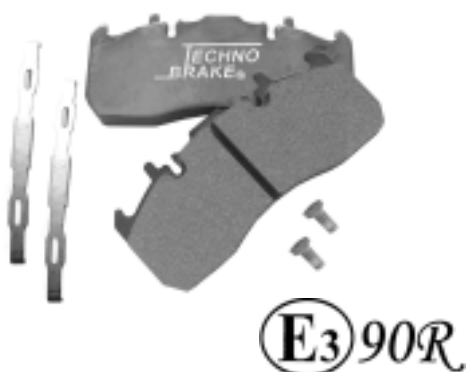

NOSTRO RIFERIMENTO OUR REFERENCE

960270

RIFERIMENTO COSTRUTTORE O.E. REFERENCE

5001864365

DESCRIZIONE / DESCRIPTION

Serie pastiglie freno anteriore e posteriore
Set of brake pads front and rear

WVA	Larghezza mm.	Altezza mm.	Spessore mm.
29173	216,20	97	29,20



TIPO DI VEICOLO / VEHICLE TYPE

MIDLUM

135.08/B - 135.09/B - 135.10/B (01/00)

150.08/B - 150.09/B - 150.10/B - 150.12/B (01/00)

ILLUSTRAZIONE / ILLUSTRATION

NOSTRO RIFERIMENTO
OUR REFERENCE**960272**RIFERIMENTO COSTRUTTORE
O.E. REFERENCE

5001855902

DESCRIZIONE / DESCRIPTION

Serie pastiglie freno anteriore e posteriore
Set of brake pads front and rear

WVA	Larghezza Width - mm.	Altezza Height - mm.	Spessore Thickness - mm.
29142	204,60	99,60	30



ILLUSTRAZIONE / ILLUSTRATION

Connettore Quadro - Lungh. 300 mm.
Square connector - Length 300 mm.NOSTRO RIFERIMENTO
OUR REFERENCE**960806**RIFERIMENTO COSTRUTTORE
O.E. REFERENCE

5010848607/A

DESCRIZIONE / DESCRIPTION

Kit segnalatori usura freno ant. / post. con supporti (2 pz.)
Set of brake wear indicators front and rear
with supports (2 pz.)

ILLUSTRAZIONE / ILLUSTRATION

Connettore Quadro - Lungh. 399 mm.
Square connector - Length 399 mm.NOSTRO RIFERIMENTO
OUR REFERENCE**960440**RIFERIMENTO COSTRUTTORE
O.E. REFERENCE

-

DESCRIZIONE / DESCRIPTION

Kit segnalatori usura freno ant. / post. senza supporti (2p.)
Set brake front / rear wear indicator without supports (2 pcs)

TIPO DI VEICOLO / VEHICLE TYPE

RENAULT

Serie R340 - R350 - R380 - R385 - R420 (04/92-10/96)

ILLUSTRAZIONE / ILLUSTRATION	NOSTRO RIFERIMENTO OUR REFERENCE	RIFERIMENTO COSTRUTTORE O.E. REFERENCE								
<p>TH min. 36,00 mm.</p> <p>10 Fori - 10 Holes Ø 131 mm.</p> <p>Ø 440 mm.</p>	960306	5010216548 5000792539								
DESCRIZIONE / DESCRIPTION										
<p>Disco freno assale anteriore Brake disc front axle</p> <p>Fascia AUTOVENTILANTE SELF-VENTILATED Band</p>										
ILLUSTRAZIONE / ILLUSTRATION	NOSTRO RIFERIMENTO OUR REFERENCE	RIFERIMENTO COSTRUTTORE O.E. REFERENCE								
<p>E3 90R</p>	960958	5000294357 - 5000821964 5000525640								
DESCRIZIONE / DESCRIPTION										
<p>Serie pastiglie freno anteriore Set of brake pads front</p> <table border="1"> <thead> <tr> <th>WVA</th> <th>Larghezza Width - mm.</th> <th>Altezza Height - mm.</th> <th>Spessore Thickness - mm.</th> </tr> </thead> <tbody> <tr> <td>29043</td> <td>204</td> <td>97</td> <td>24</td> </tr> </tbody> </table>			WVA	Larghezza Width - mm.	Altezza Height - mm.	Spessore Thickness - mm.	29043	204	97	24
WVA	Larghezza Width - mm.	Altezza Height - mm.	Spessore Thickness - mm.							
29043	204	97	24							
ILLUSTRAZIONE / ILLUSTRATION	NOSTRO RIFERIMENTO OUR REFERENCE	RIFERIMENTO COSTRUTTORE O.E. REFERENCE								
<p>Puntale - Lungh. mm. 415 Tag - Length mm. 415</p>	960917	5000297198/A								
DESCRIZIONE / DESCRIPTION										
<p>Kit segnalatori usura freno anteriore (2 pz.) Set brake wear indicators front (2 pcs)</p>										

TIPO DI VEICOLO / VEHICLE TYPE

MAGNUM	AE385TI - AE420TI - AE520TI (10/92-01/02)
PREMIUM DISTRIBUTION	210 - 250 - 300 - 340 (10/92-01/02)
PREMIUM ROUTE	300 - 340 - 385 (10/92-01/02)

ILLUSTRAZIONE / ILLUSTRATION	NOSTRO RIFERIMENTO OUR REFERENCE	RIFERIMENTO COSTRUTTORE O.E. REFERENCE																
 <p>TH min. 35,00 mm.</p> <p>10 Fori - 10 Holes Ø 131 mm.</p> <p>97 mm.</p> <p>45 mm.</p> <p>Ø 438 mm.</p>	960307	5010216437																
DESCRIZIONE / DESCRIPTION																		
<p>Disco freno assale anteriore Brake disc front axle</p> <p>Fascia AUTOVENTILANTE SELF-VENTILATED Band</p> 																		
ILLUSTRAZIONE / ILLUSTRATION	NOSTRO RIFERIMENTO OUR REFERENCE	RIFERIMENTO COSTRUTTORE O.E. REFERENCE																
 <p>IMPIANTO MERITOR MERITOR SYSTEM D 3</p>	960956	5001823000 - 5001833124																
DESCRIZIONE / DESCRIPTION																		
<p>Serie pastiglie freno anteriore Set of brake pads front</p> <table border="1"> <thead> <tr> <th>WVA</th> <th>Larghezza Width - mm.</th> <th>Altezza Height - mm.</th> <th>Spessore Thickness - mm.</th> </tr> </thead> <tbody> <tr> <td>29030</td> <td>250</td> <td>118</td> <td>28</td> </tr> <tr> <td>29113</td> <td></td> <td></td> <td></td> </tr> <tr> <td>29083</td> <td></td> <td></td> <td></td> </tr> </tbody> </table> 			WVA	Larghezza Width - mm.	Altezza Height - mm.	Spessore Thickness - mm.	29030	250	118	28	29113				29083			
WVA	Larghezza Width - mm.	Altezza Height - mm.	Spessore Thickness - mm.															
29030	250	118	28															
29113																		
29083																		
ILLUSTRAZIONE / ILLUSTRATION	NOSTRO RIFERIMENTO OUR REFERENCE	RIFERIMENTO COSTRUTTORE O.E. REFERENCE																
<p>Connettore Ovale - Lungh.mm. 580 Oval connector - Length mm.580</p>  <p>(1)</p>	960814	5001822987 /A (1)																
ILLUSTRAZIONE / ILLUSTRATION	NOSTRO RIFERIMENTO OUR REFERENCE	RIFERIMENTO COSTRUTTORE O.E. REFERENCE																
<p>Connettore Quadro - Lungh.mm. 355 Square connector - Length mm. 355</p>  <p>(2)</p>	960933	5001834075/A (2)																
DESCRIZIONE / DESCRIPTION																		
<p>Kit segnalatori usura freno anteriore (2 pz.) Set of brake wear indicators front (2 pcs)</p>																		





TIPO DI VEICOLO / VEHICLE TYPE

MAGNUM	AE385TI - AE420TI - AE520TI (10/92-01/02)
PREMIUM DISTRIBUTION	210 - 250 - 300 - 340 (10/92-01/02)
PREMIUM ROUTE	300 - 340 - 385 (10/92-01/02)

ILLUSTRAZIONE / ILLUSTRATION	NOSTRO RIFERIMENTO OUR REFERENCE	RIFERIMENTO COSTRUTTORE O.E. REFERENCE								
<p>TH min. 35,00 mm.</p> <p>10 Fori - 10 Holes</p> <p>Ø 131 mm.</p> <p>97 mm.</p> <p>45 mm.</p> <p>Ø 438 mm.</p>	960307	5010216437								
DESCRIZIONE / DESCRIPTION										
<p>Disco freno assale anteriore Brake disc front axle</p> <p>Fascia AUTOVENTILANTE SELF-VENTILATED Band</p>										
ILLUSTRAZIONE / ILLUSTRATION	NOSTRO RIFERIMENTO OUR REFERENCE	RIFERIMENTO COSTRUTTORE O.E. REFERENCE								
	960982	5001846034								
DESCRIZIONE / DESCRIPTION										
<p>Serie pastiglie freno anteriore con molle Set of brake pads front with spring</p> <table border="1"> <thead> <tr> <th>WVA</th> <th>Larghezza Width - mm.</th> <th>Altezza Height - mm.</th> <th>Spessore Thickness - mm.</th> </tr> </thead> <tbody> <tr> <td>29090</td> <td>250</td> <td>114</td> <td>28</td> </tr> </tbody> </table>			WVA	Larghezza Width - mm.	Altezza Height - mm.	Spessore Thickness - mm.	29090	250	114	28
WVA	Larghezza Width - mm.	Altezza Height - mm.	Spessore Thickness - mm.							
29090	250	114	28							
ILLUSTRAZIONE / ILLUSTRATION	NOSTRO RIFERIMENTO OUR REFERENCE	RIFERIMENTO COSTRUTTORE O.E. REFERENCE								
<p>Connettore Quadro - Lungh. mm. 270 Square connector - Length mm. 270</p>	960977	68321348								
DESCRIZIONE / DESCRIPTION										
<p>Kit segnalatori usura freno anteriore (2 pz.) Set of brake wear indicators front (2 pcs)</p>										

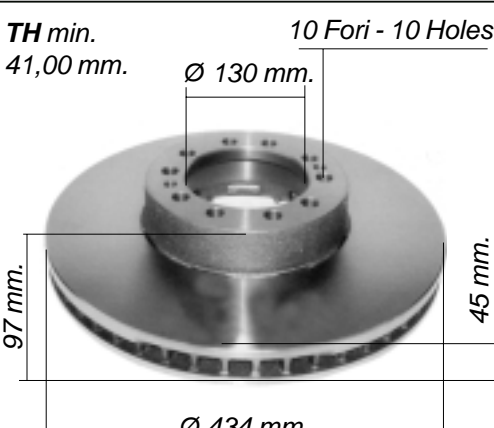
TIPO DI VEICOLO / VEHICLE TYPE

MAGNUM	AE385TI (02/92-10/96)
PREMIUM DISTRIBUTION	210 - 250 - 300 - 340 (04/96) 270 - 320 - 370 - 400 - 420 (08/00)
PREMIUM ROUTE	300 - 340 - 385 (04/96) - 420 (08/00)

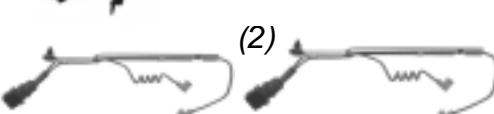
ILLUSTRAZIONE / ILLUSTRATION	NOSTRO RIFERIMENTO OUR REFERENCE	RIFERIMENTO COSTRUTTORE O.E. REFERENCE								
<p>TH min. 41,00 mm.</p> <p>10 Fori - 10 Holes</p> <p>Ø 130 mm.</p> <p>97 mm.</p> <p>45 mm.</p> <p>Ø 434 mm.</p> 	960500	5010422593 5010422363								
DESCRIZIONE / DESCRIPTION										
<p>Disco freno assale anteriore Brake disc front axle</p> <p>Fascia AUTOVENTILANTE SELF-VENTILATED Band</p> 										
ILLUSTRAZIONE / ILLUSTRATION	NOSTRO RIFERIMENTO OUR REFERENCE	RIFERIMENTO COSTRUTTORE O.E. REFERENCE								
 <p>IMPIANTO MERITOR MERITOR SYSTEM D-ELSA 2</p>	960983	5001855646								
DESCRIZIONE / DESCRIPTION										
<p>Serie pastiglie freno anteriore e posteriore Set of brake pads front and rear</p> <table border="1"> <thead> <tr> <th>WVA</th> <th>Larghezza Width - mm.</th> <th>Altezza Height - mm.</th> <th>Spessore Thickness - mm.</th> </tr> </thead> <tbody> <tr> <td>29131</td> <td>250</td> <td>118</td> <td>30</td> </tr> </tbody> </table> 			WVA	Larghezza Width - mm.	Altezza Height - mm.	Spessore Thickness - mm.	29131	250	118	30
WVA	Larghezza Width - mm.	Altezza Height - mm.	Spessore Thickness - mm.							
29131	250	118	30							
ILLUSTRAZIONE / ILLUSTRATION	NOSTRO RIFERIMENTO OUR REFERENCE	RIFERIMENTO COSTRUTTORE O.E. REFERENCE								
<p>Connettore Ovale - Lungh. mm. 580 Oval connector - Length mm. 580</p>  <p>(1)</p>	960814	5001822987/A (1)								
ILLUSTRAZIONE / ILLUSTRATION	NOSTRO RIFERIMENTO OUR REFERENCE	RIFERIMENTO COSTRUTTORE O.E. REFERENCE								
<p>Connettore Quadro - Lungh. mm. 350 Square connector - Length mm. 350</p>  <p>(2)</p>	960434	68325408 (2)								
DESCRIZIONE / DESCRIPTION										
<p>Kit segnalatori usura freno anteriore e posteriore (2 pz.) Set of brake wear indicators front and rear (2 pcs)</p>										

TIPO DI VEICOLO / VEHICLE TYPE

MAGNUM E-TECH

400.10 - 400.24 - 400.26 (05/00)

440.18 - 440.24 - 440.26 (05/00)

480.18 - 480.24 - 480.26 (05/00)

(ASSALE POSTERIORE - REAR AXLE)

ILLUSTRAZIONE / ILLUSTRATION	NOSTRO RIFERIMENTO OUR REFERENCE	RIFERIMENTO COSTRUTTORE O.E. REFERENCE								
	960226	5010422364								
DESCRIZIONE / DESCRIPTION										
<p>Disco freno assale posteriore Brake disc rear axle</p> <p>Fascia AUTOVENTILANTE SELF-VENTILATED Band</p>										
ILLUSTRAZIONE / ILLUSTRATION	NOSTRO RIFERIMENTO OUR REFERENCE	RIFERIMENTO COSTRUTTORE O.E. REFERENCE								
<p>IMPIANTO MERITOR MERITOR SYSTEM D-ELSA 2</p>	960983	5001855646								
DESCRIZIONE / DESCRIPTION										
<p>Serie pastiglie freno anteriore e posteriore Set of brake pads front and rear</p> <table border="1"> <thead> <tr> <th>WVA</th> <th>Larghezza Width - mm.</th> <th>Altezza Height - mm.</th> <th>Spessore Thickness - mm.</th> </tr> </thead> <tbody> <tr> <td>29131</td> <td>250</td> <td>118</td> <td>30</td> </tr> </tbody> </table>			WVA	Larghezza Width - mm.	Altezza Height - mm.	Spessore Thickness - mm.	29131	250	118	30
WVA	Larghezza Width - mm.	Altezza Height - mm.	Spessore Thickness - mm.							
29131	250	118	30							
ILLUSTRAZIONE / ILLUSTRATION	NOSTRO RIFERIMENTO OUR REFERENCE	RIFERIMENTO COSTRUTTORE O.E. REFERENCE								
<p>Connettore Ovale - Lungh. mm. 580 Oval connector - Length mm. 580</p> <p>(1)</p>	960814	5001822987/A (1)								
ILLUSTRAZIONE / ILLUSTRATION	NOSTRO RIFERIMENTO OUR REFERENCE	RIFERIMENTO COSTRUTTORE O.E. REFERENCE								
<p>Connettore Quadro - Lungh. mm. 350 Square connector - Length mm. 350</p> <p>(2)</p>	960434	68325408 (2)								
DESCRIZIONE / DESCRIPTION										
<p>Kit segnalatori usura freno anteriore e posteriore (2 pz.) Set of brake wear indicators front and rear (2 pcs)</p>										

TIPO DI VEICOLO / VEHICLE TYPE

MAGNUM DXI 12 440.18 - 440.24 - 440.26 - 480.18 - 480.24 - 480.26
(dal 05/2006 - from 05/2006)

MAGNUM DXI 13 460.18 - 460.24 - 460.26 - 500.18 - 500.24 - 500.26

PREMIUM DISTRIBUTION 2

PREMIUM ROUTE 2 (dal 10/2005 - from 10/2005)

ILLUSTRAZIONE / ILLUSTRATION

NOSTRO RIFERIMENTO
OUR REFERENCERIFERIMENTO COSTRUTTORE
O.E. REFERENCE**960225**

050018644980

DISPONIBILE A MAGAZZINO
AVAILABLE ON STOCK

DESCRIZIONE / DESCRIPTION

Disco freno assale anteriore e posteriore
Brake disc rear and front axle

Fascia AUTOVENTILANTE
SELF-VENTILATED Band

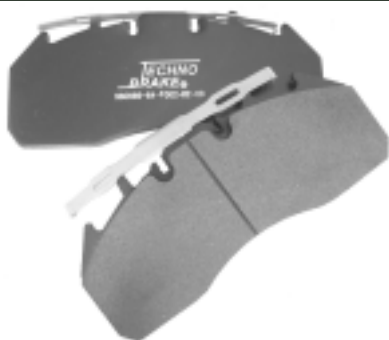

ILLUSTRAZIONE / ILLUSTRATION

NOSTRO RIFERIMENTO
OUR REFERENCERIFERIMENTO COSTRUTTORE
O.E. REFERENCE**960989**5001864363
5001864364

IMPIANTO MERITOR
MERITOR SYSTEM
ELSA 225-3

DESCRIZIONE / DESCRIPTION

Serie pastiglie freno anteriore e posteriore
Set of brake pads front and rear

WVA	Larghezza Width - mm.	Altezza Height - mm.	Spessore Thickness - mm.
29174	249.30	109.70	29.30
29204			



ILLUSTRAZIONE / ILLUSTRATION

NOSTRO RIFERIMENTO
OUR REFERENCERIFERIMENTO COSTRUTTORE
O.E. REFERENCE**960434**

68325408

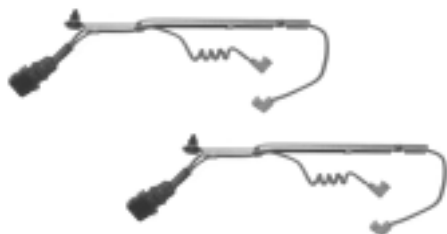

Connettore Quadro - Lungh. mm. 350
Square connector - Length mm. 350

DESCRIZIONE / DESCRIPTION

Kit segnalatori usura freno anteriore e posteriore (2 pz.)
Set of brake wear indicators front and rear (2 pcs)



TIPO DI VEICOLO / VEHICLE TYPE

- SERIE 94** (da 08/96 - from 08/96)
- SERIE 114** (da 05/96 - from 05/96)
- SERIE 124** (da 05/96 - from 05/96)
- SERIE 144** (da 11/95 - from 11/95)
- SERIE 164** (da 05/00 - from 05/00)

ILLUSTRAZIONE / ILLUSTRATION	NOSTRO RIFERIMENTO OUR REFERENCE	RIFERIMENTO COSTRUTTORE O.E. REFERENCE																								
	960052	1402272 1386686																								
DESCRIZIONE / DESCRIPTION																										
<p>Disco freno assale anteriore e posteriore Brake disc front and rear axle</p> <p>Fascia AUTOVENTILANTE SELF-VENTILATED Band</p>																										
ILLUSTRAZIONE / ILLUSTRATION	NOSTRO RIFERIMENTO OUR REFERENCE	RIFERIMENTO COSTRUTTORE O.E. REFERENCE																								
	960944	1390428																								
DESCRIZIONE / DESCRIPTION																										
<p>Serie pastiglie freno anteriore e posteriore completa di molle kit accessori SENZA piastre (1) Set of brake pads front and rear with springs, kit accessories WITHOUT plates (1)</p>																										
NOSTRO RIFERIMENTO OUR REFERENCE																										
960944/C																										
DESCRIZIONE / DESCRIPTION																										
<p>Serie pastiglie freno anteriore e posteriore completa di molle, kit accessori e piastre (2) Set of brake pads front and rear with springs, kit accessories and plates (2)</p>																										
BREVETTO PENDENTE PENDING PATENT																										
<table border="1" style="width: 100%; border-collapse: collapse;"> <thead> <tr> <th style="text-align: left;">WVA</th> <th style="text-align: center;">Larghezza Width - mm.</th> <th style="text-align: center;">Altezza Height - mm.</th> <th style="text-align: center;">Spessore Thickness - mm.</th> </tr> </thead> <tbody> <tr> <td>29087</td> <td style="text-align: center;">247,2</td> <td style="text-align: center;">109,7</td> <td style="text-align: center;">30</td> </tr> <tr> <td>29105</td> <td></td> <td></td> <td></td> </tr> <tr> <td>29108</td> <td></td> <td></td> <td></td> </tr> <tr> <td>29059</td> <td></td> <td></td> <td></td> </tr> <tr> <td>29061</td> <td></td> <td></td> <td></td> </tr> </tbody> </table>			WVA	Larghezza Width - mm.	Altezza Height - mm.	Spessore Thickness - mm.	29087	247,2	109,7	30	29105				29108				29059				29061			
WVA	Larghezza Width - mm.	Altezza Height - mm.	Spessore Thickness - mm.																							
29087	247,2	109,7	30																							
29105																										
29108																										
29059																										
29061																										

TIPO DI VEICOLO / VEHICLE TYPE

SERIE 94 (da 08/96 - from 08/96)
SERIE 114 (da 05/96 - from 05/96)
SERIE 124 (da 05/96 - from 05/96)
SERIE 144 (da 11/95 - from 11/95)
SERIE 164 (da 05/00 - from 05/00)

ILLUSTRAZIONE / ILLUSTRATION	NOSTRO RIFERIMENTO OUR REFERENCE	RIFERIMENTO COSTRUTTORE O.E. REFERENCE
 <p>Connettore klips - Lungh. 1285 (2) - 285 (2) Klips connector - Length 1285 (2) - 285 (2)</p>	960975	-
 <p>Connettore klips - Lungh.mm. 285 Klips connector - Length mm. 285</p>	960838	1388953
 <p>Connettore Tondo - Lungh. mm.300 Round connector - Length mm.300</p>	960523	-

TIPO DI VEICOLO / VEHICLE TYPE

FL 4.08 (02/86-10/89)

FL 6.08 - 6.10 - 6.11 - 6.12 - 6.14

FL 6.15 - 6.19 (11/91-09/98)

Assale anteriore e posteriore - Front and rear axle

Assale anteriore - Front axle

Assale anteriore - Front axle

ILLUSTRAZIONE / ILLUSTRATION	NOSTRO RIFERIMENTO OUR REFERENCE	RIFERIMENTO COSTRUTTORE O.E. REFERENCE												
	960310	6779208 6779205												
DESCRIZIONE / DESCRIPTION														
<p>Disco freno assale anteriore e posteriore Brake disc front and rear axle</p> <p>Fascia AUTOVENTILANTE SELF-VENTILATED Band</p>														
ILLUSTRAZIONE / ILLUSTRATION	NOSTRO RIFERIMENTO OUR REFERENCE	RIFERIMENTO COSTRUTTORE O.E. REFERENCE												
<p>Connettore a puntale - Lungh. mm. 230 Tag connector - Length mm. 230</p>	960927	2761476												
DESCRIZIONE / DESCRIPTION														
<p>Serie pastiglie freno anteriore e posteriore Set of brake pads front and rear</p> <table border="1"> <thead> <tr> <th>WVA</th> <th>Larghezza Width - mm.</th> <th>Altezza Height - mm.</th> <th>Spessore Thickness - mm.</th> </tr> </thead> <tbody> <tr> <td>29039</td> <td>175.5</td> <td>78</td> <td>21</td> </tr> <tr> <td>29302</td> <td></td> <td></td> <td></td> </tr> </tbody> </table>			WVA	Larghezza Width - mm.	Altezza Height - mm.	Spessore Thickness - mm.	29039	175.5	78	21	29302			
WVA	Larghezza Width - mm.	Altezza Height - mm.	Spessore Thickness - mm.											
29039	175.5	78	21											
29302														
ILLUSTRAZIONE / ILLUSTRATION	NOSTRO RIFERIMENTO OUR REFERENCE	RIFERIMENTO COSTRUTTORE O.E. REFERENCE												
	960963	3090048												
DESCRIZIONE / DESCRIPTION														
<p>Serie pastiglie freno anteriore e posteriore Set of brake pads front and rear</p> <table border="1"> <thead> <tr> <th>WVA</th> <th>Larghezza Width - mm.</th> <th>Altezza Height - mm.</th> <th>Spessore Thickness - mm.</th> </tr> </thead> <tbody> <tr> <td>29302</td> <td>175.5</td> <td>77</td> <td>21</td> </tr> </tbody> </table>			WVA	Larghezza Width - mm.	Altezza Height - mm.	Spessore Thickness - mm.	29302	175.5	77	21				
WVA	Larghezza Width - mm.	Altezza Height - mm.	Spessore Thickness - mm.											
29302	175.5	77	21											
ILLUSTRAZIONE / ILLUSTRATION	NOSTRO RIFERIMENTO OUR REFERENCE	RIFERIMENTO COSTRUTTORE O.E. REFERENCE												
<p>Connettore a puntale - Lungh. mm. 230 Tag connector - Length mm. 230</p>	960978	-												
DESCRIZIONE / DESCRIPTION														
<p>Kit segnalatori usura freno anteriore e posteriore (2 pz.) Set of brake wear indicators front and rear (2 pcs)</p>														

TIPO DI VEICOLO / VEHICLE TYPE

FL 4.08 (02/86-10/89)

ILLUSTRAZIONE / ILLUSTRATION	NOSTRO RIFERIMENTO OUR REFERENCE	RIFERIMENTO COSTRUTTORE O.E. REFERENCE												
<p>TH min. 28,00 mm.</p> <p>6 Fori - 6 Holes Ø 164 mm.</p> <p>115 mm.</p> <p>30 mm.</p> <p>Ø 322 mm.</p>  <p>Fascia AUTOVENTILANTE SELF-VENTILATED Band</p>	960312	6779209 6779203												
DESCRIZIONE / DESCRIPTION														
Disco freno assale posteriore Brake disc rear axle														
														
ILLUSTRAZIONE / ILLUSTRATION	NOSTRO RIFERIMENTO OUR REFERENCE	RIFERIMENTO COSTRUTTORE O.E. REFERENCE												
<p>Connettore a puntale - Lungh. mm. 230 Tag connector - Length mm. 230</p>  <p>E3 90R</p>	960927	2761476												
DESCRIZIONE / DESCRIPTION														
Serie pastiglie freno anteriore e posteriore Set of brake pads front and rear														
<table border="1"> <thead> <tr> <th>WVA</th> <th>Larghezza Width - mm.</th> <th>Altezza Height - mm.</th> <th>Spessore Thickness - mm.</th> </tr> </thead> <tbody> <tr> <td>29039</td> <td>175.5</td> <td>78</td> <td>21</td> </tr> <tr> <td>29302</td> <td></td> <td></td> <td></td> </tr> </tbody> </table>			WVA	Larghezza Width - mm.	Altezza Height - mm.	Spessore Thickness - mm.	29039	175.5	78	21	29302			
WVA	Larghezza Width - mm.	Altezza Height - mm.	Spessore Thickness - mm.											
29039	175.5	78	21											
29302														
														
ILLUSTRAZIONE / ILLUSTRATION	NOSTRO RIFERIMENTO OUR REFERENCE	RIFERIMENTO COSTRUTTORE O.E. REFERENCE												
 <p>E3 90R</p>	960963	3090048												
DESCRIZIONE / DESCRIPTION														
Serie pastiglie freno anteriore e posteriore Set of brake pads front and rear														
<table border="1"> <thead> <tr> <th>WVA</th> <th>Larghezza Width - mm.</th> <th>Altezza Height - mm.</th> <th>Spessore Thickness - mm.</th> </tr> </thead> <tbody> <tr> <td>29302</td> <td>175.5</td> <td>77</td> <td>21</td> </tr> </tbody> </table>			WVA	Larghezza Width - mm.	Altezza Height - mm.	Spessore Thickness - mm.	29302	175.5	77	21				
WVA	Larghezza Width - mm.	Altezza Height - mm.	Spessore Thickness - mm.											
29302	175.5	77	21											
														
ILLUSTRAZIONE / ILLUSTRATION	NOSTRO RIFERIMENTO OUR REFERENCE	RIFERIMENTO COSTRUTTORE O.E. REFERENCE												
<p>Connettore a puntale - Lungh. mm. 230 Tag connector - Length mm. 230</p> 	960978	-												
DESCRIZIONE / DESCRIPTION														
Kit segnalatori usura freno anteriore e posteriore (2 pz.) Set of brake wear indicators front and rear (2 pcs)														

TIPO DI VEICOLO / VEHICLE TYPE

FL 6.08 - 6.09 - 6.10 - 6.11 - 6.12 - 6.14 - 6.15 - 6.19 (11/91-09/98)

ILLUSTRAZIONE / ILLUSTRATION	NOSTRO RIFERIMENTO OUR REFERENCE	RIFERIMENTO COSTRUTTORE O.E. REFERENCE												
<p>TH min. 27,00 mm.</p> <p>8 Fori - 8 Holes</p> <p>Ø 132 mm.</p> <p>90 mm.</p> <p>30 mm.</p> <p>Ø 322 mm.</p> 	960311	6774686 6774687												
DESCRIZIONE / DESCRIPTION														
Disco freno assale anteriore Brake disc front axle														
														
Fascia AUTOVENTILANTE SELF-VENTILATED Band														
ILLUSTRAZIONE / ILLUSTRATION	NOSTRO RIFERIMENTO OUR REFERENCE	RIFERIMENTO COSTRUTTORE O.E. REFERENCE												
<p>Connettore a puntale - Lungh. mm. 230 Tag connector - Length mm. 230</p>  <p>E3 90R</p>	960927	2761476												
DESCRIZIONE / DESCRIPTION														
Serie pastiglie freno anteriore e posteriore Set of brake pads front and rear														
<table border="1"> <thead> <tr> <th>WVA</th> <th>Larghezza Width - mm.</th> <th>Altezza Height - mm.</th> <th>Spessore Thickness - mm.</th> </tr> </thead> <tbody> <tr> <td>29039</td> <td>175.5</td> <td>78</td> <td>21</td> </tr> <tr> <td>29302</td> <td></td> <td></td> <td></td> </tr> </tbody> </table>			WVA	Larghezza Width - mm.	Altezza Height - mm.	Spessore Thickness - mm.	29039	175.5	78	21	29302			
WVA	Larghezza Width - mm.	Altezza Height - mm.	Spessore Thickness - mm.											
29039	175.5	78	21											
29302														
														
ILLUSTRAZIONE / ILLUSTRATION	NOSTRO RIFERIMENTO OUR REFERENCE	RIFERIMENTO COSTRUTTORE O.E. REFERENCE												
 <p>E3 90R</p>	960963	3090048												
DESCRIZIONE / DESCRIPTION														
Serie pastiglie freno anteriore e posteriore Set of brake pads front and rear														
<table border="1"> <thead> <tr> <th>WVA</th> <th>Larghezza Width - mm.</th> <th>Altezza Height - mm.</th> <th>Spessore Thickness - mm.</th> </tr> </thead> <tbody> <tr> <td>29302</td> <td>175.5</td> <td>77</td> <td>21</td> </tr> </tbody> </table>			WVA	Larghezza Width - mm.	Altezza Height - mm.	Spessore Thickness - mm.	29302	175.5	77	21				
WVA	Larghezza Width - mm.	Altezza Height - mm.	Spessore Thickness - mm.											
29302	175.5	77	21											
														
ILLUSTRAZIONE / ILLUSTRATION	NOSTRO RIFERIMENTO OUR REFERENCE	RIFERIMENTO COSTRUTTORE O.E. REFERENCE												
<p>Connettore a puntale - Lungh. mm. 230 Tag connector - Length mm. 230</p> 	960978	-												
DESCRIZIONE / DESCRIPTION														
Kit segnalatori usura freno anteriore e posteriore (2 pz.) Set of brake wear indicators front and rear (2 pcs)														

TIPO DI VEICOLO / VEHICLE TYPE

FL 6.08 - 6.09 - 6.10 - 6.11 - 6.12 - 6.14 - 6.15 - 6.19 (11/91-09/98)

Per veicoli senza ABS - For vehicles without ABS

ILLUSTRAZIONE / ILLUSTRATION	NOSTRO RIFERIMENTO OUR REFERENCE	RIFERIMENTO COSTRUTTORE O.E. REFERENCE												
<p>TH min. 27,00 mm. Ø 216 mm. 8 Fori - 8 Holes</p> 	960387	6775227 6775229												
DESCRIZIONE / DESCRIPTION														
<p>Disco freno assale posteriore Brake disc rear axle</p> <p>Fascia AUTOVENTILANTE SELF-VENTILATED Band</p> 														
ILLUSTRAZIONE / ILLUSTRATION	NOSTRO RIFERIMENTO OUR REFERENCE	RIFERIMENTO COSTRUTTORE O.E. REFERENCE												
<p>Connettore a puntale - Lungh. mm. 230 Tag connector - Length mm. 230</p> 	960927	2761476												
DESCRIZIONE / DESCRIPTION														
<p>Serie pastiglie freno anteriore e posteriore Set of brake pads front and rear</p> <table border="1"> <thead> <tr> <th>WVA</th> <th>Larghezza Width - mm.</th> <th>Altezza Height - mm.</th> <th>Spessore Thickness - mm.</th> </tr> </thead> <tbody> <tr> <td>29039</td> <td>175.5</td> <td>78</td> <td>21</td> </tr> <tr> <td>29302</td> <td></td> <td></td> <td></td> </tr> </tbody> </table> 			WVA	Larghezza Width - mm.	Altezza Height - mm.	Spessore Thickness - mm.	29039	175.5	78	21	29302			
WVA	Larghezza Width - mm.	Altezza Height - mm.	Spessore Thickness - mm.											
29039	175.5	78	21											
29302														
ILLUSTRAZIONE / ILLUSTRATION	NOSTRO RIFERIMENTO OUR REFERENCE	RIFERIMENTO COSTRUTTORE O.E. REFERENCE												
	960963	3090048												
DESCRIZIONE / DESCRIPTION														
<p>Serie pastiglie freno anteriore e posteriore Set of brake pads front and rear</p> <table border="1"> <thead> <tr> <th>WVA</th> <th>Larghezza Width - mm.</th> <th>Altezza Height - mm.</th> <th>Spessore Thickness - mm.</th> </tr> </thead> <tbody> <tr> <td>29302</td> <td>175.5</td> <td>77</td> <td>21</td> </tr> </tbody> </table> 			WVA	Larghezza Width - mm.	Altezza Height - mm.	Spessore Thickness - mm.	29302	175.5	77	21				
WVA	Larghezza Width - mm.	Altezza Height - mm.	Spessore Thickness - mm.											
29302	175.5	77	21											
ILLUSTRAZIONE / ILLUSTRATION	NOSTRO RIFERIMENTO OUR REFERENCE	RIFERIMENTO COSTRUTTORE O.E. REFERENCE												
<p>Connettore a puntale - Lungh. mm. 230 Tag connector - Length mm. 230</p> 	960978	-												
DESCRIZIONE / DESCRIPTION														
<p>Kit segnalatori usura freno anteriore e posteriore (2 pz.) Set of brake wear indicators front and rear (2 pcs)</p>														

TIPO DI VEICOLO / VEHICLE TYPE

FL 6.08 - 6.09 - 6.10 - 6.11 - 6.12 - 6.14 - 6.15 - 6.19 (11/91-09/98)

Per veicoli con ABS - For vehicles with ABS

ILLUSTRAZIONE / ILLUSTRATION	NOSTRO RIFERIMENTO OUR REFERENCE	RIFERIMENTO COSTRUTTORE O.E. REFERENCE												
<p>TH min. 27,00 mm.</p> <p>Ø 216 mm.</p> <p>8 Fori 8 Holes</p>	960388	6796864 6796844												
DESCRIZIONE / DESCRIPTION														
<p>Disco freno assale posteriore Brake disc rear axle</p> <p>Fascia AUTOVENTILANTE SELF-VENTILATED Band</p>														
ILLUSTRAZIONE / ILLUSTRATION	NOSTRO RIFERIMENTO OUR REFERENCE	RIFERIMENTO COSTRUTTORE O.E. REFERENCE												
<p>Connettore a puntale - Lungh. mm. 230 Tag connector - Length mm. 230</p>	960927	2761476												
DESCRIZIONE / DESCRIPTION														
<p>Serie pastiglie freno anteriore e posteriore Set of brake pads front and rear</p> <table border="1"> <thead> <tr> <th>WVA</th> <th>Larghezza Width - mm.</th> <th>Altezza Height - mm.</th> <th>Spessore Thickness - mm.</th> </tr> </thead> <tbody> <tr> <td>29039</td> <td>175.5</td> <td>78</td> <td>21</td> </tr> <tr> <td>29302</td> <td></td> <td></td> <td></td> </tr> </tbody> </table>			WVA	Larghezza Width - mm.	Altezza Height - mm.	Spessore Thickness - mm.	29039	175.5	78	21	29302			
WVA	Larghezza Width - mm.	Altezza Height - mm.	Spessore Thickness - mm.											
29039	175.5	78	21											
29302														
ILLUSTRAZIONE / ILLUSTRATION	NOSTRO RIFERIMENTO OUR REFERENCE	RIFERIMENTO COSTRUTTORE O.E. REFERENCE												
	960963	3090048												
DESCRIZIONE / DESCRIPTION														
<p>Serie pastiglie freno anteriore e posteriore Set of brake pads front and rear</p> <table border="1"> <thead> <tr> <th>WVA</th> <th>Larghezza Width - mm.</th> <th>Altezza Height - mm.</th> <th>Spessore Thickness - mm.</th> </tr> </thead> <tbody> <tr> <td>29302</td> <td>175.5</td> <td>77</td> <td>21</td> </tr> </tbody> </table>			WVA	Larghezza Width - mm.	Altezza Height - mm.	Spessore Thickness - mm.	29302	175.5	77	21				
WVA	Larghezza Width - mm.	Altezza Height - mm.	Spessore Thickness - mm.											
29302	175.5	77	21											
ILLUSTRAZIONE / ILLUSTRATION	NOSTRO RIFERIMENTO OUR REFERENCE	RIFERIMENTO COSTRUTTORE O.E. REFERENCE												
<p>Connettore a puntale - Lungh. mm. 230 Tag connector - Length mm. 230</p>	960978	-												
DESCRIZIONE / DESCRIPTION														
<p>Kit segnalatori usura freno anteriore e posteriore (2 pz.) Set of brake wear indicators front and rear (2 pcs)</p>														

TIPO DI VEICOLO / VEHICLE TYPE

FL6 (nuovo modello dal 2005 / New Model from 2005)

ILLUSTRAZIONE / ILLUSTRATION	NOSTRO RIFERIMENTO OUR REFERENCE	RIFERIMENTO COSTRUTTORE O.E. REFERENCE												
<p>TH min. 37,00 mm.</p> <p>8 Fori 8 Holes</p>  <p>150 mm.</p> <p>45 mm.</p> <p>Ø 375 mm.</p>	960407	3095673												
DESCRIZIONE / DESCRIPTION														
<p>Disco freno assale posteriore Brake disc rear axle</p> <p>Fascia AUTOVENTILANTE SELF-VENTILATED Band</p> 														
ILLUSTRAZIONE / ILLUSTRATION	NOSTRO RIFERIMENTO OUR REFERENCE	RIFERIMENTO COSTRUTTORE O.E. REFERENCE												
 <p>E3 90R</p>	960394	63834665												
DESCRIZIONE / DESCRIPTION														
<p>Serie pastiglie freno Set of brake pads</p> <table border="1"> <thead> <tr> <th>WVA</th> <th>Larghezza Width - mm.</th> <th>Altezza Height - mm.</th> <th>Spessore Thickness - mm.</th> </tr> </thead> <tbody> <tr> <td>29169</td> <td>210.70</td> <td>100</td> <td>30</td> </tr> <tr> <td>29177</td> <td></td> <td></td> <td></td> </tr> </tbody> </table> 			WVA	Larghezza Width - mm.	Altezza Height - mm.	Spessore Thickness - mm.	29169	210.70	100	30	29177			
WVA	Larghezza Width - mm.	Altezza Height - mm.	Spessore Thickness - mm.											
29169	210.70	100	30											
29177														
ILLUSTRAZIONE / ILLUSTRATION	NOSTRO RIFERIMENTO OUR REFERENCE	RIFERIMENTO COSTRUTTORE O.E. REFERENCE												
 <p>E3 90R</p>	960271	20568712												
DESCRIZIONE / DESCRIPTION														
<p>Serie pastiglie freno anteriore e posteriore Set of brake pads front and rear</p> <table border="1"> <thead> <tr> <th>WVA</th> <th>Larghezza Width - mm.</th> <th>Altezza Height - mm.</th> <th>Spessore Thickness - mm.</th> </tr> </thead> <tbody> <tr> <td>29173</td> <td>216,20</td> <td>97</td> <td>29,20</td> </tr> </tbody> </table> 			WVA	Larghezza Width - mm.	Altezza Height - mm.	Spessore Thickness - mm.	29173	216,20	97	29,20				
WVA	Larghezza Width - mm.	Altezza Height - mm.	Spessore Thickness - mm.											
29173	216,20	97	29,20											
ILLUSTRAZIONE / ILLUSTRATION	NOSTRO RIFERIMENTO OUR REFERENCE	RIFERIMENTO COSTRUTTORE O.E. REFERENCE												
 <p>Ovale - Oval L = 380 mm</p>	960525	-												
DESCRIZIONE / DESCRIPTION														
<p>Kit segnalatori usura freno (2 pz.) Set of brake wear indicators (2 pcs)</p>														

TIPO DI VEICOLO / VEHICLE TYPE

FH 12 (08/93)
 FH 12 (01/95)
 FL 6 (11/91 - 03/00)
 FH 16 (08/93)
 FH 16 (01/03)
 FM (12/01 - 09/05)

ILLUSTRAZIONE / ILLUSTRATION

NOSTRO RIFERIMENTO
OUR REFERENCERIFERIMENTO COSTRUTTORE
O.E. REFERENCE**960370**

0851038030

DISPONIBILE A MAGAZZINO
 AVAILABLE ON STOCK

DESCRIZIONE / DESCRIPTION

Disco freno assale posteriore
 Brake disc rear axle

Fascia AUTOVENTILANTE
 SELF-VENTILATED Band



ILLUSTRAZIONE / ILLUSTRATION

NOSTRO RIFERIMENTO
OUR REFERENCERIFERIMENTO COSTRUTTORE
O.E. REFERENCE**960993**3095396
20918891 - 1078439

E3 90R

DESCRIZIONE / DESCRIPTION

Serie pastiglie freno posteriore
 Set of brake pads rear

Impianto Frenante
 Brake System
 Meritor D-DUCO

WVA	Larghezza Width - mm.	Altezza Height - mm.	Spessore Thickness - mm.
29125	249	111.2	29



ILLUSTRAZIONE / ILLUSTRATION

NOSTRO RIFERIMENTO
OUR REFERENCERIFERIMENTO COSTRUTTORE
O.E. REFERENCE**960349**

3099533 - 20768101



E3 90R

DESCRIZIONE / DESCRIPTION

Serie pastiglie freno posteriore
 Set of brake pads rear

Impianto Frenante
 Brake System
 Meritor DLE-DUCO

WVA	Larghezza Width - mm.	Altezza Height - mm.	Spessore Thickness - mm.
29151	216.10	97	29.20



TIPO DI VEICOLO / VEHICLE TYPE

FH 12 (08/93)
 FH 12 (01/95)
 FL 6 (11/91 - 03/00)
 FH 16 (08/93)
 FH 16 (01/03)
 FM (12/01 - 09/05)

ILLUSTRAZIONE / ILLUSTRATION

NOSTRO RIFERIMENTO
OUR REFERENCERIFERIMENTO COSTRUTTORE
O.E. REFERENCE

960374

03092710

DISPONIBILE A MAGAZZINO
 AVAILABLE ON STOCK

DESCRIZIONE / DESCRIPTION

Disco freno assale posteriore
 Brake disc rear axle

Fascia PIENA
 FULL Band



ILLUSTRAZIONE / ILLUSTRATION

NOSTRO RIFERIMENTO
OUR REFERENCERIFERIMENTO COSTRUTTORE
O.E. REFERENCE

960993

3095396
 20918891 - 1078439



DESCRIZIONE / DESCRIPTION

Serie pastiglie freno posteriore
 Set of brake pads rear

Impianto Frenante
 Brake System
 Meritor D-DUCO

WVA	Larghezza Width - mm.	Altezza Height - mm.	Spessore Thickness - mm.
29125	249	111.2	29



ILLUSTRAZIONE / ILLUSTRATION

NOSTRO RIFERIMENTO
OUR REFERENCERIFERIMENTO COSTRUTTORE
O.E. REFERENCE

960349

3099533 - 20768101



DESCRIZIONE / DESCRIPTION

Serie pastiglie freno posteriore
 Set of brake pads rear

Impianto Frenante
 Brake System
 Meritor DLE-DUCO

WVA	Larghezza Width - mm.	Altezza Height - mm.	Spessore Thickness - mm.
29151	216.10	97	29.20



TIPO DI VEICOLO / VEHICLE TYPE

FE (dal 05/2006 - from 05/2006)
FH 16 (dal 09/2006 - from 09/2006)
FH 400-440-480-520 (dal 09/2005 - from 09/2005)
FH 500 (dal 09/2007 - from 09/2007)
FM (dal 09/2005 - from 09/2005)

ILLUSTRAZIONE / ILLUSTRATION

NOSTRO RIFERIMENTO OUR REFERENCE

RIFERIMENTO COSTRUTTORE O.E. REFERENCE

960370

0851038030

**DISPONIBILE A MAGAZZINO
AVAILABLE ON STOCK**

DESCRIZIONE / DESCRIPTION

Disco freno assale posteriore
 Brake disc rear axle

Fascia AUTOVENTILANTE
 SELF-VENTILATED Band



ILLUSTRAZIONE / ILLUSTRATION

NOSTRO RIFERIMENTO OUR REFERENCE

RIFERIMENTO COSTRUTTORE O.E. REFERENCE

970006

20568711 - 20568714



E3 90R

DESCRIZIONE / DESCRIPTION

Serie pastiglie freno anteriore e posteriore
 Set of brake pads front and rear

WVA	Larghezza Width - mm.	Altezza Height - mm.	Spessore Thickness - mm.
29174	249.30	109.70	29.30
29204			



ILLUSTRAZIONE / ILLUSTRATION

NOSTRO RIFERIMENTO OUR REFERENCE

RIFERIMENTO COSTRUTTORE O.E. REFERENCE

960434

68325408

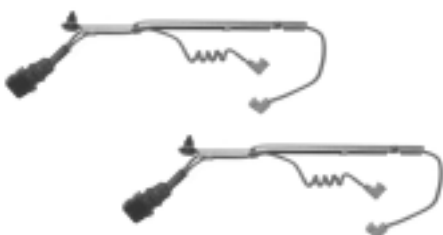





Connettore Quadro - Lungh. mm. 350
 Round connector - Length mm. 350

DESCRIZIONE / DESCRIPTION

Kit segnalatori usura freno anteriore e posteriore (2 pz.)
 Set of brake wear indicators front and rear (2 pcs)

TIPO DI VEICOLO / VEHICLE TYPE

FE (dal 05/2006 - from 05/2006)
 FH 16 (dal 09/2006 - from 09/2006)
 FH 400-440-480-520 (dal 09/2005 - from 09/2005)
 FH 500 (dal 09/2007 - from 09/2007)
 FM (dal 09/2005 - from 09/2005)

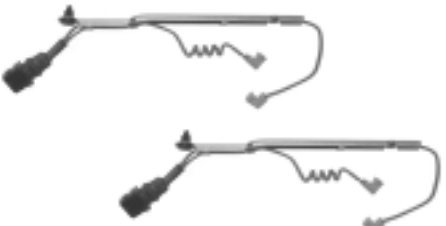
ILLUSTRAZIONE / ILLUSTRATION	NOSTRO RIFERIMENTO OUR REFERENCE	RIFERIMENTO COSTRUTTORE O.E. REFERENCE							
 <p>DISPONIBILE A MAGAZZINO AVAILABLE ON STOCK</p>	960374	03092710							
	<p>DESCRIZIONE / DESCRIPTION</p> <p>Disco freno assale posteriore Brake disc rear axle</p> <p>Fascia PIENA FULL Band</p> 								
 <p>E3 90R</p>	970006	20568711 - 20568714							
	<p>DESCRIZIONE / DESCRIPTION</p> <p>Serie pastiglie freno anteriore e posteriore Set of brake pads front and rear</p> <table border="1"> <thead> <tr> <th>WVA</th> <th>Larghezza Width - mm.</th> <th>Altezza Height - mm.</th> <th>Spessore Thickness - mm.</th> </tr> </thead> <tbody> <tr> <td>29174 29204</td> <td>249.30</td> <td>109.70</td> <td>29.30</td> </tr> </tbody> </table> 		WVA	Larghezza Width - mm.	Altezza Height - mm.	Spessore Thickness - mm.	29174 29204	249.30	109.70
WVA	Larghezza Width - mm.	Altezza Height - mm.	Spessore Thickness - mm.						
29174 29204	249.30	109.70	29.30						
 <p>Connettore Quadro - Lungh.mm. 350 Round connector - Length mm. 350</p>	960434	68325408							
	<p>DESCRIZIONE / DESCRIPTION</p> <p>Kit segnalatori usura freno anteriore e posteriore (2 pz.) Set of brake wear indicators front and rear (2 pcs)</p>								

TIPO DI VEICOLO / VEHICLE TYPE

VOLVO FL180 - FL220 - FL250 (dal 03/2000 - from 03/2000)

ILLUSTRAZIONE / ILLUSTRATION

**Impianto frenante - Brake System
MERITOR C-DUCO**



E3 90R

NOSTRO RIFERIMENTO OUR REFERENCE

960347

RIFERIMENTO COSTRUTTORE O.E. REFERENCE

3093532
20768115

DESCRIZIONE / DESCRIPTION

Serie pastiglie freno anteriore e posteriore **FL 180-220-250**
Set of brake pads front and rear **(dal 03/2000)**
(from 03/2000)

WVA	Larghezza mm.	Altezza mm.	Spessore mm.
29137	210	102.20	29.20



ILLUSTRAZIONE / ILLUSTRATION



Connettore Tondo - Lungh. mm.300
Round connector - Length mm. 300

NOSTRO RIFERIMENTO OUR REFERENCE

960523

RIFERIMENTO COSTRUTTORE O.E. REFERENCE

-

DESCRIZIONE / DESCRIPTION

Kit segnalatori usura freno (2 pz.)
Set of brake wear indicators (2 pcs)

APPLICAZIONE:
Volvo Veicoli Industriali
APPLICATION:
Volvo Industrial Vehicles

ILLUSTRAZIONE / ILLUSTRATION





NOSTRO RIFERIMENTO OUR REFERENCE

RIFERIMENTO COSTRUTTORE O.E. REFERENCE

DESCRIZIONE / DESCRIPTION

TIPO DI VEICOLO / VEHICLE TYPE

TURBOCITY 480 - 580 - 680
CITY BUS 490.12/22 - 590.22

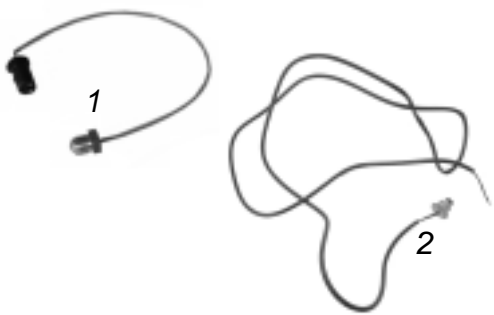
ILLUSTRAZIONE / ILLUSTRATION	NOSTRO RIFERIMENTO OUR REFERENCE	RIFERIMENTO COSTRUTTORE O.E. REFERENCE								
	960007	1907764 42063700								
DESCRIZIONE / DESCRIPTION										
<p>Serie dischi freno assale anteriore (2 Pz.) Set of brake discs front axle (2 pcs)</p> <p>Fascia AUTOVENTILANTE SELF-VENTILATED Band</p> 										
ILLUSTRAZIONE / ILLUSTRATION	NOSTRO RIFERIMENTO OUR REFERENCE	RIFERIMENTO COSTRUTTORE O.E. REFERENCE								
	960011	1906216								
DESCRIZIONE / DESCRIPTION										
<p>Serie pastiglie freno anteriore (8 pezzi) Set of brake pads front (8 pcs)</p> <table border="1"> <thead> <tr> <th>WVA</th> <th>Larghezza Width - mm.</th> <th>Altezza Height - mm.</th> <th>Spessore Thickness - mm.</th> </tr> </thead> <tbody> <tr> <td>29016 29018</td> <td>160</td> <td>111</td> <td>28</td> </tr> </tbody> </table> 			WVA	Larghezza Width - mm.	Altezza Height - mm.	Spessore Thickness - mm.	29016 29018	160	111	28
WVA	Larghezza Width - mm.	Altezza Height - mm.	Spessore Thickness - mm.							
29016 29018	160	111	28							
ILLUSTRAZIONE / ILLUSTRATION	NOSTRO RIFERIMENTO OUR REFERENCE	RIFERIMENTO COSTRUTTORE O.E. REFERENCE								
<p>Connettore tondo - Lungh. mm 195 Round connector - Length mm. 195</p>  <p>Lungh./Length mm 1480</p>	960931 960508	4823690 (1) 42539439 - 42532158 (2)								
DESCRIZIONE / DESCRIPTION										
<p>Segnalatore usura freno anteriore Brake wear indicator front</p> <p>Indicatore usura freno a disco Disc brake wear indicator</p>										





TIPO DI VEICOLO / VEHICLE TYPE

BUS 370S24 - 370S25 - 370S30 - 370S35 - 370SE27 - 370SE29 - 370SE35

ILLUSTRAZIONE / ILLUSTRATION	NOSTRO RIFERIMENTO OUR REFERENCE	RIFERIMENTO COSTRUTTORE O.E. REFERENCE																
<p>TH min. 26,00 mm.</p> <p>Ø 157 mm.</p> <p>10 Fori 10 Holes</p> <p>80 mm.</p> <p>30 mm.</p> <p>Ø 417 mm.</p>	<h2>960002</h2>	<h2>1904534</h2>																
DESCRIZIONE / DESCRIPTION																		
<p>Serie dischi freno assale anteriore (4 Pz.) Set of brake discs front axle (4 pcs)</p> <p>Fascia AUTOVENTILANTE SELF-VENTILATED Band</p>																		
<p>ILLUSTRAZIONE / ILLUSTRATION</p>	<p>NOSTRO RIFERIMENTO OUR REFERENCE</p>	<p>RIFERIMENTO COSTRUTTORE O.E. REFERENCE</p>																
<p>Connettore tondo - Lungh. mm. 45 Round connector - Length mm. 45</p> <p>E3 90R</p>	<h2>960952</h2>	<h2>42536301 - 42535773 93161314</h2>																
DESCRIZIONE / DESCRIPTION																		
<p>Serie pastiglie freno anteriore (8 pezzi) Set of brake pads front (8 pcs)</p> <table border="1" data-bbox="644 1451 1235 1621"> <thead> <tr> <th>WVA</th> <th>Larghezza Width - mm.</th> <th>Altezza Height - mm.</th> <th>Spessore Thickness - mm.</th> </tr> </thead> <tbody> <tr> <td>29186</td> <td>179</td> <td>106</td> <td>20</td> </tr> <tr> <td>29074</td> <td></td> <td></td> <td></td> </tr> <tr> <td>29075</td> <td></td> <td></td> <td></td> </tr> </tbody> </table>			WVA	Larghezza Width - mm.	Altezza Height - mm.	Spessore Thickness - mm.	29186	179	106	20	29074				29075			
WVA	Larghezza Width - mm.	Altezza Height - mm.	Spessore Thickness - mm.															
29186	179	106	20															
29074																		
29075																		
<p>ILLUSTRAZIONE / ILLUSTRATION</p>	<p>NOSTRO RIFERIMENTO OUR REFERENCE</p>	<p>RIFERIMENTO COSTRUTTORE O.E. REFERENCE</p>																
<p>Connettore tondo - Lungh. mm. 195 Round connector - Length mm. 195</p> <p>Lungh./Length mm 1480</p>	<h2>960931</h2> <h2>960508</h2>	<h2>4823690 (1)</h2> <h2>42539439 - 42532158 (2)</h2>																
DESCRIZIONE / DESCRIPTION																		
<p>Segnalatore usura freno anteriore Brake wear indicator front</p> <p>Indicatore usura freno a disco Disc brake wear indicator</p>																		

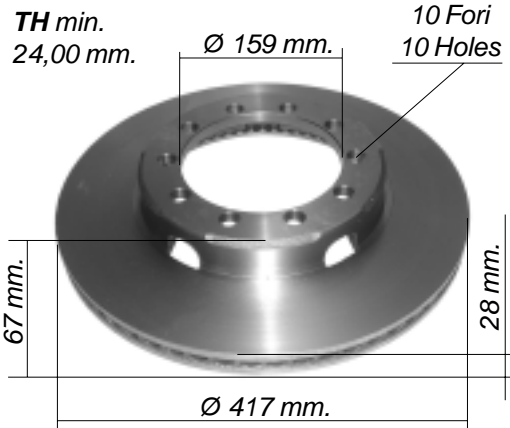
TIPO DI VEICOLO / VEHICLE TYPE

BUS 490.18
CITYCLASS.22 - .27
EUROCLASS.29 - .35
EURORIDER.29 - .35

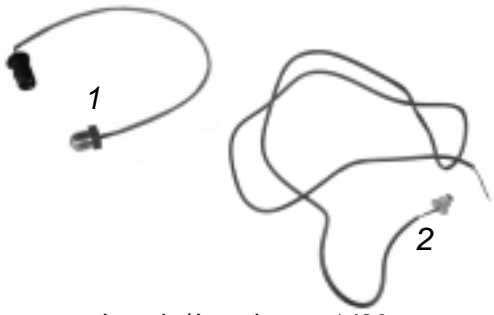
ILLUSTRAZIONE / ILLUSTRATION	NOSTRO RIFERIMENTO OUR REFERENCE	RIFERIMENTO COSTRUTTORE O.E. REFERENCE																
<p>TH min. 24,00 mm.</p> <p>Ø 159 mm.</p> <p>10 Fori 10 Holes</p> 	960003	93161407																
DESCRIZIONE / DESCRIPTION																		
<p>Serie dischi freno assale anteriore (4 Pz.) Set of brake disc front axle (4 Pz.)</p> <p>Fascia AUTOVENTILANTE SELF-VENTILATED Band</p> 																		
ILLUSTRAZIONE / ILLUSTRATION	NOSTRO RIFERIMENTO OUR REFERENCE	RIFERIMENTO COSTRUTTORE O.E. REFERENCE																
<p>Connettore tondo - Lungh. mm. 45 Round connector - Length mm. 45</p>  <p>E3 90R</p>	960952	42536301 - 42535773 93161314																
DESCRIZIONE / DESCRIPTION																		
<p>Serie pastiglie freno anteriore (8 pezzi) Set of brake pads front (8 pcs)</p> <table border="1"> <thead> <tr> <th>WVA</th> <th>Larghezza Width - mm.</th> <th>Altezza Height - mm.</th> <th>Spessore Thickness - mm.</th> </tr> </thead> <tbody> <tr> <td>29186</td> <td>179</td> <td>106</td> <td>20</td> </tr> <tr> <td>29074</td> <td></td> <td></td> <td></td> </tr> <tr> <td>29075</td> <td></td> <td></td> <td></td> </tr> </tbody> </table> 			WVA	Larghezza Width - mm.	Altezza Height - mm.	Spessore Thickness - mm.	29186	179	106	20	29074				29075			
WVA	Larghezza Width - mm.	Altezza Height - mm.	Spessore Thickness - mm.															
29186	179	106	20															
29074																		
29075																		
ILLUSTRAZIONE / ILLUSTRATION	NOSTRO RIFERIMENTO OUR REFERENCE	RIFERIMENTO COSTRUTTORE O.E. REFERENCE																
<p>Connettore tondo - Lungh. mm. 195 Round connector - Length mm. 195</p>  <p>Lungh./Length mm 1480</p>	960931 960508	4823690 (1) 42539439 - 42532158 (2)																
DESCRIZIONE / DESCRIPTION																		
<p>Segnalatore usura freno anteriore Brake wear indicator front</p> <p>Indicatore usura freno a disco Disc brake wear indicator</p>																		

TIPO DI VEICOLO / VEHICLE TYPE

EUROPOLIS 491 (2° serie) dal / from 2005

IMPIANTO MERITOR MERITOR SYSTEM

ILLUSTRAZIONE / ILLUSTRATION



NOSTRO RIFERIMENTO OUR REFERENCE

960222

RIFERIMENTO COSTRUTTORE O.E. REFERENCE

2994031

DESCRIZIONE / DESCRIPTION

Serie dischi freno assale anteriore (2 Pz.)
Set of brake disc front axle (2 pcs)



ILLUSTRAZIONE / ILLUSTRATION



NOSTRO RIFERIMENTO OUR REFERENCE

960901

RIFERIMENTO COSTRUTTORE O.E. REFERENCE

2995552

DESCRIZIONE / DESCRIPTION

Serie pastiglie freno anteriore e posteriore
Set of brake pads front and rear

WVA	Larghezza Width - mm.	Altezza Height - mm.	Spessore Thickness - mm.
29150	245	120	30



ILLUSTRAZIONE / ILLUSTRATION



Lungh./Length mm. 200

NOSTRO RIFERIMENTO OUR REFERENCE

960676

RIFERIMENTO COSTRUTTORE O.E. REFERENCE

2995553

DESCRIZIONE / DESCRIPTION

Kit segnalatori usura freno anteriore e posteriore (2 pz.)
Set of brake wear indicators front and rear (2 pcs)

TIPO DI VEICOLO / VEHICLE TYPE

EUROPOLIS 491 (2° serie) dal / from 2005

IMPIANTO MERITOR
MERITOR SYSTEM

ILLUSTRAZIONE / ILLUSTRATION

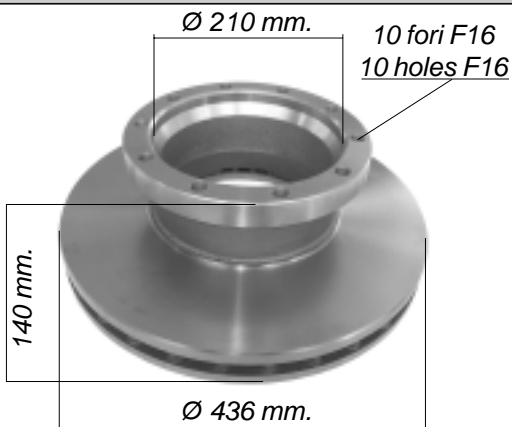
NOSTRO RIFERIMENTO
OUR REFERENCE**960224**RIFERIMENTO COSTRUTTORE
O.E. REFERENCE

2994084

DESCRIZIONE / DESCRIPTION

Serie dischi freno assale posteriore (2 Pz.)
Set of brake disc rear axle (2 pcs)

ILLUSTRAZIONE / ILLUSTRATION

NOSTRO RIFERIMENTO
OUR REFERENCE**960901**RIFERIMENTO COSTRUTTORE
O.E. REFERENCE

2995552

DESCRIZIONE / DESCRIPTION

Serie pastiglie freno anteriore e posteriore
Set of brake pads front and rear

WVA	Larghezza Width - mm.	Altezza Height - mm.	Spessore Thickness - mm.
29150	245	120	30



ILLUSTRAZIONE / ILLUSTRATION



Lungh./Length mm. 200

NOSTRO RIFERIMENTO
OUR REFERENCE**960676**RIFERIMENTO COSTRUTTORE
O.E. REFERENCE

2995553

DESCRIZIONE / DESCRIPTION

Kit segnalatori usura freno anteriore e posteriore (2 pz.)
Set of brake wear indicators front and rear (2 pcs)

TIPO DI VEICOLO / VEHICLE TYPE

IRISBUS

ILLUSTRAZIONE / ILLUSTRATION



NOSTRO RIFERIMENTO OUR REFERENCE

960221

RIFERIMENTO COSTRUTTORE O.E. REFERENCE

5001860184

DESCRIZIONE / DESCRIPTION

Disco freno assale anteriore
Brake disc front axle



TIPO DI VEICOLO / VEHICLE TYPE

BUS 315S - 316S - KASSBOHRER

ILLUSTRAZIONE / ILLUSTRATION

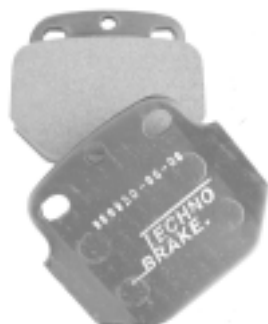

NOSTRO RIFERIMENTO OUR REFERENCE

960950

RIFERIMENTO COSTRUTTORE O.E. REFERENCE

1906118

DESCRIZIONE / DESCRIPTION

Serie pastiglie freno anteriore
Set of brake pads front

WVA	Larghezza Width - mm.	Altezza Height - mm.	Spessore Thickness - mm.
29688	109	99	25

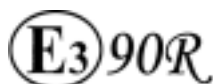

TIPO DI VEICOLO / VEHICLE TYPE

MERCEDESO303 - O305 - O404 - NEOPLAN 1991
TOURISMO (O340 - O350)

ILLUSTRAZIONE / ILLUSTRATION

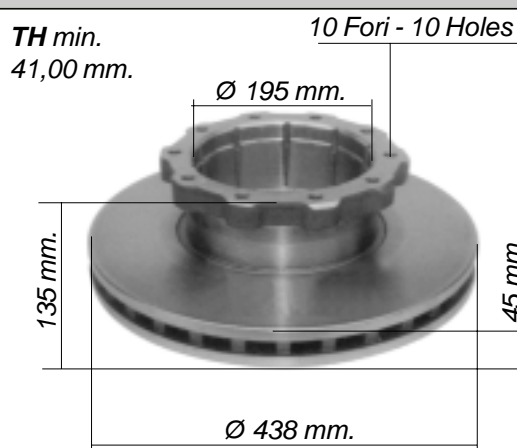
NOSTRO RIFERIMENTO
OUR REFERENCE**960315**RIFERIMENTO COSTRUTTORE
O.E. REFERENCE3564210312 - 3564211012
3564211212

DESCRIZIONE / DESCRIPTION

Disco freno assale anteriore e posteriore
Brake disc front and rear axleFascia AUTOVENTILANTE
SELF-VENTILATED Band

ILLUSTRAZIONE / ILLUSTRATION

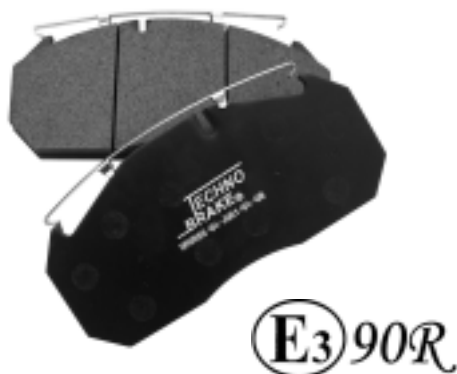
NOSTRO RIFERIMENTO
OUR REFERENCE**960956**RIFERIMENTO COSTRUTTORE
O.E. REFERENCE

0024200820

DESCRIZIONE / DESCRIPTION

Serie pastiglie freno anteriore e posteriore
Set of brake pads front and rear

WVA	Larghezza Width - mm.	Altezza Height - mm.	Spessore Thickness - mm.
29030	250	118	28
29083			
29113			

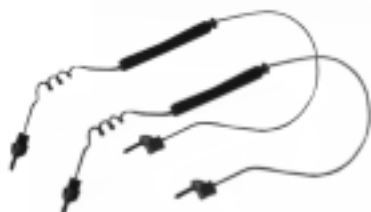

ILLUSTRAZIONE / ILLUSTRATION

Connettore Tondo - Lungh mm. 500
Round connector - Length mm. 500NOSTRO RIFERIMENTO
OUR REFERENCE**960914**RIFERIMENTO COSTRUTTORE
O.E. REFERENCE

3565400017

DESCRIZIONE / DESCRIPTION

Kit segnalatori usura freno anteriore e posteriore (2 pz.)
Set of brake wear indicators front and rear (2 pcs)

TIPO DI VEICOLO / VEHICLE TYPE

BUS
B10L - B12

ILLUSTRAZIONE / ILLUSTRATION

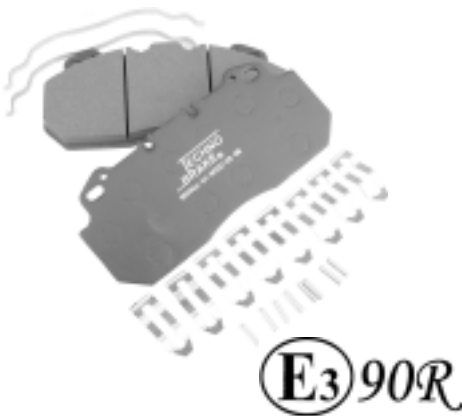

NOSTRO RIFERIMENTO
OUR REFERENCE

960964

RIFERIMENTO COSTRUTTORE
O.E. REFERENCE

3093919
8550611.1

DESCRIZIONE / DESCRIPTION

Serie pastiglie freno anteriore - Set of brake pads front

WVA	Larghezza Width - mm.	Altezza Height - mm.	Spessore Thickness - mm.
29090	250	114	28



ILLUSTRAZIONE / ILLUSTRATION

Connettore Quadro - Lungh mm 265
Round connector - Length mm. 265

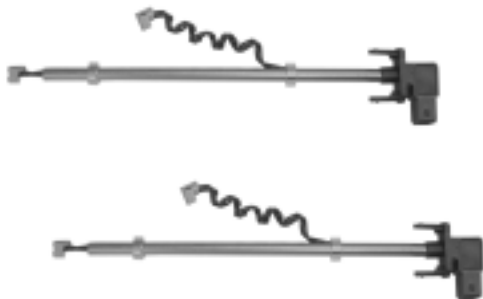

NOSTRO RIFERIMENTO
OUR REFERENCE

960977

RIFERIMENTO COSTRUTTORE
O.E. REFERENCE

3118128

DESCRIZIONE / DESCRIPTION

Kit segnalatori usura freno anteriore (2 pz.)
Set of brake wear indicators front (2 pcs)

ILLUSTRAZIONE / ILLUSTRATION

NOSTRO RIFERIMENTO
OUR REFERENCE

RIFERIMENTO COSTRUTTORE
O.E. REFERENCE

DESCRIZIONE / DESCRIPTION

TIPO DI VEICOLO / VEHICLE TYPE

SETRA BUS

S210 - S211 - S212 - S213 - S214 - S215 - S216 - S228

NEOPLAN

1802.200.62

ILLUSTRAZIONE / ILLUSTRATION

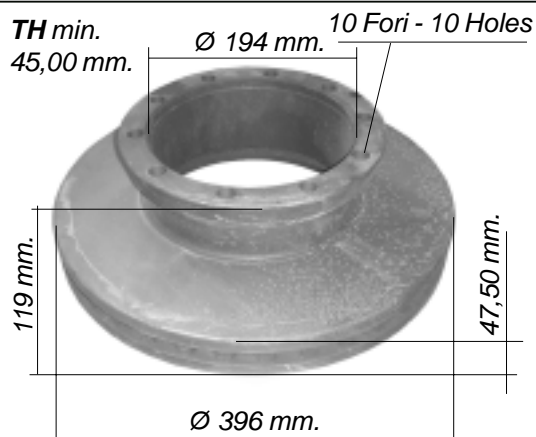
NOSTRO RIFERIMENTO
OUR REFERENCERIFERIMENTO COSTRUTTORE
O.E. REFERENCE**960313**056.101-00 - 179241111307
8284000147 - 1792411113070
8284000047

DESCRIZIONE / DESCRIPTION

Disco freno assale anteriore
Brake disc front axleFascia AUTOVENTILANTE
SELF-VENTILATED Band

ILLUSTRAZIONE / ILLUSTRATION

NOSTRO RIFERIMENTO
OUR REFERENCERIFERIMENTO COSTRUTTORE
O.E. REFERENCE**960961**8284000209
8285000235

DESCRIZIONE / DESCRIPTION

Serie pastiglie freno anteriore (8 pezzi)
Set of brake pads front (8 pcs)

WVA	Larghezza Width - mm.	Altezza Height - mm.	Spessore Thickness - mm.
29747	139.5	121	32



ILLUSTRAZIONE / ILLUSTRATION

NOSTRO RIFERIMENTO
OUR REFERENCERIFERIMENTO COSTRUTTORE
O.E. REFERENCE

Klips

(2) Lungh./Length mm 1285

(2) Lungh./Length mm 285

960975

-

DESCRIZIONE / DESCRIPTION

Kit segnalatori usura freno anteriore (4 pz.)
Set of brake wear indicators front (4 pcs)

TIPO DI VEICOLO / VEHICLE TYPE

SETRA BUS

S215HD (01/92) - S215NR (01/92) - S300NC (01/91) - S315HD (01/91)

ILLUSTRAZIONE / ILLUSTRATION	NOSTRO RIFERIMENTO OUR REFERENCE	RIFERIMENTO COSTRUTTORE O.E. REFERENCE								
	960314	8285390000								
DESCRIZIONE / DESCRIPTION										
<p>Disco freno assale anteriore Brake disc front axle</p> <p>Fascia AUTOVENTILANTE SELF-VENTILATED Band</p>										
ILLUSTRAZIONE / ILLUSTRATION	NOSTRO RIFERIMENTO OUR REFERENCE	RIFERIMENTO COSTRUTTORE O.E. REFERENCE								
	960960	8284000197 8284058204								
DESCRIZIONE / DESCRIPTION										
<p>Serie pastiglie freno anteriore (8 pezzi) Set of brake pads front (8 pcs)</p> <table border="1"> <thead> <tr> <th>WVA</th> <th>Larghezza Width - mm.</th> <th>Altezza Height - mm.</th> <th>Spessore Thickness - mm.</th> </tr> </thead> <tbody> <tr> <td>29582</td> <td>179</td> <td>112</td> <td>22</td> </tr> </tbody> </table>			WVA	Larghezza Width - mm.	Altezza Height - mm.	Spessore Thickness - mm.	29582	179	112	22
WVA	Larghezza Width - mm.	Altezza Height - mm.	Spessore Thickness - mm.							
29582	179	112	22							
ILLUSTRAZIONE / ILLUSTRATION	NOSTRO RIFERIMENTO OUR REFERENCE	RIFERIMENTO COSTRUTTORE O.E. REFERENCE								
<p>Connettore Ovale - Lungh. mm 340 Oval connector - Length mm. 340</p>	960976	81508110004 82823884510								
DESCRIZIONE / DESCRIPTION										
<p>Kit segnalatori usura freno anteriore (2 pz.) Set of brake wear indicators front (2 pcs)</p>										

TIPO DI VEICOLO / VEHICLE TYPE

TRAILER SKH - SB 3745
ECO PLUS - ECO MAXX

(con ABS - With ABS)

ILLUSTRAZIONE / ILLUSTRATION	NOSTRO RIFERIMENTO OUR REFERENCE	RIFERIMENTO COSTRUTTORE O.E. REFERENCE									
	960358	03.088.34.04.0 03.088.34.02.0 03.088.34.06.0									
DESCRIZIONE / DESCRIPTION											
<p>Disco freno assale BPW Brake disc for BPW axle</p> <p>Fascia AUTOVENTILANTE SELF-VENTILATED Band</p> 											
ILLUSTRAZIONE / ILLUSTRATION	NOSTRO RIFERIMENTO OUR REFERENCE	RIFERIMENTO COSTRUTTORE O.E. REFERENCE									
	960948	09.801.02.93.0 - 09.801.06.21.0 02.0312.15.00									
DESCRIZIONE / DESCRIPTION											
<p>Serie pastiglie freno completa di molle, kit accessori SENZA piastre Set of brake pads with springs, kit accessories WITHOUT plates</p>											
960948/C		-									
<p>Serie pastiglie freno completa di molle, kit accessori e piastre Set of brake pads with springs, kit accessories and plates</p> <p style="text-align: right;">IMPIANTO KNORR SB 6 KNORR SYSTEM SB 6</p>											
<table border="1"> <thead> <tr> <th data-bbox="655 1599 762 1641">WVA</th> <th data-bbox="770 1599 922 1641">Larghezza Width - mm.</th> <th data-bbox="930 1599 1066 1641">Altezza Height - mm.</th> <th data-bbox="1074 1599 1248 1641">Spessore Thickness - mm.</th> </tr> </thead> <tbody> <tr> <td data-bbox="655 1648 762 1704">29095</td> <td data-bbox="770 1648 922 1704">211</td> <td data-bbox="930 1648 1066 1704">92.5</td> <td data-bbox="1074 1648 1248 1704">30</td> </tr> </tbody> </table>				WVA	Larghezza Width - mm.	Altezza Height - mm.	Spessore Thickness - mm.	29095	211	92.5	30
WVA	Larghezza Width - mm.	Altezza Height - mm.	Spessore Thickness - mm.								
29095	211	92.5	30								
											
ILLUSTRAZIONE / ILLUSTRATION	NOSTRO RIFERIMENTO OUR REFERENCE	RIFERIMENTO COSTRUTTORE O.E. REFERENCE									
 <p>Connettore Tondo - Lungh. mm.365 Round connector - Length mm. 365</p>	960523	000824.1									
DESCRIZIONE / DESCRIPTION											
<p>Kit segnalatori usura freno (2 pz.) Set of brake wear indicators (2 pcs)</p>											

TIPO DI VEICOLO / VEHICLE TYPE

**TRAILER SKH - SB 3745
ECO PLUS - ECO MAXX
(9-10 TON.)
(con ABS - With ABS)**

ILLUSTRAZIONE / ILLUSTRATION



NOSTRO RIFERIMENTO OUR REFERENCE

960360

RIFERIMENTO COSTRUTTORE O.E. REFERENCE

03.088.34.03.0
03.088.34.01.0
03.088.34.01.7

DESCRIZIONE / DESCRIPTION

Disco freno assale BPW
Brake disc for BPW axle

Fascia AUTOVENTILANTE
SELF-VENTILATED Band



ILLUSTRAZIONE / ILLUSTRATION



NOSTRO RIFERIMENTO OUR REFERENCE

960948

RIFERIMENTO COSTRUTTORE O.E. REFERENCE

09.801.02.93.0 - 09.801.06.21.0
02.0312.15.00

DESCRIZIONE / DESCRIPTION

Serie pastiglie freno completa di molle,
kit accessori **SENZA** piastre
Set of brake pads with springs,
kit accessories **WITHOUT** plates

960948/C

Serie pastiglie freno **completa** di molle, kit accessori e
piastre
Set of brake pads with springs,
kit accessories and plates

**IMPIANTO KNORR SB 6
KNORR SYSTEM SB6**

WVA	Larghezza Width - mm.	Altezza Height - mm.	Spessore Thickness - mm.
29095	211	92.5	30



ILLUSTRAZIONE / ILLUSTRATION



Connettore Tondo - Lungh. mm.365
Round connector - Length mm. 365

NOSTRO RIFERIMENTO OUR REFERENCE

960523

RIFERIMENTO COSTRUTTORE O.E. REFERENCE

000824.1

DESCRIZIONE / DESCRIPTION

Kit segnalatori usura freno (2 pz.)
Set of brake wear indicators (2 pcs)

TIPO DI VEICOLO / VEHICLE TYPE

ASSALE BPW SKH
ECO PLUS - ECO MAXX
9/10 ton
CON ABS - WITH ABS

ILLUSTRAZIONE / ILLUSTRATION	NOSTRO RIFERIMENTO OUR REFERENCE	RIFERIMENTO COSTRUTTORE O.E. REFERENCE								
	960352	0308834010 0308834017								
DESCRIZIONE / DESCRIPTION										
<p>Disco freno assale BPW Brake disc for BPW axle</p> <p>Fascia AUTOVENTILANTE SELF-VENTILATED Band</p> 										
ILLUSTRAZIONE / ILLUSTRATION	NOSTRO RIFERIMENTO OUR REFERENCE	RIFERIMENTO COSTRUTTORE O.E. REFERENCE								
 <p>E3 90R</p>	960948	09.801.02.93.0 - 09.801.06.21.0 02.0312.15.00								
DESCRIZIONE / DESCRIPTION										
<p>Serie pastiglie freno completa di molle, kit accessori SENZA piastre Set of brake pads with springs, kit accessories WITHOUT plates</p>										
960948/C		-								
<p>Serie pastiglie freno completa di molle, kit accessori e piastre Set of brake pads with springs, kit accessories and plates</p> <p style="text-align: right;">IMPIANTO KNORR SB 6 KNORR SYSTEM SB 6</p> <table border="1" style="width: 100%; border-collapse: collapse;"> <thead> <tr> <th>WVA</th> <th>Larghezza Width - mm.</th> <th>Altezza Height - mm.</th> <th>Spessore Thickness - mm.</th> </tr> </thead> <tbody> <tr> <td>29095</td> <td>211</td> <td>92.5</td> <td>30</td> </tr> </tbody> </table> 			WVA	Larghezza Width - mm.	Altezza Height - mm.	Spessore Thickness - mm.	29095	211	92.5	30
WVA	Larghezza Width - mm.	Altezza Height - mm.	Spessore Thickness - mm.							
29095	211	92.5	30							
ILLUSTRAZIONE / ILLUSTRATION	NOSTRO RIFERIMENTO OUR REFERENCE	RIFERIMENTO COSTRUTTORE O.E. REFERENCE								
 <p>Connettore Tondo - Lungh. mm.365 Round connector - Length mm. 365</p>	960523	000824.1								
DESCRIZIONE / DESCRIPTION										
<p>Kit segnalatori usura freno (2 pz.) Set of brake wear indicators (2 pcs)</p>										

TIPO DI VEICOLO / VEHICLE TYPE

TRAILER SKH - U.T.
ECO PLUS - ECO MAXX

(senza ABS - Without ABS)

ILLUSTRAZIONE / ILLUSTRATION



NOSTRO RIFERIMENTO OUR REFERENCE

960361

RIFERIMENTO COSTRUTTORE O.E. REFERENCE

03.088.34.07.0

DESCRIZIONE / DESCRIPTION

Disco freno assale BPW
Brake disc for BPW axle

Fascia AUTOVENTILANTE
SELF-VENTILATED Band



ILLUSTRAZIONE / ILLUSTRATION



NOSTRO RIFERIMENTO OUR REFERENCE

960948

RIFERIMENTO COSTRUTTORE O.E. REFERENCE

09.801.02.93.0 - 09.801.06.21.0
02.0312.15.00

DESCRIZIONE / DESCRIPTION

Serie pastiglie freno completa di molle,
kit accessori **SENZA** piastre
Set of brake pads with springs,
kit accessories **WITHOUT** plates

960948/C

Serie pastiglie freno **completa** di molle, kit accessori e
piastre
Set of brake pads with springs,
kit accessories and plates

**IMPIANTO KNORR SB 6
KNORR SYSTEM SB 6**

WVA	Larghezza Width - mm.	Altezza Height - mm.	Spessore Thickness - mm.
29095	211	92.5	30



ILLUSTRAZIONE / ILLUSTRATION



Connettore Tondo - Lungh. mm.365
Round connector - Length mm. 365

NOSTRO RIFERIMENTO OUR REFERENCE

960523

RIFERIMENTO COSTRUTTORE O.E. REFERENCE

000824.1





DESCRIZIONE / DESCRIPTION

Kit segnalatori usura freno (2 pz.)
Set of brake wear indicators (2 pcs)

TIPO DI VEICOLO / VEHICLE TYPE

TRAILER SH
ECO PLUS - ECO MAXX

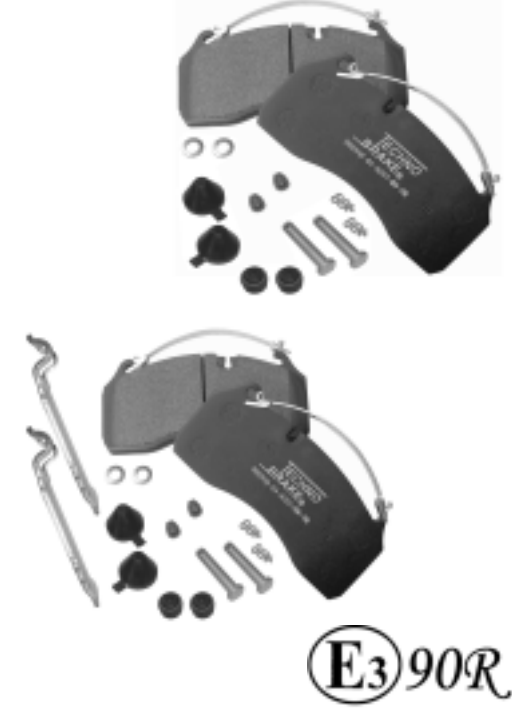
(senza ABS - Without ABS)

ILLUSTRAZIONE / ILLUSTRATION	NOSTRO RIFERIMENTO OUR REFERENCE	RIFERIMENTO COSTRUTTORE O.E. REFERENCE								
	960359	03.088.34.08.0								
DESCRIZIONE / DESCRIPTION										
<p>Disco freno assale BPW Brake disc for BPW axle</p> <p>Fascia AUTOVENTILANTE SELF-VENTILATED Band</p> 										
ILLUSTRAZIONE / ILLUSTRATION	NOSTRO RIFERIMENTO OUR REFERENCE	RIFERIMENTO COSTRUTTORE O.E. REFERENCE								
	960948	09.801.02.93.0 - 09.801.06.21.0 02.0312.15.00								
DESCRIZIONE / DESCRIPTION										
<p>Serie pastiglie freno completa di molle, kit accessori SENZA piastre Set of brake pads with springs, kit accessories WITHOUT plates</p>										
960948/C										
<p>Serie pastiglie freno completa di molle, kit accessori e piastre Set of brake pads with springs, kit accessories and plates</p> <p style="text-align: right;">IMPIANTO KNORR SB 6 KNORR SYSTEM SB 6</p>										
<table border="1" style="width: 100%; border-collapse: collapse;"> <thead> <tr> <th style="text-align: left;">WVA</th> <th style="text-align: center;">Larghezza Width - mm.</th> <th style="text-align: center;">Altezza Height - mm.</th> <th style="text-align: center;">Spessore Thickness - mm.</th> </tr> </thead> <tbody> <tr> <td style="text-align: center;">29095</td> <td style="text-align: center;">211</td> <td style="text-align: center;">92.5</td> <td style="text-align: center;">30</td> </tr> </tbody> </table> 			WVA	Larghezza Width - mm.	Altezza Height - mm.	Spessore Thickness - mm.	29095	211	92.5	30
WVA	Larghezza Width - mm.	Altezza Height - mm.	Spessore Thickness - mm.							
29095	211	92.5	30							
ILLUSTRAZIONE / ILLUSTRATION	NOSTRO RIFERIMENTO OUR REFERENCE	RIFERIMENTO COSTRUTTORE O.E. REFERENCE								
 <p>Connettore Tondo - Lungh. mm.365 Round connector - Length mm. 365</p>	960523	000824.1								
DESCRIZIONE / DESCRIPTION										
<p>Kit segnalatori usura freno (2 pz.) Set of brake wear indicators (2 pcs)</p>										

TIPO DI VEICOLO / VEHICLE TYPE

**TRAILER SB 3745 T (senza ABS - Without ABS)
(freno a disco con imbullonatura tangenziale)
(Brake disc with tangential riveting)**

9/10 ton. (ruote da 19,5" - wheels 19,5")

IMPIANTO KNORR - KNORR SYSTEM

ILLUSTRAZIONE / ILLUSTRATION	NOSTRO RIFERIMENTO OUR REFERENCE	RIFERIMENTO COSTRUTTORE O.E. REFERENCE							
	<p align="center">960366</p>	<p align="center">03.088.34.107 03.088.34.10.0</p>							
			<p align="center">DESCRIZIONE / DESCRIPTION</p> <p><i>Disco freno assale BPW Brake disc for BPW axle</i></p> <p><i>Fascia AUTOVENTILANTE SELF-VENTILATED Band</i></p>						
	<p align="center">960994</p>	<p align="center">09.801.06.43.0</p>							
			<p align="center">DESCRIZIONE / DESCRIPTION</p> <p><i>Serie pastiglie freno completa di molle e kit accessori Set of brake pads with springs and kit accessories</i></p> <table border="1"> <thead> <tr> <th>WVA</th> <th>Larghezza Width - mm.</th> <th>Altezza Height - mm.</th> <th>Spessore Thickness - mm.</th> </tr> </thead> <tbody> <tr> <td>29165</td> <td>210,9</td> <td>92.50</td> <td>30</td> </tr> </tbody> </table>		WVA	Larghezza Width - mm.	Altezza Height - mm.	Spessore Thickness - mm.	29165
WVA	Larghezza Width - mm.	Altezza Height - mm.	Spessore Thickness - mm.						
29165	210,9	92.50	30						
	<p align="center">960994/C</p>	<p align="center">-</p>							
			<p align="center">DESCRIZIONE / DESCRIPTION</p> <p><i>Serie pastiglie freno completa di molle, kit accessori e piastre Set of brake pads with springs, kit accessories and plates</i></p>						

TIPO DI VEICOLO / VEHICLE TYPE

TRAILER SB 3745 T (senza ABS - Without ABS)
(freno a disco con imbullonatura tangenziale)
(Brake disc with tangential riveting)

9/10 ton. (ruote da 19,5" - wheels 19,5")

IMPIANTO KNORR - KNORR SYSTEM

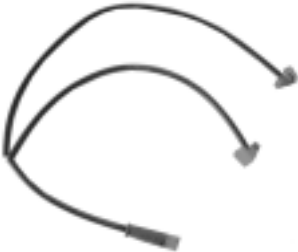
ILLUSTRAZIONE / ILLUSTRATION	NOSTRO RIFERIMENTO OUR REFERENCE	RIFERIMENTO COSTRUTTORE O.E. REFERENCE
 <p data-bbox="140 981 560 1039">Connettore Tondo - Lungh. 365 mm Round connector - Length 365 mm</p>	960523	000824.1
DESCRIZIONE / DESCRIPTION		
<p data-bbox="646 860 1145 934">Kit segnalatori usura freno (2 pz.) Set of brake wear indicators (2 pcs)</p>		
ILLUSTRAZIONE / ILLUSTRATION	NOSTRO RIFERIMENTO OUR REFERENCE	RIFERIMENTO COSTRUTTORE O.E. REFERENCE
 <p data-bbox="140 1556 560 1615">Connettore Tondo - Lungh. 380 mm Round connector - Length 380 mm</p>	960529	-
DESCRIZIONE / DESCRIPTION		
<p data-bbox="646 1370 1461 1444">Kit segnalatori usura freno per pinza freno SB6 (2 pz.) Set of brake wear indicators for SB6 brake caliper (2 pcs)</p>		
ILLUSTRAZIONE / ILLUSTRATION	NOSTRO RIFERIMENTO OUR REFERENCE	RIFERIMENTO COSTRUTTORE O.E. REFERENCE
DESCRIZIONE / DESCRIPTION		

TIPO DI VEICOLO / VEHICLE TYPE

TRAILER SH - SB 4345

IMPIANTO KNORR - KNORR SYSTEM





(con ABS - With ABS)

ILLUSTRAZIONE / ILLUSTRATION	NOSTRO RIFERIMENTO OUR REFERENCE	RIFERIMENTO COSTRUTTORE O.E. REFERENCE																								
	960355	03.088.35.01.0																								
DESCRIZIONE / DESCRIPTION																										
<p>Disco freno assale BPW Brake disc for axle BPW</p> <p>Fascia AUTOVENTILANTE SELF-VENTILATED Band</p>																										
ILLUSTRAZIONE / ILLUSTRATION	NOSTRO RIFERIMENTO OUR REFERENCE	RIFERIMENTO COSTRUTTORE O.E. REFERENCE																								
	960944	09.801.06.96.0																								
DESCRIZIONE / DESCRIPTION																										
<p>Serie pastiglie freno anteriore e posteriore completa di molle kit accessori SENZA piastre (1) Set of brake pads front and rear with springs, kit accessories WITHOUT plates (1)</p>																										
960944/C		-																								
<p>Serie pastiglie freno anteriore e posteriore completa di molle, kit accessori e piastre (2) Set of brake pads front and rear with springs, kit accessories and plates (2)</p> <p style="text-align: right;">BREVETTO PENDENTE PENDING PATENT</p> <table border="1" style="width: 100%;"> <thead> <tr> <th>WVA</th> <th>Larghezza Width - mm.</th> <th>Altezza Height - mm.</th> <th>Spessore Thickness - mm.</th> </tr> </thead> <tbody> <tr> <td>29087</td> <td>247,2</td> <td>109,7</td> <td>30</td> </tr> <tr> <td>29105</td> <td></td> <td></td> <td></td> </tr> <tr> <td>29108</td> <td></td> <td></td> <td></td> </tr> <tr> <td>29059</td> <td></td> <td></td> <td></td> </tr> <tr> <td>29061</td> <td></td> <td></td> <td></td> </tr> </tbody> </table>			WVA	Larghezza Width - mm.	Altezza Height - mm.	Spessore Thickness - mm.	29087	247,2	109,7	30	29105				29108				29059				29061			
WVA	Larghezza Width - mm.	Altezza Height - mm.	Spessore Thickness - mm.																							
29087	247,2	109,7	30																							
29105																										
29108																										
29059																										
29061																										
ILLUSTRAZIONE / ILLUSTRATION	NOSTRO RIFERIMENTO OUR REFERENCE	RIFERIMENTO COSTRUTTORE O.E. REFERENCE																								
<p>Connettore Tondo - Lungh. 365 mm Round connector - Length 365 mm</p>	960523	000824.1																								
<p>Kit segnalatori usura freno (2 pz.) Set of brake wear indicators (2 pcs)</p>																										

TIPO DI VEICOLO / VEHICLE TYPE

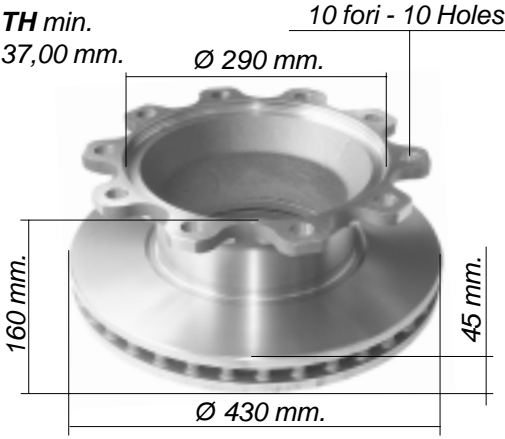
TRAILER SH - SB 4345
(senza ABS - Without ABS)

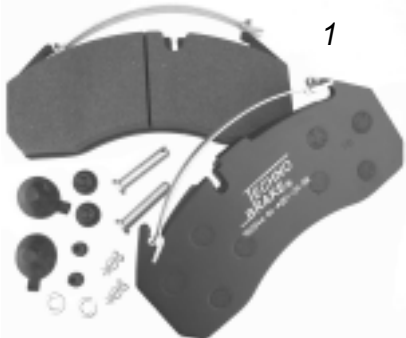
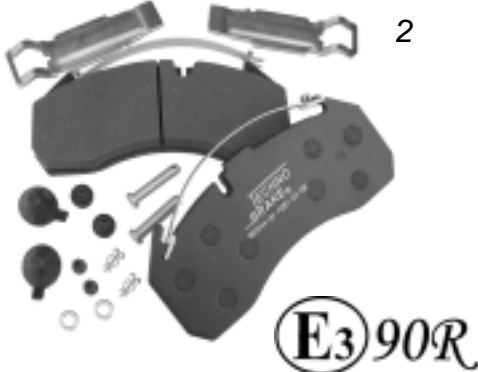
IMPIANTO KNORR - KNORR SYSTEM

ILLUSTRAZIONE / ILLUSTRATION	NOSTRO RIFERIMENTO OUR REFERENCE	RIFERIMENTO COSTRUTTORE O.E. REFERENCE																								
	960356	03.088.35.03.0																								
DESCRIZIONE / DESCRIPTION																										
Disco freno assale BPW Brake disc for BPW axle																										
Fascia AUTOVENTILANTE SELF-VENTILATED Band 																										
ILLUSTRAZIONE / ILLUSTRATION	NOSTRO RIFERIMENTO OUR REFERENCE	RIFERIMENTO COSTRUTTORE O.E. REFERENCE																								
	960944	09.801.06.96.0																								
DESCRIZIONE / DESCRIPTION																										
Serie pastiglie freno anteriore e posteriore completa di molle kit accessori SENZA piastre (1) Set of brake pads front and rear with springs, kit accessories WITHOUT plates (1)																										
960944/C		-																								
	Serie pastiglie freno anteriore e posteriore completa di molle, kit accessori e piastre (2) Set of brake pads front and rear with springs, kit accessories and plates (2)																									
BREVETTO PENDENTE PENDING PATENT																										
<table border="1"> <thead> <tr> <th>WVA</th> <th>Larghezza Width - mm.</th> <th>Altezza Height - mm.</th> <th>Spessore Thickness - mm.</th> </tr> </thead> <tbody> <tr> <td>29087</td> <td>247,2</td> <td>109,7</td> <td>30</td> </tr> <tr> <td>29105</td> <td></td> <td></td> <td></td> </tr> <tr> <td>29108</td> <td></td> <td></td> <td></td> </tr> <tr> <td>29059</td> <td></td> <td></td> <td></td> </tr> <tr> <td>29061</td> <td></td> <td></td> <td></td> </tr> </tbody> </table>			WVA	Larghezza Width - mm.	Altezza Height - mm.	Spessore Thickness - mm.	29087	247,2	109,7	30	29105				29108				29059				29061			
WVA	Larghezza Width - mm.	Altezza Height - mm.	Spessore Thickness - mm.																							
29087	247,2	109,7	30																							
29105																										
29108																										
29059																										
29061																										
																										
ILLUSTRAZIONE / ILLUSTRATION	NOSTRO RIFERIMENTO OUR REFERENCE	RIFERIMENTO COSTRUTTORE O.E. REFERENCE																								
	960523	000824.1																								
Kit segnalatori usura freno (2 pz.) Set of brake wear indicators (2 pcs)																										
Connettore Tondo - Lungh. 365 mm Round connector - Length 365 mm																										

TIPO DI VEICOLO / VEHICLE TYPE

TRAILER SB 4345 T (SENZA ABS - WITHOUT ABS)
TRAILER SB 4309 T
(freno a disco con imbullonatura tangenziale)
(Brake disc with tangential riveting)

(ruote da 22,5" - wheels 22,5")

ILLUSTRAZIONE / ILLUSTRATION	NOSTRO RIFERIMENTO OUR REFERENCE	RIFERIMENTO COSTRUTTORE O.E. REFERENCE								
	<h2>960367</h2>	03.088.35.05.0								
			DESCRIZIONE / DESCRIPTION							
<p>Disco freno assale BPW Brake disc for BPW axle</p> <p>Fascia AUTOVENTILANTE SELF-VENTILATED Band</p>										
ILLUSTRAZIONE / ILLUSTRATION	NOSTRO RIFERIMENTO OUR REFERENCE	RIFERIMENTO COSTRUTTORE O.E. REFERENCE								
	<h2>960996</h2>	09.801.06.44.0 09.801.06.95.0								
			DESCRIZIONE / DESCRIPTION							
<p>Serie pastiglie freno completa di molle e kit accessori Set of brake pads with springs and kit accessories</p> <table border="1"> <thead> <tr> <th>WVA</th> <th>Larghezza Width - mm.</th> <th>Altezza Height - mm.</th> <th>Spessore Thickness - mm.</th> </tr> </thead> <tbody> <tr> <td>29171</td> <td>210,9</td> <td>108</td> <td>30</td> </tr> </tbody> </table>			WVA	Larghezza Width - mm.	Altezza Height - mm.	Spessore Thickness - mm.	29171	210,9	108	30
WVA	Larghezza Width - mm.	Altezza Height - mm.	Spessore Thickness - mm.							
29171	210,9	108	30							
ILLUSTRAZIONE / ILLUSTRATION	NOSTRO RIFERIMENTO OUR REFERENCE	RIFERIMENTO COSTRUTTORE O.E. REFERENCE								
	<h2>960996/C</h2>	-								
			DESCRIZIONE / DESCRIPTION							
<p>Serie pastiglie freno completa di molle, kit accessori e piastre Set of brake pads with springs, kit accessories and plates</p> <table border="1"> <thead> <tr> <th>WVA</th> <th>Larghezza Width - mm.</th> <th>Altezza Height - mm.</th> <th>Spessore Thickness - mm.</th> </tr> </thead> <tbody> <tr> <td>29171</td> <td>210,9</td> <td>108</td> <td>30</td> </tr> </tbody> </table>			WVA	Larghezza Width - mm.	Altezza Height - mm.	Spessore Thickness - mm.	29171	210,9	108	30
WVA	Larghezza Width - mm.	Altezza Height - mm.	Spessore Thickness - mm.							
29171	210,9	108	30							

TIPO DI VEICOLO / VEHICLE TYPE

TRAILER SB 4345 T (SENZA ABS - WITHOUT ABS)

TRAILER SB 4309 T

(freno a disco con imbullonatura tangenziale)

(Brake disc with tangential riveting)

(ruote da 22,5" - wheels 22,5")

ILLUSTRAZIONE / ILLUSTRATION

NOSTRO RIFERIMENTO
OUR REFERENCERIFERIMENTO COSTRUTTORE
O.E. REFERENCE

PER PINZA -FOR CALIPER SB 4345 T

960997

09.801.06.45.0



DESCRIZIONE / DESCRIPTION

Serie pastiglie freno completa di molle e kit accessori
Set of brake pads with springs and kit accessories

WVA	Larghezza Width - mm.	Altezza Height - mm.	Spessore Thickness - mm.
29167	247,20	109,70	30



ILLUSTRAZIONE / ILLUSTRATION

NOSTRO RIFERIMENTO
OUR REFERENCERIFERIMENTO COSTRUTTORE
O.E. REFERENCE

960997/C

-



DESCRIZIONE / DESCRIPTION

Serie pastiglie freno completa di molle, kit accessori e piastre
Set of brake pads with springs, kit accessories and plates

WVA	Larghezza Width - mm.	Altezza Height - mm.	Spessore Thickness - mm.
29167	247,20	109,70	30



ILLUSTRAZIONE / ILLUSTRATION

NOSTRO RIFERIMENTO
OUR REFERENCERIFERIMENTO COSTRUTTORE
O.E. REFERENCE

960523

000824.1

Connettore Tondo - Lungh. 365 mm
Round connector - Length 365 mm

DESCRIZIONE / DESCRIPTION

Kit segnalatori usura freno (2 pz.)
Set of brake wear indicators (2 pcs)

TIPO DI VEICOLO / VEHICLE TYPE

RIMORCHIO CARDI

(con assale MERCEDES - With MERCEDES axle)

ILLUSTRAZIONE / ILLUSTRATION	NOSTRO RIFERIMENTO OUR REFERENCE	RIFERIMENTO COSTRUTTORE O.E. REFERENCE
	960354	-
DESCRIZIONE / DESCRIPTION		
<p>Disco freno Brake disc</p> <p>Fascia AUTOVENTILANTE SELF VENTILATED Band</p>		

ILLUSTRAZIONE / ILLUSTRATION	NOSTRO RIFERIMENTO OUR REFERENCE	RIFERIMENTO COSTRUTTORE O.E. REFERENCE																								
	960944	-																								
DESCRIZIONE / DESCRIPTION																										
<p>Serie pastiglie freno anteriore e posteriore completa di molle kit accessori SENZA piastre (1) Set of brake pads front and rear with springs, kit accessories WITHOUT plates (1)</p>																										
960944/C		-																								
<p>Serie pastiglie freno anteriore e posteriore completa di molle, kit accessori e piastre (2) Set of brake pads front and rear with springs, kit accessories and plates (2)</p> <p style="text-align: right;">BREVETTO PENDENTE PENDING PATENT</p> <table border="1"> <thead> <tr> <th>WVA</th> <th>Larghezza Width - mm.</th> <th>Altezza Height - mm.</th> <th>Spessore Thickness - mm.</th> </tr> </thead> <tbody> <tr> <td>29087</td> <td>247,2</td> <td>109,7</td> <td>30</td> </tr> <tr> <td>29105</td> <td></td> <td></td> <td></td> </tr> <tr> <td>29108</td> <td></td> <td></td> <td></td> </tr> <tr> <td>29059</td> <td></td> <td></td> <td></td> </tr> <tr> <td>29061</td> <td></td> <td></td> <td></td> </tr> </tbody> </table>			WVA	Larghezza Width - mm.	Altezza Height - mm.	Spessore Thickness - mm.	29087	247,2	109,7	30	29105				29108				29059				29061			
WVA	Larghezza Width - mm.	Altezza Height - mm.	Spessore Thickness - mm.																							
29087	247,2	109,7	30																							
29105																										
29108																										
29059																										
29061																										

ILLUSTRAZIONE / ILLUSTRATION	NOSTRO RIFERIMENTO OUR REFERENCE	RIFERIMENTO COSTRUTTORE O.E. REFERENCE
<p>Tondo - L = 365 mm</p>	960523	000824.1
<p>Kit segnalatori usura freno (2 pz.) Set brake wear indicator (2 pcs)</p>		

TIPO DI VEICOLO / VEHICLE TYPE

LECINENA
FD 22/0

ILLUSTRAZIONE / ILLUSTRATION

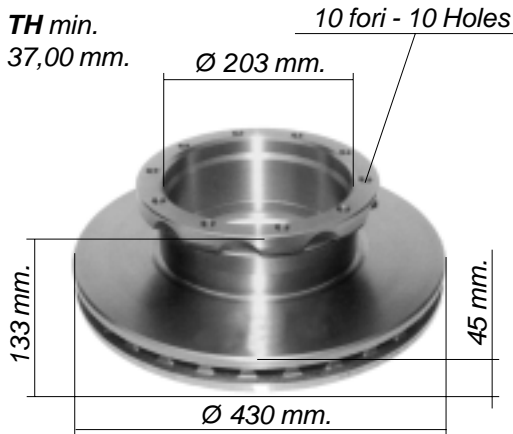
NOSTRO RIFERIMENTO
OUR REFERENCE**960397**RIFERIMENTO COSTRUTTORE
O.E. REFERENCE

120015000188

DESCRIZIONE / DESCRIPTION

Disco freno
Brake discFascia AUTOVENTILANTE
SELF VENTILATED Band

ILLUSTRAZIONE / ILLUSTRATION

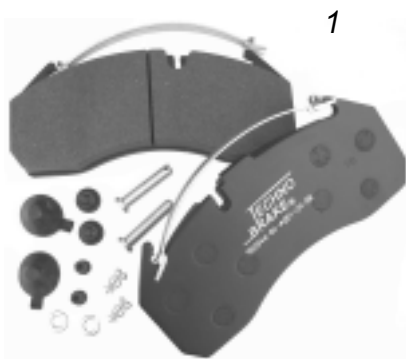

1

NOSTRO RIFERIMENTO
OUR REFERENCE**960944**RIFERIMENTO COSTRUTTORE
O.E. REFERENCE

-

DESCRIZIONE / DESCRIPTION

Serie pastiglie freno anteriore e posteriore completa di molle
kit accessori **SENZA** piastre (1)
Set of brake pads front and rear with springs,
kit accessories **WITHOUT** plates (1)**960944/C**

-

Serie pastiglie freno anteriore e posteriore completa di
molle, kit accessori e piastre (2)
Set of brake pads front and rear with springs,
kit accessories and plates (2)**BREVETTO PENDENTE
PENDING PATENT**

2

WVA	Larghezza Width - mm.	Altezza Height - mm.	Spessore Thickness - mm.
29087	247,2	109,7	30
29105			
29108			
29059			
29061			

E3 90R

TIPO DI VEICOLO / VEHICLE TYPE

LEGINENA
FD 22/120

ILLUSTRAZIONE / ILLUSTRATION

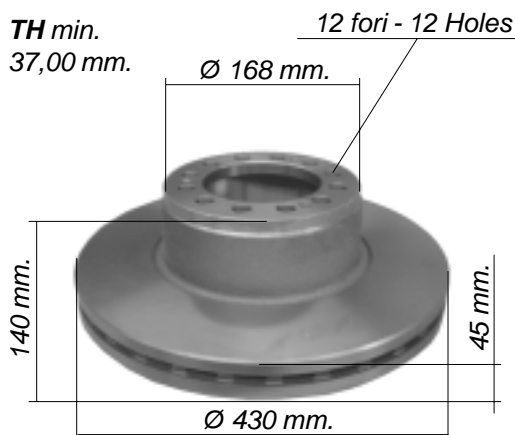

NOSTRO RIFERIMENTO
OUR REFERENCE

960399

RIFERIMENTO COSTRUTTORE
O.E. REFERENCE

120015000005.V

DESCRIZIONE / DESCRIPTION

Disco freno
Brake disc

Fascia AUTOVENTILANTE
SELF-VENTILATED Band



ILLUSTRAZIONE / ILLUSTRATION

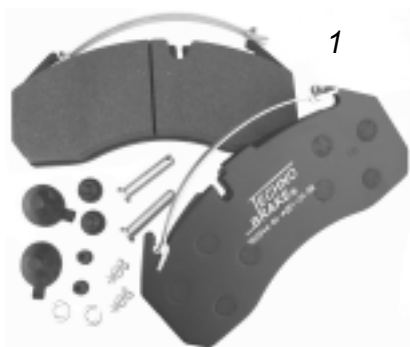

NOSTRO RIFERIMENTO
OUR REFERENCE

960944

RIFERIMENTO COSTRUTTORE
O.E. REFERENCE

-

DESCRIZIONE / DESCRIPTION

Serie pastiglie freno anteriore e posteriore completa di molle, kit accessori e senza piastre (1)
Set of brake pads front and rear without springs, kit accessories and without plates (1)



960944/C

-

Serie pastiglie freno anteriore e posteriore completa di molle, kit accessori e piastre (2)
Set of brake pads front and rear with springs, kit accessories and plates (2)

**BREVETTO PENDENTE
PENDING PATENT**



E3 90R

WVA	Larghezza Width - mm.	Altezza Height - mm.	Spessore Thickness - mm.
29087	247,2	109,7	30
29105			
29108			
29059			
29061			



TIPO DI VEICOLO / VEHICLE TYPE

ASSALE ROR LM - LMC

(con ABS - with ABS)

ILLUSTRAZIONE / ILLUSTRATION

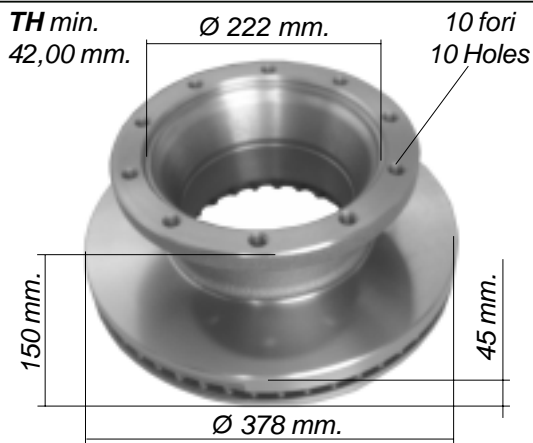
NOSTRO RIFERIMENTO
OUR REFERENCE**960110**RIFERIMENTO COSTRUTTORE
O.E. REFERENCE

21227349

DESCRIZIONE / DESCRIPTION

Disco freno
Brake discFascia AUTOVENTILANTE
SELF-VENTILATED Band

ILLUSTRAZIONE / ILLUSTRATION

NOSTRO RIFERIMENTO
OUR REFERENCE**960928**RIFERIMENTO COSTRUTTORE
O.E. REFERENCE

MDP 5076

DESCRIZIONE / DESCRIPTION

Serie pastiglie freno completa di molle e kit accessori
Set of brake pads with springs and ki accessories

WVA	Larghezza Width - mm.	Altezza Height - mm.	Spessore Thickness - mm.
29124	205,5	102	27



ILLUSTRAZIONE / ILLUSTRATION

Connettore Ovale - Lungh. 380 mm
Oval connector - LLength 380 mm.NOSTRO RIFERIMENTO
OUR REFERENCE**960525**RIFERIMENTO COSTRUTTORE
O.E. REFERENCE

-

DESCRIZIONE / DESCRIPTION

Kit segnalatori usura freno (2 pz.)
Set of brake wear indicators (2 pcs)

TIPO DI VEICOLO / VEHICLE TYPE

ASSALE ROR SERIE TM

senza ABS - without ABS

ILLUSTRAZIONE / ILLUSTRATION

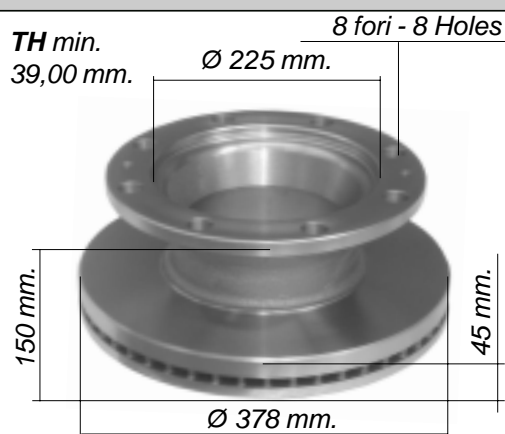

NOSTRO RIFERIMENTO OUR REFERENCE

960301

RIFERIMENTO COSTRUTTORE O.E. REFERENCE

21224263

DESCRIZIONE / DESCRIPTION

Disco freno assale
Brake disc axle

Fascia AUTOVENTILANTE
SELF-VENTILATED Band



ILLUSTRAZIONE / ILLUSTRATION



NOSTRO RIFERIMENTO OUR REFERENCE

960928

RIFERIMENTO COSTRUTTORE O.E. REFERENCE

MDP 5076

DESCRIZIONE / DESCRIPTION

Serie pastiglie freno completa di molle e kit accessori
Set of brake pads with springs and ki accessories

WVA	Larghezza Width - mm.	Altezza Height - mm.	Spessore Thickness - mm.
29124	205,5	102	27



ILLUSTRAZIONE / ILLUSTRATION



Connettore Ovale - Lungh. 380 mm
Oval connector - LEngth 380 mm.

NOSTRO RIFERIMENTO OUR REFERENCE

960525

RIFERIMENTO COSTRUTTORE O.E. REFERENCE

-

DESCRIZIONE / DESCRIPTION

Kit segnalatori usura freno (2 pz.)
Set of brake wear indicators (2 pcs)

TIPO DI VEICOLO / VEHICLE TYPE

ASSALE ROR
Impianto / System MERITOR - ELSA 195
CON ABS - WIT ABS

ILLUSTRAZIONE / ILLUSTRATION	NOSTRO RIFERIMENTO OUR REFERENCE	RIFERIMENTO COSTRUTTORE O.E. REFERENCE								
	960351	MBR 9014 - 68325372								
DESCRIZIONE / DESCRIPTION										
<p>Disco freno Brake disc</p> <p>Fascia AUTOVENTILANTE SELF-VENTILATED Band</p> 										
ILLUSTRAZIONE / ILLUSTRATION	NOSTRO RIFERIMENTO OUR REFERENCE	RIFERIMENTO COSTRUTTORE O.E. REFERENCE								
	960394	68324665 - MPD5093								
DESCRIZIONE / DESCRIPTION										
<p>Serie pastiglie freno completa di molle e kit accessori Set of brake pads with springs and ki accessories</p> <table border="1"> <thead> <tr> <th>WVA</th> <th>Larghezza Width - mm.</th> <th>Altezza Height - mm.</th> <th>Spessore Thickness - mm.</th> </tr> </thead> <tbody> <tr> <td>29169 29177</td> <td>210.70</td> <td>100</td> <td>30</td> </tr> </tbody> </table> 			WVA	Larghezza Width - mm.	Altezza Height - mm.	Spessore Thickness - mm.	29169 29177	210.70	100	30
WVA	Larghezza Width - mm.	Altezza Height - mm.	Spessore Thickness - mm.							
29169 29177	210.70	100	30							
ILLUSTRAZIONE / ILLUSTRATION	NOSTRO RIFERIMENTO OUR REFERENCE	RIFERIMENTO COSTRUTTORE O.E. REFERENCE								
 <p>Connettore Ovale - Lungh. 380 mm Oval connector - LLength 380 mm.</p>	960525	-								
DESCRIZIONE / DESCRIPTION										
<p>Kit segnalatori usura freno (2 pz.) Set of brake wear indicators (2 pcs)</p>										

TIPO DI VEICOLO / VEHICLE TYPE

ASSALE ROR

Impianto / System B-DUCO - ELSA 195

NUOVO MODELLO - NEW MODEL

ILLUSTRAZIONE / ILLUSTRATION



NOSTRO RIFERIMENTO OUR REFERENCE

960350

RIFERIMENTO COSTRUTTORE O.E. REFERENCE

MBR 9001 - 68323233

DESCRIZIONE / DESCRIPTION

Disco freno
Brake disc

Fascia AUTOVENTILANTE
SELF-VENTILATED Band



ILLUSTRAZIONE / ILLUSTRATION



NOSTRO RIFERIMENTO OUR REFERENCE

960394

RIFERIMENTO COSTRUTTORE O.E. REFERENCE

68324665 - MPD5093

DESCRIZIONE / DESCRIPTION

Serie pastiglie freno completa di molle e kit accessori
Set of brake pads with springs and ki accessories

WVA	Larghezza Width - mm.	Altezza Height - mm.	Spessore Thickness - mm.
29169 29177	210.70	100	30



ILLUSTRAZIONE / ILLUSTRATION



Connettore Ovale - Lungh. 380 mm
Oval connector - LEngth 380 mm.

NOSTRO RIFERIMENTO OUR REFERENCE

960525

RIFERIMENTO COSTRUTTORE O.E. REFERENCE

-

DESCRIZIONE / DESCRIPTION

Kit segnalatori usura freno (2 pz.)
Set of brake wear indicators (2 pcs)

TIPO DI VEICOLO / VEHICLE TYPE

ASSALE ROR**Impianto / System MERITOR - ELSA 195****CON ABS - WIT ABS****ILLUSTRAZIONE / ILLUSTRATION**Connettore Quadro - Lungh. 445 mm
Round connector - Length 445 mm**NOSTRO RIFERIMENTO
OUR REFERENCE****960530****RIFERIMENTO COSTRUTTORE
O.E. REFERENCE**

-

DESCRIZIONE / DESCRIPTIONKit segnalatori usura freno Imp. Meritor Assali ROR (2 pz.)
Set of brake wear indicators Meritor System ROR axle (2 pcs)**ILLUSTRAZIONE / ILLUSTRATION**Connettore Quadro - Lungh. 660 mm
Round connector - Length 660 mm**NOSTRO RIFERIMENTO
OUR REFERENCE****960531****RIFERIMENTO COSTRUTTORE
O.E. REFERENCE**

-

DESCRIZIONE / DESCRIPTIONKit segnalatori usura freno Imp. Meritor Assali ROR (2 pz.)
Set of brake wear indicators Meritor System ROR Axle**ILLUSTRAZIONE / ILLUSTRATION**Connettore Tondo - Lungh. 660 mm
Round connector - Length 660 mm**NOSTRO RIFERIMENTO
OUR REFERENCE****960532****RIFERIMENTO COSTRUTTORE
O.E. REFERENCE**

-

DESCRIZIONE / DESCRIPTIONKit segnalatori usura freno Imp. Meritor Assali ROR (2 pz.)
Set of brake wear indicators Meritor System ROR Axle
(2 pcs)

TIPO DI VEICOLO / VEHICLE TYPE

ASSALE ROR SERIE TA - ROR AXLE

con ABS - With ABS

IMPIANTO MERITOR D-ELSA 2
MERITOR SYSTEM D-ELSA 2

ILLUSTRAZIONE / ILLUSTRATION

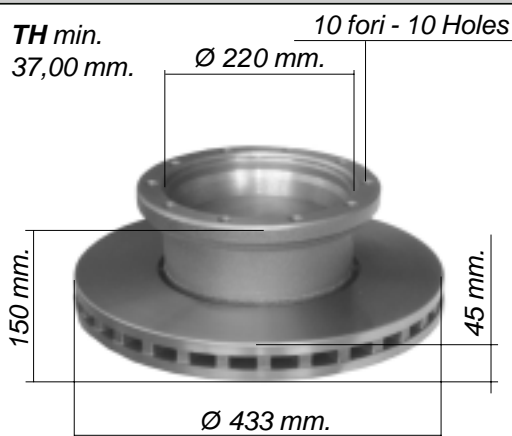

NOSTRO RIFERIMENTO
OUR REFERENCE

960300

RIFERIMENTO COSTRUTTORE
O.E. REFERENCE

MBR 9004
ex 68323825

DESCRIZIONE / DESCRIPTION

Disco freno
Brake disc

Fascia AUTOVENTILANTE
SELF-VENTILATED Band



ILLUSTRAZIONE / ILLUSTRATION

Completa di 4 molle e gommini
With 4 springs and rubber parts



NOSTRO RIFERIMENTO
OUR REFERENCE

970007

RIFERIMENTO COSTRUTTORE
O.E. REFERENCE

MDP 5073

DESCRIZIONE / DESCRIPTION

Serie pastiglie freno
Set of brake pads

WVA	Larghezza Width - mm.	Altezza Height - mm.	Spessore Thickness - mm.
29131	250	118	30



ILLUSTRAZIONE / ILLUSTRATION

NOSTRO RIFERIMENTO
OUR REFERENCE

RIFERIMENTO COSTRUTTORE
O.E. REFERENCE

DESCRIZIONE / DESCRIPTION

TIPO DI VEICOLO / VEHICLE TYPE

ASSALE SAF - SAF AXLE

TRAILER SK RS 9019 - SK RS 11019

TRAILER SK RZ 9019 - SK RZ 11019

(ruote da 19.5" - wheels from 19.5")

ILLUSTRAZIONE / ILLUSTRATION	NOSTRO RIFERIMENTO OUR REFERENCE	RIFERIMENTO COSTRUTTORE O.E. REFERENCE								
<p>TH min. 37,00 mm.</p> <p>Ø 244 mm. 8 fori - 8 Holes</p>  <p>158 mm.</p> <p>45 mm.</p> <p>Ø 377 mm.</p>	960298	4079000400								
DESCRIZIONE / DESCRIPTION										
<p>Disco freno Brake disc</p> <p>Fascia AUTOVENTILANTE SELF-VENTILATED Band</p> 										
ILLUSTRAZIONE / ILLUSTRATION	NOSTRO RIFERIMENTO OUR REFERENCE	RIFERIMENTO COSTRUTTORE O.E. REFERENCE								
<p>IMPIANTO KNORR KNORR SYSTEM</p>  <p>E3 90R</p>	960948	3057007800 5317002400								
DESCRIZIONE / DESCRIPTION										
<p>Serie pastiglie freno completa di molle e kit accessori Set of brake pads with springs and kit accessories</p> <table border="1"> <thead> <tr> <th>WVA</th> <th>Larghezza Width - mm.</th> <th>Altezza Height - mm.</th> <th>Spessore Thickness - mm.</th> </tr> </thead> <tbody> <tr> <td>29095</td> <td>211</td> <td>93</td> <td>30</td> </tr> </tbody> </table> 			WVA	Larghezza Width - mm.	Altezza Height - mm.	Spessore Thickness - mm.	29095	211	93	30
WVA	Larghezza Width - mm.	Altezza Height - mm.	Spessore Thickness - mm.							
29095	211	93	30							
ILLUSTRAZIONE / ILLUSTRATION	NOSTRO RIFERIMENTO OUR REFERENCE	RIFERIMENTO COSTRUTTORE O.E. REFERENCE								
 <p>E3 90R</p>	960948/C	-								
DESCRIZIONE / DESCRIPTION										
<p>Serie pastiglie freno completa di molle, kit accessori e piastre Set of brake pads with springs, kit accessories and plates</p> <table border="1"> <thead> <tr> <th>WVA</th> <th>Larghezza Width - mm.</th> <th>Altezza Height - mm.</th> <th>Spessore Thickness - mm.</th> </tr> </thead> <tbody> <tr> <td>29095</td> <td>211</td> <td>93</td> <td>30</td> </tr> </tbody> </table> 			WVA	Larghezza Width - mm.	Altezza Height - mm.	Spessore Thickness - mm.	29095	211	93	30
WVA	Larghezza Width - mm.	Altezza Height - mm.	Spessore Thickness - mm.							
29095	211	93	30							

TIPO DI VEICOLO / VEHICLE TYPE

ASSALE SAF - SAF AXLE

TRAILER SK RS 9019 - SK RS 11019

TRAILER SK RZ 9019 - SK RZ 11019

(ruote da 19.5" - wheel from 19.5")

ILLUSTRAZIONE / ILLUSTRATION

**IMPIANTO WABCO
WABCO SYSTEM**



NOSTRO RIFERIMENTO
OUR REFERENCE

960999

RIFERIMENTO COSTRUTTORE
O.E. REFERENCE

3057008000

DESCRIZIONE / DESCRIPTION

Serie pastiglie freno completa di molle e kit accessori
Set of brake pads with springs and ki accessories

WVA	Larghezza Width - mm.	Altezza Height - mm.	Spessore Thickness - mm.
29126 29159	210,6	92,3	29,8



ILLUSTRAZIONE / ILLUSTRATION



Connettore Ovale - Lungh. 365 mm
Oval connector - Length 365 mm

NOSTRO RIFERIMENTO
OUR REFERENCE

960523

RIFERIMENTO COSTRUTTORE
O.E. REFERENCE

000824.1

DESCRIZIONE / DESCRIPTION

Kit segnalatori usura freno (2 pz.)
Set of brake wear indicators (2 pcs)
(impianto frenante KNORR WABCO)
(KNORR WABCO Brake system)

ILLUSTRAZIONE / ILLUSTRATION

NOSTRO RIFERIMENTO
OUR REFERENCE







RIFERIMENTO COSTRUTTORE
O.E. REFERENCE

DESCRIZIONE / DESCRIPTION

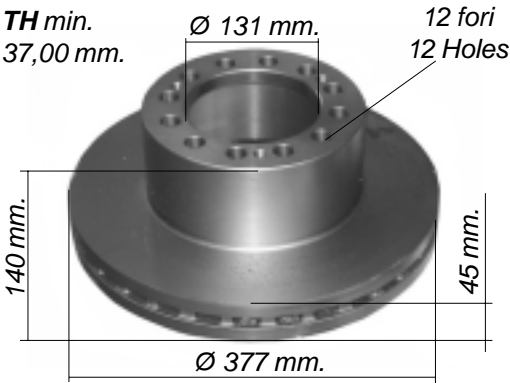
TIPO DI VEICOLO / VEHICLE TYPE

ASSALE SAF - SAF AXLE
TRAILER SK RB 9019 - 9022

(ruote da 19.5" - wheel from 19.5")

ILLUSTRAZIONE / ILLUSTRATION	NOSTRO RIFERIMENTO OUR REFERENCE	RIFERIMENTO COSTRUTTORE O.E. REFERENCE								
	960371	4079000701 4079000700								
DESCRIZIONE / DESCRIPTION										
Disco freno Brake disc										
Fascia AUTOVENTILANTE										
ILLUSTRAZIONE / ILLUSTRATION	NOSTRO RIFERIMENTO OUR REFERENCE	RIFERIMENTO COSTRUTTORE O.E. REFERENCE								
	960948	3057007800 5317002400								
DESCRIZIONE / DESCRIPTION										
Serie pastiglie freno completa di molle e kit accessori Set of brake pads with springs and kit accessories										
960948/C		-								
Serie pastiglie freno completa di molle, kit accessori e piastre Set of brake pads with springs, kit accessories and plates		IMPIANTO/SYSTEM KNORR SB 6								
<table border="1" data-bbox="638 1568 1181 1724"> <thead> <tr> <th>WVA</th> <th>Larghezza mm.</th> <th>Altezza mm.</th> <th>Spessore mm.</th> </tr> </thead> <tbody> <tr> <td>29095</td> <td>211</td> <td>92.5</td> <td>30</td> </tr> </tbody> </table>		WVA	Larghezza mm.	Altezza mm.	Spessore mm.	29095	211	92.5	30	
WVA	Larghezza mm.	Altezza mm.	Spessore mm.							
29095	211	92.5	30							
ILLUSTRAZIONE / ILLUSTRATION	NOSTRO RIFERIMENTO OUR REFERENCE	RIFERIMENTO COSTRUTTORE O.E. REFERENCE								
IMPIANTO WABCO -WABCO SYSTEM 	960999	3057008000								
DESCRIZIONE / DESCRIPTION										
Serie pastiglie freno - Set of brake pads										
<table border="1" data-bbox="638 2016 1181 2150"> <thead> <tr> <th>WVA</th> <th>Larghezza mm.</th> <th>Altezza mm.</th> <th>Spessore mm.</th> </tr> </thead> <tbody> <tr> <td>29126 29159</td> <td>210,6</td> <td>92,3</td> <td>29,8</td> </tr> </tbody> </table>		WVA	Larghezza mm.	Altezza mm.	Spessore mm.	29126 29159	210,6	92,3	29,8	
WVA	Larghezza mm.	Altezza mm.	Spessore mm.							
29126 29159	210,6	92,3	29,8							

TIPO DI VEICOLO / VEHICLE TYPE

ASSALE SAF - SAF AXLE
TRAILER SK RS 9022 - SK RS 11222
TRAILER SK RZ 9022 - SK RZ 11222

(ruote da 22.5" - wheels from 22.5")

ILLUSTRAZIONE / ILLUSTRATION

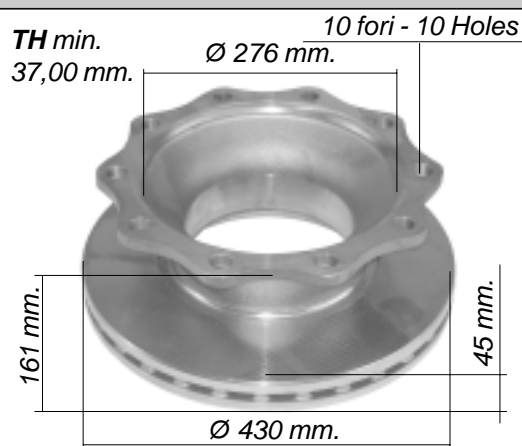

NOSTRO RIFERIMENTO
OUR REFERENCE

960353

RIFERIMENTO COSTRUTTORE
O.E. REFERENCE

4079000300

DESCRIZIONE / DESCRIPTION

Disco freno assale
Brake disc axle

Fascia AUTOVENTILANTE
SELF-VENTILATED Band



ILLUSTRAZIONE / ILLUSTRATION

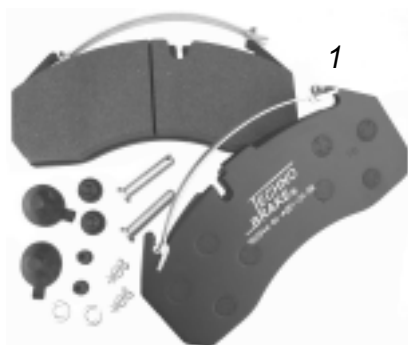

NOSTRO RIFERIMENTO
OUR REFERENCE

960944

RIFERIMENTO COSTRUTTORE
O.E. REFERENCE

3057007700
3057007900

DESCRIZIONE / DESCRIPTION

Serie pastiglie freno anteriore e posteriore completa di molle
kit accessori **SENZA** piastre (1)
Set of brake pads front and rear with springs,
kit accessories **WITHOUT** plates (1)



960944/C

Serie pastiglie freno anteriore e posteriore completa di
molle, kit accessori e piastre (2)
Set of brake pads front and rear with springs,
kit accessories and plates (2)

**BREVETTO PENDENTE
PENDING PATENT**

WVA	Larghezza Width - mm.	Altezza Height - mm.	Spessore Thickness - mm.
29087	247,2	109,7	30
29105			
29108			
29059			
29061			







E3 90R

TIPO DI VEICOLO / VEHICLE TYPE

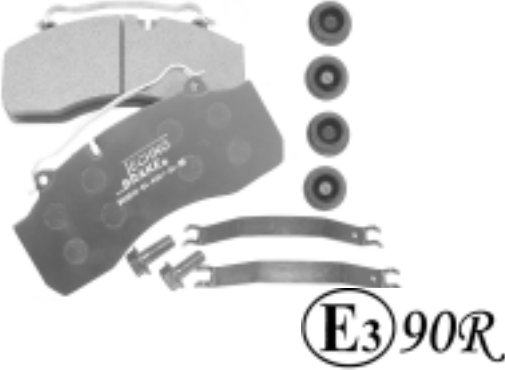
ASSALE SAF - SAF AXLE
TRAILER SK RS 9022 - SK RS 11222
TRAILER SK RZ 9022 - SK RZ 11222

(ruote da 22.5" - wheels from 22.5")

ILLUSTRAZIONE / ILLUSTRATION	NOSTRO RIFERIMENTO OUR REFERENCE	RIFERIMENTO COSTRUTTORE O.E. REFERENCE							
	<p align="center">960949</p>	<p align="center">3057317900</p>							
			<p align="center">DESCRIZIONE / DESCRIPTION</p> <p align="center">Serie pastiglie freno completa di molle e kit accessori Set of brake pads with springs and kit accessories</p> <table border="1"> <thead> <tr> <th>WVA</th> <th>Larghezza Width - mm.</th> <th>Altezza Height - mm.</th> <th>Spessore Thickness - mm.</th> </tr> </thead> <tbody> <tr> <td align="center">29143</td> <td align="center">247,6</td> <td align="center">105</td> <td align="center">30</td> </tr> </tbody> </table> 		WVA	Larghezza Width - mm.	Altezza Height - mm.	Spessore Thickness - mm.	29143
WVA	Larghezza Width - mm.	Altezza Height - mm.	Spessore Thickness - mm.						
29143	247,6	105	30						
 <p>Connettore Ovale - Lungh. 365 mm Connettore Ovale - Lungh. 365 mm</p>	<p align="center">960523</p>	<p align="center">-</p>							
			<p align="center">DESCRIZIONE / DESCRIPTION</p> <p align="center">Kit segnalatori usura freno (2 pz.) Set of brake wear indicators (2 pcs)</p>						
 <p>Connettore Ovale - Lungh. 800 mm Connettore Ovale - Lungh. 800 mm</p>	<p align="center">960524</p>	<p align="center">3424200600</p>							
			<p align="center">DESCRIZIONE / DESCRIPTION</p> <p align="center">Kit segnalatori usura freno (2 pz.) Set of brake wear indicators (2 pcs) (impianto frenante HALDEX) (HALDEX Brake system)</p>						

TIPO DI VEICOLO / VEHICLE TYPE

**ASSALE SAF - SAF AXLE
TRAILER SK RB 9022**

SAF U.T.

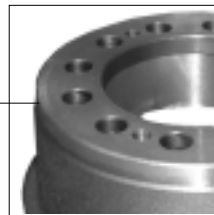

(ruote da 22.5" - wheels from 22.5")

con sede lavorata
with worked seat

ILLUSTRAZIONE / ILLUSTRATION

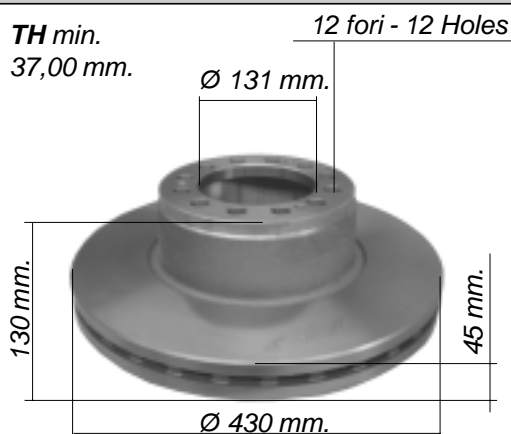

NOSTRO RIFERIMENTO
OUR REFERENCE

960362

RIFERIMENTO COSTRUTTORE
O.E. REFERENCE

4079000502
4079000501 - 4079000500

DESCRIZIONE / DESCRIPTION

Disco freno
Brake disc

Fascia AUTOVENTILANTE
SELF-VENTILATED Band



ILLUSTRAZIONE / ILLUSTRATION

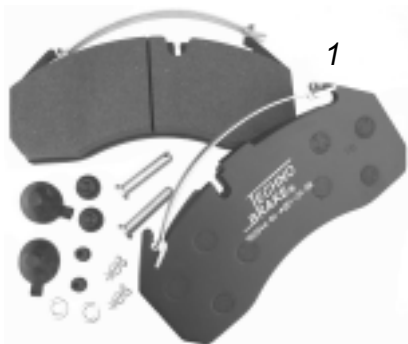

NOSTRO RIFERIMENTO
OUR REFERENCE

960944

RIFERIMENTO COSTRUTTORE
O.E. REFERENCE

3057007700
3057007900

DESCRIZIONE / DESCRIPTION

Serie pastiglie freno anteriore e posteriore completa di molle
kit accessori **SENZA** piastre (1)
Set of brake pads front and rear with springs,
kit accessories **WITHOUT** plates (1)



960944/C

Serie pastiglie freno anteriore e posteriore completa di
molle, kit accessori e piastre (2)
Set of brake pads front and rear with springs,
kit accessories and plates (2)

**BREVETTO PENDENTE
PENDING PATENT**

WVA	Larghezza Width - mm.	Altezza Height - mm.	Spessore Thickness - mm.
29087	247,2	109,7	30
29105			
29108			
29059			
29061			





E3 90R

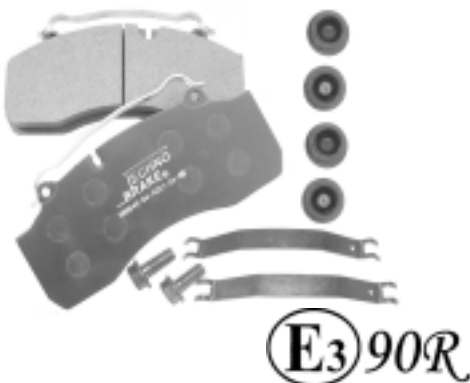

TIPO DI VEICOLO / VEHICLE TYPE

ASSALE SAF - SAF AXLE
TRAILER SK RS 9022 - SK RS 11222
TRAILER SK RZ 9022 - SK RZ 11222

(ruote da 22.5" - wheels from 22.5")

ILLUSTRAZIONE / ILLUSTRATION	NOSTRO RIFERIMENTO OUR REFERENCE	RIFERIMENTO COSTRUTTORE O.E. REFERENCE							
	<p align="center">960949</p>	<p align="center">3057317900</p>							
			<p align="center">DESCRIZIONE / DESCRIPTION</p> <p>Serie pastiglie freno completa di molle e kit accessori Set of brake pads with springs and kit accessories</p> <table border="1"> <thead> <tr> <th>WVA</th> <th>Larghezza Width - mm.</th> <th>Altezza Height - mm.</th> <th>Spessore Thickness - mm.</th> </tr> </thead> <tbody> <tr> <td>29143</td> <td>247,6</td> <td>105</td> <td>30</td> </tr> </tbody> </table> 		WVA	Larghezza Width - mm.	Altezza Height - mm.	Spessore Thickness - mm.	29143
WVA	Larghezza Width - mm.	Altezza Height - mm.	Spessore Thickness - mm.						
29143	247,6	105	30						
 <p>Connettore Ovale - Lungh. 365 mm Oval connector - Length 365 mm</p>	<p align="center">960523</p>	<p align="center">-</p>							
			<p align="center">DESCRIZIONE / DESCRIPTION</p> <p>Kit segnalatori usura freno (2 pz.) Set of brake wear indicators (2 pcs) (impianto frenante KNORR WABCO) (KNORR WABCO Brake system)</p>						
 <p>Connettore Ovale - Lungh. 800 mm Oval connector - Length 800 mm</p>	<p align="center">960524</p>	<p align="center">3424200600</p>							
			<p align="center">DESCRIZIONE / DESCRIPTION</p> <p>Kit segnalatori usura freno (2 pz.) Set of brake wear indicators (2 pcs) (impianto frenante HALDEX) (HALDEX Brake system)</p>						

TIPO DI VEICOLO / VEHICLE TYPE

ASSALE SAF - SAF AXLE U.T. SN6

(ruote da 19.5" - wheels from 19.5")

ILLUSTRAZIONE / ILLUSTRATION

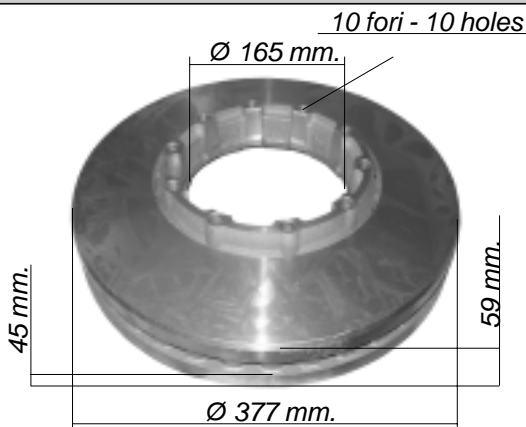

NOSTRO RIFERIMENTO OUR REFERENCE

960395

RIFERIMENTO COSTRUTTORE O.E. REFERENCE

040790010010

DESCRIZIONE / DESCRIPTION

Disco freno
Brake disc

Fascia AUTOVENTILANTE
SELF-VENTILATED Band



ILLUSTRAZIONE / ILLUSTRATION

IMPIANTO FRENANTE - BRAKE SYSTEM WABCO PAN 22-1



NOSTRO RIFERIMENTO OUR REFERENCE

960102

RIFERIMENTO COSTRUTTORE O.E. REFERENCE

3057008400

DESCRIZIONE / DESCRIPTION

Serie pastiglie freno completa di molle e kit accessori
Set of brake pads with springs and kit accessories

WVA	Larghezza Width - mm.	Altezza Height - mm.	Spessore Thickness - mm.
29162	210.60	109.55	31.70



ILLUSTRAZIONE / ILLUSTRATION



Connettore Ovale - Lungh. 365 mm
Oval connector - Length 365 mm

NOSTRO RIFERIMENTO OUR REFERENCE

960523

RIFERIMENTO COSTRUTTORE O.E. REFERENCE

000824.1

DESCRIZIONE / DESCRIPTION

Kit segnalatori usura freno (2 pz.)
Set of brake wear indicators (2 pcs)

TIPO DI VEICOLO / VEHICLE TYPE

ASSALE SAF
U.T. SN7

(ruote da 22.5" - wheels from 22.5")

ILLUSTRAZIONE / ILLUSTRATION

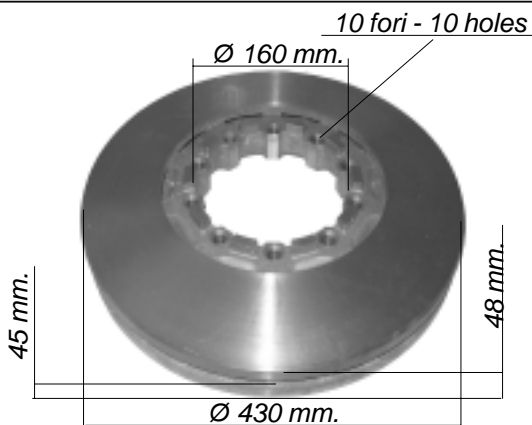
NOSTRO RIFERIMENTO
OUR REFERENCE**960396**RIFERIMENTO COSTRUTTORE
O.E. REFERENCE

040790013000

DESCRIZIONE / DESCRIPTION

Disco freno
Brake discFascia AUTOVENTILANTE
SELF-VENTILATED Band

ILLUSTRAZIONE / ILLUSTRATION

IMPIANTO FRENANTE - BRAKE SYSTEM
WABCO PAN 22-1NOSTRO RIFERIMENTO
OUR REFERENCE**960102**RIFERIMENTO COSTRUTTORE
O.E. REFERENCE

3057008400

DESCRIZIONE / DESCRIPTION

Serie pastiglie freno completa di molle e kit accessori
Set of brake pads with springs and kit accessories

WVA	Larghezza Width - mm.	Altezza Height - mm.	Spessore Thickness - mm.
29162	210.60	109.55	31.70



ILLUSTRAZIONE / ILLUSTRATION

Connettore Ovale - Lungh. 365 mm
Oval connector - Length 365 mmNOSTRO RIFERIMENTO
OUR REFERENCE**960523**RIFERIMENTO COSTRUTTORE
O.E. REFERENCE

000824.1

DESCRIZIONE / DESCRIPTION

Kit segnalatori usura freno (2 pz.)
Set of brake wear indicators (2 pcs)

TIPO DI VEICOLO / VEHICLE TYPE







TRAILER SMB 9Ton.

(Impianto KNORR)
(KNORR system)

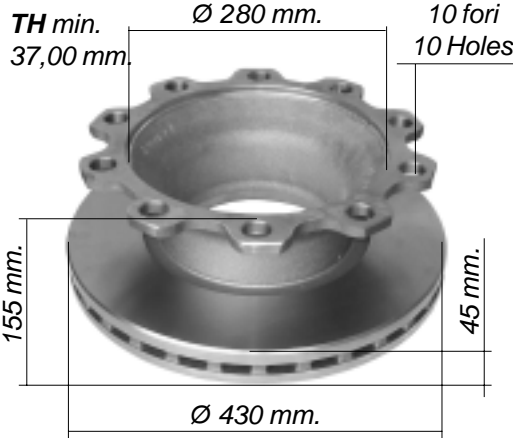
ILLUSTRAZIONE / ILLUSTRATION	NOSTRO RIFERIMENTO OUR REFERENCE	RIFERIMENTO COSTRUTTORE O.E. REFERENCE								
	<p>960364</p>	<p>449418 M078157</p>								
DESCRIZIONE / DESCRIPTION										
<p>Disco freno assale 9 ton. Brake disc for 9 ton. axle</p> <p>Fascia AUTOVENTILANTE SELF-VENTILATED Band</p>										
ILLUSTRAZIONE / ILLUSTRATION	NOSTRO RIFERIMENTO OUR REFERENCE	RIFERIMENTO COSTRUTTORE O.E. REFERENCE								
<p style="text-align: right;">E3 90R</p>	<p>960948</p>	<p>449412</p>								
DESCRIZIONE / DESCRIPTION										
<p>Serie pastiglie freno completa di molle e kit accessori Set of brake pads with springs and kit accessories</p>										
<p>960948/C</p>										
<p>Serie pastiglie freno completa di molle, kit accessori e piastre Set of brake pads with springs, kit accessories and plates</p>										
<table border="1" style="width: 100%; border-collapse: collapse;"> <thead> <tr> <th style="width: 15%;">WVA</th> <th style="width: 20%;">Larghezza Width - mm.</th> <th style="width: 20%;">Altezza Height - mm.</th> <th style="width: 20%;">Spessore Thickness - mm.</th> </tr> </thead> <tbody> <tr> <td style="text-align: center;">29095</td> <td style="text-align: center;">211</td> <td style="text-align: center;">92.5</td> <td style="text-align: center;">30</td> </tr> </tbody> </table>			WVA	Larghezza Width - mm.	Altezza Height - mm.	Spessore Thickness - mm.	29095	211	92.5	30
WVA	Larghezza Width - mm.	Altezza Height - mm.	Spessore Thickness - mm.							
29095	211	92.5	30							
ILLUSTRAZIONE / ILLUSTRATION	NOSTRO RIFERIMENTO OUR REFERENCE	RIFERIMENTO COSTRUTTORE O.E. REFERENCE								
<p>Connettore Tondo - Lungh. mm.365 Round connector - Length mm 365</p>	<p>960523</p>	<p>000824.1</p>								
DESCRIZIONE / DESCRIPTION										
<p>Kit segnalatori usura freno (2 pz.) Set of brake wear indicators (2 pcs)</p>										

TIPO DI VEICOLO / VEHICLE TYPE

TRAILER SMB 9Ton.(Impianto WABCO - Impianto KNORR)
(WABCO system - KNORR system)

ILLUSTRAZIONE / ILLUSTRATION	NOSTRO RIFERIMENTO OUR REFERENCE	RIFERIMENTO COSTRUTTORE O.E. REFERENCE													
	960363	449445 M069018 - M200135													
DESCRIZIONE / DESCRIPTION															
<p>Disco freno assale 9 ton. Brake disc for axle 9 ton.</p> <p>Fascia AUTOVENTILANTE SELF-VENTILATED Band</p> 															
ILLUSTRAZIONE / ILLUSTRATION	NOSTRO RIFERIMENTO OUR REFERENCE	RIFERIMENTO COSTRUTTORE O.E. REFERENCE													
	960944	449437													
DESCRIZIONE / DESCRIPTION															
<p>Serie pastiglie freno anteriore e posteriore completa di molle kit accessori SENZA piastre (1) Set of brake pads front and rear with springs, kit accessories WITHOUT plates (1) BREVETTO PENDENTE PENDING PATENT</p> <table border="1"> <thead> <tr> <th>WVA</th> <th>Larghezza Width - mm.</th> <th>Altezza Height - mm.</th> <th>Spessore Thickness - mm.</th> </tr> </thead> <tbody> <tr> <td>29087</td> <td rowspan="4">247,2</td> <td rowspan="4">109,7</td> <td rowspan="4">30</td> </tr> <tr> <td>29105</td> </tr> <tr> <td>29108</td> </tr> <tr> <td>29059</td> </tr> </tbody> </table> 			WVA	Larghezza Width - mm.	Altezza Height - mm.	Spessore Thickness - mm.	29087	247,2	109,7	30	29105	29108	29059		
WVA	Larghezza Width - mm.	Altezza Height - mm.	Spessore Thickness - mm.												
29087	247,2	109,7	30												
29105															
29108															
29059															
ILLUSTRAZIONE / ILLUSTRATION	NOSTRO RIFERIMENTO OUR REFERENCE	RIFERIMENTO COSTRUTTORE O.E. REFERENCE													
	960944/C	-													
DESCRIZIONE / DESCRIPTION															
<p>Serie pastiglie freno anteriore e posteriore completa di molle, kit accessori e piastre (2) Set of brake pads front and rear with springs, kit accessories and plates (2) BREVETTO PENDENTE PENDING PATENT</p> <table border="1"> <thead> <tr> <th>WVA</th> <th>Larghezza Width - mm.</th> <th>Altezza Height - mm.</th> <th>Spessore Thickness - mm.</th> </tr> </thead> <tbody> <tr> <td>29087</td> <td rowspan="6">247,2</td> <td rowspan="6">109,7</td> <td rowspan="6">30</td> </tr> <tr> <td>29105</td> </tr> <tr> <td>29108</td> </tr> <tr> <td>29059</td> </tr> <tr> <td>29061</td> </tr> <tr> <td></td> </tr> </tbody> </table> 			WVA	Larghezza Width - mm.	Altezza Height - mm.	Spessore Thickness - mm.	29087	247,2	109,7	30	29105	29108	29059	29061	
WVA	Larghezza Width - mm.	Altezza Height - mm.	Spessore Thickness - mm.												
29087	247,2	109,7	30												
29105															
29108															
29059															
29061															

TIPO DI VEICOLO / VEHICLE TYPE

TRAILER SMB 9Ton.

(Impianto WABCO - Impianto KNORR)
(WABCO system - KNORR system)

ILLUSTRAZIONE / ILLUSTRATION

NOSTRO RIFERIMENTO
OUR REFERENCERIFERIMENTO COSTRUTTORE
O.E. REFERENCE**960523**

000824.1



Connettore Tondo - Lungh. mm.365
Round conncector - Length mm. 365



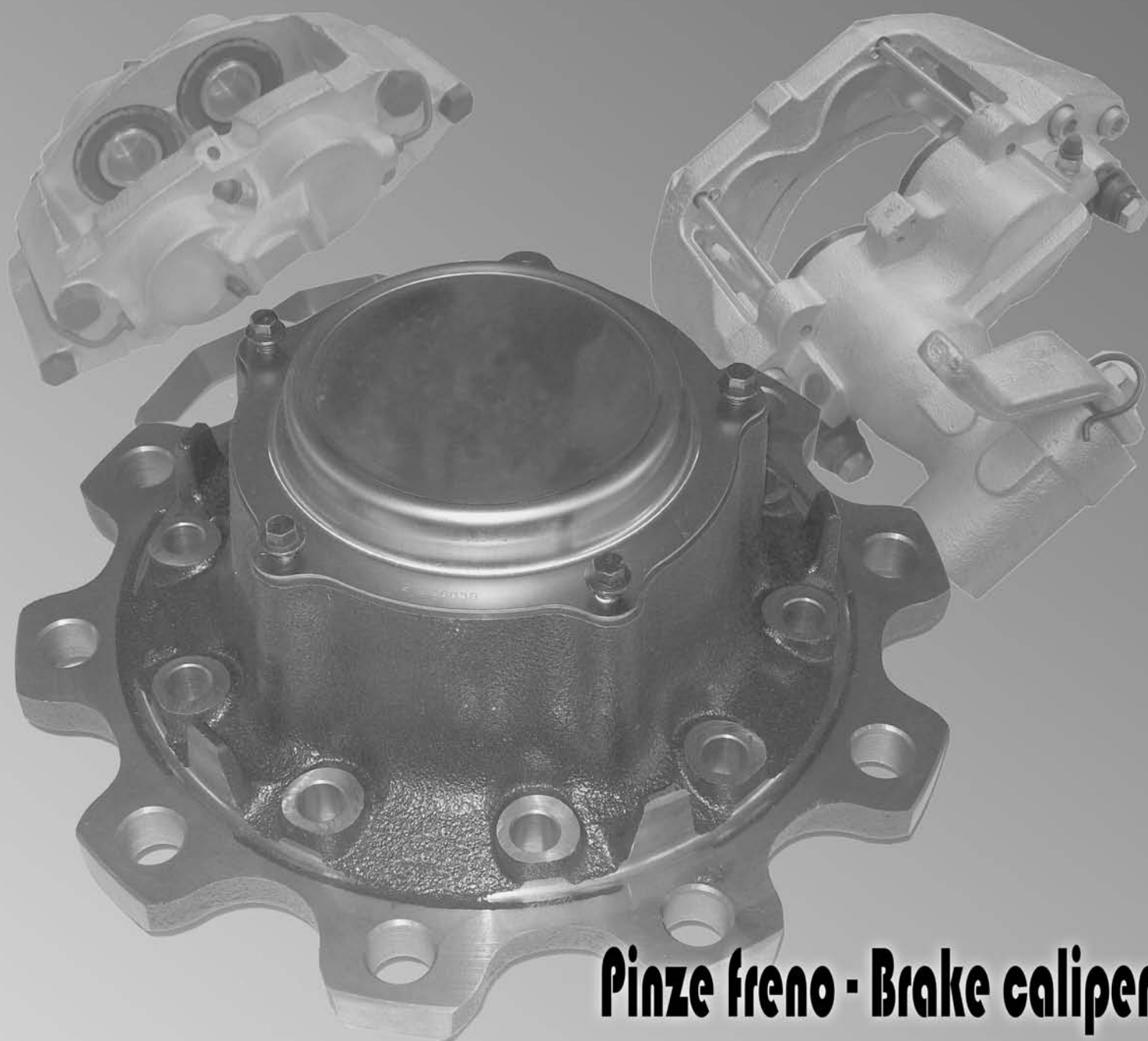

Kit segnalatori usura freno (2 pz.)
Set of brake wear indicators (2 pcs)

EMMEDRE





TECHNO
BRAKE®











Pinze freno - Brake caliper
Kit revisione e mozzi ruota
Brake repairing and wheel hub

	Ns Riferim. Our Ref.	Rif. Costr. O.E. Ref.	Descrizione/Tipo di veicolo Description/Vehicle Type
 <p>Senza pastiglie freno Without brake pads</p>	960373	42532363 99464095 93192367 93156970	<p>Pinza freno destra Brake caliper RH (Per serie pastiglie rif. 960894) (Brake pads for set ref. 960894)</p> <p>Daily 35.8 - 35.10 - 35.12 (fino / till 1996)</p>
 <p>Senza pastiglie freno Without brake pads</p>	960372	42532362 99464094 93192368 93156969	<p>Pinza freno sinistra Brake caliper LH (Per serie pastiglie rif. 960894) (Brake pads for set ref. 960894)</p> <p>Daily 35.8 - 35.10 - 35.12 (fino / till 1996)</p>
 <p>Con pastiglie freno With brake pads</p>	965056	99464101	<p>Pinza freno destra completa di pastiglie freno Brake caliper RH with brake pads</p> <p>Daily 45 - 49.10/12 (Brembo) Daily 45 - 49.10/12 4x4 (Perrot)</p>
 <p>Con pastiglie freno With brake pads</p>	965057	99464100	<p>Pinza freno sinistra completa di pastiglie freno Brake caliper LH with brake pads</p> <p>Daily 45 - 49.10/12 (Brembo) Daily 45 - 49.10/12 4x4 (Perrot)</p>





	Ns Riferim. Our Ref.	Rif. Costr. O.E. Ref.	Descrizione/Tipo di veicolo Description/Vehicle Type
 <p>Senza pastiglie freno Without brake pads</p>	975081	42536625 42536173 42548188 42470848	<p><i>Pinza freno anteriore destra</i> <i>Front brake caliper RH</i></p> <p>Daily City 2000 35C9-C11-C13 50C11-C13-C15</p> <p>Daily '96 35.8-35.10-35.12 - 49.10/12 (dal 09/00 - to 09/00)</p>
 <p>Senza pastiglie freno Without brake pads</p>	975080	42536624 42536172 42548187 42470847	<p><i>Pinza freno anteriore sinistra</i> <i>Front brake caliper LH</i></p> <p>Daily City 2000 35C9-C11-C13 50C11-C13-C15</p> <p>Daily '96 35.8-35.10-35.12 - 49.10/12 (dal 09/00 - from 09/00)</p>
 <p>Senza pastiglie freno Without brake pads</p>	975083	42536627 42536175 42548190	<p><i>Pinza freno posteriore destra</i> <i>Rear brake caliper RH</i></p> <p>Daily City 2000 35C9-C11-C13 50C11-C13-C15</p> <p>Daily '96 35.8-35.10-35.12 - 49.10/12 (dal 09/00 - from 09/00)</p>
 <p>Senza pastiglie freno Without brake pads</p>	975082	42536626 42536174 42548189	<p><i>Pinza freno posteriore sinistra</i> <i>Rear brake caliper LH</i></p> <p>Daily City 2000 35C9-C11-C13 50C11-C13-C15</p> <p>Daily '96 35.8-35.10-35.12 - 49.10/12 (dal 09/00 - from 09/00)</p>

	Ns Riferim. Our Ref.	Rif. Costr. O.E. Ref.	Descrizione/Tipo di veicolo Description/Vehicle Type
	975084	99465472	<i>Pinza freno anteriore sinistra</i> <i>Front brake caliper LH</i> Daily 59.12 Turbodaily '96
	975085	99465473	<i>Pinza freno anteriore destra</i> <i>Front brake caliper RH</i> Daily 59.12 Turbodaily '96
	975090	42554990	<i>Pinza freno posteriore sinistra</i> <i>Rear brake caliper SH</i> Daily MY 2006 65C14 / C15 / C18
	975091	42554991	<i>Pinza freno posteriore destra</i> <i>Rear brake caliper RH</i> Daily MY 2006 65C14 / C15 / C18





	Ns Riferim. Our Ref.	Rif. Costr. O.E. Ref.	Descrizione/Tipo di veicolo Description/Vehicle Type
	975086	42534119	<i>Pinza freno anteriore sinistra</i> <i>Front brake caliper LH</i> Eurocargo 60E10/E12/E14 75E12/E14 75E13/E15/E17/E18 Tector
	975087	42534120	<i>Pinza freno anteriore destra</i> <i>Front brake caliper LR</i> Eurocargo 60E10/E12/E14 75E12/E14 75E13/E15/E17/E18 Tector
	975088	42534121	<i>Pinza freno posteriore sinistra</i> <i>Rear brake caliper LH</i> Eurocargo 60E10/E12/E14 75E12/E14 75E13/E15/E17/E18 Tector
	975089	42534122	<i>Pinza freno posteriore destra</i> <i>Rear brake caliper LR</i> Eurocargo 60E10/E12/E14 75E12/E14 75E13/E15/E17/E18 Tector





	Ns Riferim. Our Ref.	Rif. Costr. O.E. Ref.	Descrizione/Tipo di veicolo Description/Vehicle Type
	960930	1902316	<p>Kit pinza freni Brake caliper kit</p> <p>Daily Restyling 30.8-35.8-40.8-35.10 New Daily 35.8-40.8-35.10 TurboDaily 35.12</p>
	960889	1902317	<p>Kit pinza freni Brake caliper kit</p> <p>Daily Restyling 30.8-35.8-40.8-35.10 New Daily 30.8-35.8-40.8-35.10 TurboDaily 30.10-35.10-35.12</p>
	965055	-	<p>Kit revisione pinza freno (Per pinza Rif. 99464100 - 99464101)</p> <p>Brake caliper overhaul kit (for brake caliper Ref. 99464100 - 99464101)</p> <p>Daily 45 - 49.10/12 (Brembo) Daily 45 - 49.10/12 4x4 (Perrot)</p>
	960829	42530365	<p>Molla freno per pinza freno Rif: Brake spring for brake caliper Ref: 42536624 - 42536625 42536626 - 42536627</p> <p>Daily City 2000 35C9-C11-C13 50C11-C13-C15 Daily '96 35.8-35.10-35.12 - 49.10/12 (dal 09/00 - from 09/00)</p>

	Ns Riferim. Our Ref.	Rif. Costr. O.E. Ref.	Descrizione/Tipo di veicolo Description/Vehicle Type
	960830	93161567	<p>Kit revisione guarnizioni ant. per pinze freno Rif. 42532362-42532363</p> <p>Front gaskets repairing kit for brake calipers Ref. 42532362 - 42532363</p> <p>Daily 35.8 - 35.10 - 35.12 (fino 1996)</p>
	960832	93161188	<p>Kit revisione guarnizioni ant. per pinze freno Rif. 99464100-99464101</p> <p>Front gaskets repairing kit for brake calipers Ref. 99464100 - 99464101</p> <p>Daily 45 - 49.10/12 (Brembo) Daily 45 - 49.10/12 4x4 (Perrot)</p>
	960833	93162189	<p>Kit revisione guarnizioni anteriori per pinze freno Rif. 42470837 - 42470838</p> <p>Front gaskets repairing kit for brake calipers Ref. 42470837 - 42470838</p> <p>Daily City 2000 35S9-35S11-35S13</p>
	960834	93161847	<p>Kit revisione guarnizioni per pinze freno anteriori Rif.42536624/625 posteriori Rif. 42536626/627</p> <p>Gaskets repairing kit for brake calipers Front Ref.42536624/625 Rear Ref. 42536626/627</p> <p>Daily City 2000 35C9-C11-C13 - 50C11-C13-C15 Daily '96 (dal 09/00 - to 09/00) 35.8-35.10-35.12 - 49.10/12</p>

	Ns Riferim. Our Ref.	Rif. Costr. O.E. Ref.	Descrizione/Tipo di veicolo Description/Vehicle Type
	960835	42535784	<p>Kit revisione guarnizioni anteriori per pinze freno Rif. 42535599/600 Front gaskets repairing kit for brake calipers Ref. 42535599/600</p> <p>Daily City 2000 65C11-65C13-65C15</p>
	960836	42535792	<p>Kit revisione guarnizioni posteriori per pinze freno Rif. 42535438/439 Rear gaskets repairing kit for brake calipers Ref. 42535438/439</p> <p>Daily City 2000 65C11-65C13-65C15</p>
 <p>Ø 42 mm</p>	960850	93161568	<p>Kit revisione pinza anteriore per pinze Rif. 42532362/363/364/365 Front repairing kit for brake calipers Ref. 42532362/363/364/365</p> <p>Daily 30.8 - 35.8 - 40.8 35.10 - 40.10 - 35.12 (1996)</p>
 <p>Ø 44 mm</p>	960848	93161187	<p>Kit revisione pinza anteriore per pinze Rif. 99464100/101 Front repairing kit for brake calipers Ref. 99464100/101</p> <p>Daily 45.10 - 49.10 - 49.12</p>





	Ns Riferim. Our Ref.	Rif. Costr. O.E. Ref.	Descrizione/Tipo di veicolo Description/Vehicle Type
	960828	93161849	<p><i>Kit revisione pinza ant. e post. Front and rear brake calipers repairing kit</i></p> <p>Daily - Daily 96 35.8 - 35.10 - 35.12 - 49.10 - 49.12</p> <p>Daily City 2000 35C9 - C11 - C13 50C11 - C13 - C15</p>
	960700	93161848	<p><i>Kit revisione pinza ant. e post. per pinze Rif. 42536172/173/174/175 Front and rear brake calipers repairing kit</i></p> <p>Ref. 42536172/173/174/175</p> <p>Daily 35.8 - 35.10 - 35.12 - 49.10 - 49.12</p> <p>Daily 96 Daily City 2000 35C9 - C11 - C13 50C11 - C13 - C15</p>
	960703	93162193	<p><i>Kit revisione pinza ant. e post. per pinze Rif. 42536172/173/174/175 Front and rear brake calipers repairing kit</i></p> <p>Ref. 42536172/173/174/175</p> <p>Daily - Daily 96 35.8 - 35.10 - 35.12 - 49.10 - 49.12</p> <p>Daily City 2000 35C9 - C11 - C13 35S9 - S11 - S13 - S15 50C11 - C13 - C15 65C11 - C13 - C15</p>
	960846	8121135	<p><i>Kit revisione pinza anteriore per pinze Rif. 42532362/363/364/365 Front brake calipers repairing kit</i></p> <p>Ref. 42532362/363/364/365</p> <p>Daily 30.8 - 35.8 - 40.8 - 35.10 - 35.12</p>

	Ns Riferim. Our Ref.	Rif. Costr. O.E. Ref.	Descrizione/Tipo di veicolo Description/Vehicle Type
 <p>Ø 42 MM.</p>	960713	93156966	<p>Kit revisione pinza anteriore Front brake calipers repairing kit</p> <p>New Daily 30.8-35.8-35.10 Daily Restyling 30.8-35.8-35.10</p>
 <p>Ø 52 MM.</p>	960714	42548325 42535785	<p>Kit revisione pinza anteriore Front brake calipers repairing kit</p> <p>Daily City 2000 65C11-65C13-65C15</p>
 <p>Ø 46 MM.</p>	960715	42548326 42535793	<p>Kit revisione pinza posteriore Rear brake calipers repairing kit</p> <p>Daily City 2000 65C11-65C13-65C15</p>
	960716	42555882	<p>Kit revisione pinza anteriore Front brake calipers repairing kit</p> <p>Daily 2006 M. Y. 35C14/C16/C18</p>
	960717	42555883	<p>Kit revisione pinza anteriore Front brake calipers repairing kit</p> <p>Daily 2006 M. Y. 35C14/C16/C18</p>

	Ns Riferim. Our Ref.	Rif. Costr. O.E. Ref.	Descrizione/Tipo di veicolo Description/Vehicle Type
 <p>Ø 48 MM.</p>	<p>960718</p>	<p>42555884</p>	<p><i>Kit revisione pinza anteriore</i> <i>Front brake calipers repairing kit</i></p> <p>Daily 2006 M. Y. 35C14/C16/C18</p>
	<p>960719</p>	<p>42555416</p>	<p><i>Kit revisione pinza anteriore e post.</i> <i>Front and rear brake calipers repairing kit</i></p> <p>Daily 2006 M. Y. 35C14/C16/C18</p>
	<p>960720</p>	<p>42555418</p>	<p><i>Kit revisione pinza posteriore</i> <i>Rear brake calipers repairing kit</i></p> <p>Daily 2006 M. Y. 35C14/C16/C18</p>
	<p>960721</p>	<p>42555419</p>	<p><i>Kit revisione pinza posteriore</i> <i>Rear brake calipers repairing kit</i></p> <p>Daily 2006 M. Y. 35C14/C16/C18</p>

	Ns Riferim. Our Ref.	Rif. Costr. O.E. Ref.	Descrizione/Tipo di veicolo Description/Vehicle Type
	960015	42555636	Kit revisione guarnizioni pinza freni Brake caliper gaskets repairing kit Daily M. Y. 2006 65-C.14
	960016	42555417	Kit revisione pinza freni viti Brake caliper repairing kit screw Daily M. Y. 2006 65-C.14
	960017	93161181	Kit revisione pinza freni Brake caliper repairing kit Daily 59.12 (96)
	960026	93160387	Kit pistoni pinza Piston set for brake caliper TurboDaily 59.12 (96)



	Ns Riferim. Our Ref.	Rif. Costr. O.E. Ref.	Descrizione/Tipo di veicolo Description/Vehicle Type
	960014	42555637	<i>Kit pistoni per pinza freni</i> <i>Piston set for brake caliper</i> Daily M.Y. 2006 65-C.14
	960013	42555635	<i>Kit ricambio molla pinza freni</i> <i>Spring brake caliper spare replacement kit</i> Daily M.Y. 2006 65-C.14
	960090	93160388	<i>Molla pinza freni</i> <i>Spring brake caliper</i> TURBODAILY 59.12 (96)
	960091	93160389	<i>Perno calibrato pinza</i> <i>Pin brake caliper</i> TURBODAILY 59.12 (96)

	Ns Riferim. Our Ref.	Rif. Costr. O.E. Ref.	Descrizione/Tipo di veicolo Description/Vehicle Type
	960725	8124032	<p>Kit revisione pinza anteriore per pinza RIF. 4824821/22 per pinza RIF. 7169623/24 Front brake calipers repairing kit for brake calipers Ref. 4824821/22 - 7169623/24</p> <p>Turbozeta 65.12 - 79.12 Zeta 79.14</p>
	960724	42541464	<p>Kit revisione pinza anteriore Front brake calipers repairing kit</p> <p>EUROCARGO TECTOR 180 EURO CURSOR STRALIS</p>
 <p>Ø 68 MM.</p>	960722	93193784	<p>Pistone per pinza freno Piston for brake caliper</p> <p>EUROCARGO 80E15-80E18-80E21 100E15-100E18-100E21</p> <p>EUROCARGO TECTOR 100E17-100E18-100E21</p>
 <p>Ø 68 MM.</p>	960723	93193785	<p>Pistone per pinza freno Piston for brake caliper</p> <p>EUROCARGO 80E15-80E18-80E21 100E15-100E18-100E21</p> <p>EUROCARGO TECTOR 100E17-100E18-100E21</p>





	Ns Riferim. Our Ref.	Rif. Costr. O.E. Ref.	Descrizione/Tipo di veicolo Description/Vehicle Type
	<p>960837</p>	<p>93162075</p>	<p>Kit revisione guarnizioni per pinze freno Anteriori Rif. 42534119/120 Posteriori Rif. 42534121/122 Gaskets repairing kit for brake calipers Front Ref. 42534119/120 Rear Ref. 42534121/122</p> <p>Eurocargo 60-65-75</p>
	<p>960843</p>	<p>93162043 93161871</p>	<p>Kit revisione guarnizioni ant. e post. per pinze Rif. 42534119/120/121/122 Gaskets repairing kit front and rear for brake calipers Ref. 42534119/120/121/122</p> <p>Eurocargo 60 - 65 - 75</p>
	<p>960841</p>	<p>93162076</p>	<p>Kit revisione guarnizioni per pinze freno Anteriori Rif. 42534115-116 Posteriori Rif. 42534117/118 Gaskets repairing kit for brake calipers Front Ref. 42534115-116 Rear Ref. 42534117/118</p> <p>Eurocargo 80-100</p>
	<p>960847</p>	<p>93161757</p>	<p>Kit revisione pinza ant. e post. per pinze Rif. 42534119/120/121/122 per pinze Rif. 42534115/116/117/118 Front and rear brake calipers repairing kit for brake calipers Ref. 42534119/120/121/122 Ref. 42534115/116/117/118</p> <p>Eurocargo 60 - 65 - 75 - 80 - 100</p> <p>Eurocargo Tector</p>





	Ns Riferim. Our Ref.	Rif. Costr. O.E. Ref.	Descrizione/Tipo di veicolo Description/Vehicle Type
	960849	93161759	<p>Kit revisione pinza ant. e post. per pinze Rif. 42534119/120/121/122 per pinze Rif. 42534115/116/117/118 Front and rear brake calipers repairing kit for brake calipers Ref. 42534119/120/121/122 Ref. 42534115/116/117/118</p> <p>Eurocargo 60 - 65 - 75 - 80 - 100 Eurocargo Tector</p>



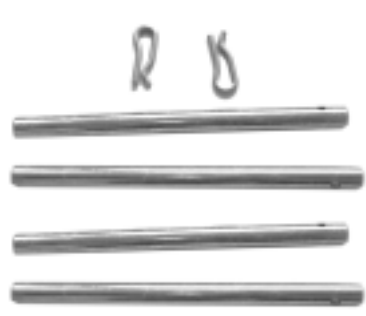

	Ns Riferim. Our Ref.	Rif. Costr. O.E. Ref.	Descrizione/Tipo di veicolo Description/Vehicle Type
	960705	93161976	<p>Kit revisione pinza anteriore per pinze Rif. 42534119/120 Front brake calipers repairing kit for brake calipers Ref. 42534119/120</p> <p>Eurocargo 60 - 65 - 75</p>
	960706	93161977	<p>Kit revisione pinza posteriore per pinze Rif. 42534117/118/121/122 Rear brake calipers repairing kit for brake calipers Ref. 42534117/118/121/122</p> <p>Eurocargo 60 - 65 - 75 - 80 - 100</p>
	960707	93162050	<p>Kit revisione pinza anteriore per pinze Rif. 99458477/478 Front brake calipers repairing kit for brake calipers Ref. 99458477/478</p> <p>Eurocargo - Eurocargo Tector 130 - 150 - 170 - 180 - 260</p> <p>Eurotech - Eurotech Cursor 180 - 190 - 240 - 260 - 400 - 440</p> <p>Eurotrakker - Eurotrakker Cursor 190 - 260 - 340 - 380 - 400 - 410 - 720</p> <p>Eurostar - Eurostar Cursor 180 - 190 - 240 - 260 - 400 - 440</p> <p>Stralis 440</p>

	Ns Riferim. Our Ref.	Rif. Costr. O.E. Ref.	Descrizione/Tipo di veicolo Description/Vehicle Type
	960708	42538002	<p>Kit revisione pinza per pinze Rif. 99458477/478 Brake calipers repairing kit for brake calipers Ref. 99458477/478</p> <p>Eurocargo - Eurocargo Tector 130 - 150 - 170 - 180 - 260 Eurotech - Eurotech Cursor 180 - 190 - 240 - 260 - 400 - 440 Eurotrakker - Eurotrakker Cursor 190 - 260 - 340 - 380 - 400 - 410 - 720 Eurostar - Eurostar Cursor 180 - 190 - 240 - 260 - 400 - 440 Stralis 440</p>
	960709	42541413	<p>Kit revisione pinza per pinze Rif. 41211269/270 Brake calipers repairing kit for brake calipers Ref. 41211269/270</p> <p>Eurocargo - Eurocargo Tector 130 - 150 - 180 Eurotech - Eurotech Cursor 190 - 260 - 440 Eurotrakker - Eurotrakker Cursor 190 - 260 - 340 - 380 - 410 - 440 - 720 Eurostar - Eurostar Cursor 190 - 260 - 440 Stralis 190 - 260 - 440</p>
	960710	42541412	<p>Kit revisione pinza per pinze Rif. 41211269/270 Brake calipers repairing kit for brake calipers Ref. 41211269/270</p> <p>Eurocargo - Eurocargo Tector 130 - 150 - 180 Eurotech - Eurotech Cursor 190 - 260 - 440 Eurotrakker - Eurotrakker Cursor 190 - 260 - 340 - 380 - 410 - 440 - 720 Eurostar - Eurostar Cursor 190 - 260 - 440 Stralis 190 - 260 - 440</p>

	Ns Riferim. Our Ref.	Rif. Costr. O.E. Ref.	Descrizione/Tipo di veicolo Description/Vehicle Type
	960711	42530519	<p><i>Pistone per pinza ant. e post.</i> <i>Piston for front and rear brake calipers</i></p> <p>Eurocargo 60 - 65 - 75</p>
	960712	42530520	<p><i>Pistone per pinza posteriore</i> <i>Piston for rear brake caliper</i></p> <p>Eurocargo 60 - 65 - 75</p>
	960009	93162033	<p><i>Kit pistoni pinza (ex 93161428) - 4 pz</i> <i>Brake caliper piston set (ex 93161428)- 4 pcs.</i></p> <p>Eurocargo Tector 90E15 - 18 - 21 100E21</p>
	960004	93191658	<p><i>Molla per pinza freni</i> <i>Springs for brake caliper</i></p> <p>Eurocargo Tector</p>

	Ns Riferim. Our Ref.	Rif. Costr. O.E. Ref.	Descrizione/Tipo di veicolo Description/Vehicle Type
	960005	93191659	<i>Perno calibrato per pinza</i> <i>Pin for brake caliper</i> Eurocargo Tector
	960077	93161429	<i>Kit guarnizioni revisione pinza freni</i> <i>Gaskets repairing kit for brake caliper</i> Eurocargo Tector
	960078	93162044	<i>Kit guarnizioni revisione pinza freni</i> <i>Gaskets repairing kit for brake caliper</i> Eurocargo Tector
	960079	93159285	<i>Pistone per pinza freni</i> <i>Piston for brake caliper</i> Eurocargo Tector

	Ns Riferim. Our Ref.	Rif. Costr. O.E. Ref.	Descrizione/Tipo di veicolo Description/Vehicle Type
	960080	93161244	<p>Pistone Piston</p> <p>Eurocargo</p>
	960081	42538003	<p>Kit revisione pinza freni Brake caliper repairing kit</p> <p>Eurocargo-Eurotrakker-Eurotech 170E27 - E18 - E23 180E21 - E24 - E28 190E24 - E27 - E31 -E38 - E44 260E31 - E31 -E 38 - E44 380 / 400E38</p>
	960082	8124735	<p>Kit revisione pinza Brake caliper repairing kit</p> <p>Eurocargo 80E15</p>
	960083	93161471 93161034	<p>Kit revisione pinza Brake caliper repairing kit</p> <p>Eurocargo 80E15</p>

	Ns Riferim. Our Ref.	Rif. Costr. O.E. Ref.	Descrizione/Tipo di veicolo Description/Vehicle Type
	960084	93161475 93161035	<i>Kit revisione pinza freni</i> <i>Brake caliper repairing kit</i> Eurocargo 80E15
	960085	93161908	<i>Kit revisione pinza freni, piastre e perni</i> <i>Brake caliper repairing kit. plates and pins</i> Eurocargo T.T Eurotech 120 - 150- 170 Eurostar
	960086	93161559	<i>Kit revisione pinza freni</i> <i>Brake caliper repairing kit</i> Eurocargo TT 120 - 150 Eurotech Eurostar
	960087	93161192	<i>Kit revisione pinza freni</i> <i>Brake caliper repairing kit</i> Eurocargo TT 120 - 150 - 170 Eurotech Eurostar

IVECO**KIT REVISIONE PINZE FRENO
BRAKE CALIPERS OVERHAUL KIT****EMMERRE**

	Ns Riferim. Our Ref.	Rif. Costr. O.E. Ref.	Descrizione/Tipo di veicolo Description/Vehicle Type
	960088	93161189	Kit revisione pinza freni <i>Brake caliper repairing kit</i> Eurocargo 120 - 150 - 170 Eurotech Eurostar

SAF**PINZE FRENO
BRAKE CALIPERS****EMMERRE**

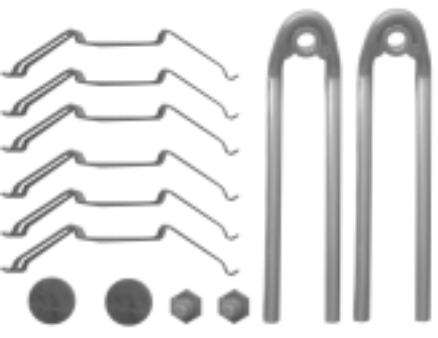
	960999/C	-	Kit revisione pinza freni <i>Brake caliper repairing kit</i> SAF Trailer SK RS 9019 - 11019 Trailer SK RZ 9019 - 11019 Trailer SK RB 9019 - 9022 (ruote da 19.5" - wheels 19.5")
--	-----------------	---	---

	Ns Riferim. Our Ref.	Rif. Costr. O.E. Ref.	Descrizione/Tipo di veicolo Description/Vehicle Type
	960280	-	<p><i>Albero con molla di trasmissione per pinze freno</i> <i>Brake caliper spring shaft</i></p> <p>Adattabile - Adaptable: KNORR SB/SN -6/7 Tutti i tipi - All types</p>
	960281	-	<p><i>Albero di registro cuscinetti per pinza freno</i> <i>Brake caliper bearing shaft</i></p> <p>Adattabile - Adaptable: KNORR SB/SN - 6/7 Tutti i tipi - All types</p>
	960282	-	<p><i>Albero registro cuscinetti per pinza freno</i> <i>Brake caliper calibration bearing shaft</i></p> <p>Adattabile - Adaptable: KNORR SB/SN -5</p>
	960283	-	<p><i>Corpo per cuscinetti pinza freno nuovo modello</i> <i>Brake caliper bearing shaft body new model</i></p> <p>Adattabile - Adaptable: KNORR SN 6/7</p>

**KIT REVISIONE PINZE FRENO
BRAKE CALIPERS OVERHAUL KIT**

EMMERRE

	Ns Riferim. Our Ref.	Rif. Costr. O.E. Ref.	Descrizione/Tipo di veicolo Description/Vehicle Type
	960284	-	<p><i>Supporto per cuscinetti tipo corto piano per pinza freno angolo 0° Brake caliper bearing short angle bed</i></p> <p>Adattabile - Adaptable: KNORR SB6 BPW-DAF-IVECO-MAN- MERCEDES-NEOPLAN-SAF SCANIA</p>
	960285	-	<p><i>Supporto per cuscinetti tipo lungo angolare 12° per pinza freno angolo Brake caliper bearing long angle bed</i></p> <p>Adattabile - Adaptable: KNORR SB6 BPW-DAF-IVECO-MAN- MERCEDES-NEOPLAN-SAF SCANIA</p>
	960286	-	<p><i>Supporto per cuscinetti tipo corto piano per pinza freno angolo 0° Brake caliper bearing short smooth bed</i></p> <p>Adattabile - Adaptable: KNORR SB7 BPW-DAF-IVECO-MAN- MERCEDES-NEOPLAN-SAF SCANIA</p>
	960287	-	<p><i>Supporto per cuscinetti tipo lungo angolare per pinza freno Brake caliper bearing long smooth bed</i></p> <p>Adattabile - Adaptable: KNORR SB7 BPW-DAF-IVECO-MAN- MERCEDES-NEOPLAN-SAF SCANIA</p>

	Ns Riferim. Our Ref.	Rif. Costr. O.E. Ref.	Descrizione/Tipo di veicolo Description/Vehicle Type
	960288	-	<p><i>Kit revisione pinza freni nuovo modello con registro</i> <i>Brake caliper calibration set new model con registro</i></p> <p>Adattabile - Adaptable: WABCO / PAN19-1 / PLUS / SAF/ DAF</p>
	960289	-	<p><i>Kit revisione pinza freni nuovo modello</i> <i>Brake caliper pin repair kit new model</i></p> <p>Adattabile - Adaptable: WABCO / PAN19-1 / PLUS / SAF/ DAF</p>
	960290	-	<p><i>Kit revisione pinza con albero e molla u.t.</i> <i>Brake caliper calibration shaft with spring</i></p> <p>Adattabile - Adaptable: WABCO / PAN17-19</p>
	960291	-	<p><i>Kit revisione pinza freni con perni nuovo modello (ELSA2)</i> <i>Brake caliper pin repair kit new model</i></p> <p>Adattabile - Adaptable: MERITOR - LUCAS MAN - MERCEDES - RENAULT</p>

**KIT REVISIONE PINZE FRENO
BRAKE CALIPERS OVERHAUL KIT**

EMMERRE

	Ns Riferim. Our Ref.	Rif. Costr. O.E. Ref.	Descrizione/Tipo di veicolo Description/Vehicle Type
	960292	-	<p><i>Kit revisione pinza freni anteriore destra/sinistra</i> <i>Brake caliper repair kit front right-left</i></p> <p>Adattabile - Adaptable: MERITOR - LUCAS - MAN MERCEDES</p>
	960293	-	<p><i>Kit revisione pinza freni posteriore destra/sinistra</i> <i>Brake caliper repair kit rear right-left</i></p> <p>Adattabile - Adaptable: MERITOR - LUCAS - MAN MERCEDES</p>
	960294	-	<p><i>Ingranaggio pinza freni destra</i> <i>Brake caliper calibration gear right</i></p> <p>Adattabile - Adaptable: MERITOR - LUCAS (ELSA 1) IRISBUS - MAN - MERCEDES RENAULT</p>
	960295	-	<p><i>Ingranaggio pinza freni sinistra</i> <i>Brake caliper calibration gear left</i></p> <p>Adattabile - Adaptable: MERITOR - LUCAS (ELSA 1) IRISBUS - MAN - MERCEDES RENAULT</p>

	Ns Riferim. Our Ref.	Rif. Costr. O.E. Ref.	Descrizione/Tipo di veicolo Description/Vehicle Type
	960296	-	<i>Ingranaggio piccolo pinza freni destra</i> <i>Brake caliper gear small right</i> Adattabile - Adaptable: MERITOR - LUCAS RENAULT
	960297	-	<i>Ingranaggio piccolo pinza freni sinistra</i> <i>Brake caliper gear small left</i> Adattabile - Adaptable: MERITOR - LUCAS RENAULT
	960279	-	<i>Ingranaggio grande pinza freni destra</i> <i>Brake caliper gear big right</i> Adattabile - Adaptable: MERITOR - LUCAS (MOD.LISA) IRISBUS - MERCEDES - MAN RENAULT - VOLVO BUS
	960278	-	<i>Ingranaggio grande pinza freni sinistra</i> <i>Brake caliper gear big left</i> Adattabile - Adaptable: MERITOR - LUCAS (MOD.LISA) IRISBUS - MERCEDES - MAN RENAULT - VOLVO BUS

**KIT REVISIONE PINZE FRENO
BRAKE CALIPERS OVERHAUL KIT**



EMMERRE





	Ns Riferim. Our Ref.	Rif. Costr. O.E. Ref.	Descrizione/Tipo di veicolo Description/Vehicle Type
	960277	-	<p><i>Kit revisione pinza freni Brake caliper kit</i></p> <p>Adattabile - Adaptable: MERITOR - LUCAS (MOD.LISA) IRISBUS -RENAULT - VOLVO BUS</p>
	960276	-	<p><i>Kit perni con ingranaggio di registro per pinza freni Brake lining calibration gear set</i></p> <p>Adattabile - Adaptable: MERITOR (ELSA2) MAN - MAN BUS - RENAULT - ROR</p>
	960275	-	<p><i>Dispositivo registro pinza freni Brake caliper calibration gear bed</i></p> <p>Adattabile - Adaptable: MERITOR (ELSA2) MAN - MAN BUS - RENAULT - ROR</p>
	960274	-	<p><i>Albero con ingranaggio di registro pinza freni Brake caliper shaft small gear</i></p> <p>Adattabile - Adaptable: MERITOR (ELSA 1) IRIBUS - MAN</p>

	Ns Riferim. Our Ref.	Rif. Costr. O.E. Ref.	Descrizione/Tipo di veicolo Description/Vehicle Type
	960273	-	<p><i>Albero con ingranaggio piccolo per pinza freni</i> <i>Brake caliper shaft small gear</i></p> <p>Adattabile - Adaptable: MERITOR (ELSA 2) MAN - RENAULT- ROR</p>
	960269	-	<p><i>Boccola registro pinza freni</i> <i>Brake caliper calibration shaft nest</i></p> <p>Adattabile - Adaptable: MERITOR (ELSA 1) IRISBUS - MAN - MAN BUS</p>
	960268	-	<p><i>Kit revisione boccole registro pinza freni (2 boccole + 2 paraoli)</i> <i>Brake caliper calibration shaft nest</i></p> <p>Adattabile - Adaptable: MERITOR (ELSA 2) MAN - RENAULT - ROR</p>
	960267	3092264	<p><i>Kit revisione pinza freno</i> <i>Brake caliper kit</i></p> <p>Adattabile - Adaptable: MERITOR - VOLVO FH/FM - ROR</p>

**KIT REVISIONE PINZE FRENO
BRAKE CALIPERS OVERHAUL KIT**



EMMERRE

	Ns Riferim. Our Ref.	Rif. Costr. O.E. Ref.	Descrizione/Tipo di veicolo Description/Vehicle Type
	960266	85102092	<p><i>Kit revisione pinza freno anteriore Brake caliper kit front</i></p> <p>Adattabile - Adaptable: MERITOR-RENAULT VOLVO FH/FM</p>
	960265	85102094	<p><i>Kit revisione pinza freno posteriore Brake caliper kit rear</i></p> <p>Adattabile - Adaptable: MERITOR-ROR-VOLVO FH/FM</p>
<p align="center">DISPONIBILE A MAGAZZINO AVAILABLE ON STOCK</p>	960264	3095626	<p><i>Kit revisione molle registro pinza freni Repair kit, springs adjusting gear</i></p> <p>Adattabile - Adaptable: MERITOR</p>
	960263	3092263	<p><i>Kit revisione pinza freni assale posteriore destro Repair kit rear brake caliper right</i></p> <p>Adattabile - Adaptable: MERITOR - VOLVO FH/FM</p>





	Ns Riferim. Our Ref.	Rif. Costr. O.E. Ref.	Descrizione/Tipo di veicolo Description/Vehicle Type
	960262	3092262	<i>Kit revisione pinza freni assale posteriore sinistro</i> <i>Repair kit rear brake caliper left</i> Adattabile - Adaptable: MERITOR - VOLVO FH/FM
	960261	3092267	<i>Kit registro freni automatico anteriore sinistro</i> <i>Brake caliper repair kit automatic adjuster front/left</i> Adattabile - Adaptable: VOLVO FH/FM
	960260	85102093	<i>Kit registro freni automatico anteriore destro</i> <i>Brake caliper repair kit automatic adjuster front/right</i> Adattabile - Adaptable: VOLVO FH/FM
	960259	85102096	<i>Kit registro freni automatico posteriore sinistro</i> <i>Brake caliper repair kit automatic adjuster rear/left</i> Adattabile - Adaptable: VOLVO FH/FM

**KIT REVISIONE PINZE FRENO
BRAKE CALIPERS OVERHAUL KIT**

EMMERRE



	Ns Riferim. Our Ref.	Rif. Costr. O.E. Ref.	Descrizione/Tipo di veicolo Description/Vehicle Type
	960258	85102095	<p><i>Kit registro freni automatico posteriore destro</i> <i>Brake caliper repair kit automatic adjuster rear/right</i></p> <p>Adattabile - Adaptable: VOLVO FH/FM</p>
	960257	3092261	<p><i>Kit cuscinetti anteriori pinza freno</i> <i>Brake caliper bearing kit front</i></p> <p>Adattabile - Adaptable: VOLVO FH/FM</p>
	960157	3092329	<p><i>Kit cuscinetti posteriori pinza freno</i> <i>Brake caliper bearing kit rear</i></p> <p>Adattabile - Adaptable: VOLVO FH-FM</p>

Copyright della EMMERRE S.r.l. - Settimo Torinese - Tutti i diritti sono riservati e depositati a norma di legge ed a norma delle convenzioni internazionali. - E' vietata la duplicazione o la riproduzione anche parziale senza la previa autorizzazione della EMMERRE S.r.l.

	Ns Riferim. Our Ref.	Rif. Costr. O.E. Ref.	Descrizione/Tipo di veicolo Description/Vehicle Type
	960302	-	<p><i>Corpo Cuscinetti pinza freno</i> <i>Bearings body for brake caliper</i></p> <p>Adattabile - Adaptable: KNORR SN6/7 SCANIA</p>
	960340	-	<p><i>Corpo Cuscinetti pinza freno</i> <i>Bearings body for brake caliper</i></p> <p>Adattabile - Adaptable: KNORR SB6/7 SCANIA</p>
	960400	3092270	<p><i>Kit revisione guarnizioni pinza freno</i> <i>Gaskets repairing kit for brake caliper</i></p> <p>Adattabile - Adaptable: MERITOR - VOLVO</p>
	960401	3095669	<p><i>Kit revisione guarnizioni pinza freno</i> <i>Gaskets repairing kit for brake caliper</i></p> <p>Adattabile - Adaptable: MERITOR - VOLVO</p>

**KIT REVISIONE PINZE FRENO
BRAKE CALIPERS OVERHAUL KIT**

EMMERRE

	Ns Riferim. Our Ref.	Rif. Costr. O.E. Ref.	Descrizione/Tipo di veicolo Description/Vehicle Type
	960403	3092269	Kit revisione guarnizioni pinza freno Gaskets repairing kit for brake caliper Adattabile - Adaptable: MERITOR - ROR - VOLVO
	960415	-	Piastra pinza freno sx/dx Brake caliper plates LH/RH Adattabile - Adaptable: WABCO PAN 17/19 - 1/19 PLUS SAF
	960416	-	Spessore pinza freno Brake caliper ring Adattabile - Adaptable: MERITOR (ELSA 1) MAN-MERCEDES-IRISBUS- LUCAS
	960420	-	Piastra pinza freni Brake caliper plates LH/RH Adattabile - Adaptable: MERITOR-MAN-MERCEDES- LUCAS



	Ns Riferim. Our Ref.	Rif. Costr. O.E. Ref.	Descrizione/Tipo di veicolo Description/Vehicle Type
	961001	-	<i>Supporto pinza freno Brake caliper support</i> Adattabile - Adaptable: MERITOR (ELSA 2) - MAN MANBUS-RENAULT-ROR
	961002	3090997	<i>Registro sx Z-CAM Adjuster LH Z-CAM</i> Adattabile - Adaptable: VOLVO
	961003	3090998	<i>Registro dx Z-CAM Adjuster RH Z-CAM</i> Adattabile - Adaptable: VOLVO

EMMEDRE

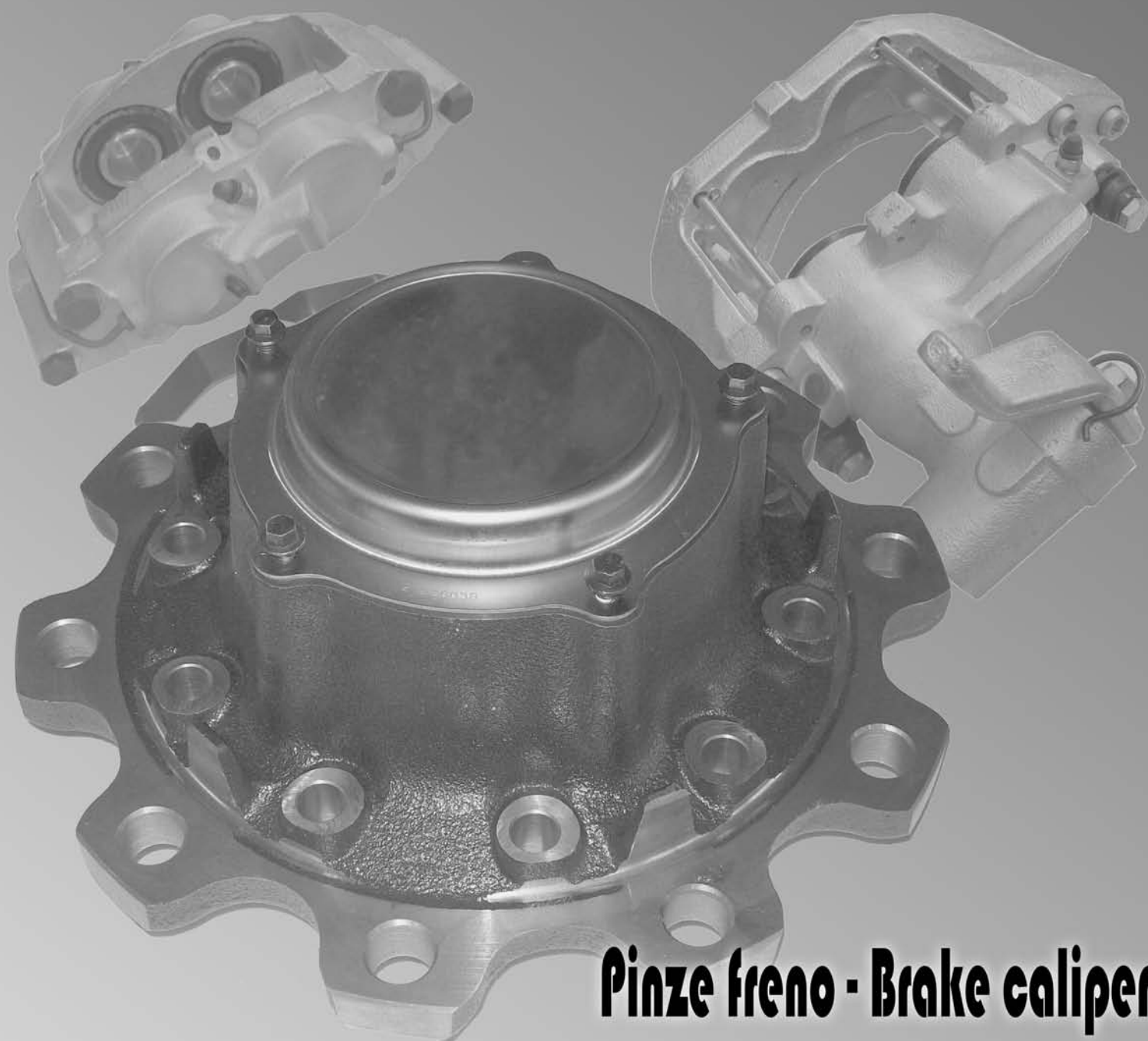
TECHNO
BRAKE®



Pinze freno - Brake caliper
Kit revisione e mozzi ruota
Brake repairing and wheel hub

	Ns Riferim. Our Ref.	Rif. Costr. O.E. Ref.	Descrizione/Tipo di veicolo Description/Vehicle Type
	931750	016973460	Mozzo ruota ant./post. completo di cuscinetti Wheel hub front/rear with bearings XF - CF
	931751	013916170	Mozzo ruota ant./post. completo di cuscinetti Wheel hub front/rear with bearings XF - CF

	Ns Riferim. Our Ref.	Rif. Costr. O.E. Ref.	Descrizione/Tipo di veicolo Description/Vehicle Type
	931005	93813627	<p><i>Mozzo anteriore completo di cuscinetti</i> <i>Front hub assy with bearings</i></p> <p>New Daily 30.8 - 35.8 - 40.8</p>
	931009	26800140	<p><i>Cuscinetto interno mozzo</i> <i>Inside bearing hub</i></p> <p>New Daily 30.8 - 35.8 - 40.8</p>
	931010	26800330	<p><i>Cuscinetto esterno mozzo</i> <i>Outward bearing hub</i></p> <p>New Daily 30.8 - 35.8 - 40.8</p>

	Ns Riferim. Our Ref.	Rif. Costr. O.E. Ref.	Descrizione/Tipo di veicolo Description/Vehicle Type
	931006	93813628	<p>Mozzo anteriore completo di cuscinetti Front hub assy with bearings</p> <p>New Daily 35.10 - 49.10 Turboaily 35.12 - 49.12 - 59.12</p>
	931011	8582739	<p>Cuscinetto interno mozzo Inside bearing hub</p> <p>New Daily 35.10 - 49.10 Turboaily 35.12 - 49.12 - 59.12</p>
	931012	8582740	<p>Cuscinetto esterno mozzo Outward bearing hub</p> <p>New Daily 35.10 - 49.10 Turboaily 35.12 - 49.12 - 59.12</p>

	Ns Riferim. Our Ref.	Rif. Costr. O.E. Ref.	Descrizione/Tipo di veicolo Description/Vehicle Type
	931004	93824579	<p><i>Mozzo anteriore completo di cuscinetti</i> <i>Front hub assy with bearings</i></p> <p>Daily City 2000 35S9 - 35S11 - 35S13</p>
	931000	42470845	<p><i>Kit mozzo ruota anteriore</i> <i>Front hub assy set</i></p> <p>Daily City 2000 35S9 - 35S11 - 35S13</p>
	931015	BTH1024C	<p><i>Cuscinetto mozzo ruota anteriore per mozzo Rif. 93824579 - 42470845</i> <i>Front wheel hub bearing for wheel hub Ref. 93824579 - 42470845</i></p> <p>Daily City 2000 35S9 - 35S11 - 35S13</p>





	Ns Riferim. Our Ref.	Rif. Costr. O.E. Ref.	Descrizione/Tipo di veicolo Description/Vehicle Type
	931001	93824580	<p>Mozzo anteriore completo di cuscinetti Front hub assy with bearings</p> <p>Daily City 2000 35C9-C11-C13 50C11-C13-C15 Daily '96 35.8-35.10-35.12 - 49.10/12 (dal 09/00 - from 09/00)</p>
	931013	98430602	<p>Corona dentata per mozzo ruota anteriore Plate wheel for front hub assy</p> <p>Daily City 2000 35C9-C11-C13 50C11-C13-C15 Daily '96 35.8-35.10-35.12 - 49.10/12 (dal 09/00 - from 09/00)</p>
	931002	42470834	<p>Kit mozzo ruota anteriore Front hub assy set</p> <p>Daily City 2000 35C9-C11-C13 50C11-C13-C15 Daily '96 35.8-35.10-35.12 - 49.10/12 (dal 09/00 - from 09/00)</p>
	931020	1861887	<p>Cuscinetto per mozzo ruota Rif. 42470834 Bearing for wheel hub Ref. 42470834</p> <p>Daily '96 Daily City 2000</p>

	Ns Riferim. Our Ref.	Rif. Costr. O.E. Ref.	Descrizione/Tipo di veicolo Description/Vehicle Type
	931007	7169265 7168256	Mozzo ruota posteriore Rear wheel hub Daily Restyling 30.8 - 40.8 - 35.8 - 35.10 New Daily 30.8 - 40.8 - 35.8 - 35.10 Turbo Daily 35.12
	931008	7180049	Mozzo ruota posteriore Rear wheel hub New Daily 35.10 - 49.10 (1996) Turbo Daily 35.12 - 49.12 - 59.12 (1996)
	931014	7180066	Cuscinetto mozzo ruota posteriore per mozzo rif. 7169265-7180049 Rear wheel hub bearing for wheel hub Ref. 7169265 - 7180049 Daily Restyling 30.8-40.8-35.8-35.10 New Daily 30.8-40.8-35.8-35.10 Turbo Daily 35.12 New Daily 35.10-49.10 (1996) Turbo Daily 35.12-49.12-59.12 (1996)
	962000	7180039	Ghiera mozzo ruote BST Wheel hub bush Iveco Daily T.T.





	Ns Riferim. Our Ref.	Rif. Costr. O.E. Ref.	Descrizione/Tipo di veicolo Description/Vehicle Type
	931017	7181957	<i>Mozzo ruota posteriore</i> <i>Rear hub assy</i> Daily City 2000 65C11/C13/C15
	931018	1905220	<i>Cuscinetto per mozzo ruota</i> <i>Rif. 7181957</i> <i>Bearing for hub Ref. 7181957</i> Turbodaily 59.12 Daily City 2000 65C11/C13/C15 EUROCARGO 60-65-75 EUROCARGO TECTOR 75



	Ns Riferim. Our Ref.	Rif. Costr. O.E. Ref.	Descrizione/Tipo di veicolo Description/Vehicle Type
	931019	42471216	<p><i>Kit mozzo ruota anteriore completo di cuscinetto</i> <i>Front hub assy kit with bearing</i></p> <p>Daily City 2000 65C11/C13/C15</p>
	931021	BTH1053	<p><i>Cuscinetto per mozzo ruota anteriore per Rif. 42471216</i> <i>Front hub bearing for Ref. 42471216</i></p> <p>Daily City 2000 65C11/C13/C15</p>
	931016	500349833	<p><i>Mozzo ruota anteriore</i> <i>Front hub assy</i></p> <p>Daily City 2000 65C11/C13/C15</p>



	Ns Riferim. Our Ref.	Rif. Costr. O.E. Ref.	Descrizione/Tipo di veicolo Description/Vehicle Type
	931030	7168586	<i>Mozzo ruota anteriore</i> <i>Front wheel hub</i> Iveco Turbostar - Turbotech 190.30 - 190.33 - 190.38
	931031	7168464	<i>Mozzo ruota posteriore</i> <i>Rear wheel hub</i> Iveco Turbostar - Turbotech 190.30 - 190.33 - 190.38
	931040	42101362 42101959 42037491	<i>Mozzo ruota posteriore</i> <i>Rear wheel hub</i> 330.26 - 330.30 - 330.36
	931032	42104691	<i>Mozzo ruota posteriore</i> <i>(freno a tamburo)</i> <i>Rear wheel hub (drum brake)</i> Eurotech Eurotrakker Cursor

	Ns Riferim. Our Ref.	Rif. Costr. O.E. Ref.	Descrizione/Tipo di veicolo Description/Vehicle Type
	<p>931033</p>	<p>7173747</p>	<p>Mozzo ruota anteriore Completo di cuscinetti e boccia Front wheel hub with bearings and bush</p> <p>Eurocargo 80-85-95-100-180E15/E18/E21 Eurocargo Tector 100E17/E18/E21</p>
	<p>931034</p>	<p>7173314</p>	<p>Mozzo ruota anteriore Front wheel hub</p> <p>Eurocargo 170 Eurotech 180 - 190 - 400 Eurostar 400</p>
	<p>931035</p>	<p>7173696</p>	<p>Mozzo ruota posteriore Rear wheel hub</p> <p>Eurocargo 80E15/E18/E21 Eurocargo 100E15/E18/E21</p>
	<p>931036</p>	<p>7182040</p>	<p>Mozzo ruota anteriore Completo di cuscinetti e boccia Front wheel hub with bearings and bush</p> <p>Eurocargo 130E15/E18/E23/E27 150E15/E18/E23/E27</p>





	Ns Riferim. Our Ref.	Rif. Costr. O.E. Ref.	Descrizione/Tipo di veicolo Description/Vehicle Type
	931037	42115016	<i>Mozzo ruota anteriore</i> <i>Front wheel hub</i> Eurocargo 135E18 Eurotrakker 260-340-380-720 (6x6 - 4x4)
	931038	7180909	<i>Mozzo ruota posteriore</i> <i>Rear wheel hub</i> Eurotech Eurostar Cursor Stralis
	931039	7172993	<i>Mozzo ruota posteriore</i> <i>Rear wheel hub</i> Eurocargo 60E10/E12/E14 75E10/E12/E14 Tector 75E13/E15/E27
	931041	7180797	<i>Mozzo ruota anteriore</i> <i>Front wheel hub</i> Eurocargo Tector 170 - 180 - 260 Eurotech Eurostar Eurotrakker Cursor Stralis



	Ns Riferim. Our Ref.	Rif. Costr. O.E. Ref.	Descrizione/Tipo di veicolo Description/Vehicle Type
	<p>931042</p>	<p>7179929</p>	<p><i>Mozzo ruota posteriore</i> <i>Rear wheel hub</i></p> <p>Eurotech Eurostar</p>
	<p>931043</p>	<p>7179777</p>	<p><i>Mozzo ruota posteriore</i> <i>Rear wheel hub</i></p> <p>Eurocargo</p>
	<p>931044</p>	<p>42101918</p>	<p><i>Mozzo ruota posteriore</i> <i>Rear wheel hub</i></p> <p>Eurotrakker <i>Eurotrakker Cursor</i> <i>Eurotech</i> <i>Eurotech Cursor</i></p>
	<p>931023</p>	<p>7182032</p>	<p><i>Mozzo ruota anteriore</i> <i>Front wheel hub</i></p> <p>Eurotech Eurostar Eurotrakker Cursor</p>



	Ns Riferim. Our Ref.	Rif. Costr. O.E. Ref.	Descrizione/Tipo di veicolo Description/Vehicle Type
	931700	402029x100	Mozzo ruota anteriore Completo di cuscinetti Front wheel hub with bearings Cabstar
	931701	43202F3903	Mozzo ruota posteriore Completo di cuscinetti Rear wheel hub with bearings Cabstar

	Ns Riferim. Our Ref.	Rif. Costr. O.E. Ref.	Descrizione/Tipo di veicolo Description/Vehicle Type
	931801	1480933	<p>Mozzo ruota anteriore per disco freno ns. rif. 960052</p> <p>Front wheel hub for our disc ref. 960052</p> <p>Scania Serie 4</p>
	931800	1382884	<p>Mozzo ruota posteriore per disco freno ns. rif. 960052</p> <p>Rear wheel hub for our disc ref. 960052</p> <p>Scania Serie 4</p>
	931802	1414154	<p>Mozzo ruota anteriore / posteriore con freni a tamburo Front / Rear wheel hub with Drum Brakes</p> <p>Scania</p>

	Ns Riferim. Our Ref.	Rif. Costr. O.E. Ref.	Descrizione/Tipo di veicolo Description/Vehicle Type
	931300	125699112	<i>Mozzo ruota sterzante (Massa frenante mm.160) Steering Wheel hub (Wheel brake mm.160)</i>

	Ns Riferim. Our Ref.	Rif. Costr. O.E. Ref.	Descrizione/Tipo di veicolo Description/Vehicle Type
	931404	0980106030	<p>Mozzo ruota completo di cuscinetto Wheel hub with bearing</p> <p>BPW Assale Eco serie H (9 ton) Axle Eco series H (9 ton)</p>
	931406	0327243100 0980106070	<p>Mozzo ruota per freno a tamburo Wheel hub for drum brake</p> <p>BPW Assale Eco Plus - Serie H (9 ton) Axle Eco Plus - Series H (9 ton)</p>
	931400	0327248460	<p>Mozzo ruota senza cuscinetto Wheel hub without bearing</p> <p>BPW Assale serie H-R (12 ton) Axle Series H-R (12 ton)</p>
	931401	0327230410	<p>Mozzo ruota senza cuscinetto Wheel hub without bearing</p> <p>BPW Assale serie H-R (8-9 ton) Axle Series H-R (8-9 ton)</p>



	Ns Riferim. Our Ref.	Rif. Costr. O.E. Ref.	Descrizione/Tipo di veicolo Description/Vehicle Type
	931402	0980106050	<i>Mozzo ruota completo di cuscinetto</i> <i>Wheel hub with bearing</i> BPW <i>Assale Eco Maxx - Serie H (9 ton)</i> <i>Axle Eco Maxx - Series H (9 ton)</i>
	931403	0980106580	<i>Mozzo ruota completo di cuscinetto</i> <i>Wheel hub with bearing</i> BPW <i>Assale Eco Plus (9 ton)</i> <i>Axle Eco Plus (9 ton)</i>



	Ns Riferim. Our Ref.	Rif. Costr. O.E. Ref.	Descrizione/Tipo di veicolo Description/Vehicle Type
	931200	59520004	<p>Mozzo ruota per massa frenante mm.180 - 200 (ruota gemellata) Wheel hub for wheel brake mm. 180 - 200 (twin wheel)</p>
	931201	59510104	<p>Mozzo ruota per massa frenante mm.160 (ruota semplice) Wheel hub for wheel brake mm. 160 (one wheel)</p>



	Ns Riferim. Our Ref.	Rif. Costr. O.E. Ref.	Descrizione/Tipo di veicolo Description/Vehicle Type
	931250	23114100	Mozzo ruota Wheel hub O/CAVA (11 ton)
	931251	23115100	Mozzo ruota Wheel hub O/CAVA (14 ton)



	Ns Riferim. Our Ref.	Rif. Costr. O.E. Ref.	Descrizione/Tipo di veicolo Description/Vehicle Type
	<p>931820</p>	<p>0003500535</p>	<p>Mozzo ruota Completo di cuscinetti Wheel hub with bearings</p> <p>Assali Mercedes per Rimorchi Axles Mercedes for Trailers</p>

Copyright della EMMERRE S.r.l. - Settimo Torinese - Tutti i diritti sono riservati e depositati a norma di legge ed a norma delle convenzioni internazionali. - E' vietata la duplicazione o la riproduzione anche parziale senza la previa autorizzazione della EMMERRE S.r.l.

	Ns Riferim. Our Ref.	Rif. Costr. O.E. Ref.	Descrizione/Tipo di veicolo Description/Vehicle Type
	931500	14204562	Mozzo ruota Completo di cuscinetti Wheel hub with bearings ROR Assale TM - Serie 33000 (ruota gemellata) Axle TM - Series 33000 (twin wheels)
	931501	14225425	Mozzo ruota Completo di cuscinetti Wheel hub with bearings ROR Assale LM (freni a disco) Axle LM (disc brakes)
	931502	14224748	Mozzo ruota Completo di cuscinetti Wheel hub with bearings ROR Assale LM (freni a tamburo) Axle LM (drum brakes)

	Ns Riferim. Our Ref.	Rif. Costr. O.E. Ref.	Descrizione/Tipo di veicolo Description/Vehicle Type
	931503	14219784	<p>Mozzo ruota Completo di cuscinetti Wheel hub with bearings</p> <p>ROR Assale TE 9000 (9 Ton) Axle TE 9000 (9 Ton)</p>
	931504	14203219	<p>Mozzo ruota Completo di cuscinetti Wheel hub with bearings</p> <p>ROR Assale TM 15" (10 fori) Axle TM 15" (10 holes)</p>
	931505	14210885	<p>Mozzo ruota Completo di cuscinetti Wheel hub with bearings</p> <p>ROR Carrello sterzante Steering truck</p>

	Ns Riferim. Our Ref.	Rif. Costr. O.E. Ref.	Descrizione/Tipo di veicolo Description/Vehicle Type
	931506	14226121	Mozzo ruota Completo di cuscinetti Wheel hub with bearings ROR Assale TA (ruota gemellata) (freni a disco) Axle TA (twin wheel) (disc brakes)
	931508	14226120	Mozzo ruota Completo di cuscinetti Wheel hub with bearings ROR Assale TA (freni a tamburo) Axle TA (drum brakes)
	931507	14227483	Mozzo ruota Completo di cuscinetti Wheel hub with bearings ROR

	Ns Riferim. Our Ref.	Rif. Costr. O.E. Ref.	Descrizione/Tipo di veicolo Description/Vehicle Type
	<p>931600</p>	<p>3434365000</p>	<p>Mozzo ruota Completo di cuscinetti per disco freno NS rif. 960371 - 960362</p> <p>Wheel hub with bearings for brake disc NS ref. 960371 - 960362</p> <p>SAF</p>
	<p>931601</p>	<p>1146200402</p>	<p>Flangia di fissaggio mozzo per disco freno NS rif. 960371 - 960362</p> <p>Wheel hub fixing flange for brake disc Our ref. 960371 - 960362</p> <p>SAF</p>

EMMERRE

TECHNO
BRAKE®

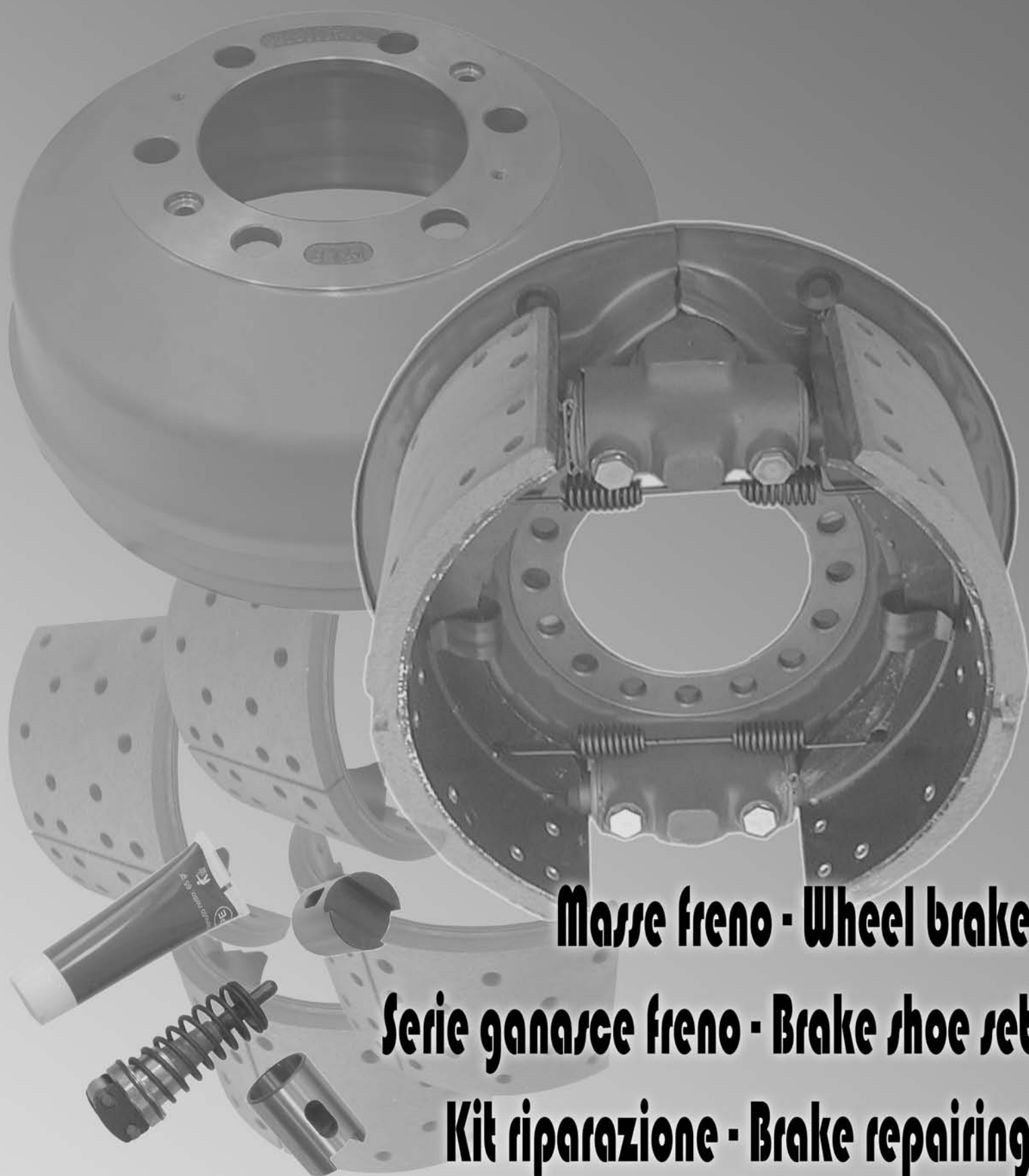

Masse freno - Wheel brake

Serie ganasce freno - Brake shoe set





Kit riparazione - Brake repairing



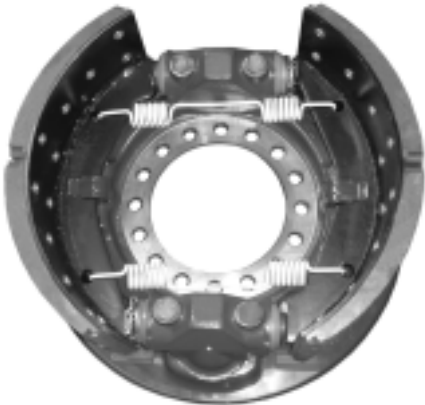
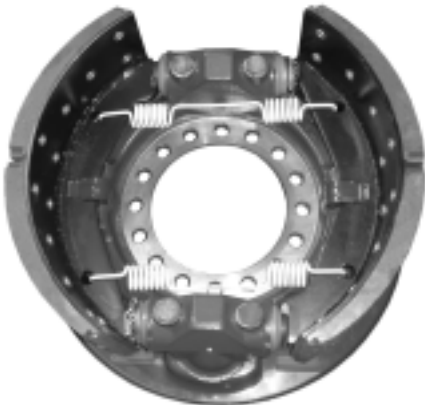

Tamburi freno - Brake drum

TIPO DI VEICOLO / VEHICLE TYPE

ASTRA





ILLUSTRAZIONE / ILLUSTRATION	NOSTRO RIFERIMENTO OUR REFERENCE	RIFERIMENTO COSTRUTTORE O.E. REFERENCE
<p>(DUPLEX) H 180 mm.</p> 	963502 (1)	-
	963503 (2)	-
	DESCRIZIONE / DESCRIPTION	
	(1) <i>Massa frenante completa anteriore sinistra Ø 410 x 180</i> <i>Complete front wheel brake left Ø 410 x 180</i>	
	(2) <i>Massa frenante completa anteriore destra Ø 410 x 180</i> <i>Complete front wheel brake right Ø 410 x 180</i>	
ILLUSTRAZIONE / ILLUSTRATION	NOSTRO RIFERIMENTO OUR REFERENCE	RIFERIMENTO COSTRUTTORE O.E. REFERENCE
<p>(DUPLEX) H 200 mm.</p> 	963500 (1)	159040
	963501 (2)	159038
	DESCRIZIONE / DESCRIPTION	
	(1) <i>Massa frenante completa posteriore sinistra Ø 410 x 200</i> <i>Complete rear wheel brake left Ø 410 x 200</i>	
	(2) <i>Massa frenante completa posteriore destra Ø 410 x 200</i> <i>Complete rear wheel brake right Ø 410 x 200</i>	



	Ns Riferim. Our Ref.	Rif. Costr. O.E. Ref.	Descrizione/Tipo di veicolo Description/Vehicle Type
<p><i>Impianto / System</i> LOCKHEED</p>  <p><i>Cilindretto/Cylinder</i> Rif. 8121575 Ø 17.4 mm.</p>	963086	500300073	<p>Massa frenante Sx Ø 254x89 mm. Wheel brake left Ø 254x89 mm.</p>
	963087	500300075	<p>Massa frenante Dx Ø 254x89 mm. Wheel brake right Ø 254x89 mm.</p> <p>Daily Restyling 35.8-35.10 New Daily 35.8-40.8-35.10-45.10-49.10</p>
<p><i>Impianto / System</i> LOCKHEED</p>  <p><i>Cilindretto/Cylinder</i> Rif. 8121575 Ø 17.4 mm.</p>	963098	500300079	<p>Massa frenante Sx Ø 254x89 mm. con segnalatore Wheel brake left Ø 254x89 mm. with brake wear indicator</p>
	963097	500300080	<p>Massa frenante Dx Ø 254x89 mm. con segnalatore Wheel brake right Ø 254x89 mm. with brake wear indicator</p> <p>New Daily 35.10 Turbo Daily 35.12</p>
<p><i>Impianto / System</i> LOCKHEED</p>  <p><i>Cilindretto/Cylinder</i> Rif. 93160540 Ø 19.5 mm.</p>	963057	500300092	<p>Massa frenante Sx Ø 254x89 mm. con segnalatore Wheel brake left Ø 254x89 mm. with brake wear indicator</p>
	963056	500300093	<p>Massa frenante Dx Ø 254x89 mm. con segnalatore Wheel brake right Ø 254x89 mm. with brake wear indicator</p> <p>New Daily 35.10-49.10 Turbo Daily 35.12</p>
<p><i>Impianto / System</i> PERROT</p>  <p><i>Cilindretto/Cylinder</i> Rif. 93155720 Ø 20.6 mm.</p>	962075	99436612	<p>Massa frenante Sx Ø 270x80 mm. Wheel brake left Ø 270x80 mm.</p>
	962076	99436613	<p>Massa frenante Dx Ø 270x80 mm. Wheel brake right Ø 270x80 mm.</p> <p>Daily Restyling 49.10 New Daily 35.8-45.10-49.10 Turbo Daily 49.12</p>

	Ns Riferim. Our Ref.	Rif. Costr. O.E. Ref.	Descrizione/Tipo di veicolo Description/Vehicle Type
	961009	1906350	<p>Serie ganasce freno fascia 89 mm. senza segnalatore d'usura Brake shoes set h.89 mm. without brake wear indicator</p> <p>New Daily 35.8-40.8-35.10-45.10-49.10 Turbo Daily 35.12 Daily Restyling 35.8-35.10</p>
	961042	-	<p>Serie ganasce freno con ceppo maggiorato 10/10 Brake shoes set with brake lining increased 10/10</p> <p>New Daily 35.8-40.8-35.10-45.10-49.10 Turbo Daily 35.12 Daily Restyling 35.8-35.10</p>
 Con segnalatore usura With brake wear indicator	961011	1906351	<p>Serie ganasce freno fascia 89 mm. con segnalatore Brake shoes set h.89 mm. with brake wear indicator</p> <p>New Daily 35.8 - 35.10 Turbo Daily 35.10-35.12</p>
 Fascia / Uning H 70 mm.	961018	1906352	<p>Serie ganasce freno fascia 70 mm. Brake shoes set h.70 mm</p> <p>New Daily 30.8 Daily Restyling 30.8 Turbo Daily 30.10 (Ruota singola)</p>

	Ns Riferim. Our Ref.	Rif. Costr. O.E. Ref.	Descrizione/Tipo di veicolo Description/Vehicle Type
<p><i>Impianto / System</i> PERROT</p> 	<p>961040</p>	<p>1906377</p>	<p><i>Serie ganasce freno fascia 80 mm. Brake shoe set h.80 mm.</i></p> <p>Daily Restyling 49.10 New Daily 35.8-45.10-49.10 Turbo Daily 49.12</p>

Copyright della EMMERRE S.r.l. - Settimo Torinese - Tutti i diritti sono riservati e depositati a norma di legge ed a norma delle convenzioni internazionali. - E' vietata la duplicazione o la riproduzione anche parziale senza la previa autorizzazione della EMMERRE S.r.l.

	Ns Riferim. Our Ref.	Rif. Costr. O.E. Ref.	Descrizione/Tipo di veicolo Description/Vehicle Type
	963085	-	Kit revisione freno posteriore sinistro (LH) (una ruota) senza cilindretto x 500300073
	963084	-	Kit revisione freno posteriore destro (RH) (una ruota) senza cilindretto x 500300075 Rear brake repairing kit (one wheel) without cylinder Daily Restyling 30.8-35.8-40.8-35.10 New Daily 30.8-35.8-40.8-35.10 Turbo Daily 35.12
	963101	8124927	Kit revisione freno sinistro Brake repairing kit left
	963100	8124924	Kit revisione freno destro Brake repairing kit right Daily Restyling 30.8-35.8-40.8-35.10 New Daily 30.8-35.8-40.8-35.10 Turbo Daily 35.12
	963116	-	Kit revisione freno sinistro senza registro Brake repairing kit left without brake adjuster
	963117	-	Kit revisione freno destro senza registro Brake repairing kit right without brake adjuster Daily Restyling 30.8-35.8-40.8-35.10 New Daily 30.8-35.8-40.8-35.10 Turbo Daily 35.12
	960884	8124928	Kit leve freno sinistro Brake lever kit left
	960883	8124925	Kit leve freno destro Brake lever kit right Daily Restyling 30.8-35.8-40.8-35.10 New Daily 30.8-35.8-40.8-35.10 Turbo Daily 35.12

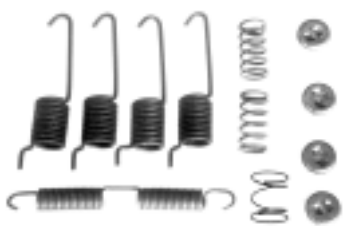
	Ns Riferim. Our Ref.	Rif. Costr. O.E. Ref.	Descrizione/Tipo di veicolo Description/Vehicle Type
	<p>963089</p> <p>963088</p>	<p>93161124</p> <p>93161123</p>	<p><i>Kit molle freno sinistro modifica con 5° molla</i> <i>Brake springs set left modified with fifth spring</i></p> <p><i>Kit molle freno destro modifica con 5° molla</i> <i>Brake springs set right modified with fifth spring</i></p> <p>Daily Restyling 30.8-35.8-40.8-35.10 New Daily 30.8-35.8-40.8-35.10 Turbo Daily 35.12</p>
	<p>963099</p>	<p>-</p>	<p><i>Kit pernetto fermo ganaschia</i> <i>Fixing shoe pin set</i></p> <p>Daily Restyling 30.8-35.8-40.8-35.10 New Daily 30.8-35.8-40.8-35.10 Turbo Daily 35.12</p>
<p><i>Impianto / System</i> PERROT</p> 	<p>961523</p>	<p>8124934</p>	<p><i>Kit molle freno</i> <i>Brake springs set</i></p> <p>Daily Restyling 45.10-49.10 New Daily 35.8-45.10-49.10 Turbo Daily 49.12</p>

KIT MASSA FRENANTE CON TAMBURO WHEEL BRAKE SET WITH DRUM

Ns. Riferim. Our Ref.	Rif. Costrutt. O.E. Ref.	Descrizione Description	Tipo di veicolo Vehicle Type
962094	-	Kit massa frenante sinistra con tamburo Ø 254x89 LH	Daily Restyling 35.8-40.8-35.10
962093	-	Kit massa frenante destra con tamburo Ø 254x89 RH Wheel brake kit with drum kit	New Daily 35.8-40.8-35.10



IMPIANTO LOCKHEED LOCKHEED SYSTEM

SENZA SEGNALATORE
WITHOUT INDICATOR



Ns. Riferim. Our Ref.	Rif. Costrutt. O.E. Ref.	Descrizione Description	Tipo di veicolo Vehicle Type
962095	-	Kit massa frenante sinistra c/segnalatore con tamburo Ø 254x89 LH	New Daily 35.10 Turbo Daily 35.12
962096	-	Kit massa frenante destra c/segnalatore con tamburo Ø 254x89 RH Wheel brake kit with indicator with drum	



IMPIANTO LOCKHEED LOCKHEED SYSTEM

CON SEGNALATORE
WITH INDICATOR



KIT REVISIONE FRENI FRONT AND REAR COMPLETE REPAIRING BRAKE SYSTEM SET

Ns. Riferim. Our Ref.	Rif. Costrutt. O.E. Ref.	Descrizione Description	Tipo di veicolo Vehicle Type
964045	-	Kit revisione impianto frenante completo anteriore e posteriore	Daily Restyling 35.8-40.8-35.10 New Daily 35.8-40.8-35.10



**COMPLETO DI:
COMPLETE OF:**

1-500300073
1-500300075
1-1904529
2-7165379
1-1906159
2-40100483

Ns. Riferim. Our Ref.	Rif. Costrutt. O.E. Ref.	Descrizione Description	Tipo di veicolo Vehicle Type
964046	-	Kit revisione impianto frenante completo anteriore e posteriore	New Daily(96) 35.8 Turbo Daily(96) 35.10-49.10 - 35.12-49.12 Daily 2000 35C9-35C11 35C13-50C11







**COMPLETO DI:
COMPLETE OF:**

1-42470842
1-42471111
2-1906401
1-1906403
2-1908407

	Ns Riferim. Our Ref.	Rif. Costr. O.E. Ref.	Descrizione/Tipo di veicolo Description/Vehicle Type
	970103	504060927 99431433	Completivo freno a mano completo posteriore Dx Complete rear hand brake assembly RH
	970104	504060926 99431432	Completivo freno a mano completo posteriore Sx Complete rear hand brake assembly LH New Daily 96 35.8 Turbo Daily 96 35.10-49.10 - 35.12-49.12 Daily City 2000 35C9-35C11-35C13 Daily City 2000 50C11 - 50C13
	970132	504093277	Completivo freno a mano completo posteriore Dx Complete rear hand brake assembly RH
	970131	504093276	Completivo freno a mano completo posteriore Sx Complete rear hand brake assembly LH Daily M.Y. 2006
	961010	1906403	Serie ganasce freno a mano post. Rear brake shoes set for hand brake New Daily 96 35.8 TurboDaily 96 35.10-49.10-35.12-49.12 Daily City 2000 35C9-35C11-35C13 50C11-50C13



	Ns Riferim. Our Ref.	Rif. Costr. O.E. Ref.	Descrizione/Tipo di veicolo Description/Vehicle Type
	970101	2992568	<p><i>Serie ganasce freno a mano posteriori</i> <i>Rear brake shoes set for hand brake</i></p> <p>New Daily 96 35.8 Turbo Daily 96 35.10-49.10 - 35.12-49.12 Daily City 2000 35C9-35C11-35C13 Daily City 2000 50C11 - 50C13</p>
	970120	2995817	<p><i>Serie ganasce freno a mano posteriori</i> <i>Rear brake shoes set for hand brake</i></p> <p>Daily M.Y. 2006</p>
	970102	42535858	<p><i>Serie ganasce freno a mano posteriori</i> <i>Rear brake shoes set for hand brake</i></p> <p>Daily City 2000 65C11-C13-C15</p>

	Ns Riferim. Our Ref.	Rif. Costr. O.E. Ref.	Descrizione/Tipo di veicolo Description/Vehicle Type
	961045	42536259 93161850	<p><i>Kit di riparazione (freno a mano)</i> <i>Repairing kit (for hand brake)</i></p> <p>New Daily 96 35.8 TurboDaily 96 35.10-49.10-35.12-49.12 Daily City 2000 35C9-35C11-35C13 50C11-50C13</p>
	961046	93161851	<p><i>Kit di riparazione (freno a mano)</i> <i>Repairing kit (for hand brake)</i></p> <p>New Daily 96 35.8 TurboDaily 96 35.10-49.10-35.12-49.12 Daily City 2000 35C9-35C11-35C13 50C11-50C13</p>
	961047	93161852	<p><i>Kit di riparazione (freno a mano)</i> <i>Repairing kit (for hand brake)</i></p> <p>New Daily(96) 35.8 TurboDaily(96) 35.10-49.10-35.12-49.12 Daily 2000 35C9-35C11-35C13 - 50C11-50C13</p>

	Ns Riferim. Our Ref.	Rif. Costr. O.E. Ref.	Descrizione/Tipo di veicolo Description/Vehicle Type
	963525	42530368	<p>Leva piatto freno a mano (Rif. 99431432 - 99431433) Lever for hand brake (Ref. 99431432-99431433)</p> <p>Daily '96 Daily City 2000 35C9/C10/C11/C12/C13/C15 50C11/C13/C15</p>
	963598	42535860	<p>Leva piatto freno a mano (Rif. 500369260 - 500369261) Lever for hand brake (Ref. 500369260 - 500369261)</p> <p>Daily City 2000 65C11/C13/C15</p>
	963597	-	<p>Kit leve freno a mano (per ganasce freno) Levers set for hand brake</p> <p>Daily Restyling 49.10 New Daily 35.8-45.10-49.10 Turbo Daily 49.12</p>
	963618	42535859	<p>Kit molle richiamo Spring set</p> <p>Daily City 2000 65C11/C13/C15</p>

TIPO DI VEICOLO / VEHICLE TYPE

Zeta 50.9 - TurboZeta 65.12

ILLUSTRAZIONE / ILLUSTRATION	NOSTRO RIFERIMENTO OUR REFERENCE	RIFERIMENTO COSTRUTTORE O.E. REFERENCE
<p>Impianto / System SIRMAC</p>  <p>Assale posteriore Rear Axle</p> <p>Cilindretto/Cylinder Rif. 4712856 Ø 23.8 mm.</p>	963110 (1)	4815279
	963111 (2)	4815280
DESCRIZIONE / DESCRIPTION		
<p>(1) Massa frenante posteriore SX Ø 325 x 100 x 12 Rear wheel brake LH Ø 325 x 100 x 12</p> <p>(2) Massa frenante anteriore e posteriore DX Ø 325 x 100 x 12 Front and rear wheel brake RH Ø 325 x 100 x 12</p>		
ILLUSTRAZIONE / ILLUSTRATION	NOSTRO RIFERIMENTO OUR REFERENCE	RIFERIMENTO COSTRUTTORE O.E. REFERENCE
<p>Impianto / System SIRMAC</p>  <p>Ø 325 x 100 mm.</p>	963616	-
	DESCRIZIONE / DESCRIPTION	
<p>Serie ganasce freno posteriori con leve freno a mano (per massa freno ns.riferimento 963110-963111)</p> <p>Brake shoes set rear with levers for hand brake (for wheel brake our ref. 963110-963111)</p>		

TIPO DI VEICOLO / VEHICLE TYPE

Zeta 79.14
TurboZeta 79.12

ILLUSTRAZIONE / ILLUSTRATION

Impianto / System **SIRMAC**



Assale posteriore
Rear Axle

NOSTRO RIFERIMENTO OUR REFERENCE

965030 (1)

965031 (2)

RIFERIMENTO COSTRUTTORE O.E. REFERENCE

4819657-4819665-7165619

4819658-4819666-7165620

DESCRIZIONE / DESCRIPTION

(1) Massa frenante posteriore SX
Ø 325 x 120 x 12 mm.
Rear wheel brake LH
Ø 325 x 120 x 12 mm.

(2) Massa frenante posteriore DX
Ø 325 x 120 x 12 mm.
Rear wheel brake RH
Ø 325 x 120 x 12 mm.

ILLUSTRAZIONE / ILLUSTRATION

Impianto / System **SIRMAC**



Ø 325 x 120 mm.

NOSTRO RIFERIMENTO OUR REFERENCE

963617

RIFERIMENTO COSTRUTTORE O.E. REFERENCE

-



DESCRIZIONE / DESCRIPTION

Serie ganasce freno posteriori
con leve freno a mano
(per massa freno ns.riferimento 965030-965031)

Brake shoes set with levers for
hand brake(for wheel brake our ref. 965030-965031)

TIPO DI VEICOLO / VEHICLE TYPE

115.14/17 - 135.14/17 - 145.17

ILLUSTRAZIONE / ILLUSTRATION	NOSTRO RIFERIMENTO OUR REFERENCE	RIFERIMENTO COSTRUTTORE O.E. REFERENCE
 <p>Assale anteriore Front Axle</p>	963549 (1)	1908484 (10360097)
	963550 (2)	1908485 (10360098)
DESCRIZIONE / DESCRIPTION		
<p>(1) Massa frenante completa sinistra Ø 365 x 190 mm. Complete wheel brake left Ø 365 x 190 mm.</p> <p>(2) Massa frenante completa destra Ø 365 x 190 mm. Complete wheel brake right Ø 365 x 190 mm.</p>		
ILLUSTRAZIONE / ILLUSTRATION	NOSTRO RIFERIMENTO OUR REFERENCE	RIFERIMENTO COSTRUTTORE O.E. REFERENCE
 <p>Impianto / System PERROT</p>	961056	-
	DESCRIZIONE / DESCRIPTION	
<p>Ganascia nuda Shoe without lining</p>		
ILLUSTRAZIONE / ILLUSTRATION	NOSTRO RIFERIMENTO OUR REFERENCE	RIFERIMENTO COSTRUTTORE O.E. REFERENCE
	961008	1906128 (12999347VT)
	DESCRIZIONE / DESCRIPTION	
<p>Serie ganasce freno Brake shoes set</p>		

TIPO DI VEICOLO / VEHICLE TYPE

115.14/17 - 135.14/17 - 145.17

ILLUSTRAZIONE / ILLUSTRATION

Impianto / System **PERROT**



NOSTRO RIFERIMENTO OUR REFERENCE

963622

RIFERIMENTO COSTRUTTORE O.E. REFERENCE

93161268
(12999403VT)

DESCRIZIONE / DESCRIPTION

Kit riparazione freni
(Per massa freno rif.963900-963901)
Brake repairing kit
(For wheel brake ref.963900-963901)

ILLUSTRAZIONE / ILLUSTRATION

Impianto / System **PERROT**



NOSTRO RIFERIMENTO OUR REFERENCE

963019

RIFERIMENTO COSTRUTTORE O.E. REFERENCE

93161254
(12999418VT)

DESCRIZIONE / DESCRIPTION

Kit cilindretto freno PERROT
Brake cylinder kit PERROT

ILLUSTRAZIONE / ILLUSTRATION

Impianto / System **PERROT**



NOSTRO RIFERIMENTO OUR REFERENCE

963599

RIFERIMENTO COSTRUTTORE O.E. REFERENCE

93161257
(12999404)

DESCRIZIONE / DESCRIPTION

Kit cuffie per cilindro freno PERROT
Protective hoods set for brake cylinder PERROT



TIPO DI VEICOLO / VEHICLE TYPE

115.14/17 - 135.14/17 - 145.17

ILLUSTRAZIONE / ILLUSTRATION	NOSTRO RIFERIMENTO OUR REFERENCE	RIFERIMENTO COSTRUTTORE O.E. REFERENCE
<p>Impianto / System PERROT</p> 	963554	93161267 (12999402VT)
DESCRIZIONE / DESCRIPTION		
<p>Kit cunei Brake wedees kit</p>		
ILLUSTRAZIONE / ILLUSTRATION	NOSTRO RIFERIMENTO OUR REFERENCE	RIFERIMENTO COSTRUTTORE O.E. REFERENCE
<p>Impianto / System PERROT</p> 	964215	9987624 (13730103)
DESCRIZIONE / DESCRIPTION		
<p>Registro freno nudo Bare brake adjuster</p>		
ILLUSTRAZIONE / ILLUSTRATION	NOSTRO RIFERIMENTO OUR REFERENCE	RIFERIMENTO COSTRUTTORE O.E. REFERENCE
<p>Impianto / System PERROT</p> 	964219	-
DESCRIZIONE / DESCRIPTION		
<p>Registro freno completo Complete brake adjuster</p>		



TIPO DI VEICOLO / VEHICLE TYPE

115.14/17 - 135.14/17 - 145.17

ILLUSTRAZIONE / ILLUSTRATION	NOSTRO RIFERIMENTO OUR REFERENCE	RIFERIMENTO COSTRUTTORE O.E. REFERENCE
<p>Impianto / System PERROT</p> 	964218	42488219 (13304019)
DESCRIZIONE / DESCRIPTION		
<p>Molletta Spring</p>		
ILLUSTRAZIONE / ILLUSTRATION	NOSTRO RIFERIMENTO OUR REFERENCE	RIFERIMENTO COSTRUTTORE O.E. REFERENCE
<p>Impianto / System PERROT</p> 	964221	42488213
DESCRIZIONE / DESCRIPTION		
<p>Nottolino Dowel pawl</p>		
ILLUSTRAZIONE / ILLUSTRATION	NOSTRO RIFERIMENTO OUR REFERENCE	RIFERIMENTO COSTRUTTORE O.E. REFERENCE
<p>Impianto / System PERROT</p> 	963021	8124814 (12999134VT)
DESCRIZIONE / DESCRIPTION		
<p>Kit cunei comando freni Brake adjuster wedges kit</p>		

TIPO DI VEICOLO / VEHICLE TYPE

115.14/17 - 135.14/17 - 145.17

ILLUSTRAZIONE / ILLUSTRATION	NOSTRO RIFERIMENTO OUR REFERENCE	RIFERIMENTO COSTRUTTORE O.E. REFERENCE
<p>Impianto / System PERROT</p> 	963003	8124815 (12999135VT)
DESCRIZIONE / DESCRIPTION		
Kit revisione boccole dentate Thooted bushing overhaul kit		
ILLUSTRAZIONE / ILLUSTRATION	NOSTRO RIFERIMENTO OUR REFERENCE	RIFERIMENTO COSTRUTTORE O.E. REFERENCE
<p>Impianto / System PERROT</p> 	963002	8124031 (12999011VT)
DESCRIZIONE / DESCRIPTION		
Kit cuffie Protective hoods set		
ILLUSTRAZIONE / ILLUSTRATION	NOSTRO RIFERIMENTO OUR REFERENCE	RIFERIMENTO COSTRUTTORE O.E. REFERENCE
DESCRIZIONE / DESCRIPTION		

TIPO DI VEICOLO / VEHICLE TYPE

EUROCARGO

EUROCARGO TECTOR

120E15/E18/E23

130E15/E18/E23/E24/E28

150E15/E18/E23/E24/E28/E27

170E15/E18/E23

180E27 - 320E27

ILLUSTRAZIONE / ILLUSTRATION

NOSTRO RIFERIMENTO
OUR REFERENCE

RIFERIMENTO COSTRUTTORE
O.E. REFERENCE

Impianto / System **ROCKWELL**

963907 (1)

98464849 (R115705219)



963908 (2)

98464850 (R115705220)

DESCRIZIONE / DESCRIPTION

(1) Massa frenante completa posteriore sinistra
Ø 381x178
Complete left rear wheel brake LH
Ø 381x178

(2) Massa frenante completa posteriore destra
Ø 381x178
Complete right rear wheel brake RH
Ø 381x178

Assale anteriore - Front axle

ILLUSTRAZIONE / ILLUSTRATION

NOSTRO RIFERIMENTO
OUR REFERENCE

RIFERIMENTO COSTRUTTORE
O.E. REFERENCE

Impianto / System **PERROT**

963900 (1)

500381595 (10360105)

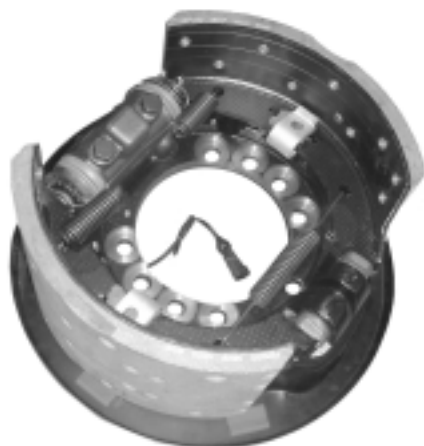

963901 (2)

500381596 (10360106)

DESCRIZIONE / DESCRIPTION

(1) Massa frenante completa posteriore sinistra
Ø 360x170
Complete left rear wheel brake LH
Ø 360x170

(2) Massa frenante completa posteriore destra
Ø 360x170
Complete right rear wheel brake RH
Ø 360x170

Assale posteriore - Rear axle

TIPO DI VEICOLO / VEHICLE TYPE

EUROCARGO**EUROCARGO TECTOR**

120E15/E18/E23

130E15/E18/E23/E24/E28

150E15/E18/E23/E24/E28/E27

170E15/E18/E23

180E27 - 320E27

ILLUSTRAZIONE / ILLUSTRATION

NOSTRO RIFERIMENTO
OUR REFERENCE**963005**RIFERIMENTO COSTRUTTORE
O.E. REFERENCE**42480059**
(A2297L3158)

DESCRIZIONE / DESCRIPTION

Registro freno
Brake adjuster

ILLUSTRAZIONE / ILLUSTRATION

NOSTRO RIFERIMENTO
OUR REFERENCE**963006**RIFERIMENTO COSTRUTTORE
O.E. REFERENCE**42480058**
(3280Y8463)

DESCRIZIONE / DESCRIPTION

Boccola zigrinata
Knurled bushing

ILLUSTRAZIONE / ILLUSTRATION

NOSTRO RIFERIMENTO
OUR REFERENCE**963007**RIFERIMENTO COSTRUTTORE
O.E. REFERENCE**42480060**

DESCRIZIONE / DESCRIPTION

Astuccio
Holder

TIPO DI VEICOLO / VEHICLE TYPE

EUROCARGO
EUROCARGO TECTOR
120E15/E18/E23
130E15/E18/E23/E24/E28
150E15/E18/E23/E24/E28/E27
170E15/E18/E23
180E27 - 320E27

ILLUSTRAZIONE / ILLUSTRATION



NOSTRO RIFERIMENTO
OUR REFERENCE

963001

RIFERIMENTO COSTRUTTORE
O.E. REFERENCE

42491950
(RBSK 0502)

DESCRIZIONE / DESCRIPTION

*Kit riparazione freno
Brake repairing kit*

ILLUSTRAZIONE / ILLUSTRATION



NOSTRO RIFERIMENTO
OUR REFERENCE

963024

RIFERIMENTO COSTRUTTORE
O.E. REFERENCE

7980407
(RBSK 0250)

DESCRIZIONE / DESCRIPTION

*Kit cunei freno
Brake wedges kit*

ILLUSTRAZIONE / ILLUSTRATION



NOSTRO RIFERIMENTO
OUR REFERENCE

963547

RIFERIMENTO COSTRUTTORE
O.E. REFERENCE

93161353

DESCRIZIONE / DESCRIPTION

*Kit cunei freno
Brake wedges kit*

TIPO DI VEICOLO / VEHICLE TYPE

EUROCARGO**EUROCARGO TECTOR**

120E15/E18/E23

130E15/E18/E23/E24/E28

150E15/E18/E23/E24/E28/E27

170E15/E18/E23

180E27 - 320E27

ILLUSTRAZIONE / ILLUSTRATION

NOSTRO RIFERIMENTO
OUR REFERENCE**963023**RIFERIMENTO COSTRUTTORE
O.E. REFERENCE**7980406**
(RBSK 0249)

DESCRIZIONE / DESCRIPTION

*Kit stantuffi dx
Brake piston kit right*

ILLUSTRAZIONE / ILLUSTRATION

NOSTRO RIFERIMENTO
OUR REFERENCE**963022**RIFERIMENTO COSTRUTTORE
O.E. REFERENCE**7980405**
(RBSK 0248)

DESCRIZIONE / DESCRIPTION

*Kit stantuffi sx
Brake piston kit left*

ILLUSTRAZIONE / ILLUSTRATION

NOSTRO RIFERIMENTO
OUR REFERENCE**963025**RIFERIMENTO COSTRUTTORE
O.E. REFERENCE**7980408**
(RBSK 0251)

DESCRIZIONE / DESCRIPTION

*Kit cuffie
Protective hoods set*

TIPO DI VEICOLO / VEHICLE TYPE

EUROCARGO
EUROCARGO TECTOR
 120E15/E18/E23
 130E15/E18/E23/E24/E28
 150E15/E18/E23/E24/E28/E27
 170E15/E18/E23
 180E27 - 320E27

ILLUSTRAZIONE / ILLUSTRATION



NOSTRO RIFERIMENTO OUR REFERENCE

963026

RIFERIMENTO COSTRUTTORE O.E. REFERENCE

7980687
(RBSK 0343)

DESCRIZIONE / DESCRIPTION

*Kit molle ritegno ganasce
Shoes springs kit*

ILLUSTRAZIONE / ILLUSTRATION



NOSTRO RIFERIMENTO OUR REFERENCE

963020

RIFERIMENTO COSTRUTTORE O.E. REFERENCE

42491974
(RBSK 0549)

DESCRIZIONE / DESCRIPTION

*Kit ridotto freno
Brake reduced kit*

ILLUSTRAZIONE / ILLUSTRATION



NOSTRO RIFERIMENTO OUR REFERENCE

963013

RIFERIMENTO COSTRUTTORE O.E. REFERENCE



41817599
(RBSK 0253)

DESCRIZIONE / DESCRIPTION

*Tubetto di grasso
Grease*

TIPO DI VEICOLO / VEHICLE TYPE

EUROCARGO
EUROCARGO TECTOR
 120E15/E18/E23
 130E15/E18/E23/E24/E28
 150E15/E18/E23/E24/E28/E27
 170E15/E18/E23
 180E27 - 320E27

ILLUSTRAZIONE / ILLUSTRATION	NOSTRO RIFERIMENTO OUR REFERENCE	RIFERIMENTO COSTRUTTORE O.E. REFERENCE
	963010	42480056 (2258H580)
Molla freno Brake Spring		
ILLUSTRAZIONE / ILLUSTRATION	NOSTRO RIFERIMENTO OUR REFERENCE	RIFERIMENTO COSTRUTTORE O.E. REFERENCE
	963011	42488736 (1205B1666)
Cuffia alta High protective hood		
ILLUSTRAZIONE / ILLUSTRATION	NOSTRO RIFERIMENTO OUR REFERENCE	RIFERIMENTO COSTRUTTORE O.E. REFERENCE
	963012	42488737 (1205B1666)
Cuffia bassa Low protective hood		

TIPO DI VEICOLO / VEHICLE TYPE

EUROCARGO TECTOR

ILLUSTRAZIONE / ILLUSTRATION

Impianto / System **PERROT**

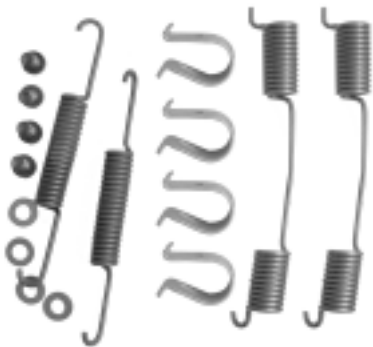

NOSTRO RIFERIMENTO
OUR REFERENCE

961043

RIFERIMENTO COSTRUTTORE
O.E. REFERENCE

93161954
(12999623VT)

DESCRIZIONE / DESCRIPTION

Kit molle freno
Brake springs set

EUROCARGO TECTOR
115 - 135

ILLUSTRAZIONE / ILLUSTRATION



NOSTRO RIFERIMENTO
OUR REFERENCE

960951

RIFERIMENTO COSTRUTTORE
O.E. REFERENCE

42538063

DESCRIZIONE / DESCRIPTION

Kit molle freno
Brake springs set

EUROCARGO
120E15/E18/E23 - 130E15/E18/E24
150E23 - 170E15/E23
260E23

ILLUSTRAZIONE / ILLUSTRATION



NOSTRO RIFERIMENTO
OUR REFERENCE

960965

RIFERIMENTO COSTRUTTORE
O.E. REFERENCE

42538064

DESCRIZIONE / DESCRIPTION

Kit molle fissaggio ganasce
Fixing shoes springs kit

EUROCARGO TECTOR
120 - 150

TIPO DI VEICOLO / VEHICLE TYPE

EUROCARGO TECTOR

ILLUSTRAZIONE / ILLUSTRATION	NOSTRO RIFERIMENTO OUR REFERENCE	RIFERIMENTO COSTRUTTORE O.E. REFERENCE
	960511	42537942
DESCRIZIONE / DESCRIPTION		
<p><i>Kit cunei freno</i> <i>Brake wedges kit</i></p> <p>EUROCARGO 120 - 130 - 150 - 170E15/E18/E23</p>		
ILLUSTRAZIONE / ILLUSTRATION	NOSTRO RIFERIMENTO OUR REFERENCE	RIFERIMENTO COSTRUTTORE O.E. REFERENCE
	960603	42538066
DESCRIZIONE / DESCRIPTION		
<p><i>Kit revisione freni</i> <i>Brake overhaul kit</i></p> <p>EUROCARGO 120 - 130 - 150 - 170E15/E18/E23</p>		
ILLUSTRAZIONE / ILLUSTRATION	NOSTRO RIFERIMENTO OUR REFERENCE	RIFERIMENTO COSTRUTTORE O.E. REFERENCE
	960601	42538062
DESCRIZIONE / DESCRIPTION		
<p><i>Kit revisione freni (perni fissi)</i> <i>Brake overhaul kit (pins)</i></p> <p>EUROCARGO 120 - 130 - 150 - 170E15/E18/E23</p>		

TIPO DI VEICOLO / VEHICLE TYPE

EUROCARGO TECTOR

ILLUSTRAZIONE / ILLUSTRATION



NOSTRO RIFERIMENTO
OUR REFERENCE

963027

RIFERIMENTO COSTRUTTORE
O.E. REFERENCE

42536176

DESCRIZIONE / DESCRIPTION

Cuffia bassa freno
Low protective hood

ILLUSTRAZIONE / ILLUSTRATION

NOSTRO RIFERIMENTO
OUR REFERENCE

RIFERIMENTO COSTRUTTORE
O.E. REFERENCE

DESCRIZIONE / DESCRIPTION

ILLUSTRAZIONE / ILLUSTRATION

NOSTRO RIFERIMENTO
OUR REFERENCE

RIFERIMENTO COSTRUTTORE
O.E. REFERENCE

DESCRIZIONE / DESCRIPTION

TIPO DI VEICOLO / VEHICLE TYPE

EUROCARGO**EUROCARGO TECTOR**



120E15/E18/E23

130E15/E18/E23/E24/E28

150E15/E18/E23/E24/E28/E27



170E15/E18/E23

180E27 - 320E27

ILLUSTRAZIONE / ILLUSTRATION	NOSTRO RIFERIMENTO OUR REFERENCE	RIFERIMENTO COSTRUTTORE O.E. REFERENCE
	963017	42480062 (A2247U47)
	DESCRIZIONE / DESCRIPTION Dispositivo a cuneo Device	
ILLUSTRAZIONE / ILLUSTRATION	NOSTRO RIFERIMENTO OUR REFERENCE	RIFERIMENTO COSTRUTTORE O.E. REFERENCE
	963014	7984216 (2297K4821)
	963015	7984217 (2297J4820)
DESCRIZIONE / DESCRIPTION Stantuffo dx Plunger right Stantuffo sx Plunger left		
ILLUSTRAZIONE / ILLUSTRATION	NOSTRO RIFERIMENTO OUR REFERENCE	RIFERIMENTO COSTRUTTORE O.E. REFERENCE
	963016	42488484
	DESCRIZIONE / DESCRIPTION Molla Spring	

TIPO DI VEICOLO / VEHICLE TYPE

EUROCARGO
EUROCARGO TECTOR
120E15/E18/E23
130E15/E18/E23/E24/E28
150E15/E18/E23/E24/E28/E27
170E15/E18/E23
180E27 - 320E27

ILLUSTRAZIONE / ILLUSTRATION	NOSTRO RIFERIMENTO OUR REFERENCE	RIFERIMENTO COSTRUTTORE O.E. REFERENCE
<p><i>Impianto / System</i> PERROT</p>  <p><i>Per massa Rif.</i> 963900 - 963901 <i>For wheel brake ref.</i> 963900 - 963901</p>	963526	1906361 (12999469VT)
DESCRIZIONE / DESCRIPTION		
<p><i>Serie ganasce freno posteriori</i> <i>(h.170 mm. e ceppo spessore 6 mm.)</i> <i>Rear brake shoes set (H 170 mm.) and lining 6 mm.</i> <i>thickness</i></p>		
ILLUSTRAZIONE / ILLUSTRATION	NOSTRO RIFERIMENTO OUR REFERENCE	RIFERIMENTO COSTRUTTORE O.E. REFERENCE
<p><i>Impianto / System</i> MERITOR</p>  <p><i>Per massa Rif.</i> 963905 - 963906 <i>For wheel brake ref.</i> 963905 - 963906</p>	963614	2992530
DESCRIZIONE / DESCRIPTION		
<p><i>Serie ganasce freno posteriori</i> <i>Rear brake shoes set</i></p>		
ILLUSTRAZIONE / ILLUSTRATION	NOSTRO RIFERIMENTO OUR REFERENCE	RIFERIMENTO COSTRUTTORE O.E. REFERENCE
<p><i>Impianto / System</i> ROCKWELL</p>  <p><i>Per massa Rif.</i> 963907 - 963908 <i>For wheel brake ref.</i> 963907 - 963908</p>	963545	1906354
DESCRIZIONE / DESCRIPTION		
<p><i>Serie ganasce freno posteriori</i> <i>Rear brake shoes set</i></p>		

TIPO DI VEICOLO / VEHICLE TYPE

EUROCARGO**EUROCARGO TECTOR**

120E15/E18/E23

130E15/E18/E23/E24/E28

150E15/E18/E23/E24/E28/E27

170E15/E18/E23

180E27 - 320E27

ILLUSTRAZIONE / ILLUSTRATION

Impianto / System **PERROT**NOSTRO RIFERIMENTO
OUR REFERENCE**963622**RIFERIMENTO COSTRUTTORE
O.E. REFERENCE**93161268**

(12999403VT)

DESCRIZIONE / DESCRIPTION

Kit riparazione freni
(Per massa freno rif.963900-963901)
Brake repairing kit
(For wheel brake ref.963900-963901)

ILLUSTRAZIONE / ILLUSTRATION

Impianto / System **PERROT**NOSTRO RIFERIMENTO
OUR REFERENCE**963019**RIFERIMENTO COSTRUTTORE
O.E. REFERENCE**93161254**

(12999418VT)

DESCRIZIONE / DESCRIPTION

Kit cilindretto freno PERROT
Brake cylinder kit PERROT

ILLUSTRAZIONE / ILLUSTRATION

Impianto / System **PERROT**NOSTRO RIFERIMENTO
OUR REFERENCE**963599**RIFERIMENTO COSTRUTTORE
O.E. REFERENCE**93161257**

(12999404)

DESCRIZIONE / DESCRIPTION

Kit cuffie per cilindro freno PERROT
Protective hoods set for brake cylinder PERROT

TIPO DI VEICOLO / VEHICLE TYPE

EUROCARGO
EUROCARGO TECTOR
120E15/E18/E23
130E15/E18/E23/E24/E28
150E15/E18/E23/E24/E28/E27
170E15/E18/E23
180E27 - 320E27

ILLUSTRAZIONE / ILLUSTRATION

Impianto / System **PERROT**



NOSTRO RIFERIMENTO
OUR REFERENCE

963554

RIFERIMENTO COSTRUTTORE
O.E. REFERENCE

93161267

(12999402VT)

DESCRIZIONE / DESCRIPTION

Kit cunei freno
Brake wedges kit

ILLUSTRAZIONE / ILLUSTRATION

NOSTRO RIFERIMENTO
OUR REFERENCE

RIFERIMENTO COSTRUTTORE
O.E. REFERENCE

DESCRIZIONE / DESCRIPTION

ILLUSTRAZIONE / ILLUSTRATION

NOSTRO RIFERIMENTO
OUR REFERENCE

RIFERIMENTO COSTRUTTORE
O.E. REFERENCE

DESCRIZIONE / DESCRIPTION

TIPO DI VEICOLO / VEHICLE TYPE

175.17/24

Turbostar

190.36/42/48 - 240.36/48 - 260.48

Turbotech

190.30/32/36 - 220/240/260.36

ILLUSTRAZIONE / ILLUSTRATION

NOSTRO RIFERIMENTO
OUR REFERENCERIFERIMENTO COSTRUTTORE
O.E. REFERENCEImpianto / System **ROCKWELL****963069****42101963**
(RD15705153)

DESCRIZIONE / DESCRIPTION

Massa frenante completa sinistra
 Ø 381 x 180 mm.
 Complete wheel brake left
 Ø 381 x 180 mm.



Assale posteriore
Rear Axle

ILLUSTRAZIONE / ILLUSTRATION

NOSTRO RIFERIMENTO
OUR REFERENCERIFERIMENTO COSTRUTTORE
O.E. REFERENCEImpianto / System **ROCKWELL****963068****42101964**
(RD15705154)

DESCRIZIONE / DESCRIPTION

Massa frenante completa destra
 Ø 381 x 180 mm.
 Complete wheel brake right
 Ø 381 x 180 mm.

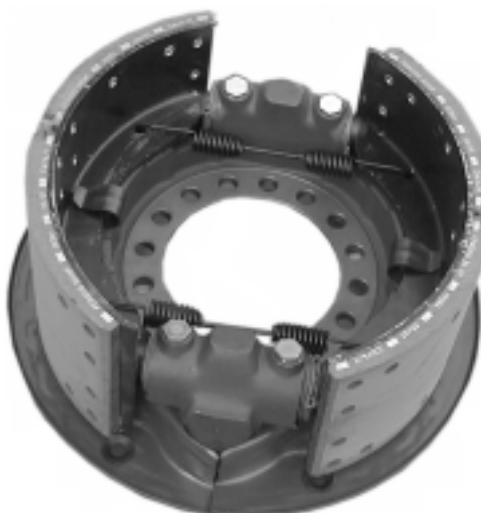

Assale posteriore
Rear Axle

TIPO DI VEICOLO / VEHICLE TYPE

175.17/24

Turbostar

190.36/42/48 - 240.36/48 - 260.48

Turbotech

190.30/32/36 - 220/240/260.36

ILLUSTRAZIONE / ILLUSTRATION



NOSTRO RIFERIMENTO
OUR REFERENCE

961055

RIFERIMENTO COSTRUTTORE
O.E. REFERENCE

-

DESCRIZIONE / DESCRIPTION

Ganascia nuda
Shoe without lining

ILLUSTRAZIONE / ILLUSTRATION

Impianto / System **ROCKWELL**



(RBSK 1212)
Ø 381 mm x H 178 mm.

NOSTRO RIFERIMENTO
OUR REFERENCE

961013

RIFERIMENTO COSTRUTTORE
O.E. REFERENCE

1906032

DESCRIZIONE / DESCRIPTION

Serie ganasce freno posteriori
Ø 381 X 178 mm.
Rear brake shoe set
Ø 381 X 178 mm.

ILLUSTRAZIONE / ILLUSTRATION

Impianto / System **ROCKWELL**



NOSTRO RIFERIMENTO
OUR REFERENCE

960559 (1)

RIFERIMENTO COSTRUTTORE
O.E. REFERENCE

1906033 (RBSK1213)

960560 (2)

1906034 (RBSK1214)

DESCRIZIONE / DESCRIPTION

- (1) Serie ganasce freno posteriori (**maggiorate 10/10**)
Ø 381 X 178 mm.
Rear brake shoes set (+ 10/10) Ø 381 X 178 mm.
- (2) Serie ganasce freno posteriori (**maggiorate 20/10**)
Ø 381 X 178 mm.
Rear brake shoes set (+ 20/10) Ø 381 X 178 mm.

TIPO DI VEICOLO / VEHICLE TYPE

175.17/24

Turbostar

190.36/42/48 - 240.36/48 - 260.48

Turbotech

190.30/32/36 - 220/240/260.36

ILLUSTRAZIONE / ILLUSTRATION

NOSTRO RIFERIMENTO
OUR REFERENCE**963106**RIFERIMENTO COSTRUTTORE
O.E. REFERENCE**42480411**
(3211J3026)

DESCRIZIONE / DESCRIPTION

Supporto massa frenante nudo
Brake wheel support

ILLUSTRAZIONE / ILLUSTRATION

NOSTRO RIFERIMENTO
OUR REFERENCE**963005**RIFERIMENTO COSTRUTTORE
O.E. REFERENCE**42480059**
(A2297L3158)

DESCRIZIONE / DESCRIPTION

Registro freno
Brake adjuster

ILLUSTRAZIONE / ILLUSTRATION

NOSTRO RIFERIMENTO
OUR REFERENCE**963006**RIFERIMENTO COSTRUTTORE
O.E. REFERENCE**42480058**
(3280Y8463)

DESCRIZIONE / DESCRIPTION

Boccola zigrinata
Knurled bushing

TIPO DI VEICOLO / VEHICLE TYPE

175.17/24

Turbostar

190.36/42/48 - 240.36/48 - 260.48

Turbotech

190.30/32/36 - 220/240/260.36

ILLUSTRAZIONE / ILLUSTRATION



NOSTRO RIFERIMENTO
OUR REFERENCE

963007

RIFERIMENTO COSTRUTTORE
O.E. REFERENCE

42480060

DESCRIZIONE / DESCRIPTION

Astuccio
Holder

ILLUSTRAZIONE / ILLUSTRATION



NOSTRO RIFERIMENTO
OUR REFERENCE

963001

RIFERIMENTO COSTRUTTORE
O.E. REFERENCE

42491950
(RBSK 0502)

DESCRIZIONE / DESCRIPTION

Kit riparazione freni
Brake repairing kit

ILLUSTRAZIONE / ILLUSTRATION



NOSTRO RIFERIMENTO
OUR REFERENCE

963024

RIFERIMENTO COSTRUTTORE
O.E. REFERENCE

7980407
(RBSK 0250)

DESCRIZIONE / DESCRIPTION

Kit cunei freni
Brake wedges kit

TIPO DI VEICOLO / VEHICLE TYPE

175.17/24

Turbostar

190.36/42/48 - 240.36/48 - 260.48

Turbotech

190.30/32/36 - 220/240/260.36

ILLUSTRAZIONE / ILLUSTRATION	NOSTRO RIFERIMENTO OUR REFERENCE	RIFERIMENTO COSTRUTTORE O.E. REFERENCE
	963547	93161353
DESCRIZIONE / DESCRIPTION		
<i>Kit cunei freno Brake wedges kit</i>		
ILLUSTRAZIONE / ILLUSTRATION	NOSTRO RIFERIMENTO OUR REFERENCE	RIFERIMENTO COSTRUTTORE O.E. REFERENCE
	963023	7980406 (RBSK 0249)
DESCRIZIONE / DESCRIPTION		
<i>Kit stantuffi dx Brake piston kit right</i>		
ILLUSTRAZIONE / ILLUSTRATION	NOSTRO RIFERIMENTO OUR REFERENCE	RIFERIMENTO COSTRUTTORE O.E. REFERENCE
	963022	7980405 (RBSK 0248)
DESCRIZIONE / DESCRIPTION		
<i>Kit stantuffi sx Brake piston kit left</i>		

TIPO DI VEICOLO / VEHICLE TYPE

175.17/24

Turbostar

190.36/42/48 - 240.36/48 - 260.48

Turbotech

190.30/32/36 - 220/240/260.36

ILLUSTRAZIONE / ILLUSTRATION



NOSTRO RIFERIMENTO
OUR REFERENCE

963025

RIFERIMENTO COSTRUTTORE
O.E. REFERENCE

7980408
(RBSK 0251)

DESCRIZIONE / DESCRIPTION

Kit cuffie
Protective hoods set

ILLUSTRAZIONE / ILLUSTRATION



NOSTRO RIFERIMENTO
OUR REFERENCE

963026

RIFERIMENTO COSTRUTTORE
O.E. REFERENCE

7980687
(RBSK 0343)

DESCRIZIONE / DESCRIPTION

Kit molle ritegno ganasce
Shoes springs kit

ILLUSTRAZIONE / ILLUSTRATION



NOSTRO RIFERIMENTO
OUR REFERENCE

963020

RIFERIMENTO COSTRUTTORE
O.E. REFERENCE

42491974
(RBSK 0549)

DESCRIZIONE / DESCRIPTION

Kit ridotto freno
Brake reduced kit

TIPO DI VEICOLO / VEHICLE TYPE

175.17/24

Turbostar

190.36/42/48 - 240.36/48 - 260.48

Turbotech

190.30/32/36 - 220/240/260.36

ILLUSTRAZIONE / ILLUSTRATION	NOSTRO RIFERIMENTO OUR REFERENCE	RIFERIMENTO COSTRUTTORE O.E. REFERENCE
	963013	41817599 (RBSK 0253)
Tubetto di grasso Grease		
ILLUSTRAZIONE / ILLUSTRATION	NOSTRO RIFERIMENTO OUR REFERENCE	RIFERIMENTO COSTRUTTORE O.E. REFERENCE
	963010	42480056 (2258H580)
Molla freni Brake Springs		
ILLUSTRAZIONE / ILLUSTRATION	NOSTRO RIFERIMENTO OUR REFERENCE	RIFERIMENTO COSTRUTTORE O.E. REFERENCE
	963011	42488736 (1205B1666)
Cuffia alta High protective hood		
ILLUSTRAZIONE / ILLUSTRATION	NOSTRO RIFERIMENTO OUR REFERENCE	RIFERIMENTO COSTRUTTORE O.E. REFERENCE
	963012	42488737 (1205B1666)
Cuffia bassa Low protective hood		

TIPO DI VEICOLO / VEHICLE TYPE



175.17/24

Turbostar

190.36/42/48 - 240.36/48 - 260.48



Turbotech

190.30/32/36 - 220/240/260.36

ILLUSTRAZIONE / ILLUSTRATION	NOSTRO RIFERIMENTO OUR REFERENCE	RIFERIMENTO COSTRUTTORE O.E. REFERENCE
	963017	42480062 (A2247U47)
	DESCRIZIONE / DESCRIPTION	
	<p><i>Dispositivo a cuneo</i> <i>Device</i></p>	
ILLUSTRAZIONE / ILLUSTRATION	NOSTRO RIFERIMENTO OUR REFERENCE	RIFERIMENTO COSTRUTTORE O.E. REFERENCE
	963014	7984216 (2297K4821)
	963015	7984217 (2297J4820)
	DESCRIZIONE / DESCRIPTION	
	<p><i>Stantuffo dx</i> <i>Plunger right</i></p> <p><i>Stantuffo sx</i> <i>Plunger left</i></p>	
ILLUSTRAZIONE / ILLUSTRATION	NOSTRO RIFERIMENTO OUR REFERENCE	RIFERIMENTO COSTRUTTORE O.E. REFERENCE
	963016	42488484
	DESCRIZIONE / DESCRIPTION	
	<p><i>Molla sostegno ganasce</i> <i>Spring brake shoes</i></p>	

TIPO DI VEICOLO / VEHICLE TYPE

EUROTECH 190E34/E38/E42 - 240E30/E34/E38/E42 - 260E42 - 440E34/E38/E42
EUROTECH CURSOR - 260E24/E31/E35/E39/E43
EUROTRAKKER - 190E30/E31/E34/E37/E42 - 260E30/E34/E37/E42/E47 - 330E34/E37
 340E34/E37/E42 - 380E31/E34/E37/E42 - 400E34/E37/E42 - 410E37/E42 - 440E34/E37/E42 -
 720E31/E37/E42
EUROSTAR 190E42/E47/E52 - 240E38/E42/E47/E52 - 260E47/E52 - 440E42/E47/E52
EUROSTAR CURSOR 260E39/E42/E48 - 440E39
STRALIS 260S40/S43/S48/S54 - 440S48/S54 - 330.30 - AP160

ILLUSTRAZIONE / ILLUSTRATION	NOSTRO RIFERIMENTO OUR REFERENCE	RIFERIMENTO COSTRUTTORE O.E. REFERENCE
<p><i>Impianto / System</i> ROCKWELL SIMPLEX</p>  <p>Assale anteriore Front Axle</p>	963457	41022771
	DESCRIZIONE / DESCRIPTION	
<p><i>Massa frenante completa sinistra</i> Ø 410x180 <i>Complete wheel brake left</i> Ø 410x180</p>		
ILLUSTRAZIONE / ILLUSTRATION	NOSTRO RIFERIMENTO OUR REFERENCE	RIFERIMENTO COSTRUTTORE O.E. REFERENCE
<p><i>Impianto / System</i> ROCKWELL SIMPLEX</p>  <p>Assale anteriore Front Axle</p>	963456	41022772
	DESCRIZIONE / DESCRIPTION	
<p><i>Massa frenante completa destra</i> Ø 410x180 <i>Complete wheel brake right</i> Ø 410x180</p>		

TIPO DI VEICOLO / VEHICLE TYPE

Eurotech 180E34/E38/E42 - 190E34/E38/E42 - 240E30/E34/E38/E42
400E34/E38/E42 - 440E34/E38/E42
Eurotech Cursor 190E24/E31/E35 -260E24/E31/E35-440E31/E35
Eurostar 180E42 - 190E38/E42/E47/E52 - 240E38/E42/E47/E52 - 400E38/E42/E47/E52
440 E38/E42/E47/E52
Eurotrakker 190E30/E31/E34/E37/E42 - 330E34/E37 - 340E34 - 380E31/E34/E37/E42
400E31/E34/E37/E42 - 410E37/E42-720E31/E37
Eurotrakker Cursor 190E31/E35 - 380/400/410E35 - 330.30 - AP160

ILLUSTRAZIONE / ILLUSTRATION	NOSTRO RIFERIMENTO OUR REFERENCE	RIFERIMENTO COSTRUTTORE O.E. REFERENCE
<p data-bbox="118 667 577 743">Impianto / System ROCKWELL (SIMPLEX)</p>  <p data-bbox="213 1245 481 1317">Assale posteriore Rear Axle</p>	<p data-bbox="769 676 922 721">963551</p>	<p data-bbox="1190 676 1401 721">41022773 (RS41020307)</p>
DESCRIZIONE / DESCRIPTION		
<p data-bbox="644 842 1120 990"><i>Massa frenante completa sinistra</i> Ø 410 x 200 mm. <i>Complete wheel brake left</i> Ø 410 x 200 mm.</p>		
ILLUSTRAZIONE / ILLUSTRATION	NOSTRO RIFERIMENTO OUR REFERENCE	RIFERIMENTO COSTRUTTORE O.E. REFERENCE
<p data-bbox="118 1456 577 1532">Impianto / System ROCKWELL (SIMPLEX)</p>  <p data-bbox="213 2065 481 2136">Assale posteriore Rear Axle</p>	<p data-bbox="769 1464 922 1509">963552</p>	<p data-bbox="1190 1464 1401 1509">41022774 (RS41020308)</p>
DESCRIZIONE / DESCRIPTION		
<p data-bbox="644 1630 1104 1778"><i>Massa frenante completa destra</i> Ø 410 x 200 mm. <i>Complete wheel brake right</i> Ø 410 x 200 mm.</p>		

TIPO DI VEICOLO / VEHICLE TYPE



Eurotech 180E34/E38/E42 - 190E34/E38/E42 - 240E30/E34/E38/E42
400E34/E38/E42 - 440E34/E38/E42

Eurotech Cursor 190E24/E31/E35 - 260E24/E31/E35 - 440E31/E35

Eurostar 180E42 - 190E38/E42/E47/E52 - 240E38/E42/E47/E52 - 400E38/E42/E47/E52
440 E38/E42/E47/E52

Eurotrakker 190E30/E31/E34/E37/E42 - 330E34/E37 - 340E34 - 380E31/E34/E37/E42
400E31/E34/E37/E42 - 410E37/E42 - 720E31/E37

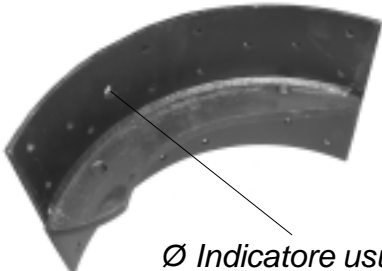
Eurotrakker Cursor 190E31/E35 - 380/400/410E35 - 330.30 - AP160

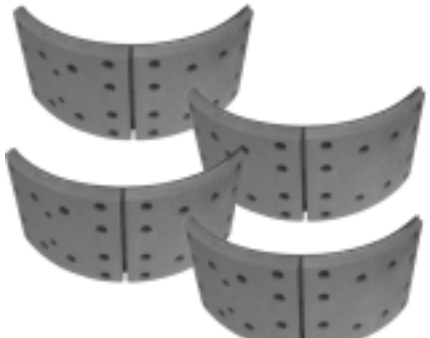
ILLUSTRAZIONE / ILLUSTRATION	NOSTRO RIFERIMENTO OUR REFERENCE	RIFERIMENTO COSTRUTTORE O.E. REFERENCE
<p>Impianto / System ROCKWELL</p>  <p>Ø Indicatore usura Ø Wear indicator</p> <p>Ø 410 x 200 mm.</p>	963520	-
DESCRIZIONE / DESCRIPTION		
<p>Ganascia nuda freno posteriore con fori indicatori usura Rear brake shoe without lining with holes for wear indicator</p>		
ILLUSTRAZIONE / ILLUSTRATION	NOSTRO RIFERIMENTO OUR REFERENCE	RIFERIMENTO COSTRUTTORE O.E. REFERENCE
<p>Impianto / System ROCKWELL</p>  <p>Ø 410 x 200 mm.</p>	963521	-
DESCRIZIONE / DESCRIPTION		
<p>Ganascia nuda freno posteriore senza fori indicatori usura Rear brake shoe without lining without holes for wear indicator</p>		
ILLUSTRAZIONE / ILLUSTRATION	NOSTRO RIFERIMENTO OUR REFERENCE	RIFERIMENTO COSTRUTTORE O.E. REFERENCE
<p>Impianto / System ROCKWELL</p>  <p>(RBSK 1496)</p>	963529	1906404
DESCRIZIONE / DESCRIPTION		
<p>Serie ganasce freno anteriori Ø 410 X 180 mm. Front brake shoes set Ø 410 X 180 mm.</p>		

TIPO DI VEICOLO / VEHICLE TYPE

Eurotech 180E34/E38/E42 - 190E34/E38/E42 - 240E30/E34/E38/E42
400E34/E38/E42 - 440E34/E38/E42

Eurotech Cursor 190E24/E31/E35 - 260E24/E31/E35-440E31/E35

Eurostar 180E42 - 190E38/E42/E47/E52 - 240E38/E42/E47/E52 - 400E38/E42/E47/E52
440 E38/E42/E47/E52

Eurotrakker 190E30/E31/E34/E37/E42 - 330E34/E37 - 340E34 - 380E31/E34/E37/E42
400E31/E34/E37/E42 - 410E37/E42-720E31/E37

Eurotrakker Cursor 190E31/E35 - 380/400/410E35 - 330.30 - AP160

ILLUSTRAZIONE / ILLUSTRATION

Impianto / System **ROCKWELL**



(RBSK 1493)

NOSTRO RIFERIMENTO OUR REFERENCE

963531

RIFERIMENTO COSTRUTTORE O.E. REFERENCE

1906410

DESCRIZIONE / DESCRIPTION

Serie ganasce freno posteriori
Ø 410 X 200 mm.
Rear brake shoes set
Ø 410 X 200 mm.

ILLUSTRAZIONE / ILLUSTRATION



NOSTRO RIFERIMENTO OUR REFERENCE

963532

RIFERIMENTO COSTRUTTORE O.E. REFERENCE

93192915
(3211Q498335)

DESCRIZIONE / DESCRIPTION

Supporto massa frenante nudo
Wheel brake support

ILLUSTRAZIONE / ILLUSTRATION



NOSTRO RIFERIMENTO OUR REFERENCE

963009

RIFERIMENTO COSTRUTTORE O.E. REFERENCE

42531676

DESCRIZIONE / DESCRIPTION

Registro ganasce freno
Brake adjuster device

TIPO DI VEICOLO / VEHICLE TYPE

Eurotech 180E34/E38/E42 - 190E34/E38/E42 - 240E30/E34/E38/E42
400E34/E38/E42 - 440E34/E38/E42

Eurotech Cursor 190E24/E31/E35 -260E24/E31/E35-440E31/E35

Eurostar 180E42 - 190E38/E42/E47/E52 - 240E38/E42/E47/E52 - 400E38/E42/E47/E52
440 E38/E42/E47/E52

Eurotrakker 190E30/E31/E34/E37/E42 - 330E34/E37 - 340E34 - 380E31/E34/E37/E42
400E31/E34/E37/E42 - 410E37/E42-720E31/E37

Eurotrakker Cursor 190E31/E35 - 380/400/410E35 - 330.30 - AP160

ILLUSTRAZIONE / ILLUSTRATION	NOSTRO RIFERIMENTO OUR REFERENCE	RIFERIMENTO COSTRUTTORE O.E. REFERENCE
	963533	93162114 - 93161622 (RBSK 1408)
Kit riparazione freni Brake repairing kit		
ILLUSTRAZIONE / ILLUSTRATION	NOSTRO RIFERIMENTO OUR REFERENCE	RIFERIMENTO COSTRUTTORE O.E. REFERENCE
	963534	93161623 (RBSK 1407)
Kit ridotto freni Reduced kit		
ILLUSTRAZIONE / ILLUSTRATION	NOSTRO RIFERIMENTO OUR REFERENCE	RIFERIMENTO COSTRUTTORE O.E. REFERENCE
	963536	93161621 (RBSK2051)
Kit cunei freni Brake wedges kit		

TIPO DI VEICOLO / VEHICLE TYPE

Eurotech 180E34/E38/E42 - 190E34/E38/E42 - 240E30/E34/E38/E42
400E34/E38/E42 - 440E34/E38/E42

Eurotech Cursor 190E24/E31/E35 - 260E24/E31/E35-440E31/E35

Eurostar 180E42 - 190E38/E42/E47/E52 - 240E38/E42/E47/E52 - 400E38/E42/E47/E52
440 E38/E42/E47/E52

Eurotrakker 190E30/E31/E34/E37/E42 - 330E34/E37 - 340E34 - 380E31/E34/E37/E42
400E31/E34/E37/E42 - 410E37/E42-720E31/E37

Eurotrakker Cursor 190E31/E35 - 380/400/410E35

ILLUSTRAZIONE / ILLUSTRATION



NOSTRO RIFERIMENTO OUR REFERENCE

963547

RIFERIMENTO COSTRUTTORE O.E. REFERENCE

93161353

DESCRIZIONE / DESCRIPTION

Kit cunei freno
Brake wedges kit

ILLUSTRAZIONE / ILLUSTRATION



NOSTRO RIFERIMENTO OUR REFERENCE

963535

RIFERIMENTO COSTRUTTORE O.E. REFERENCE

93161625
(RBSK2030)

DESCRIZIONE / DESCRIPTION

Kit cuffie
Protective hoods set

ILLUSTRAZIONE / ILLUSTRATION



NOSTRO RIFERIMENTO OUR REFERENCE

963541

RIFERIMENTO COSTRUTTORE O.E. REFERENCE

42531677
(1205X2000)

DESCRIZIONE / DESCRIPTION

Cuffia
Protective hood

TIPO DI VEICOLO / VEHICLE TYPE



Eurotech 180E34/E38/E42 - 190E34/E38/E42 - 240E30/E34/E38/E42
400E34/E38/E42 - 440E34/E38/E42

Eurotech Cursor 190E24/E31/E35 - 260E24/E31/E35 - 440E31/E35

Eurostar 180E42 - 190E38/E42/E47/E52 - 240E38/E42/E47/E52 - 400E38/E42/E47/E52
440 E38/E42/E47/E52



Eurotrakker 190E30/E31/E34/E37/E42 - 330E34/E37 - 340E34 - 380E31/E34/E37/E42
400E31/E34/E37/E42 - 410E37/E42 - 720E31/E37

Eurotrakker Cursor 190E31/E35 - 380/400/410E35

ILLUSTRAZIONE / ILLUSTRATION	NOSTRO RIFERIMENTO OUR REFERENCE	RIFERIMENTO COSTRUTTORE O.E. REFERENCE
	963027	42536176 (RBSK 1469)
	DESCRIZIONE / DESCRIPTION	
Cuffia bassa freni Low protective hood		
ILLUSTRAZIONE / ILLUSTRATION	NOSTRO RIFERIMENTO OUR REFERENCE	RIFERIMENTO COSTRUTTORE O.E. REFERENCE
	963537 (1)	93161863 (RBSK 1481)
	963538 (2)	93161864 (RBSK 1482)
DESCRIZIONE / DESCRIPTION		
(1) Kit perni sx - Brake pins set left (2) Kit perni dx - Brake pins set right		
ILLUSTRAZIONE / ILLUSTRATION	NOSTRO RIFERIMENTO OUR REFERENCE	RIFERIMENTO COSTRUTTORE O.E. REFERENCE
	963539	93162113 - 93161627 (RBSK 2128)
	DESCRIZIONE / DESCRIPTION	
Kit molle freno Springs set		

TIPO DI VEICOLO / VEHICLE TYPE

EUROTECH 190E34/E38/E42 - 240E30/E34/E38/E42 - 260E42 - 440E34/E38/E42
EUROTECH CURSOR 260E24/E31/E35/E39/E43
EUROTRAKKER 190E30/E31/E34/E37/E42 - 260E30/E34/E37/E42/E47 - 330E34/E37
 340E34/E37/E42 - 380E31/E34/E37/E42 - 400E34/E37/E42 - 410E37/E42 - 440E34/E37/E42
 720E31/E37/E42
EUROSTAR 190E42/E47/E52 - 240E38/E42/E47/E52 - 260E47/E52 - 440E42/E47/E52
EUROSTAR CURSOR 260E39/E42/E48 - 440E39
STRALIS 260S40/S43/S48/S54 - 440S48/S54

ILLUSTRAZIONE / ILLUSTRATION	NOSTRO RIFERIMENTO OUR REFERENCE	RIFERIMENTO COSTRUTTORE O.E. REFERENCE
<p><i>Impianto / System</i> PERROT</p>  <p>Assale Anteriore Front Axle</p>	<p>963902</p>	<p>41025287 (10410837)</p>
DESCRIZIONE / DESCRIPTION		
<p><i>Massa frenante completa sinistra</i> Ø 410x180 <i>Complete wheel brake left</i> Ø 410x180</p>		
ILLUSTRAZIONE / ILLUSTRATION	NOSTRO RIFERIMENTO OUR REFERENCE	RIFERIMENTO COSTRUTTORE O.E. REFERENCE
<p><i>Impianto / System</i> PERROT</p>  <p>Assale Anteriore Front Axle</p>	<p>963903</p>	<p>41025288 (10410838)</p>
DESCRIZIONE / DESCRIPTION		
<p><i>Massa frenante completa destra</i> Ø 410x180 <i>Complete wheel brake right</i> Ø 410x180</p>		

TIPO DI VEICOLO / VEHICLE TYPE

Eurotech 180E34/E38/E42 - 190E34/E38/E42 - 240E30/E34/E38/E42 - 400E34/E38/E42
440E34/E38/E42

Eurotech Cursor 190E24/E31/E35 - 260E24/E31/E35/E39/E43 - 440E31/E35

Eurostar 180E42 - 190E38/E42/E47/E52 - 240E38/E42/E47/E52 - 400E38/E42/E47/E52
440 E38/E42/E47/E52

Eurostar Cursor 190E39/E43 - 260E39/E43/E48 - 440E43

Eurotrakker 190E30/E31/E34/E37/E42 - 330E34/E37 - 340E34 - 380E31/E34/E37/E42
400E31/E34/E37/E42 - 410E37/E42-720E31/E37

Eurotrakker Cursor 190E31/E35 - 380/400/410E35

Stralis 190S27/S31/S35 - 260S30/S31/S35/S40/S43/S48/S54 - 440S31/S35

ILLUSTRAZIONE / ILLUSTRATION	NOSTRO RIFERIMENTO OUR REFERENCE	RIFERIMENTO COSTRUTTORE O.E. REFERENCE
<p data-bbox="145 741 552 779">Impianto / System PERROT</p>  <p data-bbox="212 1279 485 1350">Assale posteriore Rear Axle</p>	<p data-bbox="770 757 930 804">963557</p>	<p data-bbox="1190 757 1401 804">41025289</p> <p data-bbox="1230 804 1361 835">(10410839)</p>
DESCRIZIONE / DESCRIPTION		
<p data-bbox="644 920 1350 992">Massa frenante completa sinistra \varnothing 410 x 200 mm. Complete wheel brake left \varnothing 410 x 200 mm.</p>		
ILLUSTRAZIONE / ILLUSTRATION	NOSTRO RIFERIMENTO OUR REFERENCE	RIFERIMENTO COSTRUTTORE O.E. REFERENCE
<p data-bbox="145 1480 552 1518">Impianto / System PERROT</p>  <p data-bbox="212 2056 485 2128">Assale posteriore Rear Axle</p>	<p data-bbox="770 1480 930 1527">963558</p>	<p data-bbox="1190 1480 1401 1527">41025290</p> <p data-bbox="1230 1527 1361 1559">(10410840)</p>
DESCRIZIONE / DESCRIPTION		
<p data-bbox="644 1641 1337 1713">Massa frenante completa destra \varnothing 410 x 200 mm. Complete wheel brake right \varnothing 410 x 200 mm.</p>		

TIPO DI VEICOLO / VEHICLE TYPE

Eurotech 180E34/E38/E42 - 190E34/E38/E42 - 240E30/E34/E38/E42 - 400E34/E38/E42
440E34/E38/E42

Eurotech Cursor 190E24/E31/E35 - 260E24/E31/E35/E39/E43 - 440E31/E35

Eurostar 180E42 - 190E38/E42/E47/E52 - 240E38/E42/E47/E52 - 400E38/E42/E47/E52
440 E38/E42/E47/E52

Eurostar Cursor 190E39/E43 - 260E39/E43/E48 - 440E43

Eurotrakker 190E30/E31/E34/E37/E42 - 330E34/E37 - 340E34 - 380E31/E34/E37/E42
400E31/E34/E37/E42 - 410E37/E42-720E31/E37

Eurotrakker Cursor 190E31/E35 - 380/400/410E35

Stralis 190S27/S31/S35 - 260S30/S31/S35/S40/S43/S48/S54 - 440S31/S35

ILLUSTRAZIONE / ILLUSTRATION

Impianto / System **PERROT**



Assale posteriore
Rear Axle
Ø 410 mm x H 200 mm.

NOSTRO RIFERIMENTO OUR REFERENCE

963559

RIFERIMENTO COSTRUTTORE O.E. REFERENCE

2991759
(12999711VT)

DESCRIZIONE / DESCRIPTION

Serie ganasce freno posteriori Ø 410 X 200 mm.
Rear brake shoes set Ø 410 X 200 mm.

ILLUSTRAZIONE / ILLUSTRATION

Impianto / System **PERROT**



Ø 410 x 200 mm.

NOSTRO RIFERIMENTO OUR REFERENCE

963522

RIFERIMENTO COSTRUTTORE O.E. REFERENCE

-

DESCRIZIONE / DESCRIPTION

Ganascia nuda freno posteriore
Rear brake shoe without lining

TIPO DI VEICOLO / VEHICLE TYPE

Eurotech 180E34/E38/E42 - 190E34/E38/E42 - 240E30/E34/E38/E42 - 400E34/E38/E42
440E34/E38/E42

Eurotech Cursor 190E24/E31/E35 - 260E24/E31/E35/E39/E43 - 440E31/E35



Eurostar 180E42 - 190E38/E42/E47/E52 - 240E38/E42/E47/E52 - 400E38/E42/E47/E52
440 E38/E42/E47/E52

Eurostar Cursor 190E39/E43 - 260E39/E43/E48 - 440E43

Eurotrakker 190E30/E31/E34/E37/E42 - 330E34/E37 - 340E34 - 380E31/E34/E37/E42
400E31/E34/E37/E42 - 410E37/E42-720E31/E37

Eurotrakker Cursor 190E31/E35 - 380/400/410E35

Stralis 190S27/S31/S35 - 260S30/S31/S35/S40/S43/S48/S54 - 440S31/S35

ILLUSTRAZIONE / ILLUSTRATION	NOSTRO RIFERIMENTO OUR REFERENCE	RIFERIMENTO COSTRUTTORE O.E. REFERENCE
<p>Impianto / System PERROT</p>  <p>Assale Anteriore Front Axle</p>	<p>963615</p>	<p>2991755 (12999709VT)</p>
ILLUSTRAZIONE / ILLUSTRATION	NOSTRO RIFERIMENTO OUR REFERENCE	RIFERIMENTO COSTRUTTORE O.E. REFERENCE
<p>Impianto / System PERROT</p> 	<p>963019</p>	<p>93161254 (12999418VT)</p>

TIPO DI VEICOLO / VEHICLE TYPE

Eurotech 180E34/E38/E42 - 190E34/E38/E42 - 240E30/E34/E38/E42 - 400E34/E38/E42
440E34/E38/E42

Eurotech Cursor 190E24/E31/E35 - 260E24/E31/E35/E39/E43 - 440E31/E35

Eurostar 180E42 - 190E38/E42/E47/E52 - 240E38/E42/E47/E52 - 400E38/E42/E47/E52
440 E38/E42/E47/E52

Eurostar Cursor 190E39/E43 - 260E39/E43/E48 - 440E43

Eurotrakker 190E30/E31/E34/E37/E42 - 330E34/E37 - 340E34 - 380E31/E34/E37/E42
400E31/E34/E37/E42 - 410E37/E42-720E31/E37

Eurotrakker Cursor 190E31/E35 - 380/400/410E35

Stralis 190S27/S31/S35 - 260S30/S31/S35/S40/S43/S48/S54 - 440S31/S35

ILLUSTRAZIONE / ILLUSTRATION

Impianto / System **PERROT**



NOSTRO RIFERIMENTO OUR REFERENCE

963599

RIFERIMENTO COSTRUTTORE O.E. REFERENCE

93161257
(12999404)

DESCRIZIONE / DESCRIPTION

Kit cuffie per cilindro freno
Protective hoods set for brake cylinder

ILLUSTRAZIONE / ILLUSTRATION

Impianto / System **PERROT**



NOSTRO RIFERIMENTO OUR REFERENCE

963553

RIFERIMENTO COSTRUTTORE O.E. REFERENCE

93161768
(12999410)

DESCRIZIONE / DESCRIPTION

Kit cunei
Brake wedges kit

ILLUSTRAZIONE / ILLUSTRATION

Impianto / System **PERROT**



NOSTRO RIFERIMENTO OUR REFERENCE

963548

RIFERIMENTO COSTRUTTORE O.E. REFERENCE

93161256
(12999411VT)

DESCRIZIONE / DESCRIPTION

Kit revisione boccole freno
Brake springs kit

TIPO DI VEICOLO / VEHICLE TYPE

Eurotech 180E34/E38/E42 - 190E34/E38/E42 - 240E30/E34/E38/E42 - 400E34/E38/E42
440E34/E38/E42

Eurotech Cursor 190E24/E31/E35 - 260E24/E31/E35/E39/E43 - 440E31/E35



Eurostar 180E42 - 190E38/E42/E47/E52 - 240E38/E42/E47/E52 - 400E38/E42/E47/E52
440 E38/E42/E47/E52

Eurostar Cursor 190E39/E43 - 260E39/E43/E48 - 440E43

Eurotrakker 190E30/E31/E34/E37/E42 - 330E34/E37 - 340E34 - 380E31/E34/E37/E42
400E31/E34/E37/E42 - 410E37/E42-720E31/E37

Eurotrakker Cursor 190E31/E35 - 380/400/410E35

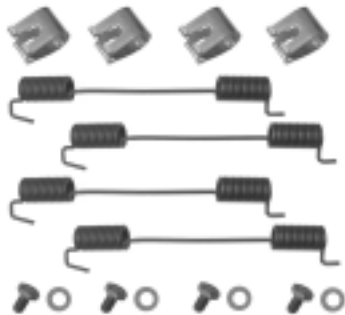
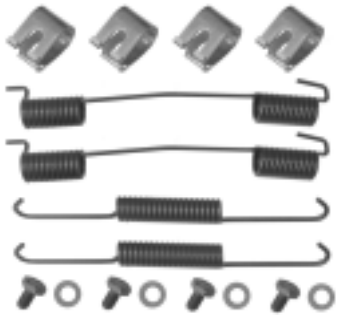
Stralis 190S27/S31/S35 - 260S30/S31/S35/S40/S43/S48/S54 - 440S31/S35

ILLUSTRAZIONE / ILLUSTRATION	NOSTRO RIFERIMENTO OUR REFERENCE	RIFERIMENTO COSTRUTTORE O.E. REFERENCE
Impianto / System PERROT 	963556	93161260 (12999443)
		DESCRIZIONE / DESCRIPTION Kit molle freno Brake springs set
Impianto / System PERROT 	963555	93161872 (12999573VT)
		DESCRIZIONE / DESCRIPTION Kit molle freno Brake springs set
ILLUSTRATION / ILLUSTRATION 	963620	8121441 (13304029)
		DESCRIZIONE / DESCRIPTION Molla ganasce Brake spring shoes

TIPO DI VEICOLO / VEHICLE TYPE

Eurotrakker 190E37 - 380E37/E42 - 440E37/E42 - 720E37/E42

Eurotrakker Cursor 190E31/E35/E38/E44 - 380E38/E44 - 410E38/E44 - 720E38/E44

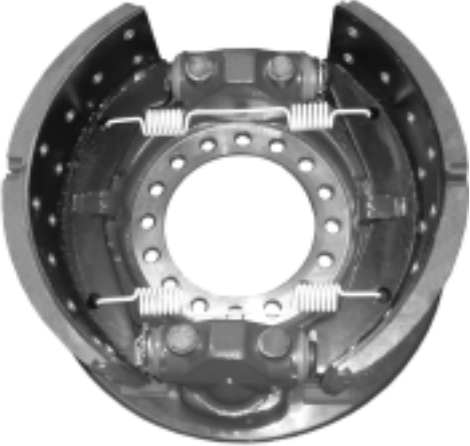
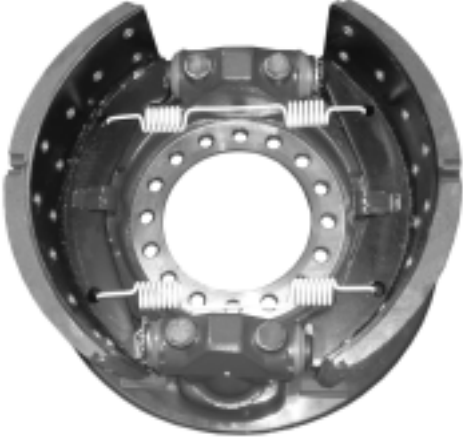
ILLUSTRAZIONE / ILLUSTRATION	NOSTRO RIFERIMENTO OUR REFERENCE	RIFERIMENTO COSTRUTTORE O.E. REFERENCE
<p data-bbox="140 674 560 745"><i>Impianto / System</i> MERITOR (DUPLEX)</p>  <p data-bbox="220 1249 475 1317">Assale Anteriore Front Axle</p>	<p data-bbox="778 667 935 712">963572</p>	<p data-bbox="1203 667 1414 712">41211318</p>
DESCRIZIONE / DESCRIPTION		
<p data-bbox="655 826 1358 898"><i>Massa frenante completa sinistra</i> Ø 410 x 180 mm. <i>Complete wheel brake left</i> Ø 410 x 180 mm.</p>		
ILLUSTRAZIONE / ILLUSTRATION	NOSTRO RIFERIMENTO OUR REFERENCE	RIFERIMENTO COSTRUTTORE O.E. REFERENCE
<p data-bbox="132 1460 552 1532"><i>Impianto / System</i> MERITOR (DUPLEX)</p>  <p data-bbox="212 2072 467 2139">Assale Anteriore Front Axle</p>	<p data-bbox="770 1453 927 1498">963573</p>	<p data-bbox="1192 1453 1402 1498">41211319</p>
DESCRIZIONE / DESCRIPTION		
<p data-bbox="647 1612 1337 1684"><i>Massa frenante completa destra</i> Ø 410 x 180 mm. <i>Complete wheel brake right</i> Ø 410 x 180 mm.</p>		

TIPO DI VEICOLO / VEHICLE TYPE

Eurotrakker 190E37 - 380E37/E42 - 440E37/E42 - 720E37/E42
Eurotrakker Cursor 180E24/E27 - 190E24/E27/E31/E35/E38/E44 - 260E31/E35/E38/E44/E48
 340E35/E38/E44/E48 - 380E35/E38/E44/E48 - 400E38/E44 - 410E35/E38/E44/E48
 440E38/E44 - 720E38/E44/E48

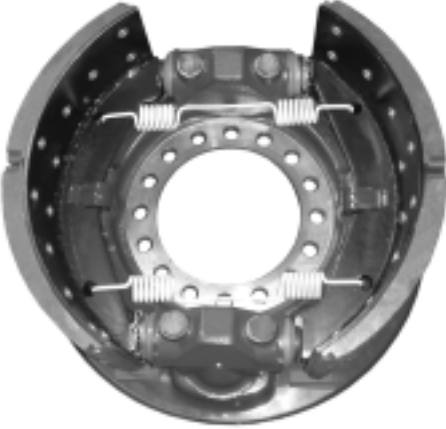
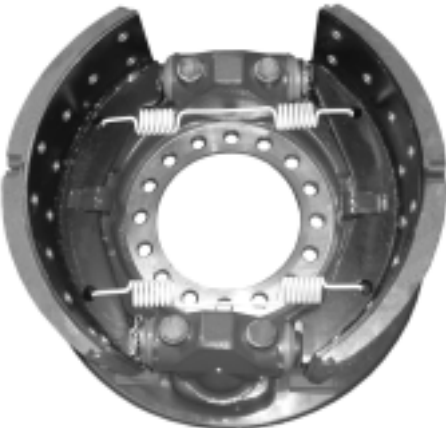
ILLUSTRAZIONE / ILLUSTRATION	NOSTRO RIFERIMENTO OUR REFERENCE	RIFERIMENTO COSTRUTTORE O.E. REFERENCE
<p data-bbox="140 667 558 741"><i>Impianto / System</i> MERITOR (DUPLEX)</p>  <p data-bbox="212 1243 486 1317">Assale Posteriore Rear Axle</p>	963570	41211321 - 41211043
DESCRIZIONE / DESCRIPTION		
<p data-bbox="655 824 1361 898"><i>Massa frenante completa sinistra</i> Ø 410 x 200 mm. <i>Complete wheel brake left</i> Ø 410 x 200 mm.</p>		
ILLUSTRAZIONE / ILLUSTRATION	NOSTRO RIFERIMENTO OUR REFERENCE	RIFERIMENTO COSTRUTTORE O.E. REFERENCE
<p data-bbox="140 1458 558 1532"><i>Impianto / System</i> MERITOR (DUPLEX)</p>  <p data-bbox="212 2033 486 2107">Assale Posteriore Rear Axle</p>	963571	41211322 - 41211044
DESCRIZIONE / DESCRIPTION		
<p data-bbox="655 1615 1342 1688"><i>Massa frenante completa destra</i> Ø 410 x 200 mm. <i>Complete wheel brake right</i> Ø 410 x 200 mm.</p>		

TIPO DI VEICOLO / VEHICLE TYPE

Eurotrakker 190E37 - 380E37/E42 - 440E37/E42 - 720E37/E42
Eurotrakker Cursor 180E24/E27 - 190E24/E27/E31/E35/E38/E44 - 260E31/E35/E38/E44/E48
 340E35/E38/E44/E48 - 380E35/E38/E44/E48 - 400E38/E44 - 410E35/E38/E44/E48
 440E38/E44 - 720E38/E44/E48

ILLUSTRAZIONE / ILLUSTRATION

Impianto / System **MERITOR**



**Assale Anteriore
Front Axle
Ø 410 mm x H 180 mm.**

NOSTRO RIFERIMENTO
OUR REFERENCE

963590

RIFERIMENTO COSTRUTTORE
O.E. REFERENCE

2992375

DESCRIZIONE / DESCRIPTION

Serie ganasce freno anteriori Ø 410 X 180 mm.
Front brake shoes set Ø 410 X 180 mm.

ILLUSTRAZIONE / ILLUSTRATION

Impianto / System **MERITOR**



**Assale Posteriore
Rear Axle
Ø 410 mm x H 200 mm.**

NOSTRO RIFERIMENTO
OUR REFERENCE

963591

RIFERIMENTO COSTRUTTORE
O.E. REFERENCE



2992378

DESCRIZIONE / DESCRIPTION

Serie ganasce freno posteriori Ø 410 X 200 mm.
Rear brake shoes set Ø 410 X 200 mm.

TIPO DI VEICOLO / VEHICLE TYPE

Eurotrakker 190E37 - 380E37/E42 - 440E37/E42 - 720E37/E42
Eurotrakker Cursor 180E24/E27 - 190E24/E27/E31/E35/E38/E44 - 260E31/E35/E38/E44/E48
 340E35/E38/E44/E48 - 380E35/E38/E44/E48 - 400E38/E44 - 410E35/E38/E44/E48
 440E38/E44 - 720E38/E44/E48

ILLUSTRAZIONE / ILLUSTRATION	NOSTRO RIFERIMENTO OUR REFERENCE	RIFERIMENTO COSTRUTTORE O.E. REFERENCE
<p>Impianto / System MERITOR</p> 	963594	42536197
DESCRIZIONE / DESCRIPTION		
<p>Kit riparazione freni (parte registrabile) Brake repairing kit (Adjustable part)</p>		
ILLUSTRAZIONE / ILLUSTRATION	NOSTRO RIFERIMENTO OUR REFERENCE	RIFERIMENTO COSTRUTTORE O.E. REFERENCE
<p>Impianto / System MERITOR</p> 	963595	42537365
DESCRIZIONE / DESCRIPTION		
<p>Kit riparazione freni (parte fissa - Lato Dx) Brake repairing kit (Fixed part- Right side)</p>		
ILLUSTRAZIONE / ILLUSTRATION	NOSTRO RIFERIMENTO OUR REFERENCE	RIFERIMENTO COSTRUTTORE O.E. REFERENCE
<p>Impianto / System MERITOR</p> 	963569	42537366
DESCRIZIONE / DESCRIPTION		
<p>Kit riparazione freni (parte fissa - Lato Sx) Brake repairing kit (Fixed part- Left side)</p>		

TIPO DI VEICOLO / VEHICLE TYPE

Eurotrakker 190E37 - 380E37/E42 - 440E37/E42 - 720E37/E42

Eurotrakker Cursor 180E24/E27 - 190E24/E27/E31/E35/E38/E44 - 260E31/E35/E38/E44/E48
340E35/E38/E44/E48 - 380E35/E38/E44/E48 - 400E38/E44 - 410E35/E38/E44/E48
440E38/E44 - 720E38/E44/E48

ILLUSTRAZIONE / ILLUSTRATION	NOSTRO RIFERIMENTO OUR REFERENCE	RIFERIMENTO COSTRUTTORE O.E. REFERENCE
<p><i>Impianto / System</i> MERITOR</p> 	963593	42536194
DESCRIZIONE / DESCRIPTION		
<i>Kit cunei freno Brake wedges kit</i>		
ILLUSTRAZIONE / ILLUSTRATION	NOSTRO RIFERIMENTO OUR REFERENCE	RIFERIMENTO COSTRUTTORE O.E. REFERENCE
<p><i>Impianto / System</i> MERITOR</p> 	963596	42536195
DESCRIZIONE / DESCRIPTION		
<i>Kit ridotto freno Reduced kit</i>		
ILLUSTRAZIONE / ILLUSTRATION	NOSTRO RIFERIMENTO OUR REFERENCE	RIFERIMENTO COSTRUTTORE O.E. REFERENCE
<p><i>Impianto / System</i> MERITOR</p> 	963574	42537884
DESCRIZIONE / DESCRIPTION		
<i>Kit cuffie freno Protective hoods set</i>		

Copyright della EMMERRE S.r.l. - Settimo Torinese - Tutti i diritti sono riservati e depositati a norma delle convenzioni internazionali. E' vietata la duplicazione o la riproduzione anche parziale senza la previa autorizzazione della EMMERRE S.r.l.



TIPO DI VEICOLO / VEHICLE TYPE

Eurotrakker 190E37 - 380E37/E42 - 440E37/E42 - 720E37/E42**Eurotrakker Cursor** 180E24/E27 - 190E24/E27/E31/E35/E38/E44 - 260E31/E35/E38/E44/E48
340E35/E38/E44/E48 - 380E35/E38/E44/E48 - 400E38/E44 - 410E35/E38/E44/E48
440E38/E44 - 720E38/E44/E48

ILLUSTRAZIONE / ILLUSTRATION	NOSTRO RIFERIMENTO OUR REFERENCE	RIFERIMENTO COSTRUTTORE O.E. REFERENCE
Impianto / System MERITOR 	963575	42537758
DESCRIZIONE / DESCRIPTION		
Registro ganasce freno Brake adjuster device		
ILLUSTRAZIONE / ILLUSTRATION	NOSTRO RIFERIMENTO OUR REFERENCE	RIFERIMENTO COSTRUTTORE O.E. REFERENCE
Impianto / System MERITOR 	963576	42537841
DESCRIZIONE / DESCRIPTION		
Cuffia bassa Low protective hood		
ILLUSTRAZIONE / ILLUSTRATION	NOSTRO RIFERIMENTO OUR REFERENCE	RIFERIMENTO COSTRUTTORE O.E. REFERENCE
	963540	93161626 (RBSK 1409)
DESCRIZIONE / DESCRIPTION		
Kit fissaggio ganasce Brake shoes fixing kit		

TIPO DI VEICOLO / VEHICLE TYPE



Eurotrakker 190E37 - 380E37/E42 - 440E37/E42 - 720E37/E42
Eurotrakker Cursor 180E24/E27 - 190E24/E27/E31/E35/E38/E44 - 260E31/E35/E38/E44/E48
 340E35/E38/E44/E48 - 380E35/E38/E44/E48 - 400E38/E44 - 410E35/E38/E44/E48
 440E38/E44 - 720E38/E44/E48

ILLUSTRAZIONE / ILLUSTRATION	NOSTRO RIFERIMENTO OUR REFERENCE	RIFERIMENTO COSTRUTTORE O.E. REFERENCE
	963560	42536192
	963518	42550957
		

Copyright della EMMERRE S.r.l. - Settimo Torinese - Tutti i diritti sono riservati e depositati a norma delle convenzioni internazionali. E' vietata la duplicazione o la riproduzione anche parziale senza la previa autorizzazione della EMMERRE S.r.l.

TIPO DI VEICOLO / VEHICLE TYPE

BUS
EUROCLASS - EURORIDER
TURBOCITY 370

ILLUSTRAZIONE / ILLUSTRATION	NOSTRO RIFERIMENTO OUR REFERENCE	RIFERIMENTO COSTRUTTORE O.E. REFERENCE
<p>Impianto / System MERITOR DUPLEX</p>  <p>Assale posteriore - Rear axle</p>	960561	2992448
ILLUSTRAZIONE / ILLUSTRATION	NOSTRO RIFERIMENTO OUR REFERENCE	RIFERIMENTO COSTRUTTORE O.E. REFERENCE
<p>Impianto / System MERITOR</p> 	963594	42536197
ILLUSTRAZIONE / ILLUSTRATION	NOSTRO RIFERIMENTO OUR REFERENCE	RIFERIMENTO COSTRUTTORE O.E. REFERENCE
<p>Impianto / System MERITOR</p> 	963595	42537365

TIPO DI VEICOLO / VEHICLE TYPE

BUS
EUROCLASS - EURORIDER
TURBOCITY 370

ILLUSTRAZIONE / ILLUSTRATION

Impianto / System **MERITOR**



NOSTRO RIFERIMENTO
OUR REFERENCE

963569

RIFERIMENTO COSTRUTTORE
O.E. REFERENCE

42537366

DESCRIZIONE / DESCRIPTION

Kit riparazione freni
(parte fissa - Lato Sx)
Brake repairing kit
(Fixed part- Left side)

ILLUSTRAZIONE / ILLUSTRATION

Impianto / System **MERITOR**



NOSTRO RIFERIMENTO
OUR REFERENCE

963593

RIFERIMENTO COSTRUTTORE
O.E. REFERENCE

42536194

DESCRIZIONE / DESCRIPTION

Kit cunei freno
Brake wedges kit

ILLUSTRAZIONE / ILLUSTRATION

Impianto / System **MERITOR**



NOSTRO RIFERIMENTO
OUR REFERENCE

963596

RIFERIMENTO COSTRUTTORE
O.E. REFERENCE

42536195

DESCRIZIONE / DESCRIPTION

Kit ridotto freno
Reduced kit

TIPO DI VEICOLO / VEHICLE TYPE

BUS
EUROCLASS - EURORIDER
TURBOCITY 370

ILLUSTRAZIONE / ILLUSTRATION	NOSTRO RIFERIMENTO OUR REFERENCE	RIFERIMENTO COSTRUTTORE O.E. REFERENCE
<p>Impianto / System MERITOR</p> 	963574	42537884
DESCRIZIONE / DESCRIPTION		
<p>Kit cuffie freno Protective hoods set</p>		
ILLUSTRAZIONE / ILLUSTRATION	NOSTRO RIFERIMENTO OUR REFERENCE	RIFERIMENTO COSTRUTTORE O.E. REFERENCE
<p>Impianto / System MERITOR</p> 	963575	42537758
DESCRIZIONE / DESCRIPTION		
<p>Registro ganasce freno Brake adjuster device</p>		
ILLUSTRAZIONE / ILLUSTRATION	NOSTRO RIFERIMENTO OUR REFERENCE	RIFERIMENTO COSTRUTTORE O.E. REFERENCE
<p>Impianto / System MERITOR</p> 	963576	42537841
DESCRIZIONE / DESCRIPTION		
<p>Cuffia bassa Low protective hood</p>		

TIPO DI VEICOLO / VEHICLE TYPE

BUS
EUROCLASS - EURORIDER
TURBOCITY 370

ILLUSTRAZIONE / ILLUSTRATION



NOSTRO RIFERIMENTO
OUR REFERENCE

963540

RIFERIMENTO COSTRUTTORE
O.E. REFERENCE

93161626
(RBSK 1409)

DESCRIZIONE / DESCRIPTION

Kit fissaggio ganasce
Brake shoes fixing kit

ILLUSTRAZIONE / ILLUSTRATION



NOSTRO RIFERIMENTO
OUR REFERENCE

963560

RIFERIMENTO COSTRUTTORE
O.E. REFERENCE

42536192

DESCRIZIONE / DESCRIPTION

Kit molle freno (impianto MERITOR)
Brake springs set (MERITOR system)

ILLUSTRAZIONE / ILLUSTRATION



NOSTRO RIFERIMENTO
OUR REFERENCE



963004

RIFERIMENTO COSTRUTTORE
O.E. REFERENCE

42488208



DESCRIZIONE / DESCRIPTION

Kit cuffie alta e bassa
High and low protective hoods set





	Ns Riferim. Our Ref.	Rif. Costr. O.E. Ref.	Descrizione/Tipo di veicolo Description/Vehicle Type
	962501	42064491	Ghiera cilindro freno Brake cylinder bush Eurocargo Tector T.T. 330.30 - AP160
	962505	93163852	Ghiera cilindro freno Brake cylinder bush Eurotrakker Cursor Stralis - Eurostar
	962504	4756032	Ghiera cilindro freno Brake cylinder bush Turbostar 115 - 330
	963028	42063178	Ghiera cilindro freno Brake cylinder bush Turbostar 115 - 135
	963029	-	Ghiera cilindro freno MODIFICATA Modified brake cylinder bush Turbostar 115 - 135





	Ns Riferim. Our Ref.	Rif. Costr. O.E. Ref.	Descrizione/Tipo di veicolo Description/Vehicle Type
	960844	-	<i>Autoregistro completo destro</i> <i>Complete autoadjuster right</i>
	960845	-	<i>Autoregistro completo sinistro</i> <i>Complete autoadjuster left</i>
			Daily Restyling 30.8-35.8-40.8-35.10 New Daily 30.8-35.8-40.8-35.10 Turbo Daily 35.12
	960860	93192155	<i>Registro freno automatico</i> <i>Automatic brake adjuster</i>
			Daily Restyling 49.10 New Daily 35.8-35.10-45.10-49.10 Turbo Daily 49.12
	960859	4851782	<i>Registro freno automatico</i> <i>Automatic brake adjuster</i>
			Daily 59.12 Zeta 50.9-65.9 TurboZeta 60.11-65.12-79.12
	960855	8528686	<i>Registro freni</i> <i>Brake adjuster</i>
			50NC-50/55/65/70/75F8 619N1-697-300

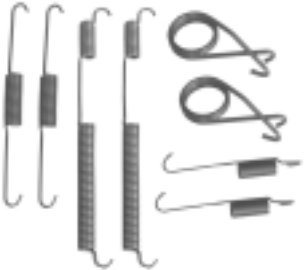

	Ns Riferim. Our Ref.	Rif. Costr. O.E. Ref.	Descrizione/Tipo di veicolo Description/Vehicle Type
	960856	-	<p>Registro freno con molla ns. modifica brevetto (M.I.U.53/896-B/91) adattabile 8528686 Brake adjuster with spring our modification/patents (M.I.U. 53/896-B/91) adaptable 8528686</p> <p>50NC - 50/55/65/70/75F8 619N1 - 697 - 300</p>
	960857	7170420	<p>Registro freno automatico Automatic brake adjuster</p> <p>Zeta 50.9 - 65.9 TurboZeta 65.12</p>
	960840	4819706	<p>Registro freno automatico Automatic brake adjuster</p> <p>Zeta 79.14 TurboZeta 79.12</p>
	960858	8547781 1269296	<p>Registro freno Brake adjuster</p> <p>80-90NC - 90.13 120.13/ - 75/80.13/17</p>

	Ns Riferim. Our Ref.	Rif. Costr. O.E. Ref.	Descrizione/Tipo di veicolo Description/Vehicle Type
	963090	5010145932	Massa frenante completa DX Complete wheel brake RH (Adattabile / Adaptable BOSCH 204111052) RENAULT FN80
	963091	5010145933	Massa frenante completa SX Complete wheel brake LH (Adattabile / Adaptable BOSCH 204111051) RENAULT FN80
	963093	5010145931	Massa frenante completa DX Complete wheel brake RH (Adattabile / Adaptable BOSCH 204111092) RENAULT FN60
	963092	5010145930	Massa frenante completa SX Complete wheel brake LH (Adattabile / Adaptable BOSCH 204111091) RENAULT FN60
<p>DISPONIBILE A MAGAZZINO AVAILABLE ON STOCK</p>	963096	5001829350	Serie ganasce freno DX/SX Brake shoes set RH/LH

	Ns Riferim. Our Ref.	Rif. Costr. O.E. Ref.	Descrizione/Tipo di veicolo Description/Vehicle Type
	970100	5001860144	Serie ganasce freno a mano posteriori Rear brake shoes set for hand brake Mascott 1999

	Ns Riferim. Our Ref.	Rif. Costr. O.E. Ref.	Descrizione/Tipo di veicolo Description/Vehicle Type
<p><i>Impianto / System</i> GIRLING</p> 	961012	9945885	<p><i>Serie ganasce freno posteriori</i> <i>Rear brake shoes set</i></p> <p>Ducato 1900 - 2500 TD 10-14 q.li dal 1994 al 2001 Citroen Jumper 27-31 dal 1994 Peugeot Boxer 10-14 q.li dal 1994</p>
<p><i>Impianto / System</i> GIRLING</p> 	961000	9945884	<p><i>Serie ganasce freno posteriori</i> <i>Rear brake shoes set</i></p> <p>Ducato 2800 TD 18 q.li dal 1994 al 2001 Citroen Jumper 35 dal 1994 Peugeot Boxer 18 q.li dal 1994</p>
<p><i>Impianto / System</i> BENDIX</p> 	961057	9566949580	<p><i>Serie ganasce freno posteriori</i> <i>Rear brake shoes set</i></p> <p>Ducato - Scudo T.T. dal 1995 Ulisse T.T.</p>
<p><i>Impianto / System</i> BENDIX</p> 	961050	77363479	<p><i>Serie ganasce freno posteriori</i> <i>Rear brake shoes set</i></p> <p>Ducato 2006 U.T.</p>
	961044	-	<p><i>Kit molle per serie ganasce freno posteriori</i> <i>Springs set for rear brake shoes set</i></p> <p>Ducato - 1900 - 2500 TD - 2800TD</p>





	Ns Riferim. Our Ref.	Rif. Costr. O.E. Ref.	Descrizione/Tipo di veicolo Description/Vehicle Type
<p><i>Impianto / System BENDIX</i></p>  <p>AD ESAURIMENTO</p>	961058	6579150	<p>Serie ganasce freno posteriori 254 x 52 mm. Rear brake shoes set 254 x 52 mm.</p> <p>Transit 80D Transit 120D dal 1991</p>
<p><i>Impianto / System BENDIX</i></p>  <p>AD ESAURIMENTO</p>	961059	6733350	<p>Serie ganasce freno posteriori 280 x 65 mm. Rear brake shoes set 280 x 65 mm.</p> <p>Ford Transit 130D - 150D - 190D dal 1991</p>
<p><i>Impianto / System BENDIX</i></p>  <p>AD ESAURIMENTO</p>	961060	7125122	<p>Serie ganasce freno posteriori 254 x 52 mm. Rear brake shoes set 254 x 52 mm.</p> <p>Ford Transit 80 - 100L - 120 dal 1994</p>
<p><i>Impianto / System BENDIX</i></p>  <p>AD ESAURIMENTO</p>	961061	92VB2200BA	<p>Serie ganasce freno posteriori 280 x 65 mm. Rear brake shoes set 280 x 65 mm.</p> <p>Ford Transit 190L dal 1994</p>
<p><i>Impianto / System BENDIX</i></p> 	961062	-	<p>Serie ganasce freno posteriori Rear brake shoes set</p> <p>Ford Transit dal 1999</p>

	Ns Riferim. Our Ref.	Rif. Costr. O.E. Ref.	Descrizione/Tipo di veicolo Description/Vehicle Type
<p>Impianto / System ATE</p>  <p>AD ESAURIMENTO</p>	962543	-	<p>Serie ganasce freno posteriori Rear brake shoe set</p> <p>Sprinter dal / from 1995</p>
<p>Impianto / System GIRLING</p>  <p>AD ESAURIMENTO</p>	962544	113602P	<p>Serie ganasce freno posteriori Rear brake shoe set</p> <p>MB 80 dal/from 1993 al/to 10/1995</p> <p>MB 100 - 140 - 180 dal/from 1988 al/to 10/1995</p>

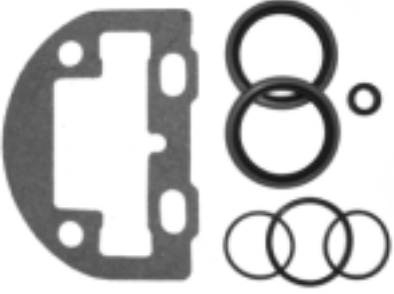

NISSAN

**SERIE GANASCE FRENO
BRAKE SHOES SET**

	Ns Riferim. Our Ref.	Rif. Costr. O.E. Ref.	Descrizione/Tipo di veicolo Description/Vehicle Type
	960873	-06905320-0	<p>Serie ganasce freno posteriori Rear brake shoe set</p> <p>Trade Cabstar</p>

	Ns Riferim. Our Ref.	Rif. Costr. O.E. Ref.	Descrizione/Tipo di veicolo Description/Vehicle Type
<p>UNTILL OUT OF STOCK</p>  <p>AD ESAURIMENTO</p>	963601	1696450	<p>Guarnizione coperchio Z-CAM Cover gasket cover Z-CAM</p> <p>VOLVO T.T.</p>
	963602	272905	<p>Kit guarnizioni Z-CAM Gaskets repairing kit Z-CAM</p> <p>VOLVO T.T.</p>
	963604	3090954 1696448	<p>Cuffia Z-CAM Protective hood Z-CAM</p> <p>VOLVO T.T.</p>
<p>UNTILL OUT OF STOCK</p>  <p>AD ESAURIMENTO</p>	963605	272904	<p>Kit revisione coperchio Z-CAM Cover repairing kit Z-CAM</p> <p>VOLVO T.T.</p>
	963606	272910 1696453	<p>Perno Z-CAM Pin Z-CAM</p> <p>VOLVO T.T.</p>

	Ns Riferim. Our Ref.	Rif. Costr. O.E. Ref.	Descrizione/Tipo di veicolo Description/Vehicle Type
	963607	1696446	<i>Perno Z-CAM Pin Z-CAM</i> VOLVO T.T.
	963608	3097299 1698346 1696445	<i>Perno Z-CAM Pin Z-CAM</i> VOLVO T.T.
UNTILL OUT OF STOCK  AD ESAURIMENTO	963609	3097092 1696444	<i>Molla ritorno Z-CAM Return spring Z-CAM</i> VOLVO T.T.
	963610	1696924	<i>Pignone registro Sx Z-CAM Adjuster pinion left Z-CAM</i>
	963611	1696925	<i>Pignone registro Dx Z-CAM Adjuster pinion right Z-CAM</i> VOLVO T.T.

	Ns Riferim. Our Ref.	Rif. Costr. O.E. Ref.	Descrizione/Tipo di veicolo Description/Vehicle Type
	963584	8550977 3097100 272908	Dispositivo registrazione Dx Z-CAM Adjuster device right Z-CAM
	963585	8550978 3097099 272909	Dispositivo registrazione Sx Z-CAM Adjuster device left Z-CAM VOLVO T.T.
<p>UNTILL OUT OF STOCK</p>  <p>AD ESAURIMENTO</p>	963586	276097	Kit revisione Sx Z-CAM Repairing kit left Z-CAM VOLVO T.T.
<p>UNTILL OUT OF STOCK</p>  <p>AD ESAURIMENTO</p>	963587	276098	Kit revisione Dx Z-CAM Repairing kit right Z-CAM VOLVO T.T.
	963588	272906	Kit revisione Sx Z-CAM Repairing kit left Z-CAM VOLVO T.T.

	Ns Riferim. Our Ref.	Rif. Costr. O.E. Ref.	Descrizione/Tipo di veicolo Description/Vehicle Type
	963589	272907	<i>Kit revisione Dx Z-CAM</i> <i>Repairing kit right Z-CAM</i> VOLVO T.T.
	963612	3090964	<i>Kit revisione Z-CAM</i> <i>Repairing kit Z-CAM</i> VOLVO T.T.
<p>UNTILL OUT OF STOCK</p> <p>AD ESAURIMENTO</p>	963613	1698967	<i>Cuffia Z-CAM</i> <i>Protective hood Z-CAM</i> VOLVO T.T.

EMMERRE

TECHNO
BRAKE®

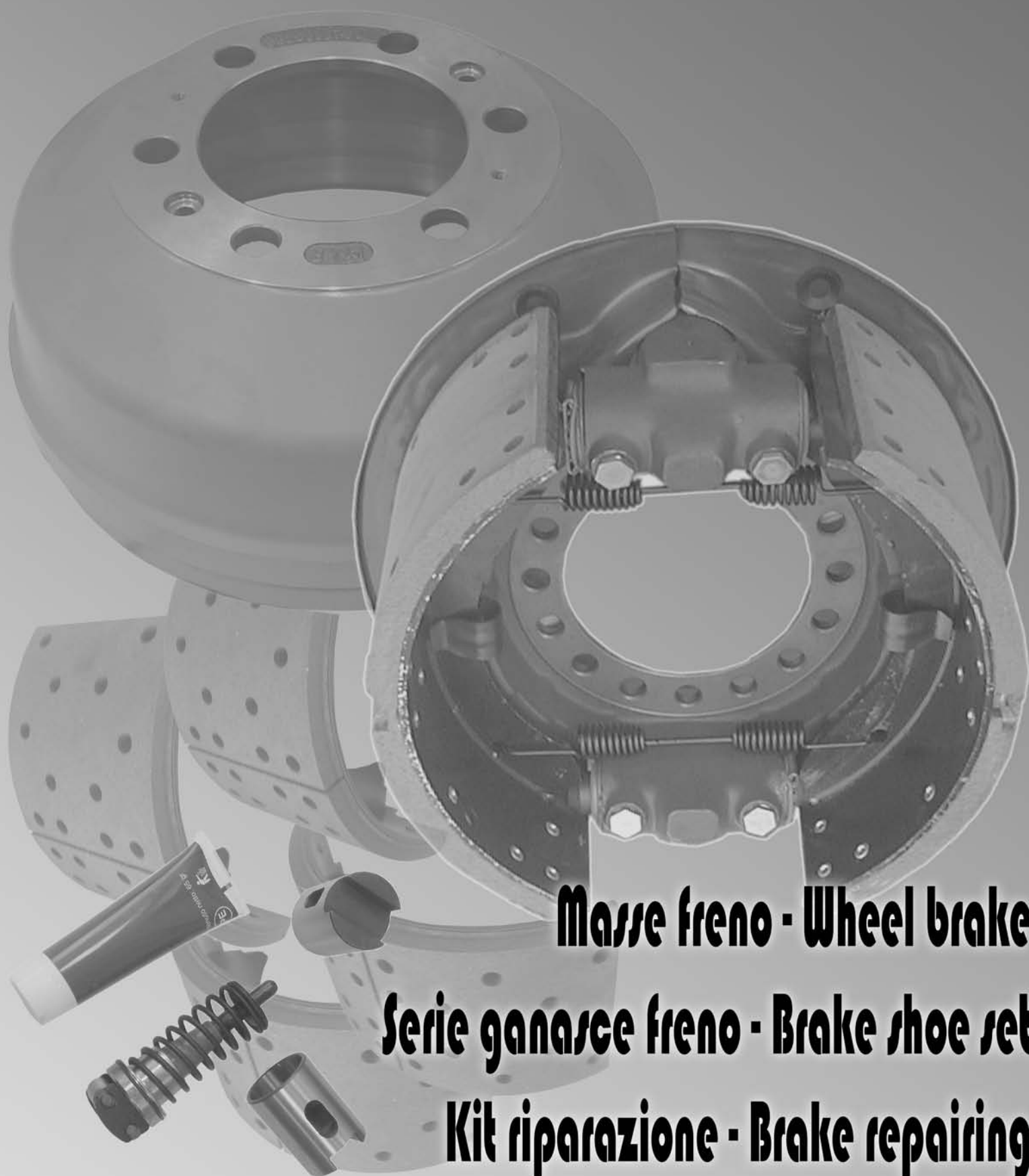

Masse freno - Wheel brake

Serie ganasce freno - Brake shoe set



Kit riparazione - Brake repairing

Tamburi freno - Brake drum

	Ns Riferim. Our Ref.	Rif. Costr. O.E. Ref.	Descrizione/Tipo di veicolo Description/Vehicle Type
 <p>Ø 254.4 H 122.4 n.fori 6</p>	960027	7165379	<p><i>Tamburo freno posteriore</i> <i>Rear brake drum</i></p> <p>Daily Restyling 35.8-40.8-35.10 New Daily 35.8-40.8-35.10 Turbo Daily 35.10-35.12</p> 
 <p>Ø 270 H 144 n.fori 6</p>	960028	7165402	<p><i>Tamburo freno posteriore</i> <i>Rear brake drum</i></p> <p>Daily Restyling 45.10 - 49.10 New Daily 35.10-45.10-49.10 Turbo Daily 49.12</p> 

	Ns Riferim. Our Ref.	Rif. Costr. O.E. Ref.	Descrizione/Tipo di veicolo Description/Vehicle Type
	960203	43206F3600	Tamburo freno posteriore Rear brake drum Trade - Cabstar 
	960220	432069x201	Tamburo freno posteriore Rear brake drum Cabstar 120 
	960204	-06200387-0	Tamburo freno posteriore Rear brake drum Eco T100 - Atleon 100-120 

Copyright della EMMERRE S.r.l. - Settimo Torinese - Tutti i diritti sono riservati e depositati a norma delle convenzioni internazionali. - E' vietata la duplicazione o la riproduzione anche parziale senza la previa autorizzazione della EMMERRE S.r.l.



	Ns Riferim. Our Ref.	Rif. Costr. O.E. Ref.	Descrizione/Tipo di veicolo Description/Vehicle Type
	960025	80600001029	<p><i>Tamburo freno posteriore</i> <i>Rear brake drum</i></p> <p>GASOLONE TS H35 TS H35 U.T. (euro4)</p> 

EMMEDDE

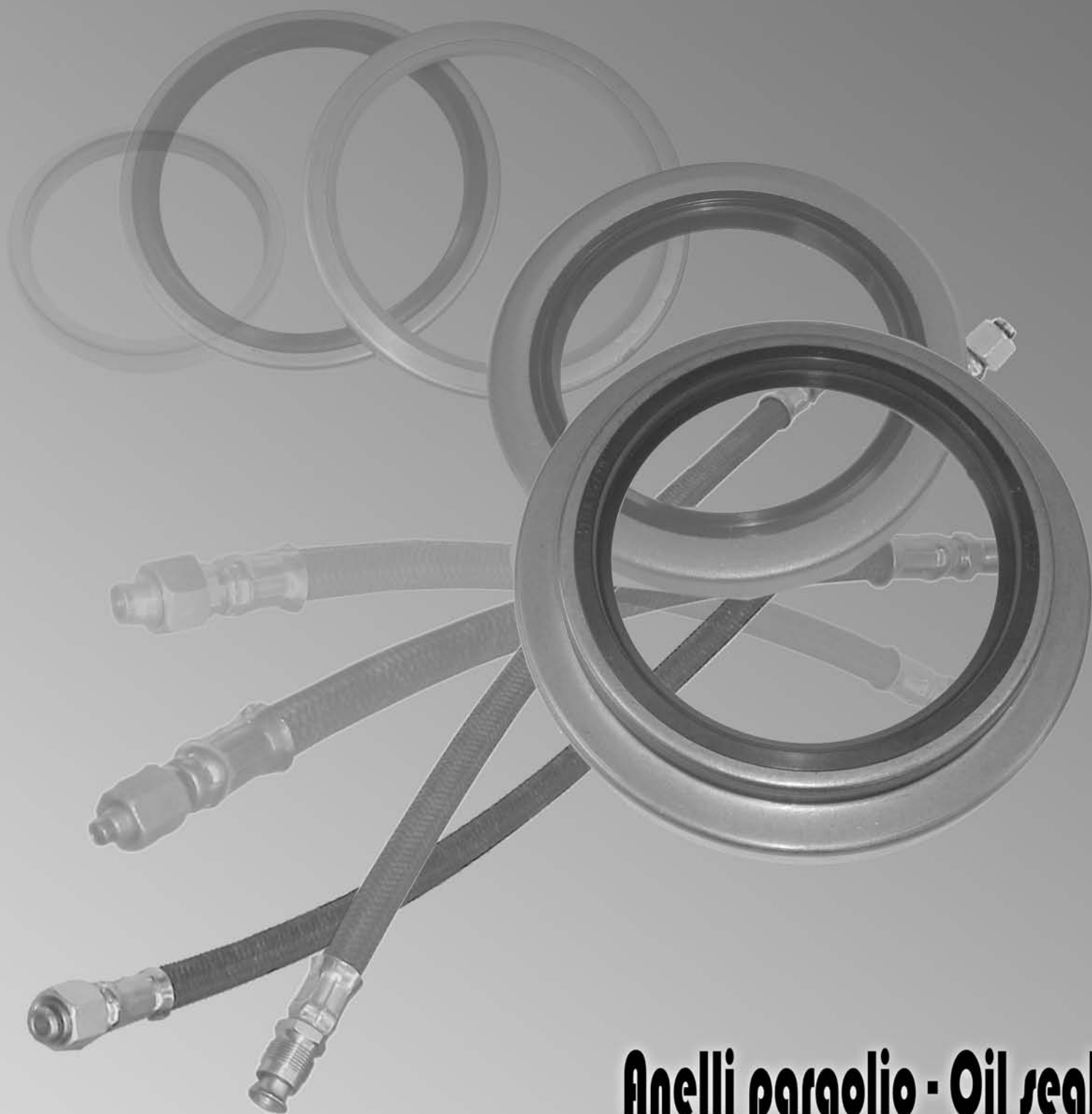



TECHNO
BRAKE®





Anelli paraolio - Oil seal
Articoli vari - Various articles



Tipo di materiale Materials type	Ns Riferim. Our Ref.	Rif. Costr. O.E. Ref.	Descrizione/Tipo di veicolo Description/Vehicle Type						
<p style="text-align: center;">NITRILE (NBR)</p>  <table border="1" data-bbox="84 629 611 730"> <thead> <tr> <th>Ø A mm.</th> <th>Ø B mm.</th> <th>H mm.</th> </tr> </thead> <tbody> <tr> <td>100</td> <td>135</td> <td>13 - 12</td> </tr> </tbody> </table> <p style="text-align: center;">AD ESAURIMENTO UNTILL OUT OF STOCK</p>	Ø A mm.	Ø B mm.	H mm.	100	135	13 - 12	101523	647330	<p><i>Paraolio mozzo anteriore Front wheel hub oil seal</i></p> <p>DAF 45</p>
Ø A mm.	Ø B mm.	H mm.							
100	135	13 - 12							
 <table border="1" data-bbox="84 1167 611 1267"> <thead> <tr> <th>Ø A mm.</th> <th>Ø B mm.</th> <th>H mm.</th> </tr> </thead> <tbody> <tr> <td>125</td> <td>160</td> <td>15/17</td> </tr> </tbody> </table> <p style="text-align: center;">AD ESAURIMENTO UNTILL OUT OF STOCK</p>	Ø A mm.	Ø B mm.	H mm.	125	160	15/17	101563	292766	<p><i>Paraolio mozzo Wheel hub oil seal</i></p> <p>DAF</p>
Ø A mm.	Ø B mm.	H mm.							
125	160	15/17							
 <table border="1" data-bbox="84 1659 611 1760"> <thead> <tr> <th>Ø A mm.</th> <th>Ø B mm.</th> <th>H mm.</th> </tr> </thead> <tbody> <tr> <td>160</td> <td>185</td> <td>14</td> </tr> </tbody> </table> <p style="text-align: center;">AD ESAURIMENTO UNTILL OUT OF STOCK</p>	Ø A mm.	Ø B mm.	H mm.	160	185	14	101564	259940 259939	<p><i>Paraolio mozzo Wheel hub oil seal</i></p> <p>DAF</p>
Ø A mm.	Ø B mm.	H mm.							
160	185	14							





Tipo di materiale Materials type	Ns Riferim. Our Ref.	Rif. Costr. O.E. Ref.	Descrizione/Tipo di veicolo Description/Vehicle Type						
<div style="text-align: center;">  <p>NITRILE (NBR)</p> <table border="1" data-bbox="82 616 612 719"> <thead> <tr> <th>Ø A mm.</th> <th>Ø B mm.</th> <th>H mm.</th> </tr> </thead> <tbody> <tr> <td>55</td> <td>80</td> <td>10</td> </tr> </tbody> </table> </div>	Ø A mm.	Ø B mm.	H mm.	55	80	10	<p>101400</p>	<p>93804576</p> <p>(M12011409)</p>	<p><i>Paraolio mozzo anteriore Front wheel hub oil seal</i></p> <p>New Daily 96 30.8-35.8-40.8 New Daily 96 35.10-45.10-49.10 Daily Restyling 30.8-35.8-40.8 Daily Restyling 35.10-45.10-49.10 Turbo Daily 96 35.10-35.12-49.12</p>
Ø A mm.	Ø B mm.	H mm.							
55	80	10							





Tipo di materiale Materials type			Ns Riferim. Our Ref.	Rif. Costr. O.E. Ref.	Descrizione/Tipo di veicolo Description/Vehicle Type			
			101565	40102093	Paraolio mozzo anteriore Front wheel hub oil seal Eurocargo Tector 100E21 - 140E24/E28 - 150E18/E24 180E24/E27 Eurotech Cursor 190E31/E35/E37 - 260E35 380E35/E37 - 720E37 Eurotrakker Cursor 190E38/E44 - 260E44 - 340E42 380E42/E44 - 410E44 - 440E38/E44 720E44			
						<table border="1"> <thead> <tr> <th>Ø A mm.</th> <th>Ø B mm.</th> <th>H mm.</th> </tr> </thead> <tbody> <tr> <td>60</td> <td>77</td> <td>13/16</td> </tr> </tbody> </table>	Ø A mm.	Ø B mm.
Ø A mm.	Ø B mm.	H mm.						
60	77	13/16						
			101566	40102503 40102113	Paraolio mozzo anteriore Front wheel hub oil seal Eurocargo Tector 100E21 - 140E24/E28 - 150E18/E24 180E24/E27 Eurotech Cursor 190E31/E35/E37 - 260E35 380E35/E37 - 720E37 Eurotrakker Cursor 190E38/E44 - 260E44 - 340E42 380E42/E44 - 410E44 - 440E38/E44 720E44			
						<table border="1"> <thead> <tr> <th>Ø A mm.</th> <th>Ø B mm.</th> <th>H mm.</th> </tr> </thead> <tbody> <tr> <td>66</td> <td>90</td> <td>10/13</td> </tr> </tbody> </table>	Ø A mm.	Ø B mm.
Ø A mm.	Ø B mm.	H mm.						
66	90	10/13						
POLIACRILICO - POLYACRIL (ACM)			101401	40100483	Paraolio mozzo posteriore Rear wheel hub oil seal New Daily 96 35.8-35.10 Turbo Daily 96 35.10-35.12 Eurocargo 60E10/E12/E14 65E10/E12/E14 75E12/E14/E15 80-100E15/E18/E21 180E21			
 <table border="1"> <thead> <tr> <th>Ø A mm.</th> <th>Ø B mm.</th> <th>H mm.</th> </tr> </thead> <tbody> <tr> <td>70</td> <td>90</td> <td>12</td> </tr> </tbody> </table>						Ø A mm.	Ø B mm.	H mm.
Ø A mm.	Ø B mm.	H mm.						
70	90	12						
VITON - VITON (FPM - FKM)			101402	40102273	Paraolio mozzo posteriore Rear wheel hub oil seal New Daily 96 30.8-35.8-35.10 Turbo Daily 96 35.10-35.12 Eurocargo 60E10/E12/E14 65E10/E12/E14 75E12/E14/E15 80-100E15/E18/E21 180E21			
 <table border="1"> <thead> <tr> <th>Ø A mm.</th> <th>Ø B mm.</th> <th>H mm.</th> </tr> </thead> <tbody> <tr> <td>70</td> <td>90</td> <td>13.5 - 14.5</td> </tr> </tbody> </table>						Ø A mm.	Ø B mm.	H mm.
Ø A mm.	Ø B mm.	H mm.						
70	90	13.5 - 14.5						





Tipo di materiale Materials type	Ns Riferim. Our Ref.	Rif. Costr. O.E. Ref.	Descrizione/Tipo di veicolo Description/Vehicle Type						
 <p>VITON - VITON (FPM - FKM)</p> <table border="1" data-bbox="82 640 612 743"> <thead> <tr> <th>Ø A mm.</th> <th>Ø B mm.</th> <th>H mm.</th> </tr> </thead> <tbody> <tr> <td>70</td> <td>100</td> <td>13.5</td> </tr> </tbody> </table>	Ø A mm.	Ø B mm.	H mm.	70	100	13.5	<p>101518</p>	<p>40102283</p>	<p><i>Paraolio mozzo posteriore interno</i> <i>Rear wheel oil seal hub int.side</i></p> <p>New Daily 35.8-35.10 45.10-49.10</p> <p>Turbo Daily 49.12</p>
Ø A mm.	Ø B mm.	H mm.							
70	100	13.5							
 <p>NITRILE (NBR)</p> <table border="1" data-bbox="82 1104 612 1207"> <thead> <tr> <th>Ø A mm.</th> <th>Ø B mm.</th> <th>H mm.</th> </tr> </thead> <tbody> <tr> <td>75</td> <td>100</td> <td>13</td> </tr> </tbody> </table>	Ø A mm.	Ø B mm.	H mm.	75	100	13	<p>101403</p>	<p>40001883 40001880</p>	<p><i>Paraolio mozzo anteriore</i> <i>Front wheel hub oil seal</i></p> <p>Zeta 50.9-65.9-79.14 95.14-109.14</p> <p>Turbozeta 60.11-65.12-79.12</p> <p>Turbotech 220.32-220.36</p>
Ø A mm.	Ø B mm.	H mm.							
75	100	13							
<p>VITON - VITON (FPM - FKM)</p>  <table border="1" data-bbox="82 1570 612 1673"> <thead> <tr> <th>Ø A mm.</th> <th>Ø B mm.</th> <th>H mm.</th> </tr> </thead> <tbody> <tr> <td>80</td> <td>110 - 115</td> <td>10 - 13</td> </tr> </tbody> </table>	Ø A mm.	Ø B mm.	H mm.	80	110 - 115	10 - 13	<p>101521</p>	<p>40102301</p>	<p><i>Paraolio mozzo anteriore</i> <i>Front wheel hub oil seal</i></p> <p>Eurocargo 120E15/E18/E23 260E23 120E21H 130E15/E18/E23 150E15/E18/E23 280E23 150E27 - 320E27</p>
Ø A mm.	Ø B mm.	H mm.							
80	110 - 115	10 - 13							
<p>POLIACRILICO - POLYACRIL (ACM)</p>  <table border="1" data-bbox="82 2038 612 2141"> <thead> <tr> <th>Ø A mm.</th> <th>Ø B mm.</th> <th>H mm.</th> </tr> </thead> <tbody> <tr> <td>80</td> <td>110</td> <td>13</td> </tr> </tbody> </table>	Ø A mm.	Ø B mm.	H mm.	80	110	13	<p>101600</p>	<p>40001670</p> <p>(M12011302)</p>	<p><i>Paraolio mozzo anteriore</i> <i>Front wheel hub oil seal</i></p> <p>Iveco 619 - 697 - 300</p>
Ø A mm.	Ø B mm.	H mm.							
80	110	13							



Tipo di materiale Materials type			Ns Riferim. Our Ref.	Rif. Costr. O.E. Ref.	Descrizione/Tipo di veicolo Description/Vehicle Type						
NITRILE (NBR)  <table border="1"> <thead> <tr> <th>Ø A mm.</th> <th>Ø B mm.</th> <th>H mm.</th> </tr> </thead> <tbody> <tr> <td>90</td> <td>110</td> <td>13</td> </tr> </tbody> </table>			Ø A mm.	Ø B mm.	H mm.	90	110	13	101404	40001903	Paraolio mozzo anteriore Front wheel hub oil seal Iveco 115 - 135.14/17 - 145.17
			Ø A mm.	Ø B mm.	H mm.						
90	110	13									
101404	40001903	Paraolio mozzo posteriore Rear wheel hub oil seal Zeta 50.9-65.9-79.14 Turbozeta 60.11-65.12-79.12									
VITON - VITON (FPM - FKM)  <table border="1"> <thead> <tr> <th>Ø A mm.</th> <th>Ø B mm.</th> <th>H mm.</th> </tr> </thead> <tbody> <tr> <td>95</td> <td>130</td> <td>16</td> </tr> </tbody> </table>			Ø A mm.	Ø B mm.	H mm.	95	130	16	101559	7185250	Paraolio mozzo anteriore Front wheel hub oil seal Eurotech 180-190-240-260-400-440 Eurotech Cursor 190-260-440 Eurotrakker 190-260-330-340-380 400-410-440-720 Eurotr. Cursor 190-260-340-380-410 Eurostar 180-190-240-260-400-440 Eurostar Cursor 190-260-440
			Ø A mm.	Ø B mm.	H mm.						
95	130	16									
101560	40102143	Paraolio mozzo posteriore Rear wheel hub oil seal Turbo Daily 96 59.12 Daily City 2000 65C13-65C15 Eurocargo 60E10/E12/E14 65E12/E14 75E12/E14/E15 80E15/E18/E21 85-95E18 100E15/E18/E21 180E21 170E15/E18/E23/E27									
NITRILE (NBR)  <table border="1"> <thead> <tr> <th>Ø A mm.</th> <th>Ø B mm.</th> <th>H mm.</th> </tr> </thead> <tbody> <tr> <td>100</td> <td>130</td> <td>14</td> </tr> </tbody> </table>			Ø A mm.	Ø B mm.	H mm.	100	130	14	101501	40100113	Paraolio mozzo posteriore lato esterno Rear wheel hub oil seal ext side IVECO 115.14/17 - 13514/17 Zeta 109.14
Ø A mm.	Ø B mm.	H mm.									
100	130	14									

Tipo di materiale Materials type	Ns Riferim. Our Ref.	Rif. Costr. O.E. Ref.	Descrizione/Tipo di veicolo Description/Vehicle Type						
<p style="text-align: center;">NITRILE (NBR)</p>  <table border="1" data-bbox="82 651 612 752"> <thead> <tr> <th>Ø A mm.</th> <th>Ø B mm.</th> <th>H mm.</th> </tr> </thead> <tbody> <tr> <td>110</td> <td>130</td> <td>13</td> </tr> </tbody> </table>	Ø A mm.	Ø B mm.	H mm.	110	130	13	<p>101405</p>	<p>40001030 (M12011364)</p>	<p><i>Paraolio mozzo anteriore Front wheel hub oil seal</i></p> <p>Fiat 100 - 110NC 645-650-662N1/N2/N3</p>
Ø A mm.	Ø B mm.	H mm.							
110	130	13							
<p style="text-align: center;">-</p>  <table border="1" data-bbox="82 1167 612 1267"> <thead> <tr> <th>Ø A mm.</th> <th>Ø B mm.</th> <th>H mm.</th> </tr> </thead> <tbody> <tr> <td>114</td> <td>152</td> <td>10,2/14</td> </tr> </tbody> </table>	Ø A mm.	Ø B mm.	H mm.	114	152	10,2/14	<p>101551</p>	<p>40102321</p>	<p><i>Paraolio mozzo posteriore Rear wheel hub oil seal</i></p> <p>Eurocargo 120E15/E18/E23 130E15/E18/E23 170E15/E18/E23 260E23</p>
Ø A mm.	Ø B mm.	H mm.							
114	152	10,2/14							
<p style="text-align: center;">NITRILE (NBR)</p>  <table border="1" data-bbox="82 1693 612 1794"> <thead> <tr> <th>Ø A mm.</th> <th>Ø B mm.</th> <th>H mm.</th> </tr> </thead> <tbody> <tr> <td>118</td> <td>136</td> <td>13</td> </tr> </tbody> </table>	Ø A mm.	Ø B mm.	H mm.	118	136	13	<p>101513</p>	<p>40001060 (M12011347)</p>	<p><i>Paraolio posteriore lato esterno Rear wheel hub oil seal ext. side</i></p> <p>Iveco 79-80-90-100.13 110/130NC - 110.14</p>
Ø A mm.	Ø B mm.	H mm.							
118	136	13							

Tipo di materiale Materials type			Ns Riferim. Our Ref.	Rif. Costr. O.E. Ref.	Descrizione/Tipo di veicolo Description/Vehicle Type
VITON - VITON (FPM - FKM)			101550	40102333	Paraolio mozzo posteriore Rear wheel hub oil seal Eurocargo 130E18 150E15/E18/E23/E27 170E15/E18/E23/E27 280E23 - 320E27 Eurotech 180E24/E27/E30 180E34/E38/E42 240E34/E38/E42 325E27 400E30/E34/E38/E42 440E38/E42 Eurot. Cursor 260E24 - 260E31/E35 Eurostar 240E38/E42/E47/E52 260E42/E47/E52 400E38/E42/E47/E52 440E42/E47/E52 Eurorider
					
Ø A mm.	Ø B mm.	H mm.			
121	170	15,5/17			
NITRILE (NBR)			101406	40001933	Paraolio mozzo anteriore Front wheel hub oil seal Iveco 175.24 - 260.36/48 Turbostar 190.36/42/48 240.36/48 Turbotech 190.24/26/30/32/36 220.32/36 - 240.26 260.32/36 330.30/35/36
					
Ø A mm.	Ø B mm.	H mm.			
125	150	13			
			101567	40102103	Paraolio mozzo anteriore Front wheel hub oil seal Eurocargo Tector 100E21 - 140E24/E28 - 150E18/E24 180E24/E27 Eurotech Cursor 190E31/E35/E37 - 260E35 380E35/E37 - 720E37 Eurotrakker Cursor 190E38/E44 - 260E44 - 340E42 380E42/E44 - 410E44 - 440E38/E44 720E44
					
Ø A mm.	Ø B mm.	H mm.			
128	144/152,30	11/25			

			Ns Riferim. Our Ref.	Rif. Costr. O.E. Ref.	Descrizione/Tipo di veicolo Description/Vehicle Type
NITRILE (NBR) 			101514	40001050 (M12011372)	Paraolio mozzo posteriore lato interno Rear wheel hub oil seal int. side Fiat 100 - 110 - 130NC
Ø A mm.	Ø B mm.	H mm.			
135	162	13			
POLIACRILICO - POLYACRIL (ACM) 			101502	40100103 40100100 (M12011593)	Paraolio posteriore lato esterno Rear wheel hub oil seal ext. side Iveco 175.17 - 175.24 - 145.17
Ø A mm.	Ø B mm.	H mm.			
140	160	14			
POLIACRILICO - POLYACRIL (ACM) 			101509	40000950 (M12011278)	Paraolio mozzo posteriore lato esterno Rear wheel hub oil seal ext. side IVECO 170.33/35 619N1-697-300-180NC 684NP - 682N4
Ø A mm.	Ø B mm.	H mm.			
150	168	13			
VITON - VITON 			101027	40101113	Paraolio mozzo posteriore Rear wheel hub oil seal Eurocargo 95-100E15/E18/E21 Eurocargo Tector
Ø A mm.	Ø B mm.	H mm.			
128	148	132			





Tipo di materiale Materials type			Ns Riferim. Our Ref.	Rif. Costr. O.E. Ref.	Descrizione/Tipo di veicolo Description/Vehicle Type						
<p>VITON (FPM - FKM)</p>  <table border="1"> <thead> <tr> <th>Ø A mm.</th> <th>Ø B mm.</th> <th>H mm.</th> </tr> </thead> <tbody> <tr> <td>179</td> <td>200</td> <td>15,7</td> </tr> </tbody> </table>			Ø A mm.	Ø B mm.	H mm.	179	200	15,7	101511	40102941	<p>Paraolio mozzo posteriore lato esterno Rear wheel hub oil seal ext. side</p> <p>Eurotech 190E24/E38/E42 - 240E34/E38/E42 400E38 - 440E38</p> <p>Eurostar 190E42/E47</p> <p>Eurotrakker 190E30/E34/E42 - 400E42 - 440E34</p>
Ø A mm.	Ø B mm.	H mm.									
179	200	15,7									
<p>NITRILE (NBR)</p>  <table border="1"> <thead> <tr> <th>Ø A mm.</th> <th>Ø B mm.</th> <th>H mm.</th> </tr> </thead> <tbody> <tr> <td>180</td> <td>200</td> <td>12</td> </tr> </tbody> </table>			Ø A mm.	Ø B mm.	H mm.	180	200	12	101519	42127526	<p>Paraolio mozzo posteriore lato esterno Rear wheel hub oil seal ext. side</p> <p>Turbostar 190.36/42/48-240.36/48 260.36/48</p> <p>Turbotech 190.24/26/30/32/36 220-240-260-330.36</p> <p>Eurocargo 170E23</p> <p>Eurotech Eurostar Eurotrakker Cursor</p> <p>(M12012049)</p>
Ø A mm.	Ø B mm.	H mm.									
180	200	12									
<p>NITRILE (NBR)</p>  <table border="1"> <thead> <tr> <th>Ø A mm.</th> <th>Ø B mm.</th> <th>H mm.</th> </tr> </thead> <tbody> <tr> <td>180</td> <td>200</td> <td>15</td> </tr> </tbody> </table>			Ø A mm.	Ø B mm.	H mm.	180	200	15	101510	40000690	<p>Paraolio mozzo posteriore lato interno Rear wheel hub oil seal int. side</p> <p>(M12011379) IVECO 170.33/35 619N1-697-300-180NC 684NP - 682N4</p>
Ø A mm.	Ø B mm.	H mm.									
180	200	15									
<p>NITRILE (NBR)</p>  <table border="1"> <thead> <tr> <th>Ø A mm.</th> <th>Ø B mm.</th> <th>H mm.</th> </tr> </thead> <tbody> <tr> <td>180</td> <td>200</td> <td>12</td> </tr> </tbody> </table>			Ø A mm.	Ø B mm.	H mm.	180	200	12	101506	40100443 40003720	<p>Paraolio mozzo posteriore lato esterno Rear wheel hub oil seal ext. side</p> <p>(M12011378) IVECO 175.24 Turbostar 190-240-260 Turbotech 190-220-240-260-330 Eurocargo Eurotech Eurotrakker Eurotrakker Cursor</p>
Ø A mm.	Ø B mm.	H mm.									
180	200	12									



Tipo di materiale Materials type			Ns Riferim. Our Ref.	Rif. Costr. O.E. Ref.	Descrizione/Tipo di veicolo Description/Vehicle Type						
<p>VITON (FPM - FKM)</p>  <table border="1"> <thead> <tr> <th>Ø A mm.</th> <th>Ø B mm.</th> <th>H mm.</th> </tr> </thead> <tbody> <tr> <td>180</td> <td>200</td> <td>12</td> </tr> </tbody> </table>			Ø A mm.	Ø B mm.	H mm.	180	200	12	101507	40100673 40003730 (M12011326)	<p>Paraolio mozzo posteriore lato interno Rear wheel hub oil seal int. side</p> <p>IVECO 175.24 Turbostar 190-240-260 Turbotech 190-220-240-260-330 Eurocargo Eurotech Eurotrakker Eurotrakker Cursor</p>
Ø A mm.	Ø B mm.	H mm.									
180	200	12									
<p>-</p>  <table border="1"> <thead> <tr> <th>Ø A mm.</th> <th>Ø B mm.</th> <th>H mm.</th> </tr> </thead> <tbody> <tr> <td>180</td> <td>200</td> <td>13.5</td> </tr> </tbody> </table>			Ø A mm.	Ø B mm.	H mm.	180	200	13.5	101512	42127773	<p>Paraolio mozzo posteriore Rear wheel hub oil seal</p> <p>IVECO</p>
Ø A mm.	Ø B mm.	H mm.									
180	200	13.5									
<p>NITRILE (NBR)</p>  <table border="1"> <thead> <tr> <th>Ø A mm.</th> <th>Ø B mm.</th> <th>H mm.</th> </tr> </thead> <tbody> <tr> <td>180</td> <td>200</td> <td>17</td> </tr> </tbody> </table>			Ø A mm.	Ø B mm.	H mm.	180	200	17	101508	40101733	<p>Paraolio mozzo posteriore UT lato esterno ed interno Rear wheel hub oil seal LM ext./int.side</p> <p>IVECO 175.24 Turbostar 190-240-260 Turbotech 190-220-240-260-330 Eurocargo Eurotech Eurotrakker Eurotrakker Cursor</p>
Ø A mm.	Ø B mm.	H mm.									
180	200	17									





**ANELLI PARAOLI
OIL SEAL**

EMMERRE



			Ns Riferim. Our Ref.	Rif. Costr. O.E. Ref.	Descrizione/Tipo di veicolo Description/Vehicle Type						
<p>CUOIO - LEATHER (F)</p>  <table border="1"> <thead> <tr> <th>Ø A mm.</th> <th>Ø B mm.</th> <th>H mm.</th> </tr> </thead> <tbody> <tr> <td>136</td> <td>190</td> <td>27</td> </tr> </tbody> </table>			Ø A mm.	Ø B mm.	H mm.	136	190	27	931320	4460212	<p>Paraolio STEMCO STEMKO oil seal</p> <p>Iveco 190 - 330</p>
Ø A mm.	Ø B mm.	H mm.									
136	190	27									
<p>CUOIO - LEATHER (F)</p>  <table border="1"> <thead> <tr> <th>Ø A mm.</th> <th>Ø B mm.</th> <th>H mm.</th> </tr> </thead> <tbody> <tr> <td>117</td> <td>152</td> <td>21</td> </tr> </tbody> </table>			Ø A mm.	Ø B mm.	H mm.	117	152	21	931317	2475977	<p>Paraolio STEMCO STEMKO oil seal</p> <p>Iveco 190-330.30H 190-330.26H 330.30 AN 190 PAC</p> <p>Astra</p>
Ø A mm.	Ø B mm.	H mm.									
117	152	21									
<p>CUOIO - LEATHER (F)</p>  <table border="1"> <thead> <tr> <th>Ø A mm.</th> <th>Ø B mm.</th> <th>H mm.</th> </tr> </thead> <tbody> <tr> <td>120,65</td> <td>152,20</td> <td>27</td> </tr> </tbody> </table>			Ø A mm.	Ø B mm.	H mm.	120,65	152,20	27	931315	8123663 9881554	<p>Paraolio STEMCO STEMKO oil seal</p> <p>Iveco 130NC Ponte Eaton</p>
Ø A mm.	Ø B mm.	H mm.									
120,65	152,20	27									

Tipo di materiale Materials type			Ns Riferim. Our Ref.	Rif. Costr. O.E. Ref.	Descrizione/Tipo di veicolo Description/Vehicle Type
			101612	8870829 42534932	Paraolio scatola cambio Gear box oil seal Daily City 2000 35S13/S15 - 35C13/C15 50C11/C13/C15 - 65C11/C13/C15
Ø A mm.	Ø B mm.	H mm.			
-	-	-			
NITRILE (NBR)			101609	595985	Paraolio scatola cambio Gear box oil seal Zeta 50.9 - 65.9
					
Ø A mm.	Ø B mm.	H mm.			
35	55	10	(M12011496)		
POLIACRILICO - POLYACRIL (ACM)			101608	40000583	Paraolio scatola cambio Gear box oil seal Turbozeta 65.12 - 79.12 Zeta 79.14 80-90-110NC 115.14/17
					
Ø A mm.	Ø B mm.	H mm.			
42	62	10			
AD ESAURIMENTO UNTILL OUT OF STOCK					
NITRILE (NBR)			101606	40001320 543637	Paraolio scatola cambio Gear box oil seal Fiat OM
					
Ø A mm.	Ø B mm.	H mm.			
50	80	13	(M12011281)		
POLIACRILICO - POLYACRIL (ACM)			101607	40000490	Paraolio scatola cambio Gear box oil seal Fiat 682 - 690
					
Ø A mm.	Ø B mm.	H mm.			
55	72	12	(M12011466)		
AD ESAURIMENTO UNTILL OUT OF STOCK					

Tipo di materiale Materials type	Ns Riferim. Our Ref.	Rif. Costr. O.E. Ref.	Descrizione/Tipo di veicolo Description/Vehicle Type						
<p>POLIACRILICO - POLYACRIL (ACM)</p>  <table border="1" data-bbox="81 656 611 757"> <thead> <tr> <th>Ø A mm.</th> <th>Ø B mm.</th> <th>H mm.</th> </tr> </thead> <tbody> <tr> <td>55</td> <td>80</td> <td>10</td> </tr> </tbody> </table>	Ø A mm.	Ø B mm.	H mm.	55	80	10	<p>101605</p>	<p>40000520 543637</p> <p>(M12011282)</p>	<p>Paraolio scatola cambio Gear box oil seal</p> <p>IVECO 80 - 90 - 110NC 684 - 160</p>
Ø A mm.	Ø B mm.	H mm.							
55	80	10							
<p>POLIACRILICO - POLYACRIL (ACM)</p>  <table border="1" data-bbox="81 1122 611 1223"> <thead> <tr> <th>Ø A mm.</th> <th>Ø B mm.</th> <th>H mm.</th> </tr> </thead> <tbody> <tr> <td>62</td> <td>80</td> <td>10</td> </tr> </tbody> </table>	Ø A mm.	Ø B mm.	H mm.	62	80	10	<p>101603</p>	<p>40000283 40000280</p> <p>(M12011433)</p>	<p>Paraolio scatola cambio Gear box oil seal</p> <p>OM 40/35 50-60-70-75-79.14 80-90-100NC 115-135.14/17</p>
Ø A mm.	Ø B mm.	H mm.							
62	80	10							
<p>POLIACRILICO - POLYACRIL (ACM)</p>  <table border="1" data-bbox="81 1597 611 1697"> <thead> <tr> <th>Ø A mm.</th> <th>Ø B mm.</th> <th>H mm.</th> </tr> </thead> <tbody> <tr> <td>70</td> <td>100</td> <td>12</td> </tr> </tbody> </table>	Ø A mm.	Ø B mm.	H mm.	70	100	12	<p>101602</p>	<p>40000410</p> <p>(M12011439)</p>	<p>Paraolio scatola cambio Gear box oil seal</p> <p>682 - 690 - 684 - 160NC</p>
Ø A mm.	Ø B mm.	H mm.							
70	100	12							



Tipo di materiale Materials type			Ns Riferim. Our Ref.	Rif. Costr. O.E. Ref.	Descrizione/Tipo di veicolo Description/Vehicle Type						
POLIACRILICO - POLYACRIL (ACM)  <table border="1"> <thead> <tr> <th>Ø A mm.</th> <th>Ø B mm.</th> <th>H mm.</th> </tr> </thead> <tbody> <tr> <td>75</td> <td>105</td> <td>12</td> </tr> </tbody> </table>			Ø A mm.	Ø B mm.	H mm.	75	105	12	101601	40000610 (M12011298)	Paraolio scatola cambio Gear box oil seal 619 - 697 - 300
Ø A mm.	Ø B mm.	H mm.									
75	105	12									
POLIACRILICO - POLYACRIL (ACM)  <table border="1"> <thead> <tr> <th>Ø A mm.</th> <th>Ø B mm.</th> <th>H mm.</th> </tr> </thead> <tbody> <tr> <td>76,20</td> <td>101,60</td> <td>11,10/9,50</td> </tr> </tbody> </table>			Ø A mm.	Ø B mm.	H mm.	76,20	101,60	11,10/9,50	101610	8121803 (M12012293)	Paraolio anteriore scatola cambio Fuller Fuller gear box oil seal Turbostar 190.36/42/48 24036/48 - 260.36/48 Turbotech 190.26/30/32/36 220.32/36 - 240.26 260.36 330.26/30/35/36 Eurotech - Eurotrakker - Eurostar
Ø A mm.	Ø B mm.	H mm.									
76,20	101,60	11,10/9,50									
POLIACRILICO - POLYACRIL (ACM)  <table border="1"> <thead> <tr> <th>Ø A mm.</th> <th>Ø B mm.</th> <th>H mm.</th> </tr> </thead> <tbody> <tr> <td>80</td> <td>110</td> <td>13</td> </tr> </tbody> </table>			Ø A mm.	Ø B mm.	H mm.	80	110	13	101600	40001670 (12011302)	Paraolio scatola cambio Gear box oil seal 619 - 697 - 300
Ø A mm.	Ø B mm.	H mm.									
80	110	13									
VITON (FPM)  <table border="1"> <thead> <tr> <th>Ø A mm.</th> <th>Ø B mm.</th> <th>H mm.</th> </tr> </thead> <tbody> <tr> <td>95,30</td> <td>114,30</td> <td>11,90</td> </tr> </tbody> </table>			Ø A mm.	Ø B mm.	H mm.	95,30	114,30	11,90	101611	1905085 (M12012235)	Paraolio posteriore scatola cambio Fuller Fuller gear box oil seal Turbostar 190.36/42/48 24036/48 - 260.36/48 Turbotech 190.26/30/32/36 220.32/36 - 240.26 260.36 330.26/30/35/36 Eurotech - Eurotrakker - Eurostar
Ø A mm.	Ø B mm.	H mm.									
95,30	114,30	11,90									

			Ns Riferim. Our Ref.	Rif. Costr. O.E. Ref.	Descrizione/Tipo di veicolo Description/Vehicle Type
-			101517	40102263	Paraolio differenziale Differential oil seal Daily T.T. Eurotrakker 260E30/E34/E37/E42 440E37 340E34/E37/E42 Eurotrakker 260E35 - 340E35 Cursor
					
Ø A mm.	Ø B mm.	H mm.			
60	90	14/16			
			101581	40102133 40100453	Paraolio differenziale Differential oil seal Turbodaily 59.12 Eurocargo 60E10/E12/E14 - 65E10/E12/E14 75E12/E14/E15 - 80E15/E18/E21 85E15100E15/E18/E21 95E18 - 180E21
					
Ø A mm.	Ø B mm.	H mm.			
65	100	14			
POLIACRILICO - POLYACRIL (ACM) 			101545	40002160 (M12011302)	Paraolio pignone conico differenziale con zigrinatura Differential oil seal 619 - 696 - 300 682N3/NA
					
Ø A mm.	Ø B mm.	H mm.			
80	110	13			
			101582	40102053	Paraolio ripartitore Oil seal 330.26 - 330.30 - 330.35 - 330.36
					
Ø A mm.	Ø B mm.	H mm.			
85	110	14			
AD ESAURIMENTO UNTILL OUT OF STOCK					

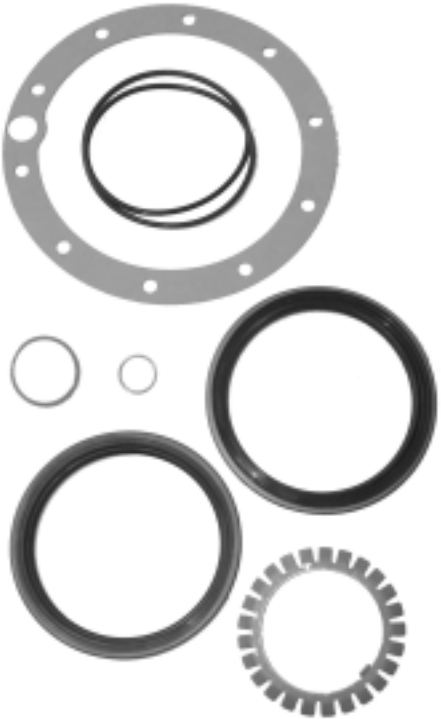
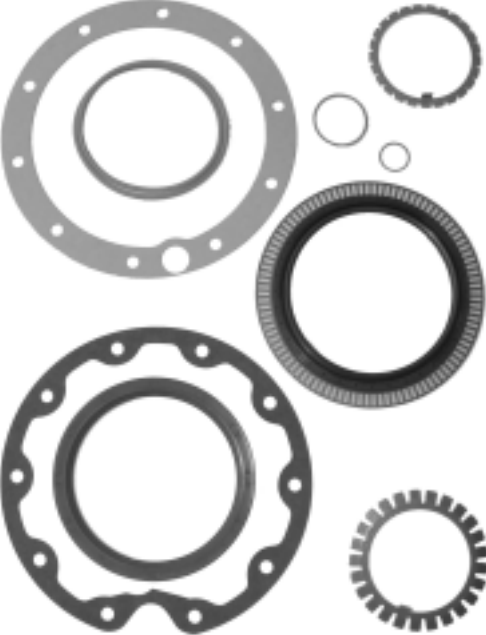
			Ns Riferim. Our Ref.	Rif. Costr. O.E. Ref.	Descrizione/Tipo di veicolo Description/Vehicle Type			
			101583	40101623	Paraolio differenziale <i>Differential oil seal</i> Eurotrakker 190E30/E31/E34/E37/E42 260E30/E34/E37/E42 330E34/E37 - 380E31/E34/E37/E42 400E31/E34/E37/E42 - 410E37/E42 720E31/E37/E42			
<table border="1"> <thead> <tr> <th>Ø A mm.</th> <th>Ø B mm.</th> <th>H mm.</th> </tr> </thead> <tbody> <tr> <td style="text-align: center;">90</td> <td style="text-align: center;">130</td> <td style="text-align: center;">14</td> </tr> </tbody> </table>	Ø A mm.	Ø B mm.				H mm.	90	130
Ø A mm.	Ø B mm.	H mm.						
90	130	14						
NITRILE (NBR) 			101584	42031684 (M12014463)	Paraolio interno per supporto bilancere <i>Oil seal int side</i> 330.26 - 330.30 - 330.35 - 330.36			
<table border="1"> <thead> <tr> <th>Ø A mm.</th> <th>Ø B mm.</th> <th>H mm.</th> </tr> </thead> <tbody> <tr> <td style="text-align: center;">125</td> <td style="text-align: center;">160</td> <td style="text-align: center;">15</td> </tr> </tbody> </table>	Ø A mm.	Ø B mm.				H mm.	125	160
Ø A mm.	Ø B mm.	H mm.						
125	160	15						
AD ESAURIMENTO UNTILL OUT OF STOCK								
NITRILE (NBR) 			101522	40101540	Paraolio interno per supporto bilancere <i>Oil seal int side</i> Eurotrakker 330E34/E37 380E31/E34/E37/E42 410E37/E42 720E31/E37/E42			
<table border="1"> <thead> <tr> <th>Ø A mm.</th> <th>Ø B mm.</th> <th>H mm.</th> </tr> </thead> <tbody> <tr> <td style="text-align: center;">166</td> <td style="text-align: center;">186</td> <td style="text-align: center;">15/23</td> </tr> </tbody> </table>	Ø A mm.	Ø B mm.				H mm.	166	186
Ø A mm.	Ø B mm.	H mm.						
166	186	15/23						

Tipo di materiale Materials type	Ns Riferim. Our Ref.	Rif. Costr. O.E. Ref.	Descrizione/Tipo di veicolo Description/Vehicle Type
	101568	6243560080S	<p><i>Kit paraolio assale posteriore composto da:</i> <i>Rear axle oil seals kit complete of:</i></p> <p><i>Disco dentato / Plate wheel</i> Nr. 1 <i>Anello di tenuta / Sealing Ring</i> Nr. 1 <i>Paraolio mozzo ruota / Wheel hub oil seal</i> Nr. 1 <i>Anello di tenuta / Sealing ring</i> Nr. 1 <i>Guarnizione cambio / Gear gasket</i> Nr. 1 <i>Anello di tenuta rame / Copper sealing ring</i> Nr. 1 <i>Anello di tenuta alluminio / Aluminium sealing ring</i> Nr. 1</p> <p>MAN TG-A F90 - F2000 M90 - M2000 - L2000 G90 - LION'S STAR-LION'S COACH NG - NL - NM SG - SL</p>
	101569	6593500135S	<p><i>Kit paraolio assale posteriore composto da:</i> <i>Rear kit oil seal complete of:</i></p> <p><i>Disco dentato / Plate wheel</i> Nr. 1 <i>Disco dentato / Plate wheel</i> Nr. 1 <i>Anello di tenuta / Sealing ring</i> Nr. 1 <i>Paraolio mozzo ruota / Wheel hub oil seal</i> Nr. 1 <i>Anello di tenuta / Sealing ring</i> Nr. 1 <i>Guarnizione cambio / Gear gasket</i> Nr. 1 <i>Guarnizione cambio / Gear gasket</i> Nr. 1 <i>Guarnizione cambio / Gear gasket</i> Nr. 1 <i>Anello di tenuta rame / Copper sealing ring</i> Nr. 1 <i>Anello di tenuta alluminio / Aluminium sealing ring</i> Nr. 1</p> <p>MAN TG-A F90 - F2000 M90 - M2000 - L2000 G90 - LION'S STAR-LION'S COACH NG - NL - NM SG - SL</p>





Tipo di materiale Materials type	Ns Riferim. Our Ref.	Rif. Costr. O.E. Ref.	Descrizione/Tipo di veicolo Description/Vehicle Type						
<p style="text-align: center;">NITRILE (NBR)</p>  <table border="1" data-bbox="82 815 612 916"> <thead> <tr> <th>Ø A mm.</th> <th>Ø B mm.</th> <th>H mm.</th> </tr> </thead> <tbody> <tr> <td>125</td> <td>150</td> <td>13</td> </tr> </tbody> </table>	Ø A mm.	Ø B mm.	H mm.	125	150	13	<p style="text-align: center;">101570</p>	<p>06562890038</p> <p>(M12011419)</p>	<p><i>Paraolio mozzo posteriore</i> <i>Rear wheel hub oil seal</i></p> <p>MAN</p>
Ø A mm.	Ø B mm.	H mm.							
125	150	13							

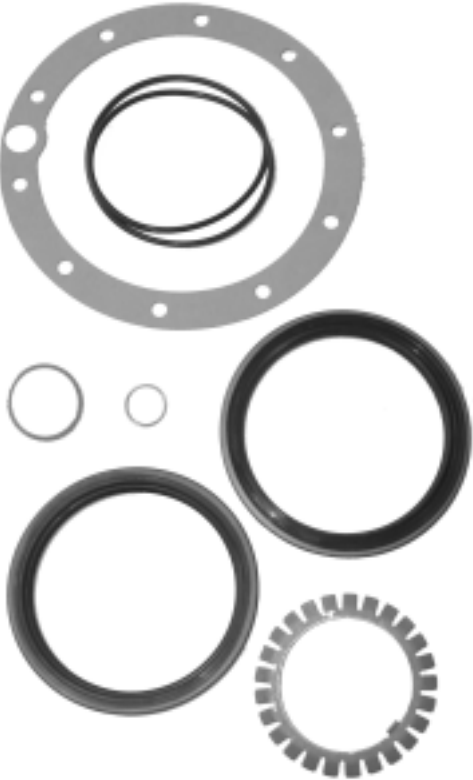

Tipo di materiale Materials type			Ns Riferim. Our Ref.	Rif. Costr. O.E. Ref.	Descrizione/Tipo di veicolo Description/Vehicle Type			
NITRILE (NBR) 			101403	0029978447 0029978547	Paraolio mozzo anteriore e posteriore <i>Front and rear wheel hub oil seal</i> Mercedes 809 - 811 - 813 - 814 - 817 913 - 914 - 917 1013 - 1017 - 1114 - 1117 - 1120			
<table border="1"> <thead> <tr> <th>Ø A mm.</th> <th>Ø B mm.</th> <th>H mm.</th> </tr> </thead> <tbody> <tr> <td style="text-align: center;">75</td> <td style="text-align: center;">100</td> <td style="text-align: center;">13</td> </tr> </tbody> </table>	Ø A mm.	Ø B mm.				H mm.	75	100
Ø A mm.	Ø B mm.	H mm.						
75	100	13						
VITON (FPM - FKM) 			101515	0139979447 (M12014739)	Paraolio mozzo posteriore lato interno <i>Rear wheel hub oil seal int. side</i> Actros (1996) 1831 - 1835 - 1840 - 1843 - 1848 1853 - 1857 2031 - 2040 - 2053 2531 - 2535 - 2540 - 2543 - 2548 2553 - 2557 - 2631 NG-SK			
<table border="1"> <thead> <tr> <th>Ø A mm.</th> <th>Ø B mm.</th> <th>H mm.</th> </tr> </thead> <tbody> <tr> <td style="text-align: center;">145</td> <td style="text-align: center;">175</td> <td style="text-align: center;">13</td> </tr> </tbody> </table>	Ø A mm.	Ø B mm.				H mm.	145	175
Ø A mm.	Ø B mm.	H mm.						
145	175	13						
NITRILE (NBR) 			101516	0169975647 (M12014740)	Paraolio mozzo posteriore lato esterno <i>Rear wheel hub oil seal ext. side</i> Actros (1996) 1831 - 1835 - 1840 - 1843 - 1848 1853 - 1857 2031 - 2040 - 2053 2531 - 2535 - 2540 - 2543 - 2548 2553 - 2557 - 2631 NG-SK			
<table border="1"> <thead> <tr> <th>Ø A mm.</th> <th>Ø B mm.</th> <th>H mm.</th> </tr> </thead> <tbody> <tr> <td style="text-align: center;">145</td> <td style="text-align: center;">175</td> <td style="text-align: center;">14</td> </tr> </tbody> </table>	Ø A mm.	Ø B mm.				H mm.	145	175
Ø A mm.	Ø B mm.	H mm.						
145	175	14						





Tipo di materiale Materials type	Ns Riferim. Our Ref.	Rif. Costr. O.E. Ref.	Descrizione/Tipo di veicolo Description/Vehicle Type						
<p style="text-align: center;">VITON (FPM)</p>  <table border="1" data-bbox="81 1095 609 1198"> <thead> <tr> <th>Ø A mm.</th> <th>Ø B mm.</th> <th>H mm.</th> </tr> </thead> <tbody> <tr> <td>145</td> <td>175</td> <td>17/21</td> </tr> </tbody> </table>	Ø A mm.	Ø B mm.	H mm.	145	175	17/21	<p>101571</p>	<p>0209973947</p> <p>(M01019352)</p>	<p><i>Paraolio mozzo posteriore</i> <i>Rear wheel hub oil seal</i></p> <p>Atego II 1823 - 1828 - 2523 - 2628</p> <p>Actros (1996) 1831 - 1835 - 1840 - 1843 - 1848 1853 - 1857 - 2031 - 2035 - 2040 2053 - 2531 - 2535 - 2540 - 2543 2548 - 2553 - 2557 - 2631 - 2635 2640 - 2643 - 2648 - 2653 - 2657 3231 - 3235 - 3240 - 3243 - 3331 3335 - 3340 - 3343 - 3346 - 3348 3357 - 4140 - 4143 - 4148</p> <p>Actros (2003) 1832 - 1836 - 1841 - 1844 - 1846 1850 - 1854 - 1858 - 2632 - 2636 2641 - 2644 - 2650 - 2654 - 2658</p> <p>Axor 1823 - 1835 - 1840 2523 - 2628 - 3228</p> <p>LK - MK - NG - SK (tutti i tipi - all types)</p>
Ø A mm.	Ø B mm.	H mm.							
145	175	17/21							



Tipo di materiale Materials type	Ns Riferim. Our Ref.	Rif. Costr. O.E. Ref.	Descrizione/Tipo di veicolo Description/Vehicle Type
	101568	9403500335	<p>Kit paraolio assale posteriore composto da: Rear kit oil seal complete of:</p> <p><i>Disco dentato / Plate wheel</i> Nr. 1 <i>Anello di tenuta / Sealing wheel</i> Nr. 1 <i>Paraolio mozzo ruota / Wheel hub oil seal</i> Nr. 1 <i>Anello di tenuta / Sealing ring</i> Nr. 1 <i>Guarnizione cambio / Gear gasket</i> Nr. 1 <i>Anello di tenuta rame / Copper sealing ring</i> Nr. 1 <i>Anello di tenuta alluminio / Aluminium sealing ring</i> Nr. 1</p> <p>Atego I 712 - 812 - 815 - 817 - 823 - 917 923 - 925 - 1017 - 1023 - 1215 1217 - 1223 - 1225 - 1317 - 1323 1325 - 1328 - 1517 - 1523 - 1525 1528</p> <p>Atego II 1823 - 1828 - 2523 - 2528 - 2628</p> <p>Actros (1996) 1831 - 1835 - 1840 - 1843 - 1848 1853 - 1857 - 2031 - 2040 - 2053 2531 - 2535 - 2540 - 2543 - 2548 2553 - 2631 - 2635 - 2640 - 2643 2648 - 2653 - 2657 - 3231 - 3235 3240 - 3243 - 3331 - 3335 - 3340 3343 - 3348 - 3353 - 3357 - 4140 4143 - 4148</p> <p>LK - LP SK - MK - NG (tutti i tipi - all types)</p> <p>BUS O 303 - O 305 - O 307 O 402 - O 404 - O405</p> <p>Unimog</p>



Tipo di materiale Materials type	Ns Riferim. Our Ref.	Rif. Costr. O.E. Ref.	Descrizione/Tipo di veicolo Description/Vehicle Type																				
	<p>101569</p>	<p>9403500035</p>	<p>Kit paraolio assale posteriore composto da: Rear axle oil seal kit complete of:</p> <table border="0"> <tr> <td><i>Disco dentato / Plate wheel</i></td> <td style="text-align: right;">Nr. 1</td> </tr> <tr> <td><i>Disco dentato / Plate wheel</i></td> <td style="text-align: right;">Nr. 1</td> </tr> <tr> <td><i>Anello di tenuta / Sealing ring</i></td> <td style="text-align: right;">Nr. 1</td> </tr> <tr> <td><i>Paraolio mozzo ruota / Wheel hub oil seal</i></td> <td style="text-align: right;">Nr. 1</td> </tr> <tr> <td><i>Anello di tenuta / Sealing ring</i></td> <td style="text-align: right;">Nr. 1</td> </tr> <tr> <td><i>Guarnizione cambio / Gear gasket</i></td> <td style="text-align: right;">Nr. 1</td> </tr> <tr> <td><i>Guarnizione cambio / Gear gasket</i></td> <td style="text-align: right;">Nr. 1</td> </tr> <tr> <td><i>Guarnizione cambio / Gear gasket</i></td> <td style="text-align: right;">Nr. 1</td> </tr> <tr> <td><i>Anello di tenuta rame / Copper sealing ring</i></td> <td style="text-align: right;">Nr. 1</td> </tr> <tr> <td><i>Anello di tenuta alluminio / Aluminium sealing ring</i></td> <td style="text-align: right;">Nr. 1</td> </tr> </table> <p>Atego I 712 - 812 - 815 - 817 - 823 - 917 923 - 925 - 1017 - 1023 - 1215 1217 - 1223 - 1225 - 1317 - 1323 1325 - 1328 - 1517 - 1523 - 1525 1528</p> <p>Atego II 1823 - 1828 - 2523 - 2528 - 2628</p> <p>Actros (1996) 1831 - 1835 - 1840 - 1843 - 1848 1853 - 1857 - 2031 - 2040 - 2053 2531 - 2535 - 2540 - 2543 - 2548 2553 - 2631 - 2635 - 2640 - 2643 2648 - 2653 - 2657 - 3231 - 3235 3240 - 3243 - 3331 - 3335 - 3340 3343 - 3348 - 3353 - 3357 - 4140 4143 - 4148</p> <p>LK - LP SK - MK - NG (tutti i tipi - all types)</p> <p>BUS O 303 - O 305 - O 307 O 402 - O 404 - O405</p> <p>Unimog</p>	<i>Disco dentato / Plate wheel</i>	Nr. 1	<i>Disco dentato / Plate wheel</i>	Nr. 1	<i>Anello di tenuta / Sealing ring</i>	Nr. 1	<i>Paraolio mozzo ruota / Wheel hub oil seal</i>	Nr. 1	<i>Anello di tenuta / Sealing ring</i>	Nr. 1	<i>Guarnizione cambio / Gear gasket</i>	Nr. 1	<i>Guarnizione cambio / Gear gasket</i>	Nr. 1	<i>Guarnizione cambio / Gear gasket</i>	Nr. 1	<i>Anello di tenuta rame / Copper sealing ring</i>	Nr. 1	<i>Anello di tenuta alluminio / Aluminium sealing ring</i>	Nr. 1
<i>Disco dentato / Plate wheel</i>	Nr. 1																						
<i>Disco dentato / Plate wheel</i>	Nr. 1																						
<i>Anello di tenuta / Sealing ring</i>	Nr. 1																						
<i>Paraolio mozzo ruota / Wheel hub oil seal</i>	Nr. 1																						
<i>Anello di tenuta / Sealing ring</i>	Nr. 1																						
<i>Guarnizione cambio / Gear gasket</i>	Nr. 1																						
<i>Guarnizione cambio / Gear gasket</i>	Nr. 1																						
<i>Guarnizione cambio / Gear gasket</i>	Nr. 1																						
<i>Anello di tenuta rame / Copper sealing ring</i>	Nr. 1																						
<i>Anello di tenuta alluminio / Aluminium sealing ring</i>	Nr. 1																						



Tipo di materiale Materials type			Ns Riferim. Our Ref.	Rif. Costr. O.E. Ref.	Descrizione/Tipo di veicolo Description/Vehicle Type						
<p>NITRILE (NBR)</p>  <table border="1"> <thead> <tr> <th>Ø A mm.</th> <th>Ø B mm.</th> <th>H mm.</th> </tr> </thead> <tbody> <tr> <td>110</td> <td>140</td> <td>13</td> </tr> </tbody> </table> <p>AD ESAURIMENTO UNTILL OUT OF STOCK</p>			Ø A mm.	Ø B mm.	H mm.	110	140	13	101520	300278 (M01002741)	Paraolio mozzo ruota anteriore Front wheel hub oil seal Scania 112 (01/81-12/86)
Ø A mm.	Ø B mm.	H mm.									
110	140	13									
<p>NITRILE (NBR)</p>  <table border="1"> <thead> <tr> <th>Ø A mm.</th> <th>Ø B mm.</th> <th>H mm.</th> </tr> </thead> <tbody> <tr> <td>110</td> <td>140</td> <td>15</td> </tr> </tbody> </table>			Ø A mm.	Ø B mm.	H mm.	110	140	15	101531	375087 (M12014464)	Paraolio mozzo ruota anteriore Mod. 82G/P-93-113-143R BASL Front wheel hub oil seal Mod. 82G/P-93-113-143R BASL Scania 93-113-143
Ø A mm.	Ø B mm.	H mm.									
110	140	15									
<p>NITRILE (NBR)</p>  <table border="1"> <thead> <tr> <th>Ø A mm.</th> <th>Ø B mm.</th> <th>H mm.</th> </tr> </thead> <tbody> <tr> <td>117,47</td> <td>142,87</td> <td>12,7</td> </tr> </tbody> </table> <p>AD ESAURIMENTO UNTILL OUT OF STOCK</p>			Ø A mm.	Ø B mm.	H mm.	117,47	142,87	12,7	101526	173320 (M12011073)	Paraolio mozzo ruota anteriore Front wheel hub oil seal Scania 93-112-113-143
Ø A mm.	Ø B mm.	H mm.									
117,47	142,87	12,7									
<p>NITRILE (NBR)</p>  <table border="1"> <thead> <tr> <th>Ø A mm.</th> <th>Ø B mm.</th> <th>H mm.</th> </tr> </thead> <tbody> <tr> <td>125</td> <td>150</td> <td>13,5</td> </tr> </tbody> </table> <p>AD ESAURIMENTO UNTILL OUT OF STOCK</p>			Ø A mm.	Ø B mm.	H mm.	125	150	13,5	101524	1334535 (M12016695)	Paraolio mozzo ruota anteriore AM61 Front wheel hub oil seal AM61 Scania
Ø A mm.	Ø B mm.	H mm.									
125	150	13,5									

Tipo di materiale Materials type	Ns Riferim. Our Ref.	Rif. Costr. O.E. Ref.	Descrizione/Tipo di veicolo Description/Vehicle Type						
<p style="text-align: center;">NITRILE (NBR)</p>  <table border="1" data-bbox="82 600 612 698"> <thead> <tr> <th>Ø A mm.</th> <th>Ø B mm.</th> <th>H mm.</th> </tr> </thead> <tbody> <tr> <td>125</td> <td>160</td> <td>15</td> </tr> </tbody> </table> <p style="text-align: center;">AD ESAURIMENTO UNTILL OUT OF STOCK</p>	Ø A mm.	Ø B mm.	H mm.	125	160	15	<p>101530</p>	<p>375086</p> <p>(M12014463)</p>	<p><i>Paraolio mozzo ruota anteriore Front wheel hub oil seal</i></p> <p>Scania 93-113-143</p>
Ø A mm.	Ø B mm.	H mm.							
125	160	15							
<p style="text-align: center;">NITRILE (NBR)</p>  <table border="1" data-bbox="82 1124 612 1223"> <thead> <tr> <th>Ø A mm.</th> <th>Ø B mm.</th> <th>H mm.</th> </tr> </thead> <tbody> <tr> <td>145</td> <td>170</td> <td>15/20</td> </tr> </tbody> </table>	Ø A mm.	Ø B mm.	H mm.	145	170	15/20	<p>101529</p>	<p>370076</p> <p>(M12011388)</p>	<p><i>Paraolio mozzo posteriore assale AD90 Rear wheel hub oil seal AD90</i></p> <p>Scania 93-112-113-124-142-143-144</p>
Ø A mm.	Ø B mm.	H mm.							
145	170	15/20							
<p style="text-align: center;">NITRILE (NBR)</p>  <table border="1" data-bbox="82 1572 612 1671"> <thead> <tr> <th>Ø A mm.</th> <th>Ø B mm.</th> <th>H mm.</th> </tr> </thead> <tbody> <tr> <td>150,81</td> <td>177,80</td> <td>12,7</td> </tr> </tbody> </table> <p style="text-align: center;">AD ESAURIMENTO UNTILL OUT OF STOCK</p>	Ø A mm.	Ø B mm.	H mm.	150,81	177,80	12,7	<p>101527</p>	<p>159496</p> <p>(M12011092)</p>	<p><i>Paraolio interno assale posteriore LB81H - LBS86H - LBT86H Rear axle oil seal int.side LB81H - LBS86H - LBT86H</i></p> <p>Scania 93-112-113-142-143 Trilox</p>
Ø A mm.	Ø B mm.	H mm.							
150,81	177,80	12,7							



Tipo di materiale Materials type			Ns Riferim. Our Ref.	Rif. Costr. O.E. Ref.	Descrizione/Tipo di veicolo Description/Vehicle Type						
<p>NITRILE (NBR)</p>  <table border="1"> <thead> <tr> <th>Ø A mm.</th> <th>Ø B mm.</th> <th>H mm.</th> </tr> </thead> <tbody> <tr> <td>77 x 98,4</td> <td>103 x 6,3</td> <td>19,3</td> </tr> </tbody> </table>			Ø A mm.	Ø B mm.	H mm.	77 x 98,4	103 x 6,3	19,3	101536	1610078 3090331 311432 (M12013127)	Kit paraolio mozzo posteriore lato esterno Rear wheel hub oil seal kit external side Volvo F10-F12 FL6-FL7-FL10-FL12 FH12-FH16
Ø A mm.	Ø B mm.	H mm.									
77 x 98,4	103 x 6,3	19,3									
<p>VITON (FPM)</p>  <table border="1"> <thead> <tr> <th>Ø A mm.</th> <th>Ø B mm.</th> <th>H mm.</th> </tr> </thead> <tbody> <tr> <td>80</td> <td>110</td> <td>12</td> </tr> </tbody> </table> <p>AD ESAURIMENTO UNTILL OUT OF STOCK</p>			Ø A mm.	Ø B mm.	H mm.	80	110	12	101575	948448 948448-6 (M12013871)	Paraolio mozzo posteriore Rear wheel hub oil seal Volvo V.I.
Ø A mm.	Ø B mm.	H mm.									
80	110	12									
<p>VITON (FPM)</p>  <table border="1"> <thead> <tr> <th>Ø A mm.</th> <th>Ø B mm.</th> <th>H mm.</th> </tr> </thead> <tbody> <tr> <td>90</td> <td>125,25</td> <td>10</td> </tr> </tbody> </table> <p>AD ESAURIMENTO UNTILL OUT OF STOCK</p>			Ø A mm.	Ø B mm.	H mm.	90	125,25	10	101576	948642 948642-4 (M12014746)	Paraolio mozzo posteriore Rear wheel hub oil seal Volvo V.I.
Ø A mm.	Ø B mm.	H mm.									
90	125,25	10									
<p>VITON (FPM)</p>  <table border="1"> <thead> <tr> <th>Ø A mm.</th> <th>Ø B mm.</th> <th>H mm.</th> </tr> </thead> <tbody> <tr> <td>110</td> <td>140</td> <td>12/21</td> </tr> </tbody> </table>			Ø A mm.	Ø B mm.	H mm.	110	140	12/21	101534	1089552 1587792 (M12014742)	Paraolio mozzo anteriore Front wheel hub oil seal Volvo F10-F12-F16 FL6-FL7-FL10-FL12 FH12-FH16
Ø A mm.	Ø B mm.	H mm.									
110	140	12/21									



Tipo di materiale Materials type	Ns Riferim. Our Ref.	Rif. Costr. O.E. Ref.	Descrizione/Tipo di veicolo Description/Vehicle Type						
<p style="text-align: center;">NITRILE (NBR)</p>  <table border="1" data-bbox="81 600 611 696"> <thead> <tr> <th>Ø A mm.</th> <th>Ø B mm.</th> <th>H mm.</th> </tr> </thead> <tbody> <tr> <td>133,4</td> <td>155,6</td> <td>14</td> </tr> </tbody> </table> <p style="text-align: center;">AD ESAURIMENTO UNTILL OUT OF STOCK</p>	Ø A mm.	Ø B mm.	H mm.	133,4	155,6	14	101535	944667 1577624 (M12011387)	Paraolio mozzo anteriore Front wheel hub oil seal Volvo F7 - F10 - F12
Ø A mm.	Ø B mm.	H mm.							
133,4	155,6	14							
<p style="text-align: center;">VITON (FPM)</p>  <table border="1" data-bbox="81 1122 611 1218"> <thead> <tr> <th>Ø A mm.</th> <th>Ø B mm.</th> <th>H mm.</th> </tr> </thead> <tbody> <tr> <td>140</td> <td>164</td> <td>15,5/23</td> </tr> </tbody> </table> <p style="text-align: center;">AD ESAURIMENTO UNTILL OUT OF STOCK</p>	Ø A mm.	Ø B mm.	H mm.	140	164	15,5/23	101578	1522372 1672249 (M12014656)	Paraolio mozzo Wheel hub oil seal Volvo F10 - F12 (08/77 - 12/94) F16 (01/88 - 12/94) FL10 - FL12 (09/95 - 09/98) FM7 - FM10 (da 04/99 - from 04/99) FM12 (da 04/98 - from 04/98) FH12 - FH16 (da 08/93 - from 08/93)
Ø A mm.	Ø B mm.	H mm.							
140	164	15,5/23							
<p style="text-align: center;">VITON (FPM - FKM)</p>  <table border="1" data-bbox="81 1671 611 1767"> <thead> <tr> <th>Ø A mm.</th> <th>Ø B mm.</th> <th>H mm.</th> </tr> </thead> <tbody> <tr> <td>140</td> <td>164</td> <td>20/23,5</td> </tr> </tbody> </table> <p style="text-align: center;">AD ESAURIMENTO UNTILL OUT OF STOCK</p>	Ø A mm.	Ø B mm.	H mm.	140	164	20/23,5	101533	1672283 (M12014656)	Paraolio mozzo posteriore Rear wheel hub oil seal Volvo F10 - F12 - F16 FH12 - FH16 FL10 - FL12 FM7 - FM10
Ø A mm.	Ø B mm.	H mm.							
140	164	20/23,5							



Tipo di materiale Materials type	Ns Riferim. Our Ref.	Rif. Costr. O.E. Ref.	Descrizione/Tipo di veicolo Description/Vehicle Type									
<p style="text-align: center;">NITRILE (NBR)</p>  <table border="1" data-bbox="84 602 611 703"> <thead> <tr> <th>Ø A mm.</th> <th>Ø B mm.</th> <th>H mm.</th> </tr> </thead> <tbody> <tr> <td>148</td> <td>170,20</td> <td>31,50</td> </tr> </tbody> </table> <p style="text-align: center;">AD ESAURIMENTO UNTILL OUT OF STOCK</p>	Ø A mm.	Ø B mm.	H mm.	148	170,20	31,50	101579	<p>944665 994665-9</p> <p>(M12011389)</p>	<p><i>Paraolio mozzo posteriore Rear wheel hub oil seal</i></p> <p>Volvo V.I.</p>			
Ø A mm.	Ø B mm.	H mm.										
148	170,20	31,50										
 <table border="1" data-bbox="84 1072 611 1211"> <thead> <tr> <th>Ø A mm.</th> <th>Ø B mm.</th> <th>H mm.</th> </tr> </thead> <tbody> <tr> <td>150</td> <td>180</td> <td>10</td> </tr> <tr> <td>150</td> <td>180</td> <td>16</td> </tr> </tbody> </table> <p style="text-align: center;">AD ESAURIMENTO UNTILL OUT OF STOCK</p>	Ø A mm.	Ø B mm.	H mm.	150	180	10	150	180	16	101580	<p>273394</p>	<p><i>Kit paraolio mozzo posteriore Kit oil seal wheel hub</i></p> <p>Volvo V.I.</p>
Ø A mm.	Ø B mm.	H mm.										
150	180	10										
150	180	16										
<p style="text-align: center;">VITON (FPM - FKM)</p>  <table border="1" data-bbox="84 1675 611 1776"> <thead> <tr> <th>Ø A mm.</th> <th>Ø B mm.</th> <th>H mm.</th> </tr> </thead> <tbody> <tr> <td>168</td> <td>188/192,5</td> <td>30/12</td> </tr> </tbody> </table> <p style="text-align: center;">AD ESAURIMENTO UNTILL OUT OF STOCK</p>	Ø A mm.	Ø B mm.	H mm.	168	188/192,5	30/12	101532	<p>1610765 1610765-8</p> <p>(M12014437)</p>	<p><i>Paraolio mozzo posteriore Rear wheel hub oil seal</i></p> <p>Volvo F7 (08/78 - 12/85) F10 - F12 (08/77 - 12/94) F16 (01/88 - 12/94) FL7 - FL10 (09/85 - 09/98) FL12 (09/95 - 09/98) FH12 - FH16 (da 08/93 - from 08/93)</p>			
Ø A mm.	Ø B mm.	H mm.										
168	188/192,5	30/12										







Tipo di materiale Materials type	Ns Riferim. Our Ref.	Rif. Costr. O.E. Ref.	Descrizione/Tipo di veicolo Description/Vehicle Type						
<p style="text-align: center;">NITRILE (NBR)</p>  <table border="1" data-bbox="82 663 612 761"> <thead> <tr> <th>Ø A mm.</th> <th>Ø B mm.</th> <th>H mm.</th> </tr> </thead> <tbody> <tr> <td>115</td> <td>136,7</td> <td>8/10,5</td> </tr> </tbody> </table>	Ø A mm.	Ø B mm.	H mm.	115	136,7	8/10,5	<p>101539</p>	<p>02.5664.57.00 02.5664.55.64</p> <p>(M01016766)</p>	<p>Paraolio mozzo lato interno Wheel hub oil seal int.side</p> <p>Assale BPW Eco 8-9 ton 20'' Axle BPW</p>
Ø A mm.	Ø B mm.	H mm.							
115	136,7	8/10,5							
<p style="text-align: center;">NITRILE (NBR)</p>  <table border="1" data-bbox="82 1126 612 1225"> <thead> <tr> <th>Ø A mm.</th> <th>Ø B mm.</th> <th>H mm.</th> </tr> </thead> <tbody> <tr> <td>135</td> <td>157</td> <td>8/10,5</td> </tr> </tbody> </table>	Ø A mm.	Ø B mm.	H mm.	135	157	8/10,5	<p>101540</p>	<p>02.5664.58.00 02.5664.56.64</p> <p>(M01026187)</p>	<p>Paraolio mozzo lato interno Wheel hub oil seal int.side</p> <p>Assale BPW Eco 10-12 ton 20'' Axle BPW</p>
Ø A mm.	Ø B mm.	H mm.							
135	157	8/10,5							



Tipo di materiale Materials type			Ns Riferim. Our Ref.	Rif. Costr. O.E. Ref.	Descrizione/Tipo di veicolo Description/Vehicle Type
			101525	01001200	<p><i>Paraolio mozzo (applicazione per massa H 180/200) Wheel hub oil seal for wheel brake 180/200</i></p> <p>Rimorchi T.T. All trailers</p>
Ø A mm.	Ø B mm.	H mm.			
110	160	15			

Tipo di materiale Materials type	Ns Riferim. Our Ref.	Rif. Costr. O.E. Ref.	Descrizione/Tipo di veicolo Description/Vehicle Type						
<p style="text-align: center;">NITRILE (NBR)</p>  <table border="1" data-bbox="82 651 612 748"> <thead> <tr> <th>Ø A mm.</th> <th>Ø B mm.</th> <th>H mm.</th> </tr> </thead> <tbody> <tr> <td>100</td> <td>135</td> <td>13/15</td> </tr> </tbody> </table>	Ø A mm.	Ø B mm.	H mm.	100	135	13/15	<p>101538</p>	<p>21220158</p>	<p><i>Paraolio mozzo Wheel hub oil seal</i></p> <p>Assale R.O.R. (serie TE 9000 - 9 ton.)</p>
Ø A mm.	Ø B mm.	H mm.							
100	135	13/15							
<p style="text-align: center;">NITRILE (NBR)</p>  <table border="1" data-bbox="82 1115 612 1211"> <thead> <tr> <th>Ø A mm.</th> <th>Ø B mm.</th> <th>H mm.</th> </tr> </thead> <tbody> <tr> <td>108</td> <td>152,40</td> <td>28,80</td> </tr> </tbody> </table>	Ø A mm.	Ø B mm.	H mm.	108	152,40	28,80	<p>101537</p>	<p>21200321/A</p>	<p><i>Paraolio mozzo lato interno Wheel hub oil seal int. side</i></p> <p>Assale R.O.R. (serie TM)</p>
Ø A mm.	Ø B mm.	H mm.							
108	152,40	28,80							

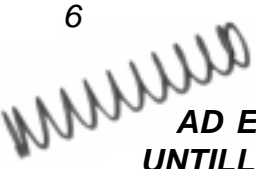
	Ns Riferim. Our Ref.	Rif. Costr. O.E. Ref.	Descrizione/Tipo di veicolo Description/Vehicle Type
	960330	-	<i>Piastra freno montata anteriore</i> <i>Front brake plate</i> 645 - 650 - 662 110NC
	960331	-	<i>Piastra freno montata posteriore</i> <i>Rear brake plate</i> 645 - 650 - 662 110NC
	961031	1906347	<i>Nastro freno a mano rivettato (SILA)</i> <i>Hand brake's band (SILA)</i> 643 - 684 - 160NC

	Ns Riferim. Our Ref.	Rif. Costr. O.E. Ref.	Descrizione/Tipo di veicolo Description/Vehicle Type
 <p>AD ESAURIMENTO UNTILL OUT OF STOCK</p>	960439	1267426	<p>Tappo freni Brake plug</p> <p>Zeta 79.14 TurboZeta 79.12</p>
 <p>AD ESAURIMENTO UNTILL OUT OF STOCK</p>	960442	9925629	<p>Tappo freni tondo Round brake plug</p> <p>115.14/17 - 135.14/17 - 145.17</p>
	103647	42493640	<p>Tassello in gomma rettangolare Lock plug</p>
	103648	42480064	<p>Tassello in gomma tondo - Plug</p> <p>175.17/24 Turbostar 190.36/42/48 - 240.36/48 - 260.48 Turbotech 190.30/32/36 - 220/240/260.36</p>
 <p>AD ESAURIMENTO UNTILL OUT OF STOCK</p>	960443	8528778	<p>Tappo freni Brake plug</p> <p>80.13 - 90.13</p>

	Ns Riferim. Our Ref.	Rif. Costr. O.E. Ref.	Descrizione/Tipo di veicolo Description/Vehicle Type
 <p>AD ESAURIMENTO UNTILL OUT OF STOCK</p> <p>1</p>	962042	2969248 (1)	Molla freni Brake spring 80.13 - 90.13
 <p>AD ESAURIMENTO UNTILL OUT OF STOCK</p> <p>2</p>	962046	9925639 (2)	Molla freni Brake spring Zeta 95.14 - 109.14
 <p>3 AD ESAURIMENTO UNTILL OUT OF STOCK</p>	962050	4572054 (3)	Molla freni Brake spring 650N3 - 662N3 - 110
 <p>4 AD ESAURIMENTO UNTILL OUT OF STOCK</p>	962051	4572055 (4)	Molla freni Brake spring 645 - 650 - 662N3 - 110
 <p>AD ESAURIMENTO UNTILL OUT OF STOCK</p> <p>5</p>	962054	9927561 (5)	Molla freni Brake spring 130NC
 <p>AD ESAURIMENTO UNTILL OUT OF STOCK</p> <p>6</p>	960866	9927555 (6)	Molla registro freno Brake adjuster's spring 130NC EATON
 <p>AD ESAURIMENTO UNTILL OUT OF STOCK</p> <p>7</p>	960861	9927529 (7)	Kit revisione registro freno Brake adjuster repairing kit 130NC EATON

	Ns Riferim. Our Ref.	Rif. Costr. O.E. Ref.	Descrizione/Tipo di veicolo Description/Vehicle Type
	962098	5010098945	<i>Molla freno posteriore</i> <i>Rear brake spring</i> Magnum - Premium AE T.T.
	962099	5010097340	<i>Molla freno posteriore</i> <i>Rear brake spring</i> Magnum - Premium AE T.T.
	962100	5010097089	<i>Molla freno posteriore</i> <i>Rear brake spring</i> Magnum - Premium AE T.T.

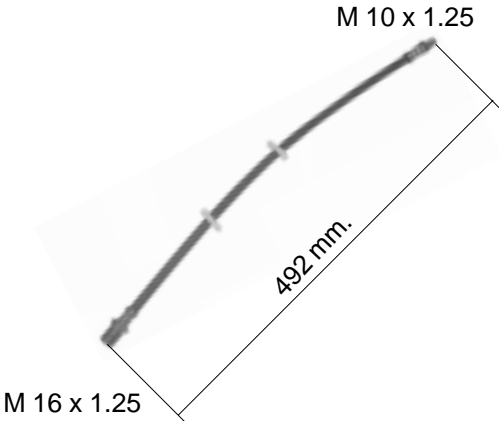
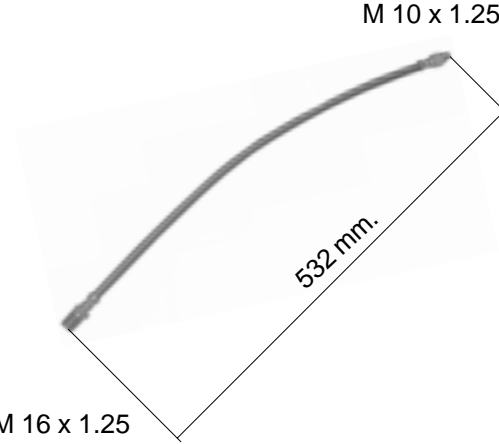
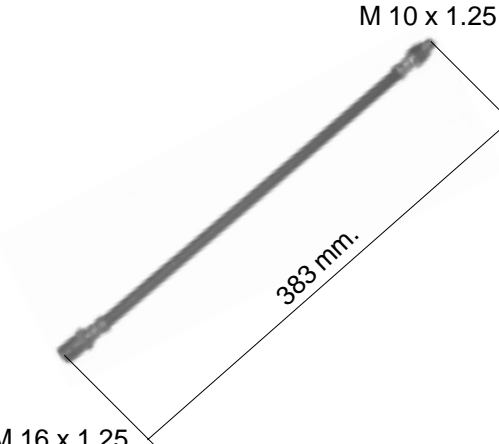
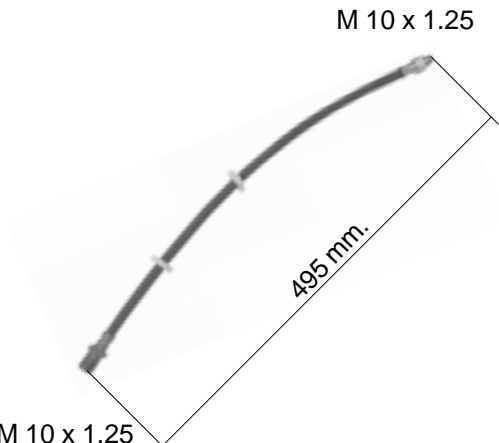
	Ns Riferim. Our Ref.	Rif. Costr. O.E. Ref.	Descrizione/Tipo di veicolo Description/Vehicle Type
 <p>M 10 x 1.25 492 mm. M 16 x 1.25</p>	972104	93822393 8797513	<p><i>Tubo flessibile freno anteriore</i> <i>Front brake pipes</i></p> <p>New Daily (96) 30.8-35.8 Turbo Daily (96) 30.10-35.10-35.12-49.10-49.12</p>
 <p>M 10 x 1.25 532 mm. M 16 x 1.25</p>	972105	8796958	<p><i>Tubo flessibile freno anteriore</i> <i>Front brake pipes</i></p> <p>Daily Restyling 30.8-35.8-40.8 - 35.10</p>
 <p>M 10 x 1.25 383 mm. M 16 x 1.25</p>	972107	93822492 8796934	<p><i>Tubo flessibile freno posteriore</i> <i>Rear brake pipes</i></p> <p>New Daily (96) 30.8-35.8 Turbo Daily (96) 30.10-35.10-35.12-49.10-49.12</p>
 <p>M 10 x 1.25 495 mm. M 10 x 1.25</p>	972106	8796885	<p><i>Tubo flessibile freno posteriore</i> <i>Rear brake pipes</i></p> <p>Daily Restyling 30.8-35.8-40.8 - 35.10</p>

**LINEA FRENANTE (VARIE)
BRAKE LINE (VARIOUS)**

EMMERRE

	Ns Riferim. Our Ref.	Rif. Costr. O.E. Ref.	Descrizione/Tipo di veicolo Description/Vehicle Type
<p>F 16 x 1.5 542 mm.</p>	972082	4722497	<p><i>Tube flessibile freno anteriore</i> <i>Front brake pipes</i></p> <p>IVECO 115.14/17 - 135.14/17 - 145.17 Eurocargo Turbotech</p>
<p>F 16 x 1.5 645 mm.</p>	972085	4722637	<p><i>Tube flessibile freno anteriore</i> <i>Front brake pipes</i></p> <p>IVECO 175.17/24 Eurocargo Turbotech Turbostar Turbotech AP 160</p>
<p>F 18 x 1.5 645 mm.</p>	972093	4742729	<p><i>Tube flessibile freno posteriore</i> <i>Rear brake pipes</i></p> <p>Turbostar Turbotech Eurocargo Eurotrakker Cursor Eurotech Cursor Eurostar Cursor</p>
<p>F 18 x 1.5 560 mm.</p>	972078	42106884	<p><i>Tube flessibile freno posteriore</i> <i>Rear brake pipes</i></p> <p>Turbostar Turbotech Eurocargo Eurotrakker Cursor Eurotech Cursor Eurostar Cursor</p>

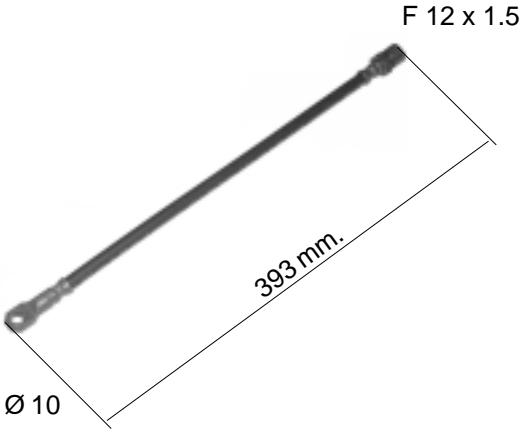

	Ns Riferim. Our Ref.	Rif. Costr. O.E. Ref.	Descrizione/Tipo di veicolo Description/Vehicle Type
 <p>F 12 x 1.5</p> <p>393 mm.</p> <p>Ø 10</p>	972079	98409528	<p><i>Tube flessibile freno posteriore</i> <i>Rear brake pipes</i></p> <p>Eurocargo 60-65-75-80-100-180</p>

EMMEDRE

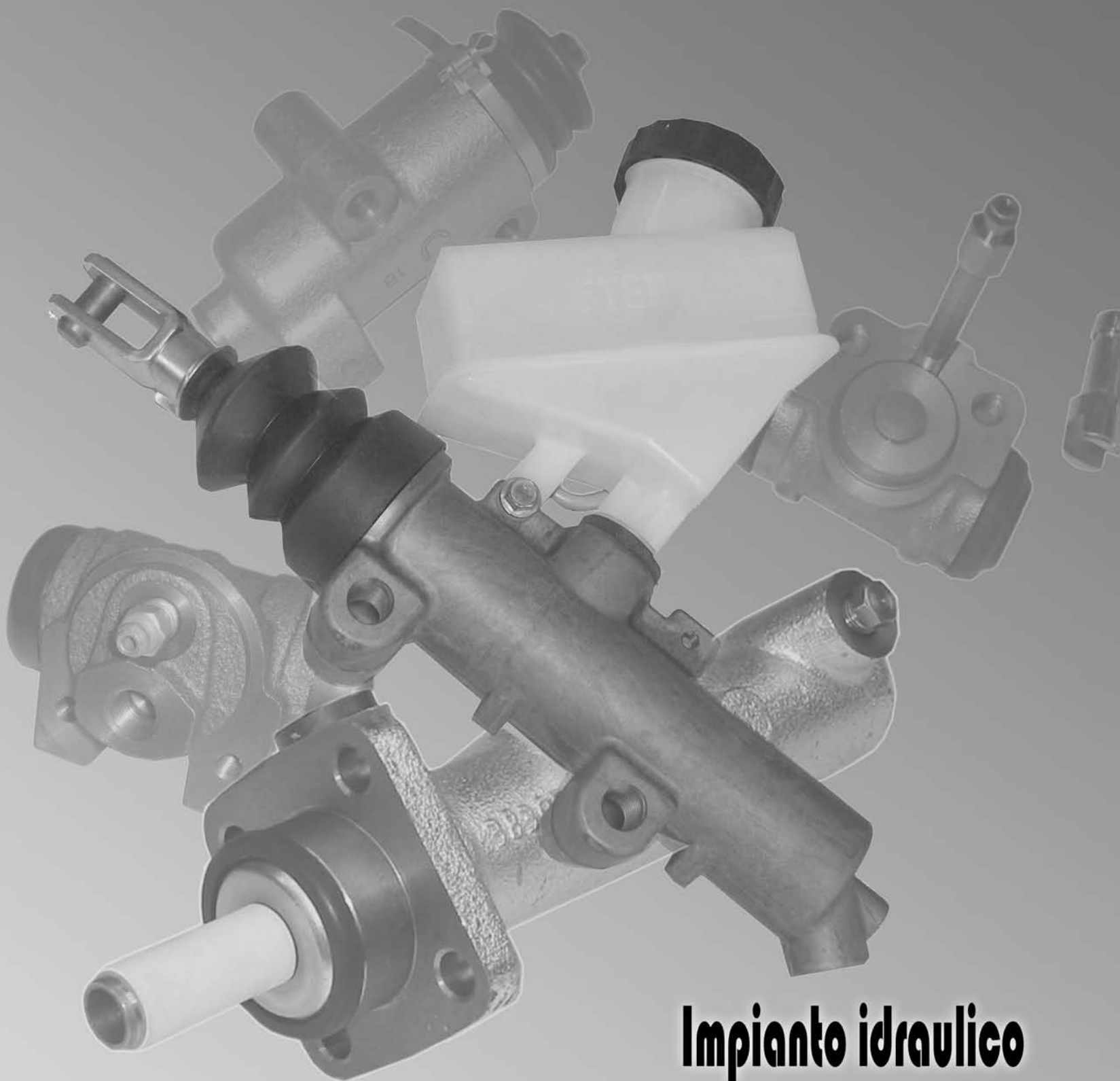
TECHNO
BRAKE®



Impianto idraulico
Hydraulic system







	Ns Riferim. Our Ref.	Rif. Costr. O.E. Ref.	Descrizione/Tipo di veicolo Description/Vehicle Type
	964019	9946799 4601-E5	<p>Pompa freno Ø 23.80 mm. Brake pump</p> <p>Ducato 1900 - 2500 TD 10 - 14 q.li dal/from 1994 al/to 2001 Citroen Jumper 27-31 dal/from 1994 Peugeot Boxer 10-14 q.li dal/from 1994</p>
	964022	9945895 4402-A5	<p>Cilindretto freno posteriore Ø 28.60 mm. Rear brake cylinder</p> <p>Ducato 2800 TD 18 q.li dal/from 1994 al/to 2001 Citroen Jumper 35 dal/from 1994 Peugeot Boxer 18 q.li dal/from 1994</p>
 <p>AD ESAURIMENTO UNTILL OUT OF STOCK</p>	964023	9946056 4601-D1	<p>Pompa freno Ø 25.40 mm. Brake pump</p> <p>Ducato 2800 TD 18 q.li dal/from 1994 al/to 2001 Citroen Jumper 35 dal/from 1994 Peugeot Boxer 18 q.li dal/from 1994</p>

	Ns Riferim. Our Ref.	Rif. Costr. O.E. Ref.	Descrizione/Tipo di veicolo Description/Vehicle Type
 <p>AD ESAURIMENTO UNTILL OUT OF STOCK</p>	<p>964026</p>	<p>6464705</p>	<p><i>Cilindretto freno posteriore Ø 20.64 mm. Rear brake cylinder</i></p> <p>Transit 130 - 150 L/S dal/from 1991</p>



Copyright della EMMERRE S.r.l. - Settimo Torinese - Tutti i diritti sono riservati e depositati a norma di legge ed a norma delle convenzioni internazionali. - E' vietata la duplicazione o la riproduzione anche parziale senza la previa autorizzazione della EMMERRE S.r.l.

	Ns Riferim. Our Ref.	Rif. Costr. O.E. Ref.	Descrizione/Tipo di veicolo Description/Vehicle Type
 <p>Ø 15.8</p>	964202	8121576	<p><i>Cilindretto freni Dx/Sx Ø 15,8 mm. Brake cylinder right/left</i></p> <p>Daily Restyling 30.8 New Daily 30.8</p>
 <p>Ø 17.4</p>	964201	8121575	<p><i>Cilindretto freni Dx/Sx Ø 17,4 mm. Brake cylinder right/left</i></p> <p>Daily Restyling 30.8 New Daily 35.8 - 35.10</p>
 <p>Ø 19.5</p>	964203	93160540	<p><i>Cilindretto freni Dx/Sx Ø 19,5 mm. Brake cylinder right/left</i></p> <p>Turbodaily 35.12</p>
 <p>Ø 20.6</p>	964211	93155720	<p><i>Cilindretto freni Dx/Sx Impianto Perrot - Perrot System Ø 20,6 mm. Brake cylinder right/left</i></p> <p>Daily Restyling 45.10 - 49.10 New Daily 49.12 Turbodaily 49.12</p>
 <p>Ø 23.8</p>	964204	98452387	<p><i>Cilindretto freni Dx/Sx Ø 23,8 mm. Brake cylinder right/left</i></p> <p>TurboDaily 59.12</p>

	Ns Riferim. Our Ref.	Rif. Costr. O.E. Ref.	Descrizione/Tipo di veicolo Description/Vehicle Type
 <p>Ø 28.5</p>	964205	4122369	<p><i>Cilindretto freni Dx/Sx anteriore e posteriore Ø 28,5 mm.</i> <i>Brake cylinder right/left front and rear</i></p> <p>616N1/N2/N3 - 625N1/N2</p>
 <p>Ø 28.5</p>	964212	4220641	<p><i>Cilindretto freni Dx/Sx anteriore e posteriore Ø 28,5 mm.</i> <i>Brake cylinder right/left front and rear</i></p> <p>OM Tigrotto CO3</p>
 <p>Ø 27</p>	964209	4276036	<p><i>Cilindretto freni Dx/Sx anteriore Ø 27 mm.</i> <i>Front brake cylinder right/left</i></p> <p>OM 40/35 - OM 50-55</p>
 <p>Ø 22</p>	964210	4220639	<p><i>Cilindretto freni Dx/Sx posteriore Ø 22 mm.</i> <i>Rear brake cylinder right/left</i></p> <p>OM 40/35 - OM 50-55</p>
 <p>Ø 23.8</p>	964214	4712856	<p><i>Cilindretto freni Dx/Sx posteriore Ø 23,8 mm.</i> <i>Rear brake cylinder right/left</i></p> <p>Zeta 50.9 TurboZeta 65.12</p>
 <p>Ø 25.4</p>	964217	4220643	<p><i>Cilindretto freni Dx/Sx anteriore e posteriore Ø 25,4 mm.</i> <i>Brake cylinder right/left front and rear</i></p> <p>65-70-75 OM Leoncino</p>



	Ns Riferim. Our Ref.	Rif. Costr. O.E. Ref.	Descrizione/Tipo di veicolo Description/Vehicle Type
 <p>Ø 27</p>	964220	4744164	<p>Cilindretto freni Dx/Sx anteriore e posteriore Ø 27 mm. Brake cylinder right/left front and rear</p> <p>Zeta 79.14 TurboZeta 79.12</p>
 <p>Ø 50.8</p>	964235	4294681	<p>Cilindretto freni Dx/Sx anteriore e posteriore Ø 50,8 mm. Brake cylinder right/left front and rear</p> <p>100 - 110 - 130NC</p>
 <p>Ø 44.4</p>	964229	4067826	<p>Cilindretto freni Dx/Sx posteriore Ø 44,4 mm. Rear brake cylinder right/left</p> <p>645 - 650N2/N3</p>
 <p>Ø 50.8</p>	964234	4212449	<p>Cilindretto freni Dx/Sx anteriore e posteriore Ø 50,8 mm. Brake cylinder right/left front and rear</p> <p>662N3 - 673 - 314/3</p>
 <p>Ø 28.5</p>	964213	93155721	<p>Cilindretto freni posteriore Ø 28,5 mm. Rear brake cylinder</p> <p>Zeta 95.14</p>
 <p>Ø 31.7</p>	964216	93155722	<p>Cilindretto freni posteriore Ø 31,7 mm. Rear brake cylinder</p> <p>Zeta 109.14</p>



	Ns Riferim. Our Ref.	Rif. Costr. O.E. Ref.	Descrizione/Tipo di veicolo Description/Vehicle Type
	964013	9989017	<i>Pompa freno a flangia ovale</i> <i>Brake pump with oval flange</i> Daily Restyling 30-35-40.8 - 35.10 New Daily 30-35-40.8 - 35.10 Turbodaily 35.12
	964004	-	<i>Pompa freno a flangia quadra</i> <i>(adatt. servofreno 4797460)</i> <i>Brake pump with square flange</i> <i>(adaptable servobrake 4797460)</i> Daily Restyling 45.10 - 49.10
	964031	-	<i>Pompa freno</i> per servofreno 99463713 <i>Brake pump</i> <i>for servo brake 99463713</i> Turbodaily 59.12
	964032	-	<i>Pompa freno</i> per servofreno 99483920 <i>Brake pump</i> <i>for servo brake 99483920</i> Turbodaily 35.8 - 35.10 - 35.12 (05/96) 49.10 - 49.12 (05/96)
	964404	2991743	<i>Pompa freno</i> <i>Brake pump</i> Daily City 2000 35C9 - 35C11 - 35C13
	964033	2991745	<i>Pompa freno servofreno idraulico</i> <i>Rif. 99487840</i> <i>Brake pump for hydraulic servo brake</i> <i>Ref. 99487840</i> Daily City 2000 35S9 - 35S11 - 35S13 - 35S15





	Ns Riferim. Our Ref.	Rif. Costr. O.E. Ref.	Descrizione/Tipo di veicolo Description/Vehicle Type
	964011	4844302	Servofreno completo Brake pump with servo brake Iveco Daily 30.8 - 35.8 - 40.8 35.10 - 40.10
	964003	-	Pompa freno x servofreno (rif. 500374416) Brake pump for servo brake (Ref. 500374416) Iveco Daily 50C11
	964002	4277619	Pompa freno Brake pump 612N2/N3N/N4 - 625N1/N2
	964005	4797844	Pompa freno U.T. con raccordi Brake pump with fittings OM40 - 40/35
	964009	4797843	Pompa freno Brake pump 50 - 55 Gammazeta

	Ns Riferim. Our Ref.	Rif. Costr. O.E. Ref.	Descrizione/Tipo di veicolo Description/Vehicle Type
	964006	4765078	<i>Pompa freno U.T. con raccordi</i> <i>Brake pump with fittings</i> OM50-55 F8/F10 - 65-75-79F10/F13 OM Leoncino
	964016	4804132	<i>Pompa freno</i> <i>Brake pump</i> 65.12 Turbozeta - 79.14 - 95.14 109.14 Zeta
	964007	4804131	<i>Pompa freno</i> <i>Brake pump</i> 65.12 Turbozeta - 79.14 - 95.14 109.14 Zeta
	964008	4762814	<i>Pompa freno</i> <i>(ex. 4164296 - 4754206)</i> <i>Brake pump</i> 80 - 90 - 100 - 110
	964017	4804129	<i>Pompa freno</i> <i>Brake pump</i> Eurocargo 75E12 - 65/75E14 75-80-100E15 - 80-100E18/E21





	Ns Riferim. Our Ref.	Rif. Costr. O.E. Ref.	Descrizione/Tipo di veicolo Description/Vehicle Type
	964035	4817854	<i>Pompa freno</i> <i>Brake pump</i> Eurocargo T.T. Eurocargo Tector 75E13/E15/E17
	964401	4792417	<i>Correttore di frenata</i> <i>Breaking control</i> New Daily 30.8-35.8-40.8 Daily Restyling 35.10-49.10 Turbodaily 59.12 Zeta 50.9-65.9-79.14-95.14-109.14 TurboZeta 60.11-65.12-79.12
	964402	4792418	<i>Correttore di frenata</i> <i>Breaking control</i> New Daily 30.8-35.8-40.8 35.10-45.10-49.10 Daily Restyling 30.8-35.8-40.8 35.10-45.10-49.10 Turbodaily 35.12-49.12



	Ns Riferim. Our Ref.	Rif. Costr. O.E. Ref.	Descrizione/Tipo di veicolo Description/Vehicle Type
	<p>964222</p>	<p>-06902174-0</p>	<p><i>Cilindretto freno posteriore Ø 25,40 mm. Rear brake cylinder</i></p> <p>Trade 2.0 D (dal 1991 from 1991)</p>
	<p>964223</p>	<p>-06902317-0</p>	<p><i>Cilindretto freno posteriore Ø 25,40 mm. Rear brake cylinder</i></p> <p>Atleon ECO T</p>

	Ns Riferim. Our Ref.	Rif. Costr. O.E. Ref.	Descrizione/Tipo di veicolo Description/Vehicle Type
 <p>AD ESAURIMENTO UNTILL OUT OF STOCK</p>	964232	77.01.034.172	<p><i>Cilindretto freno posteriore Ø 25,40 mm. Rear brake cylinder</i></p> <p>Trafic 2.1D - T900D - T1100D</p>
 <p>AD ESAURIMENTO UNTILL OUT OF STOCK</p>	964233	77.01.030.155	<p><i>Cilindretto freno posteriore Ø 25,40 mm. Rear brake cylinder</i></p> <p>Trafic 2.1D - P1400 2.2 I - T900 - T1100 - T1400 V1100 - 2.4D T1000 - T1400D - V1100D Bus</p>



	Ns Riferim. Our Ref.	Rif. Costr. O.E. Ref.	Descrizione/Tipo di veicolo Description/Vehicle Type
	908902	4311345	<i>Cilindretto frizione Clutch cylinder</i> OM 40/35 - 50 NC 616N2/N3/N4 625N1/N2/N3
	908903	4191164	<i>Cilindretto frizione Clutch cylinder</i> OM 50 60-65-70-79.10 Leoncino
	908811	4853409	<i>Cilindretto frizione Clutch cylinder</i> Eurocargo
	908800	42100180	<i>Cilindretto frizione Clutch cylinder</i> Turbostar
	908799	42063311	<i>Cilindretto frizione Clutch cylinder</i> Turbostar
	908906	4271840	<i>Cilindretto frizione Clutch cylinder</i> 673 - 130 - 150 - 159 NC OM 130 - 314/3

	Ns Riferim. Our Ref.	Rif. Costr. O.E. Ref.	Descrizione/Tipo di veicolo Description/Vehicle Type
	908910	4848576	Cilindretto frizione Clutch cylinder Zeta 50.9-79.14-95.14-109.14 TurboZeta 60.11-65.12-79.12
	908905	4271838	Cilindretto frizione Clutch cylinder 645-650-662 100 - 110NC
	908911	4777521	Cilindretto frizione Clutch cylinder 115.14/17 135.14/17 145.17 - 175.17
	908808	4854828	Cilindretto frizione Clutch cylinder Eurocargo 60E10/E12/E14 - 65E10/E12/E14 75E12/E14/E15 80E15/E18/E21 - 95E15 100E15/E18/E21 - 120E15/E18/E23 130E15/E18/E23 - 135E18/E23 150E15/E18/E23 - 170E15/E18/E23
	964034	500357840	Cilindretto frizione Clutch cylinder Eurocargo 75E13/E15/E17/E18 100E17/E18/E21 120E17/E21 - 130E18/E21 150E18/E21 - 180E21

	Ns Riferim. Our Ref.	Rif. Costr. O.E. Ref.	Descrizione/Tipo di veicolo Description/Vehicle Type
	908815	4800161	<p><i>Pompa frizione U.T. Clutch pump</i></p> <p>OM 40 40/35 NC</p>
 <p>AD ESAURIMENTO UNTILL OUT OF STOCK</p>	908817	4166208	<p><i>Pompa frizione 1a Serie Clutch pump</i></p> <p>OM 40 40/35 NC</p>
	908812	4797845	<p><i>Pompa frizione (ex 4217083) Clutch pump</i></p> <p>Zeta 50.9-65.9-79.14-95.14-109.14 TurboZeta 60.11-65.12-79.12</p>
	908809	4292543	<p><i>Pompa frizione Clutch pump</i></p> <p>Turbostar 190.36/42/48</p> <p>Turbotech 190.24/26/30/32/36 - 220.36 240.36/48 - 260.32/36/48</p>

	Ns Riferim. Our Ref.	Rif. Costr. O.E. Ref.	Descrizione/Tipo di veicolo Description/Vehicle Type
	908803	4219866	<i>Pompa frizione Clutch pump</i> 645-650-662 N2-N3 OM 100-120 Bus 312/3/4
	908804	4657683	<i>Pompa frizione Clutch pump</i> 100-110-130NC-673N OM 130
	908820	4774874	<i>Pompa frizione Clutch pump</i> 175.17/24 - 115.14/17 135.14/17 - 145.17

	Ns Riferim. Our Ref.	Rif. Costr. O.E. Ref.	Descrizione/Tipo di veicolo Description/Vehicle Type
	<p>908807</p>	<p>4853408</p>	<p>Pompa frizione Clutch pump</p> <p>Eurocargo 75E15-80E15/E18-95E15 100E15/E18 120E15/E18/E23 130E15/E18/E24/E28 150E15/E18/E24/E27/E28 170E15/E18/E23 180E21/E24/E28 260E23-280E23-320E27</p> <p>Eurotech 180E24/E27/E30/E34/E38/E42 190E24/E27/E30/E34E38/E42 240E34/E38/E42 325E27-400E34/E38/E42 440E34/E38/E42 Eurotech Cursor 190E24/E31/E35 260E24/E31/E35-440E31/E35</p> <p>Eurostar 180E38/E42-190E38/E42/E47/E52 240E38/E42/E47/E52 260E42/E47/E52 400E38/E42/E47/E52 440E38/E42/E47/E52</p> <p>Eurostar Cursor 190E43</p> <p>Eurotrakker 190E30/E31/E34/E37/E42 260E30/E34/E37/E42/E47 330E34/E37 340E34/E37/E42 380E31/E34/E37/E42/E47 400E31/E34/E37/E42 410E37/E42-440E37/E42</p> <p>Eurotrakker Cursor 260E31/E35-340E35</p>

	Ns Riferim. Our Ref.	Rif. Costr. O.E. Ref.	Descrizione/Tipo di veicolo Description/Vehicle Type
	908810	4726714	<i>Pompa frizione</i> <i>Clutch pump</i> 240.36 - 190.36 - AP160 - 12.26
	908813	41211005	<i>Cilindro maestro frizione</i> SENZA sensore <i>Clutch cylinder without sensor</i> Eurotrakker 190E30/E31/E34/E37 Eurotrakker Cursor 190E38 - 400E34/E37 Eurotech T.T. Stralis
	908823	41211006	<i>Cilindro maestro frizione</i> CON sensore <i>Clutch cylinder with sensor</i> Eurotrakker 190E30/E31/E34/E37 Eurotrakker Cursor 190E38 - 400E34/E37 Eurotech T.T. Stralis



LINEA STERZO
STEERING LINE
LIGNE DE DIRECTION
LINEA DE DIRECCION
LENKSYSTEM

Компоненты рулевого управления

نظام القيادة

EMMERRE



2009

EMMERRE
**ARTICOLI NUOVI INSERITI
NEL CATALOGO STERZO**
2009
**NEW ARTICLES INCLUDED IN
STEERING CATALOGUE**
2009
TESTE STERZO - BALL JOINTS

EMMERRE	Adattabile - Adaptable	Applicazione - Application	Pagina - Page
954020	5042 12586	IVECO	13
954314	93802356	IVECO	13
954315	5042 12925	IVECO	13
954299	42533073	IVECO	21
954037	-48647-9X62A 11200361-0	NISSAN	77
954036	-48527-9X62A 11200360-0	NISSAN	77
954045	-11500307-0	NISSAN	77
954044	-11500373-0	NISSAN	77
954550	1394443	SCANIA	88
954551	1394444	SCANIA	88
914254	60700015000	GASOLONE	107
914255	60700014000	GASOLONE	107

TIRANTI STERZO - TIE RODS

EMMERRE	Adattabile - Adaptable	Applicazione - Application	Pagina - Page
954224	1351734	DAF	7
954135	500324282	IVECO	26
954072	41028269	IVECO	28
954222	81466116004	MAN	42
954223	85466106102	MAN	43
954316	9724602805	MERCEDES	60
954400	485109X101 11200454-0	NISSAN	78
954401	485109X102	NISSAN	78
954402	48510F3900	NISSAN	78
954200	5010239387 5010130740	RENAULT	82
954201	5010383203 5010488836	RENAULT	84
954318	1384027 1769597	SCANIA	90
954319	1394884	SCANIA	90
954209	1083744	VOLVO	96

EMMERRE

**ARTICOLI NUOVI INSERITI NEL
CATALOGO STERZO
NEW ARTICLES INCLUDED IN
STEERING CATALOGUE
2009**

BARRE SOSPENSIONI - SUSPENSION BARS

EMMERRE	Adattabile - Adaptable	Applicazione - Application	Pagina - Page
972541	41034330	IVECO	35
973030	93161637	IVECO	35
972552	98454109	IVECO	35
972551	41042093	IVECO	35
973053	93162239	IVECO	35
954000	500340769	IVECO	38
954252	98489741	IVECO	38
972556	81432206285	MAN	46
972516	9483500905	MERCEDES	70
954320	1621419-1608151	VOLVO	101

BARRE ACCOPPIAMENTO - COMPLETE TRACK RODS

EMMERRE	Adattabile - Adaptable	Applicazione - Application	Pagina - Page
954309	81467116860 81467116861 81467116773 81467116858	MAN	44
954175	9443301703 6253303203	MERCEDES	64
954234	5010566063 5010439021	RENAULT	86
954233	5010439022	RENAULT	86
954232	5010600822	RENAULT	86

ARTICOLI VARI SOSPENSIONE - VARIOUS SUSPENSION ARTICLES

EMMERRE	Adattabile - Adaptable	Applicazione - Application	Pagina - Page
973231	2997004 4525854	IVECO-IVECO BUS	107
973232	2997003 4525855	IVECO-IVECO BUS	107
973146	93822444	IVECO	123
973131	93815026	IVECO	125
973158	93815025	IVECO	118
973249	93810157	IVECO	124
973248	41000480	IVECO	125
973244	4741171	IVECO	123
973140	504207328	IVECO	125
973141	504207329	IVECO	125
973142	504207327	IVECO	124
973143	504213051	IVECO	124
973144	504207331	IVECO	123
973145	93810223	IVECO	123

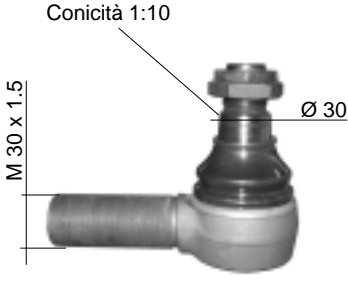
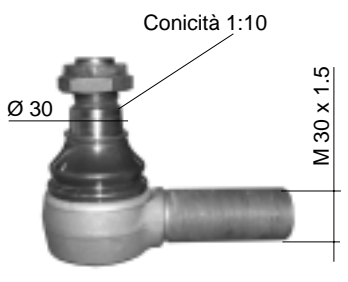
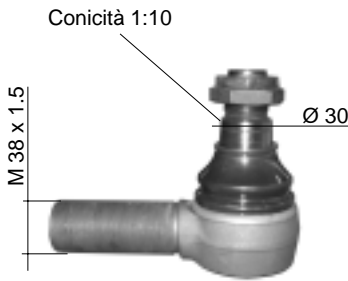
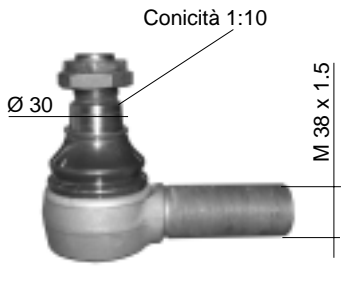
 <p>Conicità 1:10 M 30 x 1.5 Ø 30</p> <p>Dx-Right</p>	<p>Ns.Rif. Our Ref.</p> <p>954012</p>	<p>Rif.Costr. O.E. Ref.</p> <p>113254 (101694)</p> <p>698450 4833822 81953016234 0004602948 5010832582 395010</p>	<p>Tipo di veicolo Vehicle Type</p> <p>BM 304 - 305F</p> <p>DAF IVECO MAN MERCEDES RENAULT SCANIA</p>
 <p>Conicità 1:10 Ø 30 M 30 x 1.5</p> <p>Sx-Left</p>	<p>Ns.Rif. Our Ref.</p> <p>954013</p>	<p>Rif.Costr. O.E. Ref.</p> <p>113253 (101695)</p> <p>1228115 4833823 81953016237 0004603548 5010832583 395009</p>	<p>Tipo di veicolo Vehicle Type</p> <p>BM 304 - 305F</p> <p>DAF IVECO MAN MERCEDES RENAULT SCANIA</p>
 <p>Conicità 1:10 M 38 x 1.5 Ø 30</p> <p>Dx-Right</p>	<p>Ns.Rif. Our Ref.</p> <p>954040</p>	<p>Rif.Costr. O.E. Ref.</p> <p>10229</p> <p>4688948</p>	<p>Tipo di veicolo Vehicle Type</p> <p>BM</p> <p>IVECO</p>
 <p>Conicità 1:10 Ø 30 M 38 x 1.5</p> <p>Sx-Left</p>	<p>Ns.Rif. Our Ref.</p> <p>954041</p>	<p>Rif.Costr. O.E. Ref.</p> <p>30042</p> <p>4688949</p>	<p>Tipo di veicolo Vehicle Type</p> <p>BM</p> <p>IVECO</p>

<p>Sx-Left</p>	<p>Ns.Rif. Our Ref.</p> <p>954118</p>	<p>Rif.Costr. O.E. Ref.</p> <p>113252 (101348)</p>	<p>Tipo di veicolo Vehicle Type</p> <p>BM 304/305F Testa per tirante longitudinale (Longitudinal ball joint)</p>
<p>Dx-Right</p>	<p>Ns.Rif. Our Ref.</p> <p>954119</p>	<p>Rif.Costr. O.E. Ref.</p> <p>113251 (101347)</p>	<p>Tipo di veicolo Vehicle Type</p> <p>BM304/305F Testa per tirante longitudinale (Longitudinal ball joint)</p>
	<p>Ns.Rif. Our Ref.</p>	<p>Rif.Costr. O.E. Ref.</p>	<p>Tipo di veicolo Vehicle Type</p>
	<p>Ns.Rif. Our Ref.</p>	<p>Rif.Costr. O.E. Ref.</p>	<p>Tipo di veicolo Vehicle Type</p>

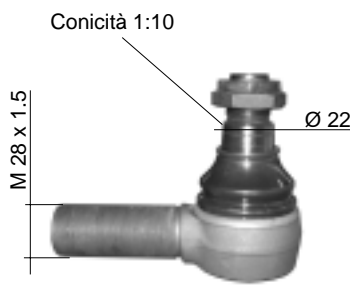
 <p>Conicità 1:10</p> <p>Ø 22</p> <p>M 28 x 1.5</p> <p>Dx-Right</p>	Ns.Rif. Our Ref.	Rif.Costr. O.E. Ref.	Tipo di veicolo Vehicle Type
	954026	607453 607451 1373135	DAF CF65-CF75 - XF95 FA45-FA55-FA75-FA95 F500-F600-F700-F800-F900-F1000-F1100-F1200-F1300 F1400-F1500-F1600-F1700-F1900 F2000-F2100-F2200-F2300-F2500-F2600-F2700-F2800 F2900-F3200-F3300-F3600
	4833825 81953016249 0003309535 5000823987 1698191	IVECO MAN MERCEDES RENAULT VOLVO	

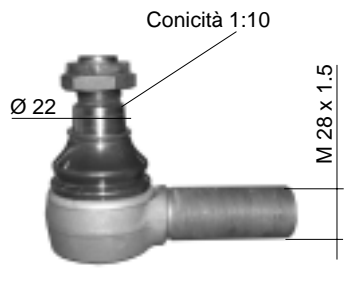
 <p>Conicità 1:10</p> <p>Ø 22</p> <p>M 28 x 1.5</p> <p>Sx-Left</p>	Ns.Rif. Our Ref.	Rif.Costr. O.E. Ref.	Tipo di veicolo Vehicle Type
	954027	607452 110196 1373137	DAF CF65-CF75 - XF95 FA45-FA55-FA75-FA95 F500-F600-F700-F800-F900-F1000-F1100-F1200-F1300 F1400-F1500-F1600-F1700-F1900 F2000-F2100-F2200-F2300-F2500-F2600-F2700-F2800 F2900-F3200-F3300-F3600
	4833826 81953016222 0003309635 5000823947 1698190	IVECO MAN MERCEDES RENAULT VOLVO	

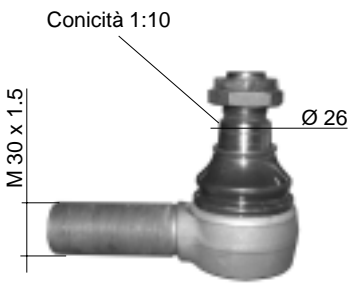
 <p>Conicità 1:10</p> <p>Ø 26</p> <p>M 30 x 1.5</p> <p>Dx-Right</p>	Ns.Rif. Our Ref.	Rif.Costr. O.E. Ref.	Tipo di veicolo Vehicle Type
	954112	698609 607999	DAF CF65-CF75 (02/98 - 12/00) FA1300-FA1400-FA1500-FA1600-FA1700-FA1900
	4833827 81953016272 00013300135 5000295214	IVECO MAN MERCEDES RENAULT	

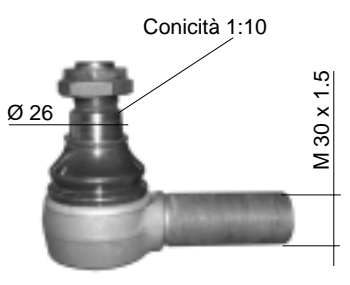
 <p>Conicità 1:10</p> <p>Ø 26</p> <p>M 30 x 1.5</p> <p>Sx-Left</p>	Ns.Rif. Our Ref.	Rif.Costr. O.E. Ref.	Tipo di veicolo Vehicle Type
	954110	607998 311300	DAF CF65-CF75 (02/98 - 12/00) FA1300-FA1400-FA1500-FA1600-FA1700-FA1900
	4833828 81953016273 3023300335 5000295215	IVECO MAN MERCEDES RENAULT	

	Ns.Rif. <i>Our Ref.</i>	Rif.Costr. <i>O.E. Ref.</i>	Tipo di veicolo <i>Vehicle Type</i>
<p>Dx-Right</p>	<p>954012</p> <p>698450 696226 607981 1257890</p> <p>113254 4833822 81953016234 0004602948 5010832582 395010</p>	<p>DAF CF65-CF75-CF85 - XF95 F1600-F1700-F1900-F200-F2100 FA85-FA95</p> <p>ASTRA IVECO MAN MERCEDES RENAULT SCANIA</p>	
<p>Sx-Left</p>	<p>954013</p> <p>1228115</p> <p>113253 4833823 81953016237 0004603548 5010832583 395009</p>	<p>DAF CF65-CF75-CF85 - XF95 F1600-F1700-F1900-F200-F2100 FA85-FA95</p> <p>ASTRA IVECO MAN MERCEDES RENAULT SCANIA</p>	
<p>Dx-Right</p>	<p>954050</p> <p>1205215 1235514</p>	<p>DAF XF95 - CF95</p>	
<p>Sx-Left</p>	<p>954051</p> <p>1205248 1235515</p>	<p>DAF XF95 - CF95</p>	

 <p>M 48 x 1.5 Ø 27 Dx-Right</p>	<p>Ns.Rif. Our Ref.</p> <p>954003</p>	<p>Rif.Costr. O.E. Ref.</p> <p>0067389</p>	<p>Tipo di veicolo Vehicle Type</p> <p>Serie 95</p>
 <p>M 48 x 1.5 Ø 27 Sx-Left</p>	<p>Ns.Rif. Our Ref.</p> <p>954004</p>	<p>Rif.Costr. O.E. Ref.</p> <p>0067303</p>	<p>Tipo di veicolo Vehicle Type</p> <p>Serie 95</p>
 <p>M 46 x 1.5 Dx-Right</p>	<p>Ns.Rif. Our Ref.</p> <p>954126</p>	<p>Rif.Costr. O.E. Ref.</p> <p>606923</p>	<p>Tipo di veicolo Vehicle Type</p> <p>2500 - 2800</p>
 <p>M 46 x 1.5 Sx-Left</p>	<p>Ns.Rif. Our Ref.</p> <p>954127</p>	<p>Rif.Costr. O.E. Ref.</p> <p>606922</p>	<p>Tipo di veicolo Vehicle Type</p> <p>2500 - 2800</p>
 <p>M 24 M 24 x 1.5 Ø 27 Dx-Right</p>	<p>Ns.Rif. Our Ref.</p> <p>954552</p>	<p>Rif.Costr. O.E. Ref.</p> <p>817824 9281792 82953010011 5000792132</p>	<p>Tipo di veicolo Vehicle Type</p> <p>Testa barra accoppiamento Ball joint for track rod IVECO MAN RENAULT</p>

L1 744 mm.		
L2 680 mm.		
Ns Riferim. Our Ref.	Rif. Costr. O.E. Ref.	Tipo di veicolo - Vehicule Type
954177	0094016 171215	F2100 - F2300 - F2500 - F2700

L1 872 mm.		
L2 805 mm.		
Ns Riferim. Our Ref.	Rif. Costr. O.E. Ref.	Tipo di veicolo - Vehicule Type
954154	0094029 117343	F2800 - F3300 - F3600

L1 876 mm.		
L2 825 mm.		
Ns Riferim. Our Ref.	Rif. Costr. O.E. Ref.	Tipo di veicolo - Vehicule Type
954161	1283211 1351714 1385497	CF65 - CF75 - CF85 F65 - F75 - F85

L1 848 mm.		
L2 798 mm.		
Ns Riferim. Our Ref.	Rif. Costr. O.E. Ref.	Tipo di veicolo - Vehicule Type
954162	1283212 1351715 1385492	CF65 - CF75 - CF85 F65 - F75 - F85 - F1660 - F1700 - F1900

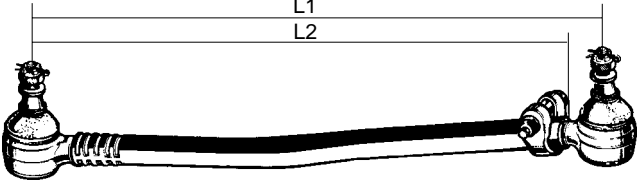
L1 995 mm.		
L2 960 mm.		
Ns Riferim. Our Ref.	Rif. Costr. O.E. Ref.	Tipo di veicolo - Vehicule Type
954155	0094038 554765 525433	FA85 - FA95 XF95

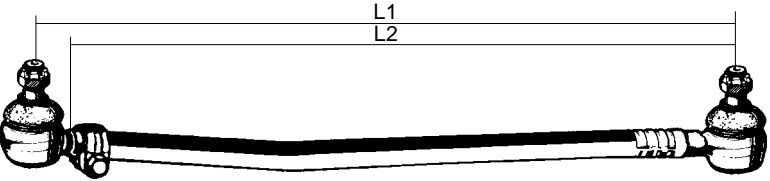
L1 1005 mm.		
L2 980 mm.		
Ns Riferim. Our Ref.	Rif. Costr. O.E. Ref.	Tipo di veicolo - Vehicule Type
954184	1291060	F95 XF95 (vecchio modello - old type)

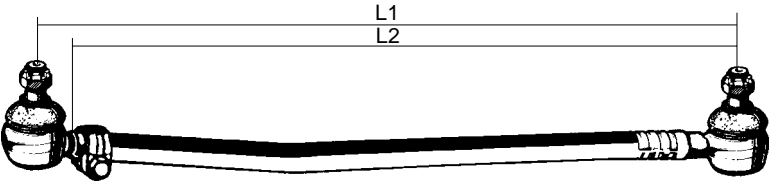
L1 1005 mm.		
L2 960 mm.		
Ns Riferim. Our Ref.	Rif. Costr. O.E. Ref.	Tipo di veicolo - Vehicule Type
954224	1351734	F95 XF95 (ultimo modello - new type)

Ns Riferim. Our Ref.	Rif. Costr. O.E. Ref.	Tipo di veicolo - Vehicule Type

	<p>Ns.Rif. Our Ref.</p> <p>972571</p>	<p>Rif.Costr. O.E. Ref.</p> <p>1368270 0080521 (1361151)</p>	<p>Tipo di veicolo Vehicle Type</p> <p>Barra angolare sospensioni Angle torque arm</p> <p>F2100 - F2300 - F2500 - F2700 XF95</p>
	<p>Ns.Rif. Our Ref.</p> <p>973056</p>	<p>Rif.Costr. O.E. Ref.</p> <p>691704 (069600) (A)</p> <p>2968454 271188</p>	<p>Tipo di veicolo Vehicle Type</p> <p>Kit revisione centrale barra 1368270 Angle torque arm repair central kit 1368270</p> <p>F2100 - F2300 - F2500 - F2700 XF95</p> <p>IVECO VOLVO</p>
	<p>Ns.Rif. Our Ref.</p> <p>972573</p>	<p>Rif.Costr. O.E. Ref.</p> <p>693778 (069724) (B)</p> <p>0005861433</p>	<p>Tipo di veicolo Vehicle Type</p> <p>Kit revisione laterale barra 1368270 Angle torque arm repair lateral kit 1368270</p> <p>F2100 - F2300 - F2500 - F2700 XF95</p> <p>MERCEDES</p>
	<p>Ns.Rif. Our Ref.</p> <p>972521</p>	<p>Rif.Costr. O.E. Ref.</p> <p>696320</p> <p>273706 81953016132</p>	<p>Tipo di veicolo Vehicle Type</p> <p>Kit revisione centrale barra angolare 649819 Angle torque arm repair central kit 649819</p> <p>VOLVO MAN</p>
	<p>Ns.Rif. Our Ref.</p> <p>973057</p>	<p>Rif.Costr. O.E. Ref.</p> <p>1271124</p> <p>2980884 81432206108</p>	<p>Tipo di veicolo Vehicle Type</p> <p>Kit revisione barra laterale Torque arm repair lateral kit</p> <p>IVECO MAN</p>

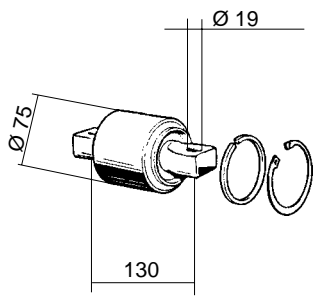
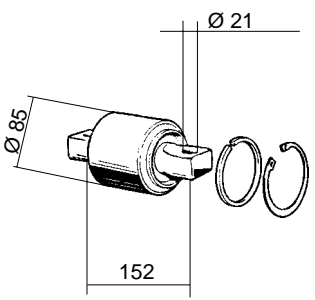
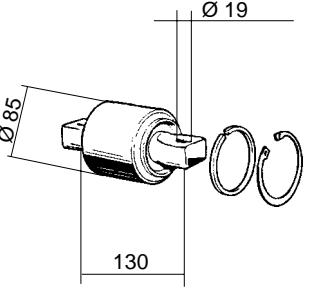
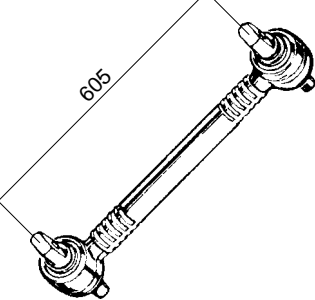
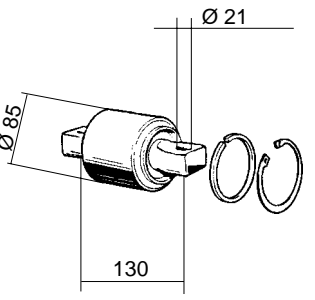
	Ns.Rif. Our Ref. 972547	Rif.Costr. O.E. Ref. 67354 93192361 0003300207 81432306061	Tipo di veicolo Vehicle Type Silentblock barra laterale Torque arm silentblock IVECO MERCEDES MAN
	Ns.Rif. Our Ref. 972550	Rif.Costr. O.E. Ref. 691703 274068 0003500613	Tipo di veicolo Vehicle Type Silentblock barra laterale Torque arm silentblock VOLVO MERCEDES
	Ns.Rif. Our Ref. 972576	Rif.Costr. O.E. Ref. 689749 42488722 638862 81432206055 82262320660	Tipo di veicolo Vehicle Type Silentblock barra laterale 658102 Torque arm silentblock 658102 IVECO SCANIA MAN KASSBOHRER
	Ns.Rif. Our Ref. 972500	Rif.Costr. O.E. Ref. 0267743 1361650	Tipo di veicolo Vehicle Type Barra reazione sospensione pneumatica Pneumatic suspension torque arm F65 - F75 - F85 - F95 CF65 - CF75 - CF85 XF95
	Ns.Rif. Our Ref. 972501	Rif.Costr. O.E. Ref. 513757 691709 42535204 81.43220.6203 273373/274019	Tipo di veicolo Vehicle Type Silentblock barra laterale Torque arm silentblock DAF F75 - F85 - F95 IVECO MAN VOLVO

 <p>Lato Dx-Sx - Rh-Lh Side</p>	Ns.Rif. Our Ref. 954009	Rif.Costr. O.E. Ref. 9750079980	Tipo di veicolo Vehicle Type FIAT DUCATO - TALENTO (fino al 1994 - till 1994)
 <p>Lato Dx-Sx - Rh-Lh Side</p>	Ns.Rif. Our Ref. 954010	Rif.Costr. O.E. Ref. 1306716080	Tipo di veicolo Vehicle Type FIAT DUCATO - TALENTO (dal 1994 - from 1994)
	Ns.Rif. Our Ref.	Rif.Costr. O.E. Ref.	Tipo di veicolo Vehicle Type
	Ns.Rif. Our Ref.	Rif.Costr. O.E. Ref.	Tipo di veicolo Vehicle Type
	Ns.Rif. Our Ref.	Rif.Costr. O.E. Ref.	Tipo di veicolo Vehicle Type





<p>Sx-Left</p>	Ns.Rif. <i>Our Ref.</i>	Rif.Costr. <i>O.E. Ref.</i>	Tipo di veicolo <i>Vehicle Type</i>
	914254	60700015000	GASOLONE TS27/28 (1°serie - 1°type)

<p>Dx-Right</p>	Ns.Rif. <i>Our Ref.</i>	Rif.Costr. <i>O.E. Ref.</i>	Tipo di veicolo <i>Vehicle Type</i>
	914255	60700014000	GASOLONE TS27/28 (1°serie - 1°type)

	Ns.Rif. <i>Our Ref.</i>	Rif.Costr. <i>O.E. Ref.</i>	Tipo di veicolo <i>Vehicle Type</i>

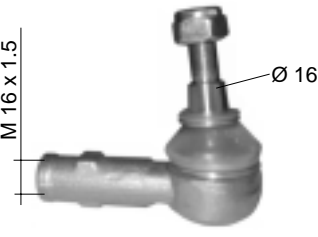
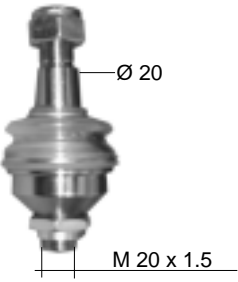
	Ns.Rif. <i>Our Ref.</i>	Rif.Costr. <i>O.E. Ref.</i>	Tipo di veicolo <i>Vehicle Type</i>



	Ns.Rif. <i>Our Ref.</i>	Rif.Costr. <i>O.E. Ref.</i>	Tipo di veicolo <i>Vehicle Type</i>

 <p>Lato Dx-Sx - Rh-Lh Side</p>	<p>Ns.Rif. <i>Our Ref.</i></p> <p>954015</p>	<p>Rif.Costr. <i>O.E. Ref.</i></p> <p>1903652 93804059 93800662</p>	<p>Tipo di veicolo <i>Vehicle Type</i></p> <p>DAILY RESTYLING 28.8-30.8-35.8-40.8-35.10-49.10 NEW DAILY 35.8-40.8-35.10-49.10 TURBO DAILY 35.12-49.12</p>
 <p>Lato Dx-Sx - Rh-Lh Side</p>	<p>Ns.Rif. <i>Our Ref.</i></p> <p>954017</p>	<p>Rif.Costr. <i>O.E. Ref.</i></p> <p>93807545</p>	<p>Tipo di veicolo <i>Vehicle Type</i></p> <p>Testa sospensione anteriore completa di ghiera (Front suspension ball joint with nut) DAILY RESTYLING 28.8-30.8-35.8-40.8-35.10-49.10 NEW DAILY 35.8-40.8-35.10-49.10 TURBO DAILY 35.12-49.12</p>
	<p>Ns.Rif. <i>Our Ref.</i></p> <p>954314</p>	<p>Rif.Costr. <i>O.E. Ref.</i></p> <p>93802356</p>	<p>Tipo di veicolo <i>Vehicle Type</i></p> <p>Ghiera per testa sospensione anteriore (rif.93807545) (Nut for front suspension ball joint) (rif.93807545)</p> <p>DAILY RESTYLING 28.8-30.8-35.8-40.8-35.10-49.10 NEW DAILY 35.8-40.8-35.10-49.10 TURBO DAILY 35.12-49.12</p>
 <p>Lato Dx-Sx - Rh-Lh Side</p>	<p>Ns.Rif. <i>Our Ref.</i></p> <p>954020</p>	<p>Rif.Costr. <i>O.E. Ref.</i></p> <p>504212586</p>	<p>Tipo di veicolo <i>Vehicle Type</i></p> <p>Testa sospensione anteriore (Front suspension ball joint with nut) DAILY M.Y. 2006</p>
	<p>Ns.Rif. <i>Our Ref.</i></p> <p>954315</p>	<p>Rif.Costr. <i>O.E. Ref.</i></p> <p>504212925</p>	<p>Tipo di veicolo <i>Vehicle Type</i></p> <p>Ghiera per testa sospensione anteriore (rif. 504212586) (Nut for front suspension ball joint) (rif. 504212586)</p> <p>DAILY M.Y. 2006</p>

 <p>M 20 x 1.5 Ø 20</p> <p>Lato Dx-Sx - Rh-Lh Side</p>	<p>Ns.Rif. Our Ref.</p> <p>954016</p>	<p>Rif.Costr. O.E. Ref.</p> <p>500310933 93802209</p>	<p>Tipo di veicolo Vehicle Type</p> <p>Testa per tirante sospensione anteriore (Drag link front suspension ball joint) DAILY RESTYLING 35.8 NEW DAILY 35.10 TURBO DAILY 35.12</p>
 <p>M 20 x 1.5 Ø 20</p> <p>Lato Dx-Sx - Rh-Lh Side</p>	<p>Ns.Rif. Our Ref.</p> <p>954014</p>	<p>Rif.Costr. O.E. Ref.</p> <p>500337201 8580735</p>	<p>Tipo di veicolo Vehicle Type</p> <p>DAILY RESTYLING 49.10 TURBO DAILY 49.12</p>
 <p>M 16 x 1.5 Ø 18</p> <p>Lato Dx-Sx - Rh-Lh Side</p>	<p>Ns.Rif. Our Ref.</p> <p>954011</p>	<p>Rif.Costr. O.E. Ref.</p> <p>42534911</p>	<p>Tipo di veicolo Vehicle Type</p> <p>DAILY CITY 2000 35S9/S11/S13/S15 35C9/C11/C13/C15 50C11/C13/C15 65C13/C15</p>
 <p>Conicità 1:10 Ø 18 M 18 x 1.5</p> <p>Dx-Right</p>	<p>Ns.Rif. Our Ref.</p> <p>954018</p>	<p>Rif.Costr. O.E. Ref.</p> <p>4579231 9009501</p>	<p>Tipo di veicolo Vehicle Type</p> <p>35NC-40NC - 625N1-N2-N3 OM40/35 - OM50</p>
 <p>Conicità 1:10 Ø 18 M 18 x 1.5</p> <p>Sx-Left</p>	<p>Ns.Rif. Our Ref.</p> <p>954019</p>	<p>Rif.Costr. O.E. Ref.</p> <p>4579232 9009503</p>	<p>Tipo di veicolo Vehicle Type</p> <p>35NC-40NC - 625N1-N2-N3 OM40/35 - OM50</p>

 <p>Sx-Left</p>	<p>Ns.Rif. Our Ref.</p> <p>954022</p>	<p>Rif.Costr. O.E. Ref.</p> <p>8558527</p> <p>0003309935 1696919</p>	<p>Tipo di veicolo Vehicle Type</p> <p>50NC-55NC-OM50-OM55</p> <p>MERCEDES VOLVO</p>
 <p>Dx-Right</p>	<p>Ns.Rif. Our Ref.</p> <p>954023</p>	<p>Rif.Costr. O.E. Ref.</p> <p>8558524</p> <p>0003309835 1696920</p>	<p>Tipo di veicolo Vehicle Type</p> <p>50NC-55NC-OM50-OM55</p> <p>MERCEDES VOLVO</p>
 <p>Dx-Right</p>	<p>Ns.Rif. Our Ref.</p> <p>954028</p>	<p>Rif.Costr. O.E. Ref.</p> <p>4663787</p>	<p>Tipo di veicolo Vehicle Type</p> <p>645 - 650 - 662N1/N2/N3 - 100.13 - 110.14 - 110NC LUPETTO - LEONCINO - TIGROTTO - BUS 314/3</p>
 <p>Sx-Left</p>	<p>Ns.Rif. Our Ref.</p> <p>954029</p>	<p>Rif.Costr. O.E. Ref.</p> <p>4663791</p>	<p>Tipo di veicolo Vehicle Type</p> <p>645 - 650 - 662N1/N2/N3 - 100.13 - 110.14 - 110NC LUPETTO - LEONCINO - TIGROTTO - BUS 314/3</p>
 <p>Dx-Right</p>	<p>Ns.Rif. Our Ref.</p> <p>954030</p>	<p>Rif.Costr. O.E. Ref.</p> <p>4663972</p>	<p>Tipo di veicolo Vehicle Type</p> <p>673 - 130 - 643</p>

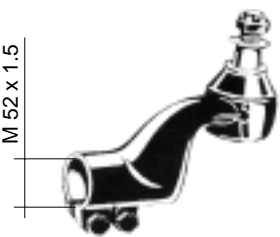
 <p>Ø 24.5</p> <p>M 28 x 1.5</p> <p>Sx-Left</p>	<p>Ns.Rif. Our Ref.</p> <p>954031</p>	<p>Rif.Costr. O.E. Ref.</p> <p>4663974</p>	<p>Tipo di veicolo Vehicle Type</p> <p>673 - 130 - 643</p>
 <p>M 38 x 1.5</p> <p>Ø 28</p> <p>Dx-Right</p>	<p>Ns.Rif. Our Ref.</p> <p>954054</p>	<p>Rif.Costr. O.E. Ref.</p> <p>4664586</p>	<p>Tipo di veicolo Vehicle Type</p> <p>682 T.T. - 690 T.T. - 691N/T - 180NC/NT</p>
 <p>M 45 x 1.5</p> <p>Ø 26</p> <p>Dx-Right</p>	<p>Ns.Rif. Our Ref.</p> <p>954034</p>	<p>Rif.Costr. O.E. Ref.</p> <p>4664349</p>	<p>Tipo di veicolo Vehicle Type</p> <p>682 T.T. - 690 T.T. - 691N-T - 180NC-NT</p>
 <p>M 45 x 1.5</p> <p>Ø 26</p> <p>Sx-Left</p>	<p>Ns.Rif. Our Ref.</p> <p>954035</p>	<p>Rif.Costr. O.E. Ref.</p> <p>4664347</p>	<p>Tipo di veicolo Vehicle Type</p> <p>682 T.T. - 690 T.T. - 691N-T - 180NC-NT</p>
	<p>Ns.Rif. Our Ref.</p>	<p>Rif.Costr. O.E. Ref.</p>	<p>Tipo di veicolo Vehicle Type</p>

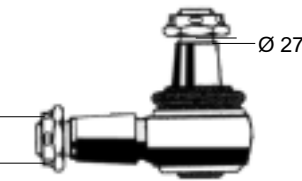
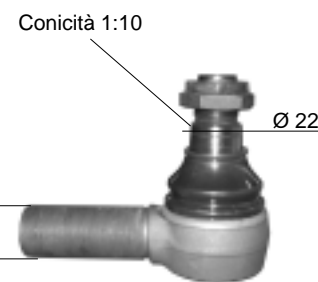
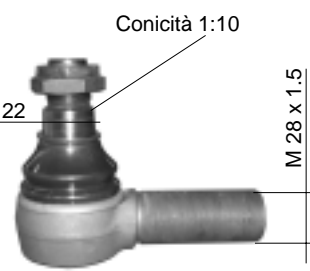
 <p>M 52 x 1.5</p> <p>Dx-Right</p>	Ns.Rif. Our Ref.	Rif.Costr. O.E. Ref.	Tipo di veicolo Vehicle Type
	954038	4732041	684 - 160NC - 619N1 - 697 - 300PC/PT
 <p>M 52 x 1.5</p> <p>30</p> <p>Sx-Left</p>	Ns.Rif. Our Ref.	Rif.Costr. O.E. Ref.	Tipo di veicolo Vehicle Type
	954039	4732042	684 - 160NC - 619N1 - 697 - 300PC/PT
 <p>M 24 x 1.5</p> <p>Ø 27</p> <p>Dx-Right</p>	Ns.Rif. Our Ref.	Rif.Costr. O.E. Ref.	Tipo di veicolo Vehicle Type
	954052	2460515	160.17 - 170.23 - 170.25/34 - 190.25/26/30 260.23/25/34 - 300.32/34 - 330.26/30/35/36 340.34
 <p>Conicità 1:10</p> <p>M 28 x 1.5</p> <p>Ø 22</p> <p>Dx-Right</p>	Ns.Rif. Our Ref.	Rif.Costr. O.E. Ref.	Tipo di veicolo Vehicle Type
	954026	4833825 8558533 607453 81953016249 0003309535 5000823987 1698191	50.8/9 - 50.10 - 60.8/9/10 - 65.10 - 79.10/13 - 80-90.13 80-90NC - ZETA 79-109.14 - OM65-70-75 DAF MAN MERCEDES RENAULT VOLVO
 <p>Conicità 1:10</p> <p>Ø 22</p> <p>M 28 x 1.5</p> <p>Sx-Left</p>	Ns.Rif. Our Ref.	Rif.Costr. O.E. Ref.	Tipo di veicolo Vehicle Type
	954027	4833826 (8558536) 607452 81953016222 0003309635 5000823947 1698190	50.8/9 - 50.10 - 60.8/9/10 - 65.10 - 79.10/13 - 80-90.13 80-90NC - ZETA 79-109.14 - OM65-70-75 DAF MAN MERCEDES RENAULT VOLVO

<p>Conicità 1:10 M 28 x 1.5 Ø 26 Dx-Right</p>	<p>Ns.Rif. Our Ref.</p> <p>954032</p>	<p>Rif.Costr. O.E. Ref.</p> <p>4688941</p>	<p>Tipo di veicolo Vehicle Type</p> <p>ZETA 50.9 - 65.9 - 79.14 - 95.14 - 109.14 TURBOZETA 65.12 115.14/17 - 135.14/17</p>
<p>Conicità 1:10 Ø 26 M 28 x 1.5 Sx-Left</p>	<p>Ns.Rif. Our Ref.</p> <p>954033</p>	<p>Rif.Costr. O.E. Ref.</p> <p>4688942</p>	<p>Tipo di veicolo Vehicle Type</p> <p>ZETA 50.9 - 65.9 - 79.14 - 95.14 - 109.14 TURBOZETA 65.12 115.14/17 - 135.14/17</p>
<p>Conicità 1:10 M 38 x 1.5 Ø 30 Dx-Right</p>	<p>Ns.Rif. Our Ref.</p> <p>954040</p>	<p>Rif.Costr. O.E. Ref.</p> <p>4688948 10229</p>	<p>Tipo di veicolo Vehicle Type</p> <p>175.17 - 175.24 TURBOSTAR 190.36/42/48 - 240.36/48 - 260.36/48 TURBOTECH 190.26/30/32/36 - 220.36 - 240.36 - 260.36 ASTRA</p>
<p>Conicità 1:10 Ø 30 M 38 x 1.5 Sx-Left</p>	<p>Ns.Rif. Our Ref.</p> <p>954041</p>	<p>Rif.Costr. O.E. Ref.</p> <p>4688949 30042</p>	<p>Tipo di veicolo Vehicle Type</p> <p>175.17 - 175.24 TURBOSTAR 190.36/42/48 - 240.36/48 - 260.36/48 TURBOTECH 190.26/30/32/36 - 220.36 - 240.36 - 260.36 ASTRA</p>
	<p>Ns.Rif. Our Ref.</p>	<p>Rif.Costr. O.E. Ref.</p>	<p>Tipo di veicolo Vehicle Type</p>

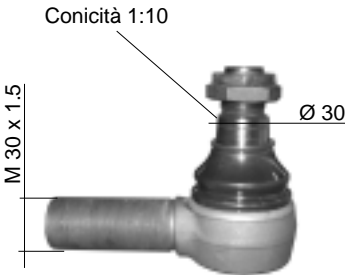
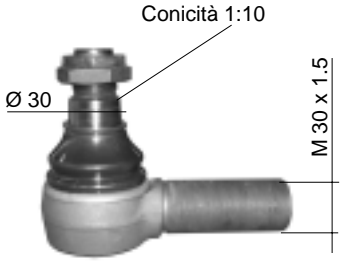
	Ns.Rif. Our Ref.	Rif.Costr. O.E. Ref.	Tipo di veicolo Vehicle Type
 <p>Dx-Right</p>	<p>954012</p>	<p>4833822 4833829 42483386 4802443</p>	<p>EUROCARGO 170E15/E18/E23/E27</p> <p>EUROCARGO TECTOR - TECTOR RESTYLING 180E21/E24/E28</p> <p>EUROTECH 180E34/E38/E42 - 190E34/E38/E42 - 240E26/E34/E38/E42 260E38/E42 - 400E34/E38/E42 - 440E34/E38/E42</p> <p>EUROTECH CURSOR 190E24/E31/E35/E39 - 260E24/E31/E35/E39/E43 440E31/E35/E39/E43</p> <p>EUROSTAR 180E38/E42 - 190E38/E42/E47/E52 400E38/E42/E47/E52 - 440E38/E42/E47/E52</p>
 <p>Sx-Left</p>	<p>954013</p>	<p>4833823 4833830 42489395 4802444</p>	<p>EUROSTAR CURSOR 260E39/E48 - 440E39/E43/E46/E48</p> <p>EUROTRAKKER 190E31/E34/E37/E42 - 260E30/E34/E37/E42 - 330E34/E37 380E31/E34/E37/E42 - 400E31/E34/E37/E42 - 410E42 440E34/E37/E42 - 720E31/E37/E42</p> <p>EUROTRAKKER CURSOR 180E24/E27 - 190E24/E27/E31/E35/E38/E44 260E31/E35/E38/E44/E48 - 340E35/E38/E44 380E35/E38/E44/E48 - 400E38/E44 - 410E35/E44 720E38/E44/E48</p>
	<p>954012 (DX)</p>	<p>113254 698450 81953016234 0004602948 5010832582 395010</p>	<p>ASTRA DAF MAN MERCEDES RENAULT SCANIA</p>
	<p>954013 (SX)</p>	<p>113253 1228115 81953016237 0004603548 5010832583 395009</p>	<p>ASTRA DAF MAN MERCEDES RENAULT SCANIA</p>

 <p>M 30 x 1,5 Ø25.5</p>	<p>Ns.Rif. Our Ref.</p> <p>954300</p>	<p>Rif.Costr. O.E. Ref.</p> <p>93192809</p>	<p>Tipo di veicolo Vehicle Type</p> <p>Testa barra accoppiamento Ball joint for track rod</p> <p>EUROTECH 240E30/E38/E42 - 440E38 EUROSTAR 240E38/E42/E47/E52</p>
 <p>M 26 x 1,5 Ø25.5</p>	<p>Ns.Rif. Our Ref.</p> <p>954301</p>	<p>Rif.Costr. O.E. Ref.</p> <p>42533101</p>	<p>Tipo di veicolo Vehicle Type</p> <p>Testa barra accoppiamento Ball joint for track rod</p> <p>EUROTECH 240E38/E42 EUROTECH CURSOR 260E24/E31/E35/E39/E43 STRALIS 260S27/S31/S35/S40/S43/S48/S54 EUROSTAR 240E38/E42/E47/E52 EUROSTAR CURSOR 260E39/E43/E48</p>
 <p>M 26 x 1,5 Ø25.5</p>	<p>Ns.Rif. Our Ref.</p> <p>954303</p>	<p>Rif.Costr. O.E. Ref.</p> <p>42533102</p>	<p>Tipo di veicolo Vehicle Type</p> <p>Testa barra accoppiamento Ball joint for track rod</p> <p>EUROTECH 240E38/E42 EUROTECH CURSOR 260E24/E31/E35/E39/E43 STRALIS 260S27/S31/S35/S40/S43/S48/S54 EUROSTAR 240E38/E42/E47/E52 EUROSTAR CURSOR 260E39/E43/E48</p>
 <p>M 24 x 1,5 Ø25.5</p>	<p>Ns.Rif. Our Ref.</p> <p>954552</p>	<p>Rif.Costr. O.E. Ref.</p> <p>9281792 817824 82953010011 5000792132</p>	<p>Tipo di veicolo Vehicle Type</p> <p>Testa barra accoppiamento Ball joint for track rod</p> <p>DAF MAN RENAULT</p>
 <p>M 26 x 1,5 Ø25.5</p>	<p>Ns.Rif. Our Ref.</p> <p>954299</p>	<p>Rif.Costr. O.E. Ref.</p> <p>42533073</p>	<p>Tipo di veicolo Vehicle Type</p> <p>Giunto sferico Spherical Joint</p>

L1 1020 mm.		
L2 975 mm.		
Ns Riferim. Our Ref.	Rif. Costr. O.E. Ref.	Tipo di veicolo - Vehicule Type
954071	61595957	100NC - 110NC - 110PC - OM110 - OM110P (Cabina ribaltabile) - (Tilting cab)

L1 979 mm.		
L2 930 mm.		
Ns Riferim. Our Ref.	Rif. Costr. O.E. Ref.	Tipo di veicolo - Vehicule Type
954074	4773359 (4834037)	115.14 - 135.14/17 - 150

L1 980 mm.		
L2 930 mm.		
Ns Riferim. Our Ref.	Rif. Costr. O.E. Ref.	Tipo di veicolo - Vehicule Type
954179	4815933 4834039	145.17

L1 708 mm.		
L2 655 mm.		
Ns Riferim. Our Ref.	Rif. Costr. O.E. Ref.	Tipo di veicolo - Vehicule Type
954065	8570528	ZETA 50.9 - 79.14 TURBOZETA 60.11 - 65.12 - 79.12 (Veicoli con servosterzo e cabina ribaltabile) - (Truck with servo steering and tilting cab)

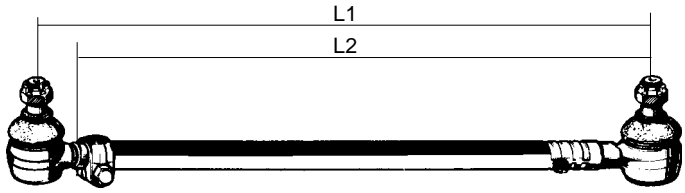
L1 825 mm.		
L2 780 mm.		
Ns Riferim. Our Ref.	Rif. Costr. O.E. Ref.	Tipo di veicolo - Vehicule Type
954185	8591222 8590479 8558522	ZETA 50.9 - 65.9 TURBOZETA 60.11 - 65.12 - 79.12

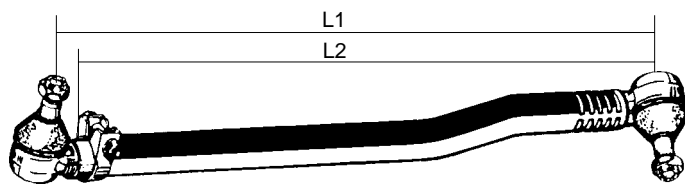
L1 775 mm.		
L2 710 mm.		
Ns Riferim. Our Ref.	Rif. Costr. O.E. Ref.	Tipo di veicolo - Vehicule Type
954063	8567618	ZETA 50.9 - 65.9 - 79.14 TURBOZETA 60.11 - 65.12 - 79.12

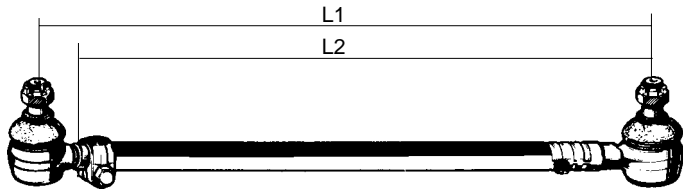
L1 830 mm.		
L2 780 mm.		
Ns Riferim. Our Ref.	Rif. Costr. O.E. Ref.	Tipo di veicolo - Vehicule Type
954060	8559559	50NC - 55NC - 50.8/F8 - 50.9/F9 - 50.10/F10 - 50.9 - 55.8/F8 - 55.9/F9 - 55.10/F10 60.8/F8 - 60.10/F10 - 60.11 TURBOZETA - 65.10/F10 - 70.10/F10 - 75.10/F10 79.10/13/14 - 80.13/F13 - 90.12/13/F13 - OM50 - OM55

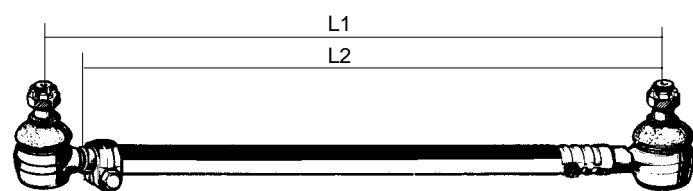
L1 747 mm.		
L2 720 mm.		
Ns Riferim. Our Ref.	Rif. Costr. O.E. Ref.	Tipo di veicolo - Vehicule Type
954066	8564248	ZETA 60.8 - 60.10 - 65.10 - 79.10 - 79.12 - 79.13 - 79.14

L1 982 mm.		
L2 932 mm.		
Ns Riferim. Our Ref.	Rif. Costr. O.E. Ref.	Tipo di veicolo - Vehicle Type
954098	4747961 4747960 42087842	TURBOSTAR 190.36/42/48 - 240.36/48 - 260.36/48 TURBOTECH 190.24/26/30/32/36 - 240.36

L1 890 mm.		
L2 835 mm.		
Ns Riferim. Our Ref.	Rif. Costr. O.E. Ref.	Tipo di veicolo - Vehicle Type
954101	42001326	190.26 - 190.30 330.26 - 330.30 - 330.35 (U.T.)

L1 910 mm.		
L2 855 mm.		
Ns Riferim. Our Ref.	Rif. Costr. O.E. Ref.	Tipo di veicolo - Vehicle Type
954100	42042950	190.26/30H - 260.26/30/35H 330.26/35 - 330.30H (1°serie) 330.36H (1°serie)

Ns Riferim. Our Ref.	Rif. Costr. O.E. Ref.	Tipo di veicolo - Vehicle Type

Copyright della EMMERRE S.p.A. - Tutti i diritti sono riservati e depositati a norma di legge ed a norma delle convenzioni internazionali. - E' vietata la duplicazione o la riproduzione anche parziale senza la previa autorizzazione della EMMERRE S.p.A.

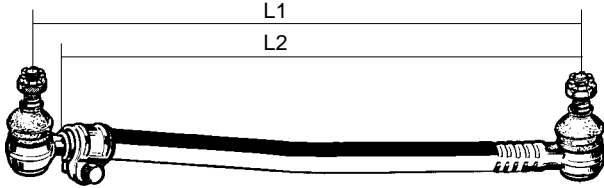
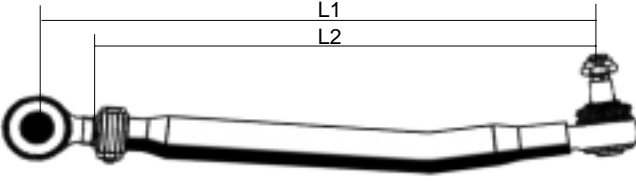
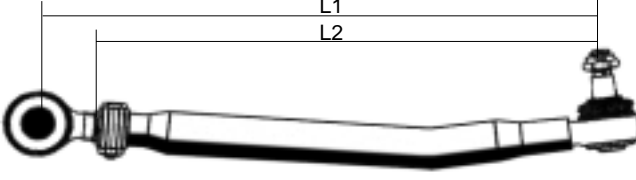
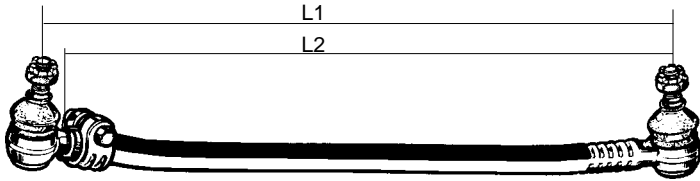
L1 822 mm.		
L2 775 mm.		
Ns Riferim. Our Ref.	Rif. Costr. O.E. Ref.	Tipo di veicolo - Vehicle Type
954136	98402544 (98467459)	EUROCARGO 60E10/E12/E14 - 65E10/E12/E14 - 75E10/E12/E14/E15 80E15/E18/E21 - 100E15/E18/E21 - 180E21 EUROCARGO TECTOR - TECTOR RESTYLING 75E13/E15/E17/E18 - 100E17/E18/E21
L1 1195mm.		
L2 1165mm.		
Ns Riferim. Our Ref.	Rif. Costr. O.E. Ref.	Tipo di veicolo - Vehicle Type
954053	98475709	EUROCARGO 85E18 - 95E18 100E15
L1 966 mm.		
L2 925 mm.		
Ns Riferim. Our Ref.	Rif. Costr. O.E. Ref.	Tipo di veicolo - Vehicle Type
954055	98473328	EUROCARGO 95E15/E21 - 135E18/E23 EUROCARGO TECTOR 100E18/E21 - 150E18/E24 TECTOR RESTYLING 140E24
L1 897 mm.		
L2 850 mm.		
Ns Riferim. Our Ref.	Rif. Costr. O.E. Ref.	Tipo di veicolo - Vehicle Type
954137	4854874	EUROCARGO 120E15/E18/E23 - 130E15/E18/E23 - 150E18/E23/E27R 260E23 - 280E23 - 320E27

L1 803 mm.		
L2 775 mm.		
Ns Riferim. Our Ref.	Rif. Costr. O.E. Ref.	Tipo di veicolo - Vehicule Type
954056	98493054	EUROCARGO 150E15H - 150E18H - 150E21H - 150E23H

L1 878 mm.		
L2 830 mm.		
Ns Riferim. Our Ref.	Rif. Costr. O.E. Ref.	Tipo di veicolo - Vehicule Type
954057	98469650 98449023	EUROCARGO 170E15/E18/E23/E27 EUROCARGO TECTOR 180E21/E24/E28 TECTOR RESTYLING 180E21/E24/E28 - 260E28

L1 770 mm.		
L2 735 mm.		
Ns Riferim. Our Ref.	Rif. Costr. O.E. Ref.	Tipo di veicolo - Vehicule Type
954135	500324282	EUROCARGO TECTOR

L1 901 mm.		
L2 853 mm.		
Ns Riferim. Our Ref.	Rif. Costr. O.E. Ref.	Tipo di veicolo - Vehicule Type
954138	98446354	EUROTECH 180E24/E27/E30/E34 190E24/E27/E30 400E30/E34

Copyright della EMMERRE S.p.A. - Tutti i diritti sono riservati e depositati a norma di legge ed a norma delle convenzioni internazionali. - E' vietata la duplicazione o la riproduzione anche parziale senza la previa autorizzazione della EMMERRE S.p.A.

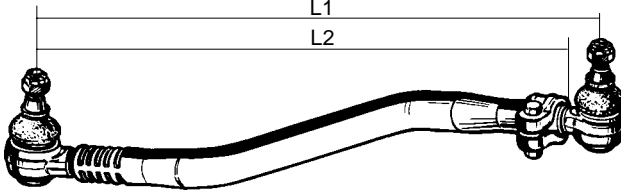
L1 953 mm.		
L2 895 mm.		
Ns Riferim. Our Ref.	Rif. Costr. O.E. Ref.	Tipo di veicolo - Vehicle Type
954139	41005463 8131582	EUROTECH - EUROTECH CURSOR EUROSTAR - EUROSTAR CURSOR EUROTRAKKER - EUROTRAKKER CURSOR STRALIS

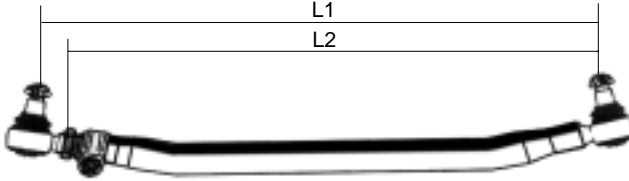
L1 950 mm.		
L2 910 mm.		
Ns Riferim. Our Ref.	Rif. Costr. O.E. Ref.	Tipo di veicolo - Vehicle Type
954058	500397738	EUROTECH CURSOR 190E31/E35/E39/E43 - 260E31/E35/E39/E43 EUROSTAR CURSOR 190E39/E43 - 260E39/E43 STRALIS 190S40/S43/S48 - 260S40/S43/S48/S54 - 440S40/S43/S44/S48/S54

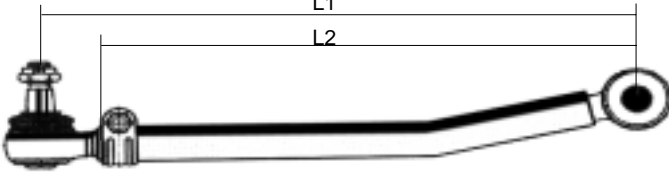
L1 930 mm.		
L2 890 mm.		
Ns Riferim. Our Ref.	Rif. Costr. O.E. Ref.	Tipo di veicolo - Vehicle Type
954059	41005475 41006093	EUROTRAKKER 190E30/E31/E34/E37/E42 - 260E34/E37/E42 - 330E34/E37 - 400E31/E37/E42 - 410E42 EUROTRAKKER CURSOR 180E24 - 190E31/E35 - 380E35 - 410E42

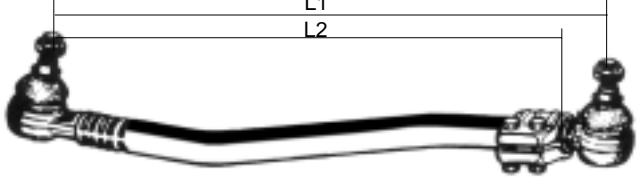
L1 925mm.		
L2 895 mm.		
Ns Riferim. Our Ref.	Rif. Costr. O.E. Ref.	Tipo di veicolo - Vehicle Type
954061	41215165	EUROTRAKKER 190E31/E37/E42 - 260E37/E42 - 380E31/E37/E42 - 720E42 EUROTRAKKER CURSOR 180E24/E27 - 190E31/E35/E38/E44 260E35/E38/E44 - 380E35/E38/E44 - 400E44 - 720E44

L1 887 mm.		
L2 mm.		
Ns Riferim. Our Ref.	Rif. Costr. O.E. Ref.	Tipo di veicolo - Vehicule Type
954072	41028269	CURSOR

L1 693 mm.		
L2 637 mm.		
Ns Riferim. Our Ref.	Rif. Costr. O.E. Ref.	Tipo di veicolo - Vehicule Type
954186	41016964	EUROTRAKKER 410E42 (2°asse)

Ns Riferim. Our Ref.	Rif. Costr. O.E. Ref.	Tipo di veicolo - Vehicule Type

Ns Riferim. Our Ref.	Rif. Costr. O.E. Ref.	Tipo di veicolo - Vehicule Type

Copyright della EMMERRE S.p.A. - Tutti i diritti sono riservati e depositati a norma di legge ed a norma delle convenzioni internazionali. - E' vietata la duplicazione o la riproduzione anche parziale senza la previa autorizzazione della EMMERRE S.p.A.

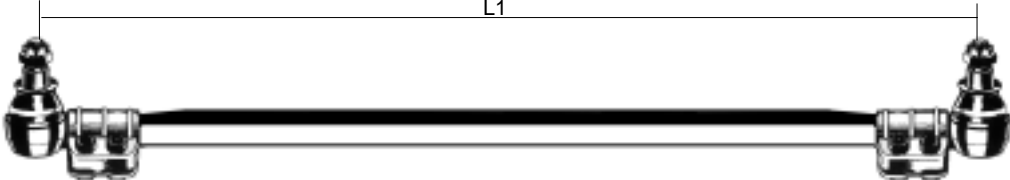
L1 1490 mm.		
L2 1470mm.		
Ns Riferim. Our Ref.	Rif. Costr. O.E. Ref.	Tipo di veicolo - Vehicule Type
954073	98402553 500307556	Barra accoppiamento ruote - Complete track rod EUROCARGO 60E10/E12/E14 - 65E10/E12/E14 - 75E12/E13/E14/E15/E17/E18 80E15/E18/E21 - 100E15/E17/E18/E21 EUROCARGO TECTOR 75E13/E15/E17/E18 - 100E17/E18/E21 EUROCARGO TECTOR RESTYLING 75E13/E15/E17/E18 - 100E17/E18/E21

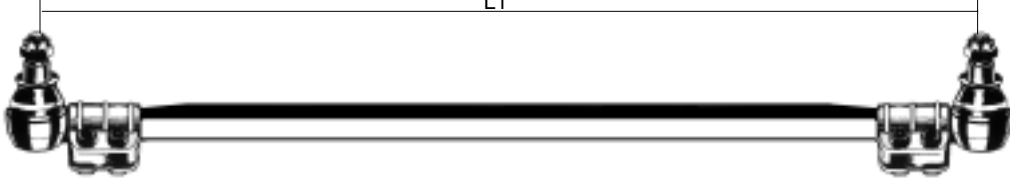
L1 1550 mm.		
L2 1500mm.		
Ns Riferim. Our Ref.	Rif. Costr. O.E. Ref.	Tipo di veicolo - Vehicule Type
954076	4854871	Barra accoppiamento ruote - Complete track rod EUROCARGO - EUROCARGO TECTOR 120-130-150 E15/E18/E23/E24/E28 260E23 - 280E23 - 320E27 - 320E28T

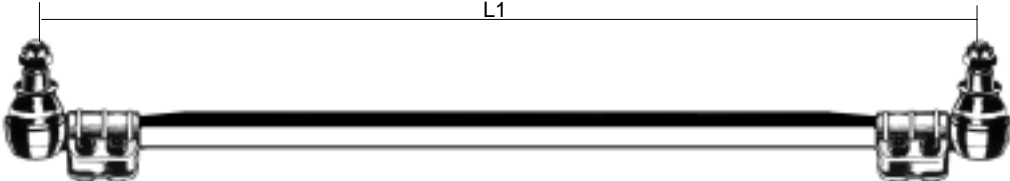
L1 1590 mm.		
L2 1570 mm.		
Ns Riferim. Our Ref.	Rif. Costr. O.E. Ref.	Tipo di veicolo - Vehicule Type
954077	98470968	Barra accoppiamento ruote - Complete track rod EUROCARGO 170E18/E23/E27

L1 1577 mm.		
L2 mm.		
Ns Riferim. Our Ref.	Rif. Costr. O.E. Ref.	Tipo di veicolo - Vehicle Type
954131	8165309	Barra accoppiamento ruote - Complete track rod EUROCARGO 150E15/E18/E21/E23 EUROTRAKKER 190E37 - 260E37 - 340E34/E37/E42 380E37/E42 - 410E37/E42 - 720E37 EUROTRAKKER CURSOR 190E31 - 340E35/E38/E44 380E38/E44 - 410E35/E38/E44/E48

L1 1631 mm.		
L2 1520 mm.		
Ns Riferim. Our Ref.	Rif. Costr. O.E. Ref.	Tipo di veicolo - Vehicle Type
954132	41036943	Barra accoppiamento ruote - Complete track rod EUROTECH CURSOR EUROSTAR CURSOR EUROTRAKKER CURSOR STRALIS



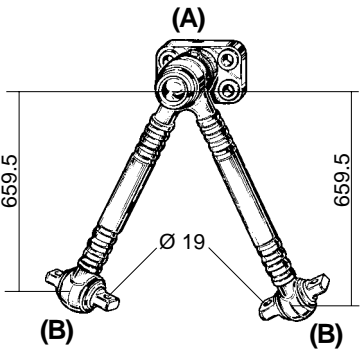
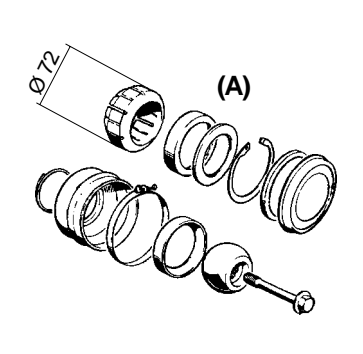
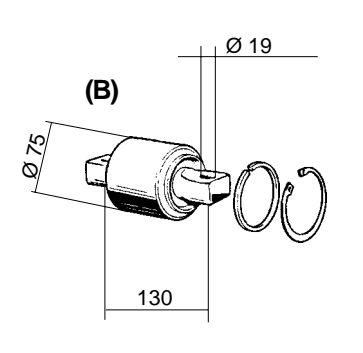
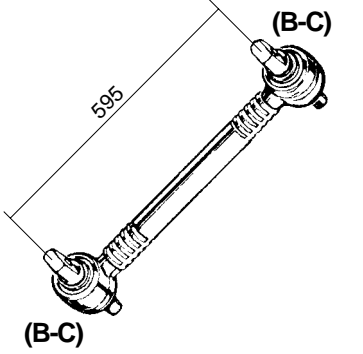
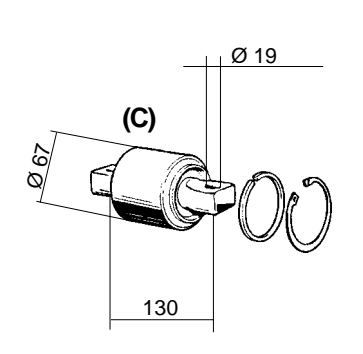

L1 1630mm.		
L2 1550 mm.		
Ns Riferim. Our Ref.	Rif. Costr. O.E. Ref.	Tipo di veicolo - Vehicle Type
954133	8163773 41005450 41005451 41036944	Barra accoppiamento ruote - Complete track rod EUROTECH CURSOR EUROSTAR CURSOR EUROTRAKKER CURSOR STRALIS

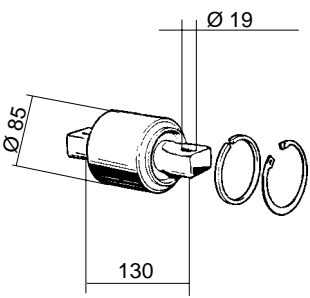
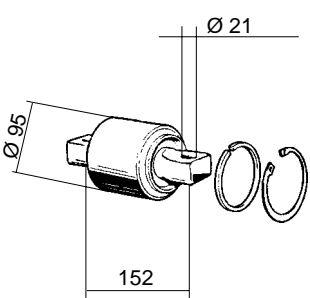
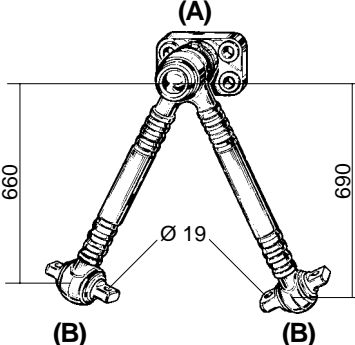
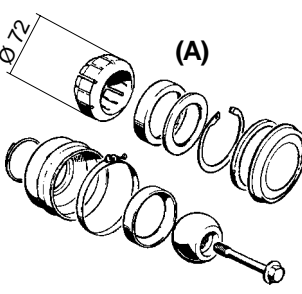
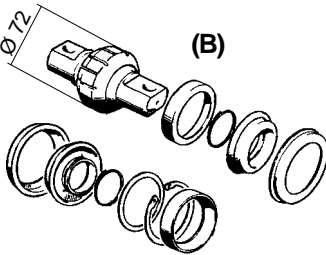
	<p>Ns.Rif. Our Ref.</p> <p>972513</p>	<p>Rif.Costr. O.E. Ref.</p> <p>504064007 41042092 98472468 41028599</p>	<p>Tipo di veicolo Vehicle Type</p> <p>Barra angolare sospensioni Angle torque arm</p> <p>EUROCARGO 120 - 130E15/E18/E23 - 150E15/E18/E23/E27 170E18/E23/E27 - 260E23 - 280E23 - 320E27</p> <p>EUROCARGO TECTOR 130E18/E24/E28 - 150E18/E24/E28</p>
	<p>Ns.Rif. Our Ref.</p> <p>972568</p>	<p>Rif.Costr. O.E. Ref.</p> <p>93161958 (93161631) (A)</p>	<p>Tipo di veicolo Vehicle Type</p> <p>Kit revisione centrale per barra rif. 504064007 Angle torque arm repair central kit ref. 504064007</p> <p>EUROCARGO 120 - 130E15/E18/E23 - 150E15/E18/E23/E27 170E18/E23/E27 - 260E23 - 280E23 - 320E27</p> <p>EUROCARGO TECTOR 130E18/E24/E28 - 150E18/E24/E28</p>
	<p>Ns.Rif. Our Ref.</p> <p>972547</p>	<p>Rif.Costr. O.E. Ref.</p> <p>93192361 (B)</p> <p>67354 0003300207 81432306061</p>	<p>Tipo di veicolo Vehicle Type</p> <p>Silentblock tirante sospensione 504064007-41035951 Torque arm silentblock 504064007-41035951</p> <p>EUROCARGO - EUROCARGO TECTOR 120 - 130E15/E18/E23 - 150E15/E18/E23/E27 170E18/E23/E27 - 260E23 - 280E23 - 320E27</p> <p>DAF MERCEDES MAN</p>
	<p>Ns.Rif. Our Ref.</p> <p>972533</p>	<p>Rif.Costr. O.E. Ref.</p> <p>41035951 98472466 8137027 41009661</p>	<p>Tipo di veicolo Vehicle Type</p> <p>Tirante sospensione Torque arm</p> <p>EUROCARGO 120 - 130E15/E18/E23 - 150E15/E18/E23/E27 170E18/E23/E27 - 260E23 - 280E23 - 320E27</p> <p>EUROCARGO TECTOR 130E18/E24/E28 - 150E18/E24/E28</p>
	<p>Ns.Rif. Our Ref.</p> <p>973060</p>	<p>Rif.Costr. O.E. Ref.</p> <p>93163617 (C)</p>	<p>Tipo di veicolo Vehicle Type</p> <p>Silentblock per tirante sospensione rif. 41035951 Torque arm silentblock ref. 41035951</p> <p>EUROCARGO 120 - 130E15/E18/E23 - 150E15/E18/E23/E27 170E18/E23/E27 - 260E23 - 280E23 - 320E27</p> <p>EUROCARGO TECTOR 130E18/E24/E28 - 150E18/E24/E28</p>

	Ns.Rif. Our Ref.	Rif.Costr. O.E. Ref.	Tipo di veicolo Vehicle Type
	972515	99458576	Tirante sospensione Torque arm EUROCARGO 60E14 - 65E12/E14 - 75E12/E14/E15 - 80E15/E18/E21 85E18 - 95E18 - 100E15/E18/E21
	Ns.Rif. Our Ref.	Rif.Costr. O.E. Ref.	Tipo di veicolo Vehicle Type
	972505	4716799	Barra angolare sospensioni Angle torque arm TURBOSTAR 190.33/36/42/48 TURBOTECH 190.26/32/36 - 220.36
	Ns.Rif. Our Ref.	Rif.Costr. O.E. Ref.	Tipo di veicolo Vehicle Type
	973056	2968454 (A)	Kit revisione centrale barra 4716799 Angle torque arm repair central kit TURBOSTAR 190.33/36/42/48 TURBOTECH 190.26/32/36 - 220.36 691704 271188 DAF VOLVO
	Ns.Rif. Our Ref.	Rif.Costr. O.E. Ref.	Tipo di veicolo Vehicle Type
	973057	2980884 (B)	Kit revisione laterale barra 4716799 e 4744134 Angle torque arm repair lateral kit 4716799 and 4744134 TURBOSTAR 190.33/36/42/48 TURBOTECH 190.26/32/36 - 220.36 1271124 81432206108 DAF MAN
	Ns.Rif. Our Ref.	Rif.Costr. O.E. Ref.	Tipo di veicolo Vehicle Type
	972531	4714134	Tirante sospensione Ø 72 mm. Torque arm Ø 72 mm. TURBOSTAR 190.33/36/42/48 TURBOTECH 190.26/32/36 - 220.36

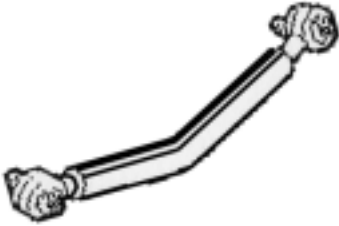
	<p>Ns.Rif. Our Ref.</p> <p>972576</p> <p>972576 972576 972576 972576</p>	<p>Rif.Costr. O.E. Ref.</p> <p>42488722</p> <p>638862 689749 81432206055 82262320660</p>	<p>Tipo di veicolo Vehicle Type</p> <p>Silentblock tirante sospensione 98488010 - 42041107 98488010 Torque arm silentblock 98488010 - 42041107 - 98488010</p> <p>SCANIA DAF MAN KASSBOHRER</p>
	<p>Ns.Rif. Our Ref.</p> <p>972580</p>	<p>Rif.Costr. O.E. Ref.</p> <p>42493431</p> <p>0003500413 81432706040</p>	<p>Tipo di veicolo Vehicle Type</p> <p>Silentblock tirante sospensione Torque arm silentblock</p> <p>MERCEDES MAN</p>
	<p>Ns.Rif. Our Ref.</p> <p>972506</p>	<p>Rif.Costr. O.E. Ref.</p> <p>4716271</p>	<p>Tipo di veicolo Vehicle Type</p> <p>Barra angolare sospensioni Angle torque arm</p> <p>TURBOSTAR 190.33/36/42/48 TURBOTECH 190.26/32/36 - 220.36</p>
	<p>Ns.Rif. Our Ref.</p> <p>973056</p>	<p>Rif.Costr. O.E. Ref.</p> <p>2968454 (A)</p> <p>691704 271188</p>	<p>Tipo di veicolo Vehicle Type</p> <p>Kit revisione centrale barra 4716271 Angle torque arm repair central kit 4716271</p> <p>TURBOSTAR 190.33/36/42/48 TURBOTECH 190.26/32/36 - 220.36</p> <p>DAF VOLVO</p>
	<p>Ns.Rif. Our Ref.</p> <p>973057</p>	<p>Rif.Costr. O.E. Ref.</p> <p>2980884 (B)</p> <p>2980884 81432206108</p>	<p>Tipo di veicolo Vehicle Type</p> <p>Kit revisione laterale barra 4716271 Angle torque arm repair lateral kit 4716271</p> <p>TURBOSTAR 190.33/36/42/48 TURBOTECH 190.26/32/36 - 220.36</p> <p>IVECO MAN</p>

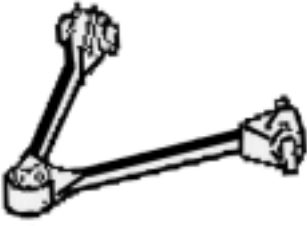
	Ns.Rif. Our Ref.	Rif.Costr. O.E. Ref.	Tipo di veicolo Vehicle Type
	972532	42125057	Tirante sospensione Ø 80 mm. Torque arm Ø 80 mm. TURBOSTAR 190.33/36/42/48 TURBOTECH 190.26/32/36 - 220.36
	Ns.Rif. Our Ref.	Rif.Costr. O.E. Ref.	Tipo di veicolo Vehicle Type
	973055	93161371 (C)	Kit revisione tirante sospensione 42125057 Torque arm repair kit 42125057 TURBOSTAR 190.33/36/42/48 TURBOTECH 190.26/32/36 - 220.36
	Ns.Rif. Our Ref.	Rif.Costr. O.E. Ref.	Tipo di veicolo Vehicle Type
	972512	41034479 41042050 41028598	Barra angolare sospensioni Angle torque arm EUROTECH - EUROTECH CURSOR EUROSTAR - EUROSTAR CURSOR EUROTRAKKER - EUROTRAKKER CURSOR STRALIS
	Ns.Rif. Our Ref.	Rif.Costr. O.E. Ref.	Tipo di veicolo Vehicle Type
	972568	93161958 93161631 (A)	Kit revisione centrale barra 41042050 Angle torque arm repair central kit 41042050 EUROTECH - EUROTECH CURSOR EUROSTAR - EUROSTAR CURSOR EUROTRAKKER - EUROTRAKKER CURSOR STRALIS
	Ns.Rif. Our Ref.	Rif.Costr. O.E. Ref.	Tipo di veicolo Vehicle Type
	972567	93161960 (B)	Silentblock laterale barra angolare 41042050 Angle torque arm lateral silentblock 41042050 EUROTECH - EUROTECH CURSOR EUROSTAR - EUROSTAR CURSOR EUROTRAKKER - EUROTRAKKER CURSOR STRALIS

	Ns.Rif. Our Ref.	Rif.Costr. O.E. Ref.	Tipo di veicolo Vehicle Type
	972541	41034330	Barra sospensione longitudinale Longitudinal suspension bar EUROTECH CURSOR EUROSTAR CURSOR STARLIS
	Ns.Rif. Our Ref.	Rif.Costr. O.E. Ref.	Tipo di veicolo Vehicle Type
	973030	93161637	Kit revisione barra sospensione longitudinale 41034330 Longitudinal suspension bar 41034330 repairing kit EUROTECH CURSOR EUROSTAR CURSOR STARLIS
	Ns.Rif. Our Ref.	Rif.Costr. O.E. Ref.	Tipo di veicolo Vehicle Type
	972552	98454109	Barra angolare sospensioni Angle torque arm IVECO EUROCARGO 260E23/E27KE/E28KE EUROCARGO TECTOR 260E24 EUROMOVER
	Ns.Rif. Our Ref.	Rif.Costr. O.E. Ref.	Tipo di veicolo Vehicle Type
	972551	41042093	Barra angolare Angle torque arm IVECO GAMMA CURSOR EUROSTAR EUROTECH EUROTRAKKER STRALIS
	Ns.Rif. Our Ref.	Rif.Costr. O.E. Ref.	Tipo di veicolo Vehicle Type
	973053	93162239	Kit revisione barra sospensione Suspension bar repairing kit IVECO EUROCARGO EUROTECH - EUROTRAKKER - EUROSTAR STRALIS

	<p>Ns.Rif. Our Ref.</p> <p>972533</p>	<p>Rif.Costr. O.E. Ref.</p> <p>41035951 98472466 41009661</p>	<p>Tipo di veicolo Vehicle Type</p> <p>Tirante sospensione Torque arm</p> <p>EUROCARGO TECTOR 180E21/E24/E28 EUROTECH - EUROTECH CURSOR EUROSTAR - EUROSTAR CURSOR EUROTRAKKER - EUROTRAKKER CURSOR STRALIS</p>
	<p>Ns.Rif. Our Ref.</p> <p>972547</p>	<p>Rif.Costr. O.E. Ref.</p> <p>93192361 (C)</p>	<p>Tipo di veicolo Vehicle Type</p> <p>Silentblock tirante sospensione 41035951 Torque arm silentblock 41035951</p> <p>EUROCARGO TECTOR 180E21/E24/E28 EUROTECH - EUROTECH CURSOR EUROSTAR - EUROSTAR CURSOR EUROTRAKKER - EUROTRAKKER CURSOR STRALIS</p>
	<p>Ns.Rif. Our Ref.</p> <p>972502</p>	<p>Rif.Costr. O.E. Ref.</p> <p>42041107 41011008</p>	<p>Tipo di veicolo Vehicle Type</p> <p>Tirante sospensione Torque arm</p> <p>EUROTECH 240E34/E38/E42 - 260E42 - 440E38/E42 EUROTECH CURSOR 260E24/E31/E35/E43 EUROSTAR 240E42/E47 - 260E47/E52 - 440E42/E52 EUROTRAKKER 260E30/E34/E37/E42-340-440E34/E37/E42 EUROTRAKKER CURSOR 260E31/E35/E38/E44/E48 340E35/E38/E44 - 440E38/E44 STRALIS 260S31/S35/S43</p>
	<p>Ns.Rif. Our Ref.</p> <p>972503</p>	<p>Rif.Costr. O.E. Ref.</p> <p>93192618</p>	<p>Tipo di veicolo Vehicle Type</p> <p>Silentblock tirante sospensione 42041107 Torque arm silentblock 42041107</p> <p>EUROTECH 240E34/E38/E42 - 260E42 - 440E38/E42 EUROTECH CURSOR 260E24/E31/E35/E43 EUROSTAR 240E42/E47 - 260E47/E52 - 440E42/E52 EUROTRAKKER 260E30/E34/E37/E42-340-440E34/E37/E42 EUROTRAKKER CURSOR 260E31/E35/E38/E44/E48 340E35/E38/E44 - 440E38/E44 STRALIS 260S31/S35/S43</p>

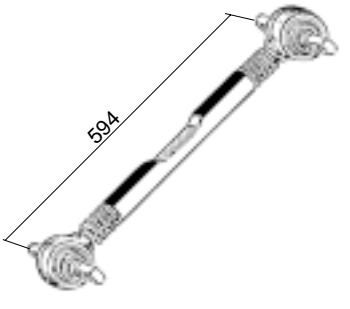
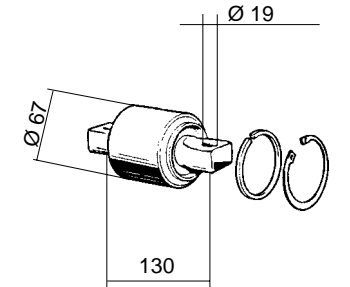
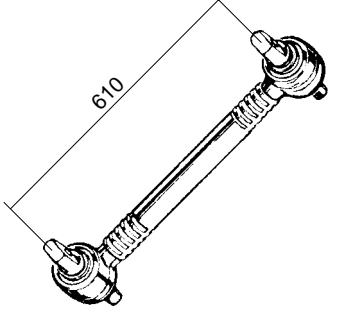
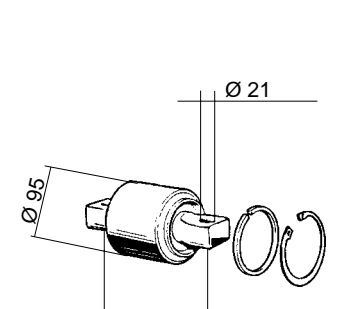
	Ns.Rif. Our Ref. 972507	Rif.Costr. O.E. Ref. 98472871	Tipo di veicolo Vehicle Type Tirante sospensione Torque arm EUROTECH 180E24/E27/E30/E34 - 190E24/E27/E30 325E27 - 400E30/E34
	Ns.Rif. Our Ref. 973060	Rif.Costr. O.E. Ref. 93163617	Tipo di veicolo Vehicle Type Silentblock tirante sospensione 98472871 Torque arm silentblock 98472871 EUROTECH 180E24/E27/E30/E34 - 190E24/E27/E30 325E27 - 400E30/E34
	Ns.Rif. Our Ref. 972542	Rif.Costr. O.E. Ref. 41011006 42065332	Tipo di veicolo Vehicle Type Tirante sospensione Torque arm EUROTRAKKER 330E34/E37 - 380E31/E34/E37/E42/E47 - 410E37/E42 720E31/E37/E42/E47 EUROTRAKKER CURSOR 380-410E35/E38/E44/E48 - 720E38/E44/E48
	Ns.Rif. Our Ref. 972580	Rif.Costr. O.E. Ref. 42493431 81432706040 0003500413	Tipo di veicolo Vehicle Type Silentblock tirante sospensione 41011006 Torque arm silentblock 41011006 EUROTRAKKER 330E34/E37 - 380E31/E34/E37/E42/E47 - 410E37/E42 720E31/E37/E42/E47 EUROTRAKKER CURSOR 380-410E35/E38/E44/E48 - 720E38/E44/E48 MAN MERCEDES
	Ns.Rif. Our Ref.	Rif.Costr. O.E. Ref.	Tipo di veicolo Vehicle Type

<p>Ø 27 M 30 x 1.5 Dx-Right</p>	Ns.Rif. Our Ref.	Rif.Costr. O.E. Ref.	Tipo di veicolo Vehicle Type
	954000	500340769	Testa barra accoppiamento Ball joint for track rod CITYCLASS .25 - .29 - .31 - .35 491 - 591D

L1 637 mm.		
L2 mm.		
Ns Riferim. Our Ref.	Rif. Costr. O.E. Ref.	Tipo di veicolo - Vehicle Type
973046	4738069	Barra reazione ponte posteriore Rear bridge torque arm BUS 370 T.T.

L1 1267 mm.		
L2 mm.		
Ns Riferim. Our Ref.	Rif. Costr. O.E. Ref.	Tipo di veicolo - Vehicle Type
954252	98489741	Barra accoppiamento ruote Complete track rod BUS EURORIDER .29 - .35 - 26A - 31 - 35 - 38 - 43

L1 845 mm.		
L2 800 mm.		
Ns Riferim. Our Ref.	Rif. Costr. O.E. Ref.	Tipo di veicolo - Vehicle Type
954140	4711108	BUS 370.12/20 - 370.12/25 - 370S24/S25 - 629E35

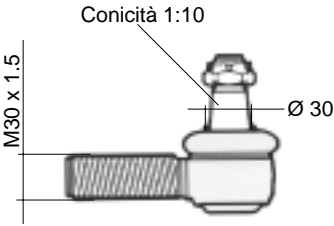
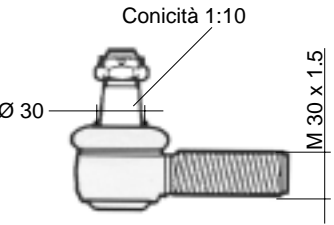
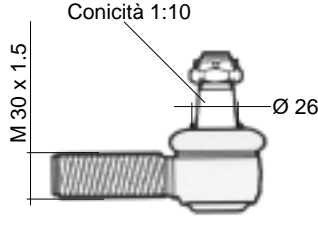
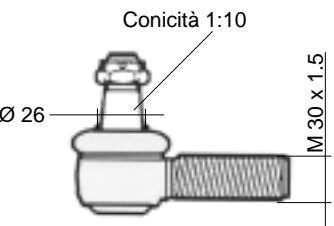
	Ns.Rif. Our Ref.	Rif.Costr. O.E. Ref.	Tipo di veicolo Vehicle Type
 <p>Conicità 1:10</p> <p>M30 x 1.5</p> <p>Ø 30</p> <p>Dx-Right</p>	954012	81953016234 81953016242 113254 698450 4833822 0004602948 5010832582 395010	MAN Serie F90 - F2000 MAN Serie M90 - M2000 ASTRA DAF IVECO MERCEDES RENAULT SCANIA
 <p>Conicità 1:10</p> <p>Ø 30</p> <p>M 30 x 1.5</p> <p>Sx-Left</p>	954013	81953016237 81953016179 113253 1228115 4833823 0004603548 5010832583 395009	MAN Serie F90 - F2000 MAN Serie M90 - M2000 ASTRA DAF IVECO MERCEDES RENAULT SCANIA
 <p>Conicità 1:10</p> <p>M 30 x 1.5</p> <p>Ø 26</p> <p>Dx-Right</p>	954112	81953016272 81953016239 90804153111 698609 4833827 00013300135 5000295214	MAN Serie F90 - F2000 MAN Serie M90 - M2000 DAF IVECO MERCEDES RENAULT
 <p>Conicità 1:10</p> <p>Ø 26</p> <p>M 30 x 1.5</p> <p>Sx-Left</p>	954110	81953016273 81953016163 90804153113 607998 4833828 3023300335 5000295215	MAN Serie F90 - F2000 MAN Serie M90 - M2000 DAF IVECO MERCEDES RENAULT

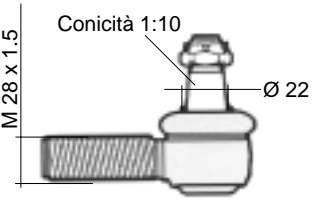
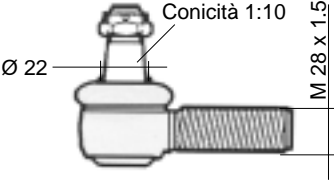
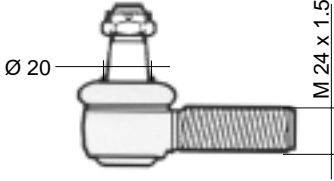
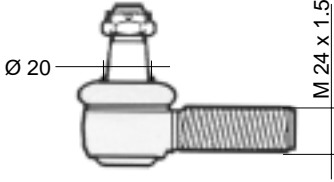
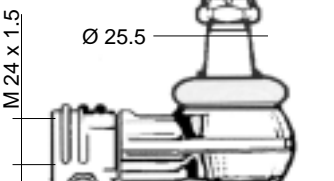
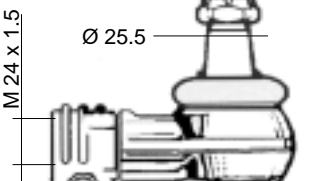
 <p>Dx-Right</p>	Ns.Rif. <i>Our Ref.</i>	Rif.Costr. <i>O.E. Ref.</i>	Tipo di veicolo <i>Vehicle Type</i>
 <p>Sx-Left</p>	954026	81953016249 607453 4833825 0003309535 5000823987 1698191	MAN Serie G90 - L2000 - M2000 DAF IVECO MERCEDES RENAULT VOLVO
 <p>Sx-Left</p>	954027	81953016222 607452 4833826 0003309635 5000823947 1698190	MAN Serie G90 - L2000 - M2000 DAF IVECO MERCEDES RENAULT VOLVO
 <p>Sx-Left</p>	954216	81953016141 0003308635 5000814096 1517448	Testa barra accoppiamento SX Ball joint Left MAN L2000 MERCEDES RENAULT VOLVO F4
 <p>Dx-Right</p>	954217	81953016142 0003308535 5000814097 1517449	Testa barra accoppiamento DX Ball joint Left MAN L2000 MERCEDES RENAULT VOLVO F4
	954552	82953010011 9281792 817824 5000792132	Testa barra accoppiamento Ball joint for track rod IVECO DAF RENAULT

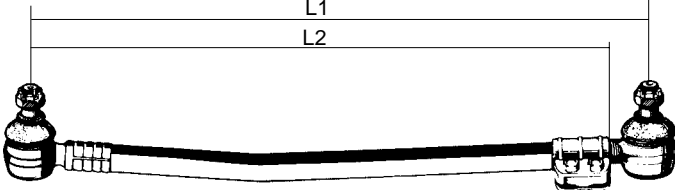
L1 785 mm.		
L2 760 mm.		
Ns Riferim. Our Ref.	Rif. Costr. O.E. Ref.	Tipo di veicolo - Vehicule Type
954188	81466106328 81466106305 81466106301	MAN Serie G90 6 ton - 8 ton - 9 ton - 10 ton (1987-1994)

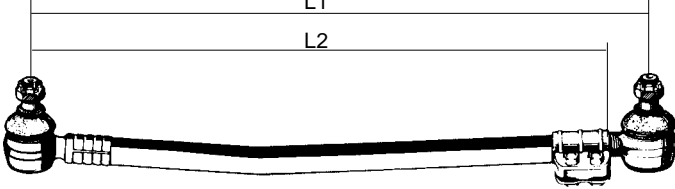
L1 1038 mm.		
L2 1000 mm.		
Ns Riferim. Our Ref.	Rif. Costr. O.E. Ref.	Tipo di veicolo - Vehicule Type
954189	81467106434 81467106435 81467106456	MAN Serie M90 12.152 - 12.192 - 12.222 - 12.232 - 12.262 - 12.272 14.152 - 14.162 - 14.192 - 14.222 - 14.232 - 14.262 - 14.272

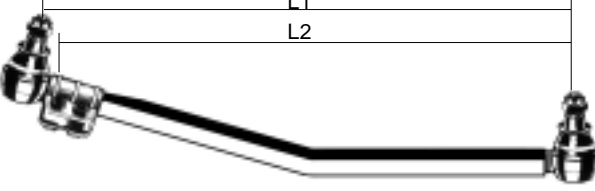
L1 820 mm.		
L2 790 mm.		
Ns Riferim. Our Ref.	Rif. Costr. O.E. Ref.	Tipo di veicolo - Vehicule Type
954078	85466106140	MAN Serie M2000 (dal 08/95 - from 08/95)

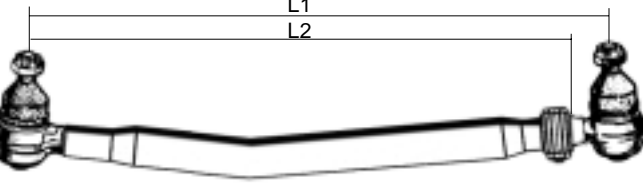
L1 825 mm.		
L2 790 mm.		
Ns Riferim. Our Ref.	Rif. Costr. O.E. Ref.	Tipo di veicolo - Vehicule Type
954079	85466106104 81466106754 81466106753	MAN L2000 8.103 - 8.113 - 8.145 - 8.153 - 8.163 - 8.185 - 8.223 - 8.224 - 8.225 MAN L2000 9.145 - 9.153 - 9.163 - 9.185 - 9.223 - 9.224 - 9.225 MAN L2000 10.145 - 10.153 - 10.163 - 10.185 - 10.223 - 10.224 - 10.225

L1 770 mm.		
L2 665 mm.		
Ns Riferim. Our Ref.	Rif. Costr. O.E. Ref.	Tipo di veicolo - Vehicule Type
972517	81466106348	MAN F90 32.262 - 32.272 - 32.292 - 32.302 - 32.322 - 32.332 - 32.342 - 32.362 - 32.372 - 32.402 32.422 - 35.262 - 35.272 - 35.292 - 35.302 - 35.322 - 35.362 35.372 - 35.402 - 35.422 - 41.262 - 41.272 - 41.292 - 41.322 - 41.362 - 41.372 41.402 - 41.422

L1 1038 mm.		
L2 1000 mm.		
Ns Riferim. Our Ref.	Rif. Costr. O.E. Ref.	Tipo di veicolo - Vehicule Type
954157	81466106722 81466106723 81466106721	MAN Serie F90 - F2000

L1 980 mm.		
L2 950 mm.		
Ns Riferim. Our Ref.	Rif. Costr. O.E. Ref.	Tipo di veicolo - Vehicule Type
954080	81466116197 81466116133 81466116132 81466116087 81466116096	MAN TG-A 18.310 - 18.360 - 18.410 - 18.460 - 18.480 - 18.510 - 18.530 26.310 - 26.360 - 26.410 - 26.460 - 26.510 - 26.530 (dal 04/2000 - from 04/2000) 32.310 - 32.360 - 32.410 - 32.460 - 32.480 (dal 2002 - from 2002) 33.360 - 33.400 - 33.460 - 33.480 - 33.510 (dal 2002 - from 2002)

L1 1040 mm.		
L2 1010 mm.		
Ns Riferim. Our Ref.	Rif. Costr. O.E. Ref.	Tipo di veicolo - Vehicule Type
954222	81466116004	MAN F2000 19.233 - 19.273 - 19.293 - 19.323 - 19.343 - 19.373 - 19.403 - 26.373

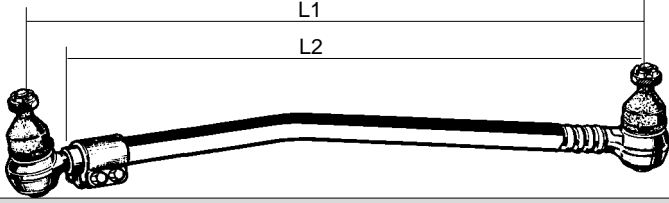
L1 810mm.		
L2 785 mm.		
Ns Riferim. Our Ref.	Rif. Costr. O.E. Ref.	Tipo di veicolo - Vehicule Type
954223	85466106102	MAN L2000 - M2000

Ns Riferim. Our Ref.	Rif. Costr. O.E. Ref.	Tipo di veicolo - Vehicule Type

Ns Riferim. Our Ref.	Rif. Costr. O.E. Ref.	Tipo di veicolo - Vehicule Type

Ns Riferim. Our Ref.	Rif. Costr. O.E. Ref.	Tipo di veicolo - Vehicule Type

L1 1652 mm.		
L2 1540 mm.		
Ns Riferim. Our Ref.	Rif. Costr. O.E. Ref.	Tipo di veicolo - Vehicule Type
954190	81467116725 81467106353 81467106361 81467106354	Barra di accoppiamento ruote - Complete track rod MAN F90 - F2000 M90 - M2000 TG-A
L1 1628 mm.		
L2 1570 mm.		
Ns Riferim. Our Ref.	Rif. Costr. O.E. Ref.	Tipo di veicolo - Vehicule Type
954176	81467106904 81467116724 81467106816	Barra di accoppiamento ruote - Complete track rod MAN F90 - F2000 M90 - M2000
L1 mm.		
L2 mm.		
Ns Riferim. Our Ref.	Rif. Costr. O.E. Ref.	Tipo di veicolo - Vehicule Type
954309	81467116860 81467116861 81467116773 81467116858	Barra di accoppiamento ruote - Complete track rod MAN TG-A (dal 09/2002 - from 09/2002)
L1 728 mm.		
L2 mm.		
Ns Riferim. Our Ref.	Rif. Costr. O.E. Ref.	Tipo di veicolo - Vehicule Type
954215	81467116759 81467106081 81467116761	Barra di accoppiamento ruote - Complete track rod MAN TG-A (dal 09/2002 - from 09/2002)

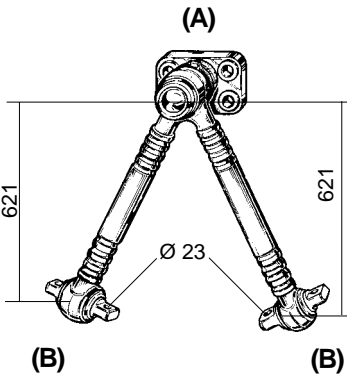
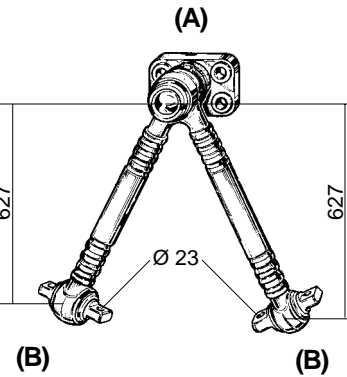
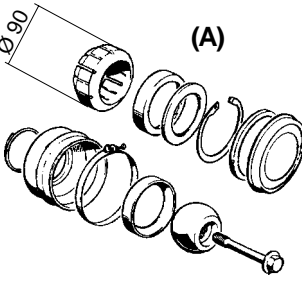
	Ns.Rif. Our Ref.	Rif.Costr. O.E. Ref.	Tipo di veicolo Vehicle Type
 <p>(A)</p> <p>621</p> <p>621</p> <p>Ø 23</p> <p>(B) (B)</p> <p>Sospensione Pneumatica Pneumatic suspension</p>	<p>972508</p>	<p>81432706078 81432706076 81432706074 81432706082 81432706034 81432706054</p>	<p>Barra angolare sospensioni Angle torque arm</p> <p>MAN F90 - F2000 13.168 - 14.192 - 15.168 -15.232 - 15.240 - 16.280 - 16.281 16.321 - 19.272 - 19.281 - 19.292 - 19.302 - 19.321 -19.322 19.361 - 19.362 - 19.362 - 19.372 - 19.422 -19.462 - 20.281 20.320 - 20.321 - 22.280 - 22.281- 22.281 - 22.240 - 22.320 22.321 - 22.241 - 22.321 - 26.262 - 26.292 26.332 - 26.362 - 26.462</p>
 <p>(A)</p> <p>627</p> <p>627</p> <p>Ø 23</p> <p>(B) (B)</p> <p>Sospensione Meccanica Mechanical suspension</p>	<p>972526</p>	<p>81432709056 81432706077 81432706075 81432706081 81432706056 81432706067</p>	<p>Barra angolare sospensioni Angle torque arm</p> <p>MAN F90 - F2000 (dal1988 - from 1988)</p>
 <p>(A)</p> <p>Ø 90</p>	<p>972521</p>	<p>81953016132 (A)</p>	<p>Kit revisione centrale barra 81432706078 - 81432709056 Angle torque arm repair central kit 81432706078 - 9056</p> <p>MAN F90 - F2000 13.168 - 14.192 - 15.168 -15.232 - 15.240 - 16.280 - 16.281 16.321 - 19.272 - 19.281 - 19.292 - 19.302 - 19.321 -19.322 19.361 - 19.362 - 19.362 - 19.372 - 19.422 -19.462 - 20.281 20.320 - 20.321 - 22.280 - 22.281- 22.281 - 22.240 - 22.320 22.321 - 22.241 - 22.321 - 26.262 - 26.292 26.332 - 26.362 - 26.462</p>

	Ns.Rif. Our Ref.	Rif.Costr. O.E. Ref.	Tipo di veicolo Vehicle Type
	972549	81953016133 (B)	Kit revisione laterale barra 81432706078 - 81432709056 Angle torque arm repair lateral kit 81432706078 - 9056 MAN F90 - F2000 13.168 - 14.192 - 15.168 - 15.232 - 15.240 - 16.280 - 16.281 16.321 - 19.272 - 19.281 - 19.292 - 19.302 - 19.321 - 19.322 19.361 - 19.362 - 19.362 - 19.372 - 19.422 - 19.462 - 20.281 20.320 - 20.321 - 22.280 - 22.281 - 22.281 - 22.240 - 22.320 22.321 - 22.241 - 22.321 - 26.262 - 26.292 26.332 - 26.362 - 26.4620 VOLVO

	Ns.Rif. Our Ref.	Rif.Costr. O.E. Ref.	Tipo di veicolo Vehicle Type
	972509	81432206140	Tirante sospensione Torque arm MAN L2000 - M2000 (dal 08/1995 - from 08/1995)

L1 1590 mm.		AD ESAURIMENTO
L2 1540 mm.		

Ns Riferim. Our Ref.	Rif. Costr. O.E. Ref.	Tipo di veicolo - Vehicule Type
972510	81467106852 81467116719	Tirante sospensione Torque arm MAN L2000 8.103 - 8.113 - 8.150 - 8.153 - 8.163 - 8.220 - 8.223 - 8.224-9.153 - 9.163 - 9.223 - 9.224 10.150 - 10.153 - 10.163 - 10.220 - 10.223 - 10.224 MAN M2000 12.136 - 12.224

DISPONIBILE A MAGAZZINO	Ns.Rif. Our Ref.	Rif.Costr. O.E. Ref.	Tipo di veicolo Vehicle Type
	972556	81432206285	Silentblock revisione trapezio Angle torque arm silentblock MAN TGA U.T.

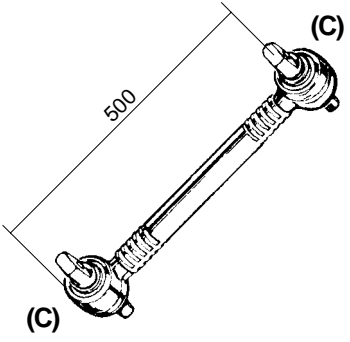
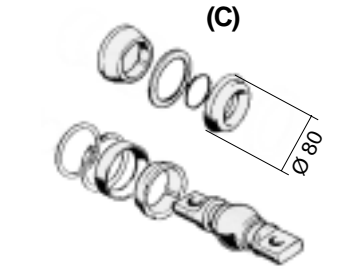
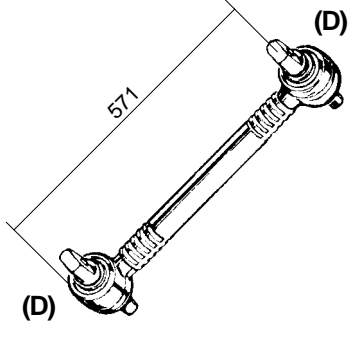
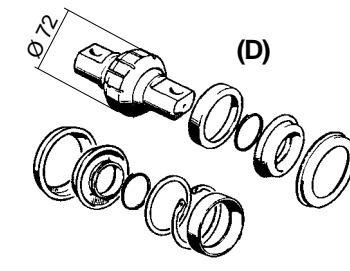
	<p>Ns.Rif. Our Ref.</p> <p>972539</p>	<p>Rif.Costr. O.E. Ref.</p> <p>81432306037 81432309037</p>	<p>Tipo di veicolo Vehicle Type</p> <p>Tirante sospensione Torque arm</p> <p>MAN F90 - F2000 13.168 - 13.192 - 14.168 - 14.192 - 14.220 - 15.168 - 15.192 15.220 - 15.232 - 15.240 - 16.168 - 16.170 - 16.192 - 16.220 16.240 - 16.280 - 16.320 - 16.321 - 16.361 - 17.170 - 17.192 19.280 - 19.320 - 19.321 - 19.361 - 20.281 - 20.321 - 22.192 22.280 - 22.281 - 22.320 - 24.220 - 24.291 - 24.220</p>
	<p>Ns.Rif. Our Ref.</p> <p>972540</p>	<p>Rif.Costr. O.E. Ref.</p> <p>81432306043 (C)</p>	<p>Tipo di veicolo Vehicle Type</p> <p>Kit revisione tirante sospensione 81432306037 Torque arm repair kit 81432306037</p> <p>MAN F90 - F2000 13.168 - 13.192 - 14.168 - 14.192 - 14.220 - 15.168 - 15.192 15.220 - 15.232 - 15.240 - 16.168 - 16.170 - 16.192 - 16.220 16.240 - 16.280 - 16.320 - 16.321 - 16.361 - 17.170 - 17.192 19.280 - 19.320 - 19.321 - 19.361 - 20.281 - 20.321 - 22.192 22.280 - 22.281 - 22.320 - 24.220 - 24.291 - 24.220</p>
	<p>Ns.Rif. Our Ref.</p> <p>972255</p>	<p>Rif.Costr. O.E. Ref.</p> <p>81432206129 81432206096 81432206097 81432206098 81432306014 81432306030</p>	<p>Tipo di veicolo Vehicle Type</p> <p>Tirante sospensione Torque arm</p> <p>MAN F90 - F2000 16.170 - 16.192 - 17.170 - 17.192 - 19.242 - 19.262 19.292 - 19.332 - 19.362 - 19.462 - 19.272 - 19.302 19.322 - 19.372 - 19.422 - 19.502 - 24.242 - 24.262 24.292 - 24.332 - 24.362 - 24.462 - 24.272 - 24.302 24.322 - 24.372 - 24.422 - 24.322 - 25.372 - 25.422 26.272 - 26.302 - 26.322 - 26.372 - 26.422 - 26.502</p>
	<p>Ns.Rif. Our Ref.</p> <p>973057</p>	<p>Rif.Costr. O.E. Ref.</p> <p>81432206108 (D)</p> <p>1271124 2980884</p>	<p>Tipo di veicolo Vehicle Type</p> <p>Kit revisione tirante sospensione 81432206129 Torque arm repair kit 81432206129</p> <p>MAN F90 - F2000 16.170 - 16.192 - 17.170 - 17.192 - 19.242 - 19.262 19.292 - 19.332 - 19.362 - 19.462 - 19.272 - 19.302 19.322 - 19.372 - 19.422 - 19.502 - 24.242 - 24.262 24.292 - 24.332 - 24.362 - 24.462 - 24.272 - 24.302 24.322 - 24.372 - 24.422 - 24.322 - 25.372 - 25.422 26.272 - 26.302 - 26.322 - 26.372 - 26.422 - 26.502</p> <p>DAF IVECO</p>

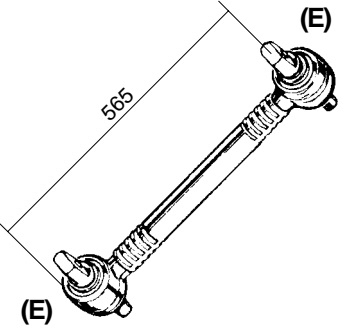
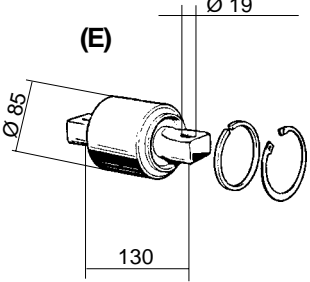
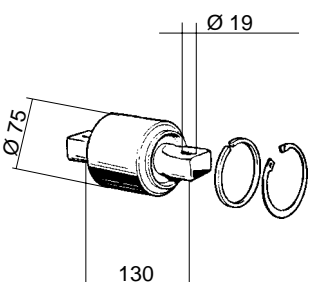
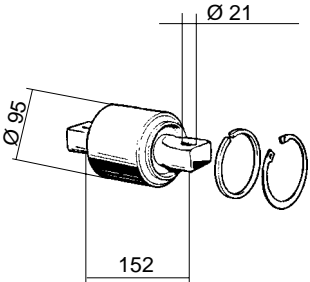
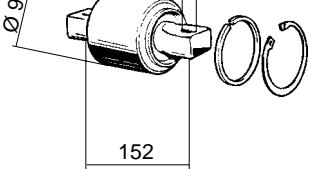
	Ns.Rif. Our Ref.	Rif.Costr. O.E. Ref.	Tipo di veicolo Vehicle Type
	97256	81432206052 81432206056 81432206041 81432206040	Tirante sospensione Torque arm MAN F90 - F2000 24.462/502 - 26.240/280/281/320/321/365 - 30.240/280 30.320 - 32.240/280/281/320/321/365 - 33.280/331/422 35.292/362/392 - 38.320 - 41.292/332/362/372/502
	972576	81432206055 (E)	Kit revisione tirante sospensione 81432206052 Torque arm repair lateral kit 81432206052 MAN F90 - F2000 24.462/502 - 26.240/280/281/320/321/365 - 30.240/280 30.320 - 32.240/280/281/320/321/365 - 33.280/331/422 35.292/362/392 - 38.320 - 41.292/332/362/372/502
	972547	81432306061	Silentblock tirante sospensione 81432206129 Torque arm silentblock 81432206129 MAN F90 - F2000 24.462/502 - 26.240/280/281/320/321/365 - 30.240/280 30.320 - 32.240/280/281/320/321/365 - 33.280/331/422 35.292/362/392 - 38.320 - 41.292/332/362/372/502
	972580	81432706040	Silentblock tirante sospensione 81432706039 Torque arm silentblock 81432706039 MAN F90 - F2000 93192619 0003500413

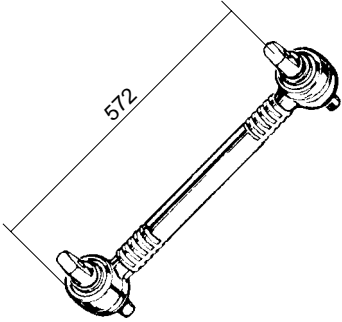
	Ns.Rif. <i>Our Ref.</i>	Rif.Costr. <i>O.E. Ref.</i>	Tipo di veicolo <i>Vehicle Type</i>
	972257	81432206236	Tirante sospensione pneumatica Torque arm MANTG-A 18.310-18.350-18.360-18.390-18.410-18.430-18.460 26.310-26.360-26.410-26.460-26.480-26.510-26.530 32.310-32.360-32.410-32.460-32.480
	Ns.Rif. <i>Our Ref.</i>	Rif.Costr. <i>O.E. Ref.</i>	Tipo di veicolo <i>Vehicle Type</i>
	Ns.Rif. <i>Our Ref.</i>	Rif.Costr. <i>O.E. Ref.</i>	Tipo di veicolo <i>Vehicle Type</i>
	Ns.Rif. <i>Our Ref.</i>	Rif.Costr. <i>O.E. Ref.</i>	Tipo di veicolo <i>Vehicle Type</i>

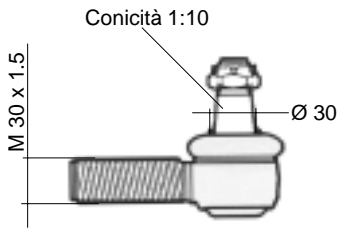
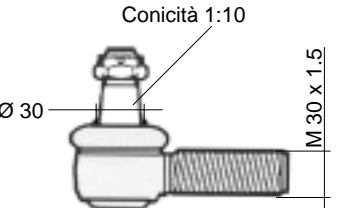
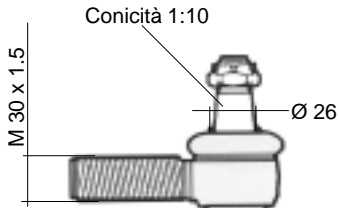
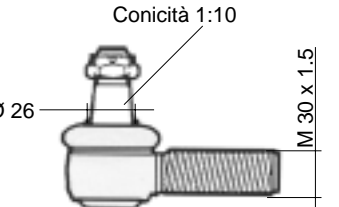

	Ns.Rif. Our Ref.	Rif.Costr. O.E. Ref.	Tipo di veicolo Vehicle Type
 <p data-bbox="95 539 212 573">Dx-Right</p>	<p data-bbox="491 300 582 327">954012</p>	<p data-bbox="632 300 778 327">0004602948</p> <p data-bbox="660 430 750 456">113254</p> <p data-bbox="660 461 746 488">698450</p> <p data-bbox="660 492 753 519">4833822</p> <p data-bbox="632 524 782 551">81953016234</p> <p data-bbox="632 555 778 582">5010832582</p> <p data-bbox="660 586 750 613">395010</p>	<p data-bbox="807 300 1430 327">ATEGO I 712 - 715 - 812 - 815 - 817 - 823 - 917 - 923</p> <p data-bbox="807 331 1350 358">1017 - 1023 - 1215 - 1217 - 1223 - 1225 - 1228</p> <p data-bbox="807 362 1350 389">1317 - 1323 - 1325 - 1328 - 1517 - 1523 - 1528</p> <p data-bbox="807 394 1058 421">SERIE MK - SK - NG</p> <p data-bbox="807 425 898 452">ASTRA</p> <p data-bbox="807 456 863 483">DAF</p> <p data-bbox="807 488 893 515">IVECO</p> <p data-bbox="807 519 868 546">MAN</p> <p data-bbox="807 551 927 577">RENAULT</p> <p data-bbox="807 582 906 609">SCANIA</p>
 <p data-bbox="95 902 193 929">Sx-Left</p>	<p data-bbox="491 629 582 656">954013</p>	<p data-bbox="632 629 778 656">0004603548</p> <p data-bbox="632 660 778 687">0014601448</p> <p data-bbox="660 763 750 790">113253</p> <p data-bbox="660 795 750 822">1228115</p> <p data-bbox="660 826 753 853">4833823</p> <p data-bbox="632 857 782 884">81953016237</p> <p data-bbox="632 889 778 916">5010832583</p> <p data-bbox="660 920 750 947">395009</p>	<p data-bbox="807 629 1430 656">ATEGO I 712 - 715 - 812 - 815 - 817 - 823 - 917 - 923</p> <p data-bbox="807 660 1350 687">1017 - 1023 - 1215 - 1217 - 1223 - 1225 - 1228</p> <p data-bbox="807 692 1350 719">1317 - 1323 - 1325 - 1328 - 1517 - 1523 - 1528</p> <p data-bbox="807 723 1058 750">SERIE MK - SK - NG</p> <p data-bbox="807 754 898 781">ASTRA</p> <p data-bbox="807 786 863 813">DAF</p> <p data-bbox="807 817 893 844">IVECO</p> <p data-bbox="807 848 868 875">MAN</p> <p data-bbox="807 880 927 907">RENAULT</p> <p data-bbox="807 911 906 938">SCANIA</p>
 <p data-bbox="95 1317 212 1350">Dx-Right</p>	<p data-bbox="491 981 582 1008">954112</p>	<p data-bbox="632 981 778 1008">0013300135</p> <p data-bbox="632 1012 778 1039">0013300235</p> <p data-bbox="632 1043 778 1070">0014603448</p> <p data-bbox="660 1424 750 1451">698609</p> <p data-bbox="660 1456 750 1482">4833827</p> <p data-bbox="632 1487 782 1514">81953016272</p> <p data-bbox="632 1518 778 1545">5000295214</p>	<p data-bbox="807 981 1110 1008">ATEGO I 917 - 925 - 1017</p> <p data-bbox="807 1012 1302 1039">ATEGO II 1823 - 1828 - 2523 - 2528 - 2628</p> <p data-bbox="807 1043 1350 1070">AXOR 1835 - 1840 - 1843 - 2535 - 2540 - 2543</p> <p data-bbox="807 1075 1445 1102">ACTROS 1996 1831-1835-1840-1843-1848-1853-1857</p> <p data-bbox="807 1106 1445 1133">2031-2040-2053-2531-2535-2540-2543-2548-2553-2557</p> <p data-bbox="807 1137 1254 1164">2631-2635-2640-2643-2648-2653-2657</p> <p data-bbox="807 1169 1254 1196">3331-3335-3340-3343-3348-3353-3357</p> <p data-bbox="807 1200 1493 1227">ACTROS 2003 1832-1836-1841-1844-1846-1850-1854-1858</p> <p data-bbox="807 1232 1445 1258">2032-2036-2041-2044-2046-2050-2532-2536-2541-2544-</p> <p data-bbox="807 1263 1445 1290">2546-2548-2632-2636-2644-2646-2646-2650-2654-2658</p> <p data-bbox="807 1294 1106 1321">Serie LK - MK - SK - NG</p> <p data-bbox="807 1326 863 1352">DAF</p> <p data-bbox="807 1357 893 1384">IVECO</p> <p data-bbox="807 1388 868 1415">MAN</p> <p data-bbox="807 1420 927 1447">RENAULT</p>
 <p data-bbox="95 1977 185 2004">Sx-Left</p>	<p data-bbox="491 1581 582 1608">954110</p>	<p data-bbox="632 1581 778 1608">3023300335</p> <p data-bbox="632 1612 778 1639">3503307135</p> <p data-bbox="660 2029 750 2056">607998</p> <p data-bbox="660 2060 750 2087">4833828</p> <p data-bbox="632 2092 782 2119">81953016273</p> <p data-bbox="632 2123 778 2150">5000295215</p>	<p data-bbox="807 1581 1110 1608">ATEGO I 917 - 925 - 1017</p> <p data-bbox="807 1612 1302 1639">ATEGO II 1823 - 1828 - 2523 - 2528 - 2628</p> <p data-bbox="807 1644 1350 1671">AXOR 1835 - 1840 - 1843 - 2535 - 2540 - 2543</p> <p data-bbox="807 1675 1445 1702">ACTROS 1996 1831-1835-1840-1843-1848-1853-1857</p> <p data-bbox="807 1706 1445 1733">2031-2040-2053-2531-2535-2540-2543-2548-2553-2557</p> <p data-bbox="807 1738 1254 1765">2631-2635-2640-2643-2648-2653-2657</p> <p data-bbox="807 1769 1254 1796">3331-3335-3340-3343-3348-3353-3357</p> <p data-bbox="807 1800 1493 1827">ACTROS 2003 1832-1836-1841-1844-1846-1850-1854-1858</p> <p data-bbox="807 1832 1445 1859">2032-2036-2041-2044-2046-2050-2532-2536-2541-2544-</p> <p data-bbox="807 1863 1445 1890">2546-2548-2632-2636-2644-2646-2646-2650-2654-2658</p> <p data-bbox="807 1895 1106 1921">Serie LK - MK - SK - NG</p> <p data-bbox="807 1926 863 1953">DAF</p> <p data-bbox="807 1957 893 1984">IVECO</p> <p data-bbox="807 1989 868 2016">MAN</p> <p data-bbox="807 2020 927 2047">RENAULT</p>

	Ns.Rif. Our Ref.	Rif.Costr. O.E. Ref.	Tipo di veicolo Vehicle Type
<p>Conicità 1:10 Ø 32 M 30 x 1.5</p> <p>Dx-Sx - Left - Right</p>	954128 DX	0014607648 0014601748 0004606848	ACTROS 1996 1831 - 1835 - 1840 - 1843 - 1848 - 1853 - 1857 2031 - 2040 - 2053 2531 - 2535 - 2540 - 2543 - 2548 - 2553 2631 - 2635 - 2640 - 2643 - 2648 - 2653 - 2657 3231 - 3255 - 3240 - 3243 3331 - 3335 - 3340 - 3343 - 3348 - 3353 - 3357 4140 - 4143 - 4148
	954129 SX	0014601348 0014600548 0004606948	ACTROS 2003 1832 - 1836 - 1841 - 1844 - 1846 - 1850 - 1854 - 1858 2032 - 2036 - 2041 - 2044 - 2046 - 2050 2532 - 2536 - 2541 - 2546 - 2548 2632 - 2636 - 2641 - 2644 - 2646 - 2650 - 2654 - 2658 ATEGO II 1823 - 1828 - 2523 - 2528 - 2628 AXOR 1823 - 1840 - 1843 - 2523 - 2528 - 2535 - 2540 - 2543 2623 - 2628 SERIE MK - NG - SK

	Ns.Rif. Our Ref.	Rif.Costr. O.E. Ref.	Tipo di veicolo Vehicle Type
<p>Conicità 1:10 Ø 22 M 28 x 1.5</p> <p>Dx-Right</p>	954026	0003309535	609 - 709 - 809 - 811 - 911 - 1813 BUS UNIMOG - VARIO
		607453 4833825 81953016249 5000823987 1698191	DAF IVECO MAN RENAULT VOLVO

	Ns.Rif. Our Ref.	Rif.Costr. O.E. Ref.	Tipo di veicolo Vehicle Type
<p>Conicità 1:10 Ø 22 M 28 x 1.5</p> <p>Sx-Left</p>	954027	0003309635	609 - 709 - 809 - 811 - 911 - 1813 BUS UNIMOG - VARIO
		607452 4833826 81953016222 5000823947 1698190	DAF IVECO MAN RENAULT VOLVO

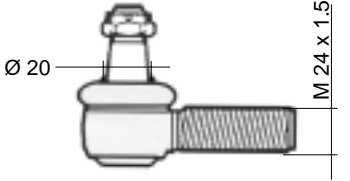
	Ns.Rif. Our Ref.	Rif.Costr. O.E. Ref.	Tipo di veicolo Vehicle Type
<p>Conicità 1:10 Ø 22 M 24 x 1.5</p> <p>Sx-Left</p>	954022	0003309935	507 - 508 - 510D 609 - 709 - 711 - 714D 809 - 811 - 814D BUS UNIMOG - VARIO
		8558527 1696919	IVECO VOLVO

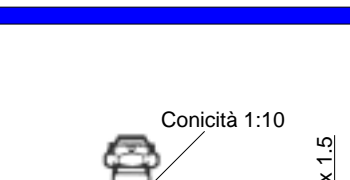
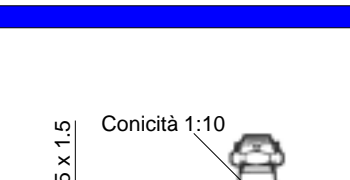
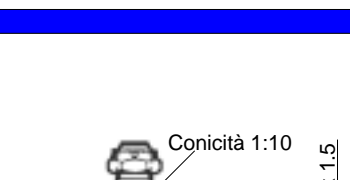
	Ns.Rif. Our Ref.	Rif.Costr. O.E. Ref.	Tipo di veicolo Vehicle Type
 <p>Sx-Left</p>	<p>954216</p>	<p>0003308635</p> <p>81953016141 5000814096 1517448</p>	<p>Testa barra accoppiamento SX Ball joint Left</p> <p>MAN L2000 RENAULT VOLVO F4</p>
 <p>Dx-Right</p>	<p>954217</p>	<p>0003308535</p> <p>81953016142 5000814097 1517449</p>	<p>Testa barra accoppiamento DX Ball joint Right</p> <p>MAN L2000 RENAULT VOLVO F4</p>
 <p>Dx-Right</p>	<p>954023</p>	<p>0003309835</p> <p>8558524 1696920</p>	<p>507 - 508 - 510D 609 - 709 - 711 - 714D 809 - 811 - 814D BUS UNIMOG - VARIO</p> <p>IVECO VOLVO</p>
 <p>Dx-Right</p>	<p>954124</p>	<p>0013302135</p>	<p>1613 - 1617 - 1626 - 1632 - 1719 - 1919 - 1926 - 1932 2026 - 2032 - 2226 - 2232 - 2626 - 2628 - 2632 - 3328 BUS O 302 - O 307 - O 405 - O 407 - O 1625 - O 1628</p>
 <p>Sx-Left</p>	<p>954125</p>	<p>0013302235</p>	<p>SERIE NG 1613 - 1617 - 1626 - 1632 - 1719 - 1919 - 1926 - 1932 2026 - 2032 - 2226 - 2232 - 2626 - 2628 - 2632 - 3328 BUS O 302 - O 307 - O 405 - O 407 - O 1625 - O 1628</p>

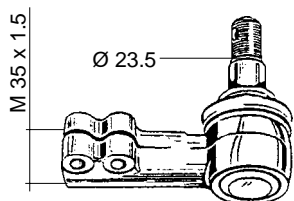

Dx-Sx - Left-Right

Ns.Rif. Our Ref.	Rif.Costr. O.E. Ref.	Tipo di veicolo Vehicle Type
<p>954007</p>	<p>0013302635 (0003302835) (0003307735) (0003384929) (0013304035)</p>	<p>16.13/17/26/26LS/32S/32LS - 17.19S - 19.19S/26/32S-LS 20.26S/32S (6x2)-(6x4) - 22.26S/32 (6x2)-(6x4) 26.28K/32S (6x4)- 33.28K BUS O302-O303-O305-O305G-O307-O405ST-O405G O407VE-O1625L-O1628L (Dx-Right)</p>
<p>954008</p>	<p>0013302735 (0003302935) (0003304135) (0003307835) (0003385029)</p>	<p>16.13/17/26/26LS/32S/32LS - 17.19S - 19.19S/26/32S-LS 20.26S/32S (6x2)-(6x4) - 22.26S/32 (6x2)-(6x4) 26.28K/32S (6x4)- 33.28K BUS O302-O303-O305-O305G-O307-O405ST-O405G O407VE-O1625L-O1628L (Sx-Left)</p>

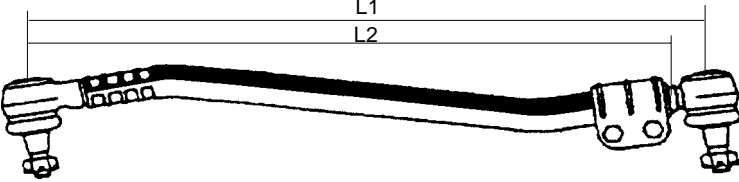
L1 470 mm.		
L2 mm.		
Ns Riferim. Our Ref.	Rif. Costr. O.E. Ref.	Tipo di veicolo - Vehicule Type
954159	6014601505	207 - 208 - 209D - 308 - 309D - 407 - 409D

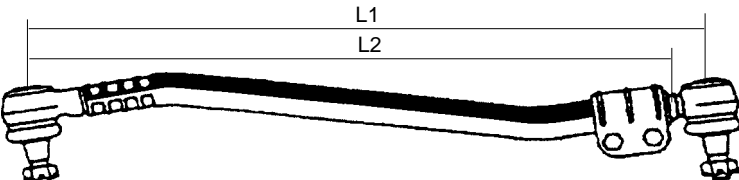
L1 486 mm.		
L2 mm.		
Ns Riferim. Our Ref.	Rif. Costr. O.E. Ref.	Tipo di veicolo - Vehicule Type
954164	6014600305 3094603105	207 - 208 - 209 - 210D 308 - 309D 406 - 407 - 408 - 409 508 - 608

AD ESAURIMENTO

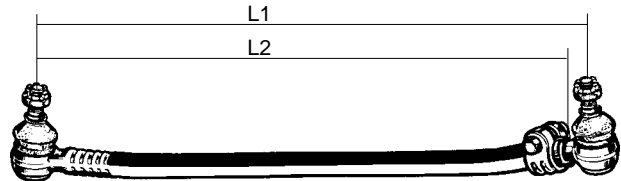
L1 517 mm.		
L2 490 mm.		
Ns Riferim. Our Ref.	Rif. Costr. O.E. Ref.	Tipo di veicolo - Vehicule Type
954106	3164600805 3164600905	608 - 709 - 808 - 811 - 813 - 913

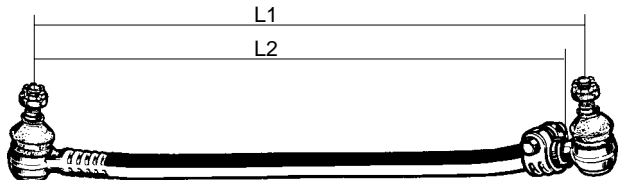
L1 725 mm.		
L2 683 mm.		
Ns Riferim. Our Ref.	Rif. Costr. O.E. Ref.	Tipo di veicolo - Vehicule Type
954143	6734600605 6734600805	709 - 711 - 809 - 811 - 814 - 817 - 914 - 917 - 1317

L1 727 mm.		
L2 670 mm.		
Ns Riferim. Our Ref.	Rif. Costr. O.E. Ref.	Tipo di veicolo - Vehicule Type
954144	6754602405 6754603005	814 - 817 - 914 - 917 - 1114 - 1117 - 1120 - 1217

L1 780 mm.		
L2 730 mm.		
Ns Riferim. Our Ref.	Rif. Costr. O.E. Ref.	Tipo di veicolo - Vehicule Type
954145	6754602205 6754602805	914 - 1114 - 1117 - 1120 - 1124 - 1314 - 1317 - 1320

L1 780 mm.		
L2 740 mm.		
Ns Riferim. Our Ref.	Rif. Costr. O.E. Ref.	Tipo di veicolo - Vehicule Type
954146	6764601105 6764601505	917 - 1114 - 1117 - 1120 - 1124 - 1314 - 1317 - 1320 - 1324

L1 860 mm.		
L2 820 mm.		
Ns Riferim. Our Ref.	Rif. Costr. O.E. Ref.	Tipo di veicolo - Vehicule Type
954168	6174602805	SERIE NG 1222 - 1414 - 1417 - 1419 - 1420 - 1422 - 1425 1614 - 1617 - 1619 - 1620 - 1622 - 1625 - 1628 2219 - 2222 - 2225 - 2228

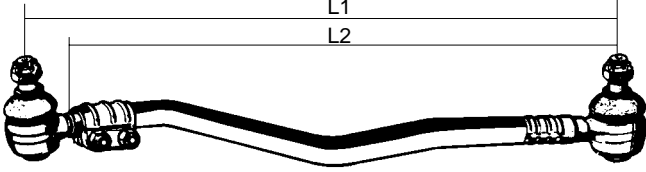
L1 890 mm.		
L2 840 mm.		
Ns Riferim. Our Ref.	Rif. Costr. O.E. Ref.	Tipo di veicolo - Vehicle Type
954147	3834601405 3834604405	SERIE NG 1013 - 1017 - 1019 - 1213 - 1217 - 1219 - 1413 - 1417 - 1419 - 1424 1613 - 1617 - 1619 - 1624 - 2219 - 2224

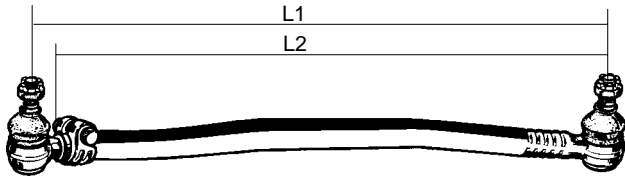
L1 885 mm.		
L2 835 mm.		
Ns Riferim. Our Ref.	Rif. Costr. O.E. Ref.	Tipo di veicolo - Vehicle Type
954150	6204602805 6204603705	1626-1628-1632-1633-1635-1638-1644-1729-1733-1735-1748-1831-1834-1922-1928 1935-1936-1938-1944-2028-2033-2035-2036-2244-2228-2233-2235-2236-2238-2244 2420-2422-2426-2427-2428-2433-2434-2438-2626-2628-2632-2633-2635-2636-2638 2828-3033-3036-3328 SERIE NG - SK

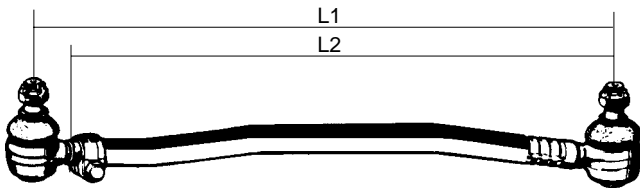
L1 865 mm.		
L2 815 mm.		
Ns Riferim. Our Ref.	Rif. Costr. O.E. Ref.	Tipo di veicolo - Vehicle Type
954149	6474600105 3874603205 3874603305 3874601405	1626-1628-1632-1636-1638-1644-1719-1733-1814-1919-1922-1926-1928-1932-1933 1935-1936-1938-1944-1948-2226-2228-2232-2433-2236-2238-2244-2428-2528-2536 2626-2628-2632-2635-2636-2638-2545-2645-3036-3328-3038-3332-3336-3636-4436 5436-6036 SERIE NG - SK

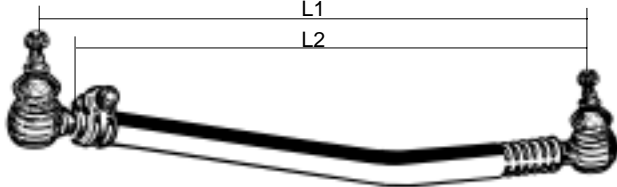
L1 860 mm.		
L2 810 mm.		
Ns Riferim. Our Ref.	Rif. Costr. O.E. Ref.	Tipo di veicolo - Vehicle Type
954148	6194602905 6194605205 6194602505	SERIE MK 1420 - 1422 - 1424 - 1427 - 1717 - 1720 - 1722 SERIE MK 1726 - 1733 - 1820 - 1824 - 1827 - 1831 - 1834 SERIE MK 2420 - 2422 - 2426 - 2433 - 2524 - 2527 - 2531 - 2534 SERIE SK 1729 - 1735 - 1748 - 1834 - 1838 - 1840 - 1844 - 1850 - 1853 - 1935 2435 - 2448 - 2538 - 2544 - 2550 - 2553 - 2638 - 3238 - 3253

L1 870 mm.		
L2 820 mm.		
Ns Riferim. Our Ref.	Rif. Costr. O.E. Ref.	Tipo di veicolo - Vehicle Type
954141	0004609805 0004609905	SERIE SK 1748 - 1844 - 1850 - 1853 - 1929 - 1935 - 1948 - 2024 - 2038 - 2044 - 2050 2429 - 2435 - 2448 - 2538 - 2544 - 2550 - 2553 - 2629 - 2631 - 2635 - 2644 - 2648 - 2650

L1 810 mm.		
L2 780mm.		
Ns Riferim. Our Ref.	Rif. Costr. O.E. Ref.	Tipo di veicolo - Vehicle Type
954081	0014602905 0014603005	SERIE MK 1424 - 1427 - 1720 - 1733 - 1820 - 1824 - 1827 - 1831 - 1834 2433 - 2524 - 2531 - 2534 SERIE SK 1735 - 1834

L1 825 mm.		
L2 785mm.		
Ns Riferim. Our Ref.	Rif. Costr. O.E. Ref.	Tipo di veicolo - Vehicle Type
954218	0014600305 0014600405	SERIE MK 1417 - 1420 - 1424 - 1427 - 1624 - 1720 - 1733 - 1820 - 1824 - 1827 - 1831 - 1834 2327 - 2431 - 2433 - 2524 - 2527 - 2531 - 2534 - 3231 SERIE NG 1928 - 2428 SERIE SK 1834 - 2534

L1 865 mm.		
L2 810mm.		
Ns Riferim. Our Ref.	Rif. Costr. O.E. Ref.	Tipo di veicolo - Vehicle Type
954219	6204602905 6204603005 6204600405	SERIE MK 1831 - 2531 SERIE NG 1922 - 1928 - 1935 - 1936 - 2028 - 2222 - 2528 - 2536 - 2628 - 2635 - 2636 3250 - 3328 - 3335 - 3336 - 3528 - 3535 - 3836 - 3850 SERIE SK da 1728 a 4844 - from 1728 to 4844

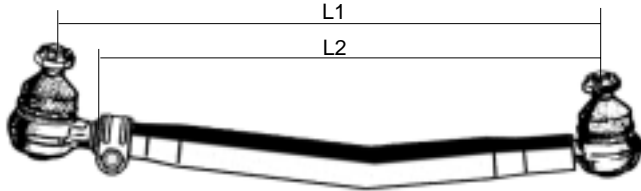
L1 825 mm.		
L2 790 mm.		
Ns Riferim. Our Ref.	Rif. Costr. O.E. Ref.	Tipo di veicolo - Vehicle Type
954084	9724601405 9724601605	ATEGO I 712 - 715 - 812 - 815 - 817 - 823 - 917 - 923 1017 - 1023 - 1215 - 1217 - 1223 - 1228 1317 - 1323 - 1328 - 1517 - 1523 - 1528 (4,1 ton)

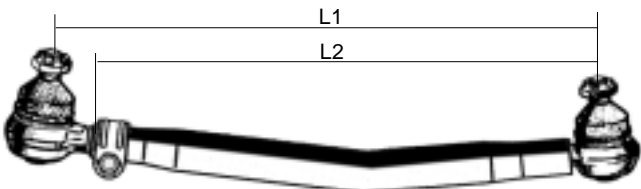
L1 865 mm.		
L2 820 mm.		
Ns Riferim. Our Ref.	Rif. Costr. O.E. Ref.	Tipo di veicolo - Vehicle Type
954085	9724601805 9724602005	ATEGO I 917 - 923 1017 - 1023 1215 - 1217 - 1223 - 1225 - 1228 1317 - 1323 - 1325 - 1328 (5,3 ton)

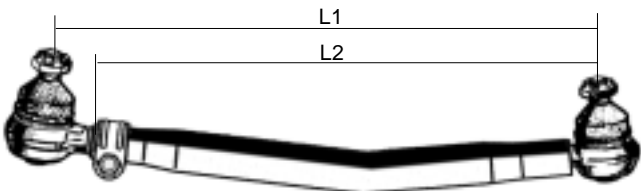
L1 835 mm.		
L2 805 mm.		
Ns Riferim. Our Ref.	Rif. Costr. O.E. Ref.	Tipo di veicolo - Vehicle Type
954082	9704600705 9704600905	ATEGO I 712 - 714 - 715 - 717 - 812 - 815 - 817 - 823 917 - 923 (3,5 ton) 1017 - 1023 - 1215 - 1217 - 1223 - 1228 - 1317 - 1323 - 1328 1517 - 1523 - 1528

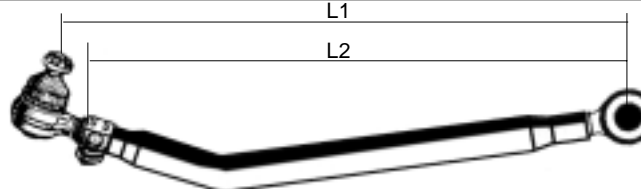
L1 885 mm.		
L2 840 mm.		
Ns Riferim. Our Ref.	Rif. Costr. O.E. Ref.	Tipo di veicolo - Vehicle Type
954086	9744601005 9744601205	ATEGO I 712 - 714 - 715 - 717 - 812 - 815 - 817 - 823 1214 - 1215 - 1217 - 1218 - 1223 - 1228 1317 - 1381 - 1323 - 1325 - 1328 - 1517 1518 - 1523 - 1528 (6,1 ton)

L1 880 mm.		
L2 845 mm.		
Ns Riferim. Our Ref.	Rif. Costr. O.E. Ref.	Tipo di veicolo - Vehicle Type
954087	0024604905 0024605005	ATEGO II 1823 - 1828 - 2528 - 2628 AXOR 1835 - 1840 - 1843 - 2535 - 2540 - 2543 SOSPENSIONE PNEUMATICA - PNEUMATIC SUSPENSION

L1 866 mm.		
L2 812 mm.		
Ns Riferim. Our Ref.	Rif. Costr. O.E. Ref.	Tipo di veicolo - Vehicle Type
954158	0014609805 0014609905 0024606405 0024606305 0024606405	ACTROS 1996 1831-1835-1840-1843-1848-1853-1857 - 2031-2035-2040-2053 2531-2535-2540-2543 - 3231-3235-3240-3243-3331-3335 3231-3235-3240-3243 3331-3335-3340-3343-3348-3353-3357 4140-4143-4148

L1 888 mm.		
L2 830 mm.		
Ns Riferim. Our Ref.	Rif. Costr. O.E. Ref.	Tipo di veicolo - Vehicle Type
954088	0014607005 0014600805 0014600705	ACTROS 1996 1831-1835-1840-1843-1848-1853-1857 - 2031-2035-2040-2053 2531-2535-2540-2543-2548-2553-2557 - 2631-2635-2640-2643-2648-2653-2657 3231-3235-3240-3243 - 3331-3335-3340-3343-3348-3353-3357 4140-4143-4148

L1 820 mm.		
L2 800 mm.		
Ns Riferim. Our Ref.	Rif. Costr. O.E. Ref.	Tipo di veicolo - Vehicle Type
954316	9724602805	ATEGO

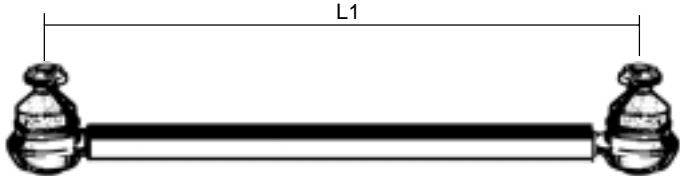
L1 954 mm.		
L2 mm.		
Ns Riferim. Our Ref.	Rif. Costr. O.E. Ref.	Tipo di veicolo - Vehicule Type
954091	0014608605	ACTROS 1996 1835-1840-1843-1848-1853-1857 - 2031-2035-2040 2531-2535-2540-2543-2548-2553-2557 - 2631-2635-2640-2643-2648-2653-2657 3331-3335-3340-3343-3348-3353-3357

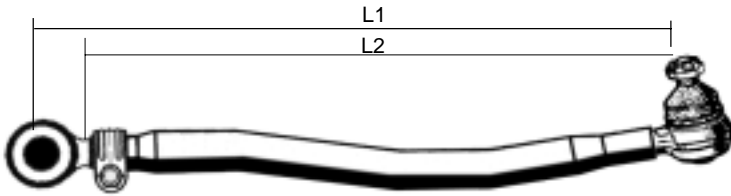
L1 855 mm.		
L2 823 mm.		
Ns Riferim. Our Ref.	Rif. Costr. O.E. Ref.	Tipo di veicolo - Vehicule Type
954113	0014606905 0004609305 0004609205	ACTROS 1996 1831-1835-1840-1843-1848-1853-1857 - 2031-2035-2040-2053 2531-2535-2540-2543-2548-2553-2557 - 2631-2635-2640-2643-2648-2653-2657 3231-3235-3240-3243 - 3331-3335-3340-3343-3348-3353-3357 - 4140-4143-4148 ACTROS 2003 1832-1836-1841-1844-1846-1850-1854-1858 - 2032-2036-2041-2044-2046-2050 2532-2536-2541-2544-2546-2548 - 2632-2636-2641-2644-2646-2650-2654-2658 ATEGO II 1823-1828 - 2523-2528 - 2628 AXOR 1835-1840-1843 - 2540-2543

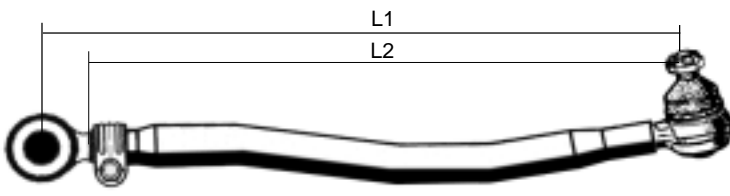
L1 879 mm.		
L2 815 mm.		
Ns Riferim. Our Ref.	Rif. Costr. O.E. Ref.	Tipo di veicolo - Vehicule Type
954111	0004607105 0014606705	ACTROS 1996 1831-1835-1840-1843-1848-1853-1857 - 2031-2035-2040-2053 2531-2535-2540-2543-2548-2553-2557 - 2631-2635-2640-2643-2648-2653-2657 3231-3235-3240-3243 - 3331-3335-3340-3343-3348-3353-3357 - 4140-4143-4148 ACTROS 2003 1832-1836-1841-1844-1846-1850-1854-1858 - 2032-2036-2041-2044-2046-2050 2532-2536-2541-2544-2546-2548 - 2632-2636-2641-2644-2646-2650-2654-2658 ATEGO II 1823-1828 - 2523-2528 - 2628 AXOR 1835-1840-1843 - 2540-2543

L1 879 mm.		
L2 822 mm.		
Ns Riferim. Our Ref.	Rif. Costr. O.E. Ref.	Tipo di veicolo - Vehicle Type
954134	0024604405 0024604305	ACTROS 1996 1831-1835-1840-1843-1848-1853-1857 - 2031-2035-2040-2053 2531-2535-2540-2543-2548-2553-2557 - 2631-2635-2640-2643-2648-2653-2657 3231-3235-3240-3243 - 3331-3335-3340-3343-3348-3353-3357 - 4140-4143-4148 ACTROS 2003 1832-1836-1841-1844-1846-1850-1854-1858 - 2032-2036-2041-2044-2046-2050 2532-2536-2541-2544-2546-2548 - 2632-2636-2641-2644-2646-2650-2654-2658 ATEGO II 1823-1828

L1 876 mm.		
L2 825mm.		
Ns Riferim. Our Ref.	Rif. Costr. O.E. Ref.	Tipo di veicolo - Vehicle Type
954156	0024604705 0024604805	ACTROS 1996 1831-1835-1840-1843-1848-1853-1857 - 2031-2035-2040-2053 2531-2535-2540-2543-2548-2553-2557 - 2631-2635-2640-2643-2648-2653-2657 3231-3235-3240-3243 - 3331-3335-3340-3343-3348-3353-3357 ACTROS 2003 1832-1836-1841-1844-1846-1850-1854-1858 - 2032-2036-2041-2044-2046-2050 2532-2536-2541-2544-2546-2548 - 2632-2636-2641-2644-2646-2650-2654-2658 ATEGO II 1823-1828 - 2523-2528 - 2628 AXOR 1823-1835-1840-1843 - 2523-2528-2535-2540-2543 - 2623-2628 - 3228

L1 880 mm.		
L2 850 mm.		
Ns Riferim. Our Ref.	Rif. Costr. O.E. Ref.	Tipo di veicolo - Vehicle Type
954092	0024604605 0024604505	ACTROS 1996 1831-1835-1840-1843-1848-1853-1857 - 2031-2035-2040-2053 2531-2535-2540-2543-2548-2553-2557 - 2631-2635-2640-2643-2648-2653-2657 3231-3235-3240-3243 - 3331-3335-3340-3343-3348-3353-3357 - 4140-4143-4148 ATEGO I 712-715 - 812-815-817-823 - 917-923 - 1017-1023 - 1215-1217-1223-1225-1228 1317-1323-1325-1328 - 1517-1523-1528 ATEGO II 1823-1828 - 2523-2528 - 2628

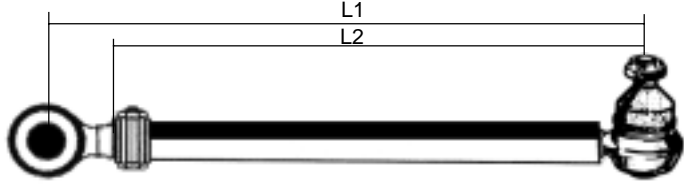
L1 909 mm.		
L2 890 mm.		
Ns Riferim. Our Ref.	Rif. Costr. O.E. Ref.	Tipo di veicolo - Vehicule Type
954089	0014608105 0014605105	ACTROS 1996 1835-1840-1843-1848-1853-1857 - 2031-2035-2040 2531-2535-2540-2543-2548-2553-2557 - 2631-2635-2640-2643-2648-2653-2657 3331-3335-3340-3343-3348-3353-3357 ACTROS 2003 2532-2536

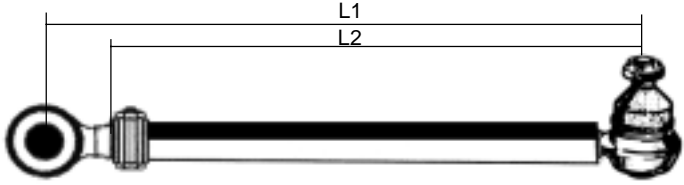
L1 730 mm.		
L2 655 mm.		
Ns Riferim. Our Ref.	Rif. Costr. O.E. Ref.	Tipo di veicolo - Vehicule Type
954090	0014608505	ACTROS 1996 1835-1840-1843-1848-1853-1857 - 2031-2035-2040 2531-2535-2540-2543-2548-2553-2557 - 2631-2635-2640-2643-2648-2653-2657 3331-3335-3340-3343-3348-3353-3357 ACTROS 2003 2532-2536

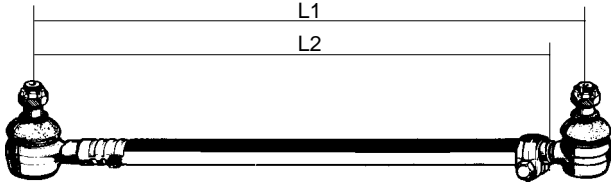
L1 975 mm.		
L2 930 mm.		
Ns Riferim. Our Ref.	Rif. Costr. O.E. Ref.	Tipo di veicolo - Vehicule Type
954151	3004600605 3004600705	BUS O 303 - O 305 - O 305G - O 307

L1 1146 mm.			AD ESAURIMENTO
L2 1100 mm.			
Ns Riferim. Our Ref.	Rif. Costr. O.E. Ref.	Tipo di veicolo - Vehicule Type	
954152	3004600405 3004600505	BUS O 303	

L1 1640 mm.		
L2 1620 mm.		
Ns Riferim. Our Ref.	Rif. Costr. O.E. Ref.	Tipo di veicolo - Vehicule Type
954097	9753300803 9753300303 9753300203	Barra accoppiamento ruote - Complete track rod ATEGO I (da 01/98 - from 01/98) 917-923 1017-1023 1215-1217-1223-1228 1317-1323-1328 1517-1523-1528

L1 1565 mm.		
L2 1455 mm.		
Ns Riferim. Our Ref.	Rif. Costr. O.E. Ref.	Tipo di veicolo - Vehicule Type
954171	9423300903 9423300503 6253302603	Barra accoppiamento ruote - Complete track rod ACTROS 1996 1831-1835-1840-1843-1848-1853-1857 - 2031-2035-2040-2053 2531-2535-2540-2543-2548-2553-2557 - 2631-2635-2640-2643-2648-2653-2657 3231-3235-3240-3243 - 3331-3335-3340-3343-3348-3353-3357 - 4140-4143-4148 SERIE SK 2648 - SK 2650 - SK 3229 - SK 3233 - SK 3234 - SK 3550
AD ESAURIMENTO		

L1 1588 mm.		
L2 1565 mm.		
Ns Riferim. Our Ref.	Rif. Costr. O.E. Ref.	Tipo di veicolo - Vehicule Type
954175	9443301703 6253303203	Barra accoppiamento ruote - Complete track rod ACTROS 1996 1831-1835-1840-1843-1848 - 2031-2035-2040 3331-3340-3343-3348-3353 - 4140-4143-4148 ATEGO II 1823 - 1828

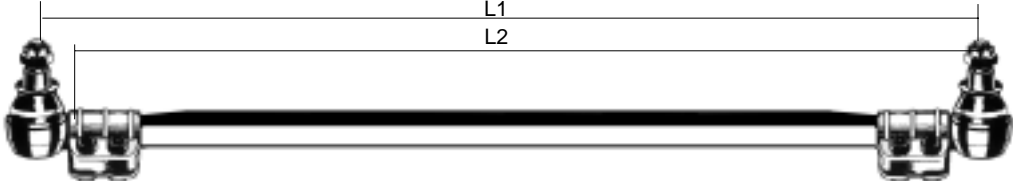
L1 1596 mm.		
L2 1575 mm.		
Ns Riferim. Our Ref.	Rif. Costr. O.E. Ref.	Tipo di veicolo - Vehicule Type
954195	9493301703 9493301003	Barra accoppiamento ruote - Complete track rod ACTROS 1996 2631-2635-2640-2643-2648 3231-32335-3240-3243 4140-4143-4148

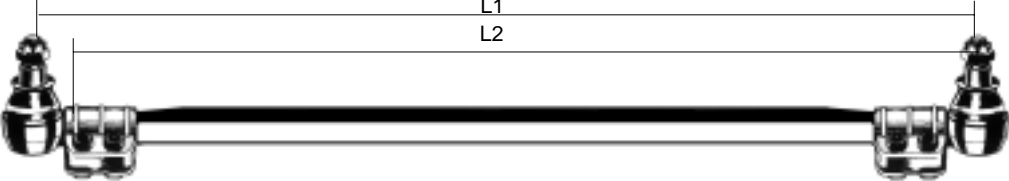
L1 1465 mm.		
L2 1355 mm.		
Ns Riferim. Our Ref.	Rif. Costr. O.E. Ref.	Tipo di veicolo - Vehicule Type
954099	9453300503 9453300303 9453300203	Barra accoppiamento ruote - Complete track rod ACTROS 1996 1831-1835-1840-1843-1848-1853-1857 - 2031-2035-2040-2053 2531-2535-2540-2543-2548-2553-2557 - 2631-2635-2640-2643-2648-2653-2657 3231-3235-3240-3243 - 3331-3335-3340-3343-3348-3353-3357 - 4140-4143-4148 ACTROS 2003 1832-1836-1841-1846 - 2532-2536-2541-2544-2546-2548 - 2632-2636-2641-2644-2650-2654 ATEGO II 1823-1828 - 2523-2528

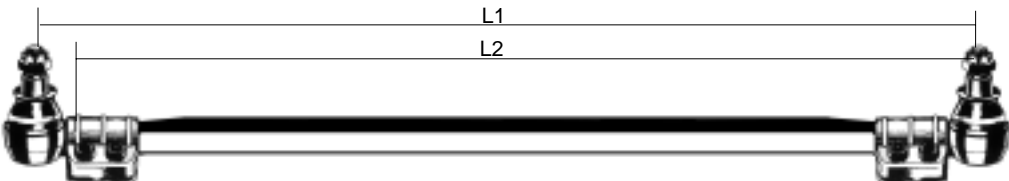
L1 1532 mm.		
L2 1520 mm.		
Ns Riferim. Our Ref.	Rif. Costr. O.E. Ref.	Tipo di veicolo - Vehicule Type
954096	9493301203 9493301803	Barra accoppiamento ruote - Complete track rod ACTROS 1996 2031-2040-2053 - 2535 - 3331-3335-3340-3343-3348-3353-3357 - 4140-4143-4148 ACTROS 2003 2032-2036-2041-2044-2046-2050 ATEGO II 1823-1828

L1 1615 mm.		
L2 1515 mm.		
Ns Riferim. Our Ref.	Rif. Costr. O.E. Ref.	Tipo di veicolo - Vehicule Type
954187	6253302503 6253302403 6253301603 6253301503	Barra accoppiamento ruote - Complete track rod ACTROS 1996 1831-1835-1840-1843-1848-1853-1857 - 2031-2035-2040-2053 2531-2535-2540-2543-2548-2553-2557 - 2631-2635-2640-2643-2648-2653-2657 3231-3235-3240-3243 - 3331-3335-3340-3343-3348-3353-3357 - 4140-4143-4148 ACTROS 2003 1832-1836-1841-1844-1846-1850-1854-1858 - 2032-2036-2041-2044-2046-2050 2532-2536-2541-2544-2546-2548 - 2632-2636-2641-2644-2646-2650-2654-2658 ATEGO II 1823-1828 - 2528-2628 SERIE MK - SK - NG

L1 1625 mm.		
L2 1525 mm.		
Ns Riferim. Our Ref.	Rif. Costr. O.E. Ref.	Tipo di veicolo - Vehicule Type
954102	9493300903 9423300803	Barra accoppiamento ruote - Complete track rod ACTROS 1996 2031-2040-2053 - 2535 - 3331-3335-3340-3343-3348-3353-3357 - 4140-4143-4148 ACTROS 2003 2032-2036-2041-2044-2046-2050 ATEGO II 1823-1828

L1 1735 mm.		
L2 1630 mm.		
Ns Riferim. Our Ref.	Rif. Costr. O.E. Ref.	Tipo di veicolo - Vehicule Type
954166	9413300203 9413300103	Barra accoppiamento ruote - Complete track rod ACTROS 1996 1831-1835-1840-1843-1848-1853-1857 - 2031-2035-2040-2053 2531-2535-2540-2543-2548-2553-2557 - 2631-2635-2640-2643-2648-2653-2657 3231-3235-3240-3243 - 3331-3335-3340-3343-3348-3353-3357 - 4140-4143-4148 ACTROS 2003 1832-1836-1841-1844-1846-1850-1854-1858 - 2032-2036-2041-2044-2046-2050 2532-2536-2541-2544-2546-2548 - 2632-2636-2641-2644-2646-2650-2654-2658 ATEGO II 1823-1828 - 2528 - 2628 AXOR 1823-1835-1840-1843 - 2523-2528-2535-2540-2543 - 2623-2628 - 3228

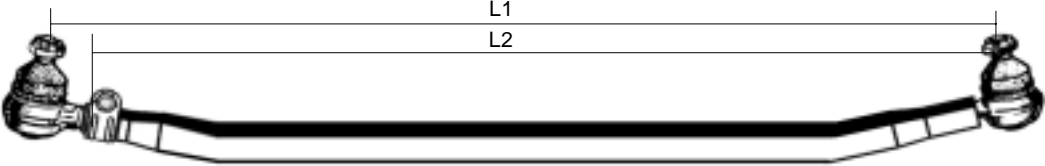
L1 1735 mm.		
L2 1645 mm.		
Ns Riferim. Our Ref.	Rif. Costr. O.E. Ref.	Tipo di veicolo - Vehicle Type
954182	9423300003 9423300103 9423300203	Barra accoppiamento ruote - Complete track rod ACTROS 1996 1831-1835-1840-1843-1848-1853-1857 - 2031-2035-2040-2053 2531-2535-2540-2543-2548-2553-2557 - 2631-2635-2640-2643-2648-2653-2657 3231-3235-3240-3243 - 3331-3335-3340-3343-3348-3353-3357 ACTROS 2003 1832-1836-1841-1844-1846-1850-1854-1858 - 2032-2036-2041-2044-2046-2050 2532-2536-2541-2544-2546-2548 - 2632-2636-2641-2644-2646-2650-2654-2658 ATEGO II 1823-1828 - 2523-2528 - 2628 AXOR 1823-1835-1840-1843 - 2523-2528-2535-2540-2543 - 2623-2628 - 3228

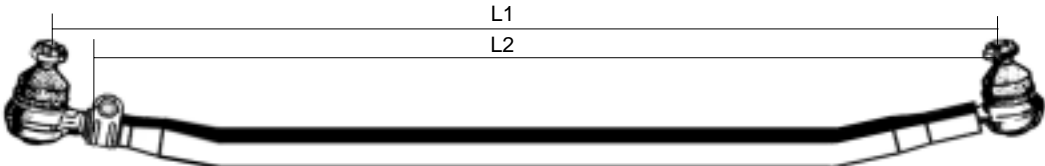
L1 1735 mm.		
L2 mm.		
Ns Riferim. Our Ref.	Rif. Costr. O.E. Ref.	Tipo di veicolo - Vehicle Type
954083	9453300003	Barra accoppiamento ruote - Complete track rod ACTROS 1996 ACTROS 2003 ATEGO AXOR

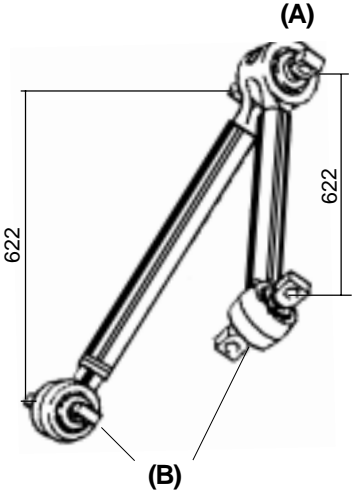
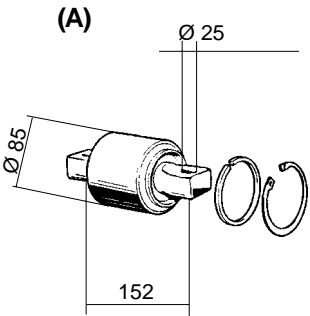
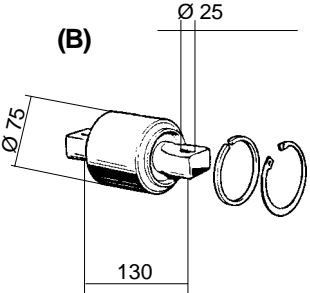

Ns Riferim. Our Ref.	Rif. Costr. O.E. Ref.	Tipo di veicolo - Vehicle Type

	Ns.Rif. Our Ref.	Rif.Costr. O.E. Ref.	Tipo di veicolo Vehicle Type
	972514	9483500405 9443500305 9443500005	Barra angolare sospensioni Angle torque arm ACTROS 1996 1831-1835-1840-1843-1848-1853-1857 2031-2035-2040-2053 2531-2535-2540-2543-2548-2553-2557 2631-2635-2640-2643-2648-2653-2657 3231-3235-3240-3243 3331-3335-3340-3343-3348-3353-3357 4140-4143-4148 ACTROS 2003 ATEGO II 1823-1828 - 2523-2528 - 2628 AXOR 2004
	972519	0003502305	Silentblock centrale barra sospensione 9443500005 Torque arm silentblock 9443500005 ACTROS 1996 1831-1835-1840-1843-1848-1853-1857 2031-2035-2040-2053 2531-2535-2540-2543-2548-2553-2557 2631-2635-2640-2643-2648-2653-2657 3231-3235-3240-3243 3331-3335-3340-3343-3348-3353-3357 4140-4143-4148 ATEGO II 1823-1828 - 2523-2528 - 2628
	972520	0003502205	Silentblock laterale barra sospensione 9443500005 Torque arm silentblock 9443500005 ACTROS 1996 1831-1835-1840-1843-1848-1853-1857 2031-2035-2040-2053 2531-2535-2540-2543-2548-2553-2557 2631-2635-2640-2643-2648-2653-2657 3231-3235-3240-3243 3331-3335-3340-3343-3348-3353-3357 4140-4143-4148 ATEGO II 1823-1828 - 2523-2528 - 2628

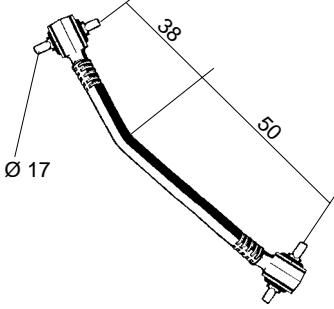
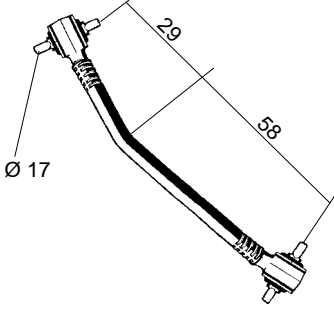
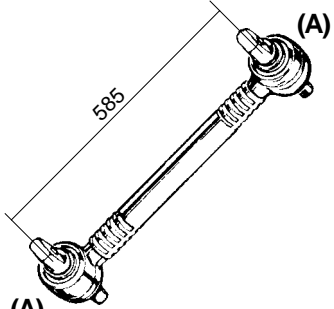
	<p>Ns.Rif. Our Ref.</p> <p>972504</p>	<p>Rif.Costr. O.E. Ref.</p> <p>041110000</p>	<p>Tipo di veicolo Vehicle Type</p> <p>Barra angolare sospensioni Angle torque arm</p> <p>ACTROS T.T. (3°asse BPW) BATTAGLINO</p>
	<p>Ns.Rif. Our Ref.</p> <p>972516</p>	<p>Rif.Costr. O.E. Ref.</p> <p>9483500905</p>	<p>Tipo di veicolo Vehicle Type</p> <p>Barra angolare sospensioni Angle torque arm</p> <p>MERCEDES ACTROS T.T. 3331-3340-3343-3346-3348-3350-3353-3354-3357-3358 4140-4143-4146-4148-4150</p>
	<p>Ns.Rif. Our Ref.</p> <p>972524</p>	<p>Rif.Costr. O.E. Ref.</p> <p>0003502005</p>	<p>Tipo di veicolo Vehicle Type</p> <p>Silentblock laterale per barra sospensione 9743500005 Torque arm silentblock 9743500005</p> <p>ACTROS T.T. ATEGO I ATEGO II SERIE MK - SK - NG</p>
	<p>Ns.Rif. Our Ref.</p>	<p>Rif.Costr. O.E. Ref.</p>	<p>Tipo di veicolo Vehicle Type</p>

	<p>Ns.Rif. Our Ref.</p> <p>972527</p>	<p>Rif.Costr. O.E. Ref.</p> <p>9453300007</p>	<p>Tipo di veicolo Vehicle Type</p> <p>Barra di reazione longitudinale per sosp.pneumatica ant. Longitudinal torque arm for pneumatic front suspension</p> <p>ACTROS 1996 1831-1835-1840-1843-1848-1853-1857 2031-2035-2040-2053-2531-2535-2540-2543-2548-2553 2557-2631-2635-2640-2643-2648-2653-2657 3331-3335-3340-3343-3348-3353-3357</p> <p>ACTROS 2003 2632-2636-2641-2644-2650-2654</p> <p>ATEGO - ATEGO II 2523-2528</p>
	<p>Ns.Rif. Our Ref.</p> <p>954181</p>	<p>Rif.Costr. O.E. Ref.</p> <p>9413300007</p>	<p>Tipo di veicolo Vehicle Type</p> <p>Barra di reazione longitudinale per sosp.pneumatica ant. Longitudinal torque arm for pneumatic front suspension</p> <p>ACTROS 1996 1831-1835-1840-1843-1848-1853-1857 2031-2035-2040-2053-2531-2535-2540-2543-2548-2553 2557-2631-2635-2640-2643-2648-2653-2657 3331-3335-3340-3343-3348-3353-3357</p> <p>ACTROS 2003 2632-2636-2641-2644-2650-2654</p> <p>ATEGO - ATEGO II 1823-1828</p>
	<p>Ns.Rif. Our Ref.</p> <p>972535</p>	<p>Rif.Costr. O.E. Ref.</p> <p>6583500206 6583500006 3933200132</p>	<p>Tipo di veicolo Vehicle Type</p> <p>Tirante sospensione Torque arm</p> <p>NG 1626-1628-1632-1633-1635-1636 NG 2226-2228-2232-2233-2235-2236-2238-2244 NG 2626-2633-2635-2636-2644 NG 3025-3228-3336</p> <p>SK 1729-1735-1748 SK 1850-1853-1929 SK 2429-2435-2448 SK 2538-2544-2550-2553-2650-3253</p>

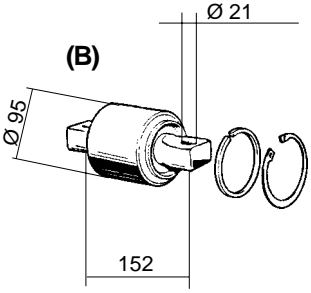
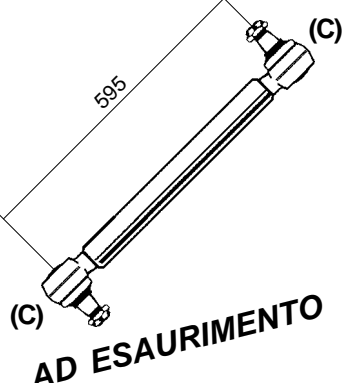
<p>(A)</p>	<p>Ns.Rif. Our Ref.</p> <p>972577</p>	<p>Rif.Costr. O.E. Ref.</p> <p>3953200132</p>	<p>Tipo di veicolo Vehicle Type</p> <p>Tirante sospensione Torque arm</p> <p>NG 2226 - NG 2232 NG 2626 - NG 2632</p>
<p>(A)</p>	<p>Ns.Rif. Our Ref.</p> <p>972543</p>	<p>Rif.Costr. O.E. Ref.</p> <p>3953201432</p>	<p>Tipo di veicolo Vehicle Type</p> <p>Tirante sospensione Torque arm</p> <p>NG 2626 - NG 2632</p>
<p>(A)</p>	<p>Ns.Rif. Our Ref.</p> <p>972578</p>	<p>Rif.Costr. O.E. Ref.</p> <p>3953201532</p>	<p>Tipo di veicolo Vehicle Type</p> <p>Tirante sospensione Torque arm</p> <p>NG 2226 - NG 2232 NG 2626 - NG 2632</p>
<p>(A)</p>	<p>Ns.Rif. Our Ref.</p> <p>972573</p>	<p>Rif.Costr. O.E. Ref.</p> <p>0005861433 (A)</p> <p>693778</p>	<p>Tipo di veicolo Vehicle Type</p> <p>Kit revisione tirante sospensione 6583500206 - 3953200132 - 3953201432 - 3953201532 Torque arm repair kit</p> <p>NG 2226 - NG 2232 NG 2626 - NG 2632</p> <p>DAF</p>
<p>(B)</p>	<p>Ns.Rif. Our Ref.</p> <p>972579</p>	<p>Rif.Costr. O.E. Ref.</p> <p>6593503406 6243500006 6593501106 3953500006</p>	<p>Tipo di veicolo Vehicle Type</p> <p>Tirante sospensione Torque arm</p> <p>NG 2626-2628-2632-2633-2635-2636-2638-2644 NG 3328-3333-3336-3528-3535 SK 2629-2631-2635-2638-2644-2648-2650 SK 3050-3053-3054 SK 3534-3535-3538-3550-3553</p>

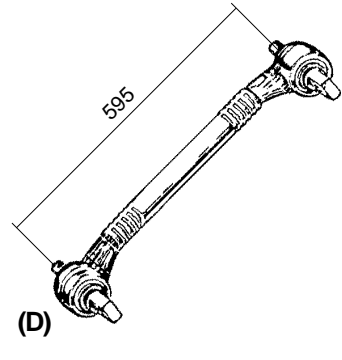
 <p>(B)</p>	<p>Ns.Rif. Our Ref.</p> <p>972580</p>	<p>Rif.Costr. O.E. Ref.</p> <p>0003500413 0005861235 (B)</p> <p>93162619 81432706040</p>	<p>Tipo di veicolo Vehicle Type</p> <p>Silentblock tirante sospensione 6593503406 Torque arm silentblock 6593503406</p> <p>NG 2626-2628-2632-2633-2635-2636-2638-2644 NG 3328-3333-3336-3528-3535 SK 2629-2631-2635-2638-2644-2648-2650 SK 3050-3053-3054 SK 3534-3535-3538-3550-3553</p> <p>IVECO MAN</p>
 <p>(C)</p> <p>AD ESAURIMENTO</p>	<p>Ns.Rif. Our Ref.</p> <p>972581</p>	<p>Rif.Costr. O.E. Ref.</p> <p>3433201732</p>	<p>Tipo di veicolo Vehicle Type</p> <p>Tirante sospensione Torque arm</p> <p>22.19 - 22.20 - 26.20 - 26.23 - 26.24 - 26.26 -(6x6) 26.32 (6x6) (Teste opposte - Opposite joints)</p>
 <p>(C)</p> <p>AD ESAURIMENTO</p>	<p>Ns.Rif. Our Ref.</p> <p>972560</p>	<p>Rif.Costr. O.E. Ref.</p> <p>3435860032 (C)</p>	<p>Tipo di veicolo Vehicle Type</p> <p>Kit revisione tirante sospensione 3433201732 Torque arm repair lateral kit 3433201732</p> <p>22.19 - 22.20 - 26.20 - 26.23 - 26.24 - 26.26 -(6x6) 26.32 (6x6) (Teste opposte - Opposite joints)</p>
 <p>(D)</p> <p>AD ESAURIMENTO</p>	<p>Ns.Rif. Our Ref.</p> <p>972582</p>	<p>Rif.Costr. O.E. Ref.</p> <p>6553500306 6553500506 6203500106</p>	<p>Tipo di veicolo Vehicle Type</p> <p>Tirante sospensione Torque arm</p> <p>NG 1628-1633-1635-1636-1638-1644 NG 1928-1933-1935-1936-1938-1944 NG 2028-2033-2035-2036-2228-2236-2244-2644</p> <p>SK 1729-1735-1748 SK 1831-1834-1838-1840-1844-1850-1853-1929 SK 2429-2435-2448-2538-2544-2550-2553-2648-2650-3253</p>

	<p>Ns.Rif. Our Ref.</p> <p>972583</p>	<p>Rif.Costr. O.E. Ref.</p> <p>6523500306 6533500106 3813500606</p>	<p>Tipo di veicolo Vehicle Type</p> <p>Tirante sospensione Torque arm</p> <p>SERIE MK SERIE SK SERIE NG Sospensione pneumatica - Pneumatic suspension</p>
	<p>Ns.Rif. Our Ref.</p> <p>972550</p>	<p>Rif.Costr. O.E. Ref.</p> <p>0003500613 0005861135 (D)</p>	<p>Tipo di veicolo Vehicle Type</p> <p>Silentblock per tirante sospensione 6553500306 - 6523500306 Torque arm silentblock 6553500306 - 6523500306</p> <p>SERIE MK SERIE SK SERIE NG Sospensione pneumatica - Pneumatic suspension</p>
	<p>Ns.Rif. Our Ref.</p> <p>972545</p>	<p>Rif.Costr. O.E. Ref.</p> <p>3433201832</p>	<p>Tipo di veicolo Vehicle Type</p> <p>Tirante sospensione registrabile Registrable torque arm</p> <p>26.24</p> <p>AD ESAURIMENTO</p>
	<p>Ns.Rif. Our Ref.</p>	<p>Rif.Costr. O.E. Ref.</p>	<p>Tipo di veicolo Vehicle Type</p>
	<p>Ns.Rif. Our Ref.</p>	<p>Rif.Costr. O.E. Ref.</p>	<p>Tipo di veicolo Vehicle Type</p>

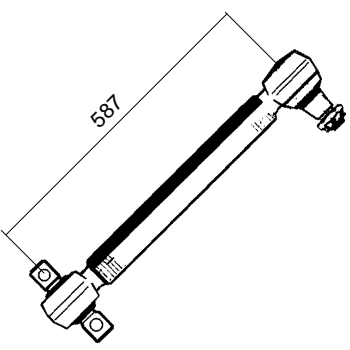

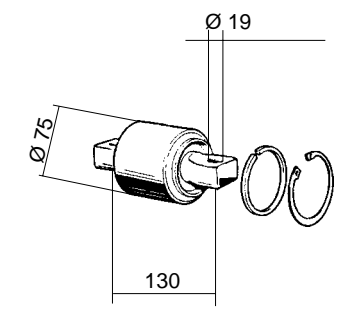

	Ns.Rif. Our Ref.	Rif.Costr. O.E. Ref.	Tipo di veicolo Vehicle Type
	972584	3523500306	Tirante sospensione Torque arm LP 2219/6x2

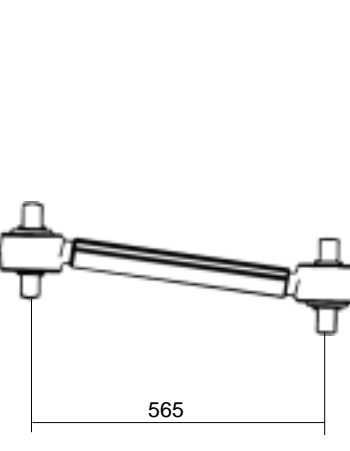
AD ESAURIMENTO

	Ns.Rif. Our Ref.	Rif.Costr. O.E. Ref.	Tipo di veicolo Vehicle Type
	972547	0003300207 93192361 67354 81432306061	Silentblock laterale barra Torque arm silentblock IVECO DAF MAN

	Ns.Rif. Our Ref.	Rif.Costr. O.E. Ref.	Tipo di veicolo Vehicle Type
	972548	9483501305 9483501205 9483500805	Tirante sospensione Torque arm ACTROS 1996 1831-1835-1840-1843-1848-1853-1857 2031-2035-2040-2053 2531-2535-2540-2543-2548-2553-2557 2631-2635-2640-2643-2648-2653-2657 3231-3235-3240-3243 3331-3335-3340-3343-3348-3353-3357 4140-4143-4148

	Ns.Rif. Our Ref.	Rif.Costr. O.E. Ref.	Tipo di veicolo Vehicle Type

	Ns.Rif. Our Ref.	Rif.Costr. O.E. Ref.	Tipo di veicolo Vehicle Type
 <p data-bbox="95 524 213 560">Dx-Right</p>	954037	-48647-9X62A 11200361-0	Testa sterzo Dx Ball joint Right TRADE L35 ECO T 100 CABSTAR ATLEON
 <p data-bbox="95 922 194 958">Sx-Left</p>	954036	-48527-9X62A 11200360-0	Testa sterzo Sx Ball joint Left TRADE L35 ECO T 100 CABSTAR ATLEON
 <p data-bbox="95 1317 213 1352">Dx-Right</p>	954045	-11500307-0	Testa sterzo Dx Ball joint Right NISSAN ECOT 135 - L701 - L80
 <p data-bbox="95 1711 194 1747">Sx-Left</p>	954044	-11500373-0	Testa sterzo Sx Ball joint Left NISSAN ECOT 135 - L701 - L80
	Ns.Rif. Our Ref.	Rif.Costr. O.E. Ref.	Tipo di veicolo Vehicle Type

L1 810 mm.		
L2 780 mm.		
Ns Riferim. Our Ref.	Rif. Costr. O.E. Ref.	Tipo di veicolo - Vehicle Type
954400	485109x101 11200454-0	ATLEON
L1 787 mm.		
L2 755 mm.		
Ns Riferim. Our Ref.	Rif. Costr. O.E. Ref.	Tipo di veicolo - Vehicle Type
954401	485109x102	ECO L60/70 - 0.95 ECO
L1 667 mm.		
L2 635 mm.		
Ns Riferim. Our Ref.	Rif. Costr. O.E. Ref.	Tipo di veicolo - Vehicle Type
954402	48510F3900	CABSTAR 110-120
Ns Riferim. Our Ref.	Rif. Costr. O.E. Ref.	Tipo di veicolo - Vehicle Type

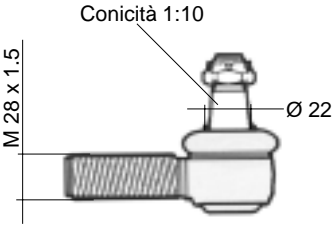
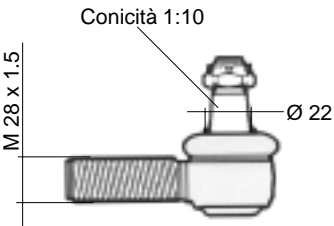
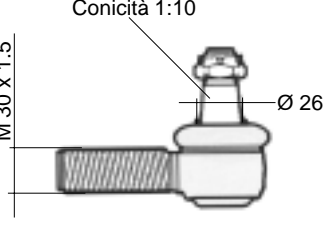
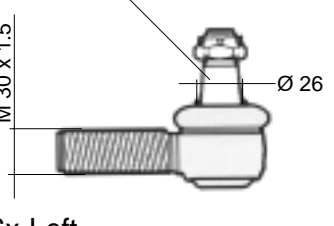
 <p>Dx-Right</p>	<p>Ns.Rif. Our Ref.</p> <p>954026</p>	<p>Rif.Costr. O.E. Ref.</p> <p>5001825687 5000823987 5000559335</p> <p>607453 4833825 81953016272 0003309535 1698191</p>	<p>Tipo di veicolo Vehicle Type</p> <p>MIDLINER M150 - M180 - M210 - M230 - M250 S100 - S130 - S135 - S150 - S160</p> <p>DAF IVECO MAN MERCEDES VOLVO</p>
 <p>Sx-Left</p>	<p>Ns.Rif. Our Ref.</p> <p>954027</p>	<p>Rif.Costr. O.E. Ref.</p> <p>5000823997 5000823947 5000559336</p> <p>607452 4833826 81953016273 0003309635 1698190</p>	<p>Tipo di veicolo Vehicle Type</p> <p>MIDLINER M150 - M180 - M210 - M230 - M250 S100 - S130 - S135 - S150 - S160</p> <p>DAF IVECO MAN MERCEDES VOLVO</p>
 <p>Dx-Right</p>	<p>Ns.Rif. Our Ref.</p> <p>954112</p>	<p>Rif.Costr. O.E. Ref.</p> <p>5000295214</p> <p>698609 4833827 81953016056 00013300135</p>	<p>Tipo di veicolo Vehicle Type</p> <p>MIDLINER M150-M180-M210 - M230 - M250 S150-S180-S210</p> <p>DAF IVECO MAN MERCEDES</p>
 <p>Sx-Left</p>	<p>Ns.Rif. Our Ref.</p> <p>954110</p>	<p>Rif.Costr. O.E. Ref.</p> <p>5000295215</p> <p>607998 4833828 81953016163 3023300335</p>	<p>Tipo di veicolo Vehicle Type</p> <p>MIDLINER M150-M180-M210 - M230 - M250 S150-S180-S210</p> <p>DAF IVECO MAN MERCEDES</p>
	<p>Ns.Rif. Our Ref.</p>	<p>Rif.Costr. O.E. Ref.</p>	<p>Tipo di veicolo Vehicle Type</p>

	Ns.Rif. Our Ref.	Rif.Costr. O.E. Ref.	Tipo di veicolo Vehicle Type
<p>Conicità 1:10</p> <p>M 30 x 1.5</p> <p>Ø 30</p> <p>Dx-Right</p>	954012	5010832582 5000288360	MAGNUM AE385 - AE420 - AE430 - AE470 - AE520 - AE560 MIDLINER M200 - M230 - S150 MAJOR R340 - R350 - R380 - R385 - R420 MANAGER G270 - G280 - G300 - G330 - G340 SERIE R310 - R330 - R340 - R350 R365 - R370 - R380 - R420
		113254 698450 4833822 81953016234 0004602948 395010	ASTRA DAF IVECO MAN MERCEDES SCANIA

	Ns.Rif. Our Ref.	Rif.Costr. O.E. Ref.	Tipo di veicolo Vehicle Type
<p>Conicità 1:10</p> <p>Ø 30</p> <p>M 30 x 1.5</p> <p>Sx-Left</p>	954013	5010832583 5000288361	MAGNUM AE385 - AE420 - AE430 - AE470 - AE520 - AE560 MIDLINER M200 - M230 - S150 MAJOR R340 - R350 - R380 - R385 - R420 MANAGER G270 - G280 - G300 - G330 - G340 SERIE R310 - R330 - R340 - R350 R365 - R370 - R380 - R420
		113253 1228115 4833823 81953016237 0004603548 395009	ASTRA DAF IVECO MAN MERCEDES SCANIA

	Ns.Rif. Our Ref.	Rif.Costr. O.E. Ref.	Tipo di veicolo Vehicle Type
<p>Ø 30</p> <p>M 52 x 1.5</p> <p>Dx-Right</p>	954120	5000288362	RVI (6x4)
		310980	SCANIA

	Ns.Rif. Our Ref.	Rif.Costr. O.E. Ref.	Tipo di veicolo Vehicle Type
<p>Ø 30</p> <p>M 52 x 1.5</p> <p>Sx-Left</p>	954121	5000288363	RVI (6x4)
		310979	SCANIA

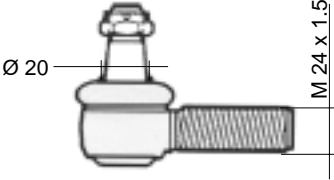
	Ns.Rif. Our Ref.	Rif.Costr. O.E. Ref.	Tipo di veicolo Vehicle Type
 <p>Sx-Left</p>	<p>954216</p>	<p>5000814096</p> <p>0003308635 81953016141 1517448</p>	<p>Testa barra accoppiamento SX Ball joint Left</p> <p>MERCEDES MAN L2000 VOLVO F4</p>

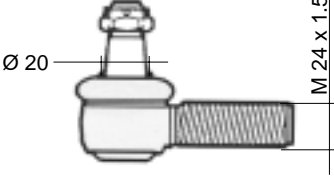
	Ns.Rif. Our Ref.	Rif.Costr. O.E. Ref.	Tipo di veicolo Vehicle Type
 <p>Dx-Right</p>	<p>954217</p>	<p>5000814097</p> <p>0003308535 81953016142 1517449</p>	<p>Testa barra accoppiamento SX Ball joint Left</p> <p>MERCEDES MAN L2000 VOLVO F4</p>

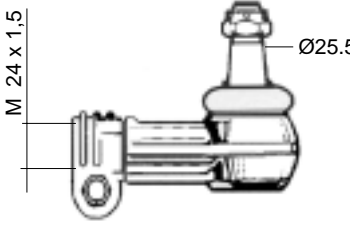
	Ns.Rif. Our Ref.	Rif.Costr. O.E. Ref.	Tipo di veicolo Vehicle Type
	<p>954552</p>	<p>5000792132</p> <p>817824 9281792 82953010011</p>	<p>RENAULT 260-290 MAGNUM - PREMIUM</p> <p>DAF IVECO MAN</p>

	Ns.Rif. Our Ref.	Rif.Costr. O.E. Ref.	Tipo di veicolo Vehicle Type

L1 1012 mm.		
L2 965 mm.		
Ns Riferim. Our Ref.	Rif. Costr. O.E. Ref.	Tipo di veicolo - Vehicle Type
954196	5010138446	SERIE R R370 - R380 - R420
L1 1012 mm.		
L2 965 mm.		
Ns Riferim. Our Ref.	Rif. Costr. O.E. Ref.	Tipo di veicolo - Vehicle Type
954160	5010130453 5000874577	SERIE R R310 - R350 - R360 - R365 R370 - R380 - R390 - R420
L1 1040 mm.		
L2 990 mm.		
Ns Riferim. Our Ref.	Rif. Costr. O.E. Ref.	Tipo di veicolo - Vehicle Type
954200	5010239387 5010130740	SERIE R R340 - R385 - R420
L1 975 mm.		
L2 928 mm.		
Ns Riferim. Our Ref.	Rif. Costr. O.E. Ref.	Tipo di veicolo - Vehicle Type
954198	5010144552 5000787306 5000787305	MANAGER G200 - G210 - G270 G280 - G300 - G340

AD ESAURIMENTO

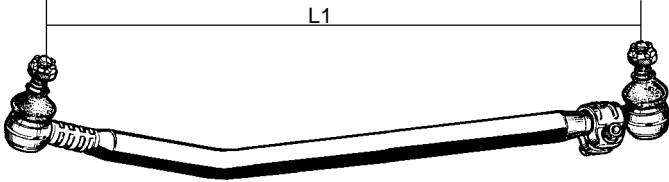
L1 875 mm.		
L2 840 mm.		
Ns Riferim. Our Ref.	Rif. Costr. O.E. Ref.	Tipo di veicolo - Vehicule Type
954193	5000541230 5516017831	MIDLINER S130 - S150

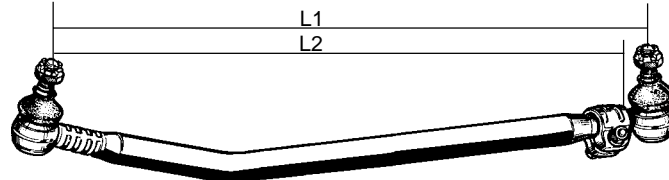
L1 885 mm.		
L2 860 mm.		
Ns Riferim. Our Ref.	Rif. Costr. O.E. Ref.	Tipo di veicolo - Vehicule Type
954191	5010130456 5010163163	MIDLINER M150 - M180 - M200 - M210 - M230 - M250 S120 - S135 - S140 - S150 - S160 - S180 - S210

L1 870 mm.		
L2 815 mm.		
Ns Riferim. Our Ref.	Rif. Costr. O.E. Ref.	Tipo di veicolo - Vehicule Type
954194	5010294199	MIDLINER M250

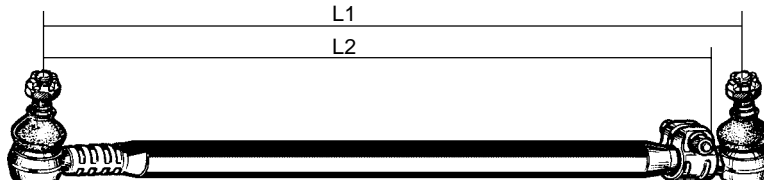
L1 720 mm.		
L2 670 mm.		
Ns Riferim. Our Ref.	Rif. Costr. O.E. Ref.	Tipo di veicolo - Vehicule Type
954153	5010060764 5010557243	MAGNUM AE 420 ti.18 (92-96) AE 420 ti.18T (92-96) AE 420 ti.26 (92-96)

L1 737 mm.		
L2 720 mm.		
Ns Riferim. Our Ref.	Rif. Costr. O.E. Ref.	Tipo di veicolo - Vehicule Type
954163	5010130344	MAGNUM AE385 - AE390 - AE420 - AE430 - AE470 - AE520 - AE560 MAGNUM E.TECH 400 - 440 - 480 (dal 2000 - from 2000) Sospensione anteriore parabolica - Parabolic front suspension

L1 750 mm.		
L2 mm.		
Ns Riferim. Our Ref.	Rif. Costr. O.E. Ref.	Tipo di veicolo - Vehicule Type
954201	5010383203 5010488836	MAGNUM AE390 - AE560 Sospensione anteriore pneumatica - Pneumatic front suspension

L1 872 mm.		
L2 835 mm.		
Ns Riferim. Our Ref.	Rif. Costr. O.E. Ref.	Tipo di veicolo - Vehicule Type
954192	5010130393	MAGNUM AE385 - AE420 - AE430 - AE470 - AE520 - AE560 PREMIUM DISTRIBUTION 250 - 300 - 340 - 400 PREMIUM ROUTE 300 - 340 - 385 - 420 MESSENGER B110 - B120 SERIE G 200 - 210 - 230 - 260 - 280 - 290 - 300 - 330

L1 809 mm.		
L2 755 mm.		
Ns Riferim. Our Ref.	Rif. Costr. O.E. Ref.	Tipo di veicolo - Vehicule Type
954197	5010294287	PREMIUM DISTRIBUTION 210.18-270.18-300.18-300.26-320.18-320.26-340.18-340.26 370.18-370.24-370.26-400.18-420.18 PREMIUM ROUTE 300.18-320.18-340.18-340.26-370.18-370.24-370.26-385.18-385.24-385.26 420.18-420.24-420.25-420.26 Sospensione anteriore parabolica - Parabolic front suspension

Copyright della EMMERRE S.p.A. - Tutti i diritti sono riservati e depositati a norma di legge ed a norma delle convenzioni internazionali. - E' vietata la duplicazione o la riproduzione anche parziale senza la previa autorizzazione della EMMERRE S.p.A.

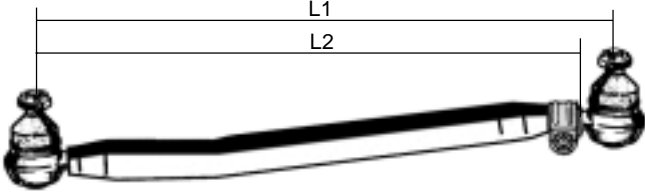
L1 825 mm.		
L2 773 mm.		
Ns Riferim. Our Ref.	Rif. Costr. O.E. Ref.	Tipo di veicolo - Vehicle Type
954094	5010294288	PREMIUM DISTRIBUTION 210.18-270.18-300.18-300.26-320.18-320.26-340.18-340.26 370.18-370.24-370.26-400.18-420.18 PREMIUM ROUTE 300.18-320.18-340.18-340.26-370.18-370.24-370.26-385.18-385.24-385.26 420.18-420.24-420.25-420.26 Sospensione anteriore meccanica - Mechanical front suspension

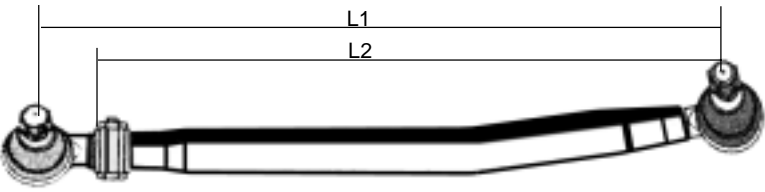
L1 864 mm.		
L2 811 mm.		
Ns Riferim. Our Ref.	Rif. Costr. O.E. Ref.	Tipo di veicolo - Vehicle Type
954095	5010294289	PREMIUM DISTRIBUTION 210.18-270.18-300.18-300.26-320.18-320.26-340.18-340.26 370.18-370.24-370.26-400.18-420.18- PREMIUM ROUTE 300.18-320.18-340.18-340.26-370.18-370.24-370.26-385.18-385.24-385.26 420.18-420.24-420.25-420.26 Sospensione anteriore pneumatica - Pneumatic front suspension

L1 mm.		
L2 mm.		
Ns Riferim. Our Ref.	Rif. Costr. O.E. Ref.	Tipo di veicolo - Vehicle Type

L1 mm.		
L2 mm.		
Ns Riferim. Our Ref.	Rif. Costr. O.E. Ref.	Tipo di veicolo - Vehicle Type

L1 1760 mm.		
L2 1690 mm.		
Ns Riferim. Our Ref.	Rif. Costr. O.E. Ref.	Tipo di veicolo - Vehicule Type
954234	5010566063 5010439021	MAGNUM E.TECH 400-440-480 (dal 05/2000 - to 05/2000) PREMIUM ROUTE - DISTRIBUTION PREMIUM 2 ROUTE - DISTRIBUTION (dal 10/2005 - to 10/2005) Sospensione meccanica - Mechanical suspension

L1 1720 mm.		
L2 1655 mm.		
Ns Riferim. Our Ref.	Rif. Costr. O.E. Ref.	Tipo di veicolo - Vehicule Type
954233	5010439022	ROUTE - DISTRIBUTION Sospensione pneumatica - Pneumatic suspension

L1 1715 mm.		
L2 1660 mm.		
Ns Riferim. Our Ref.	Rif. Costr. O.E. Ref.	Tipo di veicolo - Vehicule Type
954232	5010600822	PREMIUM DXI 440-460-480-500 U.T.

Ns Riferim. Our Ref.	Rif. Costr. O.E. Ref.	Tipo di veicolo - Vehicule Type

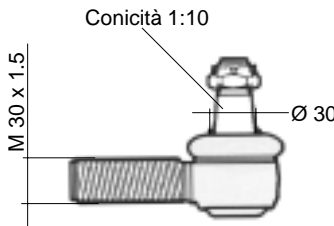
	Ns.Rif. Our Ref.	Rif.Costr. O.E. Ref.	Tipo di veicolo Vehicle Type
 <p>Dx-Right</p>	954012	1358793 1738381 283783 395009	SERIE 93 - 94 - 113 - 143 82 - 112 114 - 124 - 144 - 164
		113254 698450 4833822 81953016234 0004602948 5010832582	ASTRA DAF IVECO MAN MERCEDES RENAULT

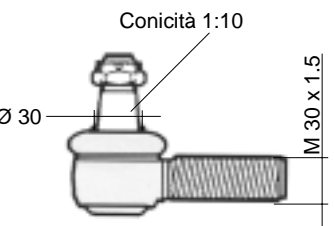
	Ns.Rif. Our Ref.	Rif.Costr. O.E. Ref.	Tipo di veicolo Vehicle Type
 <p>Sx-Left</p>	954013	1358792 1738380 1767328 283784 395010	SERIE 93 - 94 - 113 - 143 82 - 112 114 - 124 - 144 - 164
		113253 1228115 4833823 81953016237 0004603548 5010832583	ASTRA DAF IVECO MAN MERCEDES RENAULT

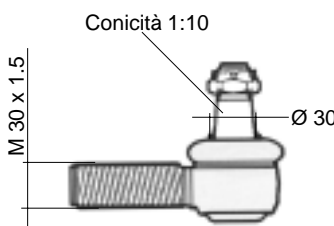
	Ns.Rif. Our Ref.	Rif.Costr. O.E. Ref.	Tipo di veicolo Vehicle Type
 <p>Dx-Right</p>	954123	1337367 352646	SERIE 142 - 143 - 144 (6x4) Angolo di sterzata 35° (Angolar steering 35°)

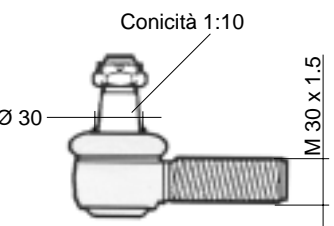
	Ns.Rif. Our Ref.	Rif.Costr. O.E. Ref.	Tipo di veicolo Vehicle Type
 <p>Sx-Left</p>	954122	1337366 352645	SERIE 142 - 143 - 144 (6x4) Angolo di sterzata 35° (Angolar steering 35°)

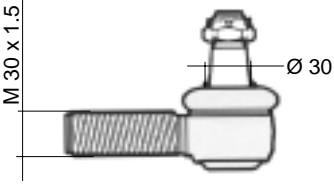
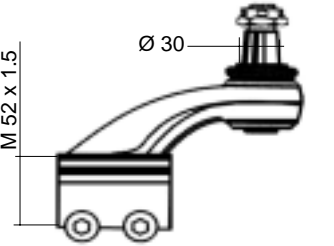
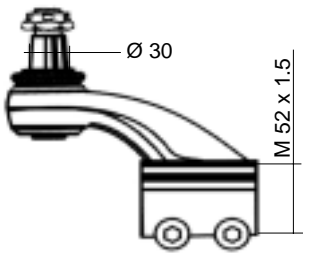
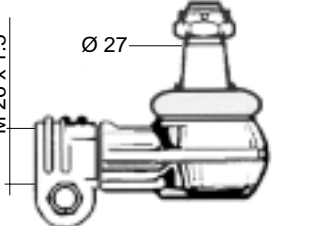
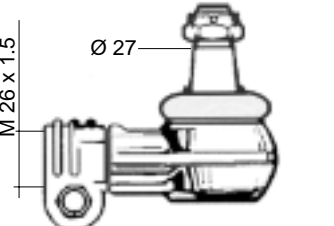
	Ns.Rif. <i>Our Ref.</i>	Rif.Costr. <i>O.E. Ref.</i>	Tipo di veicolo <i>Vehicle Type</i>
	954317	1357674	SERIE 94 - 114 - 124 - 144 - 164
 <p>Dx-Right</p>	954120	310980	SERIE 93 - 113 - 143
 <p>Sx-Left</p>	954121	310979	SERIE 93 - 113 - 143
 <p>Dx-Right</p>	954550	1394443	SCANIA BUS (per cilindro sterzante 3°asse)
 <p>Sx-Left</p>	954551	1394444	SCANIA BUS (per cilindro sterzante 3°asse)

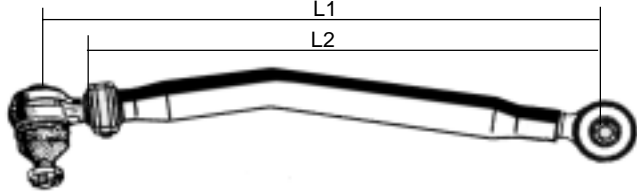
L1 800 mm.		
L2 890 mm.		
Ns Riferim. Our Ref.	Rif. Costr. O.E. Ref.	Tipo di veicolo - Vehicle Type
954103	1305012 1316872 1324483	SERIE 93 - 113 - 143

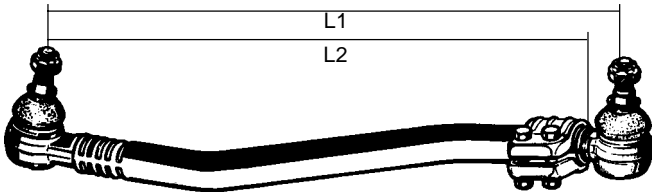
L1 843 mm.		
L2 785 mm.		
Ns Riferim. Our Ref.	Rif. Costr. O.E. Ref.	Tipo di veicolo - Vehicle Type
954105	1112511	SERIE 93 - 113 - 143 Sospensione anteriore pneumatica - Pneumatic front suspension

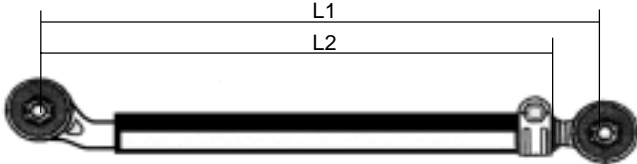
L1 926 mm.		
L2 890 mm.		
Ns Riferim. Our Ref.	Rif. Costr. O.E. Ref.	Tipo di veicolo - Vehicle Type
954180	1304569 370875 1369919	SERIE 93 - 113 - 143

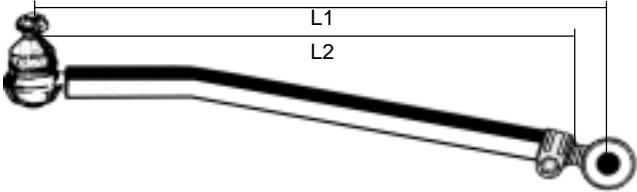
L1 855 mm.		
L2 810 mm.		
Ns Riferim. Our Ref.	Rif. Costr. O.E. Ref.	Tipo di veicolo - Vehicle Type
954165	390784	SERIE 113 - 143

L1 947 mm.		
L2 905 mm.		
Ns Riferim. Our Ref.	Rif. Costr. O.E. Ref.	Tipo di veicolo - Vehicule Type
954104	278665	SERIE 93 - 113 - 143

L1 1052 mm.		
L2 1010 mm.		
Ns Riferim. Our Ref.	Rif. Costr. O.E. Ref.	Tipo di veicolo - Vehicule Type
954167	1384025 1379071 1356055 1768898	SERIE 114 - 124 - 144 (U.T.)

L1 1059 mm.		
L2 mm.		
Ns Riferim. Our Ref.	Rif. Costr. O.E. Ref.	Tipo di veicolo - Vehicule Type
954318	1384027 1769597	SERIE 94 - 114 - 124 - 144 - 164

L1 438,5 mm.		
L2 mm.		
Ns Riferim. Our Ref.	Rif. Costr. O.E. Ref.	Tipo di veicolo - Vehicule Type
954319	1394884	SERIE 94 - 114 - 124 - 144 - 164

L1 495 mm.		
L2 400 mm.		
Ns Riferim. Our Ref.	Rif. Costr. O.E. Ref.	Tipo di veicolo - Vehicule Type
954199	1343266 1759690	SERIE 94 - 114 - 124 - 144

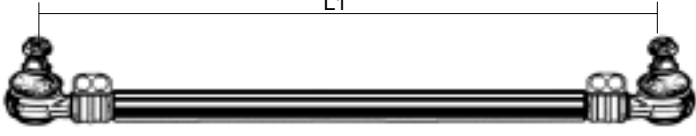
L1 590 mm.		
L2 510 mm.		
Ns Riferim. Our Ref.	Rif. Costr. O.E. Ref.	Tipo di veicolo - Vehicule Type
954202	388943	SERIE 93 - 113 - 143 AD ESAURIMENTO

Ns Riferim. Our Ref.	Rif. Costr. O.E. Ref.	Tipo di veicolo - Vehicule Type

Ns Riferim. Our Ref.	Rif. Costr. O.E. Ref.	Tipo di veicolo - Vehicule Type

Ns Riferim. Our Ref.	Rif. Costr. O.E. Ref.	Tipo di veicolo - Vehicule Type

L1 1743 mm.		
L2 1680 mm.		
Ns Riferim. Our Ref.	Rif. Costr. O.E. Ref.	Tipo di veicolo - Vehicle Type
954204	1385251 1409918 1723895 1897335	Barra accoppiamento ruote - Complete track rod SERIE 94 - 114 - 124 - 144

L1 1743 mm.		
L2 mm.		
Ns Riferim. Our Ref.	Rif. Costr. O.E. Ref.	Tipo di veicolo - Vehicle Type
954211	1395614 1361413 1734019 1897333	Barra accoppiamento ruote - Complete track rod SERIE 94 - 114 - 124 - 144 Sospensione pneumatica anteriore - Pneumatic front suspension

L1 1736 mm.		
L2 1720 mm.		
Ns Riferim. Our Ref.	Rif. Costr. O.E. Ref.	Tipo di veicolo - Vehicle Type
954203	1397866 395350 1397880 1734020	Barra accoppiamento ruote - Complete track rod SERIE 141 - 142 - 143

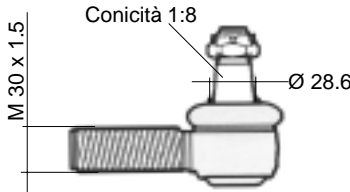
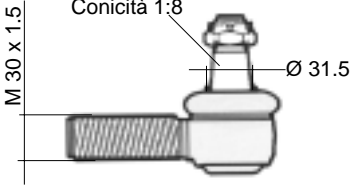
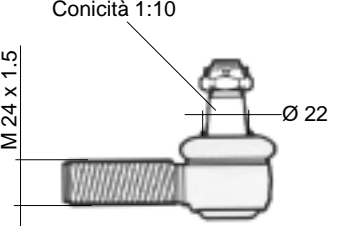
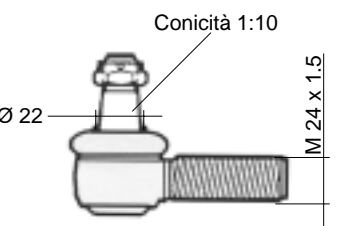
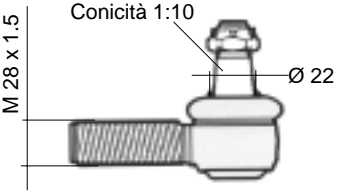
 <p>M 30 x 1.5 Conicità 1:8 Ø 28.6 Dx-Sx - Side L-R</p>	<p>Ns.Rif. Our Ref.</p> <p>954114</p> <p>954115</p>	<p>Rif.Costr. O.E. Ref.</p> <p>1698846</p> <p>1698847</p>	<p>Tipo di veicolo Vehicle Type</p> <p>VOLVO F7 - F10 - F12 - F16 FL6 - FL7 - FL10 - FL12 (Dx-Right)</p> <p>F7 - F10 - F12 - F16 FL6 - FL7 - FL10 - FL12 (Sx-Left)</p>
 <p>M 30 x 1.5 Conicità 1:8 Ø 31.5 Dx-Right</p>	<p>Ns.Rif. Our Ref.</p> <p>954116</p> <p>954107</p>	<p>Rif.Costr. O.E. Ref.</p> <p>1695776 1698557</p> <p>1698840 1698558</p>	<p>Tipo di veicolo Vehicle Type</p> <p>VOLVO F6 - F10 - F12 - F16 FL7 - FL10 - FL12 (Dx-Right)</p> <p>VOLVO F6 - F10 - F12 - F16 FL7 - FL10 - FL12 (Sx-Left)</p>
 <p>M 24 x 1.5 Conicità 1:10 Ø 22 Dx-Right</p>	<p>Ns.Rif. Our Ref.</p> <p>954023</p>	<p>Rif.Costr. O.E. Ref.</p> <p>1696920</p> <p>8558524 0003309835</p>	<p>Tipo di veicolo Vehicle Type</p> <p>VOLVO FL 4.08 FL 6.08 - FL6.10 - FL6.11 - FL6.12 FL 6.14 - FL 6.15 - 6.18</p> <p>IVECO MERCEDES</p>
 <p>Ø 22 Conicità 1:10 M 24 x 1.5 Sx-Left</p>	<p>Ns.Rif. Our Ref.</p> <p>954022</p>	<p>Rif.Costr. O.E. Ref.</p> <p>1696919</p> <p>8558527 0003309935</p>	<p>Tipo di veicolo Vehicle Type</p> <p>VOLVO FL 4.08 FL 6.08 - FL6.10 - FL6.11 - FL6.12 FL 6.14 - FL 6.15 - 6.18</p> <p>IVECO MERCEDES</p>
 <p>M 28 x 1.5 Conicità 1:10 Ø 22 Dx-Right</p>	<p>Ns.Rif. Our Ref.</p> <p>954026</p>	<p>Rif.Costr. O.E. Ref.</p> <p>1698191</p> <p>607453 4833825 81953016249 0003309535 5000823987</p>	<p>Tipo di veicolo Vehicle Type</p> <p>VOLVO F6.09 - F6.10 - F6.11 - F6.13 - F6.14 FL 4.08</p> <p>DAF IVECO MAN MERCEDES RENAULT</p>

<p>Conicità 1:10 M 28 x 1.5 Ø 22 Sx-Left</p>	<p>Ns.Rif. Our Ref.</p> <p>954027</p>	<p>Rif.Costr. O.E. Ref.</p> <p>1698190</p> <p>607452 4833826 81953016222 0003309635 5000823947</p>	<p>Tipo di veicolo Vehicle Type</p> <p>VOLVO F6.09 - F6.10 - F6.11 - F6.13 - F6.14 FL 4.08 DAF IVECO MAN MERCEDES RENAULT</p>
<p>Conicità 1:08 M 30 x 1.5 Ø 26.8 Dx-Sx - Side L-R</p>	<p>Ns.Rif. Our Ref.</p> <p>954108</p> <p>954109</p>	<p>Rif.Costr. O.E. Ref.</p> <p>3988965</p> <p>3988968</p>	<p>Tipo di veicolo Vehicle Type</p> <p>VOLVO FH12 - FH16 (dal 08/93 - from 08/93) (Dx-Right) FM7 - FM10 - FM12</p> <p>VOLVO FH12 - FH16 (dal 08/93 - from 08/93) (Sx-Left) FM7 - FM10 - FM12</p>
<p>Conicità 1:6 M 52 x 1.5 Ø 28,6 Sx-Left</p>	<p>Ns.Rif. Our Ref.</p> <p>954005</p> <p>954006</p>	<p>Rif.Costr. O.E. Ref.</p> <p>1699401 1696901</p> <p>1699400 1696900</p>	<p>Tipo di veicolo Vehicle Type</p> <p>VOLVO F10 - F12 - F16 - FL7 - FL10 - FL12 FH12 - FH16 - FM7 - FM10 - FM12 (Dx-Right)</p> <p>VOLVO F10 - F12 - F16 - FL7 - FL10 - FL12 FH12 - FH16 - FM7 - FM10 - FM12 (Sx-Left)</p>
<p>Ø 20 M 24 x 1.5 Sx-Left</p>	<p>Ns.Rif. Our Ref.</p> <p>954216</p>	<p>Rif.Costr. O.E. Ref.</p> <p>81953016141</p> <p>0003308635 5000814096 1517448</p>	<p>Tipo di veicolo Vehicle Type</p> <p>Testa barra accoppiamento SX Ball joint Left MAN L2000</p> <p>MERCEDES RENAULT VOLVO F4</p>
<p>Ø 20 M 24 x 1.5 Dx-Right</p>	<p>Ns.Rif. Our Ref.</p> <p>954217</p>	<p>Rif.Costr. O.E. Ref.</p> <p>81953016142</p> <p>0003308535 5000814097 1517449</p>	<p>Tipo di veicolo Vehicle Type</p> <p>Testa barra accoppiamento SX Ball joint Left MAN L2000</p> <p>MERCEDES RENAULT VOLVO F4</p>

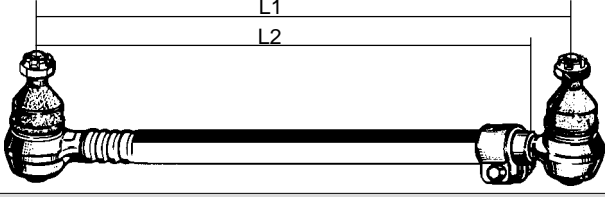
L1 978 mm.		
L2 930 mm.		
Ns Riferim. Our Ref.	Rif. Costr. O.E. Ref.	Tipo di veicolo - Vehicle Type
954214	3124480 3124594	FL6.08 - FL6.11

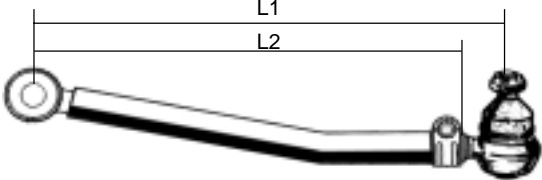
L1 871 mm.		
L2 815 mm.		
Ns Riferim. Our Ref.	Rif. Costr. O.E. Ref.	Tipo di veicolo - Vehicle Type
954212	6790572	FL6.12 - FL6.14

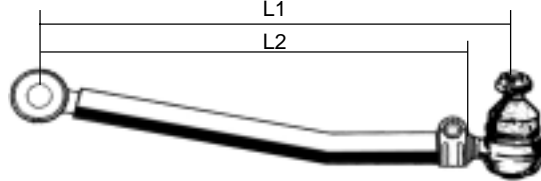
L1 870 mm.		
L2 830 mm.		
Ns Riferim. Our Ref.	Rif. Costr. O.E. Ref.	Tipo di veicolo - Vehicle Type
954213	6799190	FL6.18 (11/91 - 09/98)

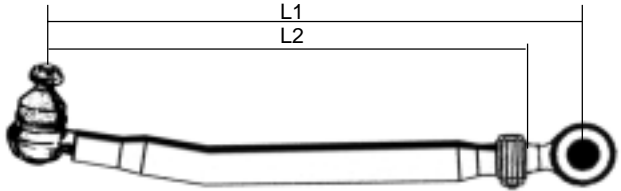
L1 823 mm.		
L2 755 mm.		
Ns Riferim. Our Ref.	Rif. Costr. O.E. Ref.	Tipo di veicolo - Vehicle Type
954178	1592939	FL7 - FL10 - FL12

L1 710 mm.		
L2 680 mm.		
Ns Riferim. Our Ref.	Rif. Costr. O.E. Ref.	Tipo di veicolo - Vehicle Type
954210	1626493 1606277 1588263	F10 - F12 - F16 FL7 - FL12
L1 870 mm.		
L2 815 mm.		
Ns Riferim. Our Ref.	Rif. Costr. O.E. Ref.	Tipo di veicolo - Vehicle Type
954174	1606283 1576092	F10 - F12 - F16 (1a generazione - 1st generation)
L1 850 mm.		
L2 800 mm.		
Ns Riferim. Our Ref.	Rif. Costr. O.E. Ref.	Tipo di veicolo - Vehicle Type
954173	1626751 1610338	F10 - F12 - F16 (2a generazione - 2nd generation)
L1 840 mm.		
L2 820 mm.		
Ns Riferim. Our Ref.	Rif. Costr. O.E. Ref.	Tipo di veicolo - Vehicle Type
954209	1083744	F10 - F12 - F16 (3a generazione - 3rd generation)

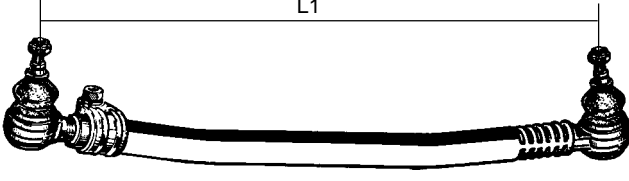
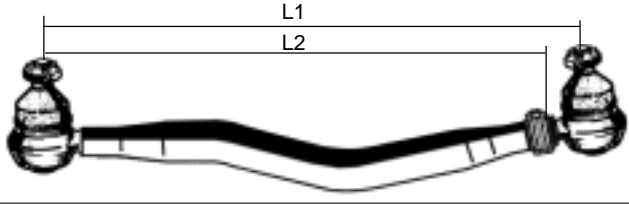
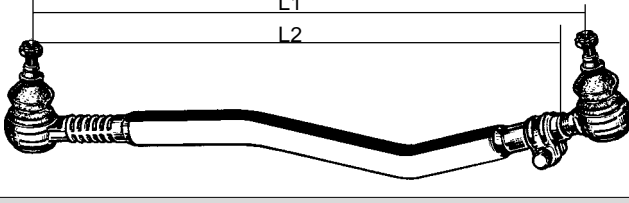
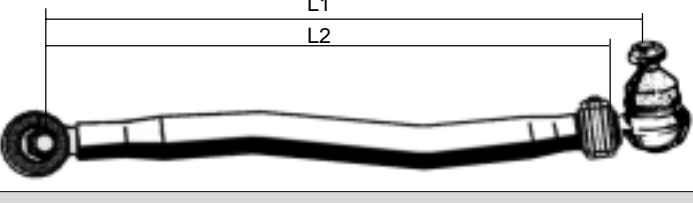
L1 880 mm.		
L2 830 mm.		
Ns Riferim. Our Ref.	Rif. Costr. O.E. Ref.	Tipo di veicolo - Vehicle Type
954208	1626749 1613562	F10 - F12 - F16 (Sospensione pneumatica anteriore) (Front pneumatic suspension)
L1 863 mm.		
L2 800 mm.		
Ns Riferim. Our Ref.	Rif. Costr. O.E. Ref.	Tipo di veicolo - Vehicle Type
954183	1075005	FH 12 - FH16 (1a generazione - 1st generation) (Sospensione meccanica) (Mechanical suspension)
L1 881 mm.		
L2 790 mm.		
Ns Riferim. Our Ref.	Rif. Costr. O.E. Ref.	Tipo di veicolo - Vehicle Type
954169	1628636	FH12 - FH16 (1a generazione - 1st generation) (Sospensione pneumatica) (Pneumatic suspension)
L1 861 mm.		
L2 820 mm.		
Ns Riferim. Our Ref.	Rif. Costr. O.E. Ref.	Tipo di veicolo - Vehicle Type
954172	20393069 3988704 1075663	FM10 - FM12 FH 12 - FH16 (2a generazione - 2nd generation) (Sospensione meccanica - Mechanical suspension)

L1 881 mm.		
L2 835 mm.		
Ns Riferim. Our Ref.	Rif. Costr. O.E. Ref.	Tipo di veicolo - Vehicle Type
954170	20393061 1075153	FM7 - FM10 - FM12 FH 12 - FH16 (2a generazione - 2nd generation) (Sospensione pneumatica - Pneumatic suspension)

L1 1010 mm.		
L2 970 mm.		
Ns Riferim. Our Ref.	Rif. Costr. O.E. Ref.	Tipo di veicolo - Vehicle Type
954207	1197338	B10M - B12M

L1 863 mm.		
L2 830 mm.		
Ns Riferim. Our Ref.	Rif. Costr. O.E. Ref.	Tipo di veicolo - Vehicle Type
954221	3986452 20375555 20393186	VOLVO FH12 - FH16 FM7 - FM10 - FM12

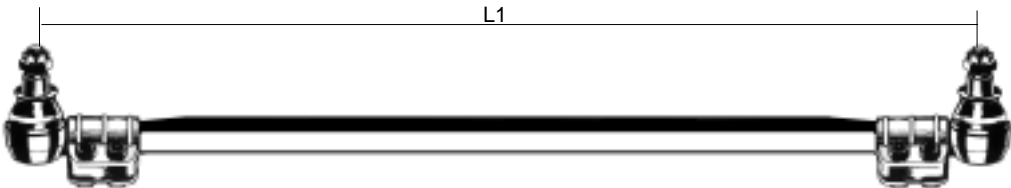

Ns Riferim. Our Ref.	Rif. Costr. O.E. Ref.	Tipo di veicolo - Vehicle Type

Copyright della EMMERRE S.p.A. - Tutti i diritti sono riservati e depositati a norma di legge ed a norma delle convenzioni internazionali. - E' vietata la duplicazione o la riproduzione anche parziale senza la previa autorizzazione della EMMERRE S.p.A.

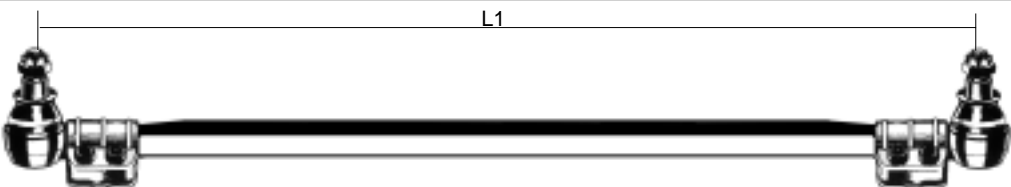
L1 1640 mm.		
L2 1620 mm.		
Ns Riferim. Our Ref.	Rif. Costr. O.E. Ref.	Tipo di veicolo - Vehicule Type
954230	1080792 6862225	Barra di accoppiamento ruote Complete track rod FL7 - FL10 - FL12

L1 1645 mm.		
L2 1620 mm.		
Ns Riferim. Our Ref.	Rif. Costr. O.E. Ref.	Tipo di veicolo - Vehicule Type
954231	3962343 3988711	Barra di accoppiamento ruote Complete track rod FM7 - FM12 (da 08/98) FH12 - FH16 (da 08/93)

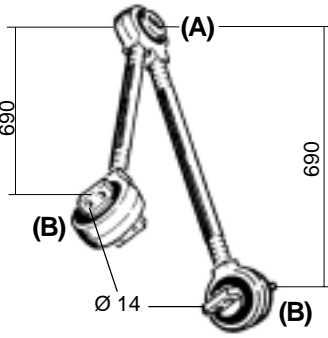
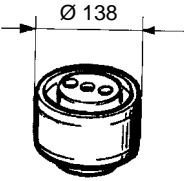
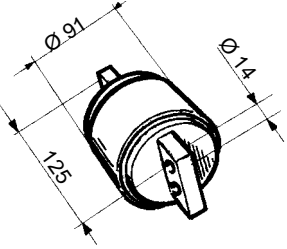
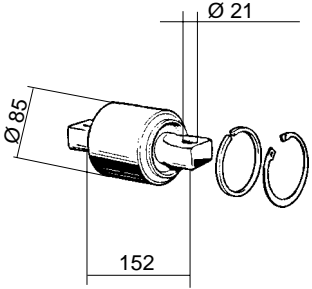
	Ns.Rif. Our Ref.	Rif.Costr. O.E. Ref.	Tipo di veicolo Vehicle Type
	972511	1080690 1606200	Barra angolare sospensioni Angle torque arm F7 - F10 - F12 - F16 FL7 - FL10 - FL12 (SOSPENSIONE MECCANICA) (MECCANICAL SUSPENSION)
	Ns.Rif. Our Ref.	Rif.Costr. O.E. Ref.	Tipo di veicolo Vehicle Type
	972521	273706 (A) 696320 81953016132	Kit revisione centrale barra 1080690 Angle torque arm repair central kit 1080690 F7 - F10 - F12 - F16 FL7 - FL10 - FL12 DAF MAN
	Ns.Rif. Our Ref.	Rif.Costr. O.E. Ref.	Tipo di veicolo Vehicle Type
	972549	273375 (B) 81953016133	Kit revisione laterale barra 1080690 Angle torque arm repair lateral kit 1080690 F7 - F10 - F12 - F16 FL7 - FL10 - FL12 MAN
	Ns.Rif. Our Ref.	Rif.Costr. O.E. Ref.	Tipo di veicolo Vehicle Type
	973056	271188 691704 2968454	Kit revisione centrale barra Angle torque arm repair central kit FM12 - FH12 - FH16 DAF IVECO
	Ns.Rif. Our Ref.	Rif.Costr. O.E. Ref.	Tipo di veicolo Vehicle Type

	Ns.Rif. Our Ref. 972574	Rif.Costr. O.E. Ref. 20556586 1628483	Tipo di veicolo Vehicle Type Barra angolare sospensioni Angle torque arm F10 - F12 - F16 FL7 - FL10 - FL12 (SOSPENSIONE PNEUMATICA) (PNEUMATIC SUSPENSION)
	Ns.Rif. Our Ref. 972569	Rif.Costr. O.E. Ref. 3175769 1075255 (A)	Tipo di veicolo Vehicle Type Silentblock centrale barra 1628483 Angle torque arm central silentblock 1628483 F10 - F12 - F16 FL7 - FL10 - FL12
	Ns.Rif. Our Ref. 972570	Rif.Costr. O.E. Ref. 1598588 (B)	Tipo di veicolo Vehicle Type Silentblock laterale barra 1628483 Angle torque arm lateral silentblock 1628483 F10 - F12 - F16 FL7 - FL10 - FL12
	Ns.Rif. Our Ref. 972550	Rif.Costr. O.E. Ref. 274068 0003500613 691703	Tipo di veicolo Vehicle Type Silentblock laterale barra 1606552 Angle torque arm lateral silentblock 1606552 F10 - F12 - F16 FL7 - FL10 - FL12 MERCEDES DAF
	Ns.Rif. Our Ref. 954320	Rif.Costr. O.E. Ref. 1621419 1608151	Tipo di veicolo Vehicle Type Barra sospensioni Torque arm

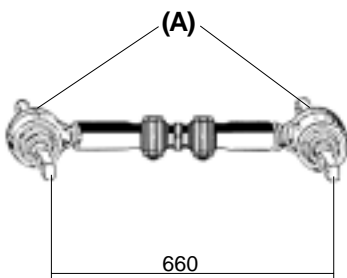
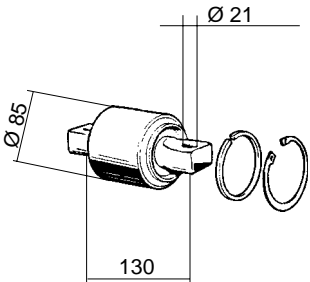
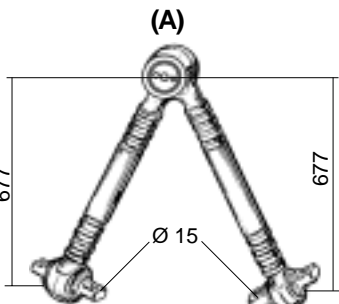
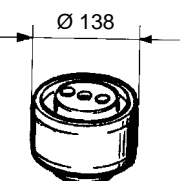
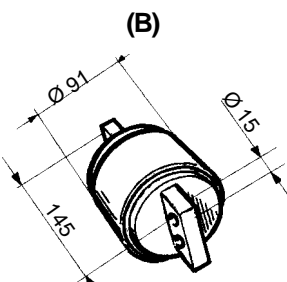

 <p>660</p> <p>AD ESAURIMENTO</p>	<p>Ns.Rif. Our Ref.</p> <p>972590</p>	<p>Rif.Costr. O.E. Ref.</p> <p>1607079 1581527</p>	<p>Tipo di veicolo Vehicle Type</p> <p>Barra sospensioni longitudinale Suspension bar</p> <p>F7 - F10 - F12 FL7 - FL10 - FL12</p> <p>(sospensione meccanica) (mechanical suspension)</p>
 <p>Ø 21</p> <p>Ø 8.5</p> <p>130</p> <p>(A)</p>	<p>Ns.Rif. Our Ref.</p> <p>972591</p>	<p>Rif.Costr. O.E. Ref.</p> <p>274019 550806 (A)</p>	<p>Tipo di veicolo Vehicle Type</p> <p>Silentblock barra 1607079 Silentblock bar 1607079</p> <p>F7 - F10 - F12 FL7 - FL10 - FL12</p> <p>(sospensione meccanica) (mechanical suspension)</p>
 <p>677</p> <p>677</p> <p>Ø 15</p> <p>(A)</p> <p>(B)</p> <p>(B)</p>	<p>Ns.Rif. Our Ref.</p> <p>972575</p>	<p>Rif.Costr. O.E. Ref.</p> <p>20556490 3173291 8156991 1628133</p>	<p>Tipo di veicolo Vehicle Type</p> <p>Barra angolare sospensioni Angle torque arm</p> <p>FM7 - FM10 - FM12 FH12 - FH16</p> <p>(sospensione pneumatica) (pneumatic suspension)</p>
 <p>Ø 138</p> <p>(A)</p>	<p>Ns.Rif. Our Ref.</p> <p>972569</p>	<p>Rif.Costr. O.E. Ref.</p> <p>3175769 1075255 (A)</p>	<p>Tipo di veicolo Vehicle Type</p> <p>Silentblock centrale barra 20556490 Angle torque arm central silentblock 20556490</p> <p>FM7 - FM10 - FM12 FH12 - FH16</p>
 <p>Ø 91</p> <p>Ø 15</p> <p>145</p> <p>(B)</p>	<p>Ns.Rif. Our Ref.</p> <p>972572</p>	<p>Rif.Costr. O.E. Ref.</p> <p>1628107 (B)</p>	<p>Tipo di veicolo Vehicle Type</p> <p>Silentblock laterale barra 20556490 Angle torque arm silentblock 20556490</p> <p>FM7 - FM10 - FM12 FH12 - FH16</p>

	Ns Riferim. Our Ref.	Rif. Costr. O.E. Ref.	Descrizione/Tipo di veicolo Description/Vehicle Type
	914223	8564527	OM40 - 40/35
	914224	8558220	50 - 75
	914222	8550139	50 - 75 - 115.14/17 - 135.14/17
	914237	8578492	50.9 - 65.9 - 60.11 65.12 - 79.12 - 79.14

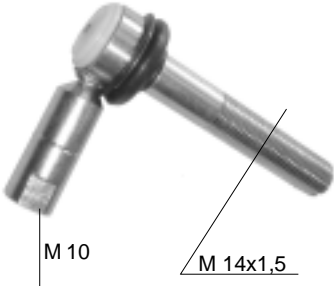
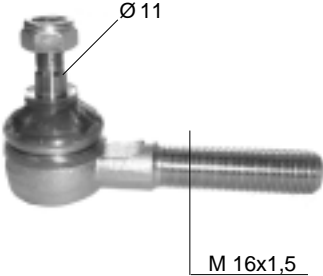
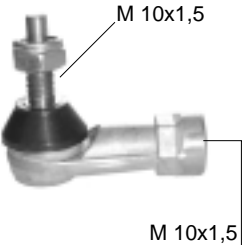
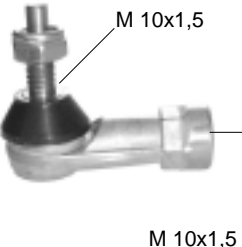
	Ns Riferim. Our Ref.	Rif. Costr. O.E. Ref.	Descrizione/Tipo di veicolo Description/Vehicle Type
	914234	8578493	50.9 - 65.9 - 60.11 - 65.12 79.12 - 79.14 (Tipo Lemforder) (Lemforder type)
	914235	8582313	50.9 - 65.9 - 60.11 - 65.12 - 79.12 - 79.14 (Tipo Ehrenreich) (Ehrenreich type)
<p>Dx-Right</p>	914245	42487482 ZF (0501204714)	AP160 - AP160.12.26/12.29 370 SE.27 - SE.29 - SE.35 Dx (14 x 1,5 mm.) ASTRA 20451 DAF 542477 MAN 81953016169 MERCEDES 0002684889 RENAULT 5000807536 VOLVO 1527453
<p>Filetto Sx-Left</p>	914287	42079837	Testa a snodo (gambo filetto SX M10 x 1,5 mm.) Ball joint (Thread rod RH M10 x 1,5 mm.) 190.26 330.26H - 330.30H - 330.35H - 330.36H

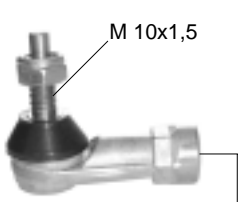
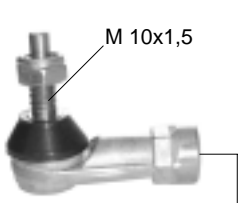
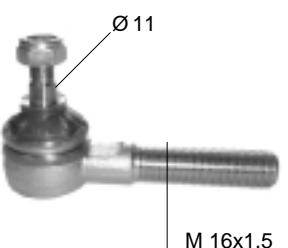
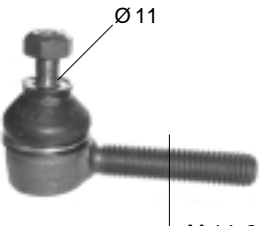

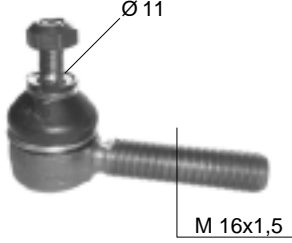
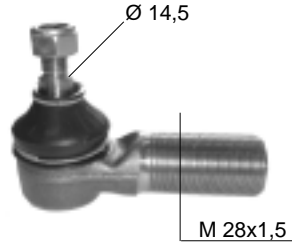
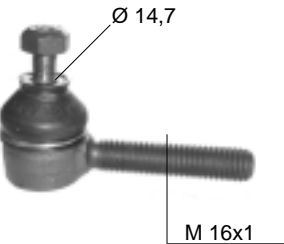

	Ns Riferim. Our Ref.	Rif. Costr. O.E. Ref.	Descrizione/Tipo di veicolo Description/Vehicle Type
 <p>Filetto Dx-Right</p>	914286	42079838	<p>Testa a snodo (gambo filetto DX M10 x 1,5 mm.) Ball joint (Thread rod RH M10 x 1,5 mm.) 190.26 330.26H - 330.30H - 330.35H - 330.36H</p>
	914221	41218482 42042912	<p>TURBOTECH - 330 EUROCARGO - EUROCARGO TECTOR EUROTECH - EUROTECH CURSOR EUROSTAR - EUROSTAR CURSOR EUROTRAKKER - EUROTRAKKER CURSOR STRALIS</p> <p>(M 16 x 1,5 mm.)</p>
 <p>Filetto Dx-Right</p>	914289	41203863 42041327 41002118	<p>EUROCARGO - EUROCARGO TECTOR EUROTECH - EUROTECH CURSOR EUROSTAR - EUROSTAR CURSOR EUROTRAKKER - EUROTRAKKER CURSOR STRALIS</p> <p>(10 x 1,5 mm.)</p>
 <p>Filetto Sx-Left</p>	914288	41203864 42041328 41002119	<p>EUROCARGO - EUROCARGO TECTOR EUROTECH - EUROTECH CURSOR EUROSTAR - EUROSTAR CURSOR EUROTRAKKER - EUROTRAKKER CURSOR STRALIS</p> <p>(10 x 1,5 mm.)</p>





	Ns Riferim. Our Ref.	Rif. Costr. O.E. Ref.	Descrizione/Tipo di veicolo Description/Vehicle Type
 <p>M 10x1,5</p> <p>M 12x1,5</p> <p>Filetto Dx-Right</p>	914248	8188187 ZF (0501206800)	TURBOSTAR - TURBOTECH EUROTECH - EUROTRAKKER - EUROSTAR (12 x 1,75 mm.) ASTRA 20447 DAF 140362 MAN 81953016170 MERCEDES 0002686289 RENAULT 5001000134 SCANIA 371452 VOLVO 1190131
 <p>M 10x1,5</p> <p>M 12x1,5</p> <p>Filetto Sx-Left</p>	914247	8188188 ZF (0501206799)	TURBOSTAR - TURBOTECH EUROTECH - EUROTRAKKER - EUROSTAR (12 x 1,75 mm.) DAF 140363 MAN 81953016064 MERCEDES 0002686189 RENAULT 5010129530 VOLVO 1190132
 <p>Ø 11</p> <p>M 16x1,5</p>	914240	41005523	EUROTECH 190E34/E38 EUROTRAKKER 190E31/E37/E42 260E37/E42 330E37 - 340E42 - 380E31/E37/E42 400E31/E37/E42 410E42 - 720E31/E37/E42 EUROTRAKKER CURSOR 190E38/E44 - 260E38/E44/E48 - 340E38/E44 380E38/E44/E48-400E38/E44-410E38/E44/E48 440E46/E48 - 720E38/E44/E48
 <p>Ø 11</p> <p>M 14x2</p>	914246	350270 243664	SCANIA Serie 93 - 113 - 143 Serie 112 (M14 x 2 mm.)





	Ns Riferim. Our Ref.	Rif. Costr. O.E. Ref.	Descrizione/Tipo di veicolo Description/Vehicle Type
	914292	1383405	SCANIA GRS 900 (M16 x 1,5 mm.)
	914294	1527234	VOLVO F12
	914254	60700015000	Gasolone
	914255	60700014000	Gasolone



	Ns Riferim. Our Ref.	Rif. Costr. O.E. Ref.	Descrizione/Tipo di veicolo Description/Vehicle Type
<p>Filetto Dx-Right</p>	973231	2997004 4525854	<p><i>Testina sospensione Suspension ball Joint</i></p> <p>TURBOSTAR - TURBOTECH - IVECO BUS EUROCARGO - EUROCARGO TECTOR EUROTECH EUROSTAR BUS CITYCLASS</p>
<p>Filetto Sx-Left</p>	973232	2997003 4525855	<p><i>Testina sospensione Suspension ball Joint</i></p> <p>TURBOSTAR - TURBOTECH - IVECO BUS EUROCARGO - EUROCARGO TECTOR EUROTECH EUROSTAR BUS CITYCLASS</p>
<p>Filetto Dx-Right</p>	973214	41019115 41012282	<p><i>Testina sospensione Suspension ball Joint</i></p> <p>EUROCARGO - EUROCARGO TECTOR EUROTECH</p>
<p>Filetto Sx-Left</p>	973215	41019116 41012281	<p><i>Testina sospensione Suspension ball Joint</i></p> <p>EUROCARGO - EUROCARGO TECTOR EUROTECH</p>

	Ns Riferim. Our Ref.	Rif. Costr. O.E. Ref.	Descrizione/Tipo di veicolo Description/Vehicle Type
	973234	4639773	<i>Kit tirante sospensioni (Torque arm kit) 370 - 421AL BUS IVECO BUS</i>
	954305	500383975	<i>Testa a snodo DX Steering joint Daily City 2000 35S9/S11/S12/S13/S15</i>
	954306	500383976	<i>Testa a snodo SX Steering joint Daily City 2000 35S9/S11/S12/S13/S15</i>





	Ns Riferim. Our Ref.	Rif. Costr. O.E. Ref.	Descrizione/Tipo di veicolo Description/Vehicle Type
 <p>Lunghezza - Lenght mm.420</p>	953033	93802065	DAILY RESTYLING 30.8 - 35.8 - 40.8
 <p>Lunghezza - Lenght mm.400</p>	953034	8585982	DAILY RESTYLING 30.8 - 35.8 - 40.8 35.10 - 49.10
 <p>Lunghezza - Lenght mm.390</p>	953030	93812112	NEW DAILY 30.8 - 35.8 - 40.8 35.10 - 49.10
 <p>Lunghezza - Lenght mm.350</p>	953032	93802399	DAILY RESTYLING 30.8 - 35.8 - 40.8 35.10 - 49.10 NEW DAILY 35.10 - 49.10 TURBO DAILY 35.12 - 49.12

	Ns Riferim. Our Ref.	Rif. Costr. O.E. Ref.	Descrizione/Tipo di veicolo Description/Vehicle Type
 <p>Ø 25,5</p> <p>Ø 25,5</p>	953002	8580539	GAMMAZETA 50.9 - 79.14 TURBOZETA 60.11 - 65.12 - 79.12 <i>(Impianto con scatola sterzo)</i> <i>(steering box system)</i>
 <p>Ø 17</p> <p>Ø 25,5</p> <p>Lunghezza - Lenght min 430 - max 570</p>	953001	8580540	GAMMAZETA 50.9 - 79.14 TURBOZETA 60.11 - 65.12 - 79.12 <i>(Impianto con idroguida)</i> <i>(Hydro-steering system)</i>
 <p>Ø 17</p> <p>Ø 25,5</p> <p>Lunghezza - Lenght min 450 - max 590</p>	953003	8581856	ZETA 95.14 - 109.14 <i>(Impianto con idroguida)</i> <i>(Hydro-steering system)</i>
 <p>Ø 17</p> <p>Ø 25,5</p> <p>Lunghezza - Lenght min 500 - max 700</p>	953031	4834295	115-135.14/17 - 145.17

	Ns Riferim. Our Ref.	Rif. Costr. O.E. Ref.	Descrizione/Tipo di veicolo Description/Vehicle Type
 <p>Ø 25,5</p> <p>Ø 25,5</p> <p>Lunghezza - Length min 500 - max 700</p>	953049	4835930	175.17 - 175.24 - 175.24 RSU 190.38 U.T.
 <p>Ø 26</p> <p>Ø 26</p>	953009	8139398	EUROTECH EUROTECH CURSOR EUROTRAKKER EUROTRAKKER CURSOR
 <p>Lunghezza min 441</p>	953006	504035805	<i>Eurocargo Tector Restyling 120 - 260</i>
 <p>Lunghezza min 552</p>	953013	500393296	<i>Eurotech Cursor 190 - 260 Eurotrakker Cursor 410 (sospensione interamente pneumatica) (Entirely pneumatic suspension)</i>

	Ns Riferim. Our Ref.	Rif. Costr. O.E. Ref.	Descrizione/Tipo di veicolo Description/Vehicle Type
 <p>Lunghezza min 459</p>	953014	504051709	Stralis AT 190S40/S43 - 440S40/S43
 <p>Lunghezza min 510</p>	953015	504051707	Stralis AD-AT 190S27/S31/S35/S40 260S31/S35/S40/S43

	Ns Riferim. Our Ref.	Rif. Costr. O.E. Ref.	Descrizione/Tipo di veicolo Description/Vehicle Type
 <p>Ø 17,5</p> <p>Ø 17,5</p> <p>Lunghezza mm.80</p>	953052	93806199	DAILY RESTYLING NEW DAILY TURBO DAILY
 <p>Ø 25</p> <p>Ø 25</p> <p>Lunghezza mm.120</p>	953050	4679363 (4630555) (4688746)	110 - 130NC - 160NC - 684 - 619N1 697 - 300 - 170 - 190.26/33 (75 denti) - (75 teeth)
 <p>Ø 25</p> <p>Ø 25</p> <p>Lunghezza mm.120</p>	953048	42552567 93163078	180.26 - 170-190.30/35/38 190.26H - 190.30H - 330.26H 330.30H - 330.35H (79 denti - acciaio tipo ZF) (79 teeth - steel ZF Type)
 <p>Ø 25</p> <p>Ø 25</p> <p>Lunghezza mm.120</p>	953051	- (4715667)	180.26 - 170-190.30/35/38 (79 denti - Lamiera) (79 teeth - iron sheet metal)

	Ns Riferim. Our Ref.	Rif. Costr. O.E. Ref.	Descrizione/Tipo di veicolo Description/Vehicle Type
	103628	93803481	Supporto albero sterzo (Steering shaft support) NEW DAILY (96) DAILY RESTYLING TURBODAILY (96)
	953016	93806182	Giunto elastico albero sterzo (Steering shaft flexible coupling) NEW DAILY (96) DAILY RESTYLING TURBODAILY (96)
	103634	9921902	Giunto elastico albero sterzo (Steering shaft flexible coupling) OM40/35
	953010	4722013	Cuscinetto albero sterzo (Steering shaft needle bearing) EUROCARGO EUROCARGO TECTOR EUROTECH - EUROTECH CURSOR EUROSTAR - EUROSTAR CURSOR EUROTRAKKER - EUROTRAKKER CURSOR STRALIS
	953020	41025213	Leva bloccaggio sterzo Clamping lever EUROCARGO EUROCARGO TECTOR EUROTECH - EUROTECH CURSOR EUROSTAR - EUROSTAR CURSOR EUROTRAKKER - EUROTRAKKER CURSOR STRALIS

Ns. Riferimento <i>Ns. Ref.</i>	Rif. OE <i>OE Ref.</i>	Descrizione <i>Description</i>
908180	93807553	<i>Traversa sospensione anteriore</i> <i>Suspension gross member</i> NEW DAILY (96) 35.8-40.8-35.10-45.10-49.10 TURBODAILY (96) 35.10-49.10-35.12-49.12



Illustrazione - Illustration

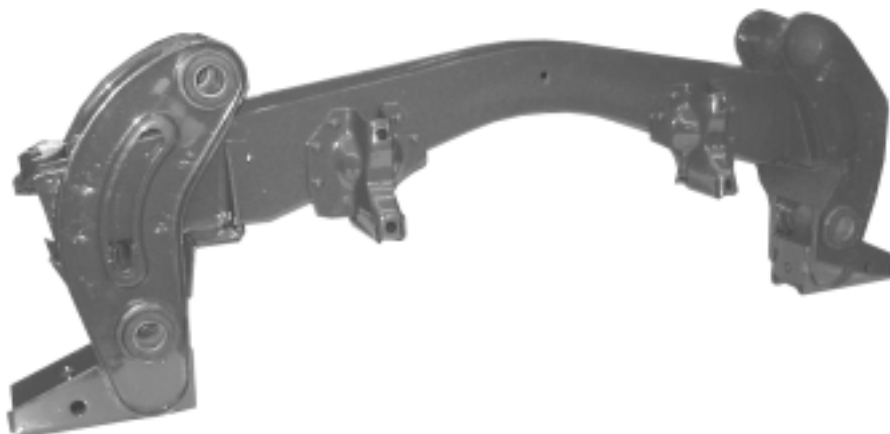

Ns. Riferimento <i>Ns. Ref.</i>	Rif. OE <i>OE Ref.</i>	Descrizione <i>Description</i>
908181	93824293	<i>Traversa sospensione anteriore</i> <i>Suspension gross member</i> TURBODAILY (96) 59.12

Illustrazione - Illustration



	Ns Riferim. Our Ref.	Rif. Costr. O.E. Ref.	Descrizione/Tipo di veicolo Description/Vehicle Type
	908182	-	<p><i>Kit revisione traversa (rif. 93807553)</i> <i>composto da:</i> <i>Kit repair cross arm composed by:</i></p> <p>93807640 <i>Boccola inferiore</i> Pz. 6 93803299 <i>Tampone</i> Pz. 2 93810239 <i>Boccola barra</i> Pz. 2 93807567 <i>Supporto balestra</i> Pz. 2</p> <p>New Daily '96 35.8-40.8-35.10-45.10-49.10 Turbodaily '96 35.10-49.10-35.12-49.12</p>
	908183	-	<p><i>Kit revisione traversa (rif. 500350345)</i> <i>composto da:</i> <i>Kit repair cross arm composed by:</i></p> <p>500350342 <i>Boccola inferiore</i> Pz. 6 500350343 <i>Boccola superiore</i> Pz. 2 93810239 <i>Boccola barra</i> Pz. 2 93803299 <i>Tampone</i> Pz. 2 93807567 <i>Supporto balestra</i> Pz. 2</p> <p>Daily City 2000 65C11/C13/C15</p>

BARRE DI TORSIONE TORSION BARS

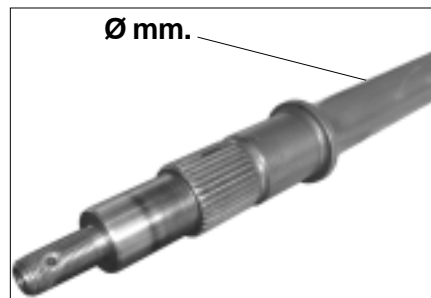

Ns.Rif. Our Ref.	Rif.Costr. O.E. Ref.	Descrizione Description	Ø mm. Ø mm.	Tipo di applicazione Application type
963562	93811176	Barra di torsione Torsion bar DX	Ø 27,50 mm.	NEW DAILY (96) 30.8 - 35.8 - 40.8 - 35.10 TURBODAILY (96) 35.10 - 35.12
963561	93811175	Barra di torsione Torsion bar SX	Ø 27,50 mm.	
963564	93812734	Barra di torsione Torsion bar DX	Ø 29,00 mm.	NEW DAILY (96) 30.8 - 35.8 - 40.8 35.10 - 45.10 - 49.10
963563	93812733	Barra di torsione Torsion bar SX	Ø 29,00 mm.	TURBODAILY (96) 35.10 - 49.10 - 35.12 - 49.12 DAILY CITY 2000 35C9/C11/C13/C15 - 35C10/C12 50C11/C13/C15
963565	93810228	Barra di torsione Torsion bar DX	Ø 31,00 mm.	NEW DAILY (96) 49.10
963566	93810229	Barra di torsione Torsion bar SX	Ø 31,00 mm.	TURBODAILY (96) 49.12 - 59.12
963568	60170736	Barra di torsione Torsion bar DX	Ø 33,00 mm.	DAILY CITY 2000 65C13 - 65C15
963567	60170737	Barra di torsione Torsion bar SX	Ø 33,00 mm.	

Ns. Riferimento Ns. Ref.	Rif. OE OE Ref.	Descrizione Description
973235	500379801 500344888-42551296	Braccio oscillante sospensione superiore Sx Upper swing arm suspension Right
973236	500379802 500344887-42551297	Braccio oscillante sospensione superiore Dx Upper swing arm suspension Left



Illustrazione Illustration	Tipo di veicolo Vehicle Type
-------------------------------	---------------------------------

 <p>BRACCIO SOSPENSIONE SUPERIORE UPPER SWING ARM SUSPENSION</p>	<p>DAILY CITY 2000 35S9/S11/S13/S15 35C9/C11/C13/C15 35S10/S12 35C10/C12</p> <p>DAILY 2006 35C10/C12/C15</p>
---	--





Ns. Riferimento Ns. Ref.	Rif. OE OE Ref.	Descrizione Description
973237	500334716 500334486-42551289	Braccio oscillante sospensione inferiore Dx Lower swing arm suspension Right
973238	500334717 500334487-42551290	Braccio oscillante sospensione inferiore Sx Lower swing arm suspension Left

Illustrazione Illustration	Tipo di veicolo Vehicle Type
-------------------------------	---------------------------------

 <p>BRACCIO SOSPENSIONE INFERIORE LOWER SWING ARM SUSPENSION</p>	<p>DAILY CITY 2000 35S9/S11/S13/S15 35C9/C11/C13/C15 35S10/S12 35C10/C12</p> <p>DAILY 2006 35C10/C12/C15</p>
--	--

	Ns Riferim. Our Ref.	Rif. Costr. O.E. Ref.	Descrizione/Tipo di veicolo Description/Vehicle Type
	<p>973242</p>	<p>-</p>	<p><i>Kit revisione bracci sospensione superiori (rif. 500379801/9802) composto da:</i> <i>Repairing set for upper swing arm suspension composed by:</i></p> <p>504039506 Pz. 4 500339201 Pz. 2 973252 Pz. 1 Daily City 2000</p>
	<p>973243</p>	<p>-</p>	<p><i>Kit revisione bracci sospensione inferiori (rif. 500334716/4717) composto da:</i> <i>Repairing kit for upper swing arm suspension composed by:</i></p> <p>504039506 Pz. 4 500339201 Pz. 2 973251 Pz. 1 Daily City 2000</p>

Copyright della EMMERRE S.r.l. - Tutti i diritti sono riservati e depositati a norma di legge ed a norma delle convenzioni internazionali. - E' vietata la duplicazione o la riproduzione anche parziale senza la previa autorizzazione della EMMERRE S.r.l.

	Ns Riferim. Our Ref.	Rif. Costr. O.E. Ref.	Descrizione/Tipo di veicolo Description/Vehicle Type
	973250	504039506	<i>Silentblock braccio oscillante superiore ed inferiore</i> <i>Swing arm silentblock</i> DAILY CITY 2000 35S9/S11/S13/S15 35C9/C11/C13/C15 35S10/S12 35C10/C12
 Ø 18 mm.	973252	-	<i>Testina articolazione Dx-Sx per revisione bracci oscillanti</i> <i>ref. 500379801 - 500379802</i> <i>Head joint right - left for swing arm suspension</i> <i>ref. 500379801 - 500379802</i> DAILY CITY 2000 35S9/S11/S13/S15 35C9/C11/C13/C15 35S10/S12 35C10/C12
 Ø 22,90 mm.	973251	-	<i>Testina articolazione Dx-Sx per revisione bracci oscillanti</i> <i>ref. 500334716-500334717</i> <i>Head joint right - left for swing arm suspension</i> <i>ref. 500334716-500334717</i> DAILY CITY 2000 35S9/S11/S13/S15 35C9/C11/C13/C15 35S10/S12 35C10/C12
	963621	500315608	<i>Barra di torsione superiore</i> <i>Upper torsion bar</i> Daily City 2000 35S9/S11/S12/S13/S15

	Ns Riferim. Our Ref.	Rif. Costr. O.E. Ref.	Descrizione/Tipo di veicolo Description/Vehicle Type
	954310	93804572	<i>Fuso a snodo DX</i> <i>Stub axle</i> New Daily Daily Restyling Turbodaily
	954311	93804573	<i>Fuso a snodo SX</i> <i>Stub axle</i> New Daily Daily Restyling Turbodaily
	954312	93801772	<i>Leva fuso snodo DX</i> <i>Stub axle lever</i> New Daily Daily Restyling Turbodaily
	954313	93801773	<i>Leva fuso snodo SX</i> <i>Stub axle lever</i> New Daily Daily Restyling Turbodaily

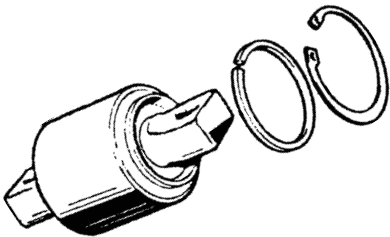
	Ns Riferim. Our Ref.	Rif. Costr. O.E. Ref.	Descrizione/Tipo di veicolo Description/Vehicle Type
	973146	93822444	<i>Tirante filettato inferiore</i> <i>Lower threaded tie rod</i> DAILY 30.8-35.8-40.8 NEW DAILY '96 35-45.10 - 35-49.12
	973147	93822441	<i>Tirante filettato superiore</i> <i>Upper threaded tie rod</i> DAILY 30.8-35.8-40.8 NEW DAILY '96 35-45.10 - 35-49.12
	973144	504207331	<i>Tirante filettato inferiore</i> <i>Lower threaded tie rod</i> DAILY 65C18
	973145	93810223	<i>Tirante filettato superiore</i> <i>Upper threaded tie rod</i> DAILY 65C11-C13-C15-C18 DAILY 59.12 ('96)
	973244	4741171	<i>Tirante oscillante sospensioni</i> <i>Torque arm swing</i> TURBOSTAR TURBOTECH

	Ns Riferim. Our Ref.	Rif. Costr. O.E. Ref.	Descrizione/Tipo di veicolo Description/Vehicle Type
	973239	93807566	<i>Braccio oscillante sospensione anteriore (superiore)</i> <i>Front swing arm suspension (upper)</i> New Daily Turbodaily
	973249	93810157	<i>Braccio oscillante sospensione superiore DX-SX</i> <i>Upper front swing arm right-left</i> NEWDAILY 96 35.8/10 - 49.10 TURBODAILY 35.12/49.12 DAILY CITY 2000 35C9/C11/C13/C15 50C11/C13/C15
	973142	504207327	<i>Braccio oscillante superiore SX</i> <i>Upper swing arm suspension LH</i> DAILY 65C18
	973143	504213051	<i>Braccio oscillante superiore DX</i> <i>Upper swing arm suspension RH</i> DAILY 65C18

	Ns Riferim. Our Ref.	Rif. Costr. O.E. Ref.	Descrizione/Tipo di veicolo Description/Vehicle Type
	973131	93815026	Braccio oscillante sospensione superiore SX Upper swing arm Left
	973158	93815025	Braccio oscillante sospensione superiore DX Upper swing arm Right TURBODAILY 59.12 NEWDAILY 96 35.8/10 - 49.10 - 35.12 - 49.12 DAILY CITY 2000 35C9/C10/C11/C12/C13/C15 50C11/C13/C15
	973240	8574229	Braccio oscillante sospensione anteriore inferiore Lower swing arm suspension New Daily Daily Restyling Turbodaily
	973248	41000480	Braccio oscillante sospensione superiore Upper swing arm suspension EUROTECH - EUROSTAR EUROTRAKKER - CURSOR STRALIS
	973140	504207328	Braccio oscillante sospensione inferiore SX Lower swing arm suspension LH
973141	504207329	Braccio oscillante sospensione inferiore DX Lower swing arm suspension RH DAILY 65C18	



Hydro Pump

LINEA RAFFREDDAMENTO
COOLING SYSTEM
SYSTEME DE REFROIDISSEMENT
SISTEMA DE REFRIGERACION
KUHLSYSTEM
Система охлаждения
نظام التبريد

EMMEDE



2009

EMMERRE

**ARTICOLI NUOVI INSERITI
NEL CATALOGO
IMPIANTO DI
RAFFREDDAMENTO
2009**



**NEW ARTICLES INCLUDED IN
COOLING SYSTEM
CATALOGUE
2009**

POMPE ACQUA - WATER PUMP

EMMERRE	Adattabile - Adaptable	Applicazione - Application	Pagina - Page
907090	51.06500.6515	MAN	26
907106	51.06500.6606	MAN	27
907107	51.06500.6537	MAN	27
907108	51.06500.6408	MAN	26
907109	8170305	VOLVO	45
907112	422.200.1001	MERCEDES	35
907120	3183908	VOLVO	44
907124	51.06500.6479	MAN	28
907127	51.06500.6282	MAN	28
907134	51.06500.6476	MAN	26
907136	5422002001	MERCEDES	30
907137	51.06500.6495	MAN	27
907138	99483937	IVECO	17
907139	500356553	IVECO	17
907140	504033770	IVECO	6
907143	51.06500.7066	MAN	28
907144	1549482	SCANIA	41
907145	2101069T02	NISSAN	38
907243	504113544	IVECO	6
907299	504062854	IVECO	15
907315	4032007101	MERCEDES	37
907333	4032007601	MERCEDES	37
907336	4412000201	MERCEDES	36
907342	4572000501	MERCEDES	36
907351	9062006101	MERCEDES	36
907352	259.065	SCANIA	42
907358	5001857427	RENAULT	40
907359	1778280	DAF	3
907360	683338	DAF	3
907361	5010323187	RENAULT	40
907362	50.10.248.921	RENAULT	40
907363	8829787	IVECO	8
907364	683225	DAF	3
907365	7701468342	RENAULT	39

EMMERRE

**ARTICOLI NUOVI INSERITI
NEL CATALOGO
IMPIANTO DI
RAFFREDDAMENTO
2009**



**NEW ARTICLES INCLUDED IN
COOLING SYSTEM
CATALOGUE
2009**

VENTILATORI ARIA - AIR BLOWER

EMMERRE	Adattabile - Adaptable	Applicazione - Application	Pagina - Page
907232	1448197	DAF	49
907240	1338736	DAF	49
907249	1315854	DAF	49
907353	51066010275	MAN	57
907354	1412398	SCANIA	60
907355	1393424	SCANIA	60
907356	1422502	SCANIA	60
907357	1674865	VOLVO	61

RADIATORI ACQUA e VARIE IMP. RAFFREDDAMENTO WATER RADIATOR AND VARIOUS

906192	41215631	IVECO	69
906878	93930676	IVECO	68
906907	99487905	IVECO	67
906908	93930693	IVECO	68
906909	93930687	IVECO	68
906924	504152996	IVECO	67
906925	504045487	IVECO	66
906934	504008108	IVECO	67
907042	98434054	IVECO	82

Ns. Riferimento Ns. Ref.	Tipo applicazione Application type	<i>Semipompa acqua</i> <i>Water semi-pump</i>
907359	XF 105	
Rif. Costruttore OE. Ref.		
1778280		
Tipo motore Engine type		
	MX 300/340/375	

Ns. Riferimento Ns. Ref.	Tipo applicazione Application type	<i>Pompa acqua</i> <i>Water pump</i>
907360	CF 75	
Rif. Costruttore OE. Ref.		
683338		
Tipo motore Engine type		
	PF 183M / 212M / 235M	

Ns. Riferimento Ns. Ref.	Tipo applicazione Application type	<i>Pompa acqua</i> <i>Water pump</i>
907364	CF 85	
Rif. Costruttore OE. Ref.		
683225		
Tipo motore Engine type		
	95XF - 95.430 - 95.480	

Ns. Riferimento Ns. Ref.	Tipo applicazione Application type	Pompa acqua completa Complete water pump 
907169	Daily Restyling 30.8-35.8-40.8 - 35.10	
Rif. Costruttore OE. Ref.	NewDaily 30.8-35.8-40.8 - 35.10-49.10	
99440728 (ex. 99440726 - 7303009)		
Tipo motore Engine type		

Ns. Riferimento Ns. Ref.	Tipo applicazione Application type	Pompa acqua completa Complete water pump 
907147	Daily Restyling 35.10 - 49.10	
Rif. Costruttore OE. Ref.		
2995627 99459755 (ex. 7303056)		
Tipo motore Engine type		

Ns. Riferimento Ns. Ref.	Tipo applicazione Application type	Pompa acqua completa Complete water pump 
907170	NewDaily 30.8-35.8-40.8 - 35.10-49.10	
Rif. Costruttore OE. Ref.	TurboDaily 35.12 - 49.12 - 59.12	
2995629 99459757 (ex. 98435994)		
Tipo motore Engine type		

Ns. Riferimento Ns. Ref.	Tipo applicazione Application type	<i>Pompa acqua completa Complete water pump</i>
907186	NewDaily 1996 30.8-35.8-40.8 - 35.10 - 49.10	
Rif. Costruttore OE. Ref.	TurboDaily 1996 35.12 - 49.12 - 59.12	
500361919 500361203 (ex. 500300476 - 99438900)		
Tipo motore Engine type		

Ns. Riferimento Ns. Ref.	Tipo applicazione Application type	<i>Pompa acqua completa Complete water pump</i>
907185	Daily City 2000 35S9/S11/S13/S15 35C9/C11/C13/C15 50C11/C13/C15 65C13/C15	
Rif. Costruttore OE. Ref.		
500362859 (ex. 99479817)		
Tipo motore Engine type		

Ns. Riferimento Ns. Ref.	Tipo applicazione Application type	<i>Pompa acqua completa Complete water pump</i>
907193	Daily City 2000 35S9/S11/S13/S15 35C9/C11/C13/C15 50C11/C13/C15 65C13/C15	
Rif. Costruttore OE. Ref.		
500362834		
Tipo motore Engine type		

Ns. Riferimento Ns. Ref.	Tipo applicazione Application type	<p>Pompa acqua Water pump</p> 
907140	Daily M.Y. 2006 29L10 / L12 / L14 35C10 / C12 35S10 / S12 / S14 40C10 / C12 / C14	
Rif. Costruttore OE. Ref.		
504033770		
Tipo motore Engine type		

Ns. Riferimento Ns. Ref.	Tipo applicazione Application type	<p>Pompa acqua Water pump</p> 
907243	Daily M.Y. 2006 (MATERIALE IN GHISA CAST IRON MATERIAL) 35C15 / C18 40C15 / C18 45C15 / C18 50C15 / C18 60C15 / C18 65C15 / C18	
Rif. Costruttore OE. Ref.		
504113544		
Tipo motore Engine type		

Ns. Riferimento Ns. Ref.	Tipo applicazione Application type	<p>Pompa acqua Water pump</p> 
907174	Daily M.Y. 2006 (MATERIALE IN ALLUMINIO ALLUMINIUM MATERIAL) 35C15 / C18 40C15 / C18 45C15 / C18 50C15 / C18 60C15 / C18 65C15 / C18	
Rif. Costruttore OE. Ref.		
504087367		
Tipo motore Engine type		

Ns. Riferimento Ns. Ref.	Tipo applicazione Application type	Pompa acqua completa Complete water pump 
907149	OM 40 - 40/35NC - 50NC OM100 - 110	
Rif. Costruttore OE. Ref.	IVECO APPLICAZIONI AIFO	
93191101 (ex. 4679242)		
Tipo motore Engine type		
8031-8041-8051-8061		

Ns. Riferimento Ns. Ref.	Tipo applicazione Application type	Pompa acqua completa Complete water pump 
907162	Unic 50 - 55 - 65 - 70 - 80 - 90 - 100U10	
Rif. Costruttore OE. Ref.		
8829770		
Tipo motore Engine type		
C03 VAR 41 - C03 VAR 49		

Ns. Riferimento Ns. Ref.	Tipo applicazione Application type	Pompa acqua completa Complete water pump 
907163	65F10 - 70F10 - 75F10 OM50 - OM8 - OM9 - OM10 OM55 - OM8 - OM9 - OM10 IVECO 50.9 - 50.10 - 55.9 - 55.10 60.10 - 65.10 - 70.10 - 75.10 79.10 (1°-2°-3° serie)	
Rif. Costruttore OE. Ref.		
4796535		
Tipo motore Engine type		

Ns. Riferimento Ns. Ref.	Tipo applicazione Application type	<p>Pompa acqua Water pump</p> 
907363	FIAT OM	
Rif. Costruttore OE. Ref.		
8829787		
Tipo motore Engine type		
	CM3 CO3-70 CO3-80	

Ns. Riferimento Ns. Ref.	Tipo applicazione Application type	
Rif. Costruttore OE. Ref.		
Tipo motore Engine type		

Ns. Riferimento Ns. Ref.	Tipo applicazione Application type	
Rif. Costruttore OE. Ref.		
Tipo motore Engine type		

Ns. Riferimento Ns. Ref.	Tipo applicazione Application type	<i>Pompa acqua completa Complete water pump</i>
907161	Lupetto 25 - 30	
Rif. Costruttore OE. Ref.	Cerbiatto Daino	
8829154		
Tipo motore Engine type		
C03		

Ns. Riferimento Ns. Ref.	Tipo applicazione Application type	<i>Pompa acqua completa Complete water pump</i>
907187	FIAT	
Rif. Costruttore OE. Ref.	80NC-90NC-N100 80 OM13 - 90 OM13 - 100 OM13 79.13 (1°-2°serie) - 79.14 (3°serie) 80.13 - 80.13A - 90.13 - 90.13A 100.13 - 100.14 - 120.13	
93191103 (ex. 4679559)		
Tipo motore Engine type		

Ns. Riferimento Ns. Ref.	Tipo applicazione Application type	<i>Pompa acqua completa Complete water pump</i>
907151	ZETA 50.9 - 65.9	
Rif. Costruttore OE. Ref.	TURBOZETA 60.11 - 79.12	
4813370		
Tipo motore Engine type		

**Ns. Riferimento
Ns. Ref.**

907167

**Rif. Costruttore
OE. Ref.**

98497117
(ex. 4784454)

**Tipo motore
Engine type**

8031 i 05 - 8041 i 05 - 8051 i 05
8061 i 05 - 8061 si 05 - 8061 si 15
8061 si 25 - 8065 si 25

**Tipo applicazione
Application type**

ZETA 50.9 - 65.9
TURBOZETA 65.12 - 60.11 - 79.12

IVECO APPLICAZIONI AIFO

**Pompa acqua completa
Complete water pump**



**Ns. Riferimento
Ns. Ref.**

907150

**Rif. Costruttore
OE. Ref.**

98497115
(ex. 4835043)

**Tipo motore
Engine type**

**Tipo applicazione
Application type**

ZETA 50.9 - 65.9
TURBOZETA 65.12 - 79.12
115 - 135

**Pompa acqua completa
Complete water pump**



**Ns. Riferimento
Ns. Ref.**

907152

**Rif. Costruttore
OE. Ref.**

4606023
(ex. 4762458)

**Tipo motore
Engine type**

**Tipo applicazione
Application type**

684NP-T-TP - 690N4 - 691N-T
693N1 - 697N-T-NP - 180NC
300PC-PT
UNIC 190 PAC 26 - 190.26N
260 PAC 26 - 260.26N - 260.26NW
330 PAC26 - 330.26N

**Pompa acqua completa
Complete water pump**





Ns. Riferimento Ns. Ref.	Tipo applicazione Application type	Pompa acqua completa Complete water pump 
907157	FIAT 682 - 690	
Rif. Costruttore OE. Ref.		
4538058		
Tipo motore Engine type		

Ns. Riferimento Ns. Ref.	Tipo applicazione Application type	Pompa acqua completa Complete water pump 
907172	330.26H - 330.30H 190.26H	
Rif. Costruttore OE. Ref.		
4752137		
Tipo motore Engine type		

Ns. Riferimento Ns. Ref.	Tipo applicazione Application type	Pompa acqua completa Complete water pump 
907188	FIAT 160 - 160NC 170.26 - 190.26 - 220.26 - 300.26 TURBOSTAR 190.30 - 190.33 - 240.30 - 240.33	
Rif. Costruttore OE. Ref.		
4710552 (ex. 4692698 - 4717916)		
Tipo motore Engine type		

Ns. Riferimento Ns. Ref.	Tipo applicazione Application type	<p>Pompa acqua completa Complete water pump</p> 
907154	TURBOSTAR 190.38 - 220.38 - 240.38 - 190.42	
Rif. Costruttore OE. Ref.		
4764156 (ex. 4737154)		
Tipo motore Engine type		

Ns. Riferimento Ns. Ref.	Tipo applicazione Application type	<p>Pompa acqua completa Complete water pump</p> 
907155	TURBOSTAR 190.48 - 220.48 - 240.48 - 260.48	
Rif. Costruttore OE. Ref.	EUROSTAR 190E52 - 240E52 - 260E52 400E52 - 440E52	
500300470 (ex. 4812406)	EURORIDER .29 - .35	
Tipo motore Engine type		

Ns. Riferimento Ns. Ref.	Tipo applicazione Application type	<p>Semipompa per pompa acqua 61315464</p> <p>Semicomplete water pump for water pump 61315464</p>  <p>N°23 denti H 20 mm. N°23 theets H 20 mm.</p>
907189	175.24 RSU	
Rif. Costruttore OE. Ref.	TURBOTECH 190.24/26/32 - 240.26/32 - 260.32 370S24	
93190288	TURBOCITY 480 - 580	
Tipo motore Engine type		

Ns. Riferimento Ns. Ref.	Tipo applicazione Application type	<i>Pompa acqua completa Complete water pump</i>
907153	TURBOSTAR 190.36 - 220.36 - 240.36 - 260.36	 <p>N°23 denti H 22 mm. N°23 theets H 22 mm.</p>
Rif. Costruttore OE. Ref.	TURBOTECH 190.36 - 220.36 - 240.36 - 260.36 330.30 - 330.36	
98468830 (ex. 99458098)		
Tipo motore Engine type		
8210.42		



Ns. Riferimento Ns. Ref.	Tipo applicazione Application type	<i>Semipompa per pompa acqua 98468830 Semicomplete water pump for water pump 98468830</i>
907180	TURBOSTAR 190.36 - 220.36 - 240.36 - 260.36	 <p>N°23 denti H 22 mm. N°23 theets H 22 mm.</p>
Rif. Costruttore OE. Ref.	TURBOTECH 190.36 - 220.36 - 240.36 - 260.36 330.30 - 330.36	
42530032 (ex. 93190286)		
Tipo motore Engine type		
8210.42		

Ns. Riferimento Ns. Ref.	Tipo applicazione Application type	<i>Pompa acqua completa Complete water pump</i>
907194	TURBOSTAR 190.36 - 220.36 - 260.36	 <p>N°19 denti H 22 mm. N°19 theets H 22 mm.</p>
Rif. Costruttore OE. Ref.	TURBOTECH 190.36 - 220.36 - 260.36 330.36H	
98468832 (ex. 99458099)		
Tipo motore Engine type		
8210.42 (Economy)		

Ns. Riferimento Ns. Ref.	Tipo applicazione Application type	<p>Semipompa per pompa acqua 98468832</p> <p>Semicomplete water pump for water pump 98468832</p>  <p>N°19 denti H 22 mm. N°19 theets H 22 mm.</p>
907179	TURBOSTAR 190.36 - 220.36 - 260.36	
Rif. Costruttore OE. Ref.	TURBOTECH 190.36 - 220.36 - 260.36 330.36H	
42530033 (ex. 93190287)		
Tipo motore Engine type	8210.42 (Economy)	

Ns. Riferimento Ns. Ref.	Tipo applicazione Application type	<p>Pompa acqua completa Complete water pump</p> 
907158	EUROCARGO 60E10/E12/E14 - 65E10/E12/E14 75E12/E14/E15 - 80E15/E18/E21 100E15/E18/E21 - 120E15/E18 130E15/E18 - 150E15/E18 170E15/E18 - 180E21	
Rif. Costruttore OE. Ref.		
98415831		
Tipo motore Engine type		

Ns. Riferimento Ns. Ref.	Tipo applicazione Application type	<p>Pompa acqua completa Complete water pump</p> 
907166	EUROCARGO 120 - 130 - 135 - 150 - 260 - 280E23 170E23/E27	
Rif. Costruttore OE. Ref.		
4838676		
Tipo motore Engine type		

Ns. Riferimento Ns. Ref.	Tipo applicazione Application type	<p>Pompa acqua completa Complete water pump</p>  <p>N°21 denti H 21 mm. N°21 theets H 21 mm.</p>
907181	EUROCARGO 150E27 - 170E27 - 320E27	
Rif. Costruttore OE. Ref.		
98439476		
Tipo motore Engine type		<p>Semipompa per pompa acqua 98439476 - 98479917 - 99446891 Semicomplete water pump for water pump 98439476 - 98479917 - 99446891</p>  <p>N°21 denti H 21 mm. N°21 theets H 21 mm.</p>
Ns. Riferimento Ns. Ref.	Tipo applicazione Application type	
907183	EUROCARGO 150E27 - 170E27 - 320E27 EUROTECH 180E24/E27 - 190E24/E27 - 325E27 BUS 490E2 - 590E2 - Cityclass	
Rif. Costruttore OE. Ref. 42535615 (ex.42532082)		
Tipo motore Engine type		<p>Pompa acqua con guarnizione Water pump with gasket</p> 
Ns. Riferimento Ns. Ref.	Tipo applicazione Application type	
907299	EUROCARGO TECTOR 65E13 - 75E13 120E28 - 130E28 150E28 - 180E28 320E28	
Rif. Costruttore OE. Ref.		
504062854		
Tipo motore Engine type		

Ns. Riferimento Ns. Ref.
907190
Rif. Costruttore OE. Ref.
61318939
Tipo motore Engine type
9460 SPR dal 1995

Tipo applicazione Application type
EUROTECH 180E30/E34/E38 - 190E30/E34/E38 240E34/E38 - 400E30/E34/E38
EUROTRAKKER 180E25/E42 - 190E30/E34 260E30/E34 - 330E34 - 380E34 400E34
EUROSTAR 180E38/E42 - 190E38 - 240E38 400E38 - 440E38

Pompa acqua completa Complete water pump



**N°23 denti H 20 mm.
N°23 theets H 20 mm.**

Ns. Riferimento Ns. Ref.
907182
Rif. Costruttore OE. Ref.
500350798 (ex.93190284)
Tipo motore Engine type
9460 SPR dal 1995

Tipo applicazione Application type
EUROTECH 180E30/E34/E38 - 190E30/E34/E38 240E34/E38 - 400E30/E34/E38
EUROTRAKKER 180E25/E42 - 190E30/E34 260E30/E34 - 330E34 - 380E34 400E34
EUROSTAR 180E38/E42 - 190E38 240E38 - 400E38 - 440E38
EUROCLASS - EURORIDER .29/.35

Semipompa per pompa acqua 61318939

Semicomplete water pump for water pump 61318939



**N°23 denti H 20 mm.
N°23 theets H 20 mm.**

Ns. Riferimento Ns. Ref.
907191
Rif. Costruttore OE. Ref.
98447661 (ex.93190285 - 98479675)
Tipo motore Engine type

Tipo applicazione Application type
EUROTRAKKER 190E31/E37/E42 260E37/E42/E47 - 330E37 340E37/E42 380E31/E37/E42/E47 400E31/E37/E42 - 410E37/E42 440E37/E42
EUROSTAR 180E42 - 190E42/E47 - 240E42 260E47 - 400E42/E47 440E42/E47
EUROTECH 180E42 - 190E42 - 240E42 260E42 - 400E42 - 440E38/E42

Pompa acqua completa Complete water pump



**N°19 denti H 22 mm.
N°19 theets H 22 mm.**

Ns. Riferimento Ns. Ref.	Tipo applicazione Application type	Semipompa per pompa acqua 98447661 - 99453848 Semicomplete water pump for water pump 98447661 - 99453848
907184	EUROTRAKKER 190E31/E37/E42 - 260E37/E42/E47 330E37 - 340E37/E42 380E31/E37/E42/E47 400E31/E37/E42 - 410E37/E42 440E37/E42 EUROSTAR 180E42 - 190E42/E47 - 240E42 260E47 - 400E42/E47 440E42/E47 EUROTECH 180E42 - 190E42 - 240E42 - 260E42 400E42 - 440E38/E42	
Rif. Costruttore OE. Ref.		
500350785 (ex.99445447 - 98479675)		
Tipo motore Engine type		



N°19 denti H 22 mm.
N°19 theets H 22 mm.

Ns. Riferimento Ns. Ref.	Tipo applicazione Application type	Pompa acqua Water pump
907138	EUROTRAKKER CURSOR 180/190E24-E27-E31/35 260E31/35 - 380E35	
Rif. Costruttore OE. Ref.		
99483937		
Tipo motore Engine type		



Ns. Riferimento Ns. Ref.	Tipo applicazione Application type	Pompa acqua Water pump
907139	EUROTRAKKER EUROTECH CURSOR STRALIS	
Rif. Costruttore OE. Ref.		
500356553		
Tipo motore Engine type		



Ns. Riferimento Ns. Ref.	Tipo applicazione Application type	Pompa acqua completa Complete water pump AGRIFUL 
907149		
Rif. Costruttore OE. Ref.		
93191101 4679242		
Tipo motore Engine type		
8035.01.317 8035.01.308 8035.02.276/.376 8035.01.317 8035.04.376 8035.02.309 8045.02.276/.376 8045.02.378 8045 8045.04.276/.376	Sprint 350 2RM / DT 30 - 40 DT 80.46E - 80.46 E DT C 80.50 - 80.50 2RM 80.56 E - 80.56E DT - C 80.56 80.60 V/F2RM - DT 80.66 E - 80.66 E DT - C 80.66 80.70 2 RM - 80.70 DTF C 80.70 SPECIAL - C 80.76 80.76 E - 80.76 DT	

Ns. Riferimento Ns. Ref.	Tipo applicazione Application type	Pompa acqua completa Complete water pump AGRIFUL 
907167		
Rif. Costruttore OE. Ref.		
98497117 4784454		
Tipo motore Engine type		
8035.06.208/.308 8035.06.222/.322 8035.06.206/.306 8035.05.208/.308 8045.06.220/.320 8045.06.206/.306 8045.06.208/.308 8045.05.206/.306 8045.05.208/.308 8055.05.200 8065.06.200/.300 8065.05.220	55 CF - 55CV - 55.60 55V - 55F - 55DTF 60C - 60CL 60F - 60DT 65 - 65 DT 70 - 70.C - 70.CL 70F - 70 DT 80 - 80DT - 80C 80F - 80F DT 90 - 90 DT 100 - 100 DT 110 DT	

Ns. Riferimento Ns. Ref.	Tipo applicazione Application type	<i>Pompa acqua completa Complete water pump</i>
907149		
Rif. Costruttore OE. Ref.		FIAT ALLIS FIAT HITACHI SIMIT
93191101 4679242		
Tipo motore Engine type		
8035.02.210/310 261/265/361/365 8035.04.265 8045.04.189 8045.04.293 8065.04.295 8065.04.295 8041 I 002 8051 I 000 8065.24.091 8041 I 002 all 004 8041.04.300 8065.24.092 8061 I 000 8061 I 000 8065.04.097 8065.24.098 8041 8041 I 002	4 FL4 C - FL4 D - FL4 L FL4 M > 400456 FD5 - FL5 > 201360 FB7 - FB7 C.M. FD7 - FD7 B > 250904 FL7 > 250909 FR7 > 000440 FR9 > 00348 FR10 > 78Y00101 FE12 > 00124 FE12 LC > 00053 FE12 MLC > 00033 FE12 R > 00133 FR12 FE14 - FE16 FE16 > 00144 FE18 > 00480 FE18 LC > 00095 FE18 M > 00029 FE18 MLC > 00101 FE18 R - FE18 RM > 00177 S60 FG65 A	

NEW HOLLAND

POMPE ACQUA WATER PUMP

Ns. Riferimento Ns. Ref.	Tipo applicazione Application type	Pompa acqua completa Complete water pump FIAT ALLIS FIAT HITACHI SIMIT
907167		
Rif. Costruttore OE. Ref.		
98497117 4784454		
Tipo motore Engine type		
8035.05.265 8045.05.389 8045.05.393 8065.05.295 8041 I 05 8045.05.395 8065.25.095 8051 I 05 8065.05.290 8065.25.0518060.25Si 8041 I 05 N 004 8051 I 05 N 004 8065.05.097 8065.25.096 8045 Si 25 N° 001 8045 Si 25 N° 002 8065 Si 25 N° 006	FL 4M FDS - FL5 - FL5 B FB7 B FD7 - FD7 B - FL7 - FL7 B FR7 FR7 B - FR7 C FD7 FRD FD10 - FL10 E FR10 FR10 B - FR10 C FR11 FE12 - FE12 LC - FE12 MLC FE12 L - FE12 R FE16 FE18 - FE18 LC - FE18 M FE18 MLC FA 120 FH120 - FR130 FH150 - FH150 3B FH200 - FH200 LC - FH200 3B FH200 Hi (> 01/93)	

Ns. Riferimento Ns. Ref.	Tipo applicazione Application type	Semipompa per pompa acqua Semicomplete water pump for water pump
907180		
Rif. Costruttore OE. Ref.		
42530032 93190286		
Tipo motore Engine type		
8215.22.400 8215.42	FH400 FH400	 N°23 denti H 22 mm. N°23 theets H 22 mm.

Ns. Riferimento Ns. Ref.	Tipo applicazione Application type	Pompa acqua completa Complete water pump
907167		
Rif. Costruttore OE. Ref.		FIAT TRATTORI
98497117		
Tipo motore Engine type		
8035.05 - 8035.06 8045.05 - 8045.06 8055.05 - 8055.06 8065.05 - 8065.06 8065.25.000	45.66 - 50.66 - 55.46 - 55.65 - 55.66 55.90 - 60.46 - 60.65 - 60.66 - 60.90 65.46 - 65.66 - 65.90 - 70.65 - 70.66 70.90 - 80.65 - 80.66 - 80.90 - 85.55 90.90 - 95.55 - 100.90 - 115.90 140.90DT Serie 76 - 86 - 93 - 94 (> 01/93 al 12/95)	

Ns. Riferimento Ns. Ref.	Tipo applicazione Application type	Semipompa per pompa acqua Semicomplete water pump for water pump
907184		
Rif. Costruttore OE. Ref.		
500350785 99445447		
Tipo motore Engine type		
8215.42	FX 300 - FX 375 - FX 450	 N°19 denti H 22 mm. N°19 theets H 22 mm.

NEW HOLLAND

POMPE ACQUA WATER PUMP

EMMERRE

Ns. Riferimento Ns. Ref.	Tipo applicazione Application type	Pompa acqua completa Complete water pump
907149		
Rif. Costruttore OE. Ref.		
93191101		<p>FIAT TRATTORI</p>
Tipo motore Engine type		
8025.01 8035.01 8035.02.309 8035.01.305 8035.02.276/376 8035.02.313 8045.01.211 8045.02.271/278.371.378 8065.02 8065.04 8065.24	250N/F/DT - 300N/DT 350/N/S/DT - 355/M/F/C 400/N/DT/DTN - 420/DT 440/D/DT/V 446/DT - 450/F/V/DT/S R450/N/V/DT 455/M/V/CI/C/CM/M/CF 455SUPER - 460/DT - 465C/CV 465CF - 466DT - 470/DT/EF/S 470S DT - 474/DT - 480/DT/V/S 480.8/DT/V - 500/DT/S/DTS 505C/CM/V/S - 540S/VS/DTS 540/F/FS/DT - 550/DT/555/M 565C/CL - 566/DT - 570/DT/V/DTF 600/DT - 605C/CM/CS/CMS 640/DT - 665C/CM - 666/DT 670/DT/F/FDT - 765 - 766/DT 880.5/DT5 - 980/DT - 1000/DT 1000/S/SDT - 1180/DT - 1280/DT 1380/D	

Ns. Riferimento Ns. Ref.	Tipo applicazione Application type	Pompa acqua completa Complete water pump LAVERDA 
907149		
Rif. Costruttore OE. Ref.		
93191101		
Tipo motore Engine type		
8065 I	M 112	
8041 I	3350	
8061 I	3450	
8061 I	3600	

Ns. Riferimento Ns. Ref.	Tipo applicazione Application type	Pompa acqua completa Complete water pump 
907167		
Rif. Costruttore OE. Ref.		
98497117 4784454		
Tipo motore Engine type		
8041 I 05.004	3300 - 3300 R	
8061 I 05.0041	3400 - 3400 R	
8061 I 05.003	3500 - 3500 R	
8061 SI 05.002	3550 - 3550 R	
8061 SI 25.002	3550 AL	
8061 SI 05.002	3650 - 3650 R	
8061 SI 25.002	3750 - 3750 R	

Ns. Riferimento Ns. Ref.	Tipo applicazione Application type	<p>Pompa acqua completa Complete water pump</p> 
907200		
Rif. Costruttore OE. Ref.		
51.06500.6426		
Tipo motore Engine type		
D 2840 L	F 90 19.502 - 19.502 F - 19.502 FLL 19.502 FS - 19.502 FLS 26.502 DF - 26.502 DFA 26.502 DFS - 26.502 DFSL 33.502 DF - 33.502 DFA	
D 2840 LF/LF20	F 2000 19.273 - 19.323 - 19.343 19.463 - 19.603 23.343 - 23.463 - 24.273 - 24.323 24.343 - 24.463 - 26.273 - 26.323 26.343 - 26.463 - 27.273 - 27.323 27.343 - 27.463 - 32.343 - 32.463 33.323 - 33.343 - 33.463 - 35.343 35.463 - 41.343 - 41.463	
	TGA	

Ns. Riferimento Ns. Ref.	Tipo applicazione Application type	<p>Pompa acqua completa Complete water pump</p> 
907141		
Rif. Costruttore OE. Ref.		
51.06500.6546		
Tipo motore Engine type		
	F 2000	

Ns. Riferimento Ns. Ref.	Tipo applicazione Application type	Pompa acqua completa Complete water pump 
907146	F 2000 F 90 M 90	
Rif. Costruttore OE. Ref.		
51.06500.6547 51.06500.9547		
Tipo motore Engine type		

Ns. Riferimento Ns. Ref.	Tipo applicazione Application type	Pompa acqua completa Complete water pump 
907201		
Rif. Costruttore OE. Ref.		
51.06500.6228		
Tipo motore Engine type		
D 2356 HMX D 2566 > fino mot. 491059 D 2566 M > fino mot. 491059 D 2566 MF > fino mot. 491059 D 2538 M/MF > fino mot. 3581000 D 2563 MTF > fino mot. 3644048 D 2566 MT > fino mot. 3644048 D 2566 MTL > fino mot. 3644048 D 2530 MF > fino mot. 3358073 D 2538/ MT > fino mot. 3581000 D 2566 MUH > fino mot. 4091102 D 2566 MTUH > fino mot. 4077098	30.230 H 14.240 - 20.240 - 20.240 D 15.240 - 16.240 - 19.240 - 26.240 32.240 15.240 - 16.240 - 19.240 - 22.240 FNL - 26.240 - 30.240 VF 16.256 - 19.256 - 26.256 - 30.256 32.256 16.280 - 20.280 FVLS - 22.280 FNL 26.280 - 30.280 VF 19.280 - 26.280 - 32.280 19.280 F/FL/FS/FT 16.320 - 19.320 - 20.320 - 26.320 30.320 - 32.320 16.320 - 19.320 - 30.320 - 32.320 SG 192 - SL 200 - SUE 240 SR 240 - SR 280 SR 240 - SR 280 - SR 280 FRH SG 280	

Ns. Riferimento <i>Ns. Ref.</i>	Tipo applicazione <i>Application type</i>	<p>Pompa acqua Water pump</p> 
907108	F 2000 F 90 M 90	
Rif. Costruttore <i>OE. Ref.</i>		
51.06500.6408		
Tipo motore <i>Engine type</i>		

Ns. Riferimento <i>Ns. Ref.</i>	Tipo applicazione <i>Application type</i>	<p>Pompa acqua Water pump</p> 
907090	L 2000 6.103 - 6.113 8.153 - 8.155 STAR 9.153 10.153 M 2000 8.125 STAR 11.153	
Rif. Costruttore <i>OE. Ref.</i>		
51.06500.6515 51.06500.9515		
Tipo motore <i>Engine type</i>		

Ns. Riferimento <i>Ns. Ref.</i>	Tipo applicazione <i>Application type</i>	<p>Pompa acqua Water pump</p> 
907134	L 2000 6.103 - 6.113 - 8.153 - 8.163 - 8.224 9.153 - 10.153 - 10.224 M 2000 11.224 - 12.192 - 12.232 - 13.224 14.232 - 15.224 L 90 6.100 - 8.150 - 9.150 - 10.150 M 90 12.192 - 14.232 - 17.232	
Rif. Costruttore <i>OE. Ref.</i>		
51.06500.6476 51.06500.9476		
Tipo motore <i>Engine type</i>		

Ns. Riferimento Ns. Ref.	Tipo applicazione Application type	Pompa acqua Water pump 
907137	M 2000 F 2000 L 2000 M 90	
Rif. Costruttore OE. Ref.		
51.06500.6495 51.06500.9495		
Tipo motore Engine type		

Ns. Riferimento Ns. Ref.	Tipo applicazione Application type	Pompa acqua Water pump 
907107	V 1700 1900 2300 2700 2900 3000 4100 Z 9500	
Rif. Costruttore OE. Ref.		
51.06500.6537 51.06500.9537		
Tipo motore Engine type		
D 0824 LFL 01/02/04 LOH 01-05 D 0826 LFL 03/6 D 0824 LF 01/02 D 0826 LOH15/17-19		

Ns. Riferimento Ns. Ref.	Tipo applicazione Application type	Pompa acqua Water pump 
907106	V 3900 V 4000 V 4400	
Rif. Costruttore OE. Ref.		
51.06500.6606 51.06500.9606		
Tipo motore Engine type		
D 0636 LFL01-06 D 0836 D 0834		

**Ns. Riferimento
Ns. Ref.**

907124

**Rif. Costruttore
OE. Ref.**

51.06500.6479
51.06500.9479

**Tipo motore
Engine type**

R 5 / 6
128 CON RETARDER

**Tipo applicazione
Application type**

F 90

**Pompa acqua
Water pump**



**Ns. Riferimento
Ns. Ref.**

907127

**Rif. Costruttore
OE. Ref.**

51.06500.6282

**Tipo motore
Engine type**

D 2530 2538
2565 2566
2866 F/FR /TUH/TUM/UH/UM

**Tipo applicazione
Application type**

V 8/10 - R 5/6
125-R6-128

**Pompa acqua
Water pump**



**Ns. Riferimento
Ns. Ref.**

907143

**Rif. Costruttore
OE. Ref.**

51.06500.7066

**Tipo motore
Engine type**

**Tipo applicazione
Application type**

TGA
18.480 - 18.510 - 18.530
24.480 - 24.510 - 24.530
26.510 - 26.530
32.480 - 33.480
33.510 - 33.530

**Pompa acqua
Water pump**



Ns. Riferimento Ns. Ref.	Tipo applicazione Application type	Pompa acqua completa Complete water pump
907255	ATEGO	
Rif. Costruttore OE. Ref.	1823 - 1828 2523 - 2628	
9042004901 9042002601 9042000801		
Tipo motore Engine type		

Ns. Riferimento Ns. Ref.	Tipo applicazione Application type	Pompa acqua completa Complete water pump
907259	ACTROS (1996)	
Rif. Costruttore OE. Ref.	1831 - 1835 - 1840 - 1843 - 1848 1853 - 1857 2031 - 2035 - 2040 - 2053 2531 - 2535 - 2540 - 2543 - 2548 2553 - 2557 2631 - 2635 - 2640 - 2643 - 2648 2653 - 2657 3231 - 3235 - 3240 - 3243 3331 - 3335 - 3340 - 3343 - 3348 3353 - 3357 4140 - 4143 - 4148	
5412001201 5412001101 5412000101		
Tipo motore Engine type		
	ACTROS (2003)	
	1832 - 1836 - 1841 - 1846 - 1850 1856 - 1858 2032 - 2036 - 2041 - 2044 - 2046 2050 2532 - 2536 - 2546 2632 - 2636 - 2646 - 2650 2654 - 2658	

Ns. Riferimento Ns. Ref.
907290
Rif. Costruttore OE. Ref.
5422001901 5422000501 5422001501
Tipo motore Engine type

Tipo applicazione Application type
Actros 1831-1835-1840-1843-1848- 1853-1857 2031-2035-2040-2043-2048- 2053 2531-2535-2540-2543-2553- 2557 2631-2635-2640-2643-2648- 2653-2657 3231-3235-3240-3243 3331-3335-3340-3343-3348- 3353-3357 4140-4143-4148 Actros 2003 1832-1836-1841-1846-1850- 1854 2032-2036-2041-2044-2046- 2050 2532-2536-2546 2632-2636-2646-2650-2654- 2658 3231-3331-3332-3336-3346- 3348-3354 4140

*Pompa acqua completa
di guarnizioni*
Water pump complete of gaskets





Ns. Riferimento Ns. Ref.
907136
Rif. Costruttore OE. Ref.
5422002001 5422000601 5422001601
Tipo motore Engine type
OM 501 LA - OM 502 LA

Tipo applicazione Application type
ACTROS ACTROS 2003

*Pompa acqua
Water pump*





Ns. Riferimento Ns. Ref.	Tipo applicazione Application type	Pompa acqua completa Complete water pump
907202		
Rif. Costruttore OE. Ref.		
403.200.71.01 403.200.51.01 403.200.44.01		
Tipo motore Engine type		
OM 401 - Mot. 129661 >	1019 - 1219 - 1419F/L/LS/S - 1424F 1619L - 1619S - 1719 1819 - 1919 - 2219L/K - 2419	
OM 402 - Mot. 129661 >	1624 - 1626K/L/LP - 1924L 1926K/AK - 2026 - 2224B/K 2226 - 2626AB/AK	
OM 403 - Mot. 129661 >	1626K/L/LP - 1632K/L/LP - 1926 1932 - 2032 (6x2) - 2226 - 2232 2626AB/AK - 2632AK/AS 3032 (8x4)	
OM 421	1222 - 1422 - 1621S - 1622	
OM422	OH1622 - 1922 - 2221	
OM422 A	1425 - 1625 - 1628 - 1928 - 2025 2028 - 2225 - 2228 - 2628 - 3025 3028 - 3228 - 3328	
OM 422 LA	1633 - 1933 - 2033 - 2233	
OM423	2633 - 3333 (8x4)	
OM 422 LA	1638 - 1938 - 2238 - 2638	
OM423	1636 - 1936 - 2036 - 2236 2636 - 3333 (8x4)	
OM441 - > Mot. 504397	1222 - 1422 - 1622 - 1722 - 1922 2222 - 2225 - 2422	
OM 441 LA - > Mot. 504397	2426 - 2429	
OM 442 - > Mot. 504397	1628 - 1733 - 2228 - 2433	
OM 442 A - > Mot. 504397	1426 - 1625 - 1726 - 1729 - 1928 1929 - 2225 - 2422 - 2426 2429 - 2629 - 3529	
OM 442 LA - > Mot. 504397	1635 - 1635L - 1735 - 1935 2035S/SL - 2235 - 2435 - 2635 3235 - 3535	
OM 442 LA - > Mot. 504397	1644 - 1748 - 1944 - 1944S - 1948 2244 - 2448 - 2644 - 2648	
OM 401 - Mot. 129661 >	O 303	
OM 402 - Mot. 129661 >	O 303	
OM 403 - Mot. 129661 >	O303	
OM 421 - 421A	O303	
OM422 - 422A	O303	
OM407 H - Mot. 017498 >	O303 - O305G - O307	
(905/8/9/10/11/13/14/15/18)		
OM 441 - 441A - > Mot. 504397	O303	
OM 442 - 442A		
OM 427 H . 910	O405ST	

Ns. Riferimento Ns. Ref.	Tipo applicazione Application type	<p>Pompa acqua completa Complete water pump</p> 
907203		
Rif. Costruttore OE. Ref.		
353.200.56.01 353.200.95.1 - 352.200.96.01 352.200.97.01 - 353.200.16.014		
Tipo motore Engine type	OM 352.985 OM 362 OM362 LA OM 352 BM352 - BM353 OM352	
	LP810 - LP813 - 911 B 1217S - 1419C/CL/L/LS 1420 - 1420L - 1617 - 1619C - 1620 2219 - 2219CL - 2220 - 2222 O 302 O 309D	

Ns. Riferimento Ns. Ref.	Tipo applicazione Application type	<p>Pompa acqua completa Complete water pump</p> 
907196		
Rif. Costruttore OE. Ref.		
353.200.36.01 353.200.04.01		
Tipo motore Engine type	OM 352 - Mot. 018152 OM 352 - Mot. 034436 > OM 352 - Mot. 034436 >	
	311/312 /328/911L/LA/LP/LAP - 710 911BL/LA 322L/LA - 327L/LA/LP/LAP 1113L/LA - 1313LA - 1317LA 1513LA - 1517LA - 1813LA O 321H - O 321HL - O 322	

Ns. Riferimento Ns. Ref.	Tipo applicazione Application type	<p>Pompa acqua completa Complete water pump</p> 
907204		
Rif. Costruttore OE. Ref.		
353.200.37.01 353.200.21.01 - 352.200.94.01 353.200.03.01 - 353.200.36.01		
Tipo motore Engine type	OM 352 OM 352	
	311-312L/LA/LP/LAP - 322L/LA 323LF/LAF - 327-328L/LA/LP/LAP 710LF/LAF - 911L/LA/LP/LAP 911B L/LA - 1113L/LA - 1313LA 1317 - 1513LA - 1517 - 1813 O 321H - O321HL - O322	

Ns. Riferimento Ns. Ref.	Tipo applicazione Application type	<i>Pompa acqua completa Complete water pump</i>
907197		
Rif. Costruttore OE. Ref.		
364.200.20.01 364.200.09.01		
Tipo motore Engine type		
	OM 364	609 - 609DS - 709D - 809
	OM 364A	711 - 811 - 814D

Ns. Riferimento Ns. Ref.	Tipo applicazione Application type	<i>Pompa acqua completa Complete water pump</i>
907205		
Rif. Costruttore OE. Ref.		
366.200.59.01 366.200.09.01		
Tipo motore Engine type		
	OM 366	814 - 914 - 1114 - 1314 - 1414 - 1614
	OM 366A	817 - 917 - 1117 - 1317 - 1417
	OH1417	1517 - 1617
	OM366LA	1017 - 1120 - 1320 - 1320S - 1324
		1419C/CL/L/LS - 1520 - 1524 - 1617
		1619 - 1620 - 1720NAW
		2219 - 2220 - 2222
	OM 366 O 301 - O402	
	OM 366A	

Ns. Riferimento Ns. Ref.	Tipo applicazione Application type	<i>Pompa acqua completa Complete water pump</i>
907207		
Rif. Costruttore OE. Ref.		
403.200.73.01 403.200.53.01		
Tipo motore Engine type		
OM 401.901/.917 - Mot. 129661 > OM 402.907/.918	O 303 O 303	
OM 421.908 - OM422.908/951		
OM 407 AH.951 - Mot. 017498 > OM 427HA/.950	O 305G O 405	
OM 447H/HA	O 405 - O 405G	
OM 427H - OM447H	O 405ST	
OM 447H	O 407GTD - O 407U	

**Ns. Riferimento
Ns. Ref.**

907206

**Rif. Costruttore
OE. Ref.**

403.200.70.01
403.200.49.01

**Tipo motore
Engine type**

OM 401 -> **Mot. 129660**

OM 402 -> **Mot. 129660**

OM 403 -> **Mot. 129660**

OM421

OM 401 -> **Mot. 129660**

OM 402 -> **Mot. 129660**

OM 403 -> **Mot. 129660**

OM 407H
905/908/909/910/911
913/914/915/916/918
> **Mot. 017497**

**Tipo applicazione
Application type**

1019-1219-1419F/L/LS/S - 1424F
1619L/S - 1719 - 1819 - 1919
2219L/K - 2419
1624-1626K/L/LP - 1924L
1926K/AK - 2026 - 2224B/K - 2226
2626AB/AK
1626-1632K/L/LP - 1926 - 1932
2032 (6x2)-2226-2232-2626AB/AK
2632AK/AS - 3032 (8x4)
2421
O 303
O 303
O 303
O305 - O305G - O307

**Pompa acqua completa
Complete water pump**



**Ns. Riferimento
Ns. Ref.**

907192

**Rif. Costruttore
OE. Ref.**

422.200.11.01

**Tipo motore
Engine type**

-> **Mot. 146024**

**Tipo applicazione
Application type**

Autobus OM 422 (tutti tipi)

**Pompa acqua completa
Complete water pump**





Ns. Riferimento Ns. Ref.	Tipo applicazione Application type	Pompa acqua completa Complete water pump
907208	SERIE MK SERIE NG SERIE SK	
Rif. Costruttore OE. Ref.	O 303 - O 404	
422.200.12.01		
Tipo motore Engine type		
OM 441LA - OM442 LA	Tutte le versioni con pompa iniezione a comando elettronico più ritardatore All version with electronic drive injection pump + retarder	
OM 422 - Mot. 146025 >	Autobus con cambio automatico e ritardatore Buses with automatic gearbox and retarder Tutti i modelli - All models	

Ns. Riferimento Ns. Ref.	Tipo applicazione Application type	Pompa acqua completa Complete water pump
907112	SERIE NG SERIE SK	
Rif. Costruttore OE. Ref.	NEOPLAN	
422.200.1001 422.200.0501		
Tipo motore Engine type		
OM 422 / 442 423 / 443 404 / 444		

Ns. Riferimento Ns. Ref.	Tipo applicazione Application type	<p>Pompa acqua Water pump</p> 
907351	OM	
Rif. Costruttore OE. Ref.	904	
9062006101	906	
Tipo motore Engine type	909	
	910	
	911	
	919	
	920	
	921	
	922	
	923	

Ns. Riferimento Ns. Ref.	Tipo applicazione Application type	<p>Pompa acqua Water pump</p> 
907342	OM	
Rif. Costruttore OE. Ref.	457	
4572000501	458	
Tipo motore Engine type	AXOR	

Ns. Riferimento Ns. Ref.	Tipo applicazione Application type	<p>Pompa acqua Water pump</p> 
907336	OM	
Rif. Costruttore OE. Ref.	441	
4412000201	442	
4032000601		
Tipo motore Engine type		

Ns. Riferimento Ns. Ref.	Tipo applicazione Application type	Pompa acqua Water pump 
907333	OM 401-404	
Rif. Costruttore OE. Ref.	402-407-409-421-424-427 429-441-444-447-449	
4032007601		
Tipo motore Engine type		

Ns. Riferimento Ns. Ref.	Tipo applicazione Application type	Pompa acqua Water pump 
907315	OM 401-402-403	
Rif. Costruttore OE. Ref.	421-422-423-441-442-444-447-449	
4032007101		
Tipo motore Engine type		

Ns. Riferimento Ns. Ref.	Tipo applicazione Application type	
Rif. Costruttore OE. Ref.		
Tipo motore Engine type		

Ns. Riferimento <i>Ns. Ref.</i>	Tipo applicazione <i>Application type</i>	<p>Pompa acqua Water pump</p> 
907145	ECO L35.085 ECO T100	
Rif. Costruttore <i>OE. Ref.</i>	ATLEON 110/120 TRADE 30/100	
2101069T02		
Tipo motore <i>Engine type</i>	BD 30	

Ns. Riferimento <i>Ns. Ref.</i>	Tipo applicazione <i>Application type</i>
Rif. Costruttore <i>OE. Ref.</i>	
Tipo motore <i>Engine type</i>	

Ns. Riferimento <i>Ns. Ref.</i>	Tipo applicazione <i>Application type</i>
Rif. Costruttore <i>OE. Ref.</i>	
Tipo motore <i>Engine type</i>	

Ns. Riferimento Ns. Ref.	Tipo applicazione Application type	Pompa acqua completa Complete water pump 
907365	TRAFIC 2.5 D 4X4 - 2.5 D MASTER	
Rif. Costruttore OE. Ref.		
7701468342 5001001274 7701462808		
Tipo motore Engine type		

Ns. Riferimento Ns. Ref.	Tipo applicazione Application type	
Rif. Costruttore OE. Ref.		
Tipo motore Engine type		

Ns. Riferimento Ns. Ref.	Tipo applicazione Application type	
Rif. Costruttore OE. Ref.		
Tipo motore Engine type		

Ns. Riferimento <i>Ns. Ref.</i>	Tipo applicazione <i>Application type</i>	<p>Semipompa acqua Water semi-pump</p> 
907358	PREMIUM 420	
Rif. Costruttore <i>OE. Ref.</i>		
5001857427		
Tipo motore <i>Engine type</i>		

Ns. Riferimento <i>Ns. Ref.</i>	Tipo applicazione <i>Application type</i>	<p>Semipompa acqua Water semi-pump</p> 
907362	MAGNUM AE 380 AE 420 R385 MAJOR 385 TI 420 TI R 1995	
Rif. Costruttore <i>OE. Ref.</i>		
5010248921		
Tipo motore <i>Engine type</i>	MIDR 06.35.40 + /A	

Ns. Riferimento <i>Ns. Ref.</i>	Tipo applicazione <i>Application type</i>	<p>Semipompa acqua Water semi-pump</p> 
907361	MAGNUM AE 385 - 420 - 430 - 470 520 - 560	
Rif. Costruttore <i>OE. Ref.</i>		
5010323187 0000773450		
Tipo motore <i>Engine type</i>	MD 06.35.40 MDS /MDR 06.35.40	

Ns. Riferimento Ns. Ref.	Tipo applicazione Application type	Pompa acqua completa Complete water pump 
907209		
Rif. Costruttore OE. Ref.		
1314406 1414336 575100		
Tipo motore Engine type		
	SERIE 112 (Tutti i modelli - All models) (01/81 - 12/86) SERIE 113 (Tutti i modelli - All models) (01/90 - 12/96)	



Ns. Riferimento Ns. Ref.	Tipo applicazione Application type	Pompa acqua completa Complete water pump 
907210		
Rif. Costruttore OE. Ref.		
320592 292762 571063		
Tipo motore Engine type		
	SERIE 142 (Tutti i modelli - All models)	N°33 denti H 23 mm. N°33 theets H 23 mm.

Ns. Riferimento Ns. Ref.	Tipo applicazione Application type	Pompa acqua Water pump 
907144		
Rif. Costruttore OE. Ref.		
1549482 570954		
Tipo motore Engine type		
	SERIE 164	

Ns. Riferimento Ns. Ref.	Tipo applicazione Application type	<p>Pompa acqua completa Complete water pump</p>  <p>N°33 denti H 23 mm. N°33 theets H 23 mm.</p>
907211		
Rif. Costruttore OE. Ref.		
382183		
Tipo motore Engine type	Tutte le versioni con ritardatore All version with retarder	
DSC 14 03 DSC 14 06	SERIE 143 (Tutti i modelli - All models)	

Ns. Riferimento Ns. Ref.	Tipo applicazione Application type	<p>Pompa acqua completa Complete water pump</p>  <p>N°33 denti H 23 mm. N°33 theets H 23 mm.</p>
907198		
Rif. Costruttore OE. Ref.		
1375839		
Tipo motore Engine type	Tutte le versioni con ritardatore All version with retarder	
DSC 14 03 DSC 14 06	SERIE 143 (Tutti i modelli - All models)	

Ns. Riferimento Ns. Ref.	Tipo applicazione Application type	<p>Pompa acqua Water pump</p> 
907352		
Rif. Costruttore OE. Ref.		
259.065		
Tipo motore Engine type	111 DS11 DN9 DS9 DSC9L DS9B	

Ns. Riferimento <i>Ns. Ref.</i>	Tipo applicazione <i>Application type</i>	Pompa acqua completa Complete water pump
907156		
Rif. Costruttore OE. Ref.		
1353072 - 1508533		
Tipo motore Engine type		
	SCANIA 124 T.T. (motore 6 cilindri) (engine 6 cylinder)	
Ns. Riferimento Ns. Ref.	Tipo applicazione Application type	Pompa acqua completa Complete water pump
907159		
Rif. Costruttore OE. Ref.		
1365841 - 1508534		
Tipo motore Engine type		
	SCANIA 144 T.T. (motore 8 cilindri) (engine 8 cylinder)	
Ns. Riferimento Ns. Ref.	Tipo applicazione Application type	
Rif. Costruttore OE. Ref.		
Tipo motore Engine type		

Ns. Riferimento Ns. Ref.	Tipo applicazione Application type	<i>Pompa acqua completa</i> <i>Complete water pump</i>
907199		
Rif. Costruttore OE. Ref.		
1545.261 1675945		
Tipo motore Engine type		N° 19 denti N° 19 theets
TD101F	F10 (dal telaio 25001 >)	
TD 102F	FL10 Intercooler 320	
TD 101F	FL10	
TD 102F	FS10	
TD 120C/D/E/F/FC/G/GA	F12 (> fino a telaio 34000)	
TD 121F/FD/G/GD	F12 (da telaio 340001 >)	
TD 122FK/FS	F12 Intercooler 360 (da telaio 314000 >) F12 intercooler 420	
TD 120A/E/G/GA	N12 (fino a telaio 12001 >)	
TD 121F/G/GA	N12 (da telaio 12001 >)	
TD 121GA	NL10S	
TD 122FK/FS	NL12 - NL12S	

Ns. Riferimento Ns. Ref.	Tipo applicazione Application type	<i>Pompa acqua</i> <i>Water pump</i>
907120		
Rif. Costruttore OE. Ref.		
3183908 276835		
Tipo motore Engine type		
	FL 6 FL 7 FM 7 FS 7	

Ns. Riferimento Ns. Ref.	Tipo applicazione Application type	Pompa acqua completa Complete water pump  N° 23 denti N° 23 theets
907263	FH12 FL12	
Rif. Costruttore OE. Ref.		
1547155 8148460 8149941		
Tipo motore Engine type		

Ns. Riferimento Ns. Ref.	Tipo applicazione Application type	Pompa acqua Water pump 
907109	FH 12 FM 12	
Rif. Costruttore OE. Ref.		
8170305 20431135		
Tipo motore Engine type		

Ns. Riferimento Ns. Ref.	Tipo applicazione Application type	
Rif. Costruttore OE. Ref.		
Tipo motore Engine type		

EMMERRE

VENTILATORI ARIA AIR BLOWERS



Illustrazione Illustration	Ns.Rif. Our Ref.	Rif.Costr. O.E. Ref.	Descrizione Description	Tipo di veicolo Vehicle Type
 <p>Ø 68 mm</p> <p>Ø 620 mm</p>	907260	505347	Ventilatore aria nylon (9 pale) Nylon blower (9 blade) AD ESAURIMENTO UNTILL OUT OF STOCK	Motore - Engine 2800
 <p>Ø 125 mm</p> <p>Ø 620 mm</p>	907261	655158	Ventilatore aria nylon (9 pale) Nylon blower (9 blade) AD ESAURIMENTO UNTILL OUT OF STOCK	Motore - Engine ATI
 <p>Ø 127 mm</p> <p>Ø 704 mm</p>	907232	1448197	Ventilatore aria (8 pale) Air blower (8 blade)	CF 65 CF 75 CF 85
 <p>Ø 180 mm</p> <p>Ø 720 mm</p>	907240	1338736	Ventilatore aria (8 pale) Air blower (8 blade)	XF 95
 <p>Ø 127 mm</p> <p>Ø 720 mm</p>	907249	1315854	Ventilatore aria (8 pale) Air blower (8 blade)	CF 85 CF 95 XF 95 XF 105

Illustrazione <i>Illustration</i>	Ns.Rif. Our Ref.	Rif.Costr. O.E. Ref.	Descrizione Description	Tipo di veicolo Vehicle Type
	907262	715F8600	Ventilatore aria nylon (7 pale) (elettroventola) Nylon blower (7 blade) AD ESAURIMENTO UNTILL OUT OF STOCK	TRANSIT Motore - Engine 2400 Diesel
	907264	84VB8600	Ventilatore aria nylon (7 pale) (elettroventola) Nylon blower (7blade) AD ESAURIMENTO UNTILL OUT OF STOCK	TRANSIT Motore - Engine 2500 Diesel

Illustrazione <i>Illustration</i>	Ns.Rif. <i>Our Ref.</i>	Rif.Costr. <i>O.E. Ref.</i>	Descrizione <i>Description</i>	Tipo di veicolo <i>Vehicle Type</i>
 <p>Ø 28 mm</p> <p>Ø 375 mm</p>	907213	4713940	Ventilatore aria nylon (6 pale) Nylon blower (6 blade)	DAILY RESTYLING 30.8 - 35.8 - 40.8
 <p>Ø 29 mm</p> <p>Ø 370 mm</p>	907214	8586706	Ventilatore aria nylon (7 pale) Nylon blower (7 blade)	DAILY RESTYLING 30-35-40.8 - 35-45-49.10 NEW DAILY 30-35-40.8 - 35-45-49.10
 <p>Ø 64 mm</p> <p>Ø 360 mm</p>	907220	93813264	Ventilatore aria nylon (7 pale) (elettroventola) Nylon blower (7 blade)	NEW DAILY 30-35-40.8 - 35-45-49.10 TURBODAILY 30-35.10 - 35-49-59.12
 <p>Ø 85,7 mm</p> <p>Ø 380 mm</p>	907228	93811590	Ventilatore aria nylon (7 pale) (elettroventola) Nylon blower (7blade)	NEW DAILY 30-35.8 - 35.10 TURBODAILY 30-35-49.10 - 35-49-59.12

Illustrazione <i>Illustration</i>	Ns.Rif. <i>Our Ref.</i>	Rif.Costr. <i>O.E. Ref.</i>	Descrizione <i>Description</i>	Tipo di veicolo <i>Vehicle Type</i>
	907235	504024647 500333136	Ventilatore aria nylon (12 pale) Nylon blower (12 blade)	DAILY CITY 2000 35C9/C11/C13/C15 35S9/S10/S11/S12/S13/S15 50C11 65C11
	907225	504154349	Ventilatore aria nylon (9 pale) Nylon blower (9 blade)	DAILY 2006 M.Y. 35C14/C16/C18

Illustrazione <i>Illustration</i>	Ns.Rif. <i>Our Ref.</i>	Rif.Costr. <i>O.E. Ref.</i>	Descrizione <i>Description</i>	Tipo di veicolo <i>Vehicle Type</i>
	907215	4595546	Ventilatore aria nylon (6 pale) Nylon blower (6 blade)	613N3/N4-625N3 OM40/35
	907222	8831375	Ventilatore aria nylon (7 pale) Nylon blower (6 blade)	50-55.8
	907216	8033778 4616572	Ventilatore aria nylon (9 pale) Nylon blower (9 blade)	50NC-50F8-662-100 110NC
	907223	4842341	Ventilatore aria nylon (7 pale) Nylon blower (7 blade)	TURBOZETA 65.12 - 79.12
	907227	4800473	Ventilatore aria nylon (7 pale) Nylon blower (7 blade)	ZETA 50.9 - 65.9 TURBOZETA 60.11 - 65.12 - 79.12 EUROCARGO 60E10 - 65E10

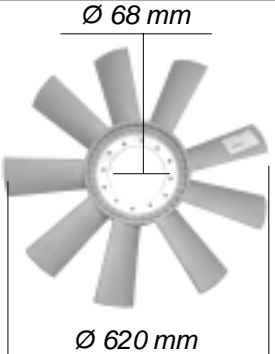
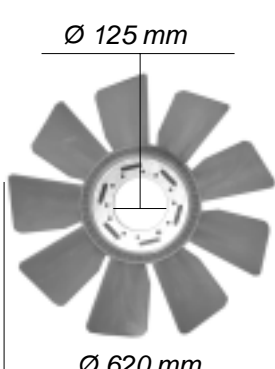
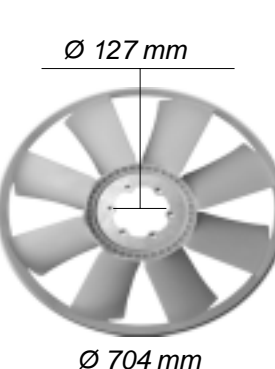
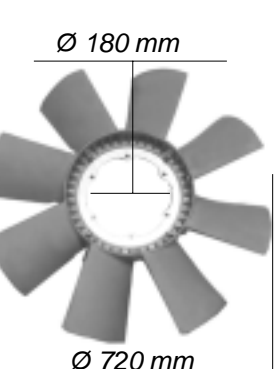
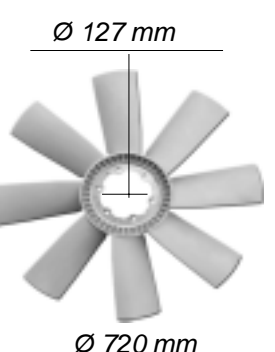
Illustrazione <i>Illustration</i>	Ns.Rif. <i>Our Ref.</i>	Rif.Costr. <i>O.E. Ref.</i>	Descrizione <i>Description</i>	Tipo di veicolo <i>Vehicle Type</i>
<p>Ø 82 mm</p> <p>Ø 470 mm</p>	907226	4800475	Ventilatore aria nylon (8 pale) Nylon blower (7 blade)	ZETA 79.14 - 109.14 EUROCARGO 60E10/E12 - 65E10/E12 75E12
<p>Ø 69 mm</p> <p>Ø 490 mm</p>	907218	4698188	Ventilatore aria nylon (7 pale) Nylon blower (7 blade)	130 NC-NR
<p>Ø 82 mm</p> <p>Ø 480 mm</p>	907224	4782877	Ventilatore aria nylon (8 pale) Nylon blower (7 blade)	135.14/17 - 145.17 - 175.17 EUROCARGO 60E14 - 65E14 - 75E14/E15 80E15 - 95E15 - 100E15 120E15 - 130E15 - 150E15 170E15
<p>Ø 82 mm</p> <p>Ø 520 mm</p>	907230	98468151	Ventilatore aria nylon (7 pale) Nylon blower (7 blade)	EUROCARGO 80E15/E18/E21 - 85E18 95E18 - 100E15/E18 120E15/E18 - 130E15/E18 150E18 - 170E18
<p>Ø 82 mm</p> <p>Ø 560 mm</p>	907231	500353523	Ventilatore aria nylon (7 pale) Nylon blower (7 blade)	EUROCARGO 75-100-120-130-150 EUROTECH 190-240

Illustrazione <i>Illustration</i>	Ns.Rif. <i>Our Ref.</i>	Rif.Costr. <i>O.E. Ref.</i>	Descrizione <i>Description</i>	Tipo di veicolo <i>Vehicle Type</i>
 <p>Ø 180 mm</p> <p>Ø 710 mm</p>	907256	99450016	Ventilatore aria nylon (8 pale) Nylon blower (8 blade)	EUROCARGO 75E12 EUROTECH 180-190-400 EUROTRAKKER 190-260-330-340 400-410-720
 <p>Ø 74 mm</p> <p>Ø 415 mm</p>	907229	500300559 4761185	Ventilatore aria nylon (10 pale) Nylon blower (10 blade)	135.17 - 145.17
 <p>Ø 82 mm</p> <p>Ø 560 mm</p>	907212	4629725	Ventilatore aria nylon (10 pale) Nylon blower (10 blade)	619N1 - 697 - 300 - 180 - 691

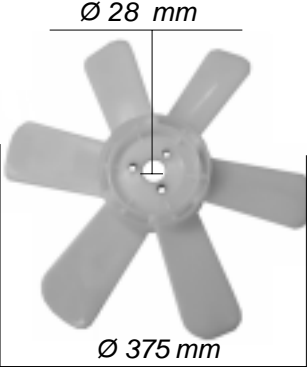
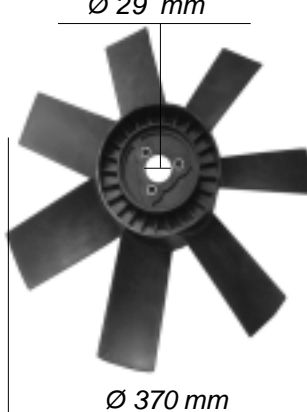
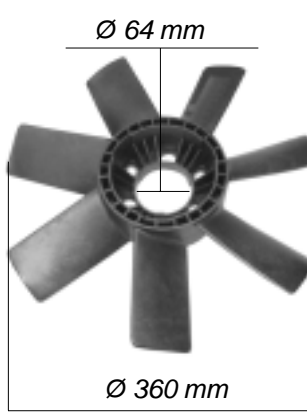
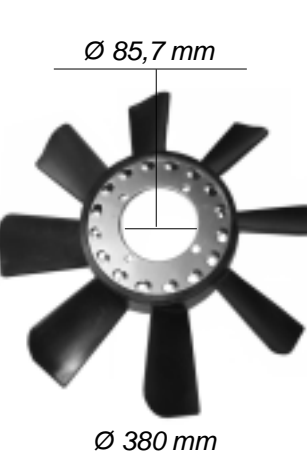
Illustrazione <i>Illustration</i>	Ns.Rif. Our Ref.	Rif.Costr. O.E. Ref.	Descrizione Description	Tipo di veicolo Vehicle Type
 <p>Ø 125 mm</p> <p>Ø 750 mm</p>	907265	51066010172	Ventilatore aria nylon (8 pale) Nylon blower (8 blade) AD ESAURIMENTO UNTILL OUT OF STOCK	MAN
 <p>Ø 125 mm</p> <p>Ø 560 mm</p>	907266	51066010200	Ventilatore aria nylon (9 pale) Nylon blower (9 blade) AD ESAURIMENTO UNTILL OUT OF STOCK	MAN
 <p>Ø 125 mm</p> <p>Ø 600 mm</p>	907267	51066010107	Ventilatore aria nylon (9 pale) Nylon blower (9 blade) AD ESAURIMENTO UNTILL OUT OF STOCK	MAN
 <p>Ø 125 mm</p> <p>Ø 620 mm</p>	907268	51066010102	Ventilatore aria nylon (9 pale) Nylon blower (9 blade) AD ESAURIMENTO UNTILL OUT OF STOCK	MAN

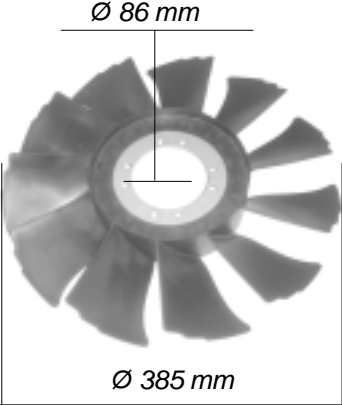
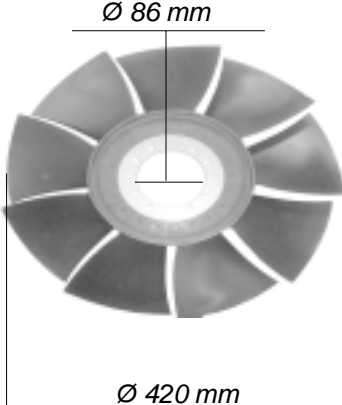
Illustrazione <i>Illustration</i>	Ns.Rif. <i>Our Ref.</i>	Rif.Costr. <i>O.E. Ref.</i>	Descrizione <i>Description</i>	Tipo di veicolo <i>Vehicle Type</i>
 <p>Ø 127 mm</p> <p>Ø 704 mm</p>	907269	51006010256	Ventilatore aria nylon (9 pale) Nylon blower (9 blade)	TG-A
 <p>Ø 178 mm</p> <p>Ø 750 mm</p>	907353	51066010275	Ventilatore aria nylon (9 pale) Nylon blower (9 blade)	TG-A

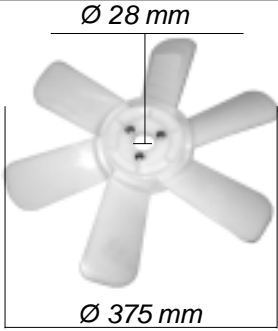
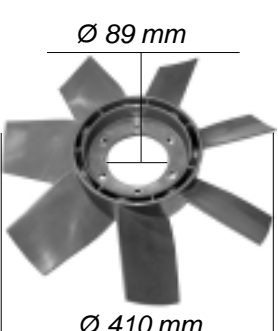
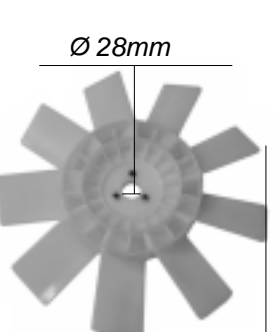
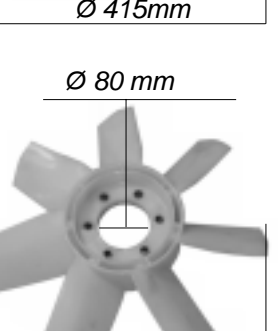
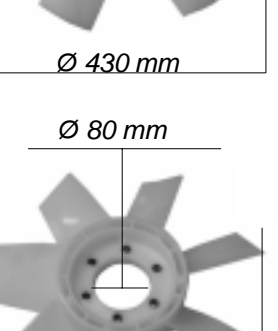
Illustrazione <i>Illustration</i>	Ns.Rif. <i>Our Ref.</i>	Rif.Costr. <i>O.E. Ref.</i>	Descrizione <i>Description</i>	Tipo di veicolo <i>Vehicle Type</i>
<p>Ø 156 mm</p>  <p>Ø 460 mm</p>	907270	0032050306	Ventilatore aria nylon (9 pale) Nylon blower (9 blade) AD ESAURIMENTO UNTILL OUT OF STOCK	SPRINTER 210D - 212D 310D - 312D 412D
<p>Ø 160 mm</p>  <p>Ø 460 mm</p>	907271	0032051306	Ventilatore aria nylon (9 pale) Nylon blower (9 blade)	SPRINTER 210D - 212D 310D - 312D 410D - 412D
<p>Ø 135 mm</p>  <p>Ø 428 mm</p>	907274	1032000423	Ventilatore aria nylon (9 pale) Nylon blower (9 blade) AD ESAURIMENTO UNTILL OUT OF STOCK	SPRINTER CDI 124 - 126 201 - 202
<p>Ø 180 mm</p>  <p>Ø 725 mm</p>	907272	0032050006	Ventilatore aria nylon (8 pale) Nylon blower (8 blade)	ACTROS
<p>Ø 180 mm</p>  <p>Ø 750 mm</p>	907273	0032050106	Ventilatore aria nylon (8 pale) Nylon blower (8 blade)	ACTROS

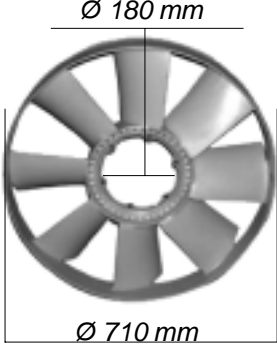
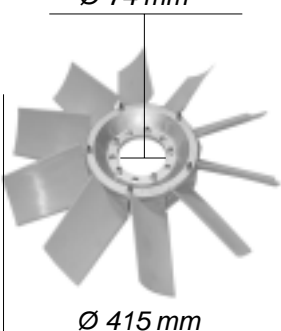
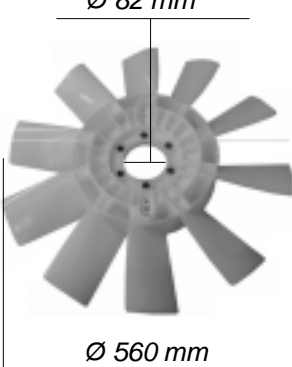

Illustrazione Illustration	Ns.Rif. Our Ref.	Rif.Costr. O.E. Ref.	Descrizione Description	Tipo di veicolo Vehicle Type
 <p>Ø 180 mm</p> <p>Ø 750 mm</p>	907278	0032054206	Ventilatore aria nylon (8 pale) Nylon blower (8 blade)	ACTROS
 <p>Ø 82 mm</p> <p>Ø 595 mm</p>	907275	9042050406	Ventilatore aria nylon (8 pale) Nylon blower (8 blade)	ATEGO 712-714-717 812-815-817 917-1017 1215-1217 1317-1517
 <p>Ø 127 mm</p> <p>Ø 750 mm</p>	907276	0032053606	Ventilatore aria nylon (8 pale) Nylon blower (8 blade)	ATEGO - AXOR Motori - Engines 457LA-OM501OA-M502LA
 <p>Ø 180 mm</p> <p>Ø 750 mm</p>	907277	87480660	Kit ventilatore aria nylon (8 pale) con anello mozzo Nylon blower set (8 blade) with Motori - Enignes oil wheel hub	AXOR 1835 - 1840

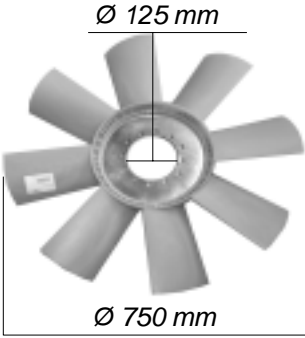
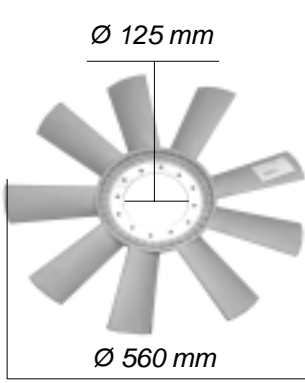
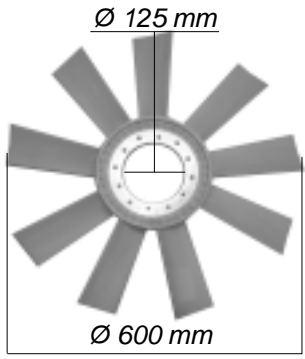
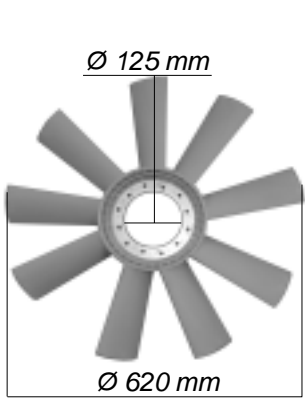
Illustrazione <i>Illustration</i>	Ns.Rif. <i>Our Ref.</i>	Rif.Costr. <i>O.E. Ref.</i>	Descrizione <i>Description</i>	Tipo di veicolo <i>Vehicle Type</i>
	907354	1412398	Ventilatore aria nylon (8 pale) Nylon blower (8 blade)	114 124
	907355	1393424	Ventilatore aria nylon (8 pale) Nylon blower (8 blade)	124 SERIE 4
	907356	1422502	Ventilatore aria nylon (8 pale) Nylon blower (8 blade)	164

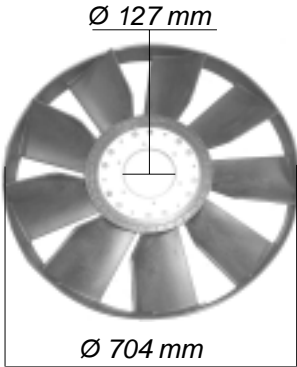
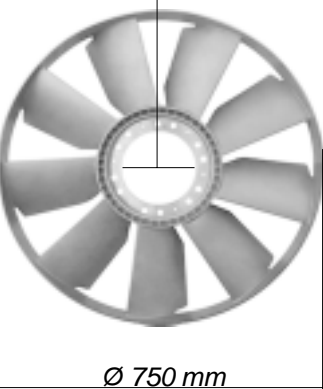
Illustrazione <i>Illustration</i>	Ns.Rif. <i>Our Ref.</i>	Rif.Costr. <i>O.E. Ref.</i>	Descrizione <i>Description</i>	Tipo di veicolo <i>Vehicle Type</i>
 <p>Ø 180 mm</p> <p>Ø 750 mm</p>	907357	1674865	Ventilatore aria nylon (8 pale) Nylon blower (8 blade)	FH12 NH12

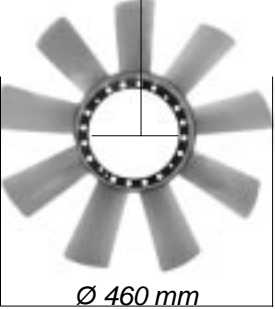
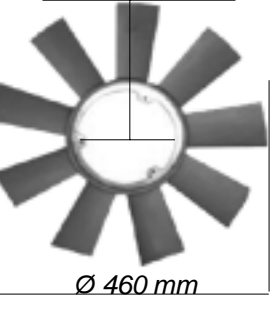
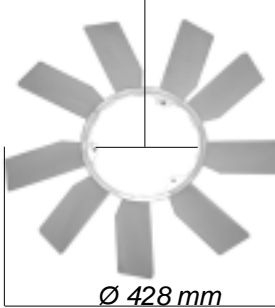
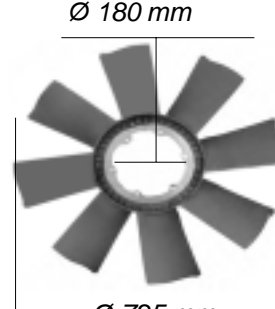
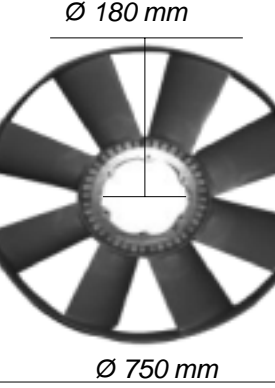
EMMERRE

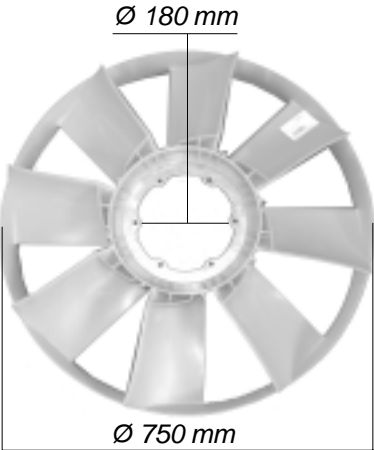
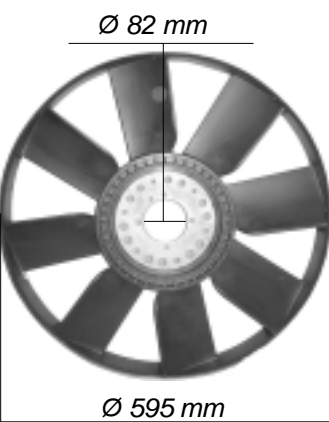
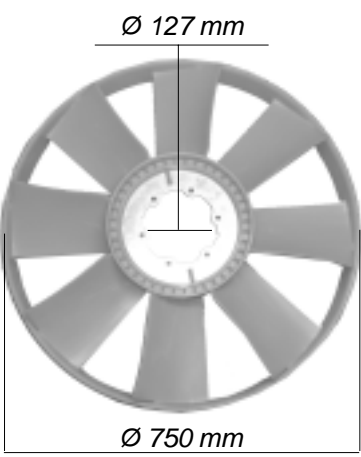
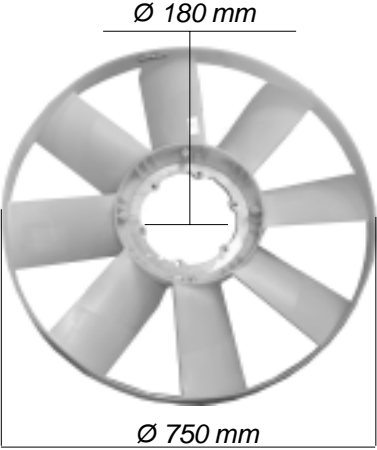
VARIE IMPIANTO DI RAFFREDDAMENTO **VARIOUS COOLING SYSTEM**

Hydro Pump



RADIATORI ACQUA

WATER RADIATOR

TERMOSTATI

THERMOSTATS

TUBI ACQUA

WATER PIPES







Illustrazione <i>Illustration</i>	Ns.Rif. <i>Our Ref.</i>	Rif.Costr. <i>O.E. Ref.</i>	Descrizione <i>Description</i>	Tipo di veicolo <i>Vehicle Type</i>
	906926	1907918	Radiatore acqua (ex 93809326 - 93814567) Water radiator	NEW DAILY 30-35-40.8 - 35-45-49.10
	906929	93818439	Radiatore acqua Water radiator	NEW DAILY 96 35.8 - 35.10 TURBO DAILY 96 35.10/12 - 49.10/12 - 59.12
	906930	93817393	Intercooler Intercooler	DAILY 35.10 - 49.10 TURBO DAILY 35.12 - 49.12 - 59.12
	906931	93809190	Convogliatore aria Air Hood	NEW DAILY 30.8 - 35.8 - 40.8 35.10 - 45.10 - 49.10

Illustrazione <i>Illustration</i>	Ns.Rif. <i>Our Ref.</i>	Rif.Costr. <i>O.E. Ref.</i>	Descrizione <i>Description</i>	Tipo di veicolo <i>Vehicle Type</i>
	906927	93813747	Radiatore acqua Water radiator	NEW DAILY 35.10-49.10 TURBODAILY 35.12 - 49.12 - 59.12
	906928	500396428	Radiatore acqua Water radiator	DAILY CITY 2000 35S9/S11/S13/S15 35C9/C11/C15/C18 50C11/C13/C15
	906932	500396429	Radiatore acqua Water radiator	DAILY CITY 2000 35S9/S11/S13/S15 35C9/C11/C15/C18 50C11/C13/C15 65C13/C15
	906925	504045487	Radiatore acqua Water radiator	DAILY CITY 2000 35S9 / S11 35C11 MOTORI / ENGINES: 29L10V - 35S10V - 2.3 TD

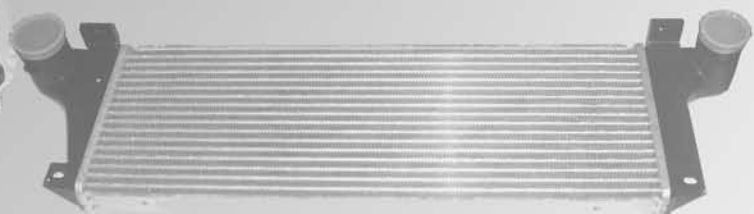
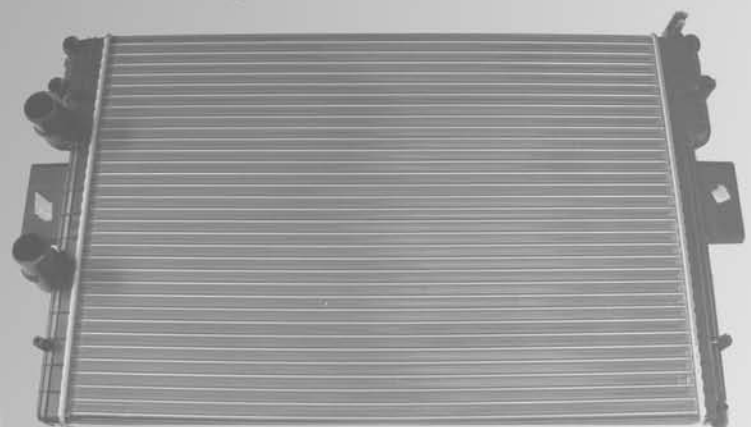
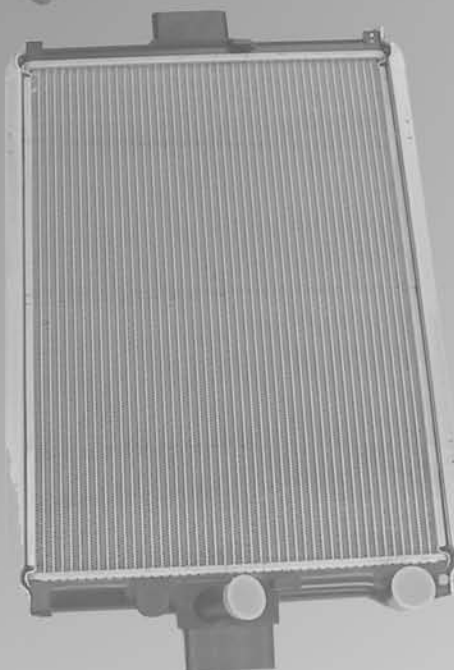

Illustrazione <i>Illustration</i>	Ns.Rif. <i>Our Ref.</i>	Rif.Costr. <i>O.E. Ref.</i>	Descrizione <i>Description</i>	Tipo di veicolo <i>Vehicle Type</i>
	906934	504008108	Radiatore acqua Water radiator	DAILY CITY 2000 29L11 - L9 35S11/C11 35S9-C9 50C11
	906907	99487905	Radiatore Radiator	DAILY CITY 2000 29L11 - L9 35S11/C11 35S9-C9 50C11 MOTORI / ENGINES: 29L11 - 35C11/35S11 50C 2.8TD
	906933	504084141	Radiatore acqua Water radiator	DAILY 2006 M.Y. 35C14/C16/C18
	906924	504152996	Radiatore acqua Water radiator	DAILY 2006 M.Y. MOTORI - ENGINES: 3.0C14 F1A EURO4



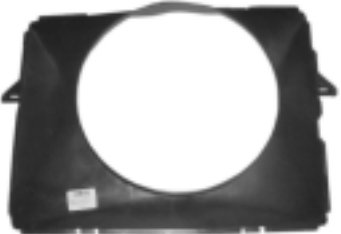

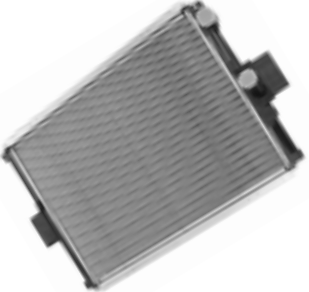
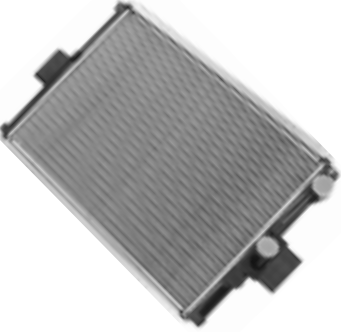
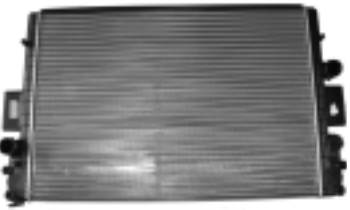
Illustrazione <i>Illustration</i>	Ns.Rif. <i>Our Ref.</i>	Rif.Costr. <i>O.E. Ref.</i>	Descrizione <i>Description</i>	Tipo di veicolo <i>Vehicle Type</i>
	906920	42530250	Rubinetto riscaldamento Heating tap	NEW DAILY 30.8 - 40.10 DAILY CITY 2000
	906908	93930693	Riscaldatore ventilatore completo	DAILY T.T. fino a 1996
	906878	93930676	Radiatore riscaldamento	DAILY T.T. fino a 1996
	906909	93930687	Ventilatore riscaldamento	DAILY T.T. fino a 1996

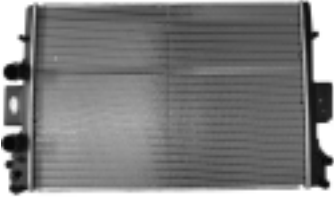

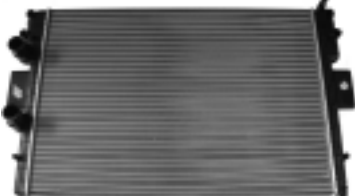
Illustrazione <i>Illustration</i>	Ns.Rif. <i>Our Ref.</i>	Rif.Costr. <i>O.E. Ref.</i>	Descrizione <i>Description</i>	Tipo di veicolo <i>Vehicle Type</i>
	906190	93902290	Serbatoio recupero acqua OE Water tank OE	DAILY 35.8 - 35.10
	906191	42107120	Serbatoio recupero acqua OE Water tank OE	TURBOSTAR 190.42/48 - 240.36/48 260.36/48 TURBOTECH 190.32/36 - 220.36 - 240.36 330.30-330.35-330.36
	906192	41215631	Serbatoio recupero acqua OE Water tank OE	STRALIS







Illustrazione <i>Illustration</i>	Ns.Rif. <i>Our Ref.</i>	Rif.Costr. <i>O.E. Ref.</i>	Descrizione <i>Description</i>	Tipo di veicolo <i>Vehicle Type</i>
	907101	9073710	Vaschetta acqua radiatore completa di tappi Radiator water tank complete of plugs	GAMMAZETA 65.10 - 79.14 - 95.14
	907099	-	(1) Tappo vaschetta acqua Lock plug	TURBODAILY 35.10 - 35.12 (>1994)
	907130	-	(2) Tappo vaschetta acqua Lock plug	DAILY 30.8 - 35.8 TURBODAILY 35.10 - 40.10 35.12 - 49.12 - 59.12
	907254	7301254	Coperchio termostato Thermostat cover	DAILY RESTYLING 30-35-40.8 - 35-45-49.10 NEW DAILY 30-35-40.8 TURBODAILY 30-35-49.10 - 35-49-59.12
	907251	4605519	Coperchio termostato Thermostat cover	OM40/35-616N3-N4
	907252	4626878	Coperchio termostato Thermostat cover	50-110NC-645-650
	907248	4697838	Tubo acqua Water pipe	OM CO3 I

Illustrazione Illustration	Ns.Rif. Our Ref.	Rif.Costr. O.E. Ref.	Descrizione Description	Tipo di veicolo Vehicle Type
	907253	4772996	Coperchio termostato Thermostat cover	115-135.14/17
	907257	4804320	Coperchio termostato Thermostat cover	115-135.14/17 - 175.17 EUROCARGO 60-65E10/E12/E14 75E12/E14/E15 80E15/E18E/21 - 180E21 95-100E15/E18/E21 120-130-150-170E15/E18
	907250	4627601	Coperchio termostato Thermostat cover	170-619-697-300
	907100	4809019	Termostato apertura 74° C Thermostat 74° C	DAILY 28-30-35-40.8 (1°serie)
	907104	98463638 4703088 4809509	Termostato apertura 79° C Thermostat 79° C	DAILY 30.8-35.8 NEW DAILY 35.10-49.10 TURBODAILY 35.10-45.10 ZETA 50.8-50.9-60.8 EUROCARGO 135E18 - 170E18 - 180E18 RENAULT MASTER - TRAFIC
	907126	98463637 4837166	Termostato apertura 79° C Thermostat 79° C	NEW DAILY 30-35-40.8 - 35-45-49.10 TURBODAILY 30.10-35.12-49.12-59.12 NEW DAILY 96 30-35.8 - 30-40-45-49.10 35-49-59.12 DAILY CITY 2000 35S9 - 35C9 FIAT DUCATO RENAULT MASTER - TRAFIC







Illustrazione <i>Illustration</i>	Ns.Rif. <i>Our Ref.</i>	Rif.Costr. <i>O.E. Ref.</i>	Descrizione <i>Description</i>	Tipo di veicolo <i>Vehicle Type</i>
	907111	-	Termostato apertura 77° C <i>Thermostat 77° C</i> AD ESAURIMENTO UNTILL OUT OF STOCK	DAF V.I.
	907119	-	Termostato apertura 77° C <i>Thermostat 77° C</i> AD ESAURIMENTO UNTILL OUT OF STOCK	RENAULT V.I.
	907122	-	Termostato apertura 77° C <i>Thermostat 77° C</i> AD ESAURIMENTO UNTILL OUT OF STOCK	MAN
	907114	-	Termostato apertura 79° C <i>Thermostat 79° C</i> AD ESAURIMENTO UNTILL OUT OF STOCK	VOLKSWAGEN
	907115	-	Termostato apertura 82° C <i>Thermostat 82° C</i> AD ESAURIMENTO UNTILL OUT OF STOCK	VOLKSWAGEN
	907113	-	Termostato apertura 82° C <i>Thermostat 82° C</i> AD ESAURIMENTO UNTILL OUT OF STOCK	FORD





Illustrazione <i>Illustration</i>	Ns.Rif. <i>Our Ref.</i>	Rif.Costr. <i>O.E. Ref.</i>	Descrizione <i>Description</i>	Tipo di veicolo <i>Vehicle Type</i>
	907246	500345688 4828059	Corpo portatermostato Thermostat cover	NEW DAILY DAILY RESTYLING TURBODAILY DAILY CITY 2000 35S11 - 35C11 - 50C11
	907247	500345691 500302581	Corpo portatermostato Thermostat cover	NEW DAILY TURBODAILY
	907030	-	Kit tubetto al termostato per pompa acqua 98415831 composto da: Thermostat threaded union for water pump 98415831 composed by: 98415712 Tubetto Pz. 1 17282381 O-Ring Pz. 1 17288681 O-Ring Pz. 1	EUROCARGO 60-65-75-80-100-120 130-150-170
	907031	-	Kit tubetto al termostato composto da: Thermostat threaded union composed by: 4835356 Tubetto Pz. 1 17288681 O-Ring Pz. 1 16866973 Seeger Pz. 1	EUROCARGO 120E18/E23 - 130E23 135E23 - 150E23 - 170E23 - 260E23 - 280E23

Illustrazione <i>Illustration</i>	Ns.Rif. <i>Our Ref.</i>	Rif.Costr. <i>O.E. Ref.</i>	Descrizione <i>Description</i>	Tipo di veicolo <i>Vehicle Type</i>
	907245	4670702	Corpo portatermostato nudo Bare thermostat body	110NC-50NC-OM40/35
	907236	4626879	Corpo portatermostato completo Thermostat body complet	110NC-645-650N2/N3
	907238	4670703	Corpo portatermostato completo Thermostat body complet	50NC-662N3
	907239	4620273	Corpo portatermostato completo Thermostat body complet	OM40/35
	907233	4601938	Tubetto corpo portatermostato Thermostat body threaded union	OM
	907234	4669837	Tubetto corpo portatermostato Thermostat body threaded union	50NC - 110NC - 616
	907258	98434833	Corpo portatermostato Thermostat body	EUROCARGO 60-65E10/E12/E14 75E12/E14/E15 80E15/E18/E21 - 95E15/E21 180E21 - 100-120E15/E18/E21 130E15/E18 - 135E15/E18 150-170E15/E18
	907241	98431829	Corpo portatermostato (ex 4804633) Thermostat body	ZETA 50.9 - 65.9 - 79.14 - 109.14 TURBOZETA 60.11 - 65.12 - 79.12 115-135.14/1 -145.17-175.17
	907242	4677550	Corpo portatermostato Thermostat body	170-619-697-300



Illustrazione Illustration	Ns.Rif. Our Ref.	Rif.Costr. O.E. Ref.	Descrizione Description	Tipo di veicolo Vehicle Type
	907092 907094 - -	- 7302296 17278581 16866173	Kit tubetto al termostato in nylon composto da: Nylon thermostat threaded union kit composed by: Tubetto al termostato q.tà 1 Anello OR q.tà 4 Anello seeger q.tà 2	DAILY RESTYLING 30.8 - 35.8 - 40.8
	907019 - - -	- - 17278581 16866173	Kit tubetto al termostato (Ns modifica in alluminio) (sostituisce/replace 4279604) composto da: Aluminium thermostat threaded union kit Our modification composed by: Tubetto modificato q.tà 1 Anello OR q.tà 4 Anello seeger q.tà 2	DAILY RESTYLING 30.8 - 35.8 - 40.8
	907091 907095 - -	- 4697947 17278581 16866173	Kit tubetto al termostato in nylon composto da: Nylon thermostat threaded union kit composed by: Tubetto al termostato q.tà 1 Anello OR q.tà 4 Anello seeger q.tà 2	DAILY RESTYLING 35.10 - 45.10 - 49.10 NEW DAILY 30-35-40.8 - 35-45-49.10 TURBODAILY 35.12 - 49.12 - 59.12 DAILY 2000 35S9 - 35C9
	907020 - - -	- - 17278581 16866173	Kit tubetto al termostato (Ns modifica in alluminio) (sostituisce/replace 4697947) composto da: Aluminium thermostat threaded union kit Our modification composed by: Tubetto modificato q.tà 1 Anello OR q.tà 4 Anello seeger q.tà 2	DAILY RESTYLING 35.10 - 45.10 - 49.10 NEW DAILY 30-35-40.8 - 35-45-49.10 TURBODAILY 35.12 - 49.12 - 59.12 DAILY 2000 35S9 - 35C9

Illustrazione <i>Illustration</i>	Ns.Rif. <i>Our Ref.</i>	Rif.Costr. <i>O.E. Ref.</i>	Descrizione <i>Description</i>	Tipo di veicolo <i>Vehicle Type</i>
	907034 907035 - -	- 99443808 17278581 16866173	Kit tubetto al termostato composto da: Thermostat threaded union kit composed by: Tubetto al term. q.tà 1 Anello OR q.tà 4 Anello seeger q.tà 2	DAILY CITY 2000 35S9/S11/S13/S15 35C9/C11/C13/C15 50C11/C13/C15 65C13/C15
	907035	99443808	Tubetto al termostato Thermostat threaded	DAILY CITY 2000 35S9/S11/S13/S15 35C9/C11/C13/C15 50C11/C13/C15 65C13/C15



Illustrazione <i>Illustration</i>	Ns.Rif. <i>Our Ref.</i>	Rif.Costr. <i>O.E. Ref.</i>	Descrizione <i>Description</i>	Tipo di veicolo <i>Vehicle Type</i>
	907097	4673807	Tubetto al termostato in nylon Nylon thermostat threaded	616-OM40/50-100
	907039	-	Kit tubetto al termostato in nylon composto da: Nylon thermostat threaded union kit composed by:	616-OM40/50-100
	907023	-	Kit tubetto al termostato (NAs modifica in alluminio) (sostituisce/replace 4673807) composto da: Aluminium thermostat threaded union kit Our modification composed by:	616-OM40/50-100
	-	-	Raccordo alluminio q.tà 1 Flangia q.tà 1 Guarnizione piana q.tà 1 Rondella q.tà 2 Vite Ø 8 mm. q.tà 2 Anello OR q.tà 1 Anello OR q.tà 1	

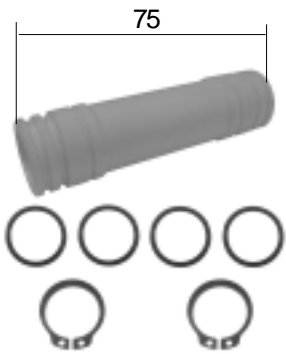

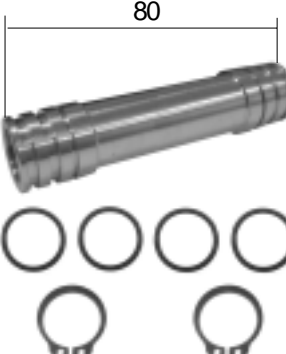
Illustrazione <i>Illustration</i>	Ns.Rif. <i>Our Ref.</i>	Rif.Costr. <i>O.E. Ref.</i>	Descrizione <i>Description</i>	Tipo di veicolo <i>Vehicle Type</i>
	907098	4772057	Tubetto al termostato in nylon Nylon thermostat threaded	115-135.14/17 (1° serie)
	907038	-	Kit tubetto al termostato in nylon composto da: Nylon thermostat threaded union kit composed by:	115-135.14/17 (1° serie)
	907022	-	Kit tubetto al termostato (Ns modifica in alluminio) (sostituisce/replace 4772057) composto da: Aluminium thermostat threaded union kit Our modification composed by:	115-135.14/17 (1° serie)
	-	-	Raccordo alluminio q.tà 1	
	-	4859908	Flangia q.tà 1	
	-	98417182	Guarnizione piana q.tà 1	
	-	12647001	Rondella q.tà 2	
	-	4798845	Vite Ø 8 mm. q.tà 2	
	-	17288681	Anello OR q.tà 2	



Illustrazione <i>Illustration</i>	Ns.Rif. <i>Our Ref.</i>	Rif.Costr. <i>O.E. Ref.</i>	Descrizione <i>Description</i>	Tipo di veicolo <i>Vehicle Type</i>
	907096	4774405	Tubetto al termostato in nylon Nylon thermostat threaded	ZETA 50.9 - 65.9 - 79.14 - 109.14 TURBOZETA 65.12 - 60.11 - 79.12 115-135.14/17-145-175.17 U.T.
	907093	-	Kit tubetto al termostato in nylon composto da: Nylon thermostat threaded union kit composed by:	ZETA 50.9 - 65.9 - 79.14 - 109.14 TURBOZETA 65.12 - 60.11 - 79.12 115-135.14/17-145-175.17 U.T.
	907021	-	Kit tubetto al termostato (Ns modifica in alluminio) (sostituisce/replace 4774405) composto da: Alluminium thermostat threaded union kit Our modification composed by:	ZETA 50.9 - 65.9 - 79.14 - 109.14 TURBOZETA 65.12 - 60.11 - 79.12 115-135.14/17-145-175.17 U.T.
	907096	4774405	Tubetto al termostato	q.tà 1
	-	4770435	Guarnizione	q.tà 1
	-	14463281	Anello OR	q.tà 1
	-		Raccordo alluminio	q.tà 1
	-	4859908	Flangia	q.tà 1
	-	98417182	Guarnizione piana	q.tà 1
	-	12647001	Rondella	q.tà 2
	-	4798845	Vite Ø 8 mm.	q.tà 2
	-	17288681	Anello OR	q.tà 1
	-	14462882	Anello OR	q.tà 1





Illustrazione <i>Illustration</i>	Ns.Rif. <i>Our Ref.</i>	Rif.Costr. <i>O.E. Ref.</i>	Descrizione <i>Description</i>	Tipo di veicolo <i>Vehicle Type</i>
	907054	500326396	Tubo acqua Water pipe	DAILY CITY 2000 35S9/S11/S13/S15 35C9/C11/C13/C15 50C11/C13/C15 65C13/C15
	907055	4837163	Tubo acqua Water pipe	NEW DAILY 30.8 - 35.8 - 40.8
	907059	99443658	Tubo acqua Water pipe	NEW DAILY 30.8 - 35.8
	907062	99482735	Tubo acqua Water pipe	NEW DAILY 30.8 - 35.8 TURBODAILY 35.12





Illustrazione <i>Illustration</i>	Ns.Rif. <i>Our Ref.</i>	Rif.Costr. <i>O.E. Ref.</i>	Descrizione <i>Description</i>	Tipo di veicolo <i>Vehicle Type</i>
	907048	93805975	Tubo acqua Water pipe	DAILY RESTYLING 30.8 - 35.8 - 40.8
	907032	98410628	Tubo acqua Water pipe	NEW DAILY 30.8 - 35.8 - 40.8
	907033	7302947	Tubo acqua Water pipe	DAILY RESTYLING 35.10 - 45.10 - 49.10
	907060	98467958	Tubo acqua Water pipe	NEW DAILY 35.10 - 45.10 - 49.10 TURBODAILY 35.12 - 49.12 - 59.12



Illustrazione <i>Illustration</i>	Ns.Rif. <i>Our Ref.</i>	Rif.Costr. <i>O.E. Ref.</i>	Descrizione <i>Description</i>	Tipo di veicolo <i>Vehicle Type</i>
	907063	99457054	Tubo acqua Waterpipe	TURBODAILY 30.10 - 35.10 - 49.10 35.12 - 49.12 - 59.12
	907042	98434054	Tubo acqua Waterpipe	DAILY TURBODAILY
	907064	4674672	Tubo acqua Waterpipe	110 NC





Illustrazione <i>Illustration</i>	Ns.Rif. <i>Our Ref.</i>	Rif.Costr. <i>O.E. Ref.</i>	Descrizione <i>Description</i>	Tipo di veicolo <i>Vehicle Type</i>
	907056	4615461	Tubo acqua Water pipe	OM40-50NC-625
	907053	4615459	Tubo acqua Water pipe	50NC - 625 - CO3 I
	907057	8827468	Tubo acqua Water pipe	OM50-55
	907058	8826137	Tubo acqua Water pipe	OM50-55







Illustrazione <i>Illustration</i>	Ns.Rif. <i>Our Ref.</i>	Rif.Costr. <i>O.E. Ref.</i>	Descrizione <i>Description</i>	Tipo di veicolo <i>Vehicle Type</i>
 AD ESAURIMENTO UNTILL OUT OF STOCK	907043	4713436	Tubo acqua Water pipe	GAMMAZETA 65-70-75.10
 AD ESAURIMENTO UNTILL OUT OF STOCK	907067	4675739	Tubo acqua Water pipe	691N
 AD ESAURIMENTO UNTILL OUT OF STOCK	907041	98451994	Tubo acqua (ex 4684407) Water pipe	180NC-619N-697N/NP 300PC
 AD ESAURIMENTO UNTILL OUT OF STOCK	907083	4622832	Tubo collettore acqua in alluminio Aluminium water manifold pipe	684 - 160
 AD ESAURIMENTO UNTILL OUT OF STOCK	907078	4640382	Tubo acqua Water pipe	180NC-619N-697N/NP 300PC

Illustrazione <i>Illustration</i>	Ns.Rif. <i>Our Ref.</i>	Rif.Costr. <i>O.E. Ref.</i>	Descrizione <i>Description</i>	Tipo di veicolo <i>Vehicle Type</i>
 <p>AD ESAURIMENTO UNTILL OUT OF STOCK</p>	907081	98450713 4629057	Tubo uscita pompa acqua Water pipe	180NC-619N1-697N/NP 300PC
 <p>AD ESAURIMENTO UNTILL OUT OF STOCK</p>	907052	4671034	Tubo acqua Water pipe	619-697N/NP 300



**LINEA VARIE
MISCELLANEOUS PARTS
RECHANGES DIVERS
VARIOS RECAMBIOS
ZUBEHOER ARTIKELN**

ДОПОЛНИТЕЛЬНЫЕ КОМПОНЕНТЫ

ةعونتم رايغ عطق

EMMEDE



2009

EMMERRE



TECHNO BRAKE®

**ARTICOLI NUOVI INSERITI
NEL CATALOGO VARIE
2009**

**NEW ARTICLES INCLUDED IN
VARIOUS CATALOGUE
2009**

RIBALTAMENTO CABINA E COMPONENTI - TIPPING OVER CABIN AND COMPONENTS

EMMERRE	Adattabile - Adaptable	Applicazione - Application	Pagina - Page
100952	9425000050	MERCEDES	36
100954	9423100049	MERCEDES	36
100955	5010269380	RENAULT	36
100961	5000789265	RENAULT	37
100962	5010316015	RENAULT	37
101007	500357265	IVECO	35
101010	500351393	IVECO	35
101016	9423172312	MERCEDES	36
101021	5010316874	RENAULT	38
101031	504021532	IVECO	35
101034	8141581	IVECO	34
973068	9423172012	MERCEDES	36
973148	500357351	IVECO	28
973190	1755638	SCANIA	18
973210	1742449	SCANIA	18
973220	1908861	IVECO	22
973221	20889134	VOLVO	33
973221	20721169	VOLVO	33
973221	1076855	VOLVO	33
975011	5010320096	RENAULT	31
975012	5010130797	RENAULT	31
975012	5010629414	RENAULT	31
975014	500307338	IVECO	28
975015	41028764	IVECO	28
975016	1349840	SCANIA	32
975018	1424231	SCANIA	32
975019	1348121	SCANIA	32
975021	8162377	IVECO	23
975022	504065532	IVECO	23
975023	1476415	SCANIA	32
975023	1381919	SCANIA	32
975032	81.41722.6048	MAN	29
975032	81.41722.6051	MAN	29
975033	9428905919	MERCEDES	30
975033	9428905319	MERCEDES	30
975037	-	IVECO	12
975046	9428900219	MERCEDES	30
975046	9428906019	MERCEDES	30
975053	9428902919	MERCEDES	30
975053	9428900119	MERCEDES	30
975055	1075076	VOLVO	33
975055	1075077	VOLVO	33
975065	3172964	VOLVO	33
975065	1629719	VOLVO	33
975065	1629724	VOLVO	33

EMMERRE



TECHNO BRAKE®

**ARTICOLI NUOVI INSERITI
NEL CATALOGO VARIE
2009**

**NEW ARTICLES INCLUDED IN
VARIOUS CATALOGUE
2009**

PARTI MOTORE - ENGINE PARTS

EMMERRE	Adattabile - Adaptable	Applicazione - Application	Pagina - Page
901151	99433386	IVECO	45
901339	500305943	IVECO	74
901340	99473900	IVECO	74
901345	504086948	IVECO	55
902007	500314583	IVECO	62
902012	99444499	IVECO	62
903039	41029915	IVECO	49
903040	98416091	IVECO	49
906116	500302200	IVECO	47
906117	93827837	IVECO	46
906237	4840434	IVECO	70
906238	4746909	IVECO	68
906239	4746907	IVECO	67
906241	504084761	IVECO	71
906242	98453557	IVECO	70
913000	98420643	IVECO	46

PARTI SCARICO - EXHAUST SYSTEM

EMMERRE	Adattabile - Adaptable	Applicazione - Application	Pagina - Page
905201	500329488	IVECO	102
905202	504033946	IVECO	102
905203	504033945	IVECO	102
905204	41007585	IVECO	104
905205	41210818	IVECO	104
905206	41210895	IVECO	104
905208	500388499	IVECO	103
905403	41210965	IVECO	116
905404	41020590	IVECO	117
905451	500329489	IVECO	114
905452	99456851	IVECO	114
905455	99461871	IVECO	115
905456	500370650	IVECO	114
905457	500370649	IVECO	115
905603	42532610	IVECO	93
905669	504059011	IVECO	102
905678	41213998	IVECO	117
905680	41214000	IVECO	117
906123	99499169	IVECO	81
906124	99450703	IVECO	81
906129	99431084	IVECO	80
906243	99450704	IVECO	80

EMMERRE**TECHNO
BRAKE®**

**ARTICOLI NUOVI INSERITI
NEL CATALOGO VARIE
2009**

**NEW ARTICLES INCLUDED IN
VARIOUS CATALOGUE
2009**

PARTI FRIZIONE E CAMBIO - CLUTCH AND GEAR PARTS

EMMERRE	Adattabile - Adaptable	Applicazione - Application	Pagina - Page
908003	2992630	IVECO	133
908007	5001830936	RENAULT	135
908007	5001838967	RENAULT	135
908008	2994026	IVECO	134
908009	2994028	IVECO	134
908010	42003397	IVECO	140
908011	8193332	IVECO	140
908012	1123296	SCANIA	143
908012	1393332	SCANIA	143
908012	1434649	SCANIA	143
908013	500305439	IVECO	140
908020	93162071	IVECO	135
908026	93162073	IVECO	135
908036	93161953	IVECO	134
908370	2995814	IVECO	133
911048	8576824	IVECO	148
911050	8132189	IVECO	156
913006	99465843	IVECO	149
913010	41271992	IVECO	150
913018	41271991	IVECO	150
913019	41226954	IVECO	150

PARTI TRASMISSIONE E DIFFERENZIALE - TRANSMISSION AND DIFFERENTIAL PARTS

EMMERRE	Adattabile - Adaptable	Applicazione - Application	Pagina - Page
923104	93190028	IVECO	180
924999	7180038	IVECO	168
925015	8171366	VOLVO	176
925035	42538361	IVECO	174
925040	6564110012	MERCEDES	176
926002	1696389	VOLVO	176
933402	500330665	IVECO	193
933403	504003565	IVECO	193
933408	93826384	IVECO	193
933455	42118921	IVECO	183
933459	-	IVECO	190
933475	-	IVECO	190
934027	8198583	IVECO	179
934033	42532346	IVECO	179
934034	93160516	IVECO	179
934035	42533841	IVECO	179
934037	93192015	IVECO	179
934038	42533410	IVECO	180
934039	42537896	IVECO	180
934040	93157114	IVECO	180
934041	93159498	IVECO	180
953200	7184090	IVECO	192

EMMERRE**TECHNO
BRAKE®**

**ARTICOLI NUOVI INSERITI
NEL CATALOGO VARIE
2009**

**NEW ARTICLES INCLUDED IN
VARIOUS CATALOGUE
2009**

ARTICOLI VARI - MISCELLANEOUS PARTS

EMMERRE	Adatt. - Adaptable	Applicazione - Application	Pagina - Page
905562	3091751	VOLVO	222
906066	99484737	IVECO	214
954570	42548853	IVECO	220
970004	-	IVECO	221
970940	500316868/A	IVECO	210
972112	2486068	IVECO	198
972113	42051434	IVECO	198
990510	504108890	IVECO	216
990511	500321204	IVECO	216
990512	42552536	IVECO	217
990513	42552535	IVECO	216
990514	42552534	IVECO	216

ARTICOLI IN GOMMA - RUBBER PARTS

EMMERRE	Adatt. - Adaptable	Applicazione - Application	Pagina - Page
100018	500398156	IVECO	244
100020	504004369	IVECO	244
100053	81962100554	MAN	255
100808	9703170112	MERCEDES	239
100826	9413260050	MERCEDES	239
100884	81.43722.0087	MAN	236
101032	9403171112	MERCEDES	248
101032	9423172012	MERCEDES	248
103679	41218902	IVECO	235

ACCESSORI VARI (KIT COMPRESSORI ARIA) - VARIOUS ARTICLES (AIR COMPRESSOR)

EMMERRE	Adatt. - Adaptable	Applicazione - Application	Pagina - Page
970003	-	VEICOLI LEGGERI T.T	272
970005	-	VEICOLI LEGGERI T.T	272
970008	-	VEICOLI LEGGERI T.T	271
970009	-	VEICOLI LEGGERI T.T	271

Ns. Riferimento <i>Ns. Ref.</i>	Descrizione <i>Description</i>
975036	KIT RIBALTAMENTO CABINA (SENZA MOLLE) COMPLETE TIPPING OVER CABIN KIT (WITHOUT SPRINGS)

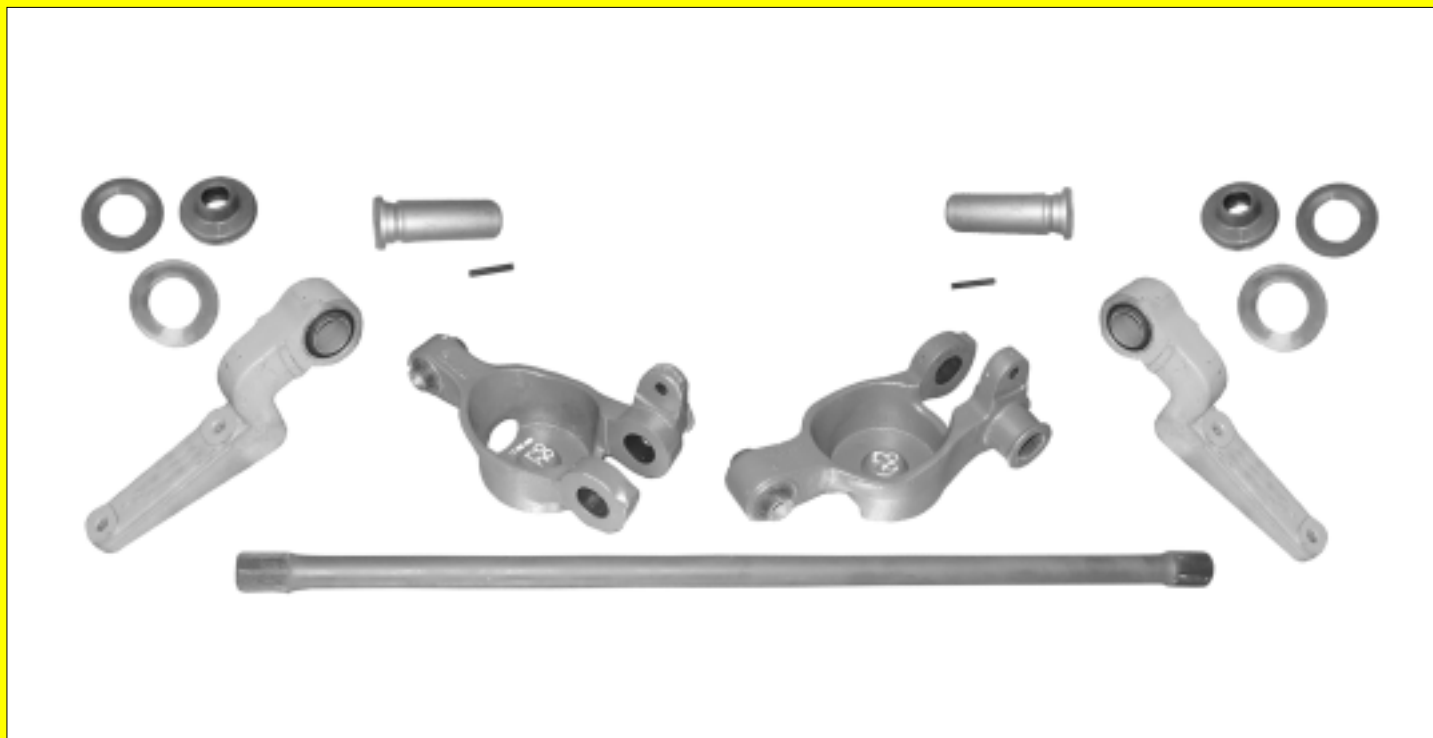

Composto da: <i>Composed by:</i>				Tipo di Applicazione <i>Type of Application</i>
Ns. Rif. <i>Ns. Ref.</i>	Rif. OE <i>OE Ref.</i>	Descrizione <i>Description</i>	Q.tà <i>Q.ty</i>	
980019	98418616	Barra cabina	1	EUROCARGO T.T (Cabina corta e lunga) (<i>Short and long cabin</i>)
-	98411635	Leva	1	
-	98411636	Leva	1	
-	98416703	Supporto	2	
-	8139014	Rosetta	4	
-	8139015	Perno	2	
-	17258070	Spina elastica	2	
-	99433917	Cuffia di protezione	2	

Ns. Riferimento <i>Ns. Ref.</i>	Descrizione <i>Description</i>
975028	KIT RIBALTAMENTO CABINA (CON MOLLE) COMPLETE TIPPING OVER CABIN KIT (WITH SPRINGS)

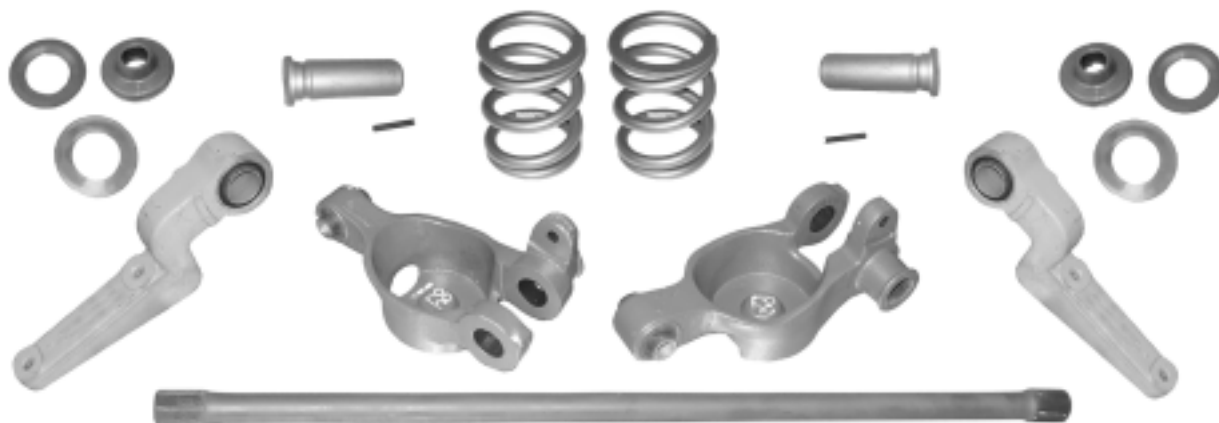

Composto da: <i>Composed by:</i>				Tipo di Applicazione <i>Type of Application</i>
Ns. Rif. <i>Ns. Ref.</i>	Rif. OE <i>OE Ref.</i>	Descrizione <i>Description</i>	Q.tà <i>Q.ty</i>	
980019	98418616	Barra cabina	1	EUROCARGO (Cabina lunga) (<i>Long cabin</i>)
-	98411635	Leva	1	
-	98411636	Leva	1	
-	98416703	Supporto	2	
-	8139014	Rosetta	4	
-	8139015	Perno	2	
-	17258070	Spina elastica	2	
-	99433917	Cuffia di protezione	2	
980016	99447542	Molla cabina	1	
980017	99447543	Molla cabina	1	

Ns. Riferimento <i>Ns. Ref.</i>	Descrizione <i>Description</i>
975029	KIT RIBALTAMENTO CABINA (CON MOLLE) COMPLETE TIPPING OVER CABIN KIT (WITH SPRINGS)

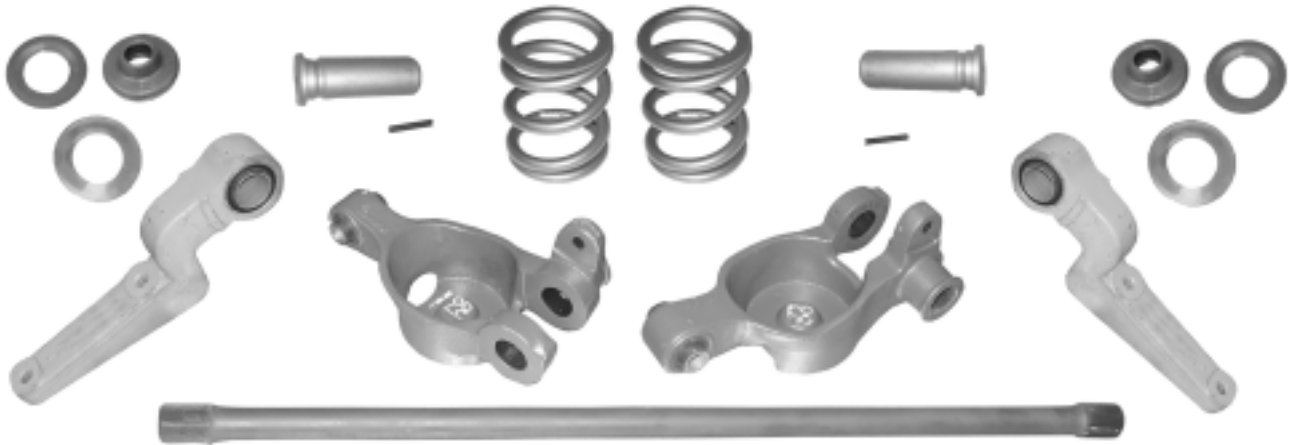

Composto da: <i>Composed by:</i>				Tipo di Applicazione <i>Type of Application</i>
Ns. Rif. <i>Ns. Ref.</i>	Rif. OE <i>OE Ref.</i>	Descrizione <i>Description</i>	Q.tà <i>Q.ty</i>	
980019	98418616	Barra cabina	1	EUROCARGO (Cabina corta) (<i>Short cabin</i>)
-	98411635	Leva	1	
-	98411636	Leva	1	
-	98416703	Supporto	2	
-	8139014	Rosetta	4	
-	8139015	Perno	2	
-	17258070	Spina elastica	2	
-	99433917	Cuffia di protezione	2	
980012	99447540	Molla cabina	1	
980015	99447541	Molla cabina	1	

Ns. Riferimento <i>Ns. Ref.</i>	Descrizione <i>Description</i>
975034	KIT RIBALTAMENTO CABINA COMPLETE TIPPING OVER CABIN KIT NOSTRA MODIFICA - OUR MODIFICATION

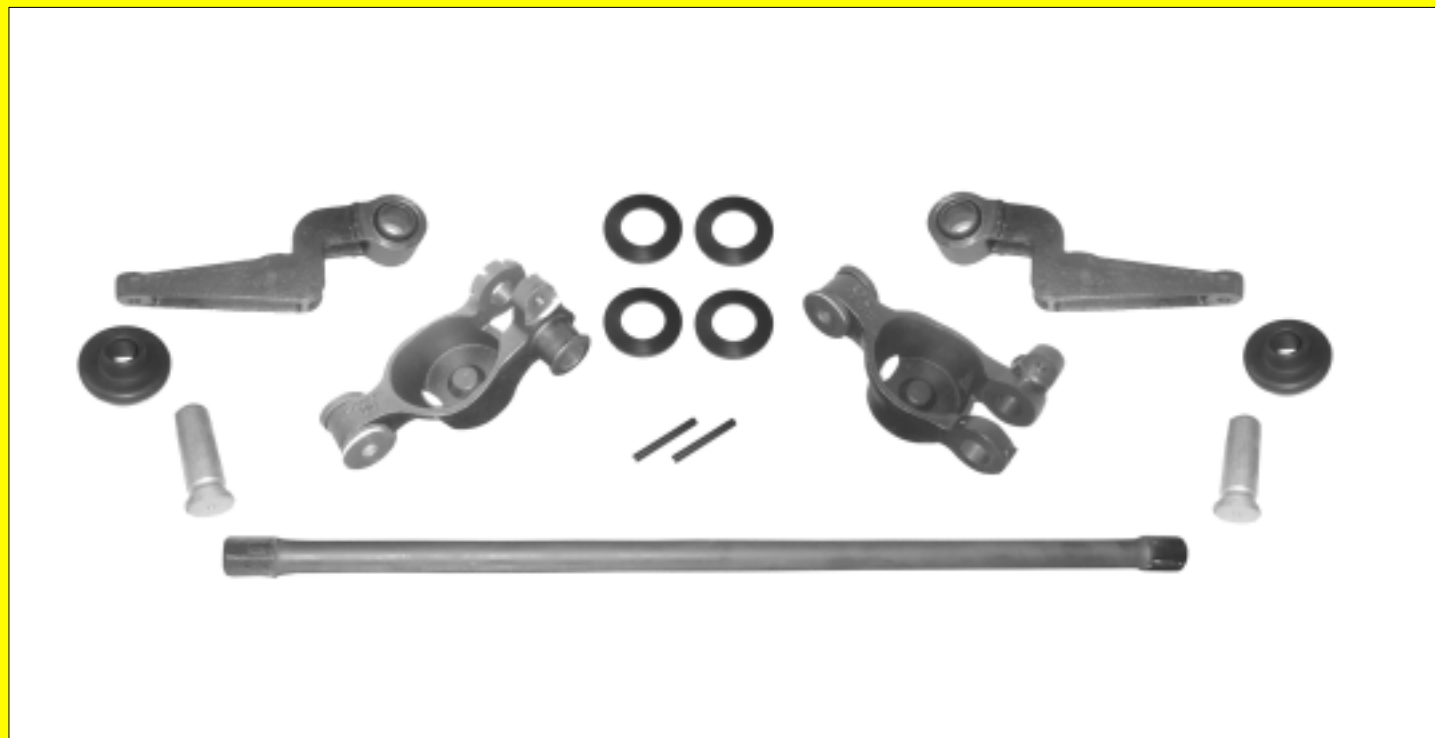

Composto da: <i>Composed by:</i>				Tipo di Applicazione <i>Type of Application</i>
Ns. Rif. <i>Ns. Ref.</i>	Rif. OE <i>OE Ref.</i>	Descrizione <i>Description</i>	Q.tà <i>Q.ty</i>	
980019	98418616	Barra cabina	1	EUROCARGO 95E15 - 135E18/E23 150E15/E18/E21/E24 170E15/E18/E23/E27 EUROCARGO TECTOR 100E18/E21 180E21/E24/E28 260E27KE/E28KE
-	98411635.1	Leva ns modifica	1	
-	98411636.1	Leva ns modifica	1	
-	98416703	Supporto	2	
-	8139014	Rosetta	4	
-	8139015	Perno	2	
-	17258070	Spina elastica	2	
-	99433917	Cuffia di protezione	2	

Ns. Riferimento Ns. Ref.	Descrizione Description
975035	KIT RIBALTAMENTO CABINA COMPLETE TIPPING OVER CABIN KIT

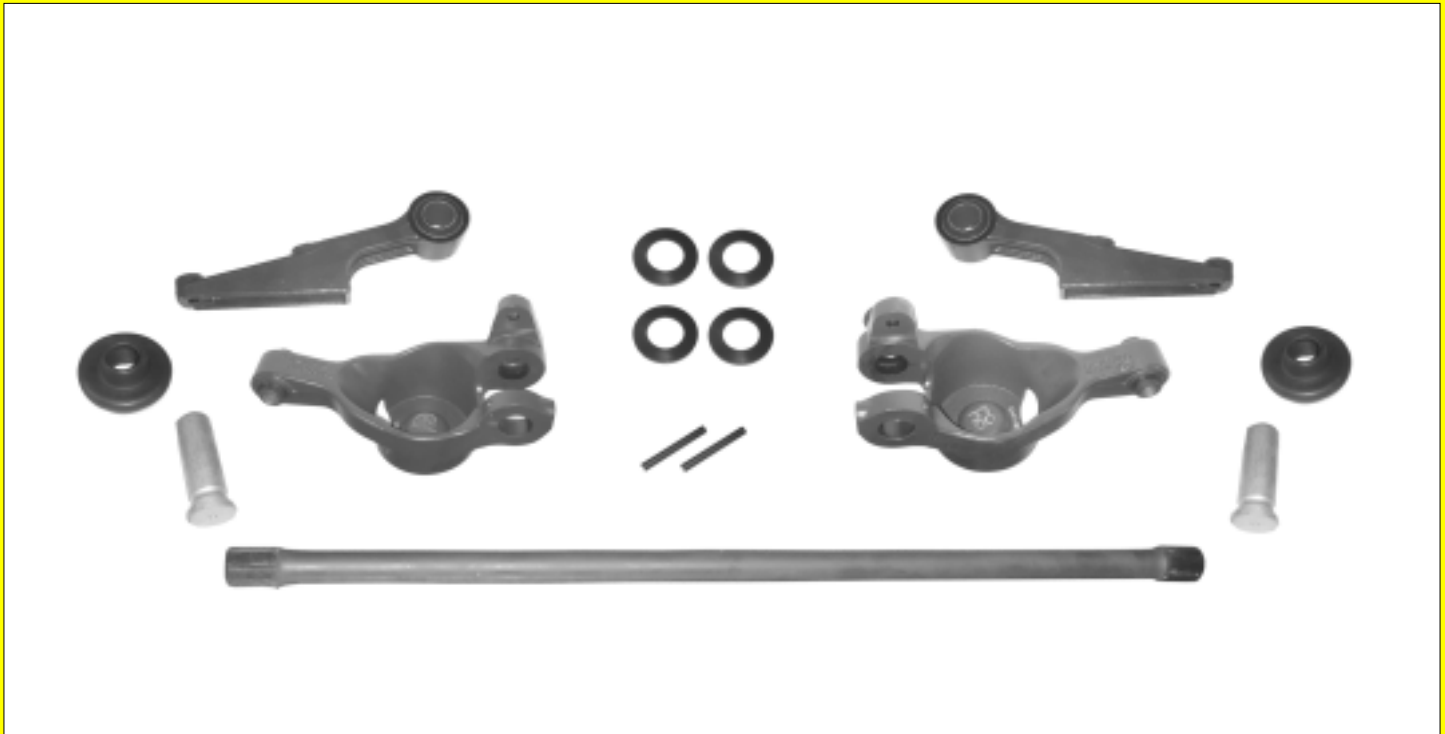

Composto da: Composed by:				Tipo di Applicazione Type of Application
Ns. Rif. Ns. Ref.	Rif. OE OE Ref.	Descrizione Description	Q.tà Q.ty	
-	504086022	Barra torsione cabina (completa di mensole)	1	EUROCARGO TECTOR 100E17/E18/E21 120E17/E21 130E18/E21/E24/E28 150E21/E24/E28
-	504037805	Supporto	2	
101055	-	Silentblock cabina	2	
-	8139014	Rosetta	4	
-	8139015	Perno	2	
-	17258070	Spina elastica	2	
-	99433917	Cuffia di protezione	2	

Ns. Riferimento Ns. Ref.	Descrizione Description
975041	KIT RIB. CABINA (SOSPENSIONE MECCANICA) COMPLETE TIPPING OVER CABIN KIT (MECHANICAL SUSPENSION)



Composto da: Composed by:				Tipo di Applicazione Type of Application	
Ns. Rif. Ns. Ref.	Rif. OE OE Ref.	Descrizione Description	Q.tà Q.ty		
975073	41012353	Barra di torsione	1	EUROTECH	
975027	41015449	Mensola	2	180-190E24/E27/E30/E34/E38E/42 - 240E34/E38/E42	
975025	41022082	Leva cabina Sx	1	260E38/E42 - 325E27 - 400E30/E34/E38/E42 - 440E34/E38	
975026	41022085	Leva cabina Dx	1	EUROTECH CURSOR	
-	41022094	Perno	2	190E24/E31/E35/E39/E43-260E24/E31/E35/E39/E43	
975067	41013913	Cuffia in gomma	2	440E31/E35/E39/E43	
-	17258270	Spina elastica	2	EUROSTAR	
				180E38/E42 - 190E38/E42/E47/E52 - 240E38/E42/E47/E52	
				260E42/E47/E52 - 400-440/E38/E42/E47/E52	
				EUROSTAR CURSOR	
				190E39/E43 - 260E39/43	
				440E39/E43/E46/E48	
				EUROTRAKKER	
				190E30/E31/E34/E37/E42 - 260E30/E34/E37/E42	
				330E34/E37 - 340E34/E37/E42	
				380E31/E34/E37/E42/E47 - 400E31/E34/E37/E42	
				410E37/E42 - 440E34/E37/E42	
				720E31/E37/E42/E47	
				EUROTRAKKER CURSOR	
				180E24 - 190E24/E31/E35/E44	
				260E31/E35/E38/E44 - 340-380E35/E38/E44	
				400E35 - 410E35/E38/E44 - 720E44	

Ns. Riferimento Ns. Ref.	Descrizione Description
975030	KIT RIB. CABINA (SOSPENSIONE MECCANICA) COMPLETE TIPPING OVER CABIN KIT (MECHANICAL SUSPENSION)

COMPLETO DI MOLLE - WITH SPRINGS



Composto da: Composed by:				Tipo di Applicazione Type of Application	
Ns. Rif. Ns. Ref.	Rif. OE OE Ref.	Descrizione Description	Q.tà Q.ty		
975073	41012353	Barra di torsione	1	EUROTECH	
975027	41015449	Mensola	2	180-190E24/E27/E30/E34/E38E/42 - 240E34/E38/E42	
975025	41022082	Leva cabina Sx	1	260E38/E42 - 325E27 - 400E30/E34/E38/E42 - 440E34/E38	
975026	41022085	Leva cabina Dx	1	EUROTECH CURSOR	
980014	41001890	Molla cabina	2	190E24/E31/E35/E39/E43-260E24/E31/E35/E39/E43	
-	41022094	Perno	2	440E31/E35/E39/E43	
975067	41013913	Cuffia in gomma	2	EUROSTAR	
-	17258270	Spina elastica	2	180E38/E42 - 190E38/E42/E47/E52 - 240E38/E42/E47/E52 260E42/E47/E52 - 400-440/E38/E42/E47/E52	
				EUROSTAR CURSOR	
				190E39/E43 - 260E39/43 440E39/E43/E46/E48	
				EUROTRAKKER	
				190E30/E31/E34/E37/E42 - 260E30/E34/E37/E42 330E34/E37 - 340E34/E37/E42 380E31/E34/E37/E42/E47 - 400E31/E34/E37/E42 410E37/E42 - 440E34/E37/E42 720E31/E37/E42/E47	
				EUROTRAKKER CURSOR	
				180E24 - 190E24/E31/E35/E44 260E31/E35/E38/E44 - 340-380E35/E38/E44 400E35 - 410E35/E38/E44 - 720E44	

Ns. Riferimento Ns. Ref.	Descrizione Description
975039	KIT RIB. CABINA (SOSPENSIONE PNEUMATICA) COMPLETE TIPPING OVER CABIN KIT (PNEUMATIC SUSPENSION)

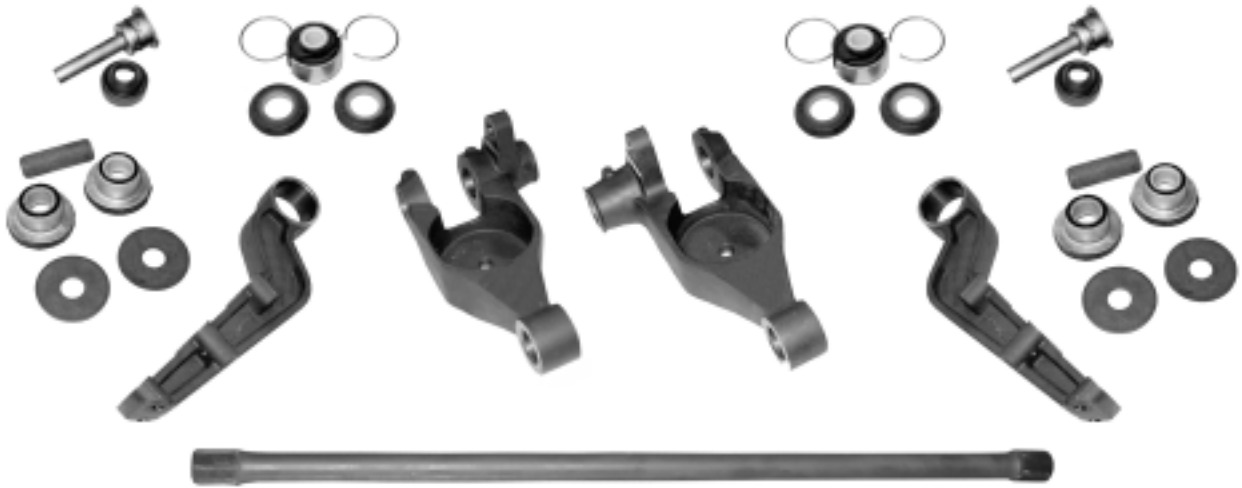

Composto da: Composed by:				Tipo di Applicazione Type of Application	
Ns. Rif. Ns. Ref.	Rif. OE OE Ref.	Descrizione Description	Q.tà Q.ty		
975072	41012352	Barra di torsione	1	EUROTECH	
975027	41015449	Mensola	2	180-190E24/E27/E30/E34/E38E/42 - 240E34/E38/E42	
975025	41022082	Leva cabina Sx	1	260E38/E42 - 325E27 - 400E30/E34/E38/E42 - 440E34/E38	
975026	41022085	Leva cabina Dx	1	EUROTECH CURSOR	
-	41022094	Perno	2	190E24/E31/E35/E39/E43-260E24/E31/E35/E39/E43	
975067	41013913	Cuffia in gomma	2	440E31/E35/E39/E43	
-	17258270	Spina elastica	2	EUROSTAR	
				180E38/E42 - 190E38/E42/E47/E52 - 240E38/E42/E47/E52	
				260E42/E47/E52 - 400-440/E38/E42/E47/E52	
				EUROSTAR CURSOR	
				190E39/E43 - 260E39/43	
				440E39/E43/E46/E48	
				EUROTRAKKER	
				190E30/E31/E34/E37/E42 - 260E30/E34/E37/E42	
				330E34/E37 - 340E34/E37/E42	
				380E31/E34/E37/E42/E47 - 400E31/E34/E37/E42	
				410E37/E42 - 440E34/E37/E42	
				720E31/E37/E42/E47	
				EUROTRAKKER CURSOR	
				180E24 - 190E24/E31/E35/E44	
				260E31/E35/E38/E44 - 340-380E35/E38/E44	
				400E35 - 410E35/E38/E44 - 720E44	

Ns. Riferimento Ns. Ref.	Descrizione Description
975031	KIT RIB. CABINA (SOSPENSIONE PNEUMATICA) COMPLETE TIPPING OVER CABIN KIT (PNEUMATIC SUSPENSION)

COMPLETO DI CELLE SOSPENSIONI - WITH AIR SPRING SUSPENSION



Composto da: Composed by:				Tipo di Applicazione Type of Application	
Ns. Rif. Ns. Ref.	Rif. OE OE Ref.	Descrizione Description	Q.tà Q.ty		
975072	41012352	Barra di torsione	1	EUROTECH	
975027	41015449	Mensola	2	180-190E24/E27/E30/E34/E38E/42 - 240E34/E38/E42	
975025	41022082	Leva cabina Sx	1	260E38/E42 - 325E27 - 400E30/E34/E38/E42 - 440E34/E38	
975026	41022085	Leva cabina Dx	1	EUROTECH CURSOR	
975050	41019150	Cella sosp. pneumatica	2	190E24/E31/E35/E39/E43-260E24/E31/E35/E39/E43	
-	41022094	Perno	2	440E31/E35/E39/E43	
975067	41013913	Cuffia in gomma	2	EUROSTAR	
-	17258270	Spina elastica	2	180E38/E42 - 190E38/E42/E47/E52 - 240E38/E42/E47/E52 260E42/E47/E52 - 400-440/E38/E42/E47/E52	
				EUROSTAR CURSOR	
				190E39/E43 - 260E39/43	
				440E39/E43/E46/E48	
				EUROTRAKKER	
				190E30/E31/E34/E37/E42 - 260E30/E34/E37/E42	
				330E34/E37 - 340E34/E37/E42	
				380E31/E34/E37/E42/E47 - 400E31/E34/E37/E42	
				410E37/E42 - 440E34/E37/E42	
				720E31/E37/E42/E47	
				EUROTRAKKER CURSOR	
				180E24 - 190E24/E31/E35/E44	
				260E31/E35/E38/E44 - 340-380E35/E38/E44	
				400E35 - 410E35/E38/E44 - 720E44	

Ns. Riferimento <i>Ns. Ref.</i>	Descrizione <i>Description</i>
975037	KIT RIBALTAMENTO CABINA COMPLETE TIPPING OVER CABIN KIT



Composto da: <i>Composed by:</i>				Tipo di Applicazione <i>Type of Application</i>
Ns. Rif. <i>Ns. Ref.</i>	Rif. OE <i>OE Ref.</i>	Descrizione <i>Description</i>	Q.tà <i>Q.ty</i>	STRALIS T.T.
-	504176388	Supporto superiore cabina	1	
-	504176382	Supporto superiore cabina	1	
-	504176391	Supporto inferiore cabina	2	
-	504176397	Leva completa cabina	1	
-	504189784	Boccola	2	
-	504189785	Vite	2	
-	16733424	Prigioniero	2	
-	16683834	Vite	2	

Ns. Riferimento Ns. Ref.	Descrizione Description
975042	KIT RIBALTAMENTO CABINA COMPLETE TIPPING OVER CABIN KIT

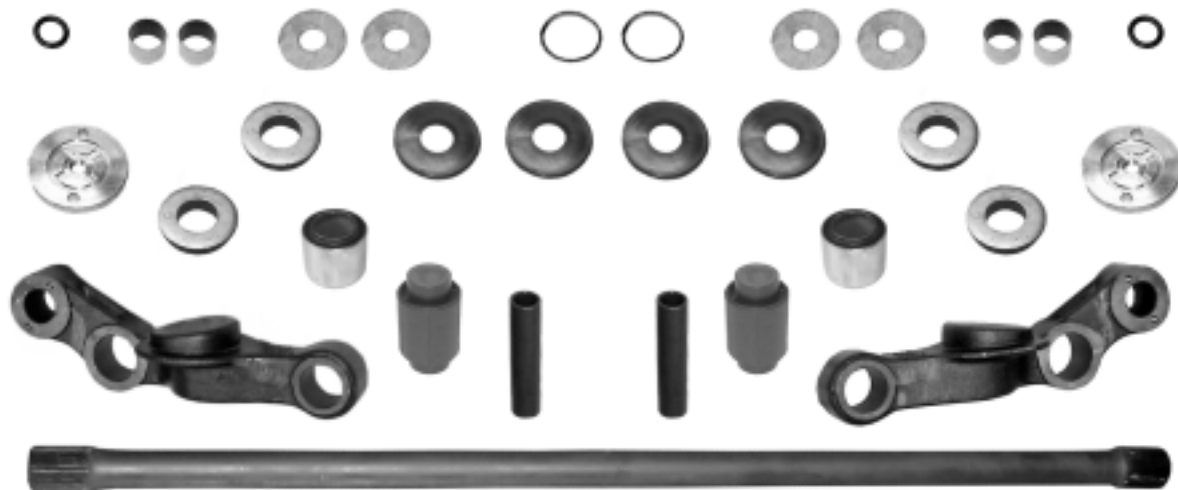

Composto da: Composed by:				Tipo di Applicazione Type of Application	
Ns. Rif. Ns. Ref.	Rif. OE OE Ref.	Descrizione Description	Q.tà Q.ty		
-	14458380	Anello OR	2	TURBOSTAR 190.36/42/48 240.36/48 - 260.36/48 TURBOTECH 240.36	
-	10902124	Vite	4		
-	42105575	Rondella nylon	4		
-	42070619	Rondella ferro	4		
-	1166030	Anello OR	2		
-	42106071	Astuccio	2		
101040	42105574	Silentblock cabina	2		
-	42106180	Boccola	4		
-	42070675	Base di gomma	2		
-	42121716	Coperchio	2		
-	1120694	Ingrassatore	2		
101039	42070674	Silentblock	2		
975057	42106069	Leva soll. cabina Sx	1		
975058	42106070	Leva soll. cabina Dx	1		
975054	42070266	Barra di torsione	1		

Ns. Riferimento <i>Ns. Ref.</i>	Descrizione <i>Description</i>
975043	KIT RIBALTAMENTO CABINA CON SUPPORTI COMPLETE TIPPING OVER CABIN KIT (WITH SUPPORTS)

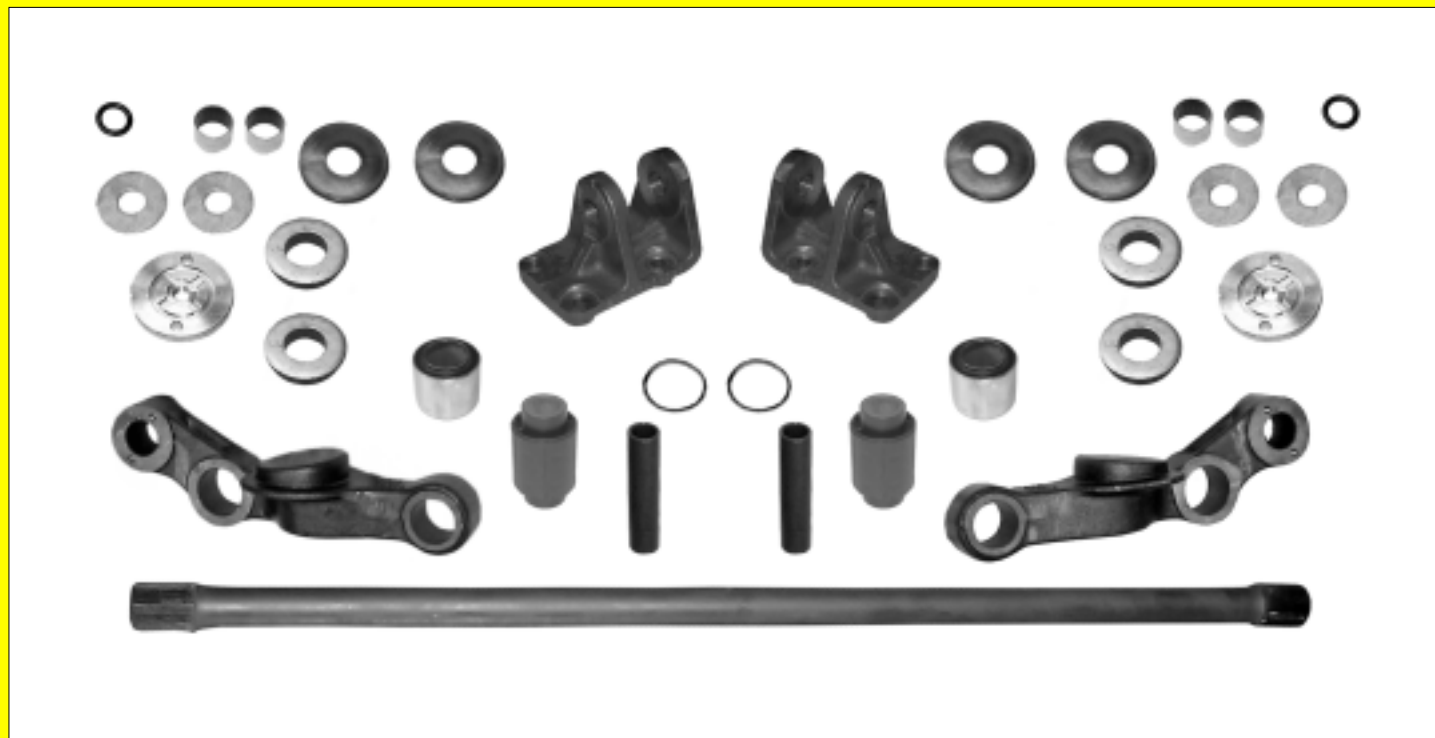

Composto da: <i>Composed by:</i>				Tipo di Applicazione <i>Type of Application</i>
Ns. Rif. <i>Ns. Ref.</i>	Rif. OE <i>OE Ref.</i>	Descrizione <i>Description</i>	Q.tà <i>Q.ty</i>	
-	14458380	Anello OR	2	TURBOSTAR 190.36/42/48 240.36/48 260.36/48 TURBOTECH 240.36
-	10902124	Vite	4	
-	42105575	Rondella nylon	4	
-	42070619	Rondella ferro	4	
-	1166030	Anello OR	2	
-	42106071	Astuccio	2	
101040	42105574	Silentblock cabina	2	
-	42106180	Boccola	4	
-	42070675	Base di gomma	2	
-	42121716	Coperchio	2	
-	1120694	Ingrassatore	2	
101039	42070674	Silentblock	2	
975057	42106069	Leva soll. cabina Sx	1	
975058	42106070	Leva soll. cabina Dx	1	
975054	42070266	Barra di torsione	1	
980010	42105790	Supporto fissaggio	2	

Ns. Riferimento
Ns. Ref.**975044**Rif. Costruttore
OE. Ref.

-

Applicazione
Application

TURBOSTAR
190.36/42/48
240.36/48
260.36/48

TURBOTECH
240.36

Descrizione - Tipo di applicazione
Description - Application type

**KIT RIBALTAMENTO CABINA
RIDOTTO**

REDUCED TIPPING OVER CABIN KIT

Ns. Riferimento
Ns. Ref.

101035

Rif. Costruttore
OE. Ref.

1907808

Applicazione
Application

EUROTECH

180-190E24/E27/E30/E34/E38E/42
240E34/E38/E42
260E38/E42 - 325E27 - 400
440E30/E34/E38/E42

EUROTECH CURSOR

190E24/E31/E35/E39/E43
260E24/E31/E35/E39/E43
440E31/E35/E39/E43

EUROSTAR

180E38/E42 - 190E38/E42/E47/E52
240E38/E42/E47
260E42/E47/E52
400-440/E38/E42/E47/E52

EUROSTAR CURSOR

190E39/E43 - 260E39/43
440E39/E43/E46/E48

EUROTRAKKER

190E30/E31/E34/E37/E42
260E30/E34/E37/E42
330E34/E37 - 340E34/E37/E42
380-400E31/E34/E37/E42/E47
410-440E37/E42
720E31/E37/E42/E47

EUROTRAKKER CURSOR



Descrizione - Tipo di applicazione
Description - Application type

SERIE BOCCOLE PER LEVA
BUSHINGS KIT FOR CABIN LEVER

Ns. Riferimento
Ns. Ref.**101036**Rif. Costruttore
OE. Ref.

1908221

Applicazione
ApplicationDescrizione - Tipo di applicazione
Description - Application type**EUROCARGO**95E15/E21 - 135E18/E23
170E15/E18/E23/E27**EUROTECH**180-190E24/E27/E30/E34/E38/E42
240E34/E38/E42
260E38/E42 - 325E27
400E30/E34/E38/E42
440E34/E38/E42**EUROSTAR**180E38 - 190E38/E42/E47/E52
240E38/E42/E47/E52
260E42/E47/E52
400-440/E38/E42/E47/E52**EUROTRAKKER**190E30/E31/E34/E37/E42
260E30/E34/E37/E42/E47
330E34/E37 - 340E34/E37/E42
380E31/E34/E37/E42/E47
400E31/E34/E37/E42
410E37/E42 - 440E37/E42
720E31/E37/E42/E47**SERIE BOCCOLE PER MENSOLA
CABINA****BUSHINGS KIT FOR CABIN BRACKET**

Ns. Riferimento
Ns. Ref.**101037**Rif. Costruttore
OE. Ref.

42470849

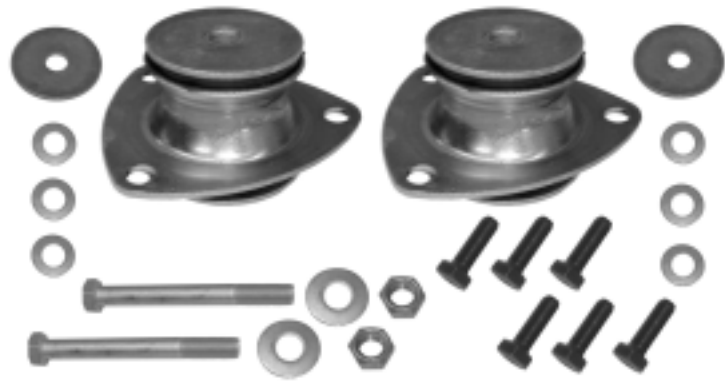
Applicazione
ApplicationDescrizione - Tipo di applicazione
Description - Application type

DAILY CITY 2000
35S9/S11/S13/S15
35C9/C11/C13/C15
35S10/S12
35C10/C12
50C11/C13/C15

KIT TASSELLI CABINA ANTERIORE
FRONT CABIN DOWELS KIT

Ns. Riferimento
Ns. Ref.**101038**Rif. Costruttore
OE. Ref.

42470850

Applicazione
ApplicationDescrizione - Tipo di applicazione
Description - Application type

DAILY CITY 2000
35S9/S11/S13/S15
35C9/C11/C13/C15
35S10/S12
35C10/C12
50C11/C13/C15
65C11/C13/C15

KIT TASSELLI CABINA POSTERIORE
REAR CABIN DOWELS KIT

	Ns Riferim. Our Ref.	Rif. Costr. O.E. Ref.	Descrizione/Tipo di veicolo Description/Vehicle Type
	<p>101041</p>	<p>42471164</p>	<p><i>Serie tasselli attacco anteriore cabina</i> <i>Kit dowels anchoring front cabin</i></p> <p>Daily City 2000 65C13/C15</p>
	<p>101042</p>	<p>42471165</p>	<p><i>Serie tasselli attacco anteriore cabina</i> <i>Kit dowels anchoring front cabin</i></p> <p>Daily City 2000 65C11/C13/C15</p>
	<p>101043</p>	<p>42536919 42546400</p>	<p><i>Serie tasselli attacco anteriore cabina</i> <i>Kit dowels anchoring front cabin</i></p> <p>Daily City 2000 35S9/S11/S13/S15 35C9/C11/C13/C15 50C11/C13/C15</p>

POMPA ELETTRICA ALZACABINA UNIVERSALE UNIVERSAL ELECTRIC TIPPING OVER CABIN PUMP

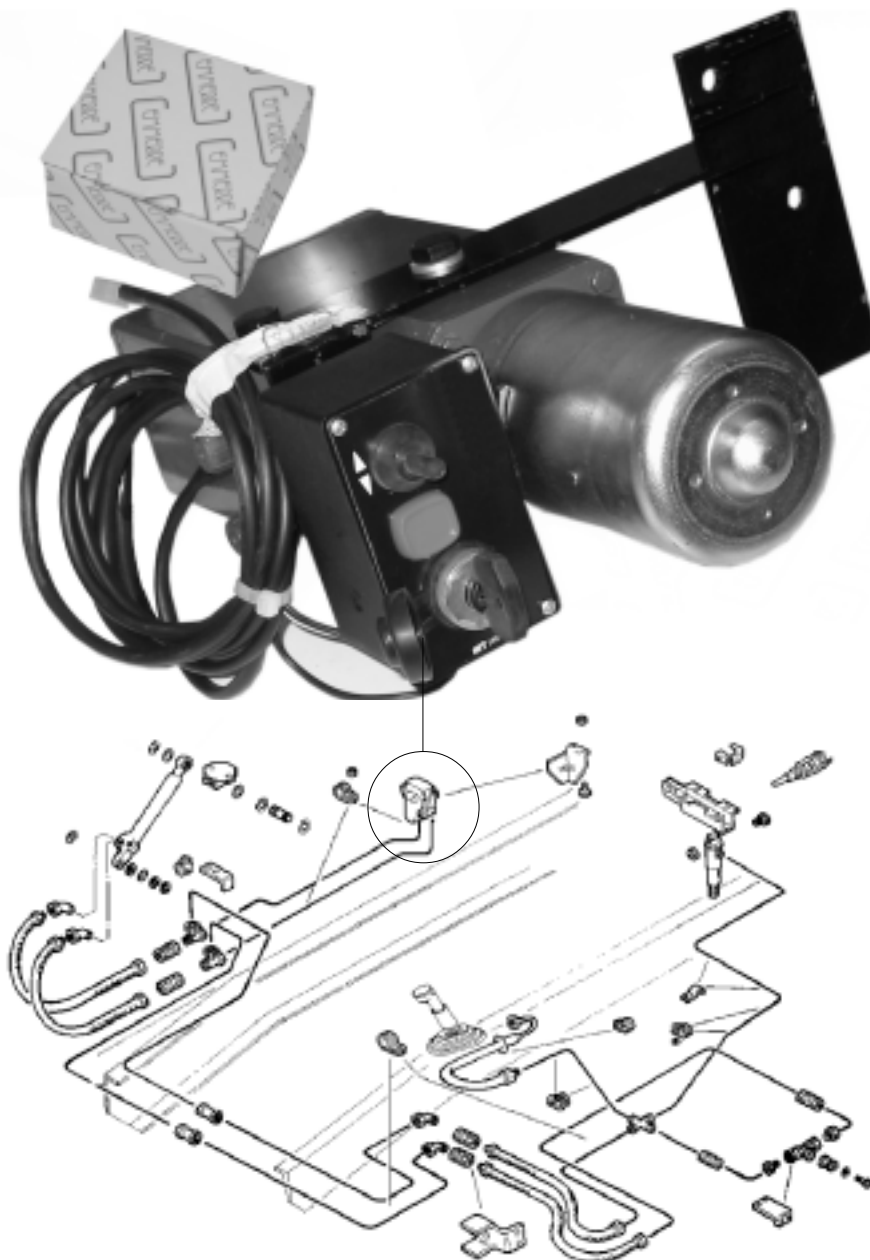

980025

Pompa elettrica alzacabina universale (**ALTA PRESSIONE**)
 Impianto **MATAIRCO POWER-PACKER**
 4727158-4774766-42108537-42085725-42108356
Universal electric tipping over cabin pump (HIGH PRESSURE)
 MATAIRCO POWER-PACKER system
 4727158-4774766-42108537-42085725-42108356







190 - 330 T.T.
EUROCARGO - EUROTECH - EUROSTAR
SCANIA - VOLVO - MERCEDES - RENAULT

980026

Pompa elettrica alzacabina universale (**BASSA PRESSIONE**)
 Impianto **WEBER 42073349**
Universal electric tipping over cabin pump (LOW PRESSURE)
 WEBER system 42073349

190 - 330 T.T.
EUROCARGO - EUROTECH - EUROSTAR
SCANIA - VOLVO - MERCEDES - RENAULT

Illustrazione <i>Illustration</i>	Ns.Rif. <i>Our Ref.</i>	Rif.Costr. <i>O.E. Ref.</i>	Descrizione <i>Description</i>	Tipo di veicolo <i>Vehicle Type</i>
	975013	42073349	Pompa alzacabina manuale Impianto WEBER <i>Manual tipping over cabin pump WEBER system</i>	TURBOSTAR 190 T.T. TURBOTECH 190 T.T.
	975000	2994022	Pompa alzacabina <i>Tipping over cabin pump</i>	TURBOSTAR 190.36/42/48
	973220	1908861	Pompa alzacabina <i>Tipping over cabin pump</i>	TURBOSTAR 190.36/42/48
	975001	1908460	Pompa alzacabina <i>Tipping over cabin pump</i>	EUROCARGO 60-65E10/E12/E14 75E12/E14/E15 80-100E15/E18/E21 120-130-170E15/E18/E23 150E15/E18/E23/E27 260E23 - 280E23
	975002	500316981	Pompa alzacabina <i>Tipping over cabin pump</i>	EUROCARGO TECTOR 75E13/E15/E17/E18 100E17/E18/E21 120E17/E21 130E18/E24/E28 150E18/E24/E28 180E21/E24/E28
	975003	99458304	Pompa alzacabina <i>Tipping over cabin pump</i>	EUROTECH EUROSTAR EUROTRAKKER CURSOR
	975004	98455864	Pompa alzacabina <i>Tipping over cabin pump</i>	EUROTECH EUROSTAR EUROTRAKKER

Illustrazione <i>Illustration</i>	Ns.Rif. <i>Our Ref.</i>	Rif.Costr. <i>O.E. Ref.</i>	Descrizione <i>Description</i>	Tipo di veicolo <i>Vehicle Type</i>
	975006	42108342	Cilindro alzacabina <i>Tipping over cabin cylinder</i>	TURBOTECH 190.26/36 240.26/36 - 260.36
	975007	42108356	Cilindro alzacabina <i>Tipping over cabin cylinder</i>	TURBOSTAR 190.36/42/48 240.36/48 - 260.36/48
	975009	98427951	Cilindro alzacabina <i>Tipping over cabin cylinder</i>	EUROCARGO EUROCARGO TECTOR
	975010	504062817 500337311	Cilindro alzacabina <i>Tipping over cabin cylinder</i>	EUROTECH EUROSTAR EUROTRAKKER CURSOR
	975022	504065532	Cilindro alzacabina <i>Tipping over cabin cylinder</i>	STRALIS 190-260-440
	975021	8162377	Tirante comando valvola livellatrice sospensione cabina <i>Control valve tie rod for cabin suspension leveller</i>	GAMMA EURO CURSOR STRALIS

Barra torsione cabina Cabin torsion bar

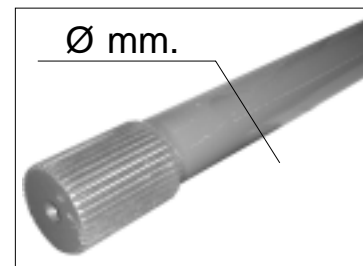
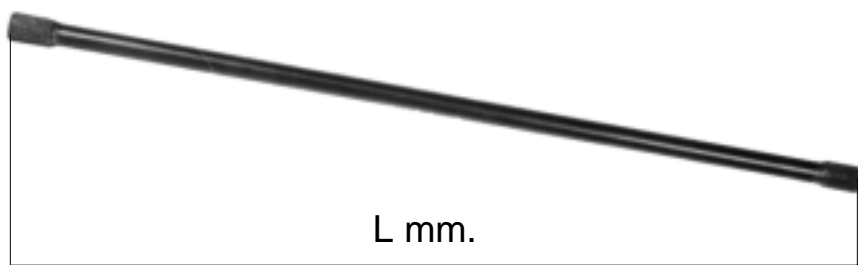

Ns. Riferimento Ns. Ref.	L mm.	Ø mm.	Applicazione Application
975054	1000	27	TURBOSTAR 190.36 - 190.42 - 190.48 240.36 - 240.48 260.36 - 260.48
Rif. Costruttore OE. Ref.			
42070266			
980019	830	26	EUROCARGO EUROCARGO TECTOR
Rif. Costruttore OE. Ref.			
98418616			
975073	1070	30	EUROTECH EUROTECH CURSOR EUROTRAKKER EUROTRAKKER CURSOR
Rif. Costruttore OE. Ref.			
41012353			
975072	1070	35	EUROSTAR EUROSTAR CURSOR
Rif. Costruttore OE. Ref.			
41012352			

Illustrazione <i>Illustration</i>	Ns.Rif. <i>Our Ref.</i>	Rif.Costr. <i>O.E. Ref.</i>	Descrizione <i>Description</i>	Tipo di veicolo <i>Vehicle Type</i>
	975058	42106070	Leva cabina Dx <i>Cabin lever right</i>	TURBOSTAR 190.36/42/48 - 240-260.36/48 TURBOTECH 240.36
	975057	42106069	Leva cabina Sx <i>Cabin lever left</i>	TURBOSTAR 190.36/42/48 - 240-260.36/48 TURBOTECH 240.36
	980010	42105790	Supporto ancoraggio cabina <i>Anchor cabin support</i>	TURBOSTAR 190.36/42/48 - 240-260.36/48 TURBOTECH 240.36
	975059	98411635	Leva cabina Dx <i>Cabin lever right</i>	EUROCARGO EUROCARGO TECTOR
	975060	98411636	Leva cabina Sx <i>Cabin lever left</i>	EUROCARGO EUROCARGO TECTOR
	975020	98416703	Mensola di ancoraggio DX e SX <i>Anchor bracket right and left</i>	EUROCARGO EUROCARGO TECTOR

Illustrazione <i>Illustration</i>	Ns.Rif. <i>Our Ref.</i>	Rif.Costr. <i>O.E. Ref.</i>	Descrizione <i>Description</i>	Tipo di veicolo <i>Vehicle Type</i>
	975026	41022085	Leva cabina Dx <i>Cabin lever right</i>	EUROTECH EUROTECH CURSOR EUROSTAR EUROSTAR CURSOR EUROTRAKKER EUROTRAKKER CURSOR
	975025	41022082	Leva cabina Sx <i>Cabin lever left</i>	EUROTECH EUROTECH CURSOR EUROSTAR EUROSTAR CURSOR EUROTRAKKER EUROTRAKKER CURSOR
	975027	500398040	Mensola di ancoraggio DX e SX <i>Anchor bracket right and left</i> (ex 41015449)	EUROTECH EUROTECH CURSOR EUROSTAR EUROSTAR CURSOR EUROTRAKKER EUROTRAKKER CURSOR
	975050	41019150	Cella sospensione pneumatica cabina <i>Air bellows</i>	EUROTECH CURSOR EUROSTAR CURSOR EUROTRAKKER CURSOR
	101045	42052453	Molla posteriore cabina gommata <i>Rear spring cabin rubber</i>	TURBOTECH 190.24/26/30/32/36 220.36 - 240.26/36 260.32/36











Illustrazione <i>Illustration</i>	Ns.Rif. <i>Our Ref.</i>	Rif.Costr. <i>O.E. Ref.</i>	Descrizione <i>Description</i>	Tipo di veicolo <i>Vehicle Type</i>
	980012	99447540	Molla cabina / <i>Cabin spring</i>	EUROCARGO 80-100-120 (Cabina corta) (Slow cabin)
	980015	99447541	Molla cabina / <i>Cabin spring</i>	EUROCARGO 80-100-120 (Cabina corta) (Short cabin)
	980016	99447542	Molla cabina / <i>Cabin spring</i>	EUROCARGO 80-100-120 (Cabina lunga) (Short cabin)
	980017	99447543	Molla cabina / <i>Cabin spring</i>	EUROCARGO 80-100-120 (Cabina lunga) (Long cabin)
	973010	42070618	Molla cabina / <i>Cabin spring</i>	TURBOSTAR 190.38/42
	980013	42126981	Molla cabina / <i>Cabin spring</i>	TURBOSTAR 190.48
	980014	41001890	Molla cabina / <i>Cabin spring</i> (fino a telaio 173225) (Up to chassis 173225)	EUROTECH - EUROTRAKKER (Sospensione meccanica) (Mechanical suspension)
	980011	41019147	Molla cabina / <i>Cabin spring</i> (da telaio 173226) (From chassis 173226)	EUROTECH - EUROTRAKKER (Sospensione meccanica) (Mechanical suspension)

Illustrazione <i>Illustration</i>	Ns.Rif. <i>Our Ref.</i>	Rif.Costr. <i>O.E. Ref.</i>	Descrizione <i>Description</i>	Tipo di veicolo <i>Vehicle Type</i>
	101055	-	Silentblock cabina NS mod. composto da - complete of: Silentblock rif. 8139012 Boccola rif. 8139013 <i>Cabin silentblock our modif.</i>	EUROCARGO 80-100-120E15/E18/E21 130E15/E18/E23 150E15/E18/E23/E27-180E21 260E23 - 280E23 - 320E27
	101039	42070674	Silentblock cabina <i>Cabin silentblock</i>	EUROCARGO 80-100-120E15/E18/E21 130E15/E18/E23 150E15/E18/E23/E27 - 180E21 260E23 - 280E23 - 320E27 TURBOSTAR 190.36/42/48 - 240-260.36/48 TURBOTECH 240.36
	100947	500398363	Silentblock cabina <i>Cabin silentblock</i>	EUROCARGO TECTOR EUROTRAKKER CURSOR STRALIS
	100948	500398364	Silentblock cabina <i>Cabin silentblock</i>	EUROCARGO TECTOR EUROTRAKKER CURSOR STRALIS
	101034	8141581	Silentblock cabina <i>Cabin silentblock</i>	EUROCARGO
	101040	42105574	Silentblock cabina <i>Cabin silentblock</i>	TURBOSTAR 190.36/42/48 - 240-260.36/48 TURBOTECH 240.36
	101006	4694227	Silentblock cabina <i>Cabin silentblock</i>	170 - 190

Illustrazione <i>Illustration</i>	Ns.Rif. <i>Our Ref.</i>	Rif.Costr. <i>O.E. Ref.</i>	Descrizione <i>Description</i>	Tipo di veicolo <i>Vehicle Type</i>
	101047	500331831 1908675	Silentblock cabina <i>Cabin silentblock</i>	EUROTECH EUROTECH CURSOR EUROSTAR EUROSTAR CURSOR EUROTRAKKER EUROTRAKKER CURSOR
	101048	41009544	Silentblock cabina <i>Cabin silentblock</i>	EUROTECH EUROTECH CURSOR EUROSTAR EUROSTAR CURSOR EUROTRAKKER EUROTRAKKER CURSOR
	101049	42070675	Base di gomma <i>Rubber plate</i>	EUROCARGO 80-100-120E15/E18/E21 130E15/E18/E23 150E15/E18/E23/E27 - 180E21 260E23 - 280E23 - 320E27 TURBOSTAR 190.36/42/48 - 240-260.36/48 TURBOTECH 240.36
	101007	500357265	Silentblock cabina <i>Cabin silentblock</i>	STRALIS
	101010	500351393	Silentblock cabina <i>Cabin silentblock</i>	STRALIS
	101031	504021532	Boccola cabina <i>Cabin silentblock</i>	STRALIS

RIBALTAMENTO CABINA E COMPONENTI TIPPING OVER CABIN AND COMPONENTS

Illustrazione <i>Illustration</i>	Ns.Rif. <i>Our Ref.</i>	Rif.Costr. <i>O.E. Ref.</i>	Descrizione <i>Description</i>	Tipo di veicolo <i>Vehicle Type</i>
 <p>Ø 40 x 65 x 31</p>	100952	9425000050	Silentblock cabina Cabin silentblock	MERCEDES
	100954	9423100049	Silentblock cabina Cabin silentblock	MERCEDES
 <p>Ø 16 x 46,7 x 64</p>	101016	9423172312	Boccola silentblock cabina Cabin silentblock	MERCEDES ACTROS
	973068	9423172012	Boccola cabina Cabin silentblock	MERCEDES ACTROS ACTROS 2031-2035-2040 2548-2631-2653-2657-3231 3235-3240-3243-3331-3343 3348-4140-4143 ACTROS 2003
 <p>Ø 12 x 40 x 41,5</p>	100955	5010269380	Silentblock cabina Cabin silentblock	RENAULT

Illustrazione <i>Illustration</i>	Ns.Rif. <i>Our Ref.</i>	Rif.Costr. <i>O.E. Ref.</i>	Descrizione <i>Description</i>	Tipo di veicolo <i>Vehicle Type</i>
 <p>Ø 12 x 40 x 42</p>	100961	5000789265	Silentblock cabina Cabin silentblock	RENAULT
 <p>Ø 16,5 x 60,5 x 68</p>	100962	5010316015	Silentblock cabina Cabin silentblock	RENAULT MIDLUM PREMIUM KERAX
	100963	1744211 1426202	Silentblock cabina Cabin silentblock	SCANIA

RIBALTAMENTO CABINA E COMPONENTI TIPPING OVER CABIN AND COMPONENTS



Illustrazione <i>Illustration</i>	Ns.Rif. <i>Our Ref.</i>	Rif.Costr. <i>O.E. Ref.</i>	Descrizione <i>Description</i>	Tipo di veicolo <i>Vehicle Type</i>
	100001	41028594	Tassello gomma cabina <i>Cabin dowel</i>	EUROTECH EUROSTAR EUROTRAKKER CURSOR STRALIS
	100034	41003278	Tassello appoggio ralla cabina <i>Cabin thrust ring dowel</i>	EUROCARGO EUROTECH EUROSTAR EUROTRAKKER
	980112	61590479	Supporto sostegno cilindro alzacabina <i>Cabin cylinder support</i>	110 (cabina ribaltabile)
	980113	61590492	Supporto sostegno cilindro alzacabina <i>Cabin cylinder support</i>	110 (cabina ribaltabile) 175.17/24
	101021	5010316874	Tampone cabina <i>Cabin buffer</i>	RENAULT KERAX - PREMIUM

Ns. Riferimento
Ns. Ref.

973190

Rif. Costruttore
OE. Ref.

1755638



Applicazione
Application

SCANIA
164L580

Descrizione - Tipo di applicazione
Description - Application type

KIT REVISIONE CABINA
CABIN REPAIRING KIT

Ns. Riferimento
Ns. Ref.

973210

Rif. Costruttore
OE. Ref.

1742449



Applicazione
Application

SCANIA
164L580

Descrizione - Tipo di applicazione
Description - Application type

KIT REVISIONE CABINA
CABIN REPAIRING KIT



Illustrazione <i>Illustration</i>	Ns.Rif. <i>Our Ref.</i>	Rif.Costr. <i>O.E. Ref.</i>	Descrizione <i>Description</i>	Tipo di veicolo <i>Vehicle Type</i>
	975015	41028764	Ammortizzatore cabina con molla Ø 16/16 <i>Cabin shock absorber with spring Ø 16/16</i>	EUROTECH EUROSTAR EUROTRAKKER
	975014	500307338	Ammortizzatore cabina con molla Ø 16 / M16x2 <i>Cabin shock absorber with spring Ø 16/16</i>	EUROTECH EUROSTAR EUROTRAKKER CURSOR
	973148	500357351	Ammortizzatore cabina <i>Cabin shock absorber</i>	STRALIS AS 260 AS 440

Illustrazione <i>Illustration</i>	Ns.Rif. <i>Our Ref.</i>	Rif.Costr. <i>O.E. Ref.</i>	Descrizione <i>Description</i>	Tipo di veicolo <i>Vehicle Type</i>
	975032	81.41722.6048 81.41722.6051	Ammortizzatore cabina con molla Ø 14 / M12x1,5 <i>Cabin shock absorber with spring</i>	MAN F2000

Illustrazione <i>Illustration</i>	Ns.Rif. <i>Our Ref.</i>	Rif.Costr. <i>O.E. Ref.</i>	Descrizione <i>Description</i>	Tipo di veicolo <i>Vehicle Type</i>
	975046	9428900219 9428906019	Ammortizzatore cabina con molla Ø 14/14 <i>Cabin shock absorber with spring</i>	MERCEDES ACTROS 1831-1835-1840-1843-1848 1853-1857-2031-2035-2040 2053-2531-2535-2540-2543 2548-2553-2557-2631-2635 2640-2643-2648-2653-2657 3231-3235-3240-3243-3331 3335-3340-3343-3348-3353 3357-4140-4143-4148 ACTROS 2003 1832-18361841-1844-1846 1850-1854-1858-2032-2632 2636-2641-2644-2646-2650 2654-2658
	975033	9428905919 9428905319	Ammortizzatore cabina con molla Ø 25/14 <i>Cabin shock absorber with spring</i>	MERCEDES ACTROS 1831-1835-1840-1843-1848 1853-1857-2031-2035-2040 2053-2531-2535-2540-2543 2548-2553-2557-2631-2635 2640-2643-2648-2653-2657 3231-3235-3240-3243-3331 3335-3340-3343-3348-3353 3357-4140-4143-4148 ACTROS 2003 1832-18361841-1844-1846 1850-1854-1858-2032-2632 2636-2641-2644-2646-2650 2654-2658
	975053	9428902919 9428900119	Ammortizzatore cabina con molla Ø 25/14 <i>Cabin shock absorber with spring</i>	MERCEDES ACTROS 1831-1835-1840-1843-1848 1853



Illustrazione <i>Illustration</i>	Ns.Rif. <i>Our Ref.</i>	Rif.Costr. <i>O.E. Ref.</i>	Descrizione <i>Description</i>	Tipo di veicolo <i>Vehicle Type</i>
	975011	5010320096	Molla aria cabina Ø 16 / M16x1.5/225 <i>Cabin air spring</i>	RENAULT MAGNUM AE 385/390/420/430/470 AE520/560 E.TECH 400/440/480
	975012	5010130797 5010629414	Molla aria cabina Ø 92x125 <i>Cabin air spring</i>	RENAULT PREMIUM DISTRIBUTION PREMIUM ROUTE KERAX

Illustrazione <i>Illustration</i>	Ns.Rif. <i>Our Ref.</i>	Rif.Costr. <i>O.E. Ref.</i>	Descrizione <i>Description</i>	Tipo di veicolo <i>Vehicle Type</i>
	975019	1348121	Ammortizzatore cabina con molla Ø 97x263 <i>Cabin shock absorber with spring</i>	SCANIA SERIE 3 93-113-143
	975023	1476415 1381919	Ammortizzatore cabina con molla Ø 90x249 <i>Cabin shock absorber with spring</i>	SCANIA SERIE 4 94-114-124-144-164
	975016	1349840	Ammortizzatore cabina con molla Ø 93x256 <i>Cabin shock absorber with spring</i>	SCANIA (4°serie) SERIE 4 94-114-124-144-164
	975018	1424231	Ammortizzatore cabina con molla Ø 93x275 <i>Cabin shock absorber with spring</i>	SCANIA (4°serie) SERIE 4 94-114-124-144-164

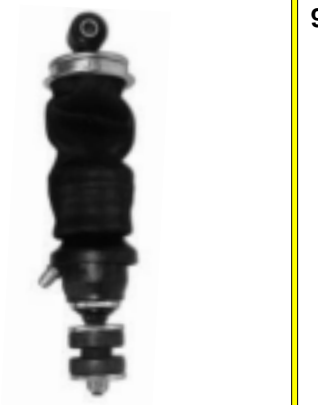

Illustrazione <i>Illustration</i>	Ns.Rif. <i>Our Ref.</i>	Rif.Costr. <i>O.E. Ref.</i>	Descrizione <i>Description</i>	Tipo di veicolo <i>Vehicle Type</i>
	973221	20889134 20721169 1076855	Ammortizzatore cabina con molla Ø 14/14 <i>Cabin shock absorber with spring</i>	VOLVO FM9 - FM12 FH12 - FH16
	975055	1075076 1075077	Ammortizzatore cabina con molla Ø 14/14 <i>Cabin shock absorber with spring</i>	VOLVO FH12 - FH16
	975065	3172964 1629719 1629724	Ammortizzatore cabina con molla Ø 20/14 <i>Cabin shock absorber with spring</i>	VOLVO FH12 - FH16



Illustrazione <i>Illustration</i>	Ns.Rif. <i>Our Ref.</i>	Rif.Costr. <i>O.E. Ref.</i>	Descrizione <i>Description</i>	Tipo di veicolo <i>Vehicle Type</i>
	900222	113811	Prigioniero M16 x 1,5 x 370 <i>Stud M16 x 1,5 x 370</i>	OM - LEONCINO - LUPETTO DAINO - TIGROTTO - CO3D
	900223	554876	Prigioniero M16 x 1,5 x 353,5 <i>Stud M16 x 1,5 x 353,5</i>	OM - LEONCINO - LUPETTO DAINO - TIGROTTO - CO3D
	900233	8504683	Prigioniero M16 x 1,5 x 337 <i>Stud M16 x 1,5 x 337</i>	OM - LEONCINO - LUPETTO DAINO - TIGROTTO - CO3D
	900234	8504930	Prigioniero M16 x 1,5 x 315 <i>Stud M16 x 1,5 x 315</i>	OM - LEONCINO - LUPETTO DAINO - TIGROTTO - CO3D
	900224	555783	Prigioniero M16 x 1,5 x 297 <i>Stud M16 x 1,5 x 297</i>	OM - LEONCINO - LUPETTO CO2
	900225	4718317	Prigioniero M16 x 1,5 x 333,5 <i>Stud M16 x 1,5 x 333,5</i>	OM - 50 - 55 - LUPETTO A15 TIGROTTO
	900226	4718320	Prigioniero M16 x 1,5 x 319,5 <i>Stud M16 x 1,5 x 319,5</i>	OM - 50 - 55 - LUPETTO A15 TIGROTTO
	900227	98444872	Prigioniero M16 x 1,5 x 315 (ex. 4718323) <i>Stud M16 x 1,5 x 315</i>	OM - 50 - 55 - LUPETTO A15 TIGROTTO
	900228	4720310	Prigioniero M16 x 1,5 x 305,5 <i>Stud M16 x 1,5 x 305,5</i>	OM - 50 - 55 - LUPETTO A15 TIGROTTO
	900229	98444904	Prigioniero M16 x 1,5 x 158,5 <i>Stud M16 x 1,5 x 158,5</i>	50 - 55 - 60 - 65 - 70 - 75
	900230	8827057	Prigioniero M16 x 1,5 x 314,5 <i>Stud M16 x 1,5 x 314,5</i>	50 - 55 - 60 - 65 - 70 - 75
	900231	8827066	Prigioniero M16 x 1,5 x 285 <i>Stud M16 x 1,5 x 285</i>	50 - 55 - 60 - 65 - 70 - 75
	900232	8827086	Prigioniero M16 x 1,5 x 300 <i>Stud M16 x 1,5 x 300</i>	50 - 55 - 60 - 65 - 70 - 75
	900235	4720307	Prigioniero M16 x 1,5 x 306 RINFORZATO <i>Stud M16 x 1,5 x 306</i> REINFORCED	130 CP3
	900210	4713556	Dado cieco per prigioniero testa cilindrica M16 x 1,5 <i>Blind nut cylindrical head</i> <i>M 16 x 1,5</i>	OM 50 - 55 - 60 - 65 - 70 - 75





Illustrazione <i>Illustration</i>	Ns.Rif. <i>Our Ref.</i>	Rif.Costr. <i>O.E. Ref.</i>	Descrizione <i>Description</i>	Tipo di veicolo <i>Vehicle Type</i>
	902293	4733350	Punteria valvole Ø 44 mm. <i>Tappet valve Ø 44 mm.</i>	DAILY RESTYLING 30.8 - 35.8 - 40.8 NEW DAILY 30.8-35.8-40.8 - 35-45-49.10 TURBODAILY 30.10-49.10-35.12-49.12-59.12 DAILY CITY 2000 35S9/S11/S13 - 35C9/C11/C13 50C11/C13 - 65C13/C15
	902290	4693033	Punteria valvole Ø 14 mm. <i>Tappet valve Ø 14 mm.</i> (AD ESAURIMENTO)	50 - 80 - 90 - 110NC
	902289	98471524	Punteria valvole Ø 15 mm. <i>Tappet valve Ø 15 mm.</i>	ZETA TURBOZETA
	902291	4753580	Punteria valvole Ø 27 mm. <i>Tappet valve Ø 27 mm.</i>	673 - 130 - OM50 - CO3
	902288	576615	Punteria valvole Ø 26 mm. <i>Tappet valve Ø 26 mm.</i>	615N1 - 241TN
	902285	569308	Punteria valvole Ø 28 mm. <i>Tappet valve Ø 28 mm.</i>	645 - 650

Illustrazione <i>Illustration</i>	Ns.Rif. <i>Our Ref.</i>	Rif.Costr. <i>O.E. Ref.</i>	Descrizione <i>Description</i>	Tipo di veicolo <i>Vehicle Type</i>
	902295	4672175	Canotto punterie <i>Liner</i>	TURBOSTAR 190.35/38/42/48 - 240-260.48 330.35
	902930	-	Canotto punterie completo di anelli <i>Liner complete with washer</i>	EUROSTAR 190-240-260-400-440E52
	901245	4672177	Anello per canotto punterie <i>Liner washer</i>	TURBOSTAR 190.35/38/42/48 - 240-260.48 330.35 EUROSTAR 190-240-260-400-440E52
	902925	4679070	Astuccio portainiettori <i>Injector holder</i>	684 - 619 - 697 190.26H 330.26 - AP160 - 370S25L
	902908	4770859	Astuccio portainiettori <i>Injector holder</i>	ZETA 50.9-65.9-79-95-109.14 TURBOZETA 60.11-65-79.12 115-135.14/17 - 145-175.17 EUROCARGO 60-65E10/E12/E14 75E12/E14/E15 80E15/E18/E21 - 95E15/E18 100E15/E18/E21 120-130E15/E18/E23-135E23 150-170E15/E18/E23-180E21 260E23 - 280E23

Illustrazione Illustration	Ns.Rif. Our Ref.	Rif.Costr. O.E. Ref.	Descrizione Description	Tipo di veicolo Vehicle Type								
<p>A = Ø esterno</p> <p>B = Ø interno</p> <p>Z = Numero di denti</p> <p>H = Spessore</p>	901153	4279804	Corona volano <i>Flywheel rim</i> <table border="1"> <thead> <tr> <th>A</th> <th>B</th> <th>H</th> <th>Z</th> </tr> </thead> <tbody> <tr> <td>335</td> <td>306</td> <td>12</td> <td>119</td> </tr> </tbody> </table>	A	B	H	Z	335	306	12	119	DAILY RESTYLING 30-35-40.8 - 35-45-49.10 NEW DAILY 30-35-40.8 - 35-45-49.10 TURBODAILY 30.10-49.10 - 35-49-59.12 DAILY 2000 35S9/S11/S13 50C11/C13/C15 - 65C13/C15
	A	B	H	Z								
	335	306	12	119								
	901152	8819789	Corona volano <i>Flywheel rim</i> <table border="1"> <thead> <tr> <th>A</th> <th>B</th> <th>H</th> <th>Z</th> </tr> </thead> <tbody> <tr> <td>395</td> <td>356</td> <td>18</td> <td>130</td> </tr> </tbody> </table>	A	B	H	Z	395	356	18	130	OM - LEONCINO - LUPETTO OM50/55
A	B	H	Z									
395	356	18	130									
901159	8819718	Corona volano <i>Flywheel rim</i> <table border="1"> <thead> <tr> <th>A</th> <th>B</th> <th>H</th> <th>Z</th> </tr> </thead> <tbody> <tr> <td>395</td> <td>356</td> <td>18</td> <td>130</td> </tr> </tbody> </table>	A	B	H	Z	395	356	18	130	OM - TIGROTTO - OM50-60 329A BUS	
A	B	H	Z									
395	356	18	130									
901154	4602143	Corona volano <i>Flywheel rim</i> <table border="1"> <thead> <tr> <th>A</th> <th>B</th> <th>H</th> <th>Z</th> </tr> </thead> <tbody> <tr> <td>335</td> <td>292</td> <td>15</td> <td>110</td> </tr> </tbody> </table>	A	B	H	Z	335	292	15	110	50 - 55 F8/F9 ZETA 50.9 - 65.9	
A	B	H	Z									
335	292	15	110									
	901160	4862411 4704106	Corona volano <i>Flywheel rim</i> <table border="1"> <thead> <tr> <th>A</th> <th>B</th> <th>H</th> <th>Z</th> </tr> </thead> <tbody> <tr> <td>395</td> <td>355</td> <td>18</td> <td>130</td> </tr> </tbody> </table>	A	B	H	Z	395	355	18	130	ZETA 79.14 - 95.14 - 109.14 TURBOZETA 65.12 - 79.12 115-135.14/17 - 145.17 EUROCARGO 60-65E10/E12/E14 75E12/E14E/15 95E15/E18/E21 80-100-120E15/E18/E21 120-260-280E23 - 180E21 130-150E15/E18/E23 135E18/E23 170E15/E18/E23/E27
A	B	H	Z									
395	355	18	130									

Illustrazione Illustration	Ns.Rif. Our Ref.	Rif.Costr. O.E. Ref.	Descrizione Description	Tipo di veicolo Vehicle Type								
<p>A = Ø esterno</p> <p>B = Ø interno</p> <p>Z = Numero di denti</p> <p>H = Spessore</p>	901156	4602203	Corona volano <i>Flywheel rim</i>	80-90-100NC-645-650-662-672 BUS 314 - 314/2 - 314/3 TURBOZETA 60.11 - 316S								
			<table border="1"> <thead> <tr> <th>A</th> <th>B</th> <th>H</th> <th>Z</th> </tr> </thead> <tbody> <tr> <td>386.5</td> <td>343</td> <td>15</td> <td>127</td> </tr> </tbody> </table>	A	B	H	Z	386.5	343	15	127	
	A	B	H	Z								
	386.5	343	15	127								
901157	4718356	Corona volano (ex. 4603795) <i>Flywheel rim</i>	TURBOTECH 190.30/36 - 220/240.36 TURBOSTAR 190-240-260.36 330.26/30/36 EUROTECH 180E42 190-240-260-400-440E42 EUROSTAR 180E42 190-240-260-400-440E42/E47 EUROTRAKKER 190E31/E37/E42 260E37/E42/E47 - 330E37 340E34/E37/E42 380E31/E37/E42/E47 400E31/E37/E42 410-440E37/E42 720E31/E37/E42/E47									
		<table border="1"> <thead> <tr> <th>A</th> <th>B</th> <th>H</th> <th>Z</th> </tr> </thead> <tbody> <tr> <td>473</td> <td>416</td> <td>25</td> <td>156</td> </tr> </tbody> </table>	A	B	H	Z	473	416	25	156		
A	B	H	Z									
473	416	25	156									
	901158	4672334	Corona volano <i>Flywheel rim</i>	EUROTECH 180E30/E34/E38 - 260E38 190-400E30/E34/E38 240-440E34/E38 EUROSTAR 180E38/E42 - 190E38/E52 240-400-440E38/E52 - 260E52 EUROTRAKKER 180E25 - 190E30/E34 260E30/E34 330-340-380-400-440E34 CITYCLASS - EUROCLASS EURORIDER								
			<table border="1"> <thead> <tr> <th>A</th> <th>B</th> <th>H</th> <th>Z</th> </tr> </thead> <tbody> <tr> <td>505</td> <td>455.5</td> <td>25</td> <td>167</td> </tr> </tbody> </table>	A	B	H	Z	505	455.5	25	167	
A	B	H	Z									
505	455.5	25	167									
	901151	99433386	Corona volano <i>Flywheel rim</i>	EUROTRAKKER STRALIS 440-260 EUROSTAR 440 CURSOR								
			<table border="1"> <thead> <tr> <th>A</th> <th>B</th> <th>H</th> <th>Z</th> </tr> </thead> <tbody> <tr> <td>496</td> <td>452</td> <td>22</td> <td>155</td> </tr> </tbody> </table>	A	B	H	Z	496	452	22	155	
A	B	H	Z									
496	452	22	155									

Illustrazione <i>Illustration</i>	Ns.Rif. <i>Our Ref.</i>	Rif.Costr. <i>O.E. Ref.</i>	Descrizione <i>Description</i>	Tipo di veicolo <i>Vehicle Type</i>
	906117	93827837 93811555 93825912	Filtro aria motore completo <i>Complete engine air filter</i>	NEW DAILY TURBODAILY
	913000	98420643	Coppa olio motore <i>Engine oil sump</i>	NEW DAILY 30.8-35.8-40.8-35.10 45.10-49.10 TURBODAILY 35.12-49.12-59.12 (ANNO1996)

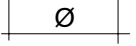



Illustrazione <i>Illustration</i>	Ns.Rif. <i>Our Ref.</i>	Rif.Costr. <i>O.E. Ref.</i>	Descrizione <i>Description</i>	Tipo di veicolo <i>Vehicle Type</i>
	906110	7301484	Sfiato olio motore <i>Engine oil breather</i>	DAILY RESTYLING 30-35-40.8 - 35-45-49.10 NEW DAILY 30-35-40.8 - 35-45-49.10 TURBODAILY 30.10
	906245	99441839	Sfiato olio motore <i>Engine oil breather</i>	NEW DAILY 30-35-40.8 - 35-45-49.10
	906116	500302200	Sfiato olio motore in plastica <i>Engine plastic oil breather</i>	NEW DAILY TURBODAILY
	906115	4624515	Sfiato olio motore <i>Engine oil breather</i>	616N3/N4 - OM40/35 50-55NC-80-90NC 100NC-110NC-130NC
	906120	4769877	Sfiato olio motore <i>Engine oil breather</i>	115-135.14

Illustrazione <i>Illustration</i>	Ns.Rif. <i>Our Ref.</i>	Rif.Costr. <i>O.E. Ref.</i>	Descrizione <i>Description</i>	Tipo di veicolo <i>Vehicle Type</i>
--------------------------------------	----------------------------	--------------------------------	-----------------------------------	--



906108 - Kit modifica sfiato olio motore
Engine oil breather modification kit

DAILY RESTYLING 35.10-49.10 - **NEW DAILY** 35.10-49.10 - **TURBODAILY** 35.12-49.12-59.12

	<p>906240</p>	<p>4736265</p>	<p>Guaina asta livello olio <i>Oil level tube</i> (AD ESAURIMENTO)</p>	<p>80-90-100NC - 75PC - 95PC</p>
	<p>906232</p>	<p>4647981</p>	<p>Guaina asta livello olio <i>Oil level tube</i> (AD ESAURIMENTO)</p>	<p>160NC - 684N</p>



Illustrazione <i>Illustration</i>	Ns.Rif. <i>Our Ref.</i>	Rif.Costr. <i>O.E. Ref.</i>	Descrizione <i>Description</i>	Tipo di veicolo <i>Vehicle Type</i>
	902365	4799472	Albero comando pompa iniezione <i>Injection pump spindle</i> (AD ESAURIMENTO)	619-697-300 TURBOSTAR 190.30/36 TURBOTECH 190.30/36-260.36 330.26/30/36 - AP160 - 370S30
	902374	4822328	Ingranaggio comando pompa iniezione <i>Injection pump driving gear</i> (AD ESAURIMENTO)	619-697-300 TURBOSTAR 190.30/36 TURBOTECH 190.30/36-260.36 330.26/30/36 - AP160 - 370S30
	902378	4706366	Supporto alternatore <i>Alternator support</i> (AD ESAURIMENTO)	AP160
	903040	98416091	Cavo comando acceleratore <i>Accelerator control cable</i>	EUROCARGO
	903039	41029915	Cavo comando acceleratore <i>Accelerator control cable</i>	EUROTRAKKER



Illustrazione <i>Illustration</i>	Ns.Rif. <i>Our Ref.</i>	Rif.Costr. <i>O.E. Ref.</i>	Descrizione <i>Description</i>	Tipo di veicolo <i>Vehicle Type</i>
	901216	500341808	Cinghia di comando <i>V-Belt</i>	EUROTECH CURSOR 190E39/E43 260-440E39/E43 EUROSTAR CURSOR 190E39/E43 260-440E39/E43 STRALIS 190S40/S43 - 260S40/S43 440S40/S43
	901217	500341810	Cinghia di comando <i>V-Belt</i>	EUROSTAR CURSOR 260E48 - 440E46/E48 EUROTRAKKER CURSOR 190E38/E44 260E38/E44/E48 340E38/E44 380E38/E44/E48 400E38/E44 410E38/E44/E48 440E38/E44 720E38/E44/E48
	901218	500328020	Cinghia di comando <i>V-Belt</i>	EUROTECH CURSOR 190E24/E31/E35 260E24/E31/E35 440E31/E35 EUROTRAKKER CURSOR 180E24/E27 190E24/E27/E31/E35 260E31/E35 340-380-400-410E35 STRALIS 190S27/S31/S35 260S27/S31/S35 440S35

Illustrazione <i>Illustration</i>	Ns.Rif. <i>Our Ref.</i>	Rif.Costr. <i>O.E. Ref.</i>	Descrizione <i>Description</i>	Tipo di veicolo <i>Vehicle Type</i>
	901220	7303414	Cinghia distribuzione DAYCO 152 denti RH 300 <i>Timing belt (152 teeth)</i>	DAILY RESTYLING 30.8-35.8-40.8
	901224	99456476	Cinghia distribuzione DAYCO 152 denti RHDS 300 <i>Timing belt (152 teeth)</i>	DAILY CITY 2000 35S13/S15 - 35C13/C15 50C13/C15 - 65C15 FIAT DUCATO RENAULT MASTER - TRAFIC
	901221	7303415	Cinghia distribuzione DAYCO 153 denti RHX 300 (fino a motore < 1307400) <i>Timing belt (153 teeth)</i> (Up to engine < 1307400)	DAILY RESTYLING 35.10 - 45.10 - 49.10 NEW DAILY 30-35-40.8 - 35-45-49.10
	901222	500323627	Cinghia distribuzione DAYCO (ex.98415921) 153 denti RHDS 300 (da motore > 1307401) <i>Timing belt (153 teeth)</i> (From engine < 1307401)	DAILY RESTYLING 35.10 - 45.10 - 49.10 NEW DAILY 30-35-40.8 - 35-45-49.10 TURBODAILY 35.10 - 35.12 - 49.12 - 59.12 DAILY 2000 35S9 - 35C9
	901223	99456477	Cinghia distribuzione DAYCO 154 denti RHDS 300H <i>Timing belt (154 teeth)</i>	TURBODAILY 96 30-35-49.10 - 35-49-59.12 DAILY 2000 35S11 - 35C11 - 50C11
	901239	500371975	Cinghia distribuzione DAYCO 178 denti <i>Timing belt (178 teeth)</i>	DAILY CITY 2000 35C10/C12 - 35S10/S12 29L10/L12

Illustrazione <i>Illustration</i>	Ns.Rif. <i>Our Ref.</i>	Rif.Costr. <i>O.E. Ref.</i>	Descrizione <i>Description</i>	Tipo di veicolo <i>Vehicle Type</i>
	901206	-	Kit cinghia e cuscinetti distribuzione composto da: <i>Kit belt and timing belt tightener composed by:</i>	DAILY RESTYLING 30.8-35.8-40.8 - 35-45-49.10 NEW DAILY 30-35-40.8 - 35-45-49.10 DAILY 2000 35S11/S13 - 35C11/C13 50C11/C13/C15 - 65C13/C15
	-	98421275	Guarnizione piana q.tà 1	
	-	98454051	Anello tenuta q.tà 1	
	901333	2992484	Cuscinetto motore q.tà 1	
	901336	2992485	Cuscinetto motore q.tà 1	
901220	7303414	Cinghia 152 denti q.tà 1		
	901205	-	Kit cinghia e tendicinghia distribuzione composto da: <i>Kit belt and timing belt tightener composed by:</i>	DAILY RESTYLING 30.8-35.8-40.8
	-	98421275	Guarnizione piana q.tà 1	
	-	98454051	Anello tenuta q.tà 1	
	901302	7301661	Tendicinghia inf. q.tà 1	
	901301	7301662	Tendicinghia sup. q.tà 1	
901220	7303414	Cinghia 152 denti q.tà 1		
	901210	-	Kit cinghia e cuscinetti distribuzione (fino a motore < 1307400) composto da: <i>Kit belt and timing belt tightener composed by: (Up to engine < 1307400)</i>	DAILY RESTYLING 30-35-40.8 - 35-45-49.10 NEW DAILY 30-35-40.8 - 35-45-49.10 TURBODAILY 35.10 - 35-49-59.12 DAILY 2000 35S9/S11/S13 - 35C9/C11/C13 50C11/C13 - 65C13/C15
	901221	7303415	Cinghia 153 denti q.tà 1	
	901333	2992484	Cuscinetto motore q.tà 2	
	-	98454051	Anello tenuta q.tà 1	
	-	98421275	Guarnizione piana q.tà 1	
	901211	-	Kit cinghia e cuscinetti distribuzione (da motore > 1307401) composto da: <i>Kit belt and timing belt tightener composed by: (From engine > 1307401)</i>	DAILY RESTYLING 30-35-40.8 - 35-45-49.10 NEW DAILY 30-35-40.8 - 35-45-49.10 TURBODAILY 35.10 - 35-49-59.12 DAILY 2000 35S9/S11/S13 - 35C9/C11/C13 50C11/C13 - 65C13/C15
	901222	500323627	Cinghia 153 denti q.tà 1	
	901333	2992484	Cuscinetto motore q.tà 2	
	-	98454051	Anello tenuta q.tà 1	
	-	98421275	Guarnizione piana q.tà 1	





Illustrazione <i>Illustration</i>	Ns.Rif. <i>Our Ref.</i>	Rif.Costr. <i>O.E. Ref.</i>	Descrizione <i>Description</i>	Tipo di veicolo <i>Vehicle Type</i>
	901214	-	Kit cinghia e cuscinetti distribuzione composto da: <i>Kit belt and timing belt tightener composed by:</i>	DAILY CITY 2000 35S9/S11/S13/S15 35C9/C11/C13/C15 50C11/C13/C15 65C13/C15
	901224	99456476	Cinghia 152 denti q.tà 1	
	901333	2992484	Cuscinetto motore q.tà 1	
	901336	2992485	Cuscinetto motore q.tà 1	
	-	98454051	Anello tenuta q.tà 1	
-	98421275	Guarnizione piana q.tà 1		
	901215	-	Kit cinghia e cuscinetti distribuzione composto da: <i>Kit belt and timing belt tightener composed by:</i>	TURBODAILY 96 30.10 - 35.10 - 49.10 59.12 DAILY CITY 2000 35S11 - 35C11 50C11
	901223	99456477	Cinghia 154 denti q.tà 1	
	901333	2992484	Cuscinetto motore q.tà 2	
	-	98454051	Anello tenuta q.tà 1	
	-	98421275	Guarnizione piana q.tà 1	
  	901337	2992485 4740847	Cuscinetto tendicinghia <i>Belt tightener bearing</i>	DAILY RESTYLING 30.8-35.8-40.8 NEW DAILY 30.8-35.8-35.10 DAILY 2000 35S11/S13 - 35C11/C13 50C11/C13/C15 - 65C13/C15
	901333	2992484 99432547	Cuscinetto tendicinghia <i>Belt tightener bearing</i>	DAILY RESTYLING 30-35-40.8 - 35-45-49.10 NEW DAILY 30-35-40.8 - 35-45-49.10 TURBODAILY 35.10 - 35-49-59.12 DAILY 2000 35S9/S11/S13 - 35C9/C11/C13 50C11/C13 - 65C13/C15
	901311	4279745	Tendicinghia <i>Belt tightener</i>	DAILY RESTYLING 30-35-40.8 - 35-45-49.10 NEW DAILY 30-35-40.8 - 35-45-49.10 TURBODAILY 35.10 - 35-49-59.12 DAILY 2000 35S9/S11/S13 - 35C9/C11/C13 50C11/C13 - 65C13/C15

Illustrazione <i>Illustration</i>	Ns.Rif. <i>Our Ref.</i>	Rif.Costr. <i>O.E. Ref.</i>	Descrizione <i>Description</i>	Tipo di veicolo <i>Vehicle Type</i>
	901300	504000412	Puleggia tendicinghia <i>Belt tightener pulley</i>	DAILY CITY 2000 35S10/S12 35C10/C12
	901305	500393575	Puleggia tendicinghia <i>Belt tightener pulley</i>	DAILY CITY 2000 35S10/S12 35C10/C12
	901306	500388688	Puleggia tendicinghia <i>Belt tightener pulley</i>	DAILY CITY 2000 35S10/S12 35C10/C12
	901301	7301662	Tendicinghia distribuzione con cuscinetto 2992484 (superiore) <i>Tining belt tightener with bearing 2992484 (upper)</i>	DAILY RESTYLING 30.8-35.8-40.8
	901302	7301661	Tendicinghia distribuzione con cuscinetto 2992485 (inferiore) <i>Tining belt tightener with bearing 2992485 (lower)</i>	DAILY RESTYLING 30.8-35.8-40.8

Illustrazione <i>Illustration</i>	Ns.Rif. <i>Our Ref.</i>	Rif.Costr. <i>O.E. Ref.</i>	Descrizione <i>Description</i>	Tipo di veicolo <i>Vehicle Type</i>
	901307	504010846	Puleggia tendicinghia <i>Belt tightener pulley</i>	DAILY CITY 2000 35S10/S12 35C10/C12
	901308	500332622 5010553544 5010284907	Tendicinghia completo <i>Complete belt tightener</i>	DAILY CITY 2000 35S9/S11/S13/S15 35C9/C11/C13/C15 50C11/C13/C15 65C13/C15 RENAULT MASCOTT 90-110-130-140
	901330	504086751	Tendicinghia completo <i>Complete belt tightener</i>	DAILY CITY 2000 35S10/S12 35C10/C12
	901345	504086948	Tendicinghia completo <i>Complete belt tightener</i>	DAILY MY 2006 35S15/S18 35C14/C5/C17/C18 50C14/C15/C18 65C15
	901314	4616156	Tendicinghia completo <i>Complete belt tightener</i>	79-80-90-100.13-110 95-109-110.14-645-650
	901303	4803462	Tendicinghia completo <i>Complete belt tightener</i>	ZETA 79.14 - 95.14 - 109.14 TURBOZETA 65.12 - 79.12 115-135.14/17 - 175.17

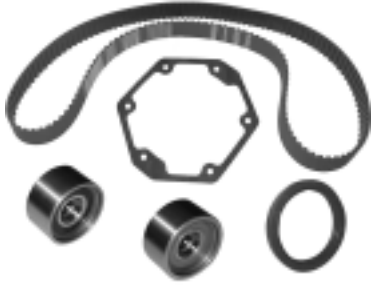
Illustrazione <i>Illustration</i>	Ns.Rif. <i>Our Ref.</i>	Rif.Costr. <i>O.E. Ref.</i>	Descrizione <i>Description</i>	Tipo di veicolo <i>Vehicle Type</i>
	901315	4606784	Tendicinghia completo <i>Complete belt tightener</i>	643 - 684 - 160 - 690 - 160 180 - 619 - 697 - 300 - 170 180 - 190.26 - 190.30 TURBOTECH 190-330.30
	901316	4831072	Tendicinghia completo <i>Complete belt tightener</i>	TURBOSTAR 190-240-260.36 TURBOTECH 190-220-240-260.36
	901304	-	Tendicinghia completo <i>Complete belt tightener</i>	EUROCARGO Gamma E80-100-120-150
	901309	4891116	Tendicinghia completo in PLASTICA <i>Complete belt tightener</i> PLASTIC	EUROCARGO TECTOR TECTOR RESTYLING 75E13/E15/E17/E18 100E17/E18/E21 120E17/E21 130E18/E24/E28 150E18/E24/E28 180E21/E24/E28
	901331	504065874	Tendicinghia completo in FERRO <i>Complete belt tightener</i> IRON	EUROCARGO TECTOR

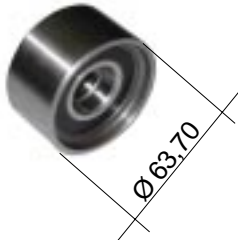
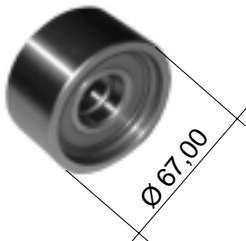



Illustrazione Illustration	Ns.Rif. Our Ref.	Rif.Costr. O.E. Ref.	Descrizione Description	Tipo di veicolo Vehicle Type
	901312	98480740 98485209	Tendicinghia completo <i>Complete belt tightener</i>	EUROTECH 180-190-240-260-400-440E42 EUROSTAR 190-240-400-440E42 EUOTRAKKER 190-400E31/E37/E42 260E37/E42 - 330-440E37 340-410E37/E42 380E31/E37/E42 720E31/E37/E42
	901332	504065877	Puleggia tendicinghia <i>Belt tightener pulley</i>	EUROCARGO TECTOR
	901338	504065878	Puleggia tendicinghia in FERRO <i>Belt tightener pulley</i> IRON	EUROCARGO TECTOR
	901323	4897031	Puleggia tendicinghia in PLASTICA <i>Belt tightener pulley</i> PLASTIC	EUROCARGO TECTOR TECTOR RESTYLING 75E13/E15/E17/E18 100E17/E18/E21 120E17/E21 130E18/E24/E28 150E18/E21/E24/E28 180E21/E24/E28
	901313	500301088	Tendicinghia completo <i>Complete belt tightener</i>	EUROTECH 180E42 - 190E42 - 240E42 260E42 - 400E42 - 440E42 EUROSTAR 180E42 - 190E42/E47 240E42/E47 - 260E42/E47 400E42/E47 - 440E42/E47 EUOTRAKKER 190E31/E37/E42 260E37/E42/E47 - 330E37 340E37/E42 380E31/E37/E42/E47 400E31/E37/E42 410E37/E42 - 440E37/E42 720E31/E37/E42

Illustrazione <i>Illustration</i>	Ns.Rif. <i>Our Ref.</i>	Rif.Costr. <i>O.E. Ref.</i>	Descrizione <i>Description</i>	Tipo di veicolo <i>Vehicle Type</i>
	901310	504006261	Puleggia tendicinghia <i>Belt tightener pulley</i>	EUROTECH 190-260-400-440 EUROSTAR 190-260-440 EUROTRAKKER - CURSOR 190-260-340-380-410 STRALIS 440S40/S43/S48/S54
	901317	504046191	Tendicinghia completo <i>Complete belt tightener</i>	EUROTECH 190-260-400 EUROSTAR 190-260-440 EUROTRAKKER - CURSOR 190-260-340-380-410 STRALIS 260S48/S54 440S40/S43/S48/S54
	901318	99449176	Tendicinghia completo <i>Complete belt tightener</i>	EUROTECH CURSOR 190E24/E32/E35 260E24/E31/E35 440E31/E35 EUROTRAKKER CURSOR 180E24/E27 190E24/E27/E31/E35 260E31/E35 340E35 - 380E35 STRALIS 190S27/S31/S35 260S27/S31/S35 440S35
	901319	500350419	Tendicinghia completo <i>Complete belt tightener</i>	EUROTECH CURSOR 190E39/E43 260E39/E43 440E39/E43 EUROSTAR CURSOR 190E39/E43 260E39/E43/E48 440E39/E43/E46/E48 EUROTRAKKER CURSOR 190E38/E44 260E38/E44/E48 340E44 - 380E38/E44/E48 400E38/E44 410E38/E44/E48 440E44 - 720E44/E48 STRALIS 190S40/S43/S48 260S40/S43/S44/S48/S54 440S40/S43/S48/S54



Illustrazione <i>Illustration</i>	Ns.Rif. <i>Our Ref.</i>	Rif.Costr. <i>O.E. Ref.</i>	Descrizione <i>Description</i>	Tipo di veicolo <i>Vehicle Type</i>
	901320	500346227	Tendicinghia completo <i>Complete belt tightener</i>	BUS CITYCLASS EUROCLASS EURORIDER
	901321	504029278	Tendicinghia completo <i>Complete belt tightener</i>	BUS CITYCLASS EUROCLASS EURORIDER





Illustrazione <i>Illustration</i>	Ns.Rif. <i>Our Ref.</i>	Rif.Costr. <i>O.E. Ref.</i>	Descrizione <i>Description</i>	Tipo di veicolo <i>Vehicle Type</i>
	901324	9062002070 9062001770	Tendicinghia completo <i>Complete belt tightener</i>	MERCEDES ATEGO I 712-715-812-815-817-917 1017-1215-1217-1317-1517 UNIMOG - VARIO
	901326	1383564	Puleggia tendicinghia <i>Belt tightener pulley</i>	SCANIA SERIE 114 (dal 05/96 from 05/96)
	901327	1545982 1503113	Tendicinghia completo <i>Complete belt tightener</i>	SCANIA SERIE 114 - 124 - 144 (dal 09/95 from 09/95)
	901328	1438743 1503115 APV1052	Tendicinghia completo <i>Complete belt tightener</i>	SCANIA SERIE 164 (dal 2000 from 2000)
	901329	3979980 5010550335	Tendicinghia completo <i>Complete belt tightener</i>	VOLVO FM10 - FM12 (dal 08/98 from 08/98) FH12 (dal 08/93 from 08/93) RENAULT PREMIUM - ROUTE 420.18T



Illustrazione <i>Illustration</i>	Ns.Rif. <i>Our Ref.</i>	Rif.Costr. <i>O.E. Ref.</i>	Descrizione <i>Description</i>	Tipo di veicolo <i>Vehicle Type</i>
	901512	-	Kit revisione scamb. di calore <i>Heat exchanger overhauling kit</i>	115 - 135.14/17
	901504	-	Kit revisione scamb. di calore <i>Heat exchanger overhauling kit</i>	170-190.33/35 330.30
	901543	-	Kit revisione scamb. di calore <i>Heat exchanger overhauling kit</i>	190.48 TURBOSTAR
	902000	4866350	Scambiatore di calore <i>Heat exchanger</i>	NEW DAILY T.T. TURBODAILY T.T.





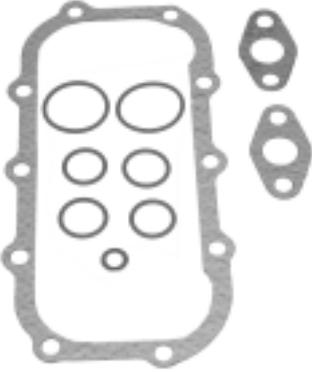
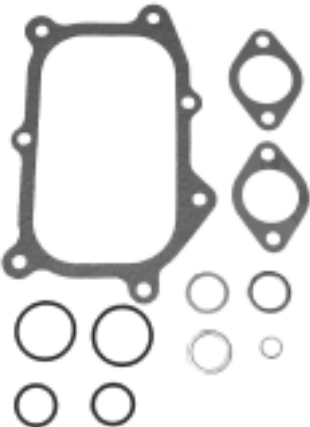

Illustrazione <i>Illustration</i>	Ns.Rif. <i>Our Ref.</i>	Rif.Costr. <i>O.E. Ref.</i>	Descrizione <i>Description</i>	Tipo di veicolo <i>Vehicle Type</i>
	902001	4774412	Candeletta pre-riscaldamento 12V <i>Pre-heater plug 12V</i>	DAILY T.T.
	902007	500314583 500303569	Termoavviatore <i>Thermo-starter</i>	DAILY CITY 2000 35C9/C11/C13 35S9/S11/S13 50C11/C13/C15 65C13/C15 DAILY M.Y. 2006
	902006	4724603	Termoavviatore 24V (ex. 4221168) <i>Thermo-starter</i>	AUTOCARRI T.T.
	902005	4724604	Termoavviatore 24V <i>Thermo-starter</i>	AUTOCARRI T.T.
	902004	4724601	Termoavviatore 24V <i>Thermo-starter</i>	AUTOCARRI T.T.
	902012	99444499 99450392	Termoavviatore <i>Thermo-starter</i>	BUS 370SE29 - AP160 AP160.12.26 EUROTECH EUROTRAKKER EUROSTAR EUROCLASS EURORIDER
	906206	4837950	Termocontatto 12 V <i>Switch 12V</i>	IVECO DAILY 30.8-35.8 (75cv) 35.10-49.10 (103cv) Duty 1991> (75cv)





Illustrazione <i>Illustration</i>	Ns.Rif. <i>Our Ref.</i>	Rif.Costr. <i>O.E. Ref.</i>	Descrizione <i>Description</i>	Tipo di veicolo <i>Vehicle Type</i>
	906207	99452677	Termocontatto <i>Switch 12V</i>	NEW DAILY 35.8 > 1996 TURBODAILY > 1996 30.10-35.10-49.10 35.12-49.12-59.12
	906208	9984319	Interruttore <i>Switch 12V</i>	IVECO DAILY 30.8-35.8 (75cv) 35.10-49.10 (103cv) Duty 30.8H 1991> (75cv)
	906222	4846676	Interruttore luci <i>Switch 12V</i>	DAILY 35.10 - 49.10 (103cv) 35.12 - 49.12 (116cv) > 1991
	906200	4856030	Interruttore luci <i>Switch 12V</i>	DAILY T.T. (96) EUROTECH EUROSTAR EUROTRAKKER CURSOR T.T. STRALIS
	906234	500388626 4840891	Interruttore emergenza luci <i>Light emergency switch</i>	EUROCARGO EUROTECH EUROSTAR EUROTRAKKER CURSOR





Illustrazione <i>Illustration</i>	Ns.Rif. <i>Our Ref.</i>	Rif.Costr. <i>O.E. Ref.</i>	Descrizione <i>Description</i>	Tipo di veicolo <i>Vehicle Type</i>
	906204	98449548	Interruttore pressione aria <i>Air pressure switch</i> (AD ESAURIMENTO)	EUROCARGO EUROTECH EUROTECH CURSOR EUROSTAR EUROSTAR CURSOR STRALIS
	906209	98444205	Interruttore pressione aria <i>Air pressure switch</i> (AD ESAURIMENTO)	EUROTECH T.T. EUROSTAR
	906211	98449549	Interruttore pressione aria <i>Air pressure switch</i> (AD ESAURIMENTO)	EUROTECH T.T. EUROSTAR T.T.
	906213	99445841	Interruttore pressione aria <i>Air pressure switch</i> (AD ESAURIMENTO)	EUROTECH T.T. EUROSTAR T.T. EUROTRAKKER T.T.





Illustrazione <i>Illustration</i>	Ns.Rif. <i>Our Ref.</i>	Rif.Costr. <i>O.E. Ref.</i>	Descrizione <i>Description</i>	Tipo di veicolo <i>Vehicle Type</i>
	906214	500315209	Interruttore pressione aria <i>Air pressure switch</i> (AD ESAURIMENTO)	EUROTECH CURSOR EUROSTAR CURSOR EUROTRAKKER CURSOR
	906215	41200636	Interruttore pressione aria <i>Air pressure switch</i> (AD ESAURIMENTO)	EUROTECH CURSOR EUROSTAR CURSOR EUROTRAKKER CURSOR
	906217	500353028	Interruttore pressione aria <i>Air pressure switch</i> (AD ESAURIMENTO)	EUROTECH CURSOR EUROSTAR EUROTRAKKER CURSOR
	906218	98444201	Interruttore pressione aria <i>Air pressure switch</i> (AD ESAURIMENTO)	EUROTECH 190E38 - 240E38 400E38 - 440E38 EUROSTAR 190E38/E47 - 240E38/E47 400E38 - 440E38/E47 STRALIS 190S27/S31/S40 260S31/S35/S40
	906219	41200709	Interruttore pressione aria <i>Air pressure switch</i> (AD ESAURIMENTO)	STRALIS 190S27/S31/S35/S40/S43/S48 260S27/S31/S35/S40/S43 260S44/S48/S54 440S31/S35/S40/S43 440S44/S48/S54

Illustrazione <i>Illustration</i>	Ns.Rif. <i>Our Ref.</i>	Rif.Costr. <i>O.E. Ref.</i>	Descrizione <i>Description</i>	Tipo di veicolo <i>Vehicle Type</i>
	906229	98469129 4422049	Interruttore pressione olio <i>Oil pressure switch</i>	NEW DAILY '96 DAILY RESTYLING '96 TURBODAILY '96
	906239	4746907	Interruttore pressione olio pressione 0.30 <i>Oil pressure switch</i>	GAMMAZETA TURBOZETA 330.36 TURBOTECH TURBOSTAR AP160
	906220	98449547	Interruttore pressione olio <i>Oil pressure switch</i> (AD ESAURIMENTO)	EUROTECH EUROSTAR
	906221	98449550	Interruttore pressione olio <i>Oil pressure switch</i> (AD ESAURIMENTO)	EUROTECH EUROTECH CURSOR EUROSTAR EUROSTAR CURSOR EUROTRAKKER CURSOR
	906224	500339377	Interruttore pressione olio <i>Oil pressure switch</i> (AD ESAURIMENTO)	EUROTECH EUROTECH CURSOR EUROSTAR EUROSTAR CURSOR STRALIS
	906230	98442879	Interruttore pressione olio <i>Oil pressure switch</i>	EUROCARGO EUROTECH EUROSTAR EUROTRAKKER CURSOR STRALIS





Illustrazione <i>Illustration</i>	Ns.Rif. <i>Our Ref.</i>	Rif.Costr. <i>O.E. Ref.</i>	Descrizione <i>Description</i>	Tipo di veicolo <i>Vehicle Type</i>
	906236	4859914	Interruttore pressione olio <i>Oil pressure switch</i>	EUROCARGO 60-65-75-80-100-120 130-150-170 EUROTECH EUROSTAR EUROTRAKKER
	906053	4151564	Trasmittitore olio M 12 x 1,5 mm. <i>Oil temperature transmitter</i> M 12 x 1,5 mm.	50 - 55 - 684 - 190
	906054	4151891	Trasmittitore olio M 12 x 1,5 mm. <i>Oil temperature transmitter</i> M 12 x 1,5 mm. (AD ESAURIMENTO)	AUTOBUS
	906238	4746909	Interruttore pressione olio pressione 1.00 <i>Oil pressure switch</i>	190.42 330.35 BUS 370S35 - 490.12.22





Illustrazione <i>Illustration</i>	Ns.Rif. <i>Our Ref.</i>	Rif.Costr. <i>O.E. Ref.</i>	Descrizione <i>Description</i>	Tipo di veicolo <i>Vehicle Type</i>
	906225	99460557	Interruttore temperatura acqua <i>Water temperature switch</i>	NEW DAILY (96) 30.8-35.8-40.8 35.10-45.10-49.10 TURBODAILY (96) 35.10-49.10 35.12-49.12-59.12 DAILY CITY 2000 35S11 - 35C11 50C11
	906226	98435734	Interruttore temperatura acqua <i>Water temperature switch</i>	NEW DAILY (96) 30.8-35.8-40.8 35.10-45.10-49.10 TURBODAILY (96) 35.10-49.10 35.12-49.12-59.12 EUROCARGO 100E15/E18/E21 120E18/E23 130E15/E18/E23 150E15/E18/E23 170E18/E23/E27
	906050	500310147	Trasmittitore acqua <i>Water temperature transmitter</i>	NEW DAILY (96) 30.8-35.8-40.8 35.10-45.10-49.10 TURBODAILY (96) 35.10-49.10 35.12-49.12-59.12
	906233	4746856	Trasmittitore acqua <i>Water temperature transmitter</i>	ZETA 50.9-65.9-79.14-109.14 TURBOZETA 60.11-65.12-79.12 TURBOSTAR 190.36/42/48 240.36/48 - 260.36/48 TURBOTECH 190.26/32 - 220-240.36
	906052	4837951	Trasmittitore acqua <i>Water temperature transmitter</i>	EUROCARGO EUROTECH EUROSTAR EUROTRAKKER CURSOR T.T.

Illustrazione <i>Illustration</i>	Ns.Rif. <i>Our Ref.</i>	Rif.Costr. <i>O.E. Ref.</i>	Descrizione <i>Description</i>	Tipo di veicolo <i>Vehicle Type</i>
	906242	98453557	Trasmittitore temperatura acqua <i>Water temperature transmitter</i>	EUROCARGO T.T.
	906051	4171667	Trasmittitore temperatura acqua M 16 x 1,5 mm. <i>Water temperature transmitter</i> M 16 x 1,5 mm.	330.35
	906231	4825110	Trasmittitore elettronico <i>Electronic transmitter</i>	NEW DAILY - TURBODAILY ZETA 50.9-65.9-79.14-109.14 TURBOZETA 65.12-79.12 115.14-115.17-175.17 135.14-135.17 TURBOSTAR 190.42
	906237	4840434	Bulbo temperatura acqua <i>Water temperature bulb</i>	GAMMAZETA TURBOZETA 79-95.14 - 109.14 115/135.14/17
	906055	4834987	Trasmittitore elettronico <i>Electronic transmitter</i>	NEW DAILY (96) TURBODAILY (96) EUROCARGO - TECTOR EUROTECH - CURSOR EUROSTAR EUROTRAKKER - CURSOR
	906235	42047142	Interruttore retromarcia <i>Reverse motion switch</i>	190.26-330.30/35/36 EUROTRAKKER 190E31-380E31/E37 400E31-720E31







Illustrazione <i>Illustration</i>	Ns.Rif. <i>Our Ref.</i>	Rif.Costr. <i>O.E. Ref.</i>	Descrizione <i>Description</i>	Tipo di veicolo <i>Vehicle Type</i>
	905091	4745192	Bulbo aria <i>Air bulb</i>	619-697-300-684-160-691 TURBOCITY 480 - 580
	905092	4741946	Bulbo aria <i>Air bulb</i>	TURBOSTAR 190.42/48 - 240.4 8- 260.48 TURBOTECH 190.24/26/30/32/36 - 220.32/36 240.36 - 260.36 330.26/30/36 TURBOCITY 480-580-680 BUS 370S24/S30/S35
	906241	504084761 99469897 99484667	Bulbo olio <i>Oil bulb</i>	EUROCARGO EUROTECH EUROTRAKKER EUROSTAR EURORIDER
	906101	4745193	Bulbo olio <i>Oil bulb</i>	619-697-300-684-160-691 TURBOCITY 480 - 580
	906102	4741945	Bulbo olio <i>Oil bulb</i>	TURBOSTAR 190.42/48 - 240.4 8- 260.48 TURBOTECH 190.24/26/30/32/36 - 220.32/36 240.36 - 260.36 330.26/30/36 TURBOCITY 480-580-680 BUS 370S24/S30/S35
	906223	4857248	Bulbo temperatura <i>Temperature transmitter</i>	IVECO DAILY 30.8-35.8 (75cv) 35.10-49.10 (103cv) Duty 1991> (75cv)

Illustrazione <i>Illustration</i>	Ns.Rif. <i>Our Ref.</i>	Rif.Costr. <i>O.E. Ref.</i>	Descrizione <i>Description</i>	Tipo di veicolo <i>Vehicle Type</i>
	906060	4862328	Sensore filtro gasolio <i>Fuel filter sensor</i>	NEW DAILY (96) 30.8-35.8-40.8 35.10-45.10-49.10 TURBODAILY (96) 35.10-49.10 35.12-49.12-59.12
	906061	4851417	Sensore filtro gasolio <i>Fuel filter sensor</i>	NEW DAILY (96) 30.8-35.8-40.8 35.10-45.10-49.10 TURBODAILY (96) 35.10-49.10 35.12-49.12-59.12
	906062	99468264	Sensore filtro gasolio <i>Fuel filter sensor</i>	DAILY CITY 2000 EUROCARGO - TECTOR EUROTECH EUROSTAR EUROTRAKKER CURSOR T.T.
	902294	98494902 4832277	Elettrovalvola <i>Electro-valve</i>	TURBODAILY '96 35.12 DAILY CITY 2000 35S9/S11/S13/S15 35C9/C11/C13/C15 50C11/C13/C15 65C13/C15
	906064	500304249	Elettropompa lavacrystalli <i>Glass washing electro-pump</i>	EUROCARGO TECTOR EUROTECH CURSOR EUROSTAR CURSOR EUROTRAKKER CURSOR STRALIS





Illustrazione <i>Illustration</i>	Ns.Rif. <i>Our Ref.</i>	Rif.Costr. <i>O.E. Ref.</i>	Descrizione <i>Description</i>	Tipo di veicolo <i>Vehicle Type</i>
	907082	4717885	Tubo aria compressore <i>Compressor connecting pipe</i>	TURBOSTAR 190.36/42/48 - 240-260.36/48 TURBOTECH 190.32/36 - 220-240-260.36 EUROSTAR 190-240-400-440E52 330.30-35-36
	907074	4649176	Tubo aria compressore <i>Compressor connecting pipe</i>	EUROCARGO 150-170-320E27 EUROTECH 180-190E24/E27/E42 240-260-400-440E42 - 325E27 EUROSTAR 190-240-260-400-440E42/E47 EUROTRAKKER 190E31/E37/E42 - 330E37 260-380-720E31/E37/E42/E47 340-400-410-440E37/E42 AP160 - 370S30
	907071	4644373	Tubo aria compressore <i>Compressor connecting pipe</i>	370 - 418
	971054	79098373 8122974	Albero compressore AC75 <i>Compressor crankshaft AC75</i>	TURBOSTAR 190.36/42/48 - 240-260.36/48 TURBOTECH 190-220-240-260.36 330.30/35/36-AP160 - 370S35

Illustrazione <i>Illustration</i>	Ns.Rif. <i>Our Ref.</i>	Rif.Costr. <i>O.E. Ref.</i>	Descrizione <i>Description</i>	Tipo di veicolo <i>Vehicle Type</i>
	901339	500305943	Puleggia elettromagnete <i>Electromagnet pulley</i>	NEW DAILY TURBODAILY 30.8 - 35.8-35.10-49.10 35.12 - 49.12 (anno 1996)
	901340	99473900	Puleggia elettromagnete <i>Electromagnet pulley</i>	DAILY CITY 2000 35S9/S11/S13/S15 35C9/C11/C13/C15 50C11/C13/C15 65C13/C15







Illustrazione <i>Illustration</i>	Ns.Rif. <i>Our Ref.</i>	Rif.Costr. <i>O.E. Ref.</i>	Descrizione <i>Description</i>	Tipo di veicolo <i>Vehicle Type</i>
	905085	4839530	Piastra collettore scarico (6 cilindri) <i>Exhaust manifold plate</i>	TURBOTECH - TURBOSTAR 190.30/36 - 220/240/260.36 190.26/30H - 330.26/30/36H 330.30N - 370
	905089	-	Kit guarnizioni scarico in rame (6 pz.) - (adattabile 4835930) <i>Exhaust copper gaskets kit</i> (AD ESAURIMENTO) (6pz.) <i>adaptable</i>	TURBOTECH - TURBOSTAR 190.30/36 - 220/240/260.36 190.26/30H - 330.26/30/36H 330.30N - 370
	905084	4836361	Piastra collettore scarico (8 cilindri a V) <i>Exhaust manifold plate</i> (8V <i>cylindres</i>)	TURBOSTAR 170 - 190.42/48 - 240/260.48 330.35H - 370S35
	905090	-	Kit guarnizioni scarico in rame (4 pz.) - (adattabile 4836361) <i>Exhaust copper gaskets kit</i> (4pz.) <i>(adaptable 4836361)</i> (AD ESAURIMENTO)	TURBOSTAR 170 - 190.42/48 - 240/260.48 330.35H - 370S35
	905550	98489690	Guarniz.collettore scarico <i>Exhaust manifold gasket</i>	EUROCARGO 60-65E12/E14-75E12/E14/E15 80-100E15/E18/E21 120-130-150E15/E18/E23 170E18
	905517	61319208	Guarniz.collettore scarico inox <i>Inox exhaust manifold gasket</i>	EUROTECH 180-400E30/E34/E38 240E34/E38 EUROTRAKKER 190-260E30/E34 330/380/400/440E34 EUROSTAR 190/240/440E38 490-590 EUROCLASS - EURORIDER
	905527	98409494	Guarniz.collettore scarico inox <i>Inox exhaust manifold gasket</i>	EUROTECH - EUROSTAR 180-190-400-440E42 190-400-440E42 EUROTRAKKER 190-400E31

Illustrazione <i>Illustration</i>	Ns.Rif. <i>Our Ref.</i>	Rif.Costr. <i>O.E. Ref.</i>	Descrizione <i>Description</i>	Tipo di veicolo <i>Vehicle Type</i>
	905533	98433292	Guarniz.collettore scarico inox <i>Inox exhaust manifold gasket</i>	EUROSTAR 190-260-400-440E52
	905541	4733026	Guarnizione turbocompressore <i>Gasket for turbocompressor</i>	190.38 (AD ESAURIMENTO)
	905543	4722894	Guarnizione turbocompressore <i>Gasket for turbocompressor</i>	190.38 (AD ESAURIMENTO)
	905542	4729026	Guarnizione turbocompressore <i>Gasket for turbocompressor</i>	TURBOSTAR 190/260.42/48 EUROSTAR 190/260/400/440E52
	905566	98428396	Guarnizione turbocompressore (ex. 4632123) <i>Gasket for turbocompressor</i>	115-135.17 TURBOSTAR 190/260.42/48 EUROSTAR 190/260/400/440E52
	905539	4512366	Guarnizione turbocompressore <i>Gasket for turbocompressor</i> (AD ESAURIMENTO)	190.30 190.33/36 TURBOSTAR
	905538	8589637	Guarnizione turbocompressore <i>Gasket for turbocompressor</i> (AD ESAURIMENTO)	TURBOZETA 65.11/12 - 79.12
	905608	42075987	Guarnizione turbocompressore <i>Gasket for turbocompressor</i>	TURBOTECH-TURBOSTAR 190.30 - 190/220/240/260.36 330.30/36H EUROTECH EUROTRAKKER EUROSTAR





Illustrazione <i>Illustration</i>	Ns.Rif. <i>Our Ref.</i>	Rif.Costr. <i>O.E. Ref.</i>	Descrizione <i>Description</i>	Tipo di veicolo <i>Vehicle Type</i>
	900298	7303100	Distanziale collettore scarico <i>Exhaust manifold spacer</i> (AD ESAURIMENTO)	DAILY RESTYLING 35.10 - 49.10
	900297	7303099	Bullone collettore scarico <i>Exhaust manifold bolt</i> (AD ESAURIMENTO)	DAILY RESTYLING 35.10 - 49.10
	900293	4756200	Bullone collettore scarico M 10 x 1.25 x 46 <i>Exhaust manifold bolt</i> (AD ESAURIMENTO)	170-190.35 - 330.35
	900271	98490937	Bullone collettore scarico M 10 x 1.25 x 70 <i>Exhaust manifold bolt</i>	EUROSTAR 190-260-440E52 190-240-400E38 EUROTECH 180-190-400E30/E34 180-400E38 TURBOSTAR 190.38/42/48
	905555	98491312	Vite fissaggio turbina (ex.4806333) <i>Fixing turbine screw</i>	EUROSTAR E52 TURBOSTAR 190.42/48



Illustrazione <i>Illustration</i>	Ns.Rif. <i>Our Ref.</i>	Rif.Costr. <i>O.E. Ref.</i>	Descrizione <i>Description</i>	Tipo di veicolo <i>Vehicle Type</i>
	906244	99431083 4841844	Turbosoffiante Turbocharger MOTORE SOFIM 8140.27 85 Kw/3800 rpm	NEW DAILY 35.10-49.10 DAILY RESTYLING 35.10-49.10
	906129	99431084	Turbosoffiante Turbocharger MOTORE SOFIM 8140.47	NEW DAILY 35.10 - 49.10 TURBODAILY 96 35.12 - 49.12 - 59.12
	906243	99450704	Turbosoffiante Turbocharger	TURBODAILY 96 30.10 - 35.10 - 49.10



Illustrazione <i>Illustration</i>	Ns.Rif. <i>Our Ref.</i>	Rif.Costr. <i>O.E. Ref.</i>	Descrizione <i>Description</i>	Tipo di veicolo <i>Vehicle Type</i>
	906124	99450703	Turbosoffiante Turbocharger MOTORE SOFIM 8140.23	TURBODAILY 96 35.12 - 49.12 - 59.12
	906123	99499169	Turbosoffiante Turbocharger MOTORE SOFIM 8140.43 84 Kw/3500 rpm	DAILY
	905625	99436004	Tubo in ghisa per passaggio aria turbina Cast iron pipe for way out turbine's air	TURBODAILY '96 35.10-35.12 49.10-49.12 - 59.12









Illustrazione <i>Illustration</i>	Ns.Rif. <i>Our Ref.</i>	Rif.Costr. <i>O.E. Ref.</i>	Descrizione <i>Description</i>	Tipo di veicolo <i>Vehicle Type</i>
	905140	-	Serie guarnizioni turbocompr. <i>Gaskets kit for turbocompressor</i>  KKK 7302470 Garrett 7302941 Garrett 7303183	DAILY RESTYLING 35.10 - 49.10 (AD ESAURIMENTO)
	905157	-	Serie guarnizioni turbocompr. <i>Gaskets kit for turbocompressor</i>  KKK 98408871 Garrett 99431084	NEW DAILY 35.10 - 49.10 TURBO DAILY 35/49/59.12
	900445	4856612	Serie guarnizioni turbocompr. (senza prigionieri) <i>Gaskets kit for turbocompressor</i>  KKK 98408871 Garrett 99431084	NEW DAILY 35.10 - 49.10 TURBO DAILY 35/49/59.12
	905180	2992533 504049364	Serie guarnizioni turbocompr. <i>Gaskets kit for turbocompressor</i>	DAILY CITY 2000 35S10/S12 35C10/C12

Illustrazione <i>Illustration</i>	Ns.Rif. <i>Our Ref.</i>	Rif.Costr. <i>O.E. Ref.</i>	Descrizione <i>Description</i>	Tipo di veicolo <i>Vehicle Type</i>
	905181	99477121	Serie guarnizioni turbocompr. <i>Gaskets kit for turbocompressor</i>	TURBODAILY '96 35.10-35.12 49.10-49.12 59.12
	905141	-	Serie guarnizioni turbocompr. (fino a telaio 11760) <i>Gaskets kit for turbocompressor (up to chassis 11760)</i>	TURBOZETA 60.11- 65.12 - 79.12
	900440	-	Serie guarnizioni turbocompr. (da telaio 11761) <i>Gaskets kit for turbocompressor (From chassis 11761)</i>	TURBOZETA 60.11- 65.12 - 79.12
	900601	-	Serie guarnizioni turbocompr. <i>Gaskets kit for turbocompressor</i>	EURO CARGO 60-65E10/E12 60-65-75E14
	900603	-	Serie guarnizioni turbocompr. <i>Gaskets kit for turbocompressor</i>	EURO CARGO 80E15



Turbina 4810558



Turbina 4810558

 KKK 99446020
 KKK 99446021
 Garrett 4848509
 Garrett 4848601

 E15 Turbina 98411632
 E18 Turbina 4848507







Illustrazione <i>Illustration</i>	Ns.Rif. <i>Our Ref.</i>	Rif.Costr. <i>O.E. Ref.</i>	Descrizione <i>Description</i>	Tipo di veicolo <i>Vehicle Type</i>
	900602	-	Serie guarnizioni turbocompr. (fino a telaio 662042) <i>Gaskets kit for turbocompressor (up to chassis 662042)</i>  E15 Turbina 98411632  E18 Turbina 4848507	EUROCARGO 75-80-100E15 120-130-150E15 80-100-130-150-170E18
	900605	-	Serie guarnizioni turbocompr. (da telaio 662043) <i>Gaskets kit for turbocompressor (from chassis 662043)</i>  E18 Garrett 98467056 KKK 99446019  E21 Garrett 98440516 KKK 99446017	EUROCARGO 80-100E18 120-130-150-170E18 EUROCARGO 120-150E18H 80-100-180E21
	900606	-	Serie guarnizioni turbocompr. (fino a telaio 662042) <i>Gaskets kit for turbocompressor (up to chassis 662042)</i>  Turbina 4848629	EUROCARGO 80-100-180E21
	905159	-	Serie guarnizioni turbocompr. <i>Gaskets kit for turbocompressor</i>  Garrett 98441188	EUROCARGO 120-150-260E23
	905142	-	Serie guarnizioni turbocompr. <i>Gaskets kit for turbocompressor (1° type)</i>  Garrett 4810230	115/135.17 Turbo (1°serie)



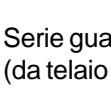

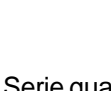





Illustrazione <i>Illustration</i>	Ns.Rif. <i>Our Ref.</i>	Rif.Costr. <i>O.E. Ref.</i>	Descrizione <i>Description</i>	Tipo di veicolo <i>Vehicle Type</i>
	900448	-	Serie guarnizioni turbocompr. <i>Gaskets kit for turbocompressor</i>  Garrett 4810230	115/135.17 U.T. 145/175.17
	900441	-	Serie guarnizioni turbocompr. <i>Gaskets kit for turbocompressor</i>  Turbina 61689950	165.24 180.24
	900442	-	Serie guarnizioni turbocompr. <i>Gaskets kit for turbocompressor</i>  Turbina 61316026	175.24 175.24 R.S.U.
	900446	-	Serie guarnizioni turbocompr. <i>Gaskets kit for turbocompressor</i>  Holsett 61315685 Garrett 61318301	190.24/26 TURBOTECH 190.26 T.R.U. 240.26 TURBOTECH
	905143	-	Serie guarnizioni turbocompr. <i>Gaskets kit for turbocompressor</i>  Holsett 4729472 Holsett 4729471 Turbina 4765164 Turbina 4776904 Turbina 4803139	190.30

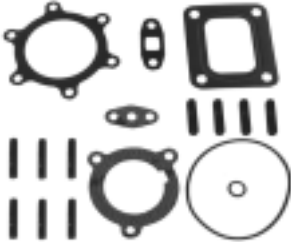



Illustrazione <i>Illustration</i>	Ns.Rif. <i>Our Ref.</i>	Rif.Costr. <i>O.E. Ref.</i>	Descrizione <i>Description</i>	Tipo di veicolo <i>Vehicle Type</i>
	905179	-	Serie guarnizioni turbocompr. <i>Gaskets kit for turbocompressor</i>  Turbina 4824498	190.32 (>1987)
	905144	-	Serie guarnizioni turbocompr. <i>Gaskets kit for turbocompressor</i>  Holsett 4818600 Holsett 98462946	190.33/36 TURBOSTAR
	905145	-	Serie guarnizioni turbocompr. DX e SX <i>Gaskets kit for turbocompressor (1°type) (LEFT and RIGHT)</i> 	190.38 (1°serie)
	900443	-	Serie guarnizioni turbocompr. DX e SX <i>Gaskets kit for turbocompressor (U.T.) (LEFT and RIGHT)</i>  KKK 4765151 KKK 4765153 Garrett 4765152 Garrett 4765459	190.38 (U.T.)
	905146	-	Serie guarnizioni turbocompr. DX e SX (fino a telaio 90610) <i>Gaskets kit for turbocompressor (up to chassis 90610) (LEFT and RIGHT)</i>  KKK 4787337 KKK 4835336 Garrett 4835337	190.42 TURBOSTAR (1°serie)

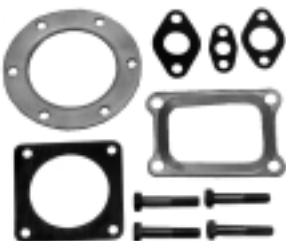







Illustrazione <i>Illustration</i>	Ns.Rif. <i>Our Ref.</i>	Rif.Costr. <i>O.E. Ref.</i>	Descrizione <i>Description</i>	Tipo di veicolo <i>Vehicle Type</i>
	900438	-	Serie guarnizioni turbocompr. DX (da telaio 90611) <i>Gaskets kit for turbocharger RIGHT (from chassis 90611)</i>  KKK 4787336 Garrett 4819795	190.42 TURBOSTAR (U.T.)
	900439	-	Serie guarnizioni turbocompr. SX (da telaio 90611) <i>Gaskets kit for turbocharger LEFT (from chassis 90611)</i>  KKK 4835336 Garrett 4835337	190.42 TURBOSTAR (U.T.)
	905148	-	Serie guarnizioni turbocompr. DX e SX <i>Gaskets kit for turbocharger (LEFT and RIGHT)</i>  Garrett 4819893 KKK 98471193 Garrett 4819892 KKK 98471190	190.48 TURBOSTAR
	905178	-	Serie guarnizioni turbocompr. <i>Gaskets kit for turbocharger</i>  Holsett 4818600 < 244928 4847181 < 302796 98488950 > 302797	330.30 (1986>) 330.36H (1988>)

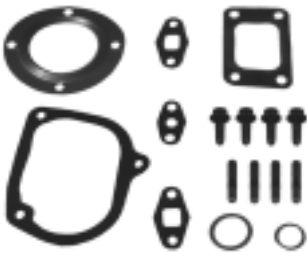



Illustrazione <i>Illustration</i>	Ns.Rif. <i>Our Ref.</i>	Rif.Costr. <i>O.E. Ref.</i>	Descrizione <i>Description</i>	Tipo di veicolo <i>Vehicle Type</i>
	900600	-	Serie guarnizioni turbocompr. <i>Gaskets kit for turbocompressor</i>  Holsett 61316428 Garrett 61318777	190.32 TURBOTECH 220.32 TURBOTECH 240.32 TURBOTECH 260.32 TURBOTECH
	900608	-	Serie guarnizioni turbocompr. (fino a telaio 17963) <i>Gaskets kit for turbocompressor (up to chassis 17963)</i>  KKK 4846402	EUROTECH 180-190E24 180-190-325E27 EUROCARGO 150-320E27
	900661	-	Serie guarnizioni turbocompr. <i>Gaskets kit for turbocompressor</i>  Holsett 61318802 KKK 61320526	EUROTECH 180-190-240-400E30 EUROTRAKKER 190-260E30
	900660	-	Serie guarnizioni turbocompr. <i>Gaskets kit for turbocompressor</i>  Holsett 61320348	EUROTECH 180-190-240-260-400 440E34/E38 EUROSTAR 190-240-440E38 EUROTRAKKER 190-260-330-340-380E34









Illustrazione <i>Illustration</i>	Ns.Rif. <i>Our Ref.</i>	Rif.Costr. <i>O.E. Ref.</i>	Descrizione <i>Description</i>	Tipo di veicolo <i>Vehicle Type</i>
	900620	-	Serie guarnizioni turbocompr. (da telaio 299112) <i>Gaskets kit for turbocompressor (from chassis 299112)</i>  Holsett 4863360	EUROTECH 180-190-440E42 EUROSTAR 190-400-440E42
	905152	-	Serie guarnizioni turbocompr. (fino a telaio 296979) <i>Gaskets kit for turbocompressor (up to chassis 296979)</i>  Garrett 4854264	EUROTECH 180E42-190E42-440E42 EUROSTAR 180E42-400E42-440E42
	900609	-	Serie guarnizioni turbocompr. DX e SX <i>Gaskets kit for turbocompressor (LEFT and RIGHT)</i>  Turbina 98429358	EUROSTAR 190E47-240E47-440E47
	905160	-	Serie guarnizioni turbocompr. DX e SX <i>Gaskets kit for turbocompressor (LEFT and RIGHT)</i>  Garrett 98435387 Garrett 98435386	EUROSTAR 190E52-260E52 440E52

Illustrazione <i>Illustration</i>	Ns.Rif. <i>Our Ref.</i>	Rif.Costr. <i>O.E. Ref.</i>	Descrizione <i>Description</i>	Tipo di veicolo <i>Vehicle Type</i>
	905597	4791129	Complessivo freno motore <i>Engine brake valve assy</i>	115-135.14/17 - 145.17 175.17
	905664	8193845	Freno motore nudo per complessivo 4791129 <i>Engine brake valve for assy 4791129</i>	115-135.14/17 - 145.17 175.17

Copyright della EMMERRE S.r.l. - Settimo Torinese - Tutti i diritti sono riservati e depositati a norma di legge ed a norma delle convenzioni internazionali. - E' vietata la duplicazione o la riproduzione anche parziale senza la previa autorizzazione della EMMERRE S.r.l.

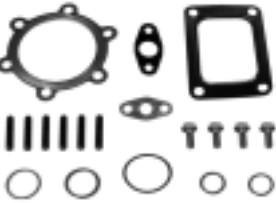

Illustrazione <i>Illustration</i>	Ns.Rif. <i>Our Ref.</i>	Rif.Costr. <i>O.E. Ref.</i>	Descrizione <i>Description</i>	Tipo di veicolo <i>Vehicle Type</i>
	905612	42086121	Complessivo freno motore <i>Engine brake valve assy</i>	TURBOSTAR 190.48 - 240.48 - 260.48 TURBOTECH 190.32 - 260.32 330.30 - 330.36 EUROTECH 180-190-240-260-400-440E42 EUROSTAR 180E42 - 190E42/E47/E52 240E42/E47/E52 - 260E42/E47 400E42/E47/E52 440E42/E47/E52 EUROTRAKKER 190E30/E31/E34/E37/E42 260E34/E37/E42/E47 330E34/E37 - 340E37/E42 380E31/E34/E37/E42/E47 400E31/E37/E42 - 410E37/E42 440E34/E37/E42 720E31/E37/E42/E47
	900700	8188890	Complessivo freno motore <i>Engine brake valve assy</i>	EUROTECH T.T. EUROSTAR T.T. EUROTRAKKER T.T.
	900701	42124998	Complessivo freno motore <i>Engine brake valve assy</i> (U.T.)	TURBOSTAR 190.48 - 240.48 TURBOTECH 190.36 - 240.36 - 260.36 330.30 - 330.36
	905600	42124922	Freno motore nudo DX e SX per complessivo 42086121 8188890 42124998 <i>Engine brake valve for assy</i> 42086121 8188890 42124998 RIGHT and LEFT	







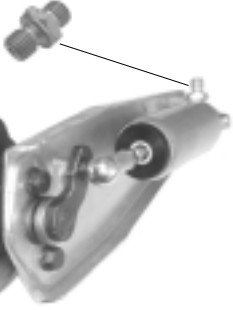
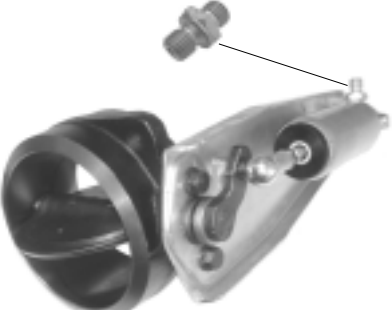

Illustrazione <i>Illustration</i>	Ns.Rif. <i>Our Ref.</i>	Rif.Costr. <i>O.E. Ref.</i>	Descrizione <i>Description</i>	Tipo di veicolo <i>Vehicle Type</i>
	905534	4677101	Freno motore nudo Dx e Sx <i>Engine brake valve</i> (LEFT and RIGHT)	170.33/35-190.35 (1°serie)
	905571	4722854	Freno motore nudo Dx e Sx <i>Engine brake valve</i> (LEFT and RIGHT)	330.35
	905510	4616372	Freno motore <i>Engine brake valve</i>	619N1-697-300
	905506	4634888	Freno motore guida SX <i>Engine brake valve</i>	619N1-697-300

Illustrazione <i>Illustration</i>	Ns.Rif. <i>Our Ref.</i>	Rif.Costr. <i>O.E. Ref.</i>	Descrizione <i>Description</i>	Tipo di veicolo <i>Vehicle Type</i>
	905508	-	Complessivo revisione freno motore <i>Overhauling engine brake (AD ESAURIMENTO)</i>	80-90-100-110NC 645-650-662
	905590	42491687	Testina freno motore Ø16 mm <i>Engine brake ball pin</i>	TURBOSTAR 190.38 - 190.42
	905739	18007911	Testina freno motore Ø14 mm <i>Engine brake ball pin</i>	TURBOSTAR 190.48 - 240.48 - 260.48 TURBOTECH 190.32 - 260.32 330.30 - 330.36 EUROTECH 180-190-240-260-400-440E42 EUROSTAR 180E42 - 190E42/E47/E52 240E42/E47/E52 - 260E42/E47 400E42/E47/E52 440E42/E47/E52 EUROTRAKKER 190E30/E31/E34/E37/E42 260E34/E37/E42/E47 330E34/E37 - 340E37/E42 380E31/E34/E37/E42/E47 400E31/E37/E42 - 410E37/E42 440E34/E37/E42 720E31/E37/E42/E47
	905735	-	Kit testina con perno Ø 5 x 0,8 mm.	VEICOLI T.T.
	905736	-	Kit testina con perno Ø 6 x 1 mm.	VEICOLI T.T.
	905733	-	Kit testina con perno Ø 8 x 1,25 mm.	VEICOLI T.T.
	905734	-	Kit testina con perno Ø 8 x 1,25 mm.	VEICOLI T.T.
	905731	-	Kit testina SX con perno Ø 10 x 1.25 mm.	VEICOLI T.T.
	905732	-	Kit testina DX con perno Ø 10 x 1.25 mm.	VEICOLI T.T.

IMPIANTO DI SCARICO - EXHAUST SYSTEM

Illustrazione <i>Illustration</i>	Ns.Rif. Our Ref.	Rif.Costr. O.E. Ref.	Descrizione Description	Tipo di veicolo Vehicle Type
	905558	4782794 4604222	Pulsante comando freno motore <i>Engine brake control button</i>	110-619-697-300-180 79.14 - 115/135.14/17 - 145.17 175.17/24 - 190.42 TURBOSTAR TURBOTECH 190-220-240E26/30/32/36
	905660	0004343801	Pulsante comando freno motore <i>Engine brake control button</i> (AD ESAURIMENTO)	MERCEDES SK 1735-1838
	905661	0004342401 0004340801 0004341101	Pulsante comando freno motore <i>Engine brake control button</i> (AD ESAURIMENTO)	MERCEDES

Copyright della EMMERRE S.r.l. - Settimo Torinese - Tutti i diritti sono riservati e depositati a norma di legge ed a norma delle convenzioni internazionali. E' vietata la duplicazione o la riproduzione anche parziale senza la previa autorizzazione della EMMERRE S.r.l.











Illustrazione Illustration	Ns.Rif. Our Ref.	Rif.Costr. O.E. Ref.	Descrizione Description	Tipo di veicolo Vehicle Type
	905749	4802797	Staffa sostegno cilindro freno motore <i>Cylinder engine brake support bracket</i>	115-135.14/17 - 145.17 175.17
	905579	42491686	Staffa sostegno cilindro freno motore <i>Cylinder engine brake support bracket</i>	330.35 BUS 370S35
	905576	42070533	Staffa sostegno cilindro freno motore <i>Cylinder engine brake support bracket</i>	TURBOSTAR 190.38/42/48-240.48-260.48 TURBOTECH 190.32 - 260.32 330.30 - 330.36 EUROTECH 180-190-240-260-400-440E42 EUROSTAR 180-190-2409-260-400-440 EUROTRAKKER 190-260-330-340-380-400-440 720
	905748	93191099	Staffa sostegno cilindro freno motore <i>Cylinder engine brake support bracket</i>	EUROCARGO 60E10/E12/E14 65E10/E12/E14 75E10/E12/E14
	905577	93191098	Staffa sostegno cilindro freno motore <i>Cylinder engine brake support bracket</i>	EUROCARGO 80E15/E18/E21 - 85E18 95E15/E18/E21 100E15/E18/E21 120-130E15/E18/E23 150-170E15/E18/E23/E27 260E23 - 320E27 EUROTECH 180-190E24/E27 325E27

Illustrazione <i>Illustration</i>	Ns.Rif. <i>Our Ref.</i>	Rif.Costr. <i>O.E. Ref.</i>	Descrizione <i>Description</i>	Tipo di veicolo <i>Vehicle Type</i>
	905621	42042638	Cilindretto freno motore Ø 35x162mm. <i>Engine brake cylinder</i>	115-135.17 - 145.17 - 175.17 175.24 - 110 - 130 TURBOTECH 190.24/26/32 EUROCARGO 60E10/E12/E14 65E10/E12/E14 75E12/E14
	905605	4671869 4695111	Cilindretto freno motore Ø 62x277mm. <i>Engine brake cylinder</i>	684-160-180-619-697-300 190.26 - AP160
	905602	4700966	Cilindretto freno motore Ø 50x240mm. (=4759252) <i>Engine brake cylinder</i>	115-135.14 ZETA 79.14 - 109.14 TURBOSTAR 190.36 TURBOTECH 190.30/36 220.36 - 240.36 - 260.36 190.30H - 330.30/35H
	905622	41022031 42050524	Cilindretto freno motore Ø 35x162mm. <i>Engine brake cylinder</i>	TURBOZETA 65.12 - 79.12 TURBOSTAR 190.35 - 190.38 - 190.42 EUROCARGO 75E15/E18/E21 80E15/E18/E21 100E15/E18/E21 120-130-150E15/E18/E23 170E18/E23/E27 EUROTECH 180E24/E27/E30 400E30/E34
	905623	7981576	Cilindretto freno motore Ø 44x173mm. <i>Engine brake cylinder</i>	TURBOSTAR 190.38 - 190.42
		905624	41022032 8194594	Cilindretto freno motore Ø 44x173mm. <i>Engine brake cylinder</i>
905629		42126564	Cilindretto freno motore <i>Engine brake cylinder</i>	TURBOSTAR 240.36 TURBOTECH 220.36 - 240.36 330.26 - 330.30

	Ns Riferim. Our Ref.	Rif. Costr. O.E. Ref.	Descrizione/Tipo di veicolo Description/Vehicle Type
	905619	-	<i>Cilindro freno motore Ø 35 mm. (TIPO BLINDATO)</i> <i>Engine brake cylinder Ø 35 mm. (REINFORCED)</i>
	905620	-	<i>Cilindro freno motore Ø 44 mm. (TIPO BLINDATO)</i> <i>Engine brake cylinder Ø 44 mm. (REINFORCED)</i> IVECO Turbotech - Turbostar Eurotech - Eurostar - Eurotrakker Cursor - Stralis
	905630	81157016080	<i>Cilindro freno motore Ø 40 mm. Engine brake cylinder Ø 40 mm. (AD ESAURIMENTO)</i> MAN
	905631	81157016112	<i>Cilindro freno motore Ø 50 mm. Engine brake cylinder Ø 50 mm. (AD ESAURIMENTO)</i> MAN
 <p>M 8 mm.</p>	905632	735121 88157016202	<i>Cilindro freno motore Ø 35 mm. Engine brake cylinder Ø 35 mm. (AD ESAURIMENTO)</i> DAF MAN

	Ns Riferim. Our Ref.	Rif. Costr. O.E. Ref.	Descrizione/Tipo di veicolo Description/Vehicle Type
 <p>M 12 mm.</p>	905634	0004300126 0482006009 4214113000	<p><i>Cilindro freno motore Ø 35 mm. Engine brake cylinder Ø 35 mm. (ADESAURIMENTO)</i></p> <p>MERCEDES</p>
	905635	0003530255 4214120000	<p><i>Cilindro freno motore Ø 50 mm. Engine brake cylinder Ø 50 mm. (ADESAURIMENTO)</i></p> <p>MERCEDES</p>
	905636	0001400459 0001400359	<p><i>Cilindro freno motore Ø 50 mm. Engine brake cylinder Ø 50 mm.</i></p> <p>MERCEDES ACTROS 1996 1831-1835-1840-1843-1848 1853-1857 2031-2035-2040-2043-2048-2053 2531-2535-2540-2543-2548 2553-2557 2631-2635-2640-2643-2648 2653-2657 3231-3235-3240-3243 3331-3335-3340-3343-3348 3353-3357 4140-4143-4148</p> <p>MERCEDES ACTROS 2003 1832-1836-1841-1844-1846 1850-1854 2032-2036-2041-2044-2046-2050 2532-2536-2541-2544-2546 2632-2636-2641-2644-2646 2650-2654-2658 3231-3241 3331-3332-3336-3341-3344-3346 3348-3350-3354 4140</p>

Illustrazione <i>Illustration</i>	Ns.Rif. <i>Our Ref.</i>	Rif.Costr. <i>O.E. Ref.</i>	Descrizione <i>Description</i>	Tipo di veicolo <i>Vehicle Type</i>
<p>F 12 x 1,25</p>  <p>F 12 x 1,25</p>	972002	4688352	Tubo comando freno motore (lunghezza mm 725) <i>Engine brake control pipe</i> (Lenght mm. 725) (AD ESAURIMENTO)	170-190.26/33
<p>M 12 x 1,5</p>  <p>M 12 x 1,5</p>	972013	4656174	Tubo comando freno motore (lunghezza mm 260) <i>Engine brake control pipe</i> (Lenght mm. 260) (AD ESAURIMENTO)	684-160NC
 <p>Ø 14</p> <p>M 14 x 1,5</p>	972016	8817406	Tubo comando freno motore (lunghezza mm 675) <i>Engine brake control pipe</i> (Lenght mm. 675) (AD ESAURIMENTO)	673 - 130
	905306	42091273	Manicotto scarico <i>Exhaust sleeve</i>	190.36 TURBOSTAR TURBOTECH
	905066	4751355	Manicotto scarico flang. Dx <i>Flanged exhaust sleeve (right)</i> (AD ESAURIMENTO)	190.38
	905067	4751356	Manicotto scarico flang. Sx <i>Flanged exhaust sleeve (left)</i> (AD ESAURIMENTO)	190.38
	905328	2513647	Manicotto scarico <i>Exhaust sleeve</i>	190.26H - 330.35H

Illustrazione <i>Illustration</i>	Ns.Rif. <i>Our Ref.</i>	Rif.Costr. <i>O.E. Ref.</i>	Descrizione <i>Description</i>	Tipo di veicolo <i>Vehicle Type</i>
	905201	500329488	Tubo scarico <i>Exhaust pipe</i>	DAILY CITY 2000 35C9 - 35S9
	905202	504033946	Tubo scarico <i>Exhaust pipe</i>	DAILY CITY 2000 35C9/C10/C11/C12/C13/C15 35S9/S10/S11/S12/S13/S15 50C11/C13/C15 65C13/C15
	905203	504033945	Tubo scarico <i>Exhaust pipe</i>	DAILY CITY 2000 35S11 - 35C11 - 50C11
	905669	504059011	Tubo scarico <i>Exhaust pipe</i>	DAILY CITY 2000
	905218	500340797 98460406	Tubo scarico <i>Exhaust pipe</i>	EUROCARGO 60E10/E12/E14 65E10/E12/E14 75E12/E14/E15

Copyright della EMMERRE S.r.l. - Settimo Torinese - Tutti i diritti sono riservati e depositati a norma di legge ed a norma delle convenzioni internazionali. - E' vietata la duplicazione o la riproduzione anche parziale senza la previa autorizzazione della EMMERRE S.r.l.





Illustrazione <i>Illustration</i>	Ns.Rif. <i>Our Ref.</i>	Rif.Costr. <i>O.E. Ref.</i>	Descrizione <i>Description</i>	Tipo di veicolo <i>Vehicle Type</i>
	905214	500369619	Tubo scarico <i>Exhaust pipe</i>	EUROCARGO 80E15 - 100E15 - 120E15 130E15 - 150E15
	905215	500369621	Tubo scarico <i>Exhaust pipe</i>	EUROCARGO 85-100-120-150-170E18 80-100-180E21
	905208	500388499	Tubo scarico <i>Exhaust pipe</i>	EUROCARGO TECTOR 130-150-180-260
	905219	99481953	Tubo scarico (ex.98454711) <i>Exhaust pipe</i>	EUROCARGO 75E15 - 80E15/E18/E21 100E15/E18/E21 120E15/E18/E23 130-150E15/E18/E23 170E18 - 180E21 - 280E23





Illustrazione <i>Illustration</i>	Ns.Rif. <i>Our Ref.</i>	Rif.Costr. <i>O.E. Ref.</i>	Descrizione <i>Description</i>	Tipo di veicolo <i>Vehicle Type</i>
	905216	500370057 500307078 98460460	Tubo scarico <i>Exhaust pipe</i>	EUROCARGO 120-130-150E23 170-260-280E23
	905222	500322473 98463576	Tubo scarico <i>Exhaust pipe</i>	EUROCARGO 150-320E27
	905204	41007585	Tubo scarico <i>Exhaust pipe</i>	EUROSTAR 190-240E38 180E34 - 440E34 EUROTECH 190E34
	905206	41210895	Tubo scarico <i>Exhaust pipe</i>	EUROTECH CURSOR EUROSTAR CURSOR STRALIS
	905205	41210818	Tubo scarico <i>Exhaust pipe</i>	EUROSTAR CURSOR 190E39/E43 - 440S43 STRALIS EUROSTAR CURSOR 440S40/E46





Illustrazione <i>Illustration</i>	Ns.Rif. <i>Our Ref.</i>	Rif.Costr. <i>O.E. Ref.</i>	Descrizione <i>Description</i>	Tipo di veicolo <i>Vehicle Type</i>
	905458	-	Flessibile per tubo di scarico Ø 65 mm. NOSTRA MODIFICA <i>Exhaust pipe flexible Ø 65 mm.</i> (OUR MODIFICATION)	EUROCARGO 60-65-70-75
	905459	-	Flessibile per tubo di scarico Ø 75 mm. NOSTRA MODIFICA <i>Exhaust pipe flexible Ø 75 mm.</i> (OUR MODIFICATION)	EUROCARGO 120-130-150-170
	905445	4020316	Tubo flessibile scarico zincato Ø 55 x 570 mm. <i>Galvanized flexible exhaust pipe</i>	OM40/35-50-55-80-90 100-110
	905449	8569057	Tubo flessibile scarico inox Ø 50 x 700 mm. <i>Inox flexible exhaust pipe</i>	OM50-65-70 50-55F8/F10 GAMMAZETA
	905448	8569477	Tubo flessibile scarico zincato Ø 55 x 850 mm. <i>Galvanized flexible exhaust pipe</i>	79-80-90-100.13

Illustrazione <i>Illustration</i>	Ns.Rif. <i>Our Ref.</i>	Rif.Costr. <i>O.E. Ref.</i>	Descrizione <i>Description</i>	Tipo di veicolo <i>Vehicle Type</i>
	905446	4555085	Tubo flessibile scarico zincato Ø 70 x 500 mm. <i>Galvanized flexible exhaust pipe</i>	130NC-673N
	905447	4776196	Tubo flessibile scarico zincato Ø 89 x 540 mm. con collare (ex. 4631757) <i>Galvanized flexible exhaust pipe with collar</i>	619N1-697-300
	905480	42094745	Tubo flessibile scarico inox Superiore <i>Inox flexible exhaust pipe</i>	190.36 TURBOSTAR 190.30/36 TURBOTECH 240/260.36 TURBOTECH
	905461	42092927	Tubo flessibile scarico inox Inferiore <i>Flexible exhaust pipe</i>	190.36 TURBOSTAR 190.30/36 TURBOTECH 240/260.36 TURBOTECH
	905755	42090446	Tubo flessibile scarico inox <i>Inox flexible exhaust pipe</i>	170.23/25 - 190.26H 330.26H - 330.35H

Illustrazione <i>Illustration</i>	Ns.Rif. <i>Our Ref.</i>	Rif.Costr. <i>O.E. Ref.</i>	Descrizione <i>Description</i>	Tipo di veicolo <i>Vehicle Type</i>
	905471	42090050	Tubo flessibile scarico inox <i>Inox flexible exhaust pipe</i>	330.36 U.T.
	905757	42094753	Tubo flessibile scarico <i>Flexibile exahust pipe</i>	EUROSTAR 190E38/E42 - 440E38/E42/E47
	905436	-	Tubo flessibile scarico inox con collari NOSTRA MODIFICA <i>Inox flexible exhaust pipe with collars</i> OUR MODIFICATION	190.36 TURBOSTAR 190.36 TURBOTECH
	905472	42093015	Tubo flessibile scarico flangiato (fino a telaio 12455) <i>Flexible exhaust pipe (up to chassis 12455)</i>	190.38/42 TURBOSTAR (U.T.)
	905221	98453453	Tubo flessibile scarico flangiato <i>Flexible exhaust pipe</i>	EUROTECH 180-190E24/E27





Illustrazione <i>Illustration</i>	Ns.Rif. <i>Our Ref.</i>	Rif.Costr. <i>O.E. Ref.</i>	Descrizione <i>Description</i>	Tipo di veicolo <i>Vehicle Type</i>
	900513	98452488	Tubo flessibile scarico flangiato <i>Flexible exhaust pipe</i>	EUROTECH 180-190-400E30
	900512	8162322	Tubo flessibile scarico flangiato <i>Flexible exhaust pipe</i>	EUROTECH 180-190-240 400-440E34/E38/E42/E47 EUROSTAR 190-240-440E38/E42/E47 EUROTRAKKER 190-260-340E30/E34/E37
	905444	42092241	Tubo flessibile scarico flangiato <i>Flexible exhaust pipe</i>	TURBOSTAR 190.48 EUROSTAR 190E52 - 240E52 260E52 - 440E52
	905254	98495744	Tubo flessibile scarico (ex. 4865484) <i>Flexible exhaust pipe</i>	EUROCLASS - BUS 370



Illustrazione <i>Illustration</i>	Ns.Rif. <i>Our Ref.</i>	Rif.Costr. <i>O.E. Ref.</i>	Descrizione <i>Description</i>	Tipo di veicolo <i>Vehicle Type</i>
	905255	42075873	Tubo fless.scarico flangiato DX <i>Flexible exhaust pipe RIGHT</i> (AD ESAURIMENTO)	330.30 - 330.36 U.T.
	905256	42075874	Tubo fless.scarico flangiato SX <i>Flexible exhaust pipe LEFT</i> (AD ESAURIMENTO)	330.30 - 330.36 U.T.
	905257	4812644	Tubo fless.scarico flangiato <i>Flexible exhaust pipe</i> (AD ESAURIMENTO)	BUS 370.12/12S - 370 S30



Illustrazione <i>Illustration</i>	Ns.Rif. <i>Our Ref.</i>	Rif.Costr. <i>O.E. Ref.</i>	Descrizione <i>Description</i>	Tipo di veicolo <i>Vehicle Type</i>
	905419	-	Tubo scendente Ø 89 mm. NOSTRA MODIFICA sostituisce 4751023-4751027 <i>Descending pipe Ø 89 mm.</i> OUR MODIFICATION <i>replace 4751023-4751027</i>	(AD ESAURIMENTO)
	905432	-	Tubo flessibile scarico inox con collari Ø 89 x 660 mm. NOSTRA MODIFICA <i>Inox flexible exhaust pipe with collars</i> OUR MODIFICATION	(AD ESAURIMENTO)
	905421	-	Tubo scendente Ø 89/100 mm. NOSTRA MODIFICA sostituisce 42048021-42048024 <i>Descending pipe Ø 89/100 mm.</i> OUR MODIFICATION <i>replace 42048021-42048024</i>	(AD ESAURIMENTO)











Illustrazione <i>Illustration</i>	Ns.Rif. <i>Our Ref.</i>	Rif.Costr. <i>O.E. Ref.</i>	Descrizione <i>Description</i>	Tipo di veicolo <i>Vehicle Type</i>
	905420	-	Tubo scendente Ø 89/100 mm. NOSTRA MODIFICA sostituisce 4753471-4753474 <i>Descending pipe Ø 89/100 mm.</i> OUR MODIFICATION <i>replace 4753471-4753474</i>	(AD ESAURIMENTO)
	905433	-	Tubo flessibile scarico inox con collari Ø 100 x 520 mm. NOSTRA MODIFICA <i>Inox flexible exhaust pipe with collars</i> OUR MODIFICATION	
	905488	-	Coppia tubi scendenti (2 Pz - 905422) (ex.42073092 - 42073093) <i>Couple descending pipe</i>	190.42 TURBOSTAR (fino a telaio 12455)
	905422	-	Tubo scendente Ø 100 mm. NOSTRA MODIFICA sostituisce 42073092-42073093 <i>Descending pipe Ø 100 mm.</i> OUR MODIFICATION <i>replace 42073092-42073093</i>	
	905433	-	Tubo flessibile scarico inox con collari Ø 100 x 520 mm. NOSTRA MODIFICA <i>Inox flexible exhaust pipe with collars</i> OUR MODIFICATION	

Illustrazione <i>Illustration</i>	Ns.Rif. <i>Our Ref.</i>	Rif.Costr. <i>O.E. Ref.</i>	Descrizione <i>Description</i>	Tipo di veicolo <i>Vehicle Type</i>
	905012	-	Coppia tubi scendenti NOSTRA MODIFICA sostituisce 42020327 - 42015724 2513647 - 2513651 <i>Couple modified descending pipe</i> Replaces 42020327 - 42015724 2513647 - 2513651	330.35
	905435	-	Tubo flessibile scarico per modifica 905012 <i>Flexible exhaust pipe</i> for modific 905012	330.35
	905260	42092909	Tubo flessibile scarico scarico inferiore <i>Exhaust pipe</i> (AD ESAURIMENTO)	190.30H - 330.30H TURBOSTAR 190.36-240.36 TURBOTECH 190.30-190.36 TURBOTECH 240.36
	905424	-	Kit tubo scendente Ø 116 mm. NOSTRA MODIFICA sostituisce 42074724 <i>Modified descending pipe</i> replaces 42070724 OUR MODIFICATION	190.30H - 330.30H TURBOSTAR 190.36-240.36 TURBOTECH 190.30-190.36 TURBOTECH 240.36
	905651	-	Modifica freno motore (sostituisce 42071914) <i>Engine brake modification</i> (replaces 42071914)	190.30H - 330.30H TURBOSTAR 190.36-240.36 TURBOTECH 190.30-190.36 TURBOTECH 240.36

Illustrazione <i>Illustration</i>	Ns.Rif. <i>Our Ref.</i>	Rif.Costr. <i>O.E. Ref.</i>	Descrizione <i>Description</i>	Tipo di veicolo <i>Vehicle Type</i>	
	905477	93811160	Silenziatore scarico <i>Exhaust silencer</i>	DAILY 28-40.8 (1°serie) NEW DAILY 28-40.8	
	905475	93806921	Silenziatore scarico <i>Exhaust silencer</i> (AD ESAURIMENTO)	DAILY 30-35-40.8 (1°-2°serie)	
	905478	93809509	Silenziatore scarico <i>Exhaust silencer</i>	DAILY 35-49.10 Turbo NEW 35-49.10 Turbo	
	905671	93822669	Silenziatore scarico <i>Exhaust silencer</i>	NEW DAILY (96) 30.8 - 35.8	
		905672	93822846	Silenziatore scarico <i>Exhaust silencer</i>	TURBODAILY 49.12 TURBODAILY (96) 30-35-49.10 35-49-59.12
		905677	500329483	Silenziatore scarico <i>Exhaust silencer</i>	DAILY CITY 2000 35S9/S11/S13 35C9/C11/C13 50C11/C13/C15 65C13/C15 35S10/S12 35C10/C12
		905670	93818452	Silenziatore scarico <i>Exhaust silencer</i>	DAILY 35.10-49.10-35.10(1996)

Illustrazione <i>Illustration</i>	Ns.Rif. <i>Our Ref.</i>	Rif.Costr. <i>O.E. Ref.</i>	Descrizione <i>Description</i>	Tipo di veicolo <i>Vehicle Type</i>
	905451	500329489	Silenziatore scarico <i>Exhaust silencer</i>	DAILY CITY 2000 35S9/S11 - 35C9/C11 50C11 - 65C11
	905464	8590315	Silenziatore scarico <i>Exhaust silencer</i>	GAMMAZETA
	905465	8590408	Silenziatore scarico <i>Exhaust silencer</i>	65/79.12 TURBOZETA
	905452	99456851	Silenziatore scarico <i>Exhaust silencer</i>	EUROCARGO 65E12/E14 - 75E12/E14
	905456	500370650	Silenziatore scarico <i>Exhaust silencer</i>	EUROCARGO TECTOR 75E13/E15/E17 - 100E15/E17 120E17 EUROCARGO TECTOR RESTYLING

Copyright della EMMERRE S.r.l. - Settimo Torinese - Tutti i diritti sono riservati e depositati a norma di legge ed a norma delle convenzioni internazionali. - E' vietata la duplicazione o la riproduzione anche parziale senza la previa autorizzazione della EMMERRE S.r.l.





Illustrazione <i>Illustration</i>	Ns.Rif. <i>Our Ref.</i>	Rif.Costr. <i>O.E. Ref.</i>	Descrizione <i>Description</i>	Tipo di veicolo <i>Vehicle Type</i>
	905476	98429580	Silenziatore scarico <i>Exhaust silencer</i>	EUROCARGO 60-65E10/E12/E14 75E12/E14
	905473	4837896	Silenziatore scarico <i>Exhaust silencer</i>	EUROCARGO 80-100E15/E18 120E18-150E18
	905455	99461871	Silenziatore scarico <i>Exhaust silencer</i>	EUROCARGO 75E15 - 80E15/18/21 100E15/E18/E21 120E15/E18/E21/E23 130E15/E18/E23 - 150E27 320E15/E18/E21/E23/E27 280E23
	905457	500370649	Silenziatore scarico <i>Exhaust silencer</i>	EUROCARGO 75/100E18/E21 130E24/E28 - 150E24 180E24/E28



Illustrazione <i>Illustration</i>	Ns.Rif. <i>Our Ref.</i>	Rif.Costr. <i>O.E. Ref.</i>	Descrizione <i>Description</i>	Tipo di veicolo <i>Vehicle Type</i>
	905428	42090557	Silenziatore scarico (ex.42073134) <i>Exhaust silencer</i>	190.33/36 TURBOSTAR
	905675	41019045	Silenziatore scarico <i>Exhaust silencer</i>	EUROTECH 180-190E24/E27/E30/E34 400E30/E34 EUROSTAR 190-240E38/E42/E47
	905676	41019322	Silenziatore scarico <i>Exhaust silencer</i>	EUROTECH 180E24/E27/E30/E34/E38/E42 190E21/E27/E30/E31/E35 190E38/E42/E43 240E30/E34/E38/E42 260E24/E31/E35/E38/E42/E43 400E31/E34/E35/E38/E42 440E38/E39/E42/E43 EUROSTAR 190E38/E42/E47 240E38/E42/E47 260E39/E42/E47 400E38/E42 440E38/E39/E42/E47 CURSOR STRALIS 270S40/S43 (>2002) 440S40/S43 (>2002)
	905403	41210965	Silenziatore scarico <i>Exhaust silencer</i>	EUROTECH CURSOR EUROSTAR CURSOR STRALIS



Illustrazione <i>Illustration</i>	Ns.Rif. <i>Our Ref.</i>	Rif.Costr. <i>O.E. Ref.</i>	Descrizione <i>Description</i>	Tipo di veicolo <i>Vehicle Type</i>
	905678	41213998	Silenziatore scarico DOPPIO <i>Exhaust silencer</i>	EUROTECH EUROTRAKKER CURSOR
	905680	41214000	Silenziatore scarico DOPPIO <i>Exhaust silencer</i>	EUROTRAKKER EUROTRAKKER CURSOR
	905404	41020590	Silenziatore scarico DOPPIO <i>Exhaust silencer</i>	EUROTRAKKER EUROTRAKKER CURSOR









Illustrazione <i>Illustration</i>	Ns.Rif. <i>Our Ref.</i>	Rif.Costr. <i>O.E. Ref.</i>	Descrizione <i>Description</i>	Tipo di veicolo <i>Vehicle Type</i>
	905935	4751044	Staffa sostegno silenziatore scarico <i>Support bracket exhaust silencer</i> (AD ESAURIMENTO)	190.33/36/38/42
	905409	4760902	Riparo marmitta <i>Silencer protection</i> (AD ESAURIMENTO)	170.33/35-190.33/35/38 190.26/36TRU-TURBOTECH 190.38 U.T.-190.42
	905905	93801183	Semicollare tubo collettore scarico <i>Exhaust manifold pipe semi-collar</i>	DAILY 28 - 40.8
	905907	8586089	Semicollare tubo collettore scarico <i>Exhaust manifold pipe semi-collar</i>	DAILY 35 - 49.10 Turbo
	905904	8540133	Semicollare tubo collettore scarico <i>Exhaust manifold pipe semi-collar</i>	110NC-673-130
	905882	-	Kit semicollari tubo collettore scarico <i>Exhaust manifold pipe kit semi-collar</i>	DAILY 28 - 40.8
	905883	-	Kit semicollari tubo collettore scarico <i>Exhaust manifold pipe kit semi-collar</i>	DAILY 35 - 49.10 Turbo
	905884	-	Kit semicollari tubo collettore scarico <i>Exhaust manifold pipe kit semi-collar</i>	110NC-673-130

Illustrazione <i>Illustration</i>	Ns.Rif. <i>Our Ref.</i>	Rif.Costr. <i>O.E. Ref.</i>	Descrizione <i>Description</i>	Tipo di veicolo <i>Vehicle Type</i>
	905909	61597791	Collare tubi scarico Ø 77 mm. <i>Exhaust pipe collar</i>	EUROTECH
	905955	41028424	Collare tubi scarico Ø 110 mm. <i>Exhaust pipe collar</i> (ex.42090023)	EUROTECH EUROSTAR
	905911	2491711	Collare tubi scarico Ø 110 mm. (da telaio 13972) <i>Exhaust pipe collar</i> (from chassis 13972)	EUROTECH EUROSTAR
	905910	42090154	Collare tubi scarico Ø 116 mm. <i>Exhaust pipe collar</i>	EUROTECH EUROSTAR
	905933	41800522	Collare tubi scarico Ø 112 mm. (fino a telaio 13971) <i>Exhaust pipe collar</i> (from chassis 13971) (AD ESAURIMENTO)	EUROSTAR 190-440E52
	905960	-	Collare rinforzato Ø 50 mm. <i>Reinforced collar</i> (AD ESAURIMENTO)	Autocarri T.T. - <i>All type trucks</i>
	905967	-	Collare rinforzato Ø 104 mm. <i>Reinforced collar</i> (AD ESAURIMENTO)	Autocarri T.T. - <i>All type trucks</i>
	905973	-	Collare rinforzato Ø 135 mm. <i>Reinforced collar</i> (AD ESAURIMENTO)	Autocarri T.T. - <i>All type trucks</i>



905990

Espositore con serie completa collari di scarico (confezionati da 5 pz. x Ø)
 Display stand with complet series of exhaust collar (paking of 5 pieces x Ø)

Ns.Rif. Ns.Ref.	Rif.costrutt. O.E. Reference	Misura Ø Dimension Ø	Tipo di veicolo Vehicle Type
906030	-	Ø 43-45 mm.	Autocarri T.T. - All type trucks
906031	-	Ø 46-48 mm.	Autocarri T.T. - All type trucks
906032	-	Ø 48-51 mm.	Autocarri T.T. - All type trucks
906033	-	Ø 51-54 mm.	Autocarri T.T. - All type trucks
906034	-	Ø 54-57 mm.	Autocarri T.T. - All type trucks
906035	-	Ø 57-60 mm.	Autocarri T.T. - All type trucks
906036	-	Ø 60-63 mm.	Autocarri T.T. - All type trucks
906037	-	Ø 63-66 mm.	Autocarri T.T. - All type trucks
906038	-	Ø 66-69 mm.	Autocarri T.T. - All type trucks
906039	-	Ø 69-76 mm.	Autocarri T.T. - All type trucks
906040	-	Ø 76-80 mm.	Autocarri T.T. - All type trucks
906041	-	Ø 80-86 mm.	Autocarri T.T. - All type trucks
906042	-	Ø 86-89 mm.	Autocarri T.T. - All type trucks
906043	-	Ø 89-92 mm.	Autocarri T.T. - All type trucks
906044	-	Ø 92-98 mm.	Autocarri T.T. - All type trucks
906045	-	Ø 98-106 mm.	Autocarri T.T. - All type trucks
906046	-	Ø 106-110 mm.	Autocarri T.T. - All type trucks
906047	-	Ø 110-118 mm.	Autocarri T.T. - All type trucks
906048	-	Ø 119-125 mm.	Autocarri T.T. - All type trucks





Illustrazione <i>Illustration</i>	Ns.Rif. <i>Our Ref.</i>	Rif.Costr. <i>O.E. Ref.</i>	Descrizione <i>Description</i>	Tipo di veicolo <i>Vehicle Type</i>
	103615	93818454	Tassello sostegno marmitta <i>Silencer dowel support</i>	DAILY T.T.
	103612	-	Complessivo fissaggio silenziatore (anteriore) <i>Assy kit fixing exhaust silencer (front)</i>	DAILY T.T.
	103614	-	Complessivo fissaggio silenziatore (posteriore) <i>Assy kit fixing exhaust silencer (rear)</i>	DAILY T.T.
	103609	-	Complessivo fissaggio scarico completo <i>Assy kit fixing exhaust silencer (front and rear)</i>	DAILY T.T.
	103618	-	Kit fissaggio silenziatore composto da: Kit fixing exhaust silencer composed by:	DAILY CITY 2000
		500329485 8585923 8582510 16598424 17094914 16750221	Tassello in gomma Pz. 4 Collare di fissaggio Pz. 1 Collare di fissaggio Pz. 1 Vite fissaggio Pz. 2 Rondella Pz. 4 Dado M8 Pz. 2	

Illustrazione <i>Illustration</i>	Ns.Rif. <i>Our Ref.</i>	Rif.Costr. <i>O.E. Ref.</i>	Descrizione <i>Description</i>	Tipo di veicolo <i>Vehicle Type</i>
	103619	-	Complessivo fissaggio scarico <i>Assy kit fixing exhaust silencer</i>	OM40/35-50NC
	103621	-	Complessivo fissaggio scarico <i>Assy kit fixing exhaust silencer</i>	OM-GAMMAZETA
	905311	-	Kit tassello marmitta <i>kit fixing exhaust silencer</i> (AD ESAURIMENTO)	619-300-190
	905312	-	Complessivo fissaggio scarico <i>kit fixing exhaust silencer</i> (AD ESAURIMENTO)	190 TT







Illustrazione <i>Illustration</i>	Ns.Rif. <i>Our Ref.</i>	Rif.Costr. <i>O.E. Ref.</i>	Descrizione <i>Description</i>	Tipo di veicolo <i>Vehicle Type</i>
	905316	8564147	Tassello sostegno marmitta <i>Silencer dowel support</i>	OM40/35 - 50NC
	905317	4066081	Tassello sostegno marmitta <i>Silencer dowel support</i>	OM - GAMMAZETA
	905314	4643918	Tassello sostegno marmitta <i>Silencer dowel support</i>	619 - 300 - 190 TT
	905901	98435271	Collare fissaggio marmitta Ø 200 mm. <i>Fixing silencer collar</i> Ø 200 mm. (AD ESAURIMENTO)	EUROCARGO 60-65-75E10/E12/E14
	905906	4722405	Collare fissaggio marmitta Ø 280 mm. <i>Fixing silencer collar</i> Ø 280 mm. (AD ESAURIMENTO)	170-190.33/35
	905912	42075535	Collare fissaggio marmitta (ex. 4760899) <i>Collar fixing silencer</i>	170-190.26/30/33/35 190.36 TURBOSTAR 190.38 T.T. 190.42 TURBOSTAR

Illustrazione <i>Illustration</i>	Ns.Rif. <i>Our Ref.</i>	Rif.Costr. <i>O.E. Ref.</i>	Descrizione <i>Description</i>	Tipo di veicolo <i>Vehicle Type</i>
	905944	-	Collare fissaggio marmitta RINFORZATO (tipo 42075535) <i>Collar fixing silencer</i>	170-190.26/30/33/35 190.36 TURBOSTAR 190.38 T.T. 190.42 TURBOSTAR
	905940	42090027	Collare fissaggio marmitta <i>Collar fixing silencer</i>	190.36 TURBOSTAR 190.38 (1985) 190.38 TRU (1985) 190.42 TURBOSTAR
	905943	-	Collare fissaggio marmitta RINFORZATO tipo 42090027 <i>Fixing silencer collar</i> REINFORCED	190.36 TURBOSTAR 190.38 (1985) 190.38 TRU (1985) 190.42 TURBOSTAR
	905986	41015925	Collare fissaggio marmitta (ex.42092142) <i>Collar fixing silencer</i> (AD ESAURIMENTO)	190.48 TURBOSTAR
	905988	-	Collare fissaggio marmitta RINFORZATO tipo 41015925 <i>Fixing silencer collar</i> REINFORCED (AD ESAURIMENTO)	190.48 TURBOSTAR





Illustrazione <i>Illustration</i>	Ns.Rif. <i>Our Ref.</i>	Rif.Costr. <i>O.E. Ref.</i>	Descrizione <i>Description</i>	Tipo di veicolo <i>Vehicle Type</i>
	905902	41015983	Collare fissaggio marmitta (ex.8138309) <i>Collar fixing silencer</i>	EUROSTAR T.T. EUROTECH T.T.
	905977	-	Kit supportino per collare modificato <i>Support kit for modified collar</i>	170-190 T.T.
	905942	-	Kit modifica collare scarico (sostituisce 42075535) <i>Kit modification for collar (replace 42075535)</i>	190.36 TURBOSTAR 190.38 (1985) 190.38 TRU (1985) 190.42 TURBOSTAR
	905957	-	Kit modifica collare scarico RINFORZATO (tipo 42075535) <i>Kit modification for collar REINFORCED</i>	190.36 TURBOSTAR 190.38 (1985) 190.38 TRU (1985) 190.42 TURBOSTAR







Illustrazione <i>Illustration</i>	Ns.Rif. <i>Our Ref.</i>	Rif.Costr. <i>O.E. Ref.</i>	Descrizione <i>Description</i>	Tipo di veicolo <i>Vehicle Type</i>
	908425	93800317	Grano forcella frizione <i>Clutch fork grub screw</i>	DAILY 28.8 - 30.8 - 35.8
	908424	93807414	Grano forcella frizione <i>Clutch fork grub screw</i>	DAILY RESTYLING 30-35-40.8 - 35-45-49.10 NEW DAILY 30-35-40.8 - 35-45-49.10
	908423	93807385	Perno registro cavo frizione <i>Clutch cable register pin</i>	DAILY RESTYLING 30-35-40.8 - 35-45-49.10 NEW DAILY 30-35-40.8 - 35-45-49.10 TURBODAILY 35-45-49-59.12
	908428	4593876	Perno articolazione leva frizione <i>Clutch lever pin</i>	FIAT OM40 - OM35
	908174	93801671	Leva distacco frizione (fino a telaio 420242) <i>Clutch lever</i> (Up to chassis 420242)	DAILY 28.8 - 35.8 - 40.8 DAILY RESTYLING 30.8 - 35.8 - 40.8
	908175	93807122	Leva distacco frizione (da telaio 420243) <i>Clutch lever</i> (From chassis 420243)	DAILY 28.8 - 35.8 - 40.8 DAILY RESTYLING 30-35-40.8 - 35-45-49.10 NEW DAILY 30-35-40.8 - 35-45-49.10

Illustrazione <i>Illustration</i>	Ns.Rif. <i>Our Ref.</i>	Rif.Costr. <i>O.E. Ref.</i>	Descrizione <i>Description</i>	Tipo di veicolo <i>Vehicle Type</i>
	908100	1908648 93811404	Leva distacco frizione <i>Clutch fork lever</i> (AD ESAURIMENTO)	NEW DAILY 30-35-40.8 - 35-45-49.10 TURBODAILY 30.10 - 35-45-49.12
	908131	42116734	Leva distacco frizione <i>Clutch fork lever</i>	NEW DAILY '96 30.8 - 35.8 TURBODAILY '96 30.10 - 35.10/12 - 49.10/12 59.12
	908113	4605179	Leva a forcella frizione <i>Clutch fork lever</i>	OM40-40/35
	908115	8566391	Leva a forcella frizione <i>Clutch fork lever</i>	79-80-90-100.13 F13
	908103	8586051	Leva a forcella frizione <i>Clutch fork lever</i>	TURBOZETA 65.12 - 79.12 ZETA 79.14 - 95.14 - 109.14
	908117	8586388	Leva a forcella frizione <i>Clutch fork lever</i>	ZETA 50.9 - 65.9







Illustrazione <i>Illustration</i>	Ns.Rif. <i>Our Ref.</i>	Rif.Costr. <i>O.E. Ref.</i>	Descrizione <i>Description</i>	Tipo di veicolo <i>Vehicle Type</i>
	908107	4773745	Leva a forcella frizione <i>Clutch fork lever</i>	115 - 135.14/17 145.17 - 175.17
	908106	4605265	Leva a forcella frizione <i>Clutch fork lever</i>	645-650 N2/N3 - 662 N2/N3 80-90-100-110NC 80.14 - 80.16 - 100.14
	908114	42115302	Leva a forcella frizione <i>Clutch fork lever</i>	EUROCARGO 60-65E10/E12/E14 75E12/E14/E15 80E15/E18/E21 - 95E15 100E15/E18/E21 120-130-150E15/E18/E23 170E15/E18/E23
	908111	42003011	Leva a forcella frizione <i>Clutch fork lever</i>	170.23/25AH 190.26/30H - 330.26/30H 190.26/30N - 330.30N 330.25AN - 330.35H 260.34AH - AP160
	908101	4702081	Leva a forcella frizione <i>Clutch fork lever</i> (AD ESAURIMENTO)	175.24 - 175.24 RSU 170 - 190 370S24 - 370S25L 370S30 - 370S35
	908109	4746189	Leva a forcella frizione <i>Clutch fork lever</i>	TURBOSTAR 190.42 TURBOTECH 190.24/26/30/32/36 220.36 - 240.36

Illustrazione <i>Illustration</i>	Ns.Rif. <i>Our Ref.</i>	Rif.Costr. <i>O.E. Ref.</i>	Descrizione <i>Description</i>	Tipo di veicolo <i>Vehicle Type</i>
	908177	4739513	Leva comando frizione <i>Clutch control lever</i> (AD ESAURIMENTO)	TURBOSTAR 190.38/42
	908179	4708356	Leva comando frizione <i>Clutch control lever</i> (AD ESAURIMENTO)	170-190.35/38 U.T. 370S24 - 370S25
	908000	4725884	Leva distacco frizione <i>Clutch lever</i> (AD ESAURIMENTO)	IVECO BUS 370S25 - 370S30 - 370SE27
	908366	4752909 4702296	Chiavetta albero frizione <i>Clutch shaft key</i> (AD ESAURIMENTO)	175.24 - 170/190.35 - 370S24 370S25/S30
	908141	4459817	Boccola per leva frizione <i>Clutch lever bushing</i> (AD ESAURIMENTO)	330.35H
	908099	4605177	Supporto manicotto frizione <i>Clutch sleeve support</i>	616 - OM40 - 40/35 - 50-55NC

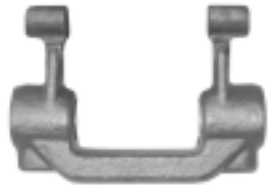

Illustrazione <i>Illustration</i>	Ns.Rif. <i>Our Ref.</i>	Rif.Costr. <i>O.E. Ref.</i>	Descrizione <i>Description</i>	Tipo di veicolo <i>Vehicle Type</i>
	908001	2994035 2995703	Kit frizione completo di disco spingidisco e reggispinta (a tiro) Ø 235 mm. <i>Kit clutch complete with disc pressurplate and thrust bearing</i>	NEW DAILY 30.8-35.8-40.8 35.10-45.10-49.10
	908370	2995814	Kit frizione completo di disco spingidisco e reggispinta (a tiro) Ø 310 mm. <i>Kit clutch complete with disc pressurplate and thrust bearing</i>	DAILY
	908003	2992630 1908543	Kit frizione completo di disco spingidisco e reggispinta (a tiro) Ø 280 mm. <i>Kit clutch complete with disc pressurplate and thrust bearing</i>	TURBODAILY 96 35.12 - 49.12 - 59.12

Illustrazione <i>Illustration</i>	Ns.Rif. <i>Our Ref.</i>	Rif.Costr. <i>O.E. Ref.</i>	Descrizione <i>Description</i>	Tipo di veicolo <i>Vehicle Type</i>
	908008	2994026 2992631 1908523	Kit frizione completo di disco spingidisco e reggispinta (a tiro) Ø 267 mm. <i>Kit clutch complete with disc pressurplate and thrust bearing</i>	NEW DAILY 35.10 - 49.10 TURBODAILY 35.12 - 49.12 - 59.12
	908009	2994028 1908521	Kit frizione completo di disco spingidisco e reggispinta (a spinta) Ø 267mm. <i>Kit clutch complete with disc pressurplate and thrust bearing</i>	NEW DAILY 35.10 - 44.10 - 49.10 DAILY CITY 2000 35S9/S11/S13 35C9/C11/C13 50C11/C13
	908036	93161953	Kit organi spinta frizione <i>Kit clutch complete</i>	DAILY

Illustrazione <i>Illustration</i>	Ns.Rif. <i>Our Ref.</i>	Rif.Costr. <i>O.E. Ref.</i>	Descrizione <i>Description</i>	Tipo di veicolo <i>Vehicle Type</i>
	908020	93162071	Kit organi spinta frizione <i>Kit clutch complete</i>	EUROCARGO 60-65-75-80-95-100-120 130-150-170
	908026	93162073	Kit organi spinta frizione <i>Kit clutch complete</i>	TURBOSTAR 190.48-260.48 EUROTECH EUROTRAKKER EUROSTAR
RENAULT				
	908007	5001830936 5001838967	Kit frizione 3 pezzi <i>Kit clutch 3 pieces</i> Ø 310 mm.	RENAULT MIDLINER S130/S140 - M140

Illustrazione <i>Illustration</i>	Ns.Rif. <i>Our Ref.</i>	Rif.Costr. <i>O.E. Ref.</i>	Descrizione <i>Description</i>	Tipo di veicolo <i>Vehicle Type</i>
	908061	1905318	Manicotto reggispinta frizione <i>Clutch thrust bearing sleeve</i>	DAILY 28-30-35.8 TURBODAILY 35.10 - 45.10 - 49.10
	908058	2992027	Manicotto reggispinta frizione (ex.1905290) <i>Clutch thrust bearing sleeve</i>	NEWDAILY 30-35-40.8 - 35-45-49.10 TURBODAILY 35-49.10 - 35.12-49.12-59.12 DAILY CITY 2000 35S9/S11/S13 35C9/C11/C13/C15 50C11/C13/C15 - 65C13/C15
	908042	8588954	Manicotto reggispinta frizione <i>Clutch thrust bearing sleeve</i>	GAMMAZETA 60-65-75-79.10
	908057	8588952	Manicotto reggispinta frizione <i>Clutch thrust bearing sleeve</i>	GAMMAZETA 79.14
	908074	8585082	Manicotto reggispinta frizione <i>Clutch thrust bearing sleeve</i>	ZETA 79.14 - 95.14 - 109.14 TURBOZETA 65.12 - 79.12 115.14-135.14

Illustrazione <i>Illustration</i>	Ns.Rif. <i>Our Ref.</i>	Rif.Costr. <i>O.E. Ref.</i>	Descrizione <i>Description</i>	Tipo di veicolo <i>Vehicle Type</i>
	908055	8587214	Manicotto reggispinta frizione <i>Clutch thrust bearing sleeve</i>	ZETA 50.9 - 65.9 TURBOZETA 60.11
	908062	4605181	Manicotto reggispinta frizione <i>Clutch thrust bearing sleeve</i>	OM40 - 50NC - 55NC
	908063	8582291	Manicotto reggispinta frizione <i>Clutch thrust bearing sleeve</i>	GAMMAZETA 50-55-60-65-70-75-79.10
	908051	4614120 0002500020 0002400020 0002540020	Cuscinetto reggispinta frizione <i>Clutch bearing</i> per manicotto reggispinta 4605181 - 8582291 - 908064 908076	OM - LEONCINO - LUPETTO TIGROTTO OM40-50-55-60-65-70 75.9/10 GAMMAZETA 50NC - 50F8 - 645 - 650 OM 80-90-100 MERCEDES L - LA 1924/2624
	908065	4605262	Manicotto reggispinta frizione <i>Clutch thrust bearing sleeve</i>	662N3-100-110NC

Illustrazione <i>Illustration</i>	Ns.Rif. <i>Our Ref.</i>	Rif.Costr. <i>O.E. Ref.</i>	Descrizione <i>Description</i>	Tipo di veicolo <i>Vehicle Type</i>
	908066	8564269	Manicotto reggispinta frizione <i>Clutch thrust bearing sleeve</i> (AD ESAURIMENTO)	80-90-100.13-110NC
	908054	1905136	Cuscinetto reggispinta frizione <i>Clutch bearing</i> (ex. 4614121) per manicotto reggispinta for thrust bearing sleeve 4605262 - 8564269	662N3 - 110 - 100NC 80-90-100.13
	908075	4787273	Manicotto reggispinta frizione <i>Clutch thrust bearing sleeve</i>	115-135-145.17
	908118	4787275	Manicotto reggispinta frizione <i>Clutch thrust bearing sleeve</i>	115-135.14/17
	908060	1905465 4769156 4787274	Manicotto reggispinta frizione <i>Clutch thrust bearing sleeve</i>	115.17 - 135.17 145.17 - 175.17

Illustrazione <i>Illustration</i>	Ns.Rif. <i>Our Ref.</i>	Rif.Costr. <i>O.E. Ref.</i>	Descrizione <i>Description</i>	Tipo di veicolo <i>Vehicle Type</i>
	908068	-	Manicotto reggispinta frizione <i>Clutch thrust bearing sleeve</i> composto da: 4672296 manicotto nudo 4675388 cuscinetto	619 - 697 - 300 - 180
	908053	4675388	Cuscinetto reggispinta frizione <i>Clutch bearing</i> per manicotto reggispinta for thrust bearing sleeve 908068	619 - 697 - 300 - 180
	908052	4675390	Cuscinetto reggispinta frizione <i>Clutch bearing</i>	684N - 160NC
	908069	42063184 30196 113365 3151007303 81305500035 3151007303	Manicotto reggispinta frizione <i>Clutch thrust bearing sleeve</i> Ø 100x460 mm.	IVECO 170.23/25AH 190.26/30H - 190.26/30N 330.26/30/35H - 330.30N 330.26/30/35 ASTRA 21 F6 BM (6X4) Motore FIAT 8210-84440 F BE BOVA Motore DAF DHT 1160 CH 3414 - 3597 DAF 2400DK TT - 2400DK 464 AT 2600DKA TT - DM17 - DM18 200/2000DKTL - 2200DKD 1303DH - 2100/2105 DH 2600DP - 2500DHS - 2800 2805 - 3300 - 2600DKB MAN 19.215F - 19.230F - 19.275F 22.304 SCANIA Omnibusse K112 Motore DS 11 224 kW



Illustrazione <i>Illustration</i>	Ns.Rif. <i>Our Ref.</i>	Rif.Costr. <i>O.E. Ref.</i>	Descrizione <i>Description</i>	Tipo di veicolo <i>Vehicle Type</i>
	908011	8193332	Manicotto reggispinta frizione <i>Clutch thrust bearing sleeve</i>	IVECO TURBOSTAR T.T. 330.36
	908010	42003397 42061921	Manicotto reggispinta frizione <i>Clutch thrust bearing sleeve</i>	EUROCARGO EUROTECH EUROTRAKKER EUROSTAR
	908013	500305439	Manicotto reggispinta frizione <i>Clutch thrust bearing sleeve</i>	EUROCARGO 150E27 130E24/E28 TECTOR EUROTECH CURSOR EUROCLASS EURORIDER
	908050	1905282	Manicotto reggispinta frizione (adattabile a frizione SACHS) <i>Clutch thrust bearing sleeve</i> (adaptable to SACHS clutch)	EUROCARGO 150-170-320E27 TURBOSTAR 190.48 - 240.48 - 260.48 TURBOTECH 190.36-220.36-240.36-260.36 EUROTECH 180E24/E27/E30/E34/E38/E42 190E24/E27/E30/E34/E38/E42 240-260E34/E38/E42 - 325E27 400-440E30/E34/E38/E42 EUROTRAKKER 190-260E30/E31/E37/E42 330-340E34/E37/E52 400-410-440E34/E37/E42 380-720E31/E34/E37/E42 EUROSTAR 180-190-240E38/E42/E47/E52 260E47/E52 400-440E38/E42/E47/E52 EUROCLASS 330.30

Illustrazione <i>Illustration</i>	Ns.Rif. <i>Our Ref.</i>	Rif.Costr. <i>O.E. Ref.</i>	Descrizione <i>Description</i>	Tipo di veicolo <i>Vehicle Type</i>
	908070	1905469 4724654	Manicotto reggispinta frizione <i>Clutch thrust bearing sleeve</i>	175.24 TURBOTECH 190.26 - 190.30H
	908071	1905470	Manicotto reggispinta frizione <i>Clutch thrust bearing sleeve</i>	TURBOTECH 190.26 - 190.30 - 190.32 EUROTECH 190E24
	908078	4727742	Manicotto reggispinta frizione <i>Clutch thrust bearing sleeve</i>	BUS 370.10.20 - 370.10.24 370.10.25 - 370.11.25 370.12.24 - 370.12.25 370.12.26 - 370.12.30

Illustrazione <i>Illustration</i>	Ns.Rif. <i>Our Ref.</i>	Rif.Costr. <i>O.E. Ref.</i>	Descrizione <i>Description</i>	Tipo di veicolo <i>Vehicle Type</i>
	908012	1123296 1393332 1434649	Dispositivo disinnesto frizione <i>centrale</i> <i>Clutch disconnecting unit</i>	SCANIA Serie 4 94-114-124-144-164





Illustrazione <i>Illustration</i>	Ns.Rif. <i>Our Ref.</i>	Rif.Costr. <i>O.E. Ref.</i>	Descrizione <i>Description</i>	Tipo di veicolo <i>Vehicle Type</i>
	913700	-	Scatola leva marce completa e montata (guida Dx) <i>Gear box lever complete and assembled</i> Foro / Hole Ø 8 mm.	619N1-697N/NP-300PC
	913701	-	Scatola leva marce completa e montata (guida Sx) <i>Gear box lever complete and assembled</i> Foro / Hole Ø 8 mm.	619N1-697N/NP-300PC
	913703	-	Scatola leva marce completa e montata <i>Gear box lever complete and assembled</i> Foro / Hole Ø 8 mm.	180NC (AD ESAURIMENTO)
	913707	-	Scatola leva marce completa e montata (guida Dx) <i>Gear box lever complete and assembled</i> Foro / Hole Ø 8 mm.	160NC
	913712	-	Scatola leva marce completa e montata (guida Sx) <i>Gear box lever complete and assembled</i> Foro / Hole Ø 8 mm.	160NC
	913004	8858515	Supporto leva marce <i>Support lever gears</i> (AD ESAURIMENTO)	NEW DAILY DAILY RESTYLING TURBODAILY
	910113	4663102	Scatola leva marce <i>Gear box lever</i>	619 - 697 - 300 - 180
	910106	4647688	Supporto inferiore scatola leva marce <i>Lower support gear box lever</i>	619 - 697 - 300 - 180
	910104	4639203	Supporto inferiore scatola leva marce <i>Lower support gear box lever</i>	684

Illustrazione <i>Illustration</i>	Ns.Rif. <i>Our Ref.</i>	Rif.Costr. <i>O.E. Ref.</i>	Descrizione <i>Description</i>	Tipo di veicolo <i>Vehicle Type</i>
	914220	8575077	Boccola snodo leva cambio <i>Gear box lever bushing</i>	ZETA 50.9 - 79.14 - 109.14 TURBOZETA 60.11 - 65.12 - 79.12 115-135.14/17 - 145.17 175.17/24 - 175.24 RSU
	914203	-	Kit riparazione supporto leva cambio composto da: <i>Gear box lever support repairing kit composed by:</i>	115-135.14/17- 145.17 (AD ESAURIMENTO)
	-	4792916	Boccola	q.tà 2
	-	4697593	Anello	q.tà 2
	-	4663036	Pernetto	q.tà 2
	914220	8575077	Boccola	q.tà 1
	913724	1907909 8859616	Kit revisione cambio ridotto <i>Kit overhaul gear box</i>	NEW DAILY 96 30.8 - 35.8 - 40.8 35.10 - 45.10 - 49.10 DAILY RESTYLING 30.8 - 35.8/10 40.8 - 45.10 - 49.10 TURBODAILY 35.12 - 49.12 - 59.12
	913714	-	Kit leva marce montato e completo di leva Rif. 8859927 <i>Gear lever kit assembled and complete with lever Ref. 8859927</i>	DAILY '96
	913715	-	Kit leva marce <i>Gear lever kit</i>	DAILY CITY 2000
	913750	504040961	Bussola leva marce	(1)
	913751	504040962	Leva marce	(2)





Illustrazione <i>Illustration</i>	Ns.Rif. <i>Our Ref.</i>	Rif.Costr. <i>O.E. Ref.</i>	Descrizione <i>Description</i>	Tipo di veicolo <i>Vehicle Type</i>
	913717	-	Kit revisione leva marce <i>Gear lever overhauling kit</i>	80NC-90NC 80-90-100F13
	913719	-	Kit revisione leva marce <i>Gear lever overhauling kit</i>	65.9-60.11 50-60.9-79.14 (cabina fissa)
	913718	-	Kit revisione leva marce <i>Gear lever overhauling kit</i>	50.8/9-60.10/11 65.9/10-79.10-65-79.12 79.100F13-79-95-109.14 (cabina ribaltabile)
	913721	-	Kit revisione leva marce completo di supporto <i>Gear lever overhauling kit with support</i>	110-130NC 662-673
	913720	-	Kit revisione leva marce senza supporto <i>Gear lever overhauling kit without support</i>	110-130NC 662-673









Illustrazione <i>Illustration</i>	Ns.Rif. <i>Our Ref.</i>	Rif.Costr. <i>O.E. Ref.</i>	Descrizione <i>Description</i>	Tipo di veicolo <i>Vehicle Type</i>
	913557	4642345	Leva interna cambio <i>Gear box inside lever</i>	110-130NC 662-673
	913410	4611917	(1) - Cuffia leva marce superiore <i>Upper head set gear lever</i>	662 - 673 - 110 - 130
	913411	4611918	(2) - Cuffia leva marce inferiore <i>Lower head set gear lever</i>	662 - 673 - 110 - 130
	913552	4611915	Supporto leva marce <i>Gear box support</i>	662 - 673 - 110 - 130
	913037	4611922	Morsetto bloccaggio leva marce <i>Gear lever locking clamp</i>	110-130NC 662-673
	913042	4784426	Piastra leva marce <i>Plate gear box lever</i>	115-135.14/17 (AD ESAURIMENTO)
	913043	990738	Spina leva marce <i>Pin</i>	115-135.14/17 (AD ESAURIMENTO)
	911048	8576824	Pomello leva marce <i>Gear lever knob</i>	DAILY

Illustrazione <i>Illustration</i>	Ns.Rif. <i>Our Ref.</i>	Rif.Costr. <i>O.E. Ref.</i>	Descrizione <i>Description</i>	Tipo di veicolo <i>Vehicle Type</i>
	913003	8859927	Leva comando marce <i>Lever control gear</i> (AD ESAURIMENTO)	NEW DAILY DAILY RESTYLING TURBODAILY
	913722	4840325	Leva comando marce <i>Lever control gear</i>	EUROCARGO 60E10/E12/E14 65E10/E12/E14 75E12/E14/E15 80E15/E18/E21 100E15/E18/E21 120E15/E18/E23 130E18/E23 150E15/E18/E23/E27 180E21 - 280E23 - 320E27
	913006	99465843	Leva comando marce <i>Lever control gear</i>	EUROCARGO 60-65-75-80-85-100-120 130-150-170
	913728	41001729	Leva comando marce <i>Lever control gear</i>	EUROTECH 180E30/E34/E38/E42 190E30/E34/E38/E42 400E30/E34/E38/E42 440E42 EUROTRAKKER 190E30/E31/E34/E37/E42 260E30/E34/E37/E42 330-340E34/E37 380E31/E34/E37/E42 400E34/E37/E42 410-440E37/E42 720E31/E37/E42
	913729	41001730	Leva comando marce <i>Lever control gear</i>	EUROTECH T.T. EUROTRAKKER T.T.

Illustrazione <i>Illustration</i>	Ns.Rif. <i>Our Ref.</i>	Rif.Costr. <i>O.E. Ref.</i>	Descrizione <i>Description</i>	Tipo di veicolo <i>Vehicle Type</i>
	913723	8139205	Leva comando marce <i>Lever control gear</i>	EUROSTAR T.T.
	913716	41210621	Kit leva marce <i>Gear lever kit</i>	EUROTECH - EUROTRAKKER CURSOR - STRALIS
	913019	41226954	Leva comando marce <i>Lever control gear</i>	STRALIS 1910S27/S31/S40/S43 260S31/S35 440S40/S43
	913018	41271991	Leva comando marce <i>Lever control gear</i>	EUROTRAKKER STRALIS
	913010	41271992	Leva comando marce <i>Lever control gear</i>	EUROTRAKKER STRALIS

Illustrazione <i>Illustration</i>	Ns.Rif. <i>Our Ref.</i>	Rif.Costr. <i>O.E. Ref.</i>	Descrizione <i>Description</i>	Tipo di veicolo <i>Vehicle Type</i>
	914250	8121825	Valvola cambio FULLER (ex.9930199) <i>Valve for FULLER gear box</i>	TURBOSTAR 190.42/48 - 240-260.48 TURBOTECH 190.26/30 - 240.26 EUROTRAKKER 190E31 - 400E37 380-720E31/E37/E42 330.26/30/35/36
	913733	42108656	Valvola cambio <i>Gear box valve</i>	EUROCARGO T.T. EUROCARGO TECTOR T.T. EUROTECH T.T. EUROSTAR T.T. EUROTRAKKER T.T. CURSOR T.T. STRALIS T.T.
	913734	93159298 81521706128 81521706064 0012606757 0012606257	Valvola cambio <i>Gear box valve</i>	TURBOSTAR T.T. TURBOTECH T.T. EUROTECH EUROSTAR EUROTRAKKER MAN Serie M90 - M2000 Serie F90 - F2000 MERCEDES
	914233	5000673571	Valvola cambio <i>Gear box valve</i>	IVECO RENAULT MAGNUM RENAULT PREMIUM KERAX serie R





Illustrazione <i>Illustration</i>	Ns.Rif. <i>Our Ref.</i>	Rif.Costr. <i>O.E. Ref.</i>	Descrizione <i>Description</i>	Tipo di veicolo <i>Vehicle Type</i>
	913644	38555888	Perno articolazione snodo cambio <i>Gear box articulation pin</i>	ZETA 50.9-65.9-79.14-95.14-109.14 TURBOZETA 65.12-79.12
	913736	42040672	Asta di comando cambio composto da: <i>Gear box shift rod composed by:</i>	TURBOTECH 190.26 - 190.30 330.30 - 330.35 - 330.36
		42040673	Asta	q.tà 1
		16979631	Dado	q.tà 1
		1104511	Dado	q.tà 1
		42079837	Testina snodo	q.tà 1
		42079838	Testina snodo	q.tà 1
	913737	9983325	Asta trasversale del giunto assiale (filettatura esterna M16x1,5) RHT Lungh. 340 mm. <i>Rod axle</i>	NEW DAILY (96) 30.8-35.8-40.8 35.10-45.10-49.10 TURBODAILY (96) 35.10-49.10 35.12-49.12-59.12 DAILY CITY 2000 35S9/S11/S13 35C9/C11/C13
	913740	42532977	Asta trasversale del giunto assiale <i>Rod axle</i>	TURBODILY (96) 35.10-49.10 35.12-49.12-59.12 DAILY CITY 2000
	913739	2992593	Asta trasversale del giunto assiale <i>Rod axle</i>	DAILY CITY 2000 35S9/S11/S13 35C9/C11/C13 50C11/C13/C15 65C11/C13/C15







Illustrazione <i>Illustration</i>	Ns.Rif. <i>Our Ref.</i>	Rif.Costr. <i>O.E. Ref.</i>	Descrizione <i>Description</i>	Tipo di veicolo <i>Vehicle Type</i>
	911045	8857922	Anello sincronizzatore cambio <i>Gear box synchronized ring</i>	ZETA 50.9 - 65.9 TURBOZETA 60.11 OM40/35 - 50-65.10 LEONCINO - LUPETTO
	911049	4541695	Anello sincronizzatore cambio <i>Gear box synchronized ring</i>	643 - 684 (AD ESAURIMENTO)
	913808	-	Complessivo revisione cambio <i>Overhauling gearbox assy</i>	OM
	913806	-	Complessivo revisione cambio <i>Overhauling gearbox assy</i>	OM40/35 - 616N3/N4 - 625N3 50 - 60 - 70 - 75
	913804	-	Complessivo revisione cambio <i>Overhauling gearbox assy</i>	650N2/N3 - 655N1 - 662N2/N3 672 - 80-90-100-110-130NC
	913805	-	Complessivo revisione cambio <i>Overhauling gearbox assy</i> (AD ESAURIMENTO)	645 - 650 - 662
	913807	-	Complessivo revisione cambio <i>Overhauling gearbox assy</i> (AD ESAURIMENTO)	79.14 - 115-135.14/17
	913803	-	Complessivo revisione cambio <i>Overhauling gearbox assy</i> (AD ESAURIMENTO)	643 - 684 - 160NC - 331A
	913801	-	Complessivo revisione cambio <i>Overhauling gearbox assy</i> (AD ESAURIMENTO)	619N/N1 - 693N/N1 - 180NC 697N/NP - 300PC
	913809	-	Complessivo revisione cambio <i>Overhauling gearbox assy</i> (AD ESAURIMENTO)	170 - 190.33/35/38

Illustrazione <i>Illustration</i>	Ns.Rif. <i>Our Ref.</i>	Rif.Costr. <i>O.E. Ref.</i>	Descrizione <i>Description</i>	Tipo di veicolo <i>Vehicle Type</i>
	914219	38555769	Testina articolazione cambio <i>Gear box head joint</i>	ZETA 50.9 - 65.9 - 79.14 - 109.14 TURBOZETA 60.11 - 65.12 - 79.12
	913519	500322689	Testa a snodo leva cambio <i>Gear lever head joint</i>	EUROCARGO 60-65E10/E12/E14 75E12/E14/E15/E17/E18 80E15/E18/E21 - 95E15/E21 100E15/E17/E18E/21 120-130-150E15/E18/E23 150-170E15/E18/E23/E27 EUROTECH 180-190E24/E27 - 325E27
	914238	41011049	Manicotto tirante cambio (ex.4732732 - 42016769) <i>Sleeve</i>	TURBOSTAR 190.36/42/48 - 240-260.36/48 TURBOTECH 190.24/26/30/32/36 220-240-260.32/36 330.26/30/35/36 EUROCARGO 60-65E10/E12/E14 75E12/E14/E15 - 95E15E/21 80-100E15/E18/E21 - 180E21 120-130-135E15/E18/E23 150-170E15/E18/E23/E27 260-280E23 - 320E27 EUROTECH 180E24/E27/E30/E34/E38/E42 190E24/E27/E30/E34/E38/E42 240E34/E38/E42-260E38/E42 325E27-400E30/E34/E38/E42 440E34/E38/E42 EUROTRAKKER 190-260E30/E31/E34/E37/E42 330-340E34/E37/E42 380-720E31/E34/E37/E42/E47 400E31/E34/E37/E42 410-440E37/E42 EUROSTAR 190-240E38/E42/E47/E52 180E42-260E47/E52 400-440E38/E42/E47/E52

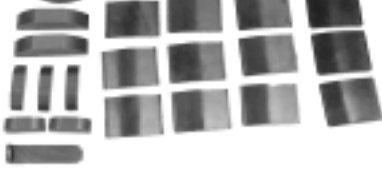

Illustrazione <i>Illustration</i>	Ns.Rif. <i>Our Ref.</i>	Rif.Costr. <i>O.E. Ref.</i>	Descrizione <i>Description</i>	Tipo di veicolo <i>Vehicle Type</i>
	913520	41013876	Scatola supporto con piastra e molla (ex.42050807) NOSTRA MODIFICA <i>Bearing housing with plate and spring</i> OUR MODIFICATION	TURBOSTAR 190.36/42/48 - 240-260.36/48 TURBOTECH 190.24/26/30/32/36 220-240-260.32/36 330.26/30/35/36 EUROCARGO 95E15E/21 - 120-130-150E23 135E18E/23 - 170-260-280E23 EUROTECH 180-190-240E30/E34/E38/E42 260E38/E42 400-440E30/E34/E38/E42 EUROTRAKKER 190-260E30/E31/E34/E37/E42 330-340E34/E37/E42 380-720E31/E34/E37/E42/E47 400E34/E37- 410E37/E42 EUROSTAR 180E42- 190E38/E42/E47/E52 240E38/E42/E47/E52 260E42/E47/E52 400-440E38/E42/E47/E52
	913727	-	Dispositivo di sgancio marce composto da: <i>Gear speed release devise</i>	TURBOSTAR 190.36/42/48 TURBOTECH 190.26/30/32
	913726	-	Dispositivo di sgancio marce composto da: <i>Gear speed release devise</i>	EUROCARGO EUROTECH EUROSTAR EUROTRAKKER
	-	42079419	Lamiera di rinforzo q.tà 1	
	914238	41011049	Manicotto cambio q.tà 1	
	913520	41013876	Scatola supporto q.tà 1	
	-	8131638	Lamiera di rinforzo q.tà 1	
	914238	41011049	Manicotto cambio q.tà 1	
	913520	41013876	Scatola supporto q.tà 1	

Illustrazione <i>Illustration</i>	Ns.Rif. <i>Our Ref.</i>	Rif.Costr. <i>O.E. Ref.</i>	Descrizione <i>Description</i>	Tipo di veicolo <i>Vehicle Type</i>
	913732	8131641	Snodo leva marce <i>Gear lever joint</i>	<p>EUROCARGO 60-65E10/E12/E14 75E12/E14/E15-80E15/18/21 85E18 - 95E15/E18/E21 100E15/E21-120E15/E18/E23 135E18/E23-130E15/E18/E23 150E15/E18/E23/E27-180E21 170E15/E18/E23/E27-260E23 280E23 - 320E27</p> <p>EUROTECH 180-190E30/E34/E38/E42 240E34/E38/E42-260E38/E42 400-440E30/E34/E38/E42</p> <p>EUROTECH CURSOR 190E24/E31/E35/E42 260E24/E31/E35/E39/E43 440E31/E35/E39/E43</p> <p>EUROSTAR 180E38/E42 190E38/E42/E47/E52 240E38/E42/E47/E52 260E42/E47/E52 400E38/E42/E47/E52 440E38/E42/E47/52</p> <p>EUROSTAR CURSOR 260E43 440E39/E43/E46/E48</p> <p>EUROTRAKKER 190E30/E31/E34/E37/E42 260E30/E34/E37/E42/E47 330E34/E37-340E34/E37/E42 380-720E31/E34/E37/E42/E47 400E31/E34/E37/E42 410E37/E42-440E34/E37/E42</p> <p>EUROTRAKKER CURSOR 180E24- 190E24/E31/E35/E44 260E31/E35/E38/E44 340-380-410E35/E38/E44 400E35 - 720E44</p>
	911050	8132189	Giunto cambio a tubo <i>Gear box joint</i>	<p>EUROTECH EUROSTAR EUROTRAKKER CURSOR STRALIS</p>



Illustrazione <i>Illustration</i>	Ns.Rif. <i>Our Ref.</i>	Rif.Costr. <i>O.E. Ref.</i>	Descrizione <i>Description</i>	Tipo di veicolo <i>Vehicle Type</i>
	913731	41210795	Snodo leva marce <i>Gear lever joint</i>	EUROTECH 180E38 - 190E34/E38/E42 240E34/E38/E42-260E42 400-440E34/E38/E42 EUROTECH CURSOR 190-260-440E35/E39/E43 EUROSTAR 190E38/E42/E47 240E38/E42/E47/E52 260E42/E47 400-440E38/E42/E47 EUROSTAR CURSOR 190E43 - 260E43/E48 440E39/E43/E46/E48 EUROTRAKKER 190E31/E34/E37/E42 260E34/E37/E42 330E34 - 340E34/E37 380E31/E34/E37/E42 400E31/E37/E42 410E37/E42 - 440E42 720E31/E37/E42 EUROTRAKKER CURSOR 190E35/E38/E44 260E35/E38/E44/E48 340E35/E38/E44 380E35/E38/E44/E48 400E38/E44 410E35/E38/E44 440E38/E44 - 720E44/E48 STRALIS 190S40/S43 - 260S40/S43/S48 440S40/S43/S48
	913738	4834271	Mozzo snodato per tubo comando cambio <i>Pivot hub</i>	EUROCARGO EUROCARGO TECTOR TECTOR RESTYLING EUROTECH 180E24/E27 - 190E24/E27 325E27
	913215	4698044	Giunto snodo cambio <i>Gear box ball joint</i>	170-190.33/35 (AD ESAURIMENTO)

Illustrazione <i>Illustration</i>	Ns.Rif. <i>Our Ref.</i>	Rif.Costr. <i>O.E. Ref.</i>	Descrizione <i>Description</i>	Tipo di veicolo <i>Vehicle Type</i>
	913213	4725393	Giunto snodo cambio <i>Gear box ball joint</i>	190 - 300 - 330 IDRO
	913211	4683737	Giunto snodo cambio (foro / Hole Ø 8 mm.) <i>Gear box ball joint</i>	619 - 697 - 300
	914227	4607716	Snodo articolazione cambio <i>Gear box swivel joint</i>	684 - 160NC
	914225	4634735	Snodo articolazione cambio <i>Gear box swivel joint</i>	110NC - 130NC
	914226	8564607	Snodo articolazione cambio <i>Gear box swivel joint</i>	50NC - 50 - 55 - 60 65 - 70 - 75



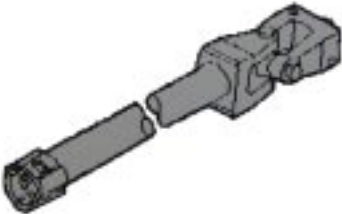



Illustrazione <i>Illustration</i>	Ns.Rif. <i>Our Ref.</i>	Rif.Costr. <i>O.E. Ref.</i>	Descrizione <i>Description</i>	Tipo di veicolo <i>Vehicle Type</i>
	914223	8564527	Testa a snodo articolazione cambio <i>Gear box head articulation joint</i>	OM40 - 40/35
	914224	8558220	Testa a snodo articolazione cambio <i>Gear box head articulation joint</i>	50 - 75
	914222	8550139	Testa a snodo articolazione cambio <i>Gear box head articulation joint</i>	50 - 75 115.14/17 - 135.14/17
	914237	8578492	Testa a snodo articolazione cambio (anteriore) <i>Gear box head articulation joint (front)</i>	ZETA 50.9-65.9-79.14 TURBOZETA 60.11 - 65-79.12
	914234	8578493	Testa a snodo articolazione cambio <i>(posteriore)</i> (Tipo Lemforder) <i>Gear box head articulation joint (rear) - (Lemforder type)</i>	ZETA 79.14-95.17-109.14 TURBOZETA 60.11-65.12-79.12
	914235	8582313	Testa a snodo articolazione cambio <i>(posteriore)</i> (Tipo Ehrenreich) <i>Gear box head articulation joint (Ehrenreich type)</i>	ZETA 50.9-65.9-79.14-95.14-109.14 TURBOZETA 60.11-65.12-79.12

Illustrazione <i>Illustration</i>	Ns.Rif. <i>Our Ref.</i>	Rif.Costr. <i>O.E. Ref.</i>	Descrizione <i>Description</i>	Tipo di veicolo <i>Vehicle Type</i>
	914221	41218482 42042912	Testa a snodo articolazione cambio <i>Gear box head articulation joint</i>	EUROCARGO 60-65E10/E12/E14 75E12/E14/E15 80-95E15/E18/E21 - 85E18 180E21 - 100E15/E18/E21 120-130E15/E18/E23 135E18E/23 150-170E15/E18/E23/E27 260-280E23 - 320E27 TURBOTECH 190.24/26/32 - 240.26 330.26/30/35/36 EUROTECH 180E24/E27/E30/E34/E38/E42 190E24/E27/E30/E34/E38/E42 240E34/E38/E42-260E38/E42 325E27-400E30/E34/E38/E42 440E34/E38/E42 EUROTECH CURSOR 190E24/E31/E35/E39/E43 260E24/E31/E35/E39/E43 440E31/E35/E39/E43 EUROTRAKKER 190E30/E31/E34/E37/E42 260E30/E34/E37/E42/E47 330E34/E37-340E34/E37/E42 380-720E31/E34/E37/E42/E47 400E31/E34/E37/E42 410E37/E42-440E34/E37/E42 EUROTRAKKER CURSOR 180E24 - 190E24/E31/E35 260E31/E35 340-380-400-410E35 EUROSTAR 180E38 - 190E38/E42/E47/E52 240E38/E42/E47/E52 260E42/E47/E52 400E38/E42/E47/E52 440E38/E42/E47/E52 EUROSTAR CURSOR 260E43 - 440E39/E43
	914240	41005523	Testa a snodo articolazione cambio <i>Gear box head articulation joint</i>	EUROTECH 190E34/E38 EUROTRAKKER 190E31/E37/E42-260E37/E42 330E37-340E4 380E31/E37/E42 400E31/E37/E42 410E42 - 720E31/E37/E42 EUROTRAKKER CURSOR 190E38/E44-260E38/E44/E48 340E38/E44 380E38/E44/E48-400E38/E44 410E38/E44/E48 440E46/E48-720E38/E44/E48

Illustrazione <i>Illustration</i>	Ns.Rif. <i>Our Ref.</i>	Rif.Costr. <i>O.E. Ref.</i>	Descrizione <i>Description</i>	Tipo di veicolo <i>Vehicle Type</i>
<p>Filetto Dx-Right</p>	914248	8198187	Testa a snodo articolazione cambio (femmina) Dx- Right (Ø12 x 1,75) <i>Gear box head articulation joint</i> ZF (0501206800) Adattabile a : ASTRA 20447 DAF 140362 MAN 81953016170 MERCEDES 0002686289 RENAULT 5001000134 SCANIA 371452 VOLVO 1190131	EUROTECH 180E24/E27/E30/E34/E38/E42 190E24/E27/E30/E34/E38/E42 240E30/E34/E38/E42 260E38/E42 - 325E27 400E30/E34/E38/E42 440E34/E38/E42 EUROTRAKKER 190E30/E31/E34/E37/E42 260E30/E34/E37/E42/E47 330-340E34/E37 380E31/E34/E37/E42 400E31/E34/E37/E42 410-440E37/E42 720E31/E37/E42/E47 EUROSTAR 180E38 - 190E38/E42/E47/E52 240-260-400E38/E42/E47/E52 440E38/E42/E47/E52
<p>Filetto Sx-Left</p>	914247	8198188	Testa a snodo articolazione cambio (femmina) Sx - Left (Ø12 x 1,75) <i>Gear box head articulation joint</i> ZF (0501206799) Adattabile a : DAF 140363 MAN 81953016064 MERCEDES 0002686189 RENAULT 5010129530 VOLVO 1190132	EUROTECH 180E24/E27/E30/E34/E38/E42 190E24/E27/E30/E34/E38/E42 240E30/E34/E38/E42 260E38/E42 - 325E27 400E30/E34/E38/E42 440E34/E38/E42 EUROTRAKKER 190E30/E31/E34/E37/E42 260E30/E34/E37/E42/E47 330-340E34/E37 380E31/E34/E37/E42 400E31/E34/E37/E42 410-440E37/E42 720E31/E37/E42/E47 EUROSTAR 180E38 - 190E38/E42/E47/E52 240-260-400E38/E42/E47/E52 440E38/E42/E47/E52
<p>Filetto Sx/Dx</p>	914287	42079837	Testa a snodo articolazione cambio filetto Sx M 10 x 1.5 mm. <i>Gear box head articulation joint</i> Left M 10 x 1.5 mm.	190.26 330.26/30H - 330.35/36H
	914286	42079838	Testa a snodo articolazione cambio Dx M 10 x 1.5 mm. <i>Gear box head articulation joint</i> Right M 10 x 1.5 mm.	190.26 330.26/30H - 330.35/36H

	Ns Riferim. Our Ref.	Rif. Costr. O.E. Ref.	Descrizione/Tipo di veicolo Description/Vehicle Type
 <p>DX (M12x1,75 - M10x1,5)</p>	914230	0009966645	<p>Testina comandi cambio Dx (M12x1,75 - M10x1,5) Gear box control ball joint (right)</p> <p>Mercedes Actros 1831-1835-1840-1843-1848 1853-1857 2031-2035-2040-2043-2048-2053 2531-2535-2540-2543-2548 2553-2557 2631-2640-2643-2648-2653 3231-3235-3240-3243 3331-3335-3340-3343-3348-3353 4140-4143-4148</p>
 <p>SX (M12x1,75 - M10x1,5)</p>	914231	0009966745	<p>Testina comandi cambio Sx (M12x1,75 - M10x1,5) Gear box control ball joint (left)</p> <p>Mercedes Actros 1831-1835-1840-1843-1848 1853-1857 2031-2035-2040-2043-2048-2053 2531-2535-2540-2543-2548 2553-2557 2631-2640-2643-2648-2653 3231-3235-3240-3243 3331-3335-3340-3343-3348-3353 4140-4143-4148</p>
 <p>DX (M14x1,5 - M10x1,5)</p>	914232	0009966845	<p>Testina comandi cambio (M14x1,5 - M10x1,5) Gear box control ball joint</p> <p>Mercedes Atego - Atego II Actros 1831-1835-1840-1843-1848 1853-1857 2031-2035-2040-2043-2048-2053 2531-2535-2540-2543-2548 2553-2557 2631-2640-2643-2648-2653 3231-3235-3240-3243 3331-3335-3340-3343-3348-3353 4140-4143-4148</p>

PARTI CAMBIO - GEAR BOX PARTS

EMMERRE

Illustrazione <i>Illustration</i>	Ns.Rif. <i>Our Ref.</i>	Rif.Costr. <i>O.E. Ref.</i>	Descrizione <i>Description</i>	Tipo di veicolo <i>Vehicle Type</i>
	<p>914292</p>	<p>1383405</p>	<p>Testa a snodo articolazione cambio <i>Gear box head articulation joint</i></p>	<p>SCANIA GRS 900</p>
	<p>914246</p>	<p>350270 243664</p>	<p>Testa a snodo articolazione cambio <i>Gear box head articulation joint</i></p>	<p>SCANIA Serie 93 - 113 - 143 SCANIA Serie 112</p>
	<p>914294</p>	<p>1527234</p>	<p>Testa a snodo articolazione cambio <i>Gear box head articulation joint</i></p>	<p>VOLVO F12 DRI 1400 SRI 1700</p>
	<p>913923</p>	<p>8556739</p>	<p>Manicotto uscita cambio <i>Sleeve output</i></p>	<p>OM50 - 55 (AD ESAURIMENTO)</p>

Copyright della EMMERRE S.r.l. - Settimo Torinese - Tutti i diritti sono riservati e depositati a norma di legge ed a norma delle convenzioni internazionali. - E' vietata la duplicazione o la riproduzione anche parziale senza la previa autorizzazione della EMMERRE S.r.l.

EMMERRE

TRASMISSIONE - DIFFERENZIALE E VARIE TRANSMISSION - DIFFERENTIAL AND MISCELLANEOUS PARTS

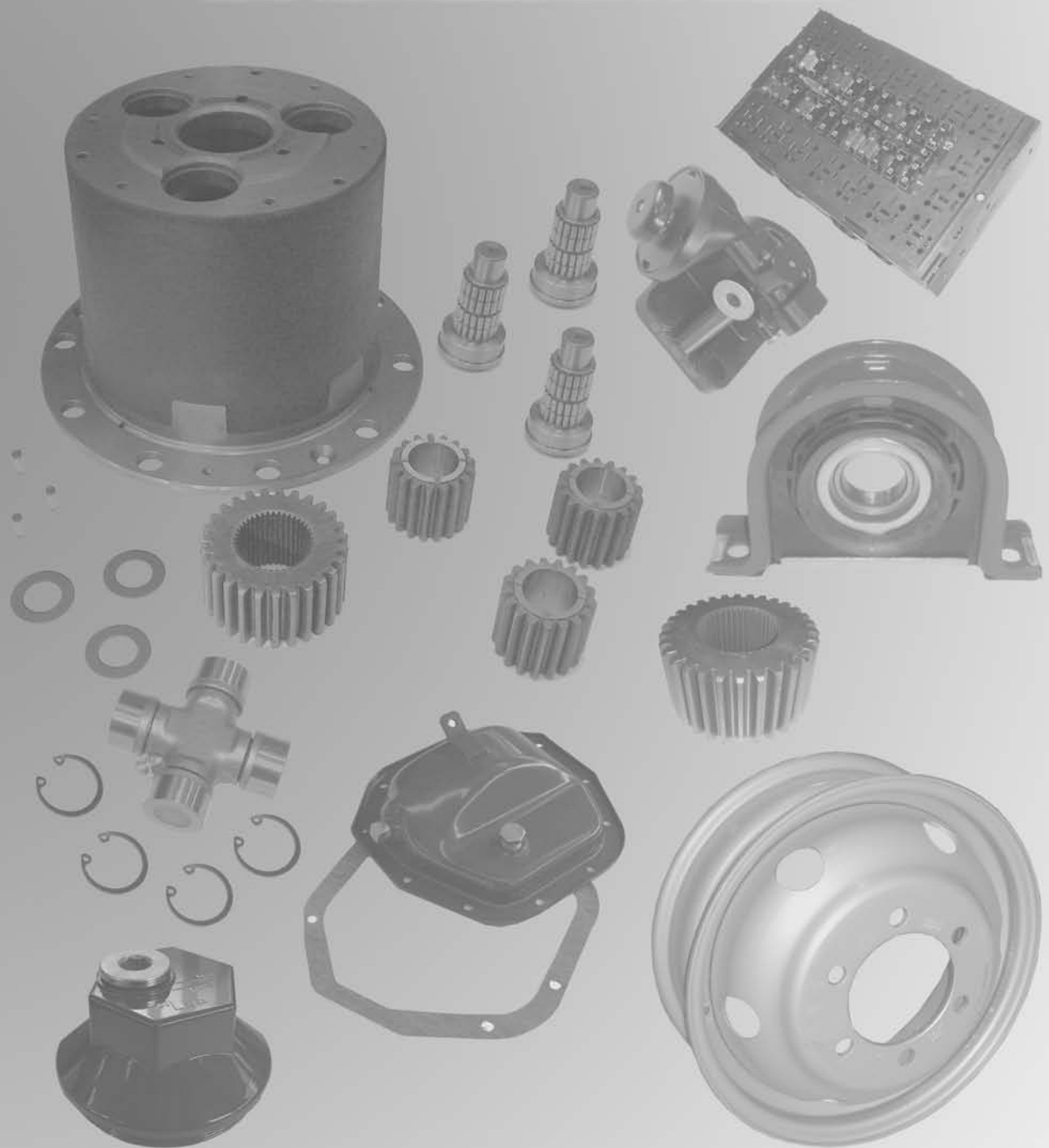

925000	7170959	Ponte posteriore nudo <i>Rear axle body</i>	NEW DAILY (96) 35.8 - 40.8 35.10 - 45.10 TURBODAILY (96) 35.10 - 35.12
925001	7180037	Ponte posteriore nudo <i>Rear axle body</i>	NEW DAILY (96) 35.8 TURBODAILY (96) 35.10 - 35.12



925002	99455219 99455218	Albero di trasmissione completo di supporto scorrevole <i>Sliding propeller shaft complete of support</i>	TURBODAILY (96) 35.10 - 49.10 35.12 - 49.12
---------------	----------------------	---	--



Lunghezza - Lenght- mm 1680 - 1750

Albero di trasmissione fisso completo di supporto Fixed propeller shaft complete with support

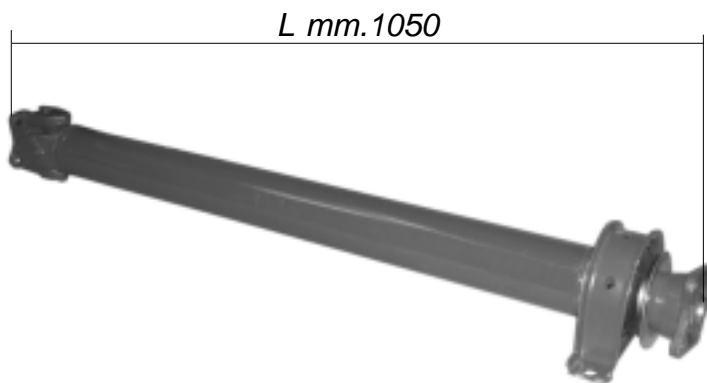

Ns Riferim. Our Ref.	Rif. Costr. O.E. Ref.	Tipo di veicolo - Vehicle Type
925038	99455579 99455578	Turbodaily '96 35.10 - 49.10 - 35.12 - 49.12

Differenziale - Differential



Ns Riferim. Our Ref.	Rif. Costr. O.E. Ref.	Tipo di veicolo - Vehicle Type
924999	7180038	DAILY ('96) DAILY CITY 2000 35C9/C10/C11/C12/C13/C15 50C11/C13/C15

Illustrazione Illustration	Ns.Rif. Our Ref.	Rif.Costr. O.E. Ref.	Descrizione Description	Tipo di veicolo Vehicle Type
	913005	7182665	Coperchio differenziale Differential cover	DAILY CITY 2000 35C9/C10/C11/C12/C13/C15 50C11/C13/C15





Illustrazione <i>Illustration</i>	Ns.Rif. <i>Our Ref.</i>	Rif.Costr. <i>O.E. Ref.</i>	Descrizione <i>Description</i>	Tipo di veicolo <i>Vehicle Type</i>						
	925020	42536526 4390495	Supporto oscill.trasmissione <i>Transmission shaft</i>	NEW DAILY 30.8-35.8-40.8 DAILY RESTYLING 30.8-35.8-40.8 - 35.10-49.10 ZETA 50.9 - 65.9 TURBOZETA 60.11						
			<table border="1"> <thead> <tr> <th>Ø mm.</th> <th>L mm.</th> <th>S mm.</th> </tr> </thead> <tbody> <tr> <td>35</td> <td>168</td> <td>17</td> </tr> </tbody> </table>	Ø mm.	L mm.	S mm.	35	168	17	
Ø mm.	L mm.	S mm.								
35	168	17								
	925019	42541021 9984261	Supporto oscill.trasmissione <i>Transmission support</i>	DAILY RESTYLING 30.8-35.8-40.8 - 35.10-49.10 NEW DAILY 30.8-35.8-40.8 - 35.10-49.10 TURBODAILY 35.12-49.12-59.12 ZETA 50.9 - 65.9						
		608924		DAF F700 - F900						
		5000560295		RENAULT MASTER B90 - JK60 - S100						
	925031	42536726 93160324	Supporto oscill.trasmissione <i>Transmission support</i>	NEW DAILY (96) 30.8-35.8-40.8 - 35.10 TURBODAILY 30.10 - 35.10						
			<table border="1"> <thead> <tr> <th>Ø mm.</th> <th>L mm.</th> <th>S mm.</th> </tr> </thead> <tbody> <tr> <td>35</td> <td>168</td> <td>18</td> </tr> </tbody> </table>	Ø mm.	L mm.	S mm.	35	168	18	
Ø mm.	L mm.	S mm.								
35	168	18								
	925024	42530546	Supporto oscill.trasmissione <i>Transmission support</i>	TURBODAILY (96) 35.12 - 49.12 - 59.12						
			<table border="1"> <thead> <tr> <th>Ø mm.</th> <th>L mm.</th> <th>S mm.</th> </tr> </thead> <tbody> <tr> <td>40</td> <td>168</td> <td>18</td> </tr> </tbody> </table>	Ø mm.	L mm.	S mm.	40	168	18	
Ø mm.	L mm.	S mm.								
40	168	18								
	925023	93158202	Supporto oscill.trasmissione <i>Transmission support</i>	TURBODAILY (96) 35.12 - 49.12 - 59.12 ZETA 50.9 - 65.9						
			<table border="1"> <thead> <tr> <th>Ø mm.</th> <th>L mm.</th> <th>S mm.</th> </tr> </thead> <tbody> <tr> <td>40</td> <td>168</td> <td>17</td> </tr> </tbody> </table>	Ø mm.	L mm.	S mm.	40	168	17	
Ø mm.	L mm.	S mm.								
40	168	17								

Illustrazione <i>Illustration</i>	Ns.Rif. <i>Our Ref.</i>	Rif.Costr. <i>O.E. Ref.</i>	Descrizione <i>Description</i>	Tipo di veicolo <i>Vehicle Type</i>						
	925030	42535254	Supporto oscill.trasmissione <i>Transmission support</i> <table border="1"> <thead> <tr> <th>Ø mm.</th> <th>L mm.</th> <th>S mm.</th> </tr> </thead> <tbody> <tr> <td>40</td> <td>170</td> <td>20</td> </tr> </tbody> </table>	Ø mm.	L mm.	S mm.	40	170	20	DAILY CITY 2000 35S9/S11/S13/S15 35C9/C11/C13/C15 50C11/C13/C15 65C13/C15
Ø mm.	L mm.	S mm.								
40	170	20								
	925013	93156460	Supporto oscill.trasmissione <i>Transmission support</i> <table border="1"> <thead> <tr> <th>Ø mm.</th> <th>L mm.</th> <th>S mm.</th> </tr> </thead> <tbody> <tr> <td>45</td> <td>168</td> <td>19</td> </tr> </tbody> </table>	Ø mm.	L mm.	S mm.	45	168	19	NEW DAILY 30.8-35.8-40.8 - 35.10-49.10 TURBODAILY 35.12-49.12-59.12 DAILY CITY 2000 35S9/S11/S13 35C9/C11/C13 50C11/C13 - 65C13
Ø mm.	L mm.	S mm.								
45	168	19								
	925027	42538439	Supporto oscill.trasmissione <i>Transmission support</i> <table border="1"> <thead> <tr> <th>Ø mm.</th> <th>L mm.</th> <th>S mm.</th> </tr> </thead> <tbody> <tr> <td>45</td> <td>170</td> <td>20</td> </tr> </tbody> </table>	Ø mm.	L mm.	S mm.	45	170	20	DAILY CITY 2000
Ø mm.	L mm.	S mm.								
45	170	20								
	925021	42536965 93160223 -	Supporto oscill.trasmissione <i>Transmission support</i> <table border="1"> <thead> <tr> <th>Ø mm.</th> <th>L mm.</th> <th>S mm.</th> </tr> </thead> <tbody> <tr> <td>40</td> <td>166</td> <td>16</td> </tr> </tbody> </table>	Ø mm.	L mm.	S mm.	40	166	16	EUROCARGO 60-65E10/E12/E14 75E12/E14 NISSAN TRADE 100
Ø mm.	L mm.	S mm.								
40	166	16								
	925017	42536523 4682902 - 5000821936 -	Supporto oscill.trasmissione <i>Transmission support</i> <table border="1"> <thead> <tr> <th>Ø mm.</th> <th>L mm.</th> <th>S mm.</th> </tr> </thead> <tbody> <tr> <td>45</td> <td>194</td> <td>20</td> </tr> </tbody> </table>	Ø mm.	L mm.	S mm.	45	194	20	ZETA 79.14 - 109.14 - 95.15 TURBOZETA 65.12 - 79.12 IVECO 115-135.14/17-145/175.17 EUROCARGO 80E15 - 100E18/E21 120-150E15/E18/E23 150E15/E18 FORD CARGO 1814 - 1214 RENAULT S130 NISSAN TRADE 130
Ø mm.	L mm.	S mm.								
45	194	20								





Illustrazione <i>Illustration</i>	Ns.Rif. <i>Our Ref.</i>	Rif.Costr. <i>O.E. Ref.</i>	Descrizione <i>Description</i>	Tipo di veicolo <i>Vehicle Type</i>						
	925032	93158251	Supporto oscill.trasmissione <i>Transmission support</i> <table border="1" data-bbox="767 427 1118 528"> <thead> <tr> <th>Ø mm.</th> <th>L mm.</th> <th>S mm.</th> </tr> </thead> <tbody> <tr> <td>45</td> <td>190</td> <td>28</td> </tr> </tbody> </table>	Ø mm.	L mm.	S mm.	45	190	28	TURBOZETA 65.12 - 79.12 115.14 - 135.14 ZETA 79.14 - 109.14 EUROCARGO 100E21 - 120-130E15/E18/E23 150E15/E18 EUROCARGO TECTOR 75E13/E15/E17/E18 100E17/E18/E21 - 120E17/E21 130E24
Ø mm.	L mm.	S mm.								
45	190	28								
	925003	42538366 42532291	Supporto oscill.trasmissione <i>Transmission support</i> <table border="1" data-bbox="767 826 1118 927"> <thead> <tr> <th>Ø mm.</th> <th>L mm.</th> <th>S mm.</th> </tr> </thead> <tbody> <tr> <td>55</td> <td>165</td> <td>18</td> </tr> </tbody> </table>	Ø mm.	L mm.	S mm.	55	165	18	EUROCARGO 65E12/E14 75E12/E14
Ø mm.	L mm.	S mm.								
55	165	18								
	925009	42536524 8194600	Supporto oscill.trasmissione <i>Transmission support</i> <table border="1" data-bbox="767 1182 1118 1283"> <thead> <tr> <th>Ø mm.</th> <th>L mm.</th> <th>S mm.</th> </tr> </thead> <tbody> <tr> <td>55</td> <td>194</td> <td>18</td> </tr> </tbody> </table>	Ø mm.	L mm.	S mm.	55	194	18	175.24 EUROCARGO 150E18/E23/E27 170E15/E18/E23/27 EUROTECH 180E24/E27 FORD CARGO 2520
Ø mm.	L mm.	S mm.								
55	194	18								
	925005	42538367 42532295	Supporto oscill.trasmissione <i>Transmission support</i> <table border="1" data-bbox="767 1563 1118 1664"> <thead> <tr> <th>Ø mm.</th> <th>L mm.</th> <th>S mm.</th> </tr> </thead> <tbody> <tr> <td>60</td> <td>195</td> <td>18</td> </tr> </tbody> </table>	Ø mm.	L mm.	S mm.	60	195	18	EUROCARGO 75E15 80E15/E18/E21 100E15/E18
Ø mm.	L mm.	S mm.								
60	195	18								
	925025	93194978	Supporto oscill.trasmissione <i>Transmission support</i> <table border="1" data-bbox="767 1906 1118 2007"> <thead> <tr> <th>Ø mm.</th> <th>L mm.</th> <th>S mm.</th> </tr> </thead> <tbody> <tr> <td>65</td> <td>190</td> <td>20</td> </tr> </tbody> </table>	Ø mm.	L mm.	S mm.	65	190	20	EUROCARGO 120E15 150E15/E18/E23/E27 170E15/E18/E23/E27 EUROTECH 180E30/E34 190E24/E27/E30
Ø mm.	L mm.	S mm.								
65	190	20								

Illustrazione <i>Illustration</i>	Ns.Rif. <i>Our Ref.</i>	Rif.Costr. <i>O.E. Ref.</i>	Descrizione <i>Description</i>	Tipo di veicolo <i>Vehicle Type</i>						
	925039	42536078	Supporto oscill.trasmissione <i>Transmission support</i>	EUROCARGO TECTOR TECTOR RESTYLING						
			<table border="1"> <thead> <tr> <th>Ø mm.</th> <th>L mm.</th> <th>S mm.</th> </tr> </thead> <tbody> <tr> <td>65</td> <td>200</td> <td>18</td> </tr> </tbody> </table>	Ø mm.	L mm.	S mm.	65	200	18	
Ø mm.	L mm.	S mm.								
65	200	18								
	925026	93192009	Supporto oscill.trasmissione <i>Transmission support</i>	EUROCARGO 75E15 80E15/E18 - 85E15 100E18						
			<table border="1"> <thead> <tr> <th>Ø mm.</th> <th>L mm.</th> <th>S mm.</th> </tr> </thead> <tbody> <tr> <td>100</td> <td>195</td> <td>13</td> </tr> </tbody> </table>	Ø mm.	L mm.	S mm.	100	195	13	
Ø mm.	L mm.	S mm.								
100	195	13								
	925010	4765836	Supporto oscill.trasmissione <i>Transmission support</i>	165.24						
		5000589888	<table border="1"> <thead> <tr> <th>Ø mm.</th> <th>L mm.</th> <th>S mm.</th> </tr> </thead> <tbody> <tr> <td>50</td> <td>192</td> <td>20</td> </tr> </tbody> </table>	Ø mm.	L mm.	S mm.	50	192	20	RENAULT G210 - G230 - G260 - G290
Ø mm.	L mm.	S mm.								
50	192	20								
	925006	42541440 93163091	Supporto oscill.trasmissione <i>Transmission support</i>	EUROTECH 180E30/E34 190E24/E27/E30 EUROTECH CURSOR 190E24/E31/E35 260E31/E35						
			<table border="1"> <thead> <tr> <th>Ø mm.</th> <th>L mm.</th> <th>S mm.</th> </tr> </thead> <tbody> <tr> <td>55</td> <td>195</td> <td>16</td> </tr> </tbody> </table>	Ø mm.	L mm.	S mm.	55	195	16	
Ø mm.	L mm.	S mm.								
55	195	16								
	925007	42541438 42002125	Supporto oscill.trasmissione <i>Transmission support</i>	TURBOTECH 190.24/26/30/32 240.26						
			<table border="1"> <thead> <tr> <th>Ø mm.</th> <th>L mm.</th> <th>S mm.</th> </tr> </thead> <tbody> <tr> <td>60</td> <td>200</td> <td>36</td> </tr> </tbody> </table>	Ø mm.	L mm.	S mm.	60	200	36	
Ø mm.	L mm.	S mm.								
60	200	36								



Illustrazione Illustration	Ns.Rif. Our Ref.	Rif.Costr. O.E. Ref.	Descrizione Description	Tipo di veicolo Vehicle Type						
	925008	42536525 93157125	Supporto oscill.trasmissione <i>Transmission support</i>	TURBOSTAR 190.36/42 - 240.36 - 260.36 TURBOTECH 190.36 - 240.36 - 260.36						
			<table border="1"> <thead> <tr> <th>Ø mm.</th> <th>L mm.</th> <th>S mm.</th> </tr> </thead> <tbody> <tr> <td>60</td> <td>220</td> <td>20</td> </tr> </tbody> </table>	Ø mm.	L mm.	S mm.	60	220	20	
Ø mm.	L mm.	S mm.								
60	220	20								
GHISA CAST IRON 	925014	42536962 42087410	Supporto oscill.trasmissione <i>Transmission support</i>	TURBOSTAR 190.33/36/42/48 240.36/48 - 260.36/48 TURBOTECH 190.36 - 240.36 - 260.36 330.30 EUROTECH 180E24 - 190E42 240E42 - 260E38/E42 EUROSTAR 190-240E42/E47 260E42/E37/E42 EUROTRAKKER 260E37/E42/E47 340E34/E37/E42 410E37/E42						
			<table border="1"> <thead> <tr> <th>Ø mm.</th> <th>L mm.</th> <th>S mm.</th> </tr> </thead> <tbody> <tr> <td>70</td> <td>220</td> <td>44</td> </tr> </tbody> </table>	Ø mm.	L mm.	S mm.	70	220	44	
Ø mm.	L mm.	S mm.								
70	220	44								
LAMIERA SHEET METAL 	925016	42087542	Supporto oscill.trasmissione <i>Transmission support</i>	TURBOSTAR 190.33/36/42 240.36 - 260.36 TURBOTECH 190.36 - 240.36 - 260.36						
		1235569		<table border="1"> <thead> <tr> <th>Ø mm.</th> <th>L mm.</th> <th>S mm.</th> </tr> </thead> <tbody> <tr> <td>70</td> <td>220</td> <td>20</td> </tr> </tbody> </table>	Ø mm.	L mm.	S mm.	70	220	20
Ø mm.	L mm.	S mm.								
70	220	20								
	925011	42536961 93157626	Supporto oscill.trasmissione <i>Transmission support</i>	TURBOSTAR 190.36/42 - 240.36 - 260.36 TURBOTECH 190.36 - 240.36 - 260.36 EUROTECH 180E34/E42 190-240E34/E38/E42 EUROTRAKKER 190E37 - 260E30/E34 340E34 EUROSTAR 190-240E38/E42/E47E52						
			<table border="1"> <thead> <tr> <th>Ø mm.</th> <th>L mm.</th> <th>S mm.</th> </tr> </thead> <tbody> <tr> <td>70</td> <td>220</td> <td>37</td> </tr> </tbody> </table>	Ø mm.	L mm.	S mm.	70	220	37	
Ø mm.	L mm.	S mm.								
70	220	37								

Illustrazione <i>Illustration</i>	Ns.Rif. <i>Our Ref.</i>	Rif.Costr. <i>O.E. Ref.</i>	Descrizione <i>Description</i>	Tipo di veicolo <i>Vehicle Type</i>						
<p>GHISA CAST IRON</p>    	925004	42536963 93163689	Supporto oscill.trasmissione <i>Transmission support</i> <table border="1" data-bbox="767 488 1118 591"> <thead> <tr> <th>Ø mm.</th> <th>L mm.</th> <th>S mm.</th> </tr> </thead> <tbody> <tr> <td>70</td> <td>220</td> <td>20</td> </tr> </tbody> </table>	Ø mm.	L mm.	S mm.	70	220	20	EUROTECH 180E34/E42 190-240E34/E38/E42 EUROSTAR 190-240E38/E42/E47/E52 EUOTRAKKER 190E37 260E30/E34 340E34
	Ø mm.	L mm.	S mm.							
	70	220	20							
	925028	42541437 93190884	Supporto oscill.trasmissione <i>Transmission support</i> <table border="1" data-bbox="767 943 1118 1046"> <thead> <tr> <th>Ø mm.</th> <th>L mm.</th> <th>S mm.</th> </tr> </thead> <tbody> <tr> <td>70</td> <td>220</td> <td>20</td> </tr> </tbody> </table>	Ø mm.	L mm.	S mm.	70	220	20	EUROTECH EUROSTAR EUOTRAKKER CURSOR STRALIS
Ø mm.	L mm.	S mm.								
70	220	20								
925029	93192572	Supporto oscill.trasmissione <i>Transmission support</i> <table border="1" data-bbox="767 1417 1118 1520"> <thead> <tr> <th>Ø mm.</th> <th>L mm.</th> <th>S mm.</th> </tr> </thead> <tbody> <tr> <td>75</td> <td>220</td> <td>20</td> </tr> </tbody> </table>	Ø mm.	L mm.	S mm.	75	220	20	EUROTECH EUROSTAR EUOTRAKKER EUOTRAKKER CURSOR STRALIS	
Ø mm.	L mm.	S mm.								
75	220	20								
925035	42538361	Supporto oscill.trasmissione <i>Transmission support</i> <table border="1" data-bbox="767 1917 1118 2020"> <thead> <tr> <th>Ø mm.</th> <th>L mm.</th> <th>S mm.</th> </tr> </thead> <tbody> <tr> <td>75</td> <td>220</td> <td>20</td> </tr> </tbody> </table>	Ø mm.	L mm.	S mm.	75	220	20	EUROTECH CURSOR STRALIS	
Ø mm.	L mm.	S mm.								
75	220	20								



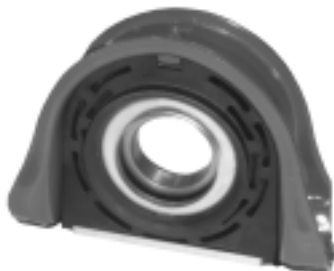

Illustrazione Illustration	Ns.Rif. Our Ref.	Rif.Costr. O.E. Ref.	Descrizione Description	Tipo di veicolo Vehicle Type		
	925036	81394106019	Supporto oscill.trasmissione <i>Transmission support</i>	MAN F2000 - L2000 - M2000 TGA		
			<table border="1"> <thead> <tr> <th>Ø mm.</th> <th>L mm.</th> <th>S mm.</th> </tr> </thead> <tbody> <tr> <td>65</td> <td>230</td> <td>23</td> </tr> </tbody> </table>		Ø mm.	L mm.
Ø mm.	L mm.	S mm.				
65	230	23				

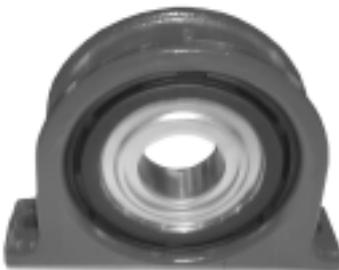
Illustrazione Illustration	Ns.Rif. Our Ref.	Rif.Costr. O.E. Ref.	Descrizione Description	Tipo di veicolo Vehicle Type						
	925037	6014102110 9014110412	Supporto oscill.trasmissione <i>Transmission support</i>	MERCEDES SPRINTER 207-208-210 308-310 407-408-409-410						
			<table border="1"> <thead> <tr> <th>Ø mm.</th> <th>L mm.</th> <th>S mm.</th> </tr> </thead> <tbody> <tr> <td>45</td> <td>195</td> <td>18</td> </tr> </tbody> </table>		Ø mm.	L mm.	S mm.	45	195	18
Ø mm.	L mm.	S mm.								
45	195	18								
	925033	9734100022 3855860141	Supporto oscill.trasmissione <i>Transmission support</i>	MERCEDES ATEGO Serie LK - MK Serie NG - SK						
	925034	6554100022	Supporto oscill.trasmissione <i>Transmission support</i>	MERCEDES ACTROS 1996 1831-1835-1840-1843-1848 1853-1857- 2031-2035-2040 2053-2531-2535-2540-2543 2548-2553-2557-2631-2635 2640-2643-2648-2653-2657 3231-3235-3240-3243 3331-3335-3340-3343-3348 3353-3357-4140-4143-4148 ATEGO II 1823-1828 - 2523-2528 - 2628 Serie NK-NG-SK						
			<table border="1"> <thead> <tr> <th>Ø mm.</th> <th>L mm.</th> <th>S mm.</th> </tr> </thead> <tbody> <tr> <td>70</td> <td>247,60</td> <td>20</td> </tr> </tbody> </table>	Ø mm.	L mm.	S mm.	70	247,60	20	
Ø mm.	L mm.	S mm.								
70	247,60	20								

MERCEDES PARTI TRASMISSIONE E DIFFERENZIALE TRANSMISSION AND DIFFERENTIAL PARTS

EMMERRE

Illustrazione <i>Illustration</i>	Ns.Rif. <i>Our Ref.</i>	Rif.Costr. <i>O.E. Ref.</i>	Descrizione <i>Description</i>	Tipo di veicolo <i>Vehicle Type</i>		
	925040	6564110012	Supporto oscill.trasmissione <i>Transmission support</i>	MERCEDES ACTROS ACTROS 2003		
			<table border="1"> <thead> <tr> <th>Ø mm.</th> <th>L mm.</th> <th>S mm.</th> </tr> </thead> <tbody> <tr> <td>70</td> <td>87</td> <td>52</td> </tr> </tbody> </table>		Ø mm.	L mm.
Ø mm.	L mm.	S mm.				
70	87	52				

VOLVO

PARTI TRASMISSIONE E DIFFERENZIALE TRANSMISSION AND DIFFERENTIAL PARTS

EMMERRE



Illustrazione <i>Illustration</i>	Ns.Rif. <i>Our Ref.</i>	Rif.Costr. <i>O.E. Ref.</i>	Descrizione <i>Description</i>	Tipo di veicolo <i>Vehicle Type</i>						
 	925015	8171366	Supporto oscill.trasmissione <i>Transmission support</i>	VOLVO FH 12						
			<table border="1"> <thead> <tr> <th>Ø mm.</th> <th>L mm.</th> <th>S mm.</th> </tr> </thead> <tbody> <tr> <td>70</td> <td>-</td> <td>-</td> </tr> </tbody> </table>		Ø mm.	L mm.	S mm.	70	-	-
Ø mm.	L mm.	S mm.								
70	-	-								
	926002	1696389	Supporto oscill.trasmissione <i>Transmission support</i>	VOLVO FL 12						
			<table border="1"> <thead> <tr> <th>Ø mm.</th> <th>L mm.</th> <th>S mm.</th> </tr> </thead> <tbody> <tr> <td>60</td> <td>190,30</td> <td>25</td> </tr> </tbody> </table>	Ø mm.	L mm.	S mm.	60	190,30	25	
Ø mm.	L mm.	S mm.								
60	190,30	25								







Illustrazione <i>Illustration</i>	Ns.Rif. <i>Our Ref.</i>	Rif.Costr. <i>O.E. Ref.</i>	Descrizione <i>Description</i>	Tipo di veicolo <i>Vehicle Type</i>
	934015	967265	Crociera completa Ø 27 x 74,60 <i>Complet universal joint cross Ø 27 x 74,60</i>	615 - 616
	934019	42532985	Crociera completa Ø 27 x 74,60 <i>Complet universal joint cross Ø 27 x 74,60</i>	NEW DAILY 96 30.8 - 35.8 TURBO DAILY 96 30.10
	934016	1905986 9984381 93163407	Crociera completa Ø 27 x 81,7 <i>Complet universal joint cross Ø 27 x 81,7</i>	DAILY RESTYLING 30.8-35.8-40.8 - 35.10 NEW DAILY 30.8-35.8-40.8 - 35.10
	934022	42541372 42535109	Crociera completa Ø 27 x 74,60 <i>Complet universal joint cross Ø 27 x 74,60</i>	DAILY CITY 2000 35S9/S11 35C9/C11 35S10/S12 35C10/C12
	934014	42546332 42530886	Crociera completa Ø 30,17 x 82 <i>Complet universal joint cross Ø 30,17 X 82</i>	TURBODAILY 96 35.10-49.10 35.12-49.12-59.12
	934018	8197741	Crociera completa Ø 30,20 x 92.00 <i>Complet universal joint cross Ø 30.20 x 92.00</i>	NEW DAILY 96 30.8 - 35.8 TURBO DAILY 96 30.10





Illustrazione <i>Illustration</i>	Ns.Rif. <i>Our Ref.</i>	Rif.Costr. <i>O.E. Ref.</i>	Descrizione <i>Description</i>	Tipo di veicolo <i>Vehicle Type</i>
	934017	92601339 4675624	Crociera completa <i>Complet universal joint cross</i> Ø 30,17 X 106,28	DAILY RESTYLING 35.10-45.10-49.10 ZETA 50.9 - 65.9 TURBOZETA 60.11
	934023	42541373 42535251	Crociera completa Ø 30,17 x 82 <i>Complet universal joint cross</i> Ø 30,17 X 82	DAILY CITY 2000 35S13/S15 35C13/C15 50C11/C13/C15 65C13/C15
	934024	42535253	Crociera completa Ø 30,17 x 106,28 <i>Complet universal joint cross</i> Ø 30,17 X 106,28	DAILY CITY 2000 35S13/S15 35C13/C15 50C11/C13/C15 65C11/C13/C15
	934021	42546224 93160221 42532573	Crociera completa Ø 34,90 x 92,50 <i>Complet universal joint cross</i> Ø 34,90 X 92,50	TURBODAILY 59.12 EUROCARGO 60E10/E12/E14 65E10/E12/E14 75E12/E14
	934032	93160225	Crociera completa Ø 35 x 106,4 <i>Complet universal joint cross</i> Ø 35 x 106,4	EUROCARGO 75-80-95-100





Illustrazione <i>Illustration</i>	Ns.Rif. <i>Our Ref.</i>	Rif.Costr. <i>O.E. Ref.</i>	Descrizione <i>Description</i>	Tipo di veicolo <i>Vehicle Type</i>
	934033	42532346	Crociera completa Ø 41,2 x 126 <i>Complet universal joint cross Ø 41,2 x 126</i>	EUROCARGO 100-120-130-150
	934035	42533841 93160228	Crociera completa Ø 42 x 119,4 <i>Complet universal joint cross Ø 42 x 119,4</i>	EUROCARGO EUROCARGO TECTOR 75-100-120-130-140
	934034	93160516	Crociera completa Ø 47,6 x 135,2 <i>Complet universal joint cross Ø 47,6 x 135,2</i>	EUROCARGO 95-135-150-170-180-260
	934037	93192015	Crociera completa Ø 48 x 135 <i>Complet universal joint cross Ø 48 x 135</i>	EUROCARGO EUROTECH EUROTRAKKER
	934027	8198583 2969532	Crociera completa Ø 52 x 133 <i>Complet universal joint cross Ø 52 X 133</i>	180.24/26 - 190.35 - 260 - 330 TURBOTECH 330-AP160 TURBOCITY 480





Illustrazione <i>Illustration</i>	Ns.Rif. <i>Our Ref.</i>	Rif.Costr. <i>O.E. Ref.</i>	Descrizione <i>Description</i>	Tipo di veicolo <i>Vehicle Type</i>
	934038	42533410 93163090 93192012	Crociera completa Ø 52 x 147,2 <i>Complet universal joint cross</i> Ø 52 x 147,2	EUROTECH EUROSTAR EUROTRAKKER CURSOR STRALIS
	923104	93190028 42491973	Crociera completa Ø 57 x 144 <i>Complet universal joint cross</i> Ø 57 x 144	EUROTECH
	934039	42537896 42533784	Crociera completa Ø 57 x 152 <i>Complet universal joint cross</i> Ø 57 x 152	EUROTECH EUROSTAR EUROTRAKKER CURSOR STRALIS
	934040	93157114 93160297	Crociera completa Ø 57 x 172 <i>Complet universal joint cross</i> Ø 57 x 172	EUROTECH EUROSTAR EUROTRAKKER
	934041	93159498 93156581	Crociera completa Ø 65 x 172 <i>Complet universal joint cross</i> Ø 65 x 172	EUROTECH EUROSTAR EUROTRAKKER



Illustrazione <i>Illustration</i>	Ns.Rif. <i>Our Ref.</i>	Rif.Costr. <i>O.E. Ref.</i>	Descrizione <i>Description</i>	Tipo di veicolo <i>Vehicle Type</i>
	934028	337058	Crociera completa Ø 38 x 148 <i>Complet universal joint cross Ø 38 X 148</i> (AD ESAURIMENTO)	SCANIA
	934030	264043	Crociera completa Ø 44 x 149 <i>Complet universal joint cross Ø 44 X 149</i> (AD ESAURIMENTO)	SCANIA 140 - 141
	934029	294383 365913	Crociera completa Ø 48 x 161 <i>Complet universal joint cross Ø 48 X 161</i> (AD ESAURIMENTO)	SCANIA 144



Illustrazione <i>Illustration</i>	Ns.Rif. <i>Our Ref.</i>	Rif.Costr. <i>O.E. Ref.</i>	Descrizione <i>Description</i>	Tipo di veicolo <i>Vehicle Type</i>
	933435	42037489	Scatola riduttore <i>Planetary carrier</i>	175.24-190.26/30-190.38TRW 330.26/30/35/36 - AP160 TURBOCITY 480 - 580 - 680
	933434	42118227	Scatola riduttore porta satelliti <i>Planetary carrier</i>	EUROTRAKKER 190E30/E31/E34/E37/E42 260E30/E34/E37/E42/E47 330E34/E37 - 340E37/E42 380E31/E34/E37/E42 400E31/E34/E37/E42 410E37/E42 440E34/E37/E42 720E31/E37/E42 EUROTRAKKER CURSOR 180E24/E27 190E24/E27/E31/E35/E38/E44 260E31/E35/E38/E44 340E35/E38/E44 380E35/E38/E44/E48 400E38/E44 410E35/E38/E44/E48 440E38/E44 720E38/E44/E48 STRALIS 440S40/S43

Illustrazione <i>Illustration</i>	Ns.Rif. <i>Our Ref.</i>	Rif.Costr. <i>O.E. Ref.</i>	Descrizione <i>Description</i>	Tipo di veicolo <i>Vehicle Type</i>
	933454	42118606 42062798	Coperchio scatola riduttore <i>Planetary carrier cover</i>	EUROTRAKKER 180E25 190E30/E31/E34/E37/E42 260E34/E37/E42 330E34/E37 380E31/E37/E42 400E37 - 720E31/E37/E42 EUROTRAKKER CURSOR 180E24/E27 190E31/E35/E38/E44 260E35/E38/E44 380E35/E38/E44 400E38/E44 410E44 - 720E44
	933455	42118921	Coperchio scatola riduttore <i>Planetary carrier cover</i>	EUROTRAKKER 190E30/E31/E34/E37/E42 260E30/E34/E37/E42/E47 330E34/E37 - 340E37/E42 380E31/E34/E37/E42 400E31/E34/E37/E42 410E37/E42 440E34/E37/E42 720E31/E37/E42 EUROTRAKKER CURSOR 180E24/E27 190E24/E27/E31/E35/E38/E44 260E31/E35/E38/E44 340E35/E38/E44 380E35/E38/E44/E48 400E38/E44 410E35/E38/E44/E48 440E38/E44 720E38/E44/E48 STRALIS 440S40/S43

Illustrazione <i>Illustration</i>	Ns.Rif. <i>Our Ref.</i>	Rif.Costr. <i>O.E. Ref.</i>	Descrizione <i>Description</i>	Tipo di veicolo <i>Vehicle Type</i>
	933406	4459828	Planetario riduttore <i>Planet gear</i>	175.24-190.26/30-190.38TRW 330.26/30/35/36 - AP160 TURBOCITY 480 - 580 - 680
	933407	42064799	Planetario riduttore <i>Planet gear</i>	EUROTRAKKER 190E30/E31/E34/E37/E42 260E30/E34/E37/E42/E47 330E34/E37 - 340E37/E42 380E31/E34/E37/E42 400E31/E34/E37/E42 410E37/E42 440E34/E37/E42 720E31/E37/E42 EUROTRAKKER CURSOR 180E24/E27 190E24/E27/E31/E35/E38/E44 260E31/E35/E38/E44 340E35/E38/E44 380E35/E38/E44/E48 400E38/E44 410E35/E38/E44/E48 440E38/E44 720E38/E44/E48 STRALIS 440S40/S43



Illustrazione <i>Illustration</i>	Ns.Rif. <i>Our Ref.</i>	Rif.Costr. <i>O.E. Ref.</i>	Descrizione <i>Description</i>	Tipo di veicolo <i>Vehicle Type</i>
	933405	42159023	Satellite riduttore <i>Satellite gear</i>	175.24-190.26/30-190.38TRW 330.26/30/35/36 - AP160 TURBOCITY 480 - 580 - 680
	933404	42064798	Satellite riduttore <i>Satellite gear</i>	EUROTRAKKER 190E30/E31/E34/E37/E42 260E30/E34/E37/E42/E47 330E34/E37 - 340E37/E42 380E31/E34/E37/E42 400E31/E34/E37/E42 410E37/E42 440E34/E37/E42 720E31/E37/E42 EUROTRAKKER CURSOR 180E24/E27 190E24/E27/E31/E35/E38/E44 260E31/E35/E38/E44 340E35/E38/E44 380E35/E38/E44/E48 400E38/E44 410E35/E38/E44/E48 440E38/E44 720E38/E44/E48 STRALIS 440S40/S43







Illustrazione <i>Illustration</i>	Ns.Rif. <i>Our Ref.</i>	Rif.Costr. <i>O.E. Ref.</i>	Descrizione <i>Description</i>	Tipo di veicolo <i>Vehicle Type</i>
	933415	2477919	Perno portasatellite riduttore <i>Planetary pin</i>	175.24-190.26/30-190.38TRW 330.26/30/35/36 - AP160 TURBOCITY 480 - 580 - 680
	933412	42064785	Perno portasatellite riduttore <i>Planetary pin</i>	EUROTRAKKER 190E30/E31/E34/E37/E42 260E30/E34/E37/E42/E47 330E34/E37 - 340E37/E42 380E31/E34/E37/E42 400E31/E34/E37/E42 410E37/E42 440E34/E37/E42 720E31/E37/E42 EUROTRAKKER CURSOR 180E24/E27 190E24/E27/E31/E35/E38/E44 260E31/E35/E38/E44 340E35/E38/E44 380E35/E38/E44/E48 400E38/E44 410E35/E38/E44/E48 440E38/E44 720E38/E44/E48 STRALIS 440S40/S43
	103640	42118229	Anello tenuta mozzo <i>Hub O-Ring</i>	EUROTRAKKER T.T. EUROTRAKKER CURSOR T.T. EUROTECH 190E42 440E42
	931024	7166472	Boccola distanziale <i>Spacer bushing</i>	OM40 - 40-50-55NC

Illustrazione <i>Illustration</i>	Ns.Rif. <i>Our Ref.</i>	Rif.Costr. <i>O.E. Ref.</i>	Descrizione <i>Description</i>	Tipo di veicolo <i>Vehicle Type</i>
	933471	-	Kit guarnizioni riduttore per raggiera <i>Reducer kit gaskets</i>	EUROCARGO 150E15/E18 330.26/30/35
	933470	-	Kit guarnizioni riduttore per mozzo <i>Hub reducer kit gaskets</i>	EUROTRAKKER 260-340E30/E34/E37 190.26H-330.26H-330.30AN 330.36H 190.26/30/35/38
	933444	42118478	Guarnizione riduttore per mozzo e raggiera <i>Hub reducer gaskets</i>	EUROCARGO 150E15/E18 330.26/30/35 EUROTRAKKER 260-340E30/E34/E37 190.26H-330.26H-330.30AN 330.36H 190.26/30/35/38
	103637	42026473	Anello tenuta raggiera <i>O-ring</i>	EUROCARGO 150E15/E18 330.26/30/35
	103639	4459785	Anello tenuta scatola differenziale <i>Differential case o-ring</i>	EUROTRAKKER 190E30/E31/E34/E37/E42 260E30/E34/E37/E42/E47 330E34/E37 - 340E34/E37/E42 380E31/E34/E37/E42/E47 400E31/E34/E37/E42 440E34/E37/E42 720E31/E37/E42/E47 EUROTRAKKER CURSOR 180E24 - 190E24/E31/E35 260E31/E35 340-380-400-410E35 330.26H-330.30AN-330.36H
	931207	3555488	Ghiera ponte <i>Nut</i>	175.24-190.26/30-190.38TRW 330.26/30/35/36 - AP160 TURBOCITY 480 - 580 - 680 EUROTRAKKER 190E30/E31/E34/E37/E42 260E30/E34/E37/E42/E47 330E34/E37 - 340E34/E37/E42 380E31/E34/E37/E42/E47 400E31/E34/E37/E42 440E34/E37/E42 720E31/E37/E42/E47 EUROTRAKKER CURSOR 180E24 - 190E24/E31/E35 260E31/E35 340-380-400-410E35

933436

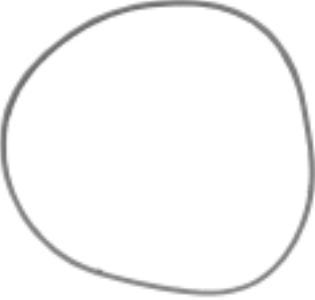
Scatola riduttore per mozzo completa e montata **TIPO ALTO**
*Hub planetary carrier complete and assembly **HIGH TYPE***

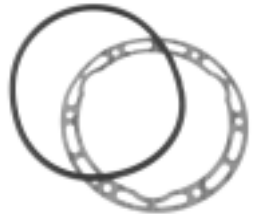
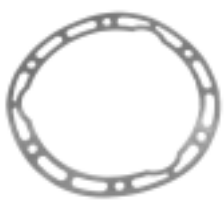
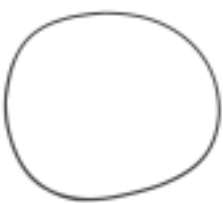
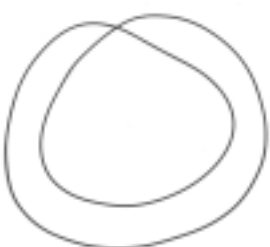

175.24-190.26/30-190.38TRW 330.26/30/35/36

AP160 - **TURBOCITY** 480 - 580 - 680

Composta da - *Composed by:*

933435	42037489	Scatola riduttore	q.tà	1
-	1101586	Pernetto	q.tà	1
-	1101642	Seeger	q.tà	1
933405	42159023	Satellite riduttore	q.tà	3
933415	2477919	Perno portasatellite	q.tà	3
933448	2443705	Rasamento	q.tà	3
933447	2478064	Spina cilindrica	q.tà	3
933406	4459828	Planetario	q.tà	1

933437

Scatola riduttore per mozzo completa e montata (senza planetario 4459828) **TIPO ALTO**
*Hub planetary carrier complete and assembly (without planet gear) **HIGH TYPE***



175.24-190.26/30-190.38TRW 330.26/30/35/36

AP160 - **TURBOCITY** 480 - 580 - 680

Composta da - *Composed by:*

933435	42037489	Scatola riduttore	q.tà	1
-	1101586	Pernetto	q.tà	1
-	1101642	Seeger	q.tà	1
933405	42159023	Satellite riduttore	q.tà	3
933415	2477919	Perno portasatellite	q.tà	3
933448	2443705	Rasamento	q.tà	3
933447	2478064	Spina cilindrica	q.tà	3

933442Scatola riduttore per mozzo completa e montata **senza planetario**
*Hub planetary carrier complete and assembly **without planetary*****EUROTRAKKER**190E30/E31/E34/E37/E42
260E30/E34/E37/E42/E47
330E34/E37
340E37/E42
380E31/E34/E37/E42
400E31/E34/E37/E42
410E37/E42
440E34/E37/E42
720E31/E37/E42**EUROTRAKKER CURSOR**180E24/E27
190E24/E27/E31/E35/E38/E44
260E31/E35/E38/E44
340E35/E38/E44
380E35/E38/E44/E48
400E38/E44
410E35/E38/E44/E48
440E38/E44
720E38/E44/E48**STRALIS**

400S40/S43

Composta da - *Composed by:*

933434	42118227	Scatola riduttore	q.tà	1
933404	42064798	Satellite riduttore	q.tà	3
933412	42064785	Perno portasatellite	q.tà	3
933448	2443705	Rasamento	q.tà	3
933450	-	Perno con testa	q.tà	3
933447	2478064	Spina cilindrica	q.tà	3

933459

Scatola riduttore per mozzo completa di coperchio **senza planetario**
*Hub planetary carrier complete and assembly **without planetary***



EUROTRAKKER

Composto da - *Composed by:*

933442	-	Scatola riduttore	q.tà	1
-	2478435	Guarnizione	q.tà	1
-	1107286	Rosetta elastica	q.tà	6
-	16607624	Vite	q.tà	6
-	1101642	Seeger	q.tà	1
-	1101586	Perno	q.tà	1
-	16509011	Dado	q.tà	1
-	16508460	Rondella rame	q.tà	1
-	2476603	Vite registro	q.tà	1
-	1118980	Tappo	q.tà	1

933475

Scatola riduttore per mozzo completa di coperchio **con planetario**
*Hub planetary carrier complete and assembly **with planetary***



EUROTRAKKER

Composto da - *Composed by:*

933442	-	Scatola riduttore	q.tà	1
933407	42064799	Planetario	q.tà	1
-	2478435	Guarnizione	q.tà	1
-	1107286	Rosetta elastica	q.tà	6
-	16607624	Vite	q.tà	6
-	1101642	Seeger	q.tà	1
-	1101586	Perno	q.tà	1
-	16509011	Dado	q.tà	1
-	16508460	Rondella rame	q.tà	1
-	2476603	Vite registro	q.tà	1
-	1118980	Tappo	q.tà	1

Illustrazione <i>Illustration</i>	Ns.Rif. <i>Our Ref.</i>	Rif.Costr. <i>O.E. Ref.</i>	Descrizione <i>Description</i>	Tipo di veicolo <i>Vehicle Type</i>
	953201	7184091	Coperchio mozzo ruota completo di tappo <i>Wheel hub cover with plug</i>	<p>EUROCARGO 170E15/E18/E21/E23/E27 TECTOR 180E21/E24/E28 EUROTECH 180E24/E27/E30/E34/E38/E42 190E24/E27/E30/E34/E38/E42 240E34/E38/E42 - 260E38/E42 325E27 - 330E34/E37 340E34/E37/E42 380E31/E34/E37 400E30/E34/E38/E42 410E37/E42 - 440E34/E38/E42 720E31/E37/E42/E48 EUROTECH CURSOR 190E24/E31/E35/E39/E43 260E24/E31/E35/E39/E43 440E31/E35/E39/E43 EUROTRAKKER 190E30/E31/E34/E37/E42 260E30/E34/E37 400E31/E34/E37/E42 - 440E42 EUROTRAKKER CURSOR 190E24/E27/E31/E35/E38/E44 260E31/E35/E38/E44 340E35/E38/E44 380E35/E38/E44/E48 400E35/E38/E44 410E35/E38/E44/E48 720E38/E44/E48 EUROSTAR 180E38 - 190E38/E42/E47/E52 240E38/E42/E47/E52 400E38/E42/E47/E52 440E38/E42/E47/E52 EUROSTAR CURSOR 190E39/E43 - 260E39/E43/E47 440E39/E43/E46/E48 STRALIS 190S27/S31/S3540/S43/S48 260S31/S35/S40/S43/S44 260S48/S54 440S31/S35/S40/S43/S44 440S48/S54</p>

Illustrazione <i>Illustration</i>	Ns.Rif. <i>Our Ref.</i>	Rif.Costr. <i>O.E. Ref.</i>	Descrizione <i>Description</i>	Tipo di veicolo <i>Vehicle Type</i>
	953202	7184092	Coperchio mozzo ruota completo di tappo <i>Wheel hub cover with plug</i>	EUROCARGO 75E13/E14/E15/E17/E18 EUROCARGO TECTOR
	953200	7184090	Coperchio mozzo ruota <i>Wheel hub cover</i>	EUROCARGO TECTOR
	933413	42037779	Parapolvere per mozzo <i>Hub dust protection</i> (AD ESAURIMENTO)	175.24-190.26/30-190.38TRW 330.26/30/35/36 - AP160 TURBOCITY 480 - 580 - 680
	933414	42037552	Parapolvere per raggiera <i>Dust protection</i> (AD ESAURIMENTO)	190.33/35- 330

Illustrazione <i>Illustration</i>	Ns.Rif. <i>Our Ref.</i>	Rif.Costr. <i>O.E. Ref.</i>	Descrizione <i>Description</i>	Tipo di veicolo <i>Vehicle Type</i>
	933400	93803594	Cerchio ruota 16" (tipo Gianetti 5JKX) <i>Disc wheel 16"</i> (<i>type Gianetti 5JKX</i>)	DAILY RESTYLING 35.8 - 40.8 35.10 - 45.10 - 49.10 NEW DAILY (96) 35.8 - 35.10 TURBODAILY (96) 35.10 - 35.12
	933401	98464866 500307777	Cerchio ruota 16" (tipo Gianetti 6J-16H2) <i>Disc wheel 16"</i> (<i>type Gianetti 6J-16H2</i>)	TURBODAILY (96) 59.12 DAILY CITY 2000 65C11/C13/C15 EUROCARGO 60E10/E12/E14 65E10/E12/E14 75E12/E14/E15 EUROCARGO TECTOR 75E13/E15/E17
	933402	500330665	Cerchio ruota 5,5Jx16" H1 <i>Disc wheel 5,5Jx16" H1</i> (con foro tondo) (with round hole)	DAILY CITY 2000 35C9/C11/C13 35C10/C12
	933403	504003565	Cerchio ruota 5,5Jx16" H1 <i>Disc wheel 5,5Jx16" H1</i> (con foro rettangolare) (with rectangular hole)	DAILY CITY 2000 35C9/C11/C13 35C10/C12
	933408	93826384	Cerchio ruota 5 JKx16" (Gianetti) <i>Disc wheel 5 JKx16"</i> (Gianetti)	DAILY CITY 2000 35C9/C11/C13/C15 50C11/C13/C15

SPESSORI PER REGISTRO PIGNONE CONICO REGISTER BEVEL PIGNON THICKNESS

Illustrazione <i>Illustration</i>	Ns.Rif. <i>Our.Ref.</i>	Rif.Costr. <i>O.E. Ref.</i>	Ø Ø	S S	Q.tà <i>Q.ty</i>	Tipo di veicolo <i>Vehicle Type</i>
	941510	8557989-98	40.4	0.10	25	FIAT 616N3/N4 - 625N3-50NC
	941511	8553742-44	40.4	0.15	25	50F - 55F
	941512	8563404-12	40.4	0.20	25	OM40/35 - 50-55
	941513	8548975-78	35	0.10	25	FIAT 60-70-75
	941514		35	0.15	25	OM - Leoncino 35 - Daino 45
	941515	8661350	35	0.20	25	FIAT 65-70-75
	941516		45	0.10	25	FIAT 80-90NC
	941517	4656957-76	45	0.15	25	645N1/N2/N3
	941518		45	0.20	25	650N1/N2/N3 - OM90 - Tigrotto
	941519		50	0.10	25	FIAT 80-90-100-110-130
	941520	4657402	50	0.15	25	662N3 - 673N
	941521		50	0.20	25	OM80-90-100-110-130
	941522	4550773-74	50.3	0.10	25	
	941524	4658194-8213	50.3	0.20	25	FIAT 643N/N1 - 684N
	941525	4037734	70.2	0.10	25	
	941526		70.2	0.15	25	FIAT 682N3 (1°serie) - 690N1
	941528	4551597-98	55.4	0.10	25	
	941529		55.4	0.15	25	FIAT 682N3 (2°serie) - 690N3
	941530	4628860	55.4	0.20	25	
941531		60	0.10	25	FIAT 682N3/N4 - 690N4 - 691N	
941532	4619761-75	60	0.15	25	180NC - 684N U.T. - 160NC	
941533		60	0.20	25	619N1 - 170.26 - 170.35 - 190.35	
941534		40.2	0.10	25	FIAT 693N1 - 697N/NP - 300PC	
941535	8546246	40.2	0.15	25		
941537		55.3	0.10	25	FIAT 693N1 - 697N/NP - 300PC	
941538	8546276-85	55.3	0.15	25		
941539		55.3	0.20	25	PONTE POSTERIORE	

SPESSORI PER REGISTRO SCATOLA DIFFERENZIALE REGULATOR DIFFERENTIAL BOX THICKNESS

Illustrazione <i>Illustration</i>	Ns.Rif. <i>Our.Ref.</i>	Rif.Costr. <i>O.E. Ref.</i>	Ø Ø	S S	Q.tà <i>Q.ty</i>	Tipo di veicolo <i>Vehicle Type</i>
	941550		86	0.10	25	FIAT 616N3/N4 - 625N3-50NC
	941551	8553745-48	86	0.15	25	55NC - 50F - 55F
	941552		86	0.20	25	OM40/35 - 50-55-50F-55F
	941553	8562636-45	96.2	0.10	25	FIAT 65-70-75F
	941554		96.2	0.15	25	
	941555	8562646-55	96.2	0.10	25	OM 65-70-75F







Illustrazione Illustration	Ns.Rif. Our Ref.	Rif.Costr. O.E. Ref.	Descrizione Description	Tipo di veicolo Vehicle Type
M 20 x 1,5 M 20 x 1,5 	971102	4597836	Tubo compressore L 300 mm. <i>Compressor air hose L 300 mm.</i>	645-650-110NC-619-697-300
M 22 x 1,5 M 22 x 1,5 	971106	4785531	Tubo compressore L 465 mm. <i>Compressor air hose L 465 mm.</i>	115-135.14/17
M 22 x 1,5 M 22 x 1,5 	971103	4722029	Tubo compressore L 300 mm. <i>Compressor air hose L 300 mm.</i>	170 - 190 - 370
M 22 x 1,5 M 22 x 1,5 	971104	4766191	Tubo compressore L 420 mm. <i>Compressor air hose L 420 mm.</i>	190.38 U.T. - 370.10.25 370.12.25
F 22 x 1,5 F 22 x 1,5 	971101	4589336	Tubo compressore L 360 mm. <i>Compressor air hose L 360 mm.</i>	682-690-691-180NC
M 26 x 1,5 M 26 x 1,5 	971107	-	Tubo compressore L 455 mm. (adatt. 4788907) <i>Compressor air hose L 455 mm.</i>	175.17 - 175.24 TURBOTECH 190.24/26/30/32/36 TURBOSTAR 190.36/42/48
M 26 x 1,5 M 26 x 1,5 	971109	4788907	Tubo compressore L 455 mm. corrugato <i>Corrugated compressor air hose L 455 mm.</i>	175.17 - 175.24 TURBOTECH 190.24/26/30/32/36 TURBOSTAR 190.36/42/48
F 12 x 1,25 F 12 x 1,25 	972002	4688352	Tubo comando freno motore (lunghezza mm 725) <i>Control pipe engine brake (Lenght mm. 725)</i>	170-190.26/33

Illustrazione <i>Illustration</i>	Ns.Rif. <i>Our Ref.</i>	Rif.Costr. <i>O.E. Ref.</i>	Descrizione <i>Description</i>	Tipo di veicolo <i>Vehicle Type</i>
<p>M 12 x 1,5 M 12 x 1,5</p> <p>L</p> <p>(AD ESAURIMENTO)</p> <p>Ø 14</p> <p>M 14 x 1,5</p> <p>(AD ESAURIMENTO)</p>	972013	4656174	Tubo comando freno motore (lunghezza mm 260) <i>Control pipe engine brake (Lenght mm. 260)</i>	684-160NC
	972015	4729612	Tubo comando freno motore (lunghezza mm 350) <i>Control pipe engine brake (Lenght mm. 350)</i>	170-190.33/35 - 370 Bus
	972016	8817406	Tubo comando freno motore (lunghezza mm 675) <i>Control pipe engine brake (Lenght mm. 675)</i>	673 - 130
<p>F 12 x 1,25</p> <p>F 12 x 1,25</p> <p>L</p>	975075	99464832	Tubo alzacabina L 442 mm. <i>Tipping over cabin hose Lenght 442 mm.</i>	EUROCARGO 75E14 - 80E15/E18 100E18/E21 - 130E15/E18 150E18
<p>F 12 x 1,25</p> <p>(AD ESAURIMENTO)</p>	975066	42108427	Tubo alzacabina L 3510 mm. <i>Tipping over cabin hose Lenght 3510 mm.</i>	TURBOSTAR 190.36/42/48 - 240-260.36/48 TURBOTECH 240.36
<p>F 12 x 1</p> <p>M 12 x 1</p> <p>L</p> <p>(AD ESAURIMENTO)</p>	975047	4729192	Tubo alzacabina L 464,5 mm. <i>Tipping over cabin hose Lenght 464,5 mm.</i>	TURBOSTAR 190.42 TURBOTECH 190.26/36 - 240.36

Illustrazione <i>Illustration</i>	Ns.Rif. <i>Our Ref.</i>	Rif.Costr. <i>O.E. Ref.</i>	Descrizione <i>Description</i>	Tipo di veicolo <i>Vehicle Type</i>
 <p>(AD ESAURIMENTO)</p>	975076	42089641	Tubo alzacabina L 539,5 mm. <i>Tipping over cabin hose Lenght 539,5 mm.</i>	TURBOSTAR 190.42 TURBOTECH 190.26/3
 <p>(AD ESAURIMENTO)</p>	975045	4755152	Tubo alzacabina L 387 mm. <i>Tipping over cabin hose Lenght 387 mm.</i>	TURBOSTAR 190.42 TURBOTECH 190.26/36
 <p>(AD ESAURIMENTO)</p>	975048	4665740	Tubo alzacabina L 500 mm. <i>Tipping over cabin hose Lenght 500 mm.</i>	TURBOTECH 190.26/36 - 240.26/36 - 260.36
 <p>(AD ESAURIMENTO)</p>	953313	93808619	Tubo idroguida <i>Flexible drive hose</i>	DAILY RESTYLING 30.8 - 35.8/10 - 40.8 - 49.10 115-135.14/17 EUROCARGO 65E12/E14 - 75E12/E14/E15 80E15/E18/E21 - 180E21 100E15/E18/E21 - 120E15/E18 130E15/E18 - 150E15/E18/E27

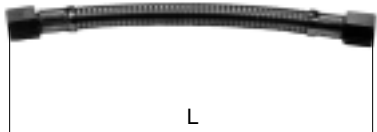
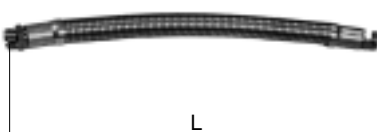
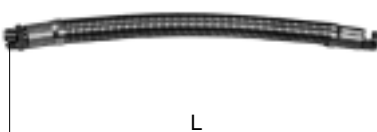

Illustrazione <i>Illustration</i>	Ns.Rif. <i>Our Ref.</i>	Rif.Costr. <i>O.E. Ref.</i>	Descrizione <i>Description</i>	Tipo di veicolo <i>Vehicle Type</i>
	972112	2486068	Tubo flessibile passaggio olio servosterzo L 310 mm. <i>Flexible pipe</i>	190-240-260.26 - 330.35
	972013	4656174	Tubo comando cambio L 267 mm. <i>Gearbox hose L 267 mm.</i>	684 - 160NC





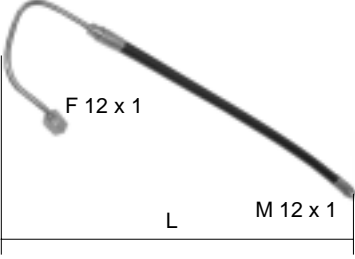
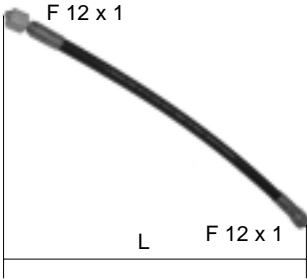
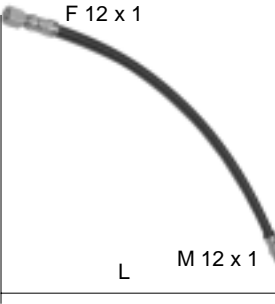
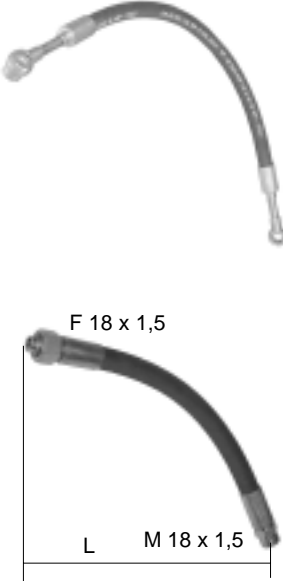

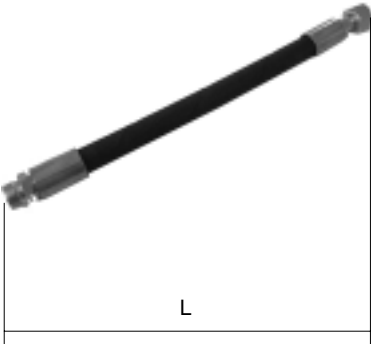
Illustrazione Illustration	Ns.Rif. Our Ref.	Rif.Costr. O.E. Ref.	Descrizione Description	Tipo di veicolo Vehicle Type
	972104	93822393 (8797513)	Tubo freno (L mm. 492) Brake pipe (L mm. 492)	NEW DAILY 96 30.8 - 35.8 TURBODAILY 96 30-35.10 - 35-49-59.12
	972105	8796958	Tubo freno (L mm. 532) Brake pipe (L mm. 532)	DAILY RESTYLING 30-35-40.8 - 35.10
	972107	93822492 (8796934)	Tubo freno (L mm. 383) Brake pipe (L mm. 383)	NEW DAILY 96 30.8 - 35.8 TURBODAILY 96 30-35.10 - 35-49-59.12
	972106	8796885	Tubo freno (L mm. 495) Brake pipe (L mm. 495)	DAILY RESTYLING 30-35-40.8 - 35.10
	972079	98409528	Tubo freno (L mm. 393) Brake pipe (L mm. 393)	EUROCARGO 60-65-70-75-80-100-180
	972082	4722497	Tubo freno (L mm. 542) Brake pipe (L mm. 542)	115-135.14/17 - 145.17 EUROCARGO TURBOTECH
	972085	4722637	Tubo freno (L mm. 645) Brake pipe (L mm. 645)	175.17/24 EUROCARGO - EUROTECH TURBOSTAR - TURBOTECH AP 160



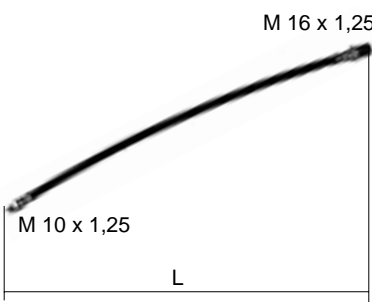
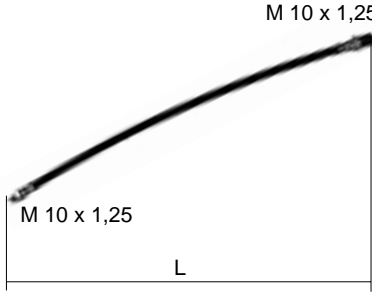
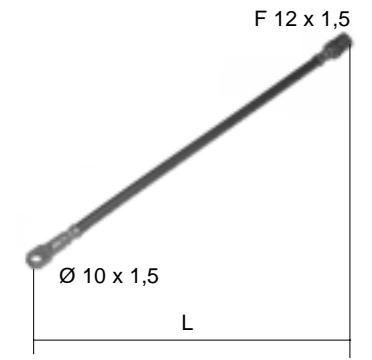
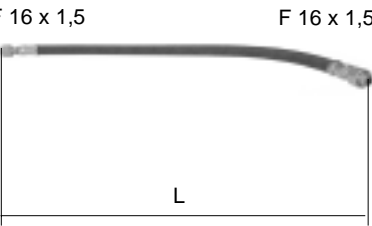



Illustrazione <i>Illustration</i>	Ns.Rif. <i>Our Ref.</i>	Rif.Costr. <i>O.E. Ref.</i>	Descrizione <i>Description</i>	Tipo di veicolo <i>Vehicle Type</i>
<p>F 18 x 1,5 F 18 x 1,5</p> <p>L</p>	972093	4742729	Tubo freno (L mm. 645) <i>Brake pipe (L mm. 645)</i>	EUROCARGO TURBOSTAR TURBOTECH EUROTRAKKER CURSOR
<p>F 18 x 1,5 F 18 x 1,5</p> <p>L</p>	972078	42106884	Tubo freno (L mm.560) <i>Brake pipe (L mm.560)</i>	EUROTECH CURSOR EUROSTAR CURSOR
<p>M 22 x 1,5</p> <p>M 22 x 1,5</p> <p>L</p>	971111	99447552	Tubo freno (L mm. 411) <i>Brake pipe (L mm. 411)</i>	EUROCARGO 150E27 - 320E27 EUROTECH 180E24/E27/E30/E34 190E24/E27/E30 - 325E27 400E30/E34 EUROTECH CURSOR 190-260E24/E31/E35 440E31/E35 EUROTRAKKER CURSOR 180E24 - 190E31/E35 260E31/E35 - 380-400E35

Illustrazione <i>Illustration</i>	Ns.Rif. <i>Our Ref.</i>	Rif.Costr. <i>O.E. Ref.</i>	Descrizione <i>Description</i>	Tipo di veicolo <i>Vehicle Type</i>
	971305	4644217	Tubo spiralato giallo <i>Yellow air brake coil</i>	Semirimorchi
	971303	4633471	Tubo spiralato rosso <i>Red air brake coil</i>	Semirimorchi
	971301	42544135 41800543	Tubo spiralato nero <i>Black air brake coil</i>	Semirimorchi
	971310	504065617 4634846	Cavo elettrico spiralato a 7 vie <i>Electical cable 7 way</i>	Semirimorchi
	971311	-	Adattatore spiralato a 15 vie <i>Adapter 15 way</i>	Autocarri - Trattori T.T.

**ARTICOLI VARI
MISCELLANEOUS PARTS**





EMMERRE

	Ns Riferim. Our Ref.	Rif. Costr. O.E. Ref.	Descrizione/Tipo di veicolo Description/Vehicle Type
<p align="center">M16x1,5 (AD ESAURIMENTO)</p>	971304	8150400/R	<p><i>Tube spiralato rosso (M16x1,5 - M16x1,5) Red air brake coil</i></p> <p>VOLVO Semirimorchi - Motrice Semi-trailers Trucks</p>
<p align="center">M16x1,5 (AD ESAURIMENTO)</p>	971307	8150400/G	<p><i>Tube spiralato giallo tipo corto a raccordi mobili (M16x1,5 - M16x1,5) Yellow air brake coil short type with moving trucks connection</i></p> <p>VOLVO Semirimorchi - Motrice Semi-trailers Trucks</p>
<p align="center">M18x1,5 (AD ESAURIMENTO)</p>	971308	647998/R	<p><i>Tube spiralato rosso (M18x1,5 girevole) Red air brake coil</i></p> <p>DAF Semirimorchi - Motrice Semi-trailers Trucks</p>
<p align="center">M18x1,5 (AD ESAURIMENTO)</p>	971309	647998/G	<p><i>Tube spiralato giallo (M18x1,5 girevole) Yellow air brake coil</i></p> <p>DAF Semirimorchi - Motrice Semi-trailers Trucks</p>

Illustrazione <i>Illustration</i>	Ns.Rif. <i>Our Ref.</i>	Rif.Costr. <i>O.E. Ref.</i>	Descrizione <i>Description</i>	Tipo di veicolo <i>Vehicle Type</i>
	971312	-	Cavo elettrico spiralato a 7 vie <i>Electrical cable 7 way</i> (AD ESAURIMENTO)	Autocarri - Trattori T.T.
	971313	500302665	Cavo elettrico per ABS - EBS 5 vie <i>ABS-EBS Electrical cable 5 way</i> (AD ESAURIMENTO)	Autocarri - Trattori T.T.
	971314	-	Cavo elettrico per EBS 7 vie <i>EBS Electrical cable 7 way</i> (AD ESAURIMENTO)	Autocarri - Trattori T.T.
	970915	99484322 2486790 4863347	Valvola drenaggio manuale <i>Manual drain valve</i>	190.26/38 - 330
	970916	4755126	Valvola drenaggio automatico <i>Automatic drain valve</i>	Motrici - Rimorchi
	971319	-	Gommino per raccordi <i>Fitting rubber</i>	Semirimorchi - Rimorchi

ARTICOLI VARI
MISCELLANEOUS PARTS

EMMERRE





Illustrazione <i>Illustration</i>	Ns.Rif. <i>Our Ref.</i>	Rif.Costr. <i>O.E. Ref.</i>	Descrizione <i>Description</i>	Tipo di veicolo <i>Vehicle Type</i>
	971315	-	Semigiunto rosso CON VALVOLA <i>Red semi-joint with valve</i>	Semirimorchi - Rimorchi
	971316	-	Semigiunto rosso SENZA VALVOLA <i>Red semi-joint without valve</i>	Semirimorchi - Rimorchi
	971317	-	Semigiunto giallo CON VALVOLA <i>Yellow semi-joint with valve</i>	Semirimorchi - Rimorchi
	971318	-	Semigiunto giallo SENZA VALVOLA <i>Yellow semi-joint without valve</i>	Semirimorchi - Rimorchi

	Ns Riferim. Our Ref.	Rif. Costr. O.E. Ref.	Descrizione/Tipo di veicolo Description/Vehicle Type
 (AD ESAURIMENTO)	971320	-	<i>Semigiunto rosso con valvola (doppia connessione) M16x1.5</i> <i>Red semi-joint with valve (double connection)</i> Daf - Iveco Man - Mercedes Renault - Scania Volvo
 (AD ESAURIMENTO)	971321	-	<i>Semigiunto rosso con valvola M22x1.5</i> <i>Red semi-joint with valve</i> Daf Iveco Man Mercedes Renault Scania Volvo
 (AD ESAURIMENTO)	971323	-	<i>Semigiunto rosso STD con filtro in linea M16x1.5</i> <i>Red semi-joint STD with filter</i> Daf
 (AD ESAURIMENTO)	971324	-	<i>Semigiunto giallo con valvola M22x1.5</i> <i>Yellow semi-joint with valve</i> Daf Iveco Man Mercedes Renault Scania Volvo

ARTICOLI VARI
MISCELLANEOUS PARTS

EMMERRE

	Ns Riferim. Our Ref.	Rif. Costr. O.E. Ref.	Descrizione/Tipo di veicolo Description/Vehicle Type
 <p>(AD ESAURIMENTO)</p>	971325	-	<p>Semigiunto giallo senza valvola M22x1.5 Yellow semi-joint without valve</p> <p>Daf Iveco Man Mercedes Renault Scania Volvo</p>
 <p>(AD ESAURIMENTO)</p>	971326	-	<p>Semigiunto giallo STD con filtro in linea M16x1.5 Yellow semi-joint STD with filter</p> <p>Daf</p>
 <p>(AD ESAURIMENTO)</p>	904055	-	<p>Filtro aria in linea M22x1.5 Air filter</p> <p>1238508 Daf 81512706026 Man 0004292995 Mercedes 110250100 Neoplan 631697 Scania 1591031 Volvo</p>
	970920	4686377	<p>Sedimentatore Decanter</p> <p>AUTOCARRI VARI</p>

Illustrazione <i>Illustration</i>	Ns.Rif. <i>Our Ref.</i>	Rif.Costr. <i>O.E. Ref.</i>	Descrizione <i>Description</i>	Tipo di veicolo <i>Vehicle Type</i>
 <p>Ø 8 Ø 6</p>	904061	RT 16	Pre-filtro gasolio piccolo Ø 42,5 mm. <i>Fuel prefilter little Ø 42,5 mm.</i>	AUTOCARRI LEGGERI T.T. HEAVY TRUCKS
 <p>Ø 10 Ø 8</p>	904060	RT 06	Pre-filtro gasolio grande Ø 41,5 mm. <i>Fuel prefilter big Ø 41,5 mm.</i>	AUTOCARRI PESANTI T.T. HEAVY TRUCKS
 <p>Ø 8 Ø 8</p>	904057	-	Pre-filtro gasolio con innesto rapido <i>Fuel pre-filter with quick coupling</i>	Gamma EURO Veicoli leggeri LIGHT VEHICLES
 <p>Ø 10 Ø 10</p>	904058	-	Pre-filtro gasolio con innesto rapido <i>Fuel pre-filter with quick coupling</i>	Gamma EURO Veicoli pesanti HEAVY TRUCKS
 <p>Ø 12 Ø 12</p>	904059	-	Pre-filtro gasolio con innesto rapido <i>Fuel pre-filter with quick coupling</i>	Gamma EURO Veicoli pesanti HEAVY TRUCKS

	Ns Riferim. Our Ref.	Rif. Costr. O.E. Ref.	Descrizione/Tipo di veicolo Description/Vehicle Type
 <p>Magnete Magnet</p> <p>Rete metallica in rame Copper wire mesh</p>	<p>904063</p>	<p>-</p>	<p><i>Prefiltro ad innesto rapido con valvola Ø 8 mm. Prefilter with quick coupling and valve Ø 8 mm.</i></p> <p>Veicoli commerciali ed industriali T.T. Commercial and industrial Vehicles</p> <p>(AD ESAURIMENTO)</p>
 <p>Magnete Magnet</p> <p>Rete metallica in rame Copper wire mesh</p>	<p>904065</p>	<p>-</p>	<p><i>Prefiltro ad innesto rapido con valvola Ø 10 mm. Prefilter with quick coupling and valve Ø 10 mm.</i></p> <p>Veicoli commerciali ed industriali T.T. Commercial and industrial Vehicles</p> <p>(AD ESAURIMENTO)</p>





Illustrazione <i>Illustration</i>	Ns.Rif. <i>Our Ref.</i>	Rif.Costr. <i>O.E. Ref.</i>	Descrizione <i>Description</i>	Tipo di veicolo <i>Vehicle Type</i>
	906904	99456723	Tappo serbatoio gasolio Ø 80 mm. chiusura a vite <i>Fuel tank plug Ø 80 mm.</i>	NEW DAILY 35.8 (1996) TURBO DAILY 35.10/12 - 49.10/12 - 59.12 EUROCARGO 95E15/E18/E21 - 135E18/E23
	906922	2993920	Tappo serbatoio gasolio Ø 60 mm. con chiave <i>Fuel tank plug Ø 60 mm.</i>	DAILY T.T. (fino al 1995)
	906919	2993923	Tappo serbatoio gasolio Ø 65 mm. con chiave <i>Fuel tank plug Ø 65 mm.</i>	DAILY CITY 2000 EUROCARGO TECTOR T.T. (dal 2003) SCANIA (dal 1998)
	906921	2993924	Tappo serbatoio gasolio Ø 80 mm. con chiave <i>Fuel tank plug Ø 80 mm.</i>	DAILY CITY 2000 EUROCARGO TECTOR T.T. (dal 2002)
	906901	2993918 500302656	Tappo serbatoio gasolio Ø 105 mm. con chiave <i>Fuel tank plug Ø 105 mm.</i>	EUROTECH EUROSTAR EUROTRAKKER

Illustrazione <i>Illustration</i>	Ns.Rif. <i>Our Ref.</i>	Rif.Costr. <i>O.E. Ref.</i>	Descrizione <i>Description</i>	Tipo di veicolo <i>Vehicle Type</i>
	970922	4797320	Supporto filtro gasolio <i>Fuel filter support</i>	TURBOSTAR 190.36/42/48 - 240.48 - 260.48 TURBOTECH 190.26/30/32 - 220.36 - 240.36 AP 160 330.30 - 330.36 TURBOCITY - CITYCLASS EUROCLASS
	970926	8124210	Kit filtro combustibile <i>Kit fuel filter</i>	TURBOTECH 190.30/32/36 - 220.36 240.36 - 260.32/36 330.26 - 330.30 - 330.35/36 AP160 - 370 TURBOCITY CITYCLASS - EUROCLASS
	970923	98439683	Supporto filtro gasolio completo <i>Complete fuel filter support</i>	EUROCARGO T.T.
	970921	500316868	Supporto filtro gasolio <i>Fuel filter support</i> (O.E.)	GAMMA EURO T.T.
	970940	500316868/A	Supporto filtro gasolio <i>Fuel filter support</i> (Commerciale - After market)	GAMMA EURO T.T.
	970924	42545573	Supporto filtro gasolio senza riscaldatore <i>Fuel filter support</i> without heater	GAMMA EURO T.T. GAMMA CURSOR STRALIS

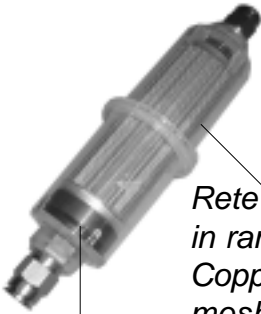
Illustrazione <i>Illustration</i>	Ns.Rif. <i>Our Ref.</i>	Rif.Costr. <i>O.E. Ref.</i>	Descrizione <i>Description</i>	Tipo di veicolo <i>Vehicle Type</i>
	970925	42545831	Supporto filtro gasolio con riscaldatore <i>Fuel filter support with heater</i>	Gamma EURO T.T. Gamma CURSOR STRALIS
	970928	504030790	Supporto filtro gasolio <i>Fuel filter support</i>	EUROCARGO TECTOR EUROTECH EUROSTAR EUROTRAKKER CURSOR STRALIS
	970929	500316676	Supporto filtro gasolio con riscaldatore <i>Fuel filter support with heater</i>	EUROCARGO EUROCARGO TECTOR EUROTECH EUROSTAR EUROTRAKKER CURSOR STRALIS
	970931	504082414	Supporto filtro gasolio con riscaldatore e filtro UFI montato UT <i>Fuel filter support with heater and filter UFI assembled last pipe</i>	EUROCARGO - EUROTECH EUROSTAR - EUROTRAKKER CURSOR STRALIS



	Ns Riferim. Our Ref.	Rif. Costr. O.E. Ref.	Descrizione/Tipo di veicolo Description/Vehicle Type
	970932	2447010033	<p><i>Adescatore gasolio</i> <i>Taking fuel</i></p> <p>Daf Man Mecedes Renaut Scania Volvo</p>
	902363	500339316 4717165	<p><i>Cilindro pompa iniezione</i> <i>Injection pump cylinder</i></p> <p>IVECO 115.17-135.17-145.17 175.17-175.24 TURBOSTAR 190.36/42/48 - 24036/48 - 260.36/48 TURBOTECH 190.30/32/36 - 220/240/260.36 330.30 - 330.35 - 330.36</p>
 <p>(AD ESAURIMENTO)</p>	902364	4799471	<p><i>Supporto pompa iniezione</i> <i>Injection pump support</i></p> <p>TURBOSTAR 190.36 330.30 - 330.35 - 330.36 TURBOTECH 190.30/36</p>











Illustrazione <i>Illustration</i>	Ns.Rif. <i>Our Ref.</i>	Rif.Costr. <i>O.E. Ref.</i>	Descrizione <i>Description</i>	Tipo di veicolo <i>Vehicle Type</i>
	970801	-	Membrana corsa corta 9" <i>Membrane short stroke 9"</i>	Veicoli vari <i>Various vehicle</i>
	970802	-	Membrana corsa corta 12" <i>Membrane short stroke 12"</i>	Veicoli vari <i>Various vehicle</i>
	970803	-	Membrana corsa corta 16" <i>Membrane short stroke 16"</i>	Veicoli vari <i>Various vehicle</i>
	970804	-	Membrana corsa corta 20" <i>Membrane short stroke 20"</i>	Veicoli vari <i>Various vehicle</i>
	970805	-	Membrana corsa corta 24" <i>Membrane short stroke 24"</i>	Veicoli vari <i>Various vehicle</i>
	970806	-	Membrana corsa corta 30" <i>Membrane short stroke 30"</i>	Veicoli vari <i>Various vehicle</i>
	970807	-	Membrana corsa corta 36" <i>Membrane short stroke 36"</i>	Veicoli vari <i>Various vehicle</i>
	970808	-	Membrana corsa lunga 12" <i>Membrane long stroke 12"</i>	Veicoli vari <i>Various vehicle</i>
	970809	-	Membrana corsa lunga 16" <i>Membrane long stroke 16"</i>	Veicoli vari <i>Various vehicle</i>
	970810	-	Membrana corsa lunga 20" <i>Membrane long stroke 20"</i>	Veicoli vari <i>Various vehicle</i>
	970811	-	Membrana corsa lunga 24" <i>Membrane long stroke 24"</i>	Veicoli vari <i>Various vehicle</i>
	970812	-	Membrana corsa lunga 30" <i>Membrane long stroke 30"</i>	Veicoli vari <i>Various vehicle</i>

Illustrazione <i>Illustration</i>	Ns.Rif. <i>Our Ref.</i>	Rif.Costr. <i>O.E. Ref.</i>	Descrizione <i>Description</i>	Tipo di veicolo <i>Vehicle Type</i>
	906059	99457634	Quadro di comando <i>Console</i>	EUROCARGO TECTOR EUROTECH CURSOR EUROSTAR CURSOR EUROTRAKKER CURSOR
	906066	99484737	Centralina elettronica <i>Electronic box</i>	EUROCARGO BUS 490/590/370/491.27 EURORIDER
	906063	4838244	Centralina portafusibili <i>Fuse box</i>	NEW DAILY (96) TURBODAILY (96)
	906065	500325434	Centralina portafusibili <i>Fuse box</i>	EUROTECH EUROSTAR EUROTRAKKER CURSOR
	990507	4837683	Blocchetto accensione <i>Starter</i>	EUROCARGO EUROTECH EUROSTAR EUROTRAKKER
	990506	4836359 4836356	Bloccasterzo <i>Steerin column lock</i>	NEW DAILY(96) TURBODAILY (96)

	Ns Riferim. Our Ref.	Rif. Costr. O.E. Ref.	Descrizione/Tipo di veicolo Description/Vehicle Type
 <p>(AD ESAURIMENTO)</p>	990500	1117025 IMOS	Devioguida Con Airbag Steering column switch With Airbag Fiat Ducato '99
 <p>(AD ESAURIMENTO)</p>	990501	1118066 IMOS	Devioguida Steering column switch Fiat Ducato U.T.
	990505	99456701	Devioguida Steering column switch NEW DAILY(96) 30.8 - 35.8 - 40.8 35.10 - 45.10 - 49.10 TURBODAILY (96) 35.10 - 49.10 35.12 - 49.12 - 59.12
	990502	500321203	Devioguida Steering column switch Daily City 2000 35S9/S10/S11/S12/S13/S15 35C9/C10/C11/C12/C13/C15 50C11/C13/C15 65C11/C13/C15

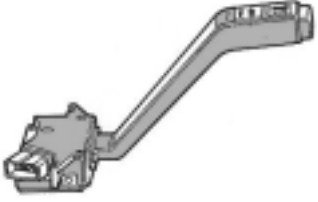
	Ns Riferim. Our Ref.	Rif. Costr. O.E. Ref.	Descrizione/Tipo di veicolo Description/Vehicle Type
	990510	504108890	<i>Devioguida</i> <i>Steering column switch</i> Daily City 2000
	990511	500321204	<i>Devioguida</i> <i>Steering column switch</i> DAILY CITY 2000 35C9/C10/C11/C12/C13/C15 35S9/S10/S11/S12/S13/S15 50C11/C13/C15 65C13/C15
	990514	42552534	<i>Leva devio</i> <i>Steering column switch lever</i> DAILY CITY 2000 35C9/C11/C13 35S9/S11/S13 50C11/C13/C15 29L9/L11
	990513	42552535	<i>Leva devio SX</i> <i>Steering column switch lever</i> DAILY CITY 2000 Serie S - Serie C

	Ns Riferim. Our Ref.	Rif. Costr. O.E. Ref.	Descrizione/Tipo di veicolo Description/Vehicle Type
	990512	42552536	Leva devio DX con cruise control Steering column switch lever with cruise control DAILY CITY 2000 Serie S - Serie C
	990503	4812066	Devioguida Steering column switch Zeta 50.9-65.9-79.14-95.14-109.14 Turbozeta 65.12-79.12
	990504	4784774	Devioguida Steering column switch 115-135.14/17 Turbostar 190.42 Turbotech 190.24/26/30/32/36 220-240-260.36 - 330.30/35/36
 (AD ESAURIMENTO)	990509	1118800 IMOS	Devioguida Steering column switch Mercedes Sprinter

	Ns Riferim. Our Ref.	Rif. Costr. O.E. Ref.	Descrizione/Tipo di veicolo Description/Vehicle Type
	990300	T90204	<p>Sollevatore idraulico a bottiglia (portata 2 TON) Bottle hydraulic hoist (capacity 2 TON)</p> <p>Veicoli commerciali ed industriali T.T. Commercial and industrial Vehicles</p>
	990301	T90304	<p>Sollevatore idraulico a bottiglia (portata 3 TON) Bottle hydraulic hoist (capacity 3 TON)</p> <p>Veicoli commerciali ed industriali T.T. Commercial and industrial Vehicles</p>
	990302	T90504	<p>Sollevatore idraulico a bottiglia (portata 5 TON) Bottle hydraulic hoist (capacity 5 TON)</p> <p>Veicoli commerciali ed industriali T.T. Commercial and industrial Vehicles</p>
	990303	T90804	<p>Sollevatore idraulico a bottiglia (portata 8 TON) Bottle hydraulic hoist (capacity 8 TON)</p> <p>Veicoli commerciali ed industriali T.T. Commercial and industrial Vehicles</p>











	Ns Riferim. Our Ref.	Rif. Costr. O.E. Ref.	Descrizione/Tipo di veicolo Description/Vehicle Type
	990304	T91004	Sollevatore idraulico a bottiglia (portata 10 TON) Bottle hydraulic hoist (capacity 10 TON) Veicoli commerciali ed industriali T.T. Commercial and industrial Vehicles
	990305	T91204	Sollevatore idraulico a bottiglia (portata 12 TON) Bottle hydraulic hoist (capacity 12 TON) Veicoli commerciali ed industriali T.T. Commercial and industrial Vehicles
	990306	T91504	Sollevatore idraulico a bottiglia (portata 15 TON) Bottle hydraulic hoist (capacity 15 TON) Veicoli commerciali ed industriali T.T. Commercial and industrial Vehicles
	990307	T92004	Sollevatore idraulico a bottiglia (portata 20 TON) Bottle hydraulic hoist (capacity 20 TON) Veicoli commerciali ed industriali T.T. Commercial and industrial Vehicles
	990308	T93204	Sollevatore idraulico a bottiglia (portata 30 TON) Bottle hydraulic hoist (capacity 30 TON) Veicoli commerciali ed industriali T.T. Commercial and industrial Vehicles

Illustrazione <i>Illustration</i>	Ns.Rif. <i>Our Ref.</i>	Rif.Costr. <i>O.E. Ref.</i>	Descrizione <i>Description</i>	Tipo di veicolo <i>Vehicle Type</i>
	955351	4648354	Supporto vaschetta servosterzo <i>Power steering tank support</i> (AD ESAURIMENTO)	100 - 110
	902296	2997012 4856604	Valvola pressione olio <i>Oil pressure valve</i>	NEW DAILY 30.8 - 35.8/10 - 40.8 - 49.10 TURBODAILY 35.12 - 49.12 - 59.12
	902297	99438751	Valvola pressione olio <i>Oil pressure valve</i> (AD ESAURIMENTO)	DAILY CITY 2000 35S9/S11/S13/S15 35C9/C11/C13/C15 50C11/C13/C15 - 65C11
	902298	8796328	Valvola a più vie per impianto pneumatico freni <i>Multi-way valve for pneumatic brake system</i>	NEW DAILY 30.8 - 35.8 - 40.8 35.10 - 45.10 - 49.10 TURBODAILY 35.10 - 35.12 - 49.12
	902299	42008943	Valvola a più vie per impianto aria <i>Multi-way valve for air system</i>	IVECO MAN MERCEDES RENAULT
	954570	42548853 93193415	Serbatoio olio servosterzo <i>Power steering oil tank</i>	DAILY CITY 2000 EUROCARGO





	Ns Riferim. Our Ref.	Rif. Costr. O.E. Ref.	Descrizione/Tipo di veicolo Description/Vehicle Type
	970004	-	Kit revisione sgancio ralla <i>Repairing relase fifth wheel set</i> Semirimorchi Semitrailers
	990309	L57S12041	Sistema di ancoraggio 1857/2 x 1204 poliestere arancio lunghezza totale 9 Mt con gancio aperto <i>Anchoring system 1857/2 x 1204</i> <i>orange polyester total lenght 9 Mt</i> <i>(with hook open)</i> Veicoli commerciali ed industriali T.T. Commercial and industrial Vehicles
	990310	L57S12291	Sistema di ancoraggio 1857/2 x 1229 poliestere arancio lunghezza totale 9 Mt con gancio chiuso <i>Anchoring system 1857/2 x 1204</i> <i>orange polyester total lenght 9 Mt</i> <i>(with hook closed)</i> Veicoli commerciali ed industriali T.T. Commercial and industrial Vehicles
	990311	L0312651-035	Sistema di ancoraggio per interni colore nero lunghezza totale 3,5 Mt <i>Inner anchoring system black colour</i> <i>total lenght 3,5 Mt</i> Veicoli commerciali ed industriali T.T. Commercial and industrial Vehicles





Illustrazione <i>Illustration</i>	Ns.Rif. <i>Our Ref.</i>	Rif.Costr. <i>O.E. Ref.</i>	Descrizione <i>Description</i>	Tipo di veicolo <i>Vehicle Type</i>
	905562	3091751	Supporto retrovisore SX O.E. <i>Mirror support O.E.</i> (AD ESAURIMENTO)	VOLVO FH12
	990002	-	Set pannelli posteriori retro-riflettenti <i>Rear retro-reflecting panels set</i>	Motrici
	990012	-	Set pannelli posteriori retro-riflettenti <i>Rear retro-reflecting panels set</i>	Rimorchi - Semirimorchi
	990240	-	Supporto in alluminio applicabile con biadesivo con pellicola limite di velocità 15 Km/h <i>Support with adhesive film speed limit 15 Km/h</i> (AD ESAURIMENTO)	Veicoli T.T.
	990241	-	Supporto in alluminio applicabile con biadesivo con pellicola limite di velocità 40 Km/h <i>Support with adhesive film speed limit 40 Km/h</i> (AD ESAURIMENTO)	Veicoli T.T.







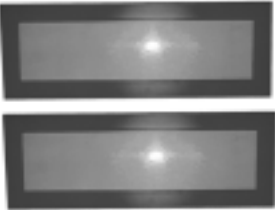



Illustrazione <i>Illustration</i>	Ns.Rif. <i>Our Ref.</i>	Rif.Costr. <i>O.E. Ref.</i>	Descrizione <i>Description</i>	Tipo di veicolo <i>Vehicle Type</i>
	990230	-	Pellicola adesiva limite di velocità 15 Km/h <i>Adesive film speed limit 15 Km/h</i>	Veicoli T.T.
	990231	-	Pellicola adesiva limite di velocità 40 Km/h <i>Adesive film speed limit 40Km/h</i>	Veicoli T.T.
	990236	-	Pellicola adesiva limite di velocità 50 Km/h <i>Adesive film speed limit 50 Km/h</i>	Veicoli T.T.
	990232	-	Pellicola adesiva limite di velocità 60 Km/h <i>Adesive film speed limit 60 Km/h</i>	Veicoli T.T.
	990233	-	Pellicola adesiva limite di velocità 70 Km/h <i>Adesive film speed limit 70 Km/h</i>	Veicoli T.T.
	990234	-	Pellicola adesiva limite di velocità 80 Km/h <i>Adesive film speed limit 80 Km/h</i>	Veicoli T.T.
	990237	-	Pellicola adesiva limite di velocità 90 Km/h <i>Adesive film speed limit 90 Km/h</i>	Veicoli T.T.
	990235	-	Pellicola adesiva limite di velocità 100 Km/h <i>Adesive film speed limit 100 Km/h</i>	Veicoli T.T.

Illustrazione <i>Illustration</i>	Ns.Rif. <i>Our Ref.</i>	Rif.Costr. <i>O.E. Ref.</i>	Descrizione <i>Description</i>	Tipo di veicolo <i>Vehicle Type</i>
 <p>(AD ESAURIMENTO)</p>	903009	8548351	Pedale acceleratore completo <i>Complete pedal accelerator</i>	OM50-LEONCINO-LUPETTO TIGROTTO
 <p>(AD ESAURIMENTO)</p>	960732	42072790	Tirante completo valvola freno <i>Rod complete with brake valve</i>	170 - 190
 <p>(AD ESAURIMENTO)</p>	973225	96015719	Supporto sospensione anteriore <i>Front suspension support</i>	343 BUS



Tipo Type	Ø mm	L mm	Lato Side	Ns.Rif. Ns.Ref.	Rif.Costr. O.E. Ref.	Tipo di veicolo Vehicle Type
A	18	40	Post. Rear	100877	8581021	NEW DAILY 30.8-35.8-40.8 - 35.10 - 45.10 - 49.10 DAILY RESTYLING 30.8 - 35.10 - 45.10 - 49.10 TURBO DAILY 30.10 - 35.10 - 49.10 - 35.12 - 49.12 - 59.12
A	20	40	Post. Rear	100876	93802629	DAILY RESTYLING 40.8 NEW DAILY 35.8 - 40.8 - 35.10 - 49.10 TURBO DAILY 35.12 - 49.12 - 59.12
A	16	40	Post. Rear	100850	93803961	DAILY RESTYLING 35.8 - 35.10 NEW DAILY 35.8 - 35.10
A	22	40	Post. Rear	100878	93801556	DAILY RESTYLING 45.10 NEW DAILY 49.10 TURBO DAILY 49.12
B	20	35	Ant. Front	100800	93802248	NEW DAILY 30-35-40.8 - 35.10 - 49.10 DAILY RESTYLING 30-35-40.8 - 35.10 - 49.10 TURBO DAILY 35.12 - 49.12 - 59.12
B	35.5	34.5	Ant. Front	100827	8585819	TURBO DAILY 59.12
B	26	63	Post. Rear	100903	93814617	TURBO DAILY 96 49.12 - 59.12 DAILY CITY 2000 65C11/C13/C15
B	28	62	Post. Rear	100904	93814618	TURBO DAILY 96 59.12 DAILY CITY 2000 65C11/C13/C15
A	25	60	A/P F/R	100853	8569607	50-55 GAMMA ZETA (ESAURIMENTO)

BOCCOLE BARRA STABILIZZATRICE STABILIZER BAR RUBBER BUSH

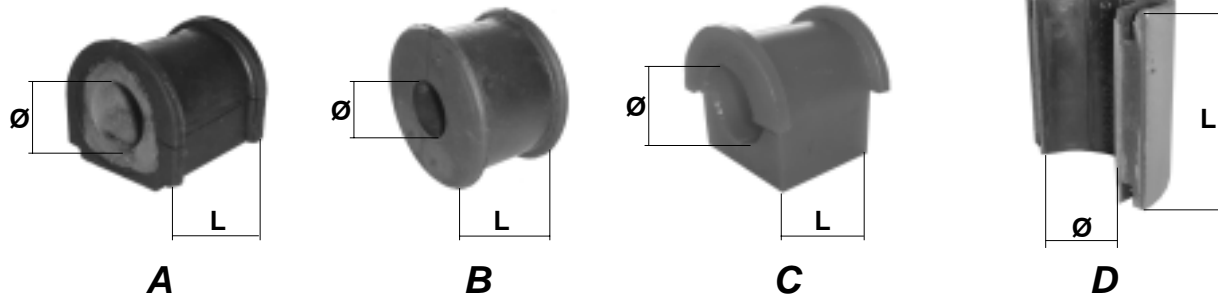
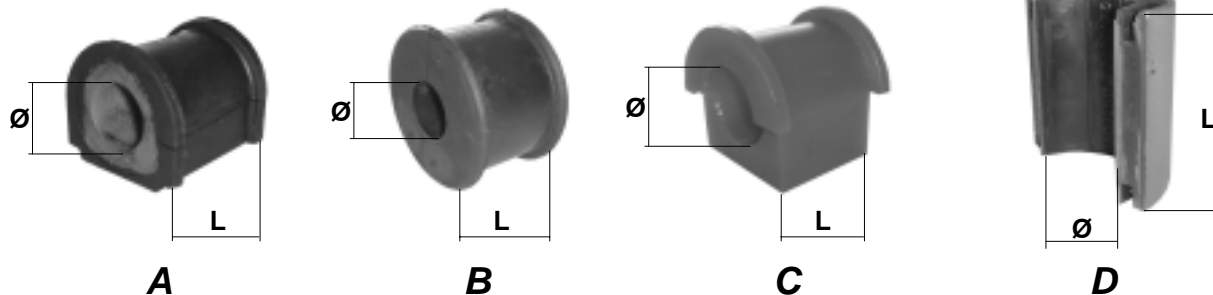

Tipo Type	Ø mm	L mm	Lato Side	Ns.Rif. Ns.Ref.	Rif.Costr. O.E. Ref.	Tipo di veicolo Vehicle Type
A	28	60	Ant Front	100802	8563414	50-55NC - 50-55-60.8 - 50-55.9 - 50-55.10 60-65.10 - 50.9 (Fino a chassis < 350096)
A	24	55	Ant. Front	100801	8557780	50-55NC - 50-55.9 - 60-65.10 - OM70-75 50-55-60.8 - 50-55.10 - 70-75-79.10 50.9 (Fino a chassis < 350096) ZETA 79.13-79.14 - 80-90NC - 80-90-100.13
A	28	70	Post. Rear	100858	8560291	ZETA 50.9 (da chassis > 350097) 60-65-75-79.10 - OM70-75 - 79.14 80-90-100.13
A	35	70	Post. Rear	100879	8569596	ZETA 65.9 (ESAURIMENTO)
A	34	70	Post. Rear	100864	8584626	TURBOZETA 60.11 - 65.12 (ESAURIMENTO) ZETA 65.9 - 79.14
A	26	60	A/P F/R	100813	8581295	TURBOZETA 65.12 - 79.12 - 60.11 - 65.9 ZETA 50.9 - 65.9 - 79.14 - 95.14 - 109.14
A	38	70	A/P F/R	100823	8572709	ZETA 65.9 - 95.14 - 109.14 (ESAURIMENTO) 95.14 - 109.14 (3°e 4° serie)
A	40	70	Ant. Front	100814	8584196	ZETA 95.14 - 109.14 (ESAURIMENTO)
A	32	70	Ant. Front	100804	8558110	TURBOZETA 65.12 - 79.12 - 60.11 ZETA 65.9 - 79.14

Copyright della EMMERRE S.r.l. - Settimo Torinese - Tutti i diritti sono riservati e depositati a norma di legge ed a norma delle convenzioni internazionali. - E' vietata la duplicazione o la riproduzione anche parziale senza la previa autorizzazione della EMMERRE S.r.l.

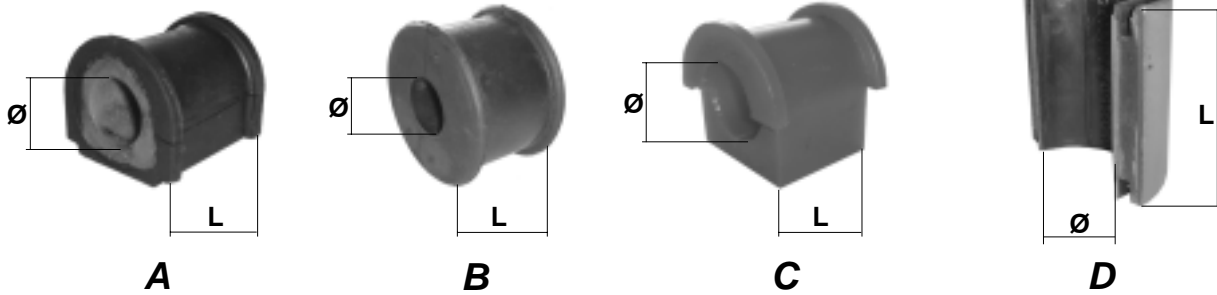

Tipo Type	Ø mm	L mm	Lato Side	Ns.Rif. Ns.Ref.	Rif.Costr. O.E. Ref.	Tipo di veicolo Vehicle Type
A	43	67	Post. Rear	100860	4796745	115.14/17 - 145.17
A	40	67	Post. Rear	100861	4796746	115.14 - 115.17 - 135.17
A	38	69	Post. Rear	100868	4796971	115.17 - 175.24 - 175.24 R.S.U. - 165.24
A	40	55	Ant. Front	100816	4792127	135.14 - 135.17 - 145.17 - 175.17 - 175.24 175.24 R.S.U.
C	30	55	Ant. Front	100803	8125527	EUROCARGO 60 - 65E10/E12/E14
B	30	62	Post. Rear	100855	8125490	EUROCARGO 60 - 65E10/E12/E14 EUROCARGO 75E12/E14/E15 (Inferiore balestra semimetallica)
B	32	62	Post. Rear	100856	8125491	EUROCARGO 60 - 65E10/E12/E14 EUROCARGO 75E12/E14/E15 (Inferiore-lower)
B	40	63	Post. Rear	100857	8127383	EUROCARGO 60 - 65E10/E12/E14 EUROCARGO 75E12/E14/E15 - 80E15/E18/E21 180E21 (inferiore-lower)
B	27	62	Post. Rear	100830	4848464	EUROCARGO 60E14 - 65E12/E14 - 75E12/E14 EUROCARGO TECTOR 75E13/E15/E17/E18 (poliuretano) (ESAURIMENTO)

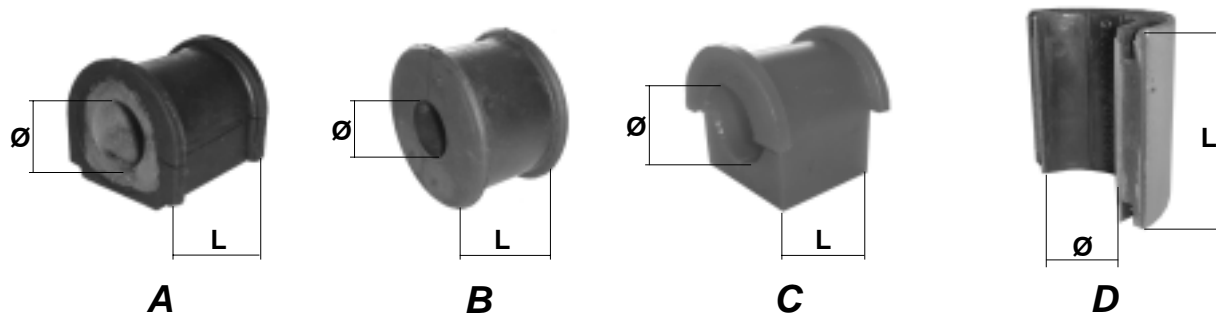

Tipo Type	Ø mm	L mm	Lato Side	Ns.Rif. Ns.Ref.	Rif.Costr. O.E. Ref.	Tipo di veicolo Vehicle Type
A	34,5	58	Ant. Front	100831	8125528	EUROCARGO 75E15 (ESAURIMENTO)
C	37	55	Ant. Front	100820	8127910	EUROCARGO 75E12/E14/E15 EUROCARGO 80E10 - 100E15/E18
B	35	63	Post. Rear	100865	8125492	EUROCARGO 80E15/E18/E21 EUROCARGO 100E15 - 120E21
B	42	72	Post. Rear	100867	8127381	EUROCARGO 95E18 - 100E18/E21 (sospensione pneumatica - pneumatic suspension) (ESAURIMENTO)
A	41	70	Post. Rear	100862	98407169	EUROCARGO 120E15-E15H-E18-E23 130E15-E18 - 280E23 - 320E27
C	38	56	Ant. Front	100819	98415468	EUROCARGO 120E15-E15H-E18-E23
C	43	65	Ant. Front	100821	98415469	EUROCARGO 120E18-E23 - 130E15-E18-E23 150E15-E18-E23-E27 (ESAURIMENTO)
D	60	70	Post. Rear	100881	98444831	EUROCARGO 120E18-E23 EUROTECH 400E34MT (ESAURIMENTO)
C	45	65	Ant. Front	100807	98431946	EUROCARGO 130-150E15-E18 - 150E23-E27
A	42	70	Post Rear	100863	98407168	EUROCARGO 150E15-E18-E23-E27

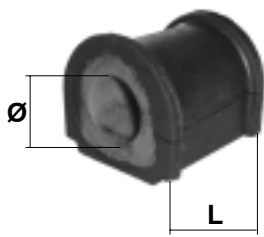

A

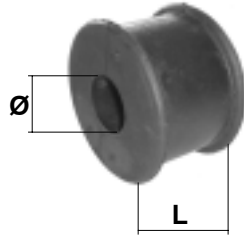

B

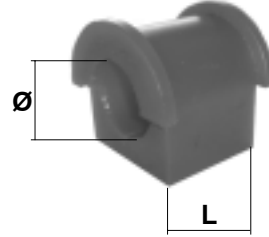

C



D

Tipo Type	Ø mm	L mm	Lato Side	Ns.Rif. Ns.Ref.	Rif.Costr. O.E. Ref.	Tipo di veicolo Vehicle Type
D	64	70	Post. Rear	100883	98444832	EUROCARGO 150E23 EUROTECH 180E24-E27-E30 - 400E34MT
D	48	70	Post. Rear	100880	98456259	EUROCARGO 170E15-E18-E23 EUROTECH 180E24-E27-E30 190E24-E27-E30 190E24-E27-E30 - 400E34 (ESAURIMENTO)
D	48	70	Ant. Front	100825	98469635	EUROCARGO 170E15-E18-E23 (sosp.mecc.) EUROTECH 180E30-E34MT 190E24-E27-E30 (sosp. meccanica)
C	48	65	Ant. Front	100832	98466340	EUROFIRE 150E27 EUROFIRE TECTOR 150E24/E28 (ESAURIMENTO)
A	40	70	Ant. Front	100809	4700488	170.26 - 170.33 - 170.35 (ESAURIMENTO)
A	48	56	Ant. Front	100810	4754678	180.24 - 180.26 - 190.26 - 190.30 (ESAURIMENTO) 190.35/38 (1°serie)
A	45	70	Ant. Front	100811	4731981	TURBOSTAR 190-240-260.36/42/48 TURBOTECH 190-240-260.24/26//32/36
A	50	76	Post. Rear	100859	4688153	170.33/35 - 180.26 - Turbostar 190.42/48 TURBOTECH 190.24/26/30/32/36
A	50	93	Post. Rear	100869	4735723	TURBOSTAR 190.36-190.42-190.48 TURBOTECH 190.32-190.36 (sosp.pneumatica) (ESAURIMENTO)

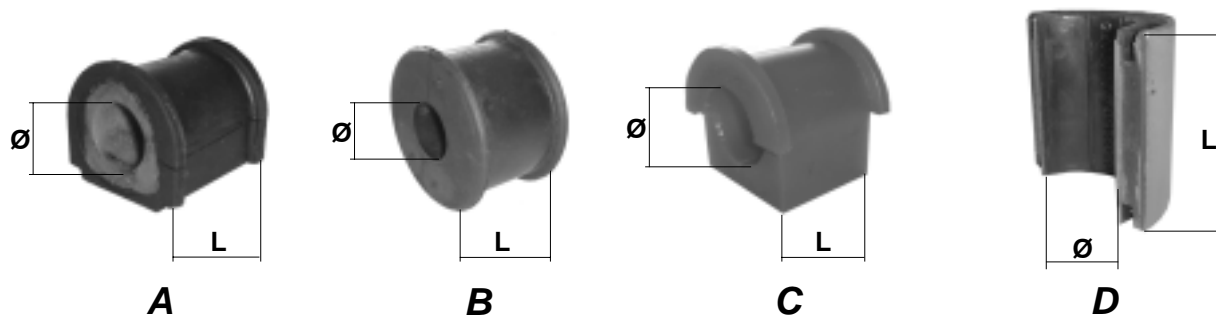

Tipo Type	Ø mm	L mm	Lato Side	Ns.Rif. Ns.Ref.	Rif.Costr. O.E. Ref.	Tipo di veicolo Vehicle Type
A	60	93	Post. Rear	100871	4740646	TURBOSTAR 190.42-190.48 TURBOTECH 190.32-190.36-240.32 (ESAURIMENTO)
D	65	70	Post. Rear	100882	98444833	EUROTECH 180E30 - 190E24/E27/E30
D	45	70	Ant. Front	100824	98469634	EUROTECH 180E24-E27-E30 - 400E30-E34MT
D	44	70	Ant. Front	100822	8189831	EUROSTAR 190-240-400-440E38/E42/E47/E52 EUROTECH 180-400-440E34/E38-240-440E42
D	38	70	Ant. Front	100812	2520448	EUROSTAR 400E42 - EUROTECH 400E34/E38 EUROTRAKKER 190E30/E31/E34/E37 260E30/34/37 - 330E34/E37 - 380E34/37/42 480 TURBOCITY
D	53.90	70	Post. Rear	100870	2521481	EUROSTAR - EUROTECH - EUROTRAKKER 330.26 - 330.35
D	48.90	70	Post. Rear	100873	2521850	190-330.26H-30H-35H-36H EUROTECH 240E42 - 400E30/E34 EUROTRAKKER 260E30/E34/E37 - 330E34/E37 380E34/E37 - 720E37
D	70	55	Post. Rear	100874	41015581	EUROTECH - EUROSTAR
D	60	80	Post. Rear	100875	41270883 8169892	EUROTECH - EUROSTAR - CURSOR
D	46	82	Post. Rear	100905	2521482	EUROTECH 240E34/E38/E42 - 440E42 EUROSTAR 240E38/E42/E47/E52 (ESAURIMENTO)

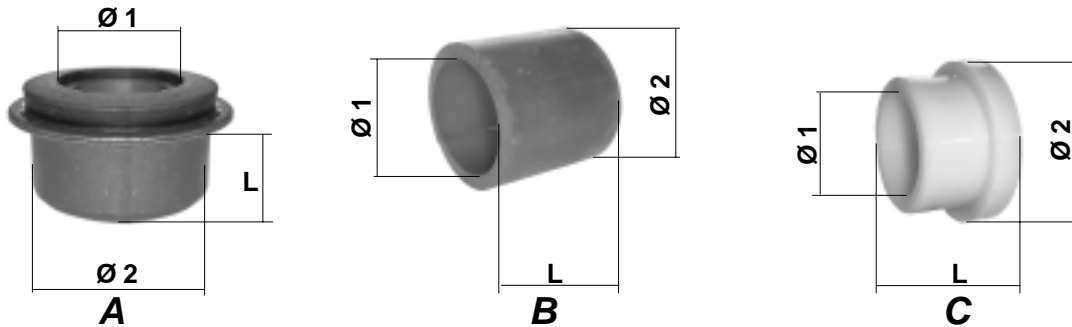
BOCCOLE BARRA STABILIZZATRICE E TORSIONE
STABILIZER AND TORSION BAR RUBBER BUSH

Tipo Type	Ø1 mm	L mm	Ø2 mm	Ns.Rif. Ns.Ref.	Rif.Costr. O.E. Ref.	Tipo di veicolo Vehicle Type
A	29	25	52	100890	1391347	DAILY 30.8-35.8-40.8 DAILY RESTYLING 30.8-35.8-40.8 DAILY RESTYLING 35.10 - 49.10 (superiore - upper)
A	32	25	52	100891	1391348	DAILY 30.8-35.8-40.8 DAILY RESTYLING 30.8-35.8-40.8 DAILY RESTYLING 35.10 - 49.10 (inferiore - lower)
A	32	35	52	100892	93807641	NEW DAILY 30.8-35.8-40.8 - 35.10 TURBO DAILY 35.12 (superiore - upper)
A	37	35	57	100894	504277460 93810239	NEW DAILY 30.8-35.8-40.8 - 35.10-49.10 TURBO DAILY 35.12-49.12-59.12 (superiore - upper)
A	29	35	52	100893	504277459 93807640	NEW DAILY 30.8-35.8-40.8 - 35.10-49.10 TURBO DAILY 35.12-49.12-59.12 (inferiore - lower)
C	32.5	19	41.5	100854	8127423	EUROCARGO 60E10/E12/E14 65E10/E12/E14 - 75E12/E14/ER15 80E15/E18/E21 - 100E15/E18/E21 - 180E21 (attacco laterale - lateral connection)
B	52	59.5	64	100872	4739171	TURBOSTAR 190.42/48 TURBOTECH 190.32/36 - 220.32/36 - 240.36 (sospensione pneumatica - pneumatic suspension) (ESBURIMENTO)

BOCCOLE ATTACCO BALESTRA LEAF SPRINGS FASTENING BUSH

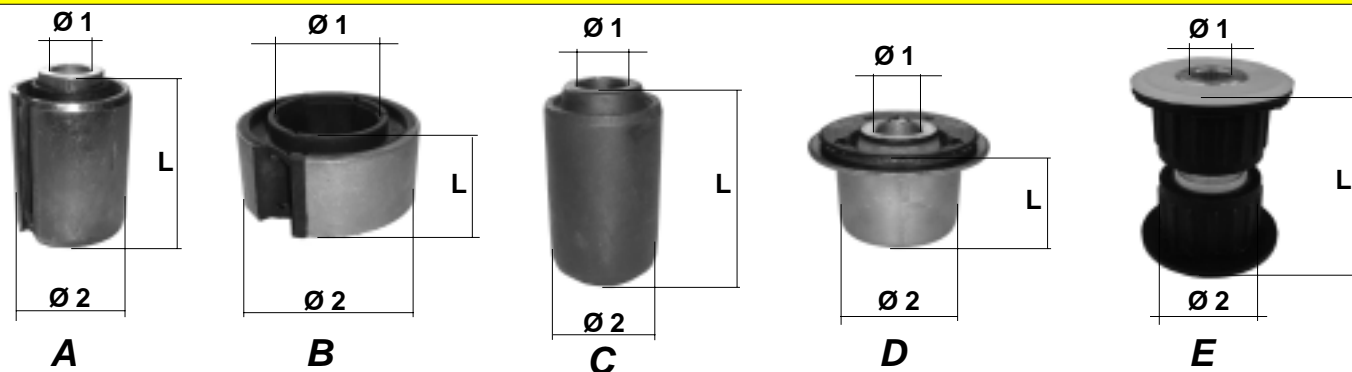

Tipo Type	Ø1 mm	L mm	Ø2 mm	Ns.Rif. Ns.Ref.	Rif.Costr. O.E. Ref.	Tipo di veicolo Vehicle Type
C	16	72	38.2	100950	93800193	DAILY 30.8-35.8-40.8 (ESAURIMENTO) DAILY RESTYLING 30.8-35.8-40.8 DAILY RESTYLING 35.10-49.10
D	16.5	30	40	100951	93808935	NEW DAILY 30.8-35.8-40.8 NEW DAILY 35.10-49.10 TURBO DAILY 35.12-49.12-59.12
D	16.5	35	45.5	100949	98482540	EUROCARGO T.T.
E	17/30	80	48	100975	504011462	EUROCARGO 75/100
D	16.2	36	40	100953	8587681	TURBO DAILY 59.12 TURBOZETA 60.11 - 65.12 - 79.12 Zeta 50.9 - 65.9 - 79.14 (anteriore e posteriore - front and rear)
A	16.2	74	47.5	100960	98413847	EUROCARGO 60-65E10/E12/E14 75E12/E14/E15 - 80E15/E18/E21 - 95E18 100E15/E18/E21 (anteriore e posteriore - front and rear)
A	20.2	84	57.2	100959	98413939	EUROTECH 180-190E24/E27/E30 - 180-400E34 EUROCARGO 120-130-150-170E15/E18 120-150-170E23 - 150320E27 (anteriore e posteriore - front and rear)
A	20.2	97	62	100956	8160686	EUROSTAR 190-400-440E42/E52 EUROTECH 180E34/E38 - 190-400-440E42 (anteriore - front)
A	20.2	107	62	100957	8160687	EUROSTAR 190-400-440E42/E52 EUROTECH 180E34/E38 - 190-400-440E42 (posteriore - rear) (ESAURIMENTO)
B	36.8	28	64.5	100958	8162280	EUROTRAKKER 340E34/E37 - 410E37/E42 (anteriore - front)

SILENT-BLOCK BARRA STABILIZZATRICE
SILENTBLOCK STABILIZER BAR

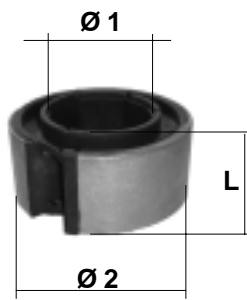
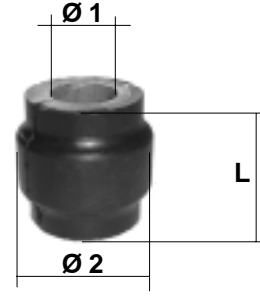



**A****B****C**

Tipo Type	Ø1 mm	L mm	Ø2 mm	Ns.Rif. Ns.Ref.	Rif.Costr. O.E. Ref.	Tipo di veicolo Vehicle Type
C	24	30	38	103682	93801623	DAILY RESTYLING 30.8-35.8-40.8 DAILY RESTYLING 35.10-49.10
C	16	30	38	103683	93803960	DAILY RESTYLING 35.8 DAILY RESTYLING 35.10
C	20	30	38	103673	93802631	DAILY RESTYLING 40.8
C	18	30	38	103674	8581022	DAILY RESTYLING 30.8 DAILY RESTYLING 35.10-49.10
C	22	30	38	103675	93801624	DAILY RESTYLING 45.10-49.10
B	28	50	60	103600	4601722	TURBOSTAR 190.36/38/42 - TURBOTECH 190.24 TURBOTECH 190.26/30/32/36 - 115-135.14/17 - 145.17 EUROCARGO 120E15/E18/E23 - 130E15/E18 - 150E15/E18/E23
B	20	42	46	103602	4606624	EUROCARGO 60-65E10/E12/E14 - 75E12/E14 75E15 - 80E15 - 100E15/E18 (anteriore - front)
B	20	55	46	103603	4791448	EUROTECH 180E27/E30/E34 - 190E24/E27/E30 EUROCARGO 120E15/E18/E23 - 130E15/E18 150E15/E18/E23/E27 - 170E18/E23 (ant/post.)
B	28	40	62.5	103676	8162306	EUROSTAR T.T. - EUROTECH T.T. (anteriore)
A	28	50	60	103678	500336108 41218902	EUROTECH CURSOR 190E24/E31/E35/E43 EUROTECH CURSOR 260E31/E35/E39/E43 - 440E35/E43 EUROSTAR CURSOR 190E39/E43 - 260E39/E43 STRALIS 190S27/S31/S35/S40/S43/S48 STRALIS 260S27/S30/S31/S35/S40/S43/S48/S54 STRALIS 440S31/S35/S40/S43/S48/S54





BOCCOLE BARRA STABILIZZATRICE STABILIZER BAR RUBBER BUSH

Illustrazione <i>Illustration</i>	Ns.Rif. <i>Our Ref.</i>	Rif.Costr. <i>O.E. Ref.</i>	Descrizione <i>Description</i>	Tipo di veicolo <i>Vehicle Type</i>
<p>Ø 39.6 x 64 x 80</p>	100906	0010761	Boccola barra stabilizzatrice Stabilizer bar rubber bush (ESAURIMENTO)	DAF F65 - F95 F1200 - F1400 - F1600 - F1900 F2100 - F2300 - F2900
	100884	81437220087	Boccola barra Bar rubber bush	MANTGA
<p>Ø 9 x 29.5 x 24</p>	100907	9013230285	Boccola barra stabilizzatrice Stabilizer bar rubber bush (ESAURIMENTO)	MERCEDES SPRINTER 208 - 210 - 212D 308 - 310 - 312D 412D VOLKSWAGEN LT28-35 - LT28-46
<p>Ø 22 x 35 x 38</p>	100915	9013260081	Boccola barra stabilizzatrice Stabilizer bar rubber bush (ESAURIMENTO)	MERCEDES SPRINTER 208 - 210 - 212D 308 - 310 - 312D
<p>Ø 22 x 42 x 30</p>	100916	9013230185	Boccola barra stabilizzatrice Stabilizer bar rubber bush (ESAURIMENTO)	MERCEDES SPRINTER 208 - 212 - 214 - 216D 308CDI - 311CDI - 313CDI 316CDI
<p>Ø 25 x 42 x 30</p>	100917	9043230085	Boccola barra stabilizzatrice Stabilizer bar rubber bush (ESAURIMENTO)	MERCEDES SPRINTER 208 - 212 - 214 - 216D 308 - 310 - 312 - 314D 311CDI - 313CDI - 316CDI 411CDI - 413CDI - 416CDI VOLKSWAGEN LT28-35/46







BOCCOLE BARRA STABILIZZATRICE STABILIZER BAR RUBBER BUSH

Illustrazione <i>Illustration</i>	Ns.Rif. <i>Our Ref.</i>	Rif.Costr. <i>O.E. Ref.</i>	Descrizione <i>Description</i>	Tipo di veicolo <i>Vehicle Type</i>
 Ø 26,5 x 54 x 46	100918	9043260881	Boccola barra stabilizzatrice Stabilizer bar rubber bush (ESAURIMENTO)	MERCEDES SPRINTER 412 - 141D 411CDI - 413CDI - 416CDI
 Ø 12 x 30 x 30	100919	3093200073	Boccola barra stabilizzatrice Stabilizer bar rubber bush (ESAURIMENTO)	MERCEDES ATEGO
 Ø 17 X 40 X 40	100920	3183200073	Boccola barra stabilizzatrice Stabilizer bar rubber bush (ESAURIMENTO)	MERCEDES ATEGO
 Ø 20 x 43 x 39.5	100921	0003232885	Boccola barra stabilizzatrice Stabilizer bar rubber bush (ESAURIMENTO)	MERCEDES ATEGO ACTROS 1831 - 1835 - 1840 - 1843 1848 - 1853 - 1857 - 2031 2035 - 2040 - 2531 - 2535 2530 - 2543 - 2548 - 2553 2557 - 2631 - 2635 - 2640 2643 - 2648 - 3231 - 3235 3331 - 3335 - 3353 - 4140 4143
 Ø 22,5 x 51 x 40	100922	9743280181	Boccola barra stabilizzatrice Stabilizer bar rubber bush (ESAURIMENTO)	MERCEDES ATEGO I 1214 - 1215 - 1217 - 1223 1225 - 1228 - 1317 - 1323 1325 - 1328 - 1517 - 1523 1528 ATEGO II 1215 - 1218 - 1222 1223 - 1226 - 1228 - 1318 1322 - 1323 - 1326 - 1328 1518 - 1522 - 1526 - 1528

BOCCOLE BARRA STABILIZZATRICE STABILIZER BAR RUBBER BUSH

Illustrazione <i>Illustration</i>	Ns.Rif. <i>Our Ref.</i>	Rif.Costr. <i>O.E. Ref.</i>	Descrizione <i>Description</i>	Tipo di veicolo <i>Vehicle Type</i>
 Ø 33,5 x 62 x 47	100923	9703231585	Boccola barra stabilizzatrice Stabilizer bar rubber bush (ESBURIMENTO)	MERCEDES ATEGO I 712 - 714 - 715 - 717 - 812 814 - 815 - 817 - 823 - 917 923 - 1017 - 1023 - 1214 1215 - 1217 - 1223 - 1225 1228 - 1317 - 1323 - 1517 1523 - 1528 ATEGO II 712 - 713 - 715 - 716 - 812 813 - 815 - 823 - 915 - 918 923 - 1016 - 1018 - 1023 1215 - 1218 - 1223 - 1323 1326 - 1328 - 1518 - 1523
 Ø 37,5 x 62 x 56	100924	9743230285	Boccola barra stabilizzatrice Stabilizer bar rubber bush (ESBURIMENTO)	MERCEDES ATEGO
 Ø 42,5 x 68 x 56	100927	9743230385	Boccola barra stabilizzatrice Stabilizer bar rubber bush (ESBURIMENTO)	MERCEDES ATEGO I 1214 - 1215 - 1217 - 1223 1225 - 1228 - 1317 - 1323 1325 - 1328 - 1517 - 1523 1528 ATEGO II 1215 - 1218 - 1222 - 1223 1226 - 1228 - 1318 - 1322 1323 - 1326 - 1328 - 1518 1522 - 1526 - 1528
 Ø 28 x 52 x 56	100928	0003236285	Boccola barra stabilizzatrice Stabilizer bar rubber bush (ESBURIMENTO)	MERCEDES ATEGO ACTROS 1831 - 1835 - 1840 - 1843 1848 - 1853 - 1857 - 2031 2035 - 2040 - 2531 - 2535 2530 - 2543 - 2548 - 2553 2557 - 2631 - 2635 - 2640 2643 - 2648 - 3231 - 3235 3331 - 3335 - 3353 - 4140 4143
 Ø 38 x 62 x 56	100930	0003262481	Boccola barra stabilizzatrice Stabilizer bar rubber bush (ESBURIMENTO)	MERCEDES ATEGO ACTROS

BOCCOLE BARRA STABILIZZATRICE STABILIZER BAR RUBBER BUSH

Illustrazione <i>Illustration</i>	Ns.Rif. <i>Our Ref.</i>	Rif.Costr. <i>O.E. Ref.</i>	Descrizione <i>Description</i>	Tipo di veicolo <i>Vehicle Type</i>
 Ø 40 x 52 x 65	100931	9413230350	Boccola barra stabilizzatrice Stabilizer bar rubber bush (ESBURIMENTO)	MERCEDES ACTROS
 Ø 47,5 x 75 x 56,5	100932	0003262681	Boccola barra stabilizzatrice Stabilizer bar rubber bush (ESBURIMENTO)	MERCEDES ATEGO ACTROS
 Ø 52 x 81 x 56	100933	0003250685	Boccola barra stabilizzatrice Stabilizer bar rubber bush (ESBURIMENTO)	MERCEDES ATEGO ACTROS
 Ø 57,5 x 88 x 56	100934	0003264481	Boccola barra stabilizzatrice Stabilizer bar rubber bush (ESBURIMENTO)	MERCEDES ATEGO ACTROS
 Ø 61 x 100 x 70	100808	9703170112	Boccola barra stabilizzatrice Stabilizer bar rubber bush	MERCEDES
 Ø 67 x 109 x 81	100826	9413260050	Boccola barra stabilizzatrice Stabilizer bar rubber bush	MERCEDES ATEGO ACTROS
 Ø 60 x 74 x 96	100936	1075188	Boccola barra stabilizzatrice Stabilizer bar rubber bush (ESBURIMENTO)	VOLVO FH12 - FH16





BOCCOLE BARRA STABILIZZATRICE STABILIZER BAR RUBBER BUSH

Illustrazione Illustration	Ns.Rif. Our Ref.	Rif.Costr. O.E. Ref.	Descrizione Description	Tipo di veicolo Vehicle Type
 <p>Ø 60 x 81,5 x 94</p>	100938	1629169	Boccola barra stabilizzatrice Stabilizer bar rubber bush (ESAURIMENTO)	VOLVO FH12 - FH16
 <p>Ø 60 x 103 x 95</p>	100940	9519245	Boccola barra stabilizzatrice Stabilizer bar rubber bush (ESAURIMENTO)	VOLVO
 <p>Ø 65 x 102 x 95</p>	100942	1079256	Boccola barra stabilizzatrice Stabilizer bar rubber bush (ESAURIMENTO)	VOLVO
 <p>Ø 71 x 118 x 95</p>	100943	1077594	Boccola barra stabilizzatrice Stabilizer bar rubber bush (ESAURIMENTO)	VOLVO
 <p>Ø 75 x 95</p>	100944	1622838	Boccola barra stabilizzatrice Stabilizer bar rubber bush (ESAURIMENTO)	VOLVO FL7 - FL10 F10 - F12 FH12 - FH16



**BOCCOLE BARRA SOSPENSIONI
SUSPENSION BAR BUSHING**

Illustrazione <i>Illustration</i>	Ns.Rif. <i>Our Ref.</i>	Rif.Costr. <i>O.E. Ref.</i>	Descrizione <i>Description</i>	Tipo di veicolo <i>Vehicle Type</i>
	100895	500350342	Boccola inferiore avantreno Fore-carriage lower bushing	DAILY CITY 2000 65C11/C13/C15
	100896	500350343	Boccola superiore avantreno Fore-carriage upper bushing	DAILY CITY 2000 65C11/C13/C15
	100900	500326957	Boccola sospensione Suspension bushing (ESAURIMENTO)	DAILY CITY 2000 35S9/S11/S13/S15 35C9/C11/C13/C15 50C11/C13/C15 65C13
	100902	504112266 504048721 504054600	Boccola balestra posteriore Rear leaf spring bushing	DAILY CITY 2000 35C9/C11/C13/C15 50C11/C13/C15





BOCCOLE BARRA SOSPENSIONI SUSPENSION BAR BUSHING

Illustrazione <i>Illustration</i>	Ns.Rif. <i>Our Ref.</i>	Rif.Costr. <i>O.E. Ref.</i>	Descrizione <i>Description</i>	Tipo di veicolo <i>Vehicle Type</i>
	100968	504112265 99469085	Silentblock sospensione <i>Suspension silentblock</i>	Daily City 2000 35S9/S10/S11/S12/S13/S15
	100964	0295726	Silentblock sospensione <i>Suspension silentblock</i> (ESAURIMENTO)	Daf 65-75-85
	100965	500343454 4703856	Boccola barra sospensioni <i>Suspension bar bushing</i>	370
	100966	4746348	Boccola barra sospensioni <i>Suspension bar bushing</i>	370
	103680	500343453 4639392	Boccola barra <i>Bar bushing</i>	370

BOCCOLE STERZO STEERING BUSHING

Illustrazione <i>Illustration</i>	Ns.Rif. <i>Our Ref.</i>	Rif.Costr. <i>O.E. Ref.</i>	Descrizione <i>Description</i>	Tipo di veicolo <i>Vehicle Type</i>
	103651	93802390	Boccola scatola sterzo Sx <i>Left steering box bushing</i>	DAILY RESTYLING 30.8-35.8-40.8 35.10 - 45.10 - 49.10 NEW DAILY 30.8 - 35.8 - 40.8 - 35.10 TURBODAILY 30/35.10 - 35.12
	103652	93802391	Boccola scatola sterzo Dx <i>Right steering box bushing</i>	DAILY RESTYLING 30.8 - 35.8 - 40.8 - 35.10 NEW DAILY 30.8 - 35.8 - 40.8 - 35.10 TURBODAILY 30.10 - 35.10
	103653	93802392	Boccola scatola sterzo destra/sinistra (Idroguida) <i>Right/Left steering box bushing</i>	DAILY RESTYLING 30.8 - 35.8 - 40.8 - 35.10 NEW DAILY 30.8 - 35.8 - 40.8 35.10 - 45.10 - 49.10 TURBODAILY 30.10 - 35.10 35.12 - 49.12 - 59.12







SUPPORTI E TIRANTI VARI SUPPORT AND TIE ROD

Illustrazione <i>Illustration</i>	Ns.Rif. <i>Our Ref.</i>	Rif.Costr. <i>O.E. Ref.</i>	Descrizione <i>Description</i>	Tipo di veicolo <i>Vehicle Type</i>
	902366	500315622	Biella sospensione con silentblock <i>Suspension connecting rod with silentblock</i>	DAILY CITY 2000 35S9/S11/S12/S13/S15
	100973	500336363	Supporto barra stabilizzatrice <i>Anti-roll bar support</i>	DAILY CITY 2000 35S9/S10/S11/S12/S13
	100974	500336364	Supporto barra stabilizzatrice <i>Anti-roll bar support</i>	DAILY CITY 2000 35S9/S10/S11/S12/S13
	100018	500398156 41001647	Tirante SX radiatore <i>Radiator tie rod LH</i>	EUROTECH - EUROSTAR EUROTRAKKER - CURSOR STRALIS
	100020	504004369 41001646	Tirante DX radiatore <i>Radiator tie rod RH</i>	EUROTECH - EUROSTAR EUROTRAKKER - CURSOR STRALIS

TASSELLI SOSTEGNO CABINA
ANCHORS CABIN SUPPORT

Illustrazione <i>Illustration</i>	Ns.Rif. <i>Our Ref.</i>	Rif.Costr. <i>O.E. Ref.</i>	Descrizione <i>Description</i>	Tipo di veicolo <i>Vehicle Type</i>
	101018	4576957	Tassello anteriore e posteriore cabina <i>Front and rear dowel cabin</i> (ESAUIMENTO)	DAILY RESTYLING 30.8 - 35.8 - 40.8 35.10 - 49.10
	101020	8141758	Tassello posteriore cabina <i>Rear dowel cabin</i>	EUROCARGO 60E10/12/E14 65E10/E12/E14 75E12/E14/E15/E17/E18 85E15/E18 120E15/E18

SILENTBLOCK CABINA CABIN SILENTBLOCK

Illustrazione <i>Illustration</i>	Ns.Rif. <i>Our Ref.</i>	Rif.Costr. <i>O.E. Ref.</i>	Descrizione <i>Description</i>	Tipo di veicolo <i>Vehicle Type</i>
	101055	-	Silentblock cabina NS mod. composto da : Silentblock rif. 8139012 Boccola rif. 8139013 <i>Silentblock cabin OUR mod.</i> complete of: Silentblock ref. 8139012 Bush ref. 8139013	EUROCARGO (Cabina corta e lunga) 80-100-120E15/E18/E21 130E15/E18/E23 150E15/E18/E23/E27 180E21 260E23 - 280E23 - 320E27
	101006	4694227	Silentblock ancoraggio cabina <i>Silentblock anchorage cabin</i> (ESAURIMENTO)	190.35 (1°serie)
	101049	42070675	Base di gomma <i>Rubber plate</i>	EUROCARGO 80-100-120E15/E18/E21 130E15/E18/E23 150E15/E18/E23/E27 - 180E21 260E23 - 280E23 - 320E27 TURBOSTAR 190.36/42/48 - 240-260.36/48 TURBOTECH 240.36
	101039	42070674	Silentblock cabina <i>Cabin silentblock</i>	TURBOSTAR 190.36/42/48 240.36/48 - 260.36/48 TURBOTECH 240.36 EUROCARGO 75E14 80-100E15/E18/E21 120E15/E18/E23 - 130E18/E23 150E15/E18/E23/E27 - 180E21 280E23 - 320E27
	101040	42105574	Silentblock cabina <i>Cabin silentblock</i>	TURBOSTAR 190.36/42/48 260.36/48 TURBOTECH 240.36/48
	101047	500331831 1908675	Silentblock cabina <i>Cabin silentblock</i>	EUROTECH EUROTECH CURSOR EUROSTAR EUROSTAR CURSOR EUROTRAKKER EUROTRAKKER CURSOR

SILENTBLOCK CABINA CABIN SILENTBLOCK

Illustrazione <i>Illustration</i>	Ns.Rif. <i>Our Ref.</i>	Rif.Costr. <i>O.E. Ref.</i>	Descrizione <i>Description</i>	Tipo di veicolo <i>Vehicle Type</i>
	101048	41009544	Silentblock cabina <i>Cabin silentblock</i>	EUROTECH EUROTECH CURSOR EUROSTAR EUROSTAR CURSOR EUROTRAKKER EUROTRAKKER CURSOR
	101035	1907808	Serie boccole per leva <i>Bushings kit for cabin lever</i>	EUROTECH EUROTECH CURSOR EUROSTAR EUROSTAR CURSOR EUROTRAKKER EUROTRAKKER CURSOR
	101036	1908221	Serie boccole per mensola cabina <i>Bushings kit for cabin braket</i>	EUROTECH EUROTECH CURSOR EUROSTAR EUROSTAR CURSOR EUROTRAKKER EUROTRAKKER CURSOR
	101031	504021532	Boccola cabina <i>Bushings cabin</i>	STRALIS
	101010	500351393	Silentblock cabina <i>Cabin silentblock</i>	STRALIS
	101007	500357265	Silentblock ribaltamento cabina <i>Tipping over cabin silentblock</i>	STRALIS

SILENTBLOCK CABINA CABIN SILENTBLOCK

Illustrazione <i>Illustration</i>	Ns.Rif. <i>Our Ref.</i>	Rif.Costr. <i>O.E. Ref.</i>	Descrizione <i>Description</i>	Tipo di veicolo <i>Vehicle Type</i>
	101016	9423172312	Boccola silentblock cabina <i>Cabin silentblock bushings</i>	MERCEDES ACTROS
	101032	9403171112 9423172012	Boccola cabina <i>Cabin bushings</i>	MERCEDES ACTROS 2031-2035-2040-2531-2535 2540-2548-2631-2653-2657 3231-3235-3240-3243-3331 3343-3348-4140-4143

SILENTBLOCK CAMBIO GEAR BOX SILENTBLOCK

Illustrazione <i>Illustration</i>	Ns.Rif. <i>Our Ref.</i>	Rif.Costr. <i>O.E. Ref.</i>	Descrizione <i>Description</i>	Tipo di veicolo <i>Vehicle Type</i>
	100945	42078196	Silentblock cambio (fino a telaio n° C00101) Gear box silentblock (up to frame n° C00101) (ESAURIMENTO)	TURBOTECH TURBOSTAR EUROTECH EUROSTAR EUROTRAKKER
	100946	42078032	Silentblock cambio (fino a telaio n° C00102) Gear box silentblock (up to frame n° C00102)	TURBOTECH TURBOSTAR EUROTECH EUROSTAR EUROTRAKKER

TASSELLI MOTORE ENGINE DOWELS

Illustrazione <i>Illustration</i>	Ns.Rif. <i>Our Ref.</i>	Rif.Costr. <i>O.E. Ref.</i>	Descrizione <i>Description</i>	Tipo di veicolo <i>Vehicle Type</i>
	100009	93803159	Tassello anteriore motore Dx <i>Engine right front dowel</i> (ESAURIMENTO)	DAILY RESTYLING 30.8 - 35.8 - 40.8
	100011	8588903	Tassello anteriore motore Dx <i>Engine right front dowel</i>	NEW DAILY 30.8 - 35.8 - 40.8 35.10 - 45.10 - 49.10 DAILY RESTYLING 35.10-49.10 TURBO DAILY 30-35-49.10 35.12 - 49.12 - 59.12
	100012	8588904	Tassello anteriore motore Sx <i>Engine left front dowel</i>	NEW DAILY 30.8 - 35.8 - 40.8 35.10 - 45.10 - 49.10 DAILY RESTYLING 35.10-49.10 TURBO DAILY 30-35-49.10 35.12 - 49.12 - 59.12
	100003	504085410 500309459	Supporto motore posteriore <i>Engine rear support</i>	Daily City 2000 35S9/S11/S13/S15 35C9/C11/C13/C15 50C11/C13/C15 65C13/C15
	100061	8582425	Tassello posteriore motore <i>Engine rear dowel</i>	NEW DAILY 30.8 - 35.8 - 40.8 35.10 - 45.10 - 49.10 DAILY RESTYLING 35.10-49.10 TURBO DAILY 35.10 - 49.10 35.12 - 49.12 - 59.12

TASSELLI MOTORE ENGINE DOWELS

Illustrazione <i>Illustration</i>	Ns.Rif. <i>Our Ref.</i>	Rif.Costr. <i>O.E. Ref.</i>	Descrizione <i>Description</i>	Tipo di veicolo <i>Vehicle Type</i>
	100004	500342991	Supporto motore Sx Engine left support	DAILY CITY 2000 35S9/S11/S13/S15 35C9/C11/C13/C15 50C11/C13/C15 65C11/C13/C15
	100005	500342992	Supporto motore Dx Engine right support	DAILY CITY 2000 35S9/S11/S13/S15 35C9/C11/C13/C15 50C11/C13/C15 65C11/C13/C15
	100007	8557402	Tassello ant. sostegno motore Front anchor engine support	TURBOZETA
	100002	4617444	Tassello anteriore sostegno motore <i>Front anchor engine support</i>	115.14/17 - 135.14/17 145.17 - 175.17 TURBOSTAR 190.36 - 240.36 - 260.36 TURBOTECH 190.30/36 220.36 - 240.36 - 260.36
	100091	4467652	Tassello sostegno cambio <i>Gear box anchor support</i> Cambi Fuller MRT 9509 MRT 11609 MRT 9513 MRT 11613 MRT 11613B	190-26H/30H/30N/25AN 330.26/30/35/36

PARACOLPI SOSPENSIONI SUSPENSION BUFFERS

Illustrazione <i>Illustration</i>	Ns.Rif. <i>Our Ref.</i>	Rif.Costr. <i>O.E. Ref.</i>	Descrizione <i>Description</i>	Tipo di veicolo <i>Vehicle Type</i>
	100937	93803299	Tampone paracolpo superiore sospensione anteriore <i>Front suspension higher buffer</i>	DAILY RESTYLING 30-35-40.8 35.10 - 45.10 - 49.10 NEW DAILY 30-35-40.8 35.10 - 45.10 - 49.10 TURBO DAILY 35-49-59.12
	100908	93802207	Tampone paracolpo superiore sospensione anteriore <i>Front suspension higher buffer</i>	DAILY RESTYLING 30-35-40.8 35.10 - 45.10 - 49.10
	100909	93807567	Tampone paracolpo superiore sospensione anteriore <i>Front suspension lower buffer</i>	DAILY RESTYLING 45.10-49.10 NEW DAILY 30-35-40.8 35.10 - 45.10 - 49.10 TURBO DAILY 35-49-59.12
	100910	504060027 500362729	Tampone paracolpo superiore sospensione anteriore <i>Front suspension higher buffer</i>	DAILY CITY 2000 35S9/S11/S13/S15 35C9/C11/C13/C15 35S10/S12 35C10/C12
	100911	500306407	Tampone paracolpo inferiore sospensione anteriore <i>Front suspension lower buffer</i>	DAILY CITY 2000 35S9/S11/S13/S15 35C9/C11/C13/C15 35S10/S12 35C10/C12

**PARACOLPI SOSPENSIONI
SUSPENSION BUFFERS**

Illustrazione <i>Illustration</i>	Ns.Rif. <i>Our Ref.</i>	Rif.Costr. <i>O.E. Ref.</i>	Descrizione <i>Description</i>	Tipo di veicolo <i>Vehicle Type</i>
	100008	504060351	Paracolpo balestra posteriore Rear leaf spring buffer	Daily City 2000 35S9/S10/S11/S12/S13/S15
	100013	99470924	Paracolpo balestra posteriore Rear leaf spring buffer (ESAUIMENTO)	Daily City 2000 35S9/S10/S11/S12/S13
	100014	93803992	Paracolpo balestra posteriore Rear leaf spring buffer	New Daily Daily Restyling Daily City 2000 35C9/C11/C13/C15 50C11/C13/C15
	100016	93814245	Paracolpo balestra posteriore Rear leaf spring buffer (ESAUIMENTO)	Turbodaily '96 59.12 Daily City 2000 65C11/C13/C15
	100912	500316838	Tampone paracolpo superiore sospensione anteriore <i>Front suspension higher</i> buffer	DAILY CITY 2000 35S9/S11/S13/S15 35C9/C11/C13/C15 35S10/S12 35C10/C12
	100913	500316841	Tampone paracolpo inferiore sospensione anteriore <i>Front suspension lower</i> buffer	DAILY CITY 2000 35S9/S11/S13/S15 35C9/C11/C13/C15 35S10/S12 35C10/C12

PARACOLPI SOSPENSIONI SUSPENSION BUFFERS

Illustrazione Illustration	Ns.Rif. Our Ref.	Rif.Costr. O.E. Ref.	Descrizione Description	Tipo di veicolo Vehicle Type
	100914	500320322	Tampone paracolpo sospensione posteriore <i>Rear suspension buffer</i>	DAILY CITY 2000 35C9/C10/C11/C12/C13/C15
	100030	98401286	Tassello sospensione Suspension dowel	EUROCARGO 60E10/E12/E14 65E10/E12/E14 75E12/E14/E15 EUROCARGO TECTOR
	100031	98405404	Tassello sospensione Suspension dowel	EUROCARGO 120-130-150-170 EUROCARGO TECTOR
	100935	98404961	Tassello sospensione Suspension dowel	EUROCARGO 170E18/E23 180E21/E24/E28 EUROCARGO TECTOR EUROTECH 180E21/E24/E27/E28/E30/E34 190E24/E27/E30
	100033	4714376	Tassello sospensione Suspension dowel (ESAURIMENTO)	TURBOTECH TURBOSTAR EUROCARGO TECTOR EUROTECH EUROTRAKKER CURSOR STRALIS

Illustrazione Illustration	Ns.Rif. Our Ref.	Rif.Costr. O.E. Ref.	Descrizione Description	Tipo di veicolo Vehicle Type
	100053	81962100554	Supporto a molla sospensioni Suspension support	MAN TGA
	100035	0003250496	Supporto sospensione Suspension support	MERCEDES ACTROS
	100036	0003250596	Supporto sospensione Suspension support	MERCEDES ATEGO ACTROS
	100038	0003250896	Supporto sospensione Suspension support	MERCEDES ACTROS

SUPPORTI SOSPENSIONE SUSPENSION SUPPORT

Illustrazione <i>Illustration</i>	Ns.Rif. <i>Our Ref.</i>	Rif.Costr. <i>O.E. Ref.</i>	Descrizione <i>Description</i>	Tipo di veicolo <i>Vehicle Type</i>
	100039	1586089 1587103 1508080	Supporto sospensione posteriore a molla Rear suspension spring support	VOLVO F7 - F10 - F12
	100040	1609657 1577873 8151413	Supporto sospensione posteriore a molla Rear suspension spring support	VOLVO F7 - F10 - F12 - F16 FL7 - FL10 - FL12 FH12 - FH16
	100041	1629553 2039836 3090971	Supporto sospensione posteriore a molla Rear suspension spring support	VOLVO F7 - F10 - F12 - F16 FL7 - FL10 - FL12 FH12 - FH16

CUFFIE ASPIRAZIONE BELLOWS

Illustrazione <i>Illustration</i>	Ns.Rif. <i>Our Ref.</i>	Rif.Costr. <i>O.E. Ref.</i>	Descrizione <i>Description</i>	Tipo di veicolo <i>Vehicle Type</i>
	101050	61596842 4820412	Cuffia aspirazione <i>Bellow</i> (AD ESAURIMENTO)	ZETA 50.9 - 79-95-10.14 TURBOZETA 65-79.12 115-135.14/17 - 145.17 175.17/24
	101051	42040707	Cuffia aspirazione <i>Bellow</i>	TURBOSTAR 190.36/42/48 TURBOTECH 190.26/30/30H/32/36 330.30H - 330.36H
	101053	8141955	Cuffia aspirazione <i>Bellow</i> (ESAURIMENTO)	EUROCARGO 60-65E10/E12/E14 75E12/E14/E15 80E15/E18/E21 95E15/E21 100-120E15/E18/E21 130E15/E18/E23 135E18/E23 150-170E15/E18/E23/E27 260E23 - 280E23 EUROCARGO TECTOR 75E13/E15/E17/E18 100E17/E18/E21 120E17/E21 130-150E18/E21/E24/E28 180E21/E24/E28 260E28







CUFFIE ASPIRAZIONE BELLOWS

Illustrazione <i>Illustration</i>	Ns.Rif. <i>Our Ref.</i>	Rif.Costr. <i>O.E. Ref.</i>	Descrizione <i>Description</i>	Tipo di veicolo <i>Vehicle Type</i>
	101054	98479283	Cuffia aspirazione <i>Bellow</i> (ESAUIMENTO)	EUROCARGO 60-65E10/E12/E14 75E12/E14/E15 80E15/E18/E21 95E15/E21 100-120E15/E18/E21 130E15/E18/E23 135E18/E23 150-170E15/E18/E23/E27 260E23 - 280E23 EUROCARGO TECTOR 75E13/E15/E17/E18 100E17/E18/E21 120E17/E21 130-150E18/E21/E24/E28 180E21/E24/E28 260E28
	101056	98473621	Cuffia aspirazione <i>Bellow</i>	EUROTECH T.T. EUROTRAKKER T.T. EUROSTAR T.T.



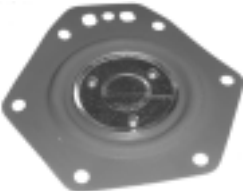

CUFFIE LEVA MARCE GEAR LEVER PROTECTIVE HOODS

Illustrazione <i>Illustration</i>	Ns.Rif. <i>Our Ref.</i>	Rif.Costr. <i>O.E. Ref.</i>	Descrizione <i>Description</i>	Tipo di veicolo <i>Vehicle Type</i>
	100606	93911172	Cuffia leva marce <i>Gear lever protective hood</i>	DAILY T.T.
	100604	8584807	Cuffia leva marce <i>Gear lever protective hood</i>	ZETA 50-65.9 TURBOZETA 60.11 65-79.12-79.13-79.14 OM80-90 - 80-90-100NC 80-90-100.13 ZETA 95-109.14 (3°-4°serie)
	100601	4654040	Cuffia leva marce <i>Gear lever protective hood</i>	160-180NC - 684N-T 619-697-300
	100602	4725239	Cuffia leva marce <i>Gear lever protective hood</i>	TURBOSTAR 190.42/48 240-260.48 190.38 TRU (3°serie) Turbo TURBOTECH - TURBOSTAR 190-240-260.36 TURBOTECH 190-240-260.32 190.33 TURBOSTAR 190-220.35 TURBOTECH 190.26/30 TRU - 180.24/26

ARTICOLI VARI VARIOUS PARTS

Illustrazione <i>Illustration</i>	Ns.Rif. <i>Our Ref.</i>	Rif.Costr. <i>O.E. Ref.</i>	Descrizione <i>Description</i>	Tipo di veicolo <i>Vehicle Type</i>
	103631	4625614	Boccola sterzo <i>Steering bushing</i>	110-130-160-180NC 619-697-300PC
	953016	93806182	Giunto elastico sterzo <i>Steering flexible coupling</i>	DAILY T.T.
	103634	9921902	Giunto elastico sterzo <i>Steering flexible coupling</i>	OM 40/35
	100032	500329485	Tassello gomma sostegno silenziatore <i>Holding exhaust dowel</i>	DAILY CITY 2000 35S9/S11/S13/S15 35C9/C11/C13/C15 50C11/C13/C15 65C13/C15
	103611	4771078	Membrana sfiato olio motore <i>Engine oil membrane breather</i>	TURBOSTAR 190.42/48 240.36/48 - 260.36 TURBOTECH 220.36 - 240.36 330.30/36
	103610	4733157	Membrana sfiato olio motore <i>Engine oil membrane breather</i> (ESAUIMENTO)	190.38
	103608	61315069	Membrana sfiato olio motore <i>Engine oil membrane breather</i>	TURBOTECH 190.24/26/32 - 240.26 - 260.32 TURBOCITY EUROTECH EUROSTAR EUROTRAKKER

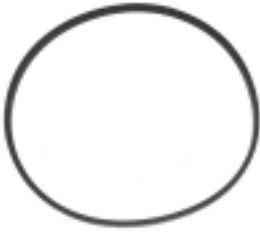
**ARTICOLI VARI
VARIOUS PARTS**

Illustrazione Illustration	Ns.Rif. Our Ref.	Rif.Costr. O.E. Ref.	Descrizione Description	Tipo di veicolo Vehicle Type
	103613	4600893	Anello tenuta sfiato olio <i>Oil breather tightness ring</i>	DAILY T.T. ZETA 50.9-65.9 79.14-95.14-109.14 115/135.14/17 - 145/175.17
	103607	98481105 4696011	Guarnizione coperchio <i>Cover gasket</i>	170-190.35/38/42 EUROSTAR 190-240-260-440E52
	103606	98481106	Guarnizione coperchio <i>Cover gasket</i>	170-190.35/38/42 EUROSTAR 190-240-260-440E52
	103635	42061628	Anello tenuta mozzo <i>Hub holding ring</i>	190.26 - 190.30 330.26 - 330.36 EUROTECH EUROTRAKKER CURSOR
	960733	4691818	Tirante valvola <i>Valve rod</i>	115-135.14/17 - 145.17 175.17/24

MANICOTTI ACQUA AL SILICONE SILICON WATER SLEEVES

Illustrazione <i>Illustration</i>	Ns.Rif. <i>Our Ref.</i>	Rif.Costr. <i>O.E. Ref.</i>	Descrizione <i>Description</i>	Tipo di veicolo <i>Vehicle Type</i>
	102375	42088612	Manicotto acqua al silicone <i>Silicon water sleeve</i> (ESAURIMENTO)	TURBOSTAR 190.36 - 240.36 - 260.36 TURBOTECH 190.36 220.26 - 240.36 - 260.36
	102377	42088622	Manicotto acqua al silicone <i>Silicon water sleeve</i> (ESAURIMENTO)	TURBOSTAR 190.36 - 240.36 - 260.36 TURBOTECH 190.36 220.6 - 240.36 - 260.36 330.36
	102378	42106780	Manicotto acqua al silicone <i>Silicon water sleeve</i> (ESAURIMENTO)	TURBOSTAR 190.48 - 240.48 - 260.48
	102379	42106779	Manicotto acqua al silicone <i>Silicon water sleeve</i> (ESAURIMENTO)	TURBOSTAR 190.48 - 240.48 - 260.48
	102393	42088621	Manicotto silicone <i>Silicon water sleeve</i> (ESAURIMENTO)	TURBOTECH 190.32 - 240.32 - 260.32 EUROTRAKKER 190E34 - 260E34 330E34 - 380E34 - 400E34 EUROSTAR 190E38/E52 240E52 - 400E52 - 440E38/E52 EUROTECH 180E24/E27/E30/E34/E38 190E24/E27/E30 325E27 - 400E30/E34
	102394	8134300	Manicotto acqua al silicone <i>Silicon water sleeve</i> (ESAURIMENTO)	EUROTRAKKER 190E30/E31/E34/E37/E42 260E30/E34/E37 - 330E34/E37 380E31/E34/E37 400E31/E37/E42 - 410E37/E42 720E37 EUROSTAR 180E38 190E38/E42 - 400E38/E42 440E38 EUROTECH 180E30/E34 - 190E30 400E30/E34

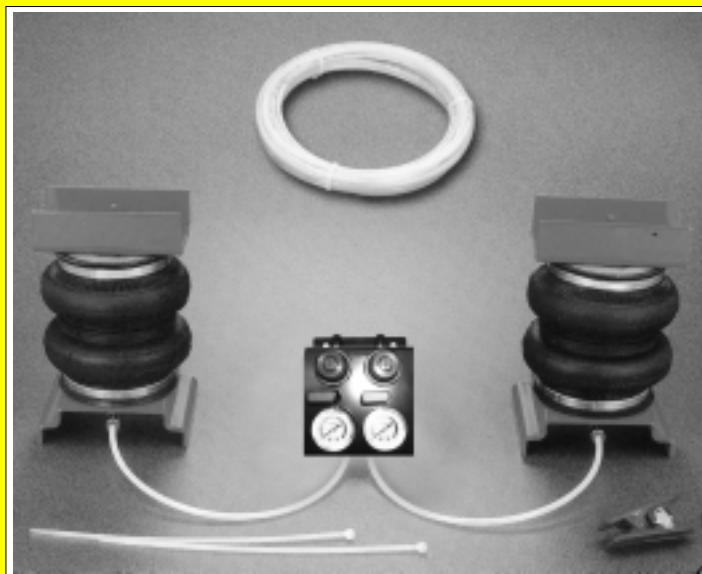

Ns.Rif. <i>Ns.Ref.</i>	Rif. O.E. <i>O.E. Ref.</i>	Taratura <i>Calibration</i>
103400	-	2,5 Bar
103400.1	-	4 Bar

Applicazione tipo veicolo
Vehicle type

NUOVO DUCATO (dal 1994)
DUCATO NEW (to 1994)
PEUGEOT BOXER
CITROEN JUMPER

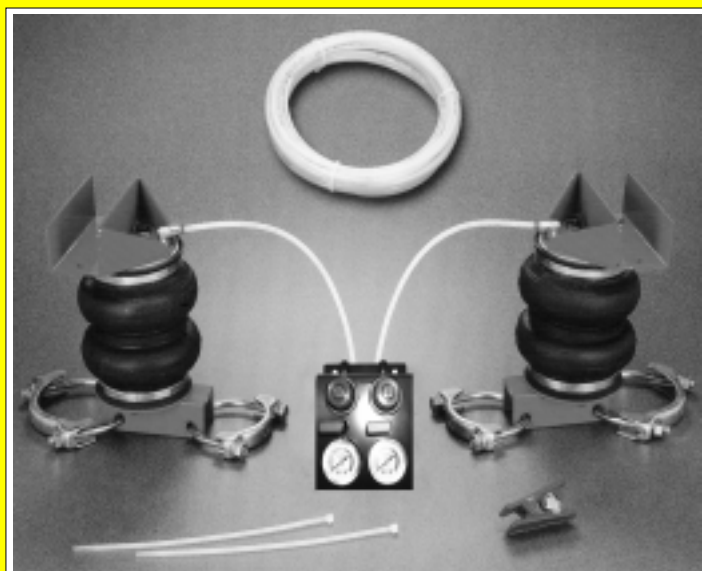

Ns.Rif. <i>Ns.Ref.</i>	Rif. O.E. <i>O.E. Ref.</i>	Taratura <i>Calibration</i>
103401	-	2,5 Bar
103401.1	-	4 Bar

Applicazione tipo veicolo
Vehicle type

DUCATO (1°serie dal 1994)
DUCATO (1°type to 1994)
PEUGEOT J5
CITROEN C25

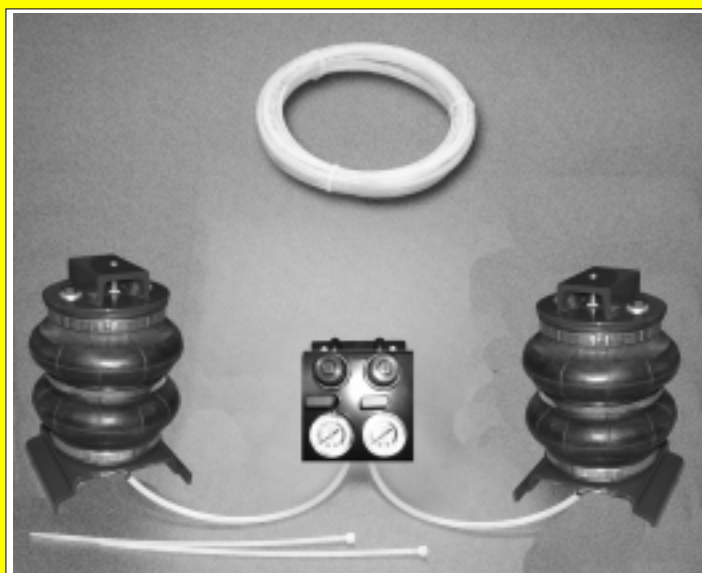

Ns.Rif. <i>Ns.Ref.</i>	Rif. O.E. <i>O.E. Ref.</i>	Taratura <i>Calibration</i>
103421	-	2,5 Bar
103421.1	-	4 Bar

Applicazione tipo veicolo
Vehicle type

DUCATO 2007

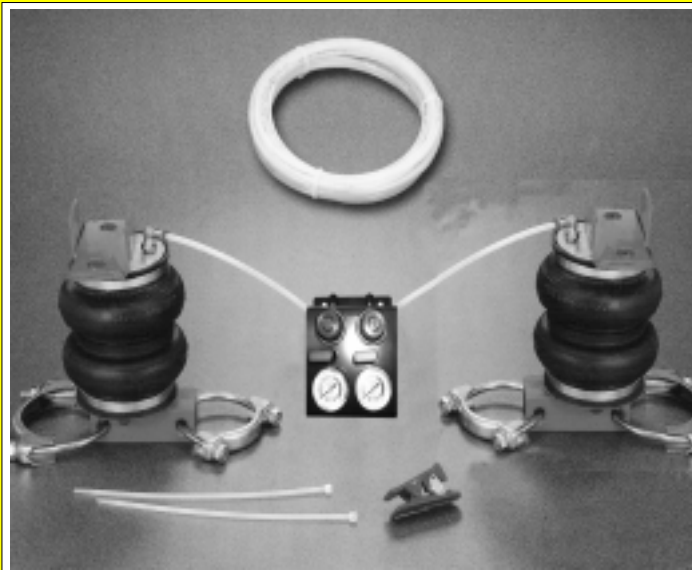

Ns.Rif. <i>Ns.Ref.</i>	Rif. O.E. <i>O.E. Ref.</i>	Taratura <i>Calibration</i>
103414	-	2,5 Bar
103414.1	-	4 Bar

Applicazione tipo veicolo
Vehicle type

FORD TRANSIT
300-330-350SL (dal 2000)
Ponte tondo - Round axle
Ruota gemellata
Twin wheels

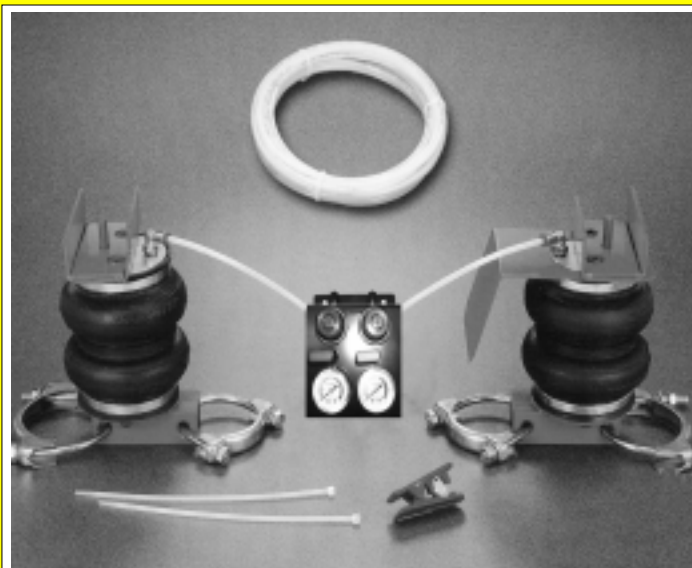

Ns.Rif. <i>Ns.Ref.</i>	Rif. O.E. <i>O.E. Ref.</i>	Taratura <i>Calibration</i>
103406	-	2,5 Bar
103406.1	-	4 Bar

Applicazione tipo veicolo
Vehicle type

FORD TRANSIT
80-100L-120-130-150-190
Ponte tondo
Round axle

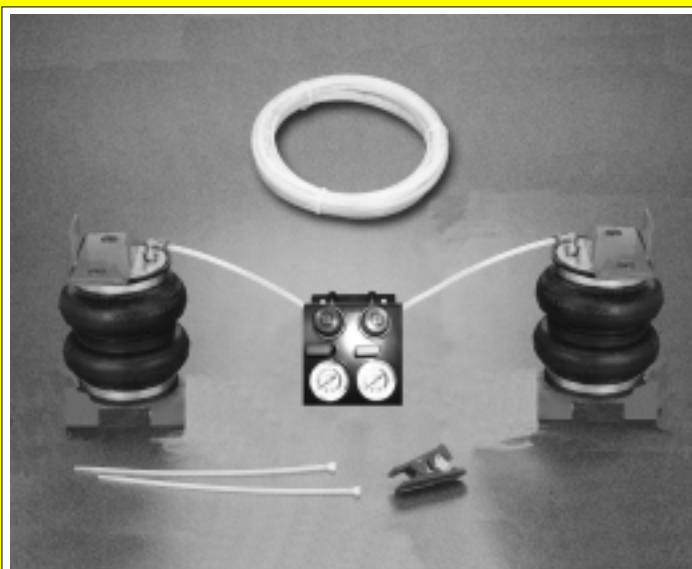

Ns.Rif. <i>Ns.Ref.</i>	Rif. O.E. <i>O.E. Ref.</i>	Taratura <i>Calibration</i>
103420	-	2,5 Bar
103420.1	-	4 Bar

Applicazione tipo veicolo
Vehicle type

FORD TRANSIT 2001
Ruota singola
Single wheel
Ponte quadro
Square axle
Trazione anteriore
Front drive

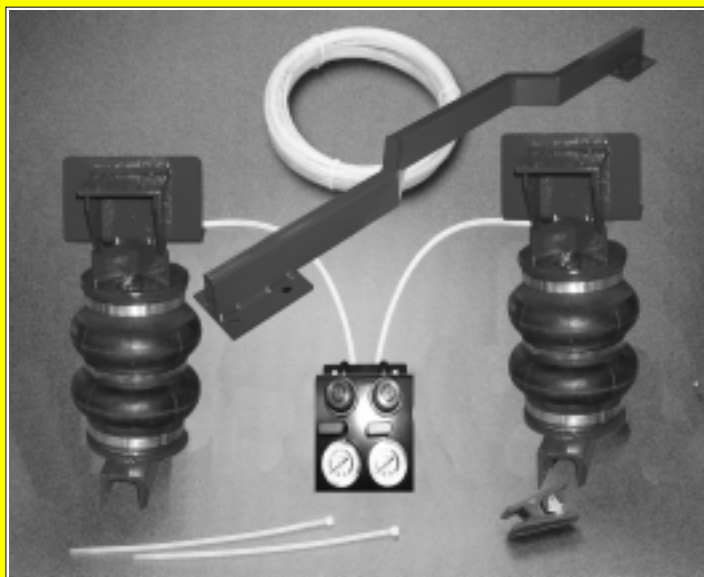

Ns.Rif. <i>Ns.Ref.</i>	Rif. O.E. <i>O.E. Ref.</i>	Taratura <i>Calibration</i>
103422	-	2,5 Bar
103422.1	-	4 Bar

Applicazione tipo veicolo
Vehicle type

FORD TRANSIT 2007
Ruota gemellata
Twin wheels

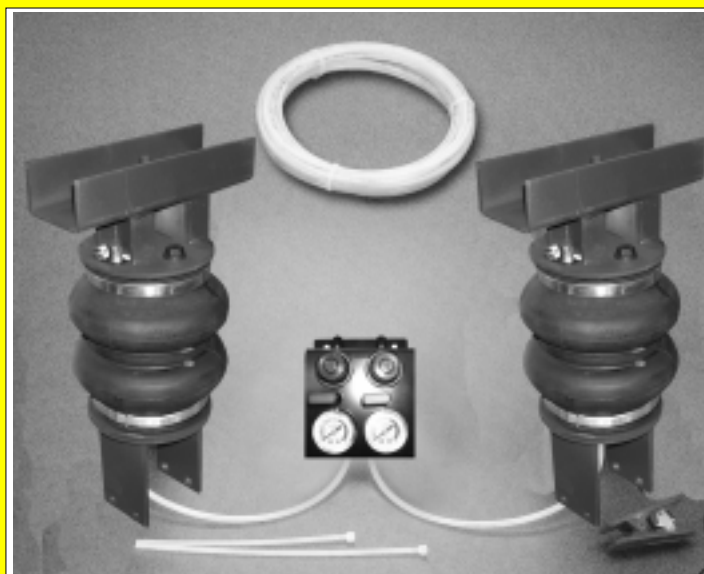

Ns.Rif. <i>Ns.Ref.</i>	Rif. O.E. <i>O.E. Ref.</i>	Taratura <i>Calibration</i>
103423	-	2,5 Bar
103423.1	-	4 Bar

Applicazione tipo veicolo
Vehicle type

FORD TRANSIT 2008
Ponte quadro
Square axle

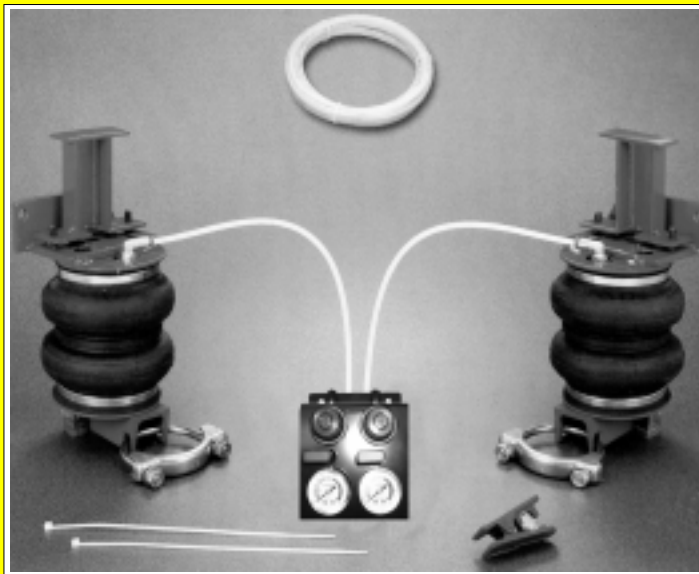

Ns.Rif. <i>Ns.Ref.</i>	Rif. O.E. <i>O.E. Ref.</i>	Taratura <i>Calibration</i>
103405	-	2,5 Bar
103405.1	-	4 Bar

Applicazione tipo veicolo
Vehicle type

DAILY M.Y. 2006
DAILY CITY 2000
35S9/S11/S13
35C9/C11/C13
DAILY RESTYLING
NEW DAILY
TURBO DAILY
DAILY 96

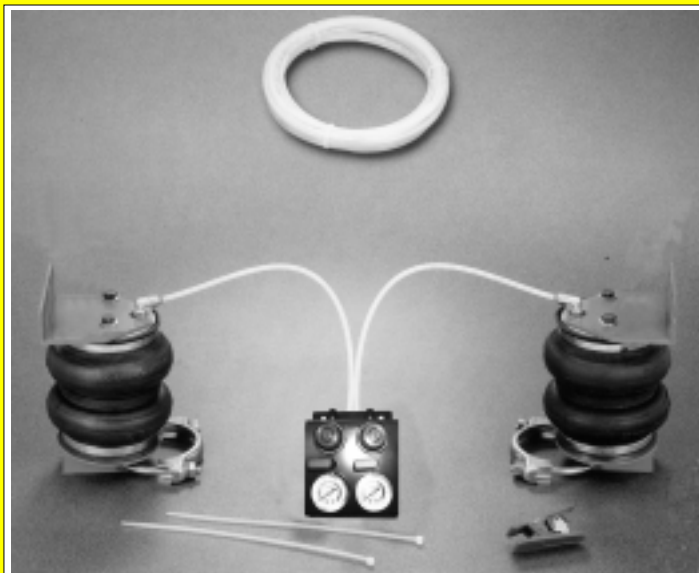

Ns.Rif. <i>Ns.Ref.</i>	Rif. O.E. <i>O.E. Ref.</i>	Taratura <i>Calibration</i>
103418	-	2,5 Bar
103418.1	-	4 Bar

Applicazione tipo veicolo
Vehicle type

DAILY CITY 2000
Ruota singola
Single wheel

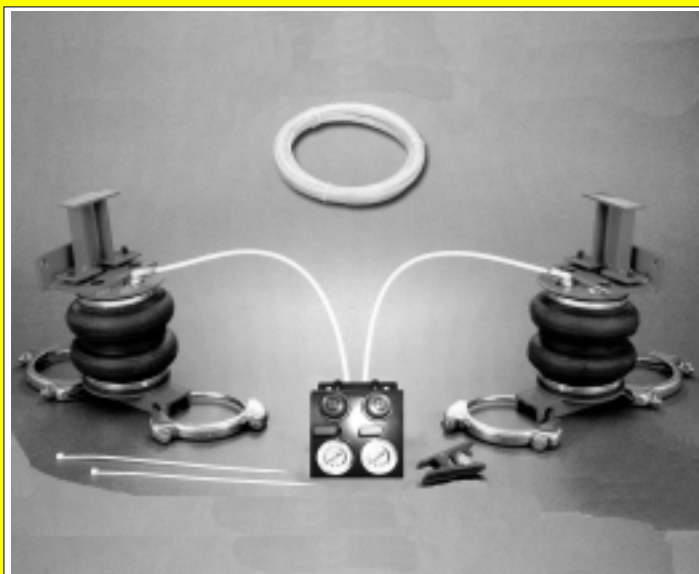

Ns.Rif. <i>Ns.Ref.</i>	Rif. O.E. <i>O.E. Ref.</i>	Taratura <i>Calibration</i>
103404	-	2,5 Bar
103404.1	-	4 Bar

Applicazione tipo veicolo
Vehicle type

TURBODAILY
59.12

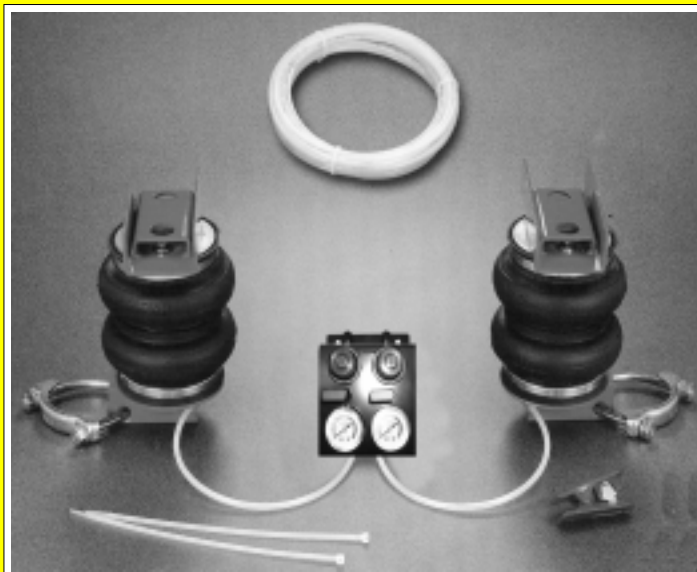

Ns.Rif. <i>Ns.Ref.</i>	Rif. O.E. <i>O.E. Ref.</i>	Taratura <i>Calibration</i>
103402	-	2,5 Bar
103402.1	-	4 Bar

Applicazione tipo veicolo
Vehicle type

MERCEDES SPRINTER
Ruota singola
Single wheel
WOLKSVAGEN LT35 U.T
Ruota singola dal 1997
Single wheel from 1997

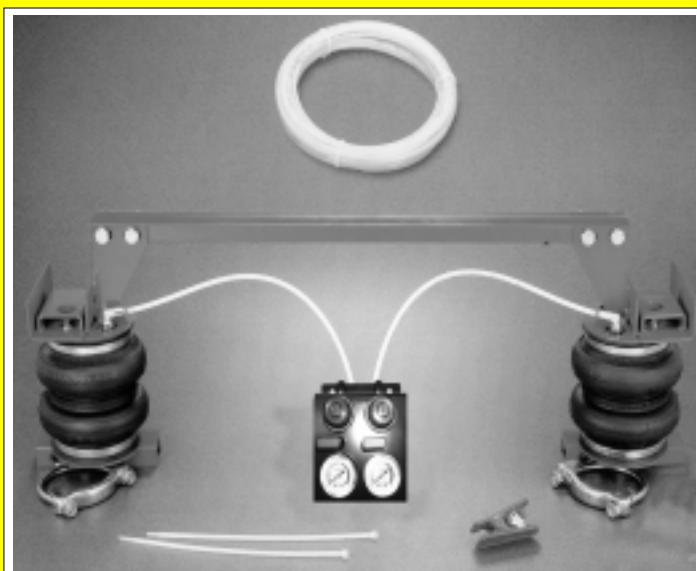

Ns.Rif. <i>Ns.Ref.</i>	Rif. O.E. <i>O.E. Ref.</i>	Taratura <i>Calibration</i>
103403	-	2,5 Bar
103403.1	-	4 Bar

Applicazione tipo veicolo
Vehicle type

MERCEDES SPRINTER
Ruota gemellata
Coupled wheels
WOLKSVAGEN LT35/46
Ruota gemellata dal 1997
Coupled wheels from 1997

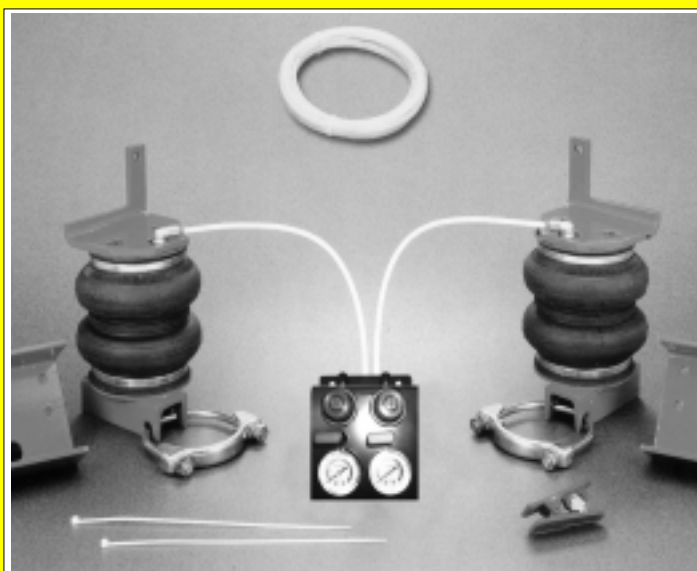

Ns.Rif. <i>Ns.Ref.</i>	Rif. O.E. <i>O.E. Ref.</i>	Taratura <i>Calibration</i>
103416	-	2,5 Bar
103416.1	-	4 Bar

Applicazione tipo veicolo
Vehicle type

NISSAN ATLEON
110HD

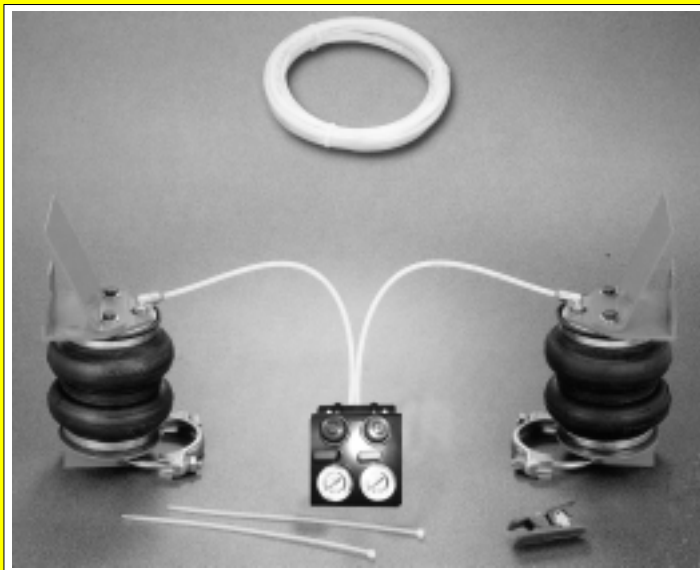

Ns.Rif. <i>Ns.Ref.</i>	Rif. O.E. <i>O.E. Ref.</i>	Taratura <i>Calibration</i>
103415	-	2,5 Bar
103415.1	-	4 Bar
Applicazione tipo veicolo <i>Vehicle type</i>		
NISSAN CABSTAR E110		

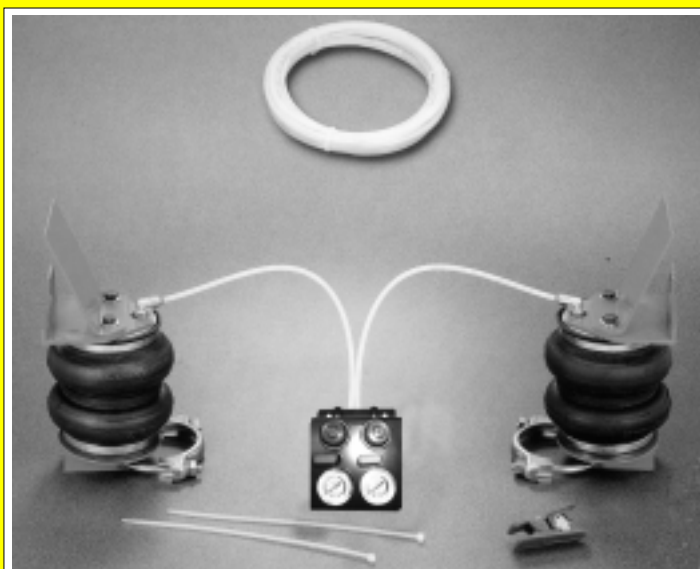

Ns.Rif. <i>Ns.Ref.</i>	Rif. O.E. <i>O.E. Ref.</i>	Taratura <i>Calibration</i>
103412	-	2,5 Bar
103412.1	-	4 Bar
Applicazione tipo veicolo <i>Vehicle type</i>		
NISSAN TRADE 100		

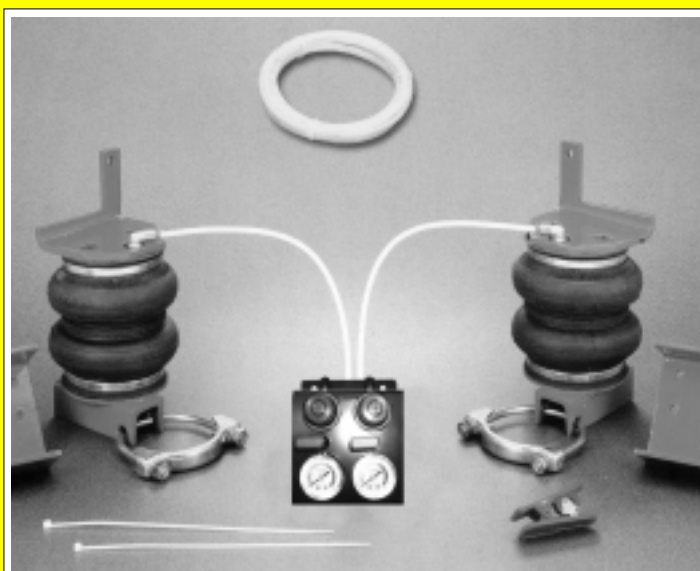

Ns.Rif. <i>Ns.Ref.</i>	Rif. O.E. <i>O.E. Ref.</i>	Taratura <i>Calibration</i>
103413	-	2,5 Bar
103413.1	-	4 Bar
Applicazione tipo veicolo <i>Vehicle type</i>		
NISSAN ECO T100 ATLEON 110		

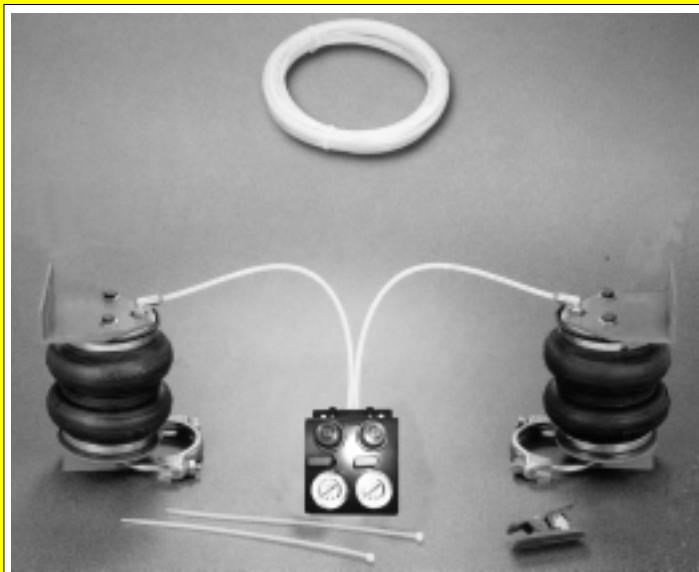

Ns.Rif. <i>Ns.Ref.</i>	Rif. O.E. <i>O.E. Ref.</i>	Taratura <i>Calibration</i>
103419	-	2,5 Bar
103419.1	-	4 Bar

Applicazione tipo veicolo
Vehicle type

RENAULT MASCOTT

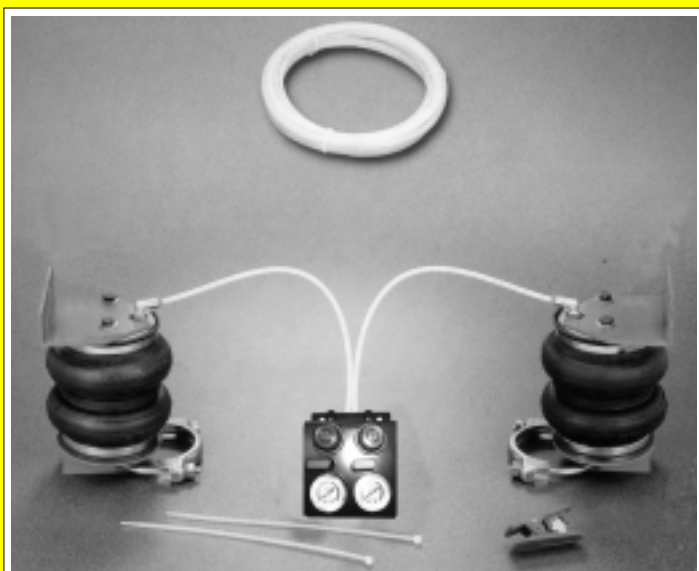

Ns.Rif. <i>Ns.Ref.</i>	Rif. O.E. <i>O.E. Ref.</i>	Taratura <i>Calibration</i>
103417	-	2,5 Bar
103417.1	-	4 Bar

Applicazione tipo veicolo
Vehicle type

RENAULT MASCOTT U.T.
160 (DAL 2005 - FROM 2005)

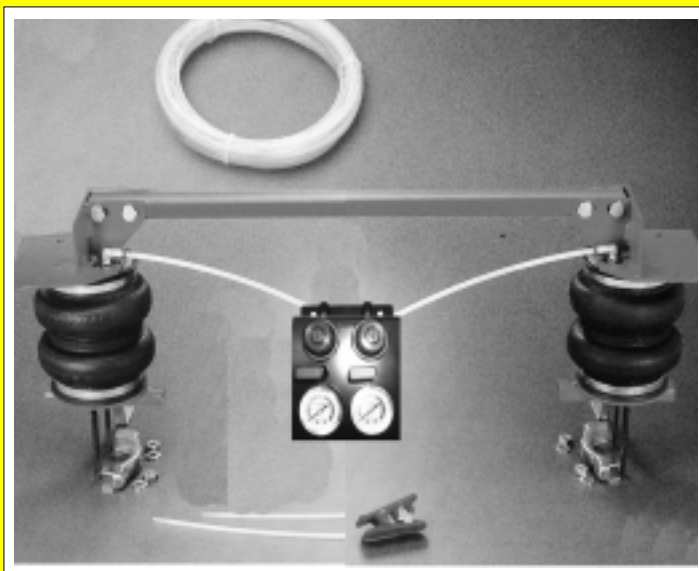

Ns.Rif. <i>Ns.Ref.</i>	Rif. O.E. <i>O.E. Ref.</i>	Taratura <i>Calibration</i>
103408	-	2,5 Bar
103408.1	-	4 Bar

Applicazione tipo veicolo
Vehicle type

RENAULT MASTER 35 U.T.

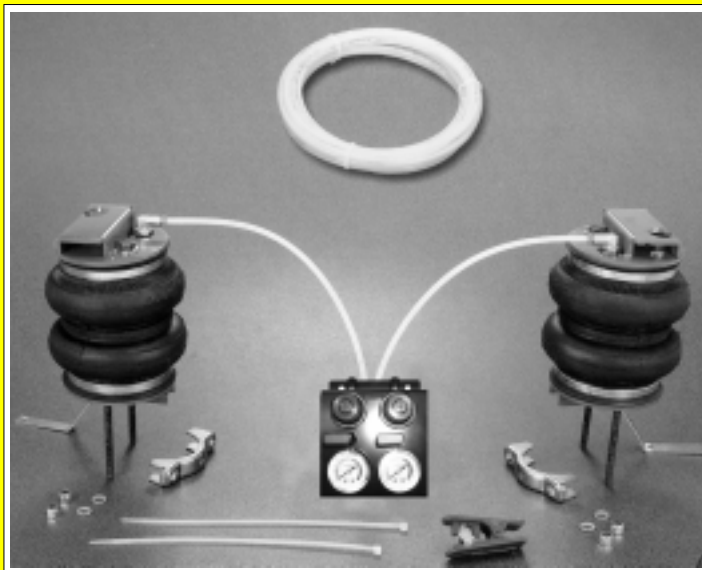

Ns.Rif. <i>Ns.Ref.</i>	Rif. O.E. <i>O.E. Ref.</i>	Taratura <i>Calibration</i>
103409	-	2,5 Bar
103409.1	-	4 Bar
Applicazione tipo veicolo <i>Vehicle type</i>		
RENAULT TRAFIC		

PARTI DI RICAMBIO SPARE PARTS



Ns.Rif. <i>Ns.Ref.</i>	Rif. O.E. <i>O.E. Ref.</i>	
103500	-	
Applicazione tipo veicolo <i>Vehicle type</i>		
Torpress per veicoli leggeri <i>(Torpress for light vehicle)</i>		



Ns.Rif. <i>Ns.Ref.</i>	Rif. O.E. <i>O.E. Ref.</i>	Taratura <i>Calibration</i>
103515.1	-	2,5 Bar
103515.2	-	4 Bar
Applicazione tipo veicolo <i>Vehicle type</i>		
Kit impianto pneumatico taratura (2,5 Bar) <i>Pneumatic system calibration (2,5 Bar)</i>		
Kit impianto pneumatico taratura (4 Bar) <i>Pneumatic system calibration (4 Bar)</i>		

KIT COMPRESSORE MONOCILINDRICO C/SERBATOIO 5 LT. - 12V
KIT MONO CYLINDRIC COMPRESSOR WITH TANC 5 LT - 12V

Ns.Rif.
Ns.Ref.

970008

Rif. O.E.
O.E. Ref.

-

Applicazione tipo veicolo
Vehicle type

 Veicoli leggeri T.T.
 Light vehicles

KIT COMPRESSORE BICILINDRICO C/SERBATOIO 5 LT. - 12V
KIT BYCYLINDRIC COMPRESSOR WITH TANC 5 LT - 12V

Ns.Rif.
Ns.Ref.

970009

Rif. O.E.
O.E. Ref.

-

Applicazione tipo veicolo
Vehicle type

 Veicoli leggeri T.T.
 Light vehicles

KIT COMPRESSORI ARIA
KIT AIR COMPRESSOR

EMMERRE

KIT COMPRESSORE MONOCILINDRICO C/SERBATOIO 5 LT. - 24V
KIT MONO CYLINDRIC COMPRESSOR WITH TANC 5 LT - 24V



Ns.Rif.
Ns.Ref.

Rif. O.E.
O.E. Ref.

970003

-

Applicazione tipo veicolo
Vehicle type

Veicoli leggeri T.T.
Light vehicles

KIT COMPRESSORE BICILINDRICO C/SERBATOIO 5 LT. - 24V
KIT BYCYLINDRIC COMPRESSOR WITH TANC 5 LT - 24V



Ns.Rif.
Ns.Ref.

Rif. O.E.
O.E. Ref.

970005

-

Applicazione tipo veicolo
Vehicle type

Veicoli leggeri T.T.
Light vehicles

EMMERRE *Presenta***AIR FREN***Freno motore ad aria per veicoli commerciali Common Rail*

I freni del vostro autocarro, a disco o a tamburo, singoli o doppi che siano, sono soggetti a forti sollecitazioni, possono quindi facilmente surriscaldarsi diminuendo le loro prestazioni sino a compromettere il livello di sicurezza del guidatore o del carico.

Il surriscaldamento provoca, inoltre, pericolose deformazioni nell'impianto con conseguente anomala usura dei freni che determina un'ulteriore, quanto irreversibile, diminuzione dell'efficienza dell'intero sistema frenante.

Risulta evidente come tutto ciò comporti un

notevole aumento dei costi. Il freno motore ad aria AIR FREN, applicato sui veicoli commerciali, integra l'azione del sistema frenante e contribuisce in misura determinante alla soluzione di questi problemi.

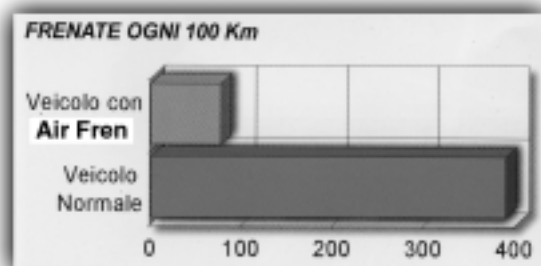

Il miglioramento è evidenziato anche dal fatto che il freno motore ad aria AIR FREN riduce drasticamente il numero di frenate necessarie per un percorso medio di 100 Km.

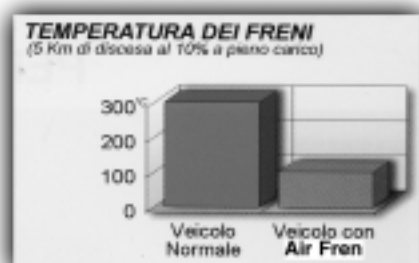

Test effettuati dimostrano come anche un breve tragitto in discesa, 5 Km, possa mettere seriamente in crisi il sistema frenante di un veicolo commerciale. L'utilizzo dell' AIR FREN consente di riportare la temperatura dei freni entro i normali limiti di funzionamento.

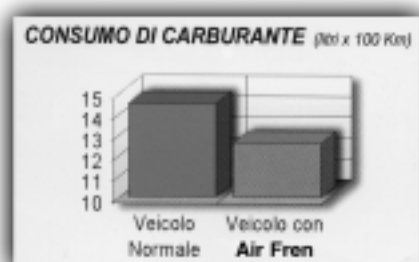

Grazie alla particolare azione sviluppata dal freno motore ad aria, vengono ridotti anche i consumi di carburante. I test dimostrano come un veicolo commerciale che utilizzi questo sistema sia in grado di risparmiare circa il 15% di carburante arrivando a percorrenze medie impensabili per i veicoli che ne sono sprovvisti.

**FRENO MOTORE ELETTRICO
ELECTRIC ENGINE BRAKE**

EMMERRE

**KIT FRENO MOTORE ELETTRICO
KIT ELECTIC ENGINE BRAKE**



**Ns.Rif.
Ns.Ref.**

**Rif. O.E.
O.E. Ref.**

304000

1411100

**Applicazione tipo veicolo
Vehicle type**

Veicoli leggeri T.T.
Light vehicles

**Ns.Rif.
Ns.Ref.**

**Rif. O.E.
O.E. Ref.**

**Applicazione tipo veicolo
Vehicle type**

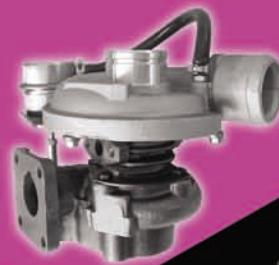

**TECHNO
BRAKE®**

Hydro Pump

**VEICOLI COMMERCIALI
COMMERCIAL VEHICLES
VEHICULES UTILITAIRES
VEHICULOS COMERCIALES
NUTZFAHRZEUGE**

**Легкий коммерческий транспорт
النقل الخفيف**

EMMEDE



2009

TIPO DI VEICOLO / VEHICLE TYPE

DUCATO (Impianto Lucas - Lucas system) - **TALENTO** - **PEUGEOT J5** - **CITROEN C25**
(14 q.li - da telaio 155247 - Autobus - Furgonato e pianale piatto)1.8 (07/82-12/88) - 1.9D (02/87-08/90) - 1.9D (07/90-03/94) - 1.9TD (03/89-08/90)
1.9TD (07/90-03/94) - 2.0 (07/82-08/90) - 2.0 (07/90-03/94) - 2.4D (07/82-12/85)
2.4D (07/90-03/94) - 2.5D (01/86-08/90) - 2.5D (07/90-03/94) - 2.5D 4X4 (01/87-08/90)
2.5TD 4X4 (07/90-03/94) - 2.5TD (01/87-08/90) - 2.5TD 4X4 (01/86-08/90)

ILLUSTRAZIONE / ILLUSTRATION	NOSTRO RIFERIMENTO OUR REFERENCE	RIFERIMENTO COSTRUTTORE O.E. REFERENCE								
<p>TH min. 11,00 mm.</p> <p>5 fori - 5 Holes</p> <p>Ø 73 mm.</p> <p>61,5 mm.</p> <p>13 mm.</p> <p>Ø 255 mm.</p> 	960378	4450931 - 7568501								
DESCRIZIONE / DESCRIPTION										
Disco freno assale anteriore Brake disc front axle										
										
ILLUSTRAZIONE / ILLUSTRATION	NOSTRO RIFERIMENTO OUR REFERENCE	RIFERIMENTO COSTRUTTORE O.E. REFERENCE								
<p>Connettore tondo - Round connector</p>  <p>E3 90R</p>	960862	9945070 9941207								
DESCRIZIONE / DESCRIPTION										
Serie pastiglie freno anteriore - Set of brake pads front										
<table border="1"> <thead> <tr> <th>WVA</th> <th>Larghezza Width - mm.</th> <th>Altezza Height -mm.</th> <th>Spessore Thickness - mm.</th> </tr> </thead> <tbody> <tr> <td>20741 20787</td> <td>130</td> <td>71,5</td> <td>19</td> </tr> </tbody> </table>			WVA	Larghezza Width - mm.	Altezza Height -mm.	Spessore Thickness - mm.	20741 20787	130	71,5	19
WVA	Larghezza Width - mm.	Altezza Height -mm.	Spessore Thickness - mm.							
20741 20787	130	71,5	19							
										
ILLUSTRAZIONE / ILLUSTRATION	NOSTRO RIFERIMENTO OUR REFERENCE	RIFERIMENTO COSTRUTTORE O.E. REFERENCE								
<p>Connettore tondo - Round connector</p>  <p>E3 90R</p>	960867	9945076								
DESCRIZIONE / DESCRIPTION										
Serie pastiglie freno anteriore - Set of brake pads front										
<table border="1"> <thead> <tr> <th>WVA</th> <th>Larghezza Width - mm.</th> <th>Altezza Height -mm.</th> <th>Spessore Thickness -mm.</th> </tr> </thead> <tbody> <tr> <td>21205 21206</td> <td>145</td> <td>71,50</td> <td>19,40</td> </tr> </tbody> </table>			WVA	Larghezza Width - mm.	Altezza Height -mm.	Spessore Thickness -mm.	21205 21206	145	71,50	19,40
WVA	Larghezza Width - mm.	Altezza Height -mm.	Spessore Thickness -mm.							
21205 21206	145	71,50	19,40							
										

TIPO DI VEICOLO / VEHICLE TYPE

DUCATO (Impianto Lucas - Lucas system)
(14 q.li - da telaio 154462 - Autobus - Furgonato e pianale piatto)

1.8 (07/82-12/88) - 1.9D (02/87-08/90) - 1.9D (07/90-03/94) - 1.9TD (03/89-08/94)
2.0 (07/82-03/94) - 2.4D (07/82-12/85) - 2.4D (07/90-03/94) - 2.5D (01/86-08/90)
2.5D (07/90-03/94) - 2.5D-TD 4X4 (01/87-03/94) - 2.5TD (01/87-08/90) - 2.5TD 4X4 (01/86-08/90)
TALENTO (14q.li) 1.9D (03/89-03/94)

ILLUSTRAZIONE / ILLUSTRATION

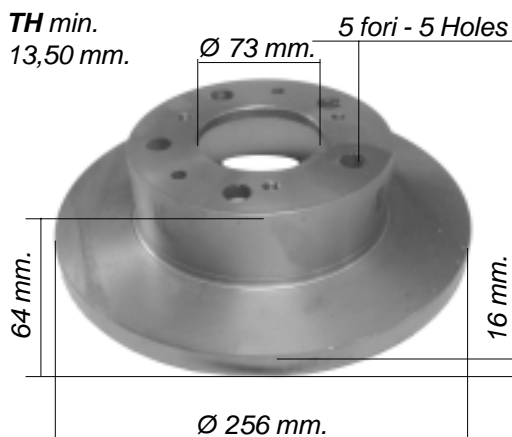

NOSTRO RIFERIMENTO OUR REFERENCE

960379

RIFERIMENTO COSTRUTTORE O.E. REFERENCE

7531819

DESCRIZIONE / DESCRIPTION

Disco freno assale anteriore
Brake disc front axle



ILLUSTRAZIONE / ILLUSTRATION

Connettore tondo - Round connector



NOSTRO RIFERIMENTO OUR REFERENCE

960862

RIFERIMENTO COSTRUTTORE O.E. REFERENCE

9945070
9941207

DESCRIZIONE / DESCRIPTION

Serie pastiglie freno anteriore - Set of brake pads front

WVA	Larghezza Width - mm.	Altezza Height - mm.	Spessore Thickness - mm.
20741 20787	130	71,5	19



ILLUSTRAZIONE / ILLUSTRATION

Connettore tondo - Round connector



NOSTRO RIFERIMENTO OUR REFERENCE

960867

RIFERIMENTO COSTRUTTORE O.E. REFERENCE

9945076

DESCRIZIONE / DESCRIPTION

Serie pastiglie freno anteriore - Set of brake pads front







WVA	Larghezza Width - mm.	Altezza Height - mm.	Spessore Thickness - mm.
21205 21206	145	71,50	19,40

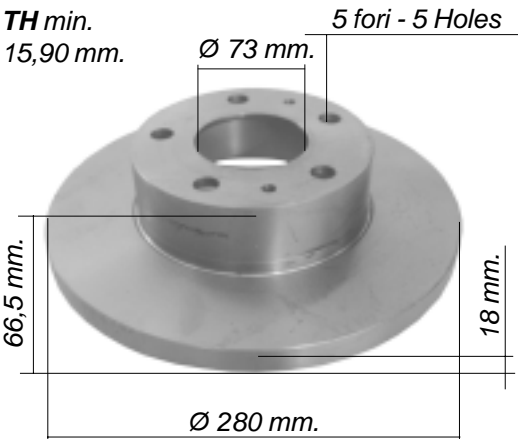

TIPO DI VEICOLO / VEHICLE TYPE

DUCATO (Impianto Lucas - Lucas system)
(14 q.li - Autobus - Furgonato e pianale piatto)

1.9D (04/98-04/02) - 1.9D COMBINATO (06/95-04/02) - 1.9TD (04/98-04/02)
 AUTOBUS - 1.9TD COMBI (08/94-04/02) - 2.0 (03/94-04/02) - 2.5D COMBI (08/94-04/02)
 2.5TDI 4X4(04/97-04/02) - 2.5TDI COMBINATO (08/94-04/02) - 2.5TDI (03/94-04/02)
 2.8D (02/98-04/02) - 2.8TDI (10/97-04/02) - 2.8TDI 4X4 (07/99-04/02) - 2.0 (04/02) - 2.8 JTD (04/02)

ILLUSTRAZIONE / ILLUSTRATION	NOSTRO RIFERIMENTO OUR REFERENCE	RIFERIMENTO COSTRUTTORE O.E. REFERENCE								
<p>TH min. 15,90 mm.</p> <p>5 fori - 5 Holes</p> <p>Ø 73 mm.</p> <p>66,5 mm.</p> <p>18 mm.</p> <p>Ø 280 mm.</p> 	960380	1300500080								
DESCRIZIONE / DESCRIPTION										
<p>Disco freno assale anteriore Brake disc front axle</p> 										
ILLUSTRAZIONE / ILLUSTRATION	NOSTRO RIFERIMENTO OUR REFERENCE	RIFERIMENTO COSTRUTTORE O.E. REFERENCE								
<p>Connettore quadro - Square connector</p> 	960929	77362212 9948626								
DESCRIZIONE / DESCRIPTION										
<p>Serie pastiglie freno anteriore - Set of brake pads front</p> <table border="1"> <thead> <tr> <th>WVA</th> <th>Larghezza Width - mm.</th> <th>Altezza Height -mm.</th> <th>Spessore Thickness - mm.</th> </tr> </thead> <tbody> <tr> <td>21797 21798</td> <td>145</td> <td>61</td> <td>19,7</td> </tr> </tbody> </table> 			WVA	Larghezza Width - mm.	Altezza Height -mm.	Spessore Thickness - mm.	21797 21798	145	61	19,7
WVA	Larghezza Width - mm.	Altezza Height -mm.	Spessore Thickness - mm.							
21797 21798	145	61	19,7							
ILLUSTRAZIONE / ILLUSTRATION	NOSTRO RIFERIMENTO OUR REFERENCE	RIFERIMENTO COSTRUTTORE O.E. REFERENCE								
<p>Connettore tondo - Round connector</p> 	960935	9945810 9948629								
DESCRIZIONE / DESCRIPTION										
<p>Serie pastiglie freno anteriore - Set of brake pads front</p> <table border="1"> <thead> <tr> <th>WVA</th> <th>Larghezza Width - mm.</th> <th>Altezza Height -mm.</th> <th>Spessore Thickness -mm.</th> </tr> </thead> <tbody> <tr> <td>21799 21800</td> <td>160</td> <td>64</td> <td>19,70</td> </tr> </tbody> </table> 			WVA	Larghezza Width - mm.	Altezza Height -mm.	Spessore Thickness -mm.	21799 21800	160	64	19,70
WVA	Larghezza Width - mm.	Altezza Height -mm.	Spessore Thickness -mm.							
21799 21800	160	64	19,70							

TIPO DI VEICOLO / VEHICLE TYPE

DUCATO (Impianto Lucas - Lucas system)
(10-14 q.li dal 03/94 - 04/02 Autobus - Furgonato e pianale piatto)







1.9D - 1.9TD - 2.0 - 2.5D - 2.5TDI - 2.8TDI

ILLUSTRAZIONE / ILLUSTRATION	NOSTRO RIFERIMENTO OUR REFERENCE	RIFERIMENTO COSTRUTTORE O.E. REFERENCE								
<p>TH min. 21,90 mm.</p> <p>5 fori - 5 Holes</p> <p>Ø 73 mm.</p> <p>65 mm.</p> <p>24 mm.</p> <p>Ø 280 mm.</p>	960201	1300501080								
DESCRIZIONE / DESCRIPTION										
<p>Disco freno assale anteriore Brake disc front axle</p> <p>Fascia AUTOVENTILANTE SELF-VENTILATED Band</p>										
ILLUSTRAZIONE / ILLUSTRATION	NOSTRO RIFERIMENTO OUR REFERENCE	RIFERIMENTO COSTRUTTORE O.E. REFERENCE								
<p>Connettore quadro - Square connector</p>	960929	77362212 9948626								
DESCRIZIONE / DESCRIPTION										
<p>Serie pastiglie freno anteriore - Set of brake pads front</p> <table border="1"> <thead> <tr> <th>WVA</th> <th>Larghezza Width - mm.</th> <th>Altezza Height -mm.</th> <th>Spessore Thickness - mm.</th> </tr> </thead> <tbody> <tr> <td>21797 21798</td> <td>145</td> <td>61</td> <td>19,70</td> </tr> </tbody> </table>			WVA	Larghezza Width - mm.	Altezza Height -mm.	Spessore Thickness - mm.	21797 21798	145	61	19,70
WVA	Larghezza Width - mm.	Altezza Height -mm.	Spessore Thickness - mm.							
21797 21798	145	61	19,70							
ILLUSTRAZIONE / ILLUSTRATION	NOSTRO RIFERIMENTO OUR REFERENCE	RIFERIMENTO COSTRUTTORE O.E. REFERENCE								
<p>Connettore tondo - Round connector</p>	960935	9945810 9948629								
DESCRIZIONE / DESCRIPTION										
<p>Serie pastiglie freno anteriore - Set of brake pads front</p> <table border="1"> <thead> <tr> <th>WVA</th> <th>Larghezza Width - mm.</th> <th>Altezza Height -mm.</th> <th>Spessore Thickness -mm.</th> </tr> </thead> <tbody> <tr> <td>21799 21800</td> <td>160</td> <td>64</td> <td>19,70</td> </tr> </tbody> </table>			WVA	Larghezza Width - mm.	Altezza Height -mm.	Spessore Thickness -mm.	21799 21800	160	64	19,70
WVA	Larghezza Width - mm.	Altezza Height -mm.	Spessore Thickness -mm.							
21799 21800	160	64	19,70							

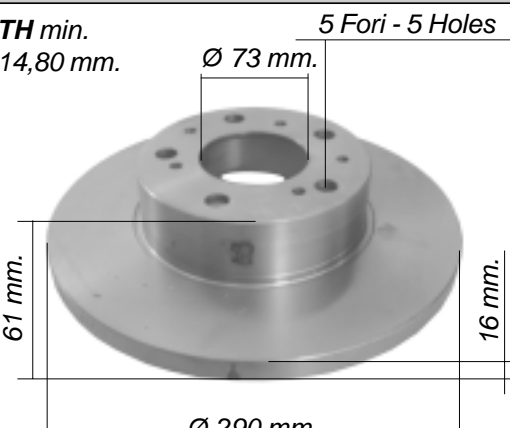
TIPO DI VEICOLO / VEHICLE TYPE

DUCATO (Impianto Lucas - Lucas system)
(18 q.li Autobus - Furgonato e pianale piatto)

1.8 (07/82-12/88) - 1.9D (02/87-08/90) - 1.9D (07/90-03/94) - 1.9TD (03/89-08/90)
1.9TD (07/90-03/94) - 2.0 (07/82-05/85) - 2.0 (07/90-03/94) - 2.4D (07/82-12/85)
2.4D (07/90-03/94) - 2.5D (01/86-08/90) - 2.5D (07/90-03/94) - 2.5D 4x4 (01/87-08/90)
2.5 TD 4x4 (07/90-03/94) - 2.5TD (01/87-08/90) - 2.5TD 4x4 (01/86-08/90)

ILLUSTRAZIONE / ILLUSTRATION	NOSTRO RIFERIMENTO OUR REFERENCE	RIFERIMENTO COSTRUTTORE O.E. REFERENCE								
<p>TH min. 14,80 mm.</p> <p>5 Fori - 5 Holes</p> <p>Ø 73 mm.</p> <p>61 mm.</p> <p>16 mm.</p> <p>Ø 290 mm.</p> 	960381	7538682 - 93500521								
DESCRIZIONE / DESCRIPTION										
<p>Disco freno assale anteriore Brake disc front axle</p> 										
ILLUSTRAZIONE / ILLUSTRATION	NOSTRO RIFERIMENTO OUR REFERENCE	RIFERIMENTO COSTRUTTORE O.E. REFERENCE								
<p>Connettore quadro - Square connector</p>  <p>E3 90R</p>	960929	77362212 9948626								
DESCRIZIONE / DESCRIPTION										
<p>Serie pastiglie freno anteriore - Set of brake pads front</p> <table border="1"> <thead> <tr> <th>WVA</th> <th>Larghezza Width - mm.</th> <th>Altezza Height -mm.</th> <th>Spessore Thickness - mm.</th> </tr> </thead> <tbody> <tr> <td>21797 21798</td> <td>145</td> <td>61</td> <td>19,70</td> </tr> </tbody> </table> 			WVA	Larghezza Width - mm.	Altezza Height -mm.	Spessore Thickness - mm.	21797 21798	145	61	19,70
WVA	Larghezza Width - mm.	Altezza Height -mm.	Spessore Thickness - mm.							
21797 21798	145	61	19,70							
ILLUSTRAZIONE / ILLUSTRATION	NOSTRO RIFERIMENTO OUR REFERENCE	RIFERIMENTO COSTRUTTORE O.E. REFERENCE								
<p>Connettore tondo - Round connector</p>  <p>E3 90R</p>	960935	9945810 9948629								
DESCRIZIONE / DESCRIPTION										
<p>Serie pastiglie freno anteriore - Set of brake pads front</p> <table border="1"> <thead> <tr> <th>WVA</th> <th>Larghezza Width - mm.</th> <th>Altezza Height -mm.</th> <th>Spessore Thickness -mm.</th> </tr> </thead> <tbody> <tr> <td>21799 21800</td> <td>160</td> <td>64</td> <td>19,70</td> </tr> </tbody> </table> 			WVA	Larghezza Width - mm.	Altezza Height -mm.	Spessore Thickness -mm.	21799 21800	160	64	19,70
WVA	Larghezza Width - mm.	Altezza Height -mm.	Spessore Thickness -mm.							
21799 21800	160	64	19,70							

TIPO DI VEICOLO / VEHICLE TYPE

DUCATO

(18 q.li - Autobus - Furgonato e pianale piatto)

2.0 (03/94-04/02) - 2.5D Combinato (08/94-04/02)

2.5TDi Combinato (08/94-04/02) - 2.5TDi (03/94-04/02)

2.8D (02/98-04/02) - 2.8Jtd (11/00-04/02) - 2.8 Jtd 4x4 (11/00-04/02)

2.8TDi (11/97-04/02) - 2.8TDi 4x4 (07/99-04/02)

ILLUSTRAZIONE / ILLUSTRATION

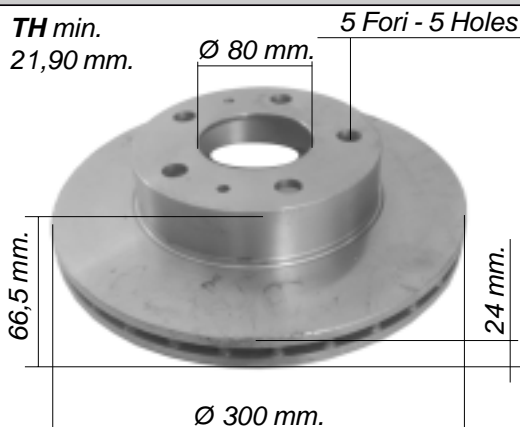

NOSTRO RIFERIMENTO OUR REFERENCE

960202

RIFERIMENTO COSTRUTTORE O.E. REFERENCE

1307356080

DESCRIZIONE / DESCRIPTION

Disco freno assale anteriore
Brake disc front axle

Fascia AUTOVENTILANTE
SELF-VENTILATED Band



ILLUSTRAZIONE / ILLUSTRATION

Connettore quadro - Square connector



NOSTRO RIFERIMENTO OUR REFERENCE

960929

RIFERIMENTO COSTRUTTORE O.E. REFERENCE

77362212
9948626

DESCRIZIONE / DESCRIPTION

Serie pastiglie freno anteriore - Set of brake pads front

WVA	Larghezza Width - mm.	Altezza Height -mm.	Spessore Tickness - mm.
21797 21798	145	61	19,70



ILLUSTRAZIONE / ILLUSTRATION

Connettore tondo - Round connector



NOSTRO RIFERIMENTO OUR REFERENCE

960935

RIFERIMENTO COSTRUTTORE O.E. REFERENCE

9945810
9948629

DESCRIZIONE / DESCRIPTION

Serie pastiglie freno anteriore - Set of brake pads front

WVA	Larghezza Width - mm.	Altezza Height -mm.	Spessore Tickness -mm.
21799 21800	160	64	19,70



TIPO DI VEICOLO / VEHICLE TYPE

DUCATO 2006 - 17 qli - H
(Autobus - Furgonato e pianale piatto)
Multijet
2.2D - 2.3D - 3.0D

ILLUSTRAZIONE / ILLUSTRATION

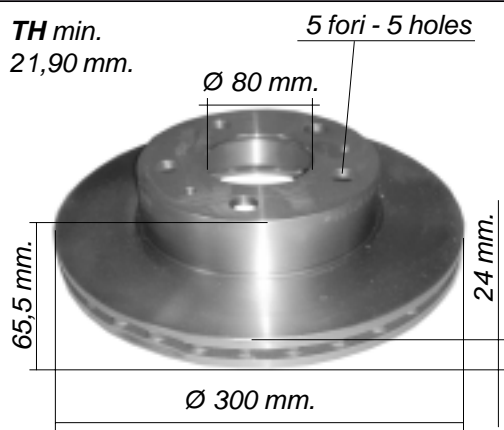
NOSTRO RIFERIMENTO
OUR REFERENCE**960180**RIFERIMENTO COSTRUTTORE
O.E. REFERENCE

51728378

DESCRIZIONE / DESCRIPTION

Disco freno assale anteriore
Brake disc front axle

Fascia AUTOVENTILANTE
SELF-VENTILATED Band



ILLUSTRAZIONE / ILLUSTRATION

Connettore quadro - Square connector

NOSTRO RIFERIMENTO
OUR REFERENCE**960181**RIFERIMENTO COSTRUTTORE
O.E. REFERENCE

77364014

DESCRIZIONE / DESCRIPTION

Serie pastiglie freno anteriore - Set of brake pads front

WVA	Larghezza Width - mm.	Altezza Height - mm.	Spessore Thickness - mm.
24468	169	61,6	19



ILLUSTRAZIONE / ILLUSTRATION

Connettore quadro - Square connector

NOSTRO RIFERIMENTO
OUR REFERENCE**960182**RIFERIMENTO COSTRUTTORE
O.E. REFERENCE

77364318

DESCRIZIONE / DESCRIPTION

Serie pastiglie freno anteriore - Set of brake pads front

WVA	Larghezza Width - mm.	Altezza Height - mm.	Spessore Thickness - mm.
24466	169	69,3	19



TIPO DI VEICOLO / VEHICLE TYPE

DUCATO 2006 - 17 qli - H
(Autobus - Furgonato e pianale piatto)
Multijet
2.2D - 2.3D - 3.0D

ILLUSTRAZIONE / ILLUSTRATION

Connettore - Connector



NOSTRO RIFERIMENTO OUR REFERENCE

960428

RIFERIMENTO COSTRUTTORE O.E. REFERENCE

77362216 - 9949517

DESCRIZIONE / DESCRIPTION

Serie pastiglie freno anteriore **DUCATO (U.T.)**
Set of brake pads front **DUCATO (L.M.)**

WVA	Larghezza Width - mm.	Altezza Height -mm.	Spessore Thickness -mm.
23858	164,80	69,30	19



ILLUSTRAZIONE / ILLUSTRATION

NOSTRO RIFERIMENTO OUR REFERENCE

RIFERIMENTO COSTRUTTORE O.E. REFERENCE

DESCRIZIONE / DESCRIPTION

WVA	Larghezza Width - mm.	Altezza Height -mm.	Spessore Thickness - mm.

ILLUSTRAZIONE / ILLUSTRATION

NOSTRO RIFERIMENTO OUR REFERENCE

RIFERIMENTO COSTRUTTORE O.E. REFERENCE

DESCRIZIONE / DESCRIPTION

TIPO DI VEICOLO / VEHICLE TYPE

DUCATO 2006 - 17 q.li L
(Autobus - Furgonato e pianale piatto)
Multijet
2.2D - 2.3D - 3.0D

ILLUSTRAZIONE / ILLUSTRATION

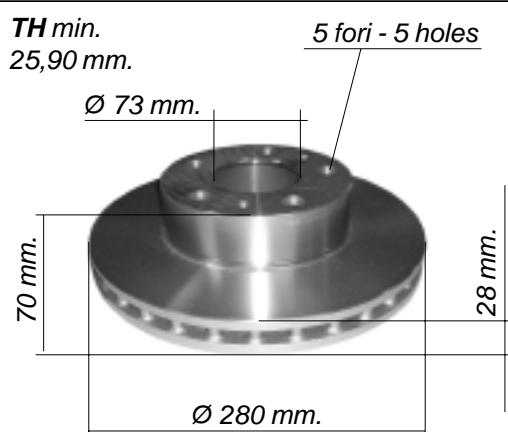
NOSTRO RIFERIMENTO
OUR REFERENCE**960183**RIFERIMENTO COSTRUTTORE
O.E. REFERENCE

51705749

DESCRIZIONE / DESCRIPTION

Disco freno assale anteriore
Brake disc front axle

Fascia AUTOVENTILANTE
SELF-VENTILATED Band



ILLUSTRAZIONE / ILLUSTRATION

Connettore quadro - Square connector

NOSTRO RIFERIMENTO
OUR REFERENCE**960184**RIFERIMENTO COSTRUTTORE
O.E. REFERENCE

77364160

DESCRIZIONE / DESCRIPTION

Serie pastiglie freno anteriore - Set of brake pads front

WVA	Larghezza Width - mm.	Altezza Height -mm.	Spessore Thickness - mm.
24469	169	61,60	19



ILLUSTRAZIONE / ILLUSTRATION

Connettore - connector

NOSTRO RIFERIMENTO
OUR REFERENCE**960428**RIFERIMENTO COSTRUTTORE
O.E. REFERENCE

77362216 - 9949517

DESCRIZIONE / DESCRIPTION

Serie pastiglie freno anteriore **DUCATO (U.T.)**
Set of brake pads front **DUCATO (L.M.)**

WVA	Larghezza Width - mm.	Altezza Height -mm.	Spessore Thickness -mm.
23858	164,80	69,30	19



TIPO DI VEICOLO / VEHICLE TYPE

DUCATO 2006 - 20 q.li
(Autobus - Furgonato e pianale piatto)
Multijet
2.2D - 2.3D - 3.0D

ILLUSTRAZIONE / ILLUSTRATION

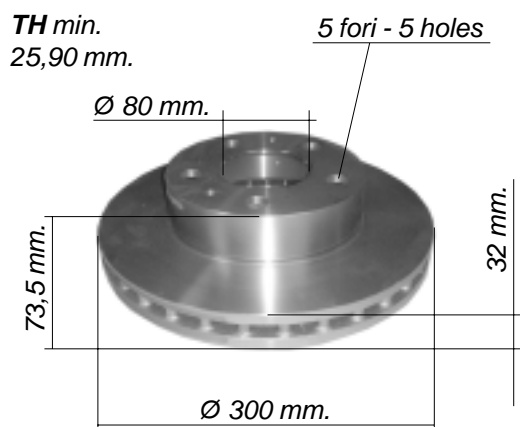

NOSTRO RIFERIMENTO OUR REFERENCE

960185

RIFERIMENTO COSTRUTTORE O.E. REFERENCE

51705758

DESCRIZIONE / DESCRIPTION

Disco freno assale anteriore
Brake disc front axle

Fascia AUTOVENTILANTE
SELF-VENTILATED Band



ILLUSTRAZIONE / ILLUSTRATION

Connettore quadro - Square connector



NOSTRO RIFERIMENTO OUR REFERENCE

960186

RIFERIMENTO COSTRUTTORE O.E. REFERENCE

77364319

DESCRIZIONE / DESCRIPTION

Serie pastiglie freno anteriore - Set of brake pads front

WVA	Larghezza Width - mm.	Altezza Height - mm.	Spessore Thickness - mm.
24467	169	69	19



ILLUSTRAZIONE / ILLUSTRATION

Connettore - connector



NOSTRO RIFERIMENTO OUR REFERENCE

960428

RIFERIMENTO COSTRUTTORE O.E. REFERENCE

77362216 - 9949517

DESCRIZIONE / DESCRIPTION

Serie pastiglie freno anteriore **DUCATO (U.T.)**
Set of brake pads front **DUCATO (L.M.)**

WVA	Larghezza Width - mm.	Altezza Height - mm.	Spessore Thickness - mm.
23858	164,80	69,30	19



TIPO DI VEICOLO / VEHICLE TYPE

DUCATO 2008 JTD - 11 q.li

ILLUSTRAZIONE / ILLUSTRATION

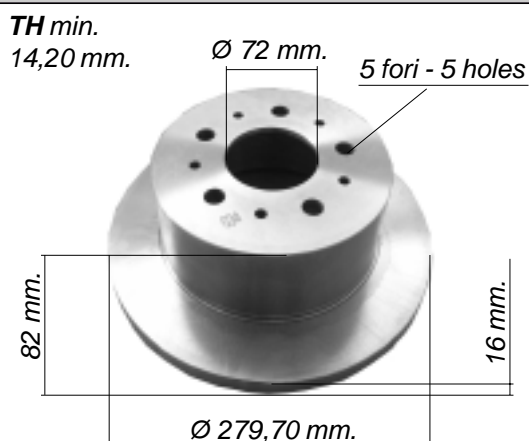
NOSTRO RIFERIMENTO
OUR REFERENCE

960188

RIFERIMENTO COSTRUTTORE
O.E. REFERENCE

71740118

DESCRIZIONE / DESCRIPTION

Disco freno assale posteriore
Brake disc rear axleFascia AUTOVENTILANTE
SELF-VENTILATED Band

ILLUSTRAZIONE / ILLUSTRATION

NOSTRO RIFERIMENTO
OUR REFERENCE

960190

RIFERIMENTO COSTRUTTORE
O.E. REFERENCE

77362274

DESCRIZIONE / DESCRIPTION

Serie pastiglie freno posteriore - Set of brake pads rear

WVA	Larghezza Width - mm.	Altezza Height -mm.	Spessore Thickness - mm.
23919 23920	165	69,3	19,10



ILLUSTRAZIONE / ILLUSTRATION

NOSTRO RIFERIMENTO
OUR REFERENCERIFERIMENTO COSTRUTTORE
O.E. REFERENCE

DESCRIZIONE / DESCRIPTION

TIPO DI VEICOLO / VEHICLE TYPE

DUCATO 2008 JTD - 18 q.li

ILLUSTRAZIONE / ILLUSTRATION

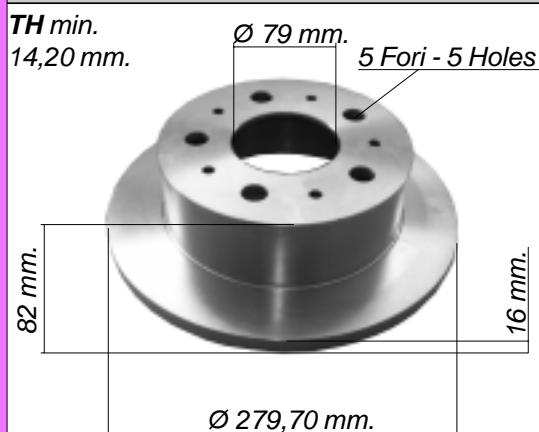

NOSTRO RIFERIMENTO OUR REFERENCE

960189

RIFERIMENTO COSTRUTTORE O.E. REFERENCE

71740117

DESCRIZIONE / DESCRIPTION

Disco freno assale posteriore
Brake disc rear axle

Fascia AUTOVENTILANTE
SELF-VENTILATED Band



ILLUSTRAZIONE / ILLUSTRATION



NOSTRO RIFERIMENTO OUR REFERENCE

960190

RIFERIMENTO COSTRUTTORE O.E. REFERENCE

77362274

DESCRIZIONE / DESCRIPTION

Serie pastiglie freno posteriore - Set of brake pads rear

WVA	Larghezza Width - mm.	Altezza Height -mm.	Spessore Thickness - mm.
23919 23920	165	69,3	19,10







ILLUSTRAZIONE / ILLUSTRATION

NOSTRO RIFERIMENTO OUR REFERENCE

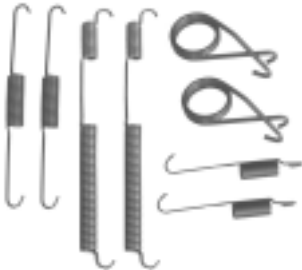

RIFERIMENTO COSTRUTTORE O.E. REFERENCE

DESCRIZIONE / DESCRIPTION

	Ns Riferim. Our Ref.	Rif. Costr. O.E. Ref.	Descrizione/Tipo di veicolo Description/Vehicle Type
<p><i>Impianto / System</i> GIRLING</p> 	961012	9945885	<p><i>Serie ganasce freno posteriori</i> <i>Rear brake shoes set</i></p> <p>Ducato 1900 - 2500 TD 10-14 q.li dal 1994 al 2001 Citroen Jumper 27-31 dal 1994 Peugeot Boxer 10-14 q.li dal 1994</p>
<p><i>Impianto / System</i> GIRLING</p> 	961000	9945884	<p><i>Serie ganasce freno posteriori</i> <i>Rear brake shoes set</i></p> <p>Ducato 2800 TD 18 q.li dal 1994 al 2001 Citroen Jumper 35 dal 1994 Peugeot Boxer 18 q.li dal 1994</p>
<p><i>Impianto / System</i> BENDIX</p> 	961057	9566949580	<p><i>Serie ganasce freno posteriori</i> <i>Rear brake shoes set</i></p> <p>Ducato - Scudo T.T. dal 1995 Ulisse T.T.</p>
<p><i>Impianto / System</i> BENDIX</p> 	961050	77363479	<p><i>Serie ganasce freno posteriori</i> <i>Rear brake shoes set</i></p> <p>Ducato 2006 U.T.</p>
	961044	-	<p><i>Kit molle per serie ganasce freno posteriori</i> <i>Springs set for rear brake shoes set</i></p> <p>Ducato - 1900 - 2500 TD - 2800TD</p>

	Ns Riferim. Our Ref.	Rif. Costr. O.E. Ref.	Descrizione/Tipo di veicolo Description/Vehicle Type
	964019	9946799 4601-E5	<p><i>Pompa freno Ø 23.80 mm. Brake pump</i></p> <p>Ducato 1900 - 2500 TD 10 - 14 q.li dal/from 1994 al/to 2001 Citroen Jumper 27-31 dal/from 1994 Peugeot Boxer 10-14 q.li dal/from 1994</p>
	964022	9945895 4402-A5	<p><i>Cilindretto freno posteriore Ø 28.60 mm. Rear brake cylinder</i></p> <p>Ducato 2800 TD 18 q.li dal/from 1994 al/to 2001 Citroen Jumper 35 dal/from 1994 Peugeot Boxer 18 q.li dal/from 1994</p>
<p>AD ESAURIMENTO UNTILL OUT OF STOCK</p>	964023	9946056 4601-D1	<p><i>Pompa freno Ø 25.40 mm. Brake pump</i></p> <p>Ducato 2800 TD 18 q.li dal/from 1994 al/to 2001 Citroen Jumper 35 dal/from 1994 Peugeot Boxer 18 q.li dal/from 1994</p>

 <p>Lato Dx-Sx - Rh-Lh Side</p>	Ns.Rif. <i>Our Ref.</i> 954009	Rif.Costr. <i>O.E. Ref.</i> 9750079980	Tipo di veicolo <i>Vehicle Type</i> FIAT DUCATO - TALENTO (fino al 1994 - till 1994)
 <p>Lato Dx-Sx - Rh-Lh Side</p>	Ns.Rif. <i>Our Ref.</i> 954010	Rif.Costr. <i>O.E. Ref.</i> 1306716080	Tipo di veicolo <i>Vehicle Type</i> FIAT DUCATO - TALENTO (dal 1994 - from 1994)
	Ns.Rif. <i>Our Ref.</i>	Rif.Costr. <i>O.E. Ref.</i>	Tipo di veicolo <i>Vehicle Type</i>
	Ns.Rif. <i>Our Ref.</i>	Rif.Costr. <i>O.E. Ref.</i>	Tipo di veicolo <i>Vehicle Type</i>
	Ns.Rif. <i>Our Ref.</i>	Rif.Costr. <i>O.E. Ref.</i>	Tipo di veicolo <i>Vehicle Type</i>

	Ns Riferim. Our Ref.	Rif. Costr. O.E. Ref.	Descrizione/Tipo di veicolo Description/Vehicle Type
 <p>(AD ESAURIMENTO)</p>	<p>990500</p>	<p>1117025 IMOS</p>	<p><i>Devioguida Con Airbag</i> <i>Steering column switch With Airbag</i></p> <p>Fiat Ducato '99</p>
 <p>(AD ESAURIMENTO)</p>	<p>990501</p>	<p>1118066 IMOS</p>	<p><i>Devioguida</i> <i>Steering column switch</i></p> <p>Fiat Ducato U.T.</p>

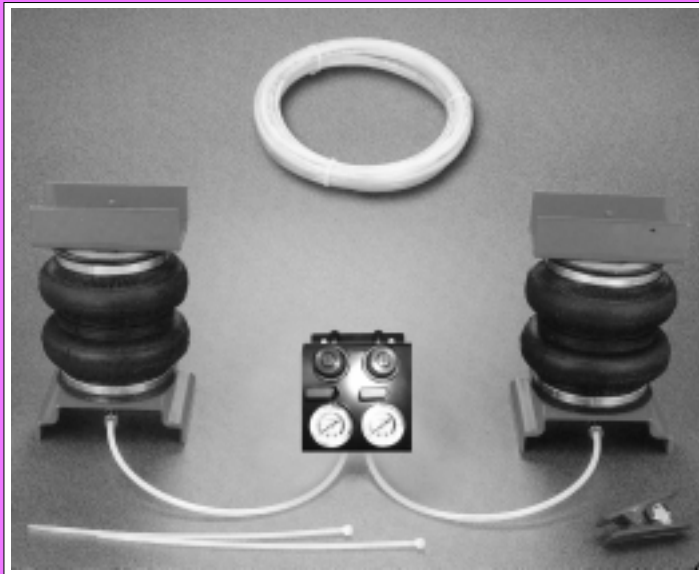

Ns.Rif. <i>Ns.Ref.</i>	Rif. O.E. <i>O.E. Ref.</i>	Taratura <i>Calibration</i>
103400	-	2,5 Bar
103400.1	-	4 Bar

Applicazione tipo veicolo
Vehicle type

NUOVO DUCATO (dal 1994)
DUCATO NEW (to 1994)
PEUGEOT BOXER
CITROEN JUMPER

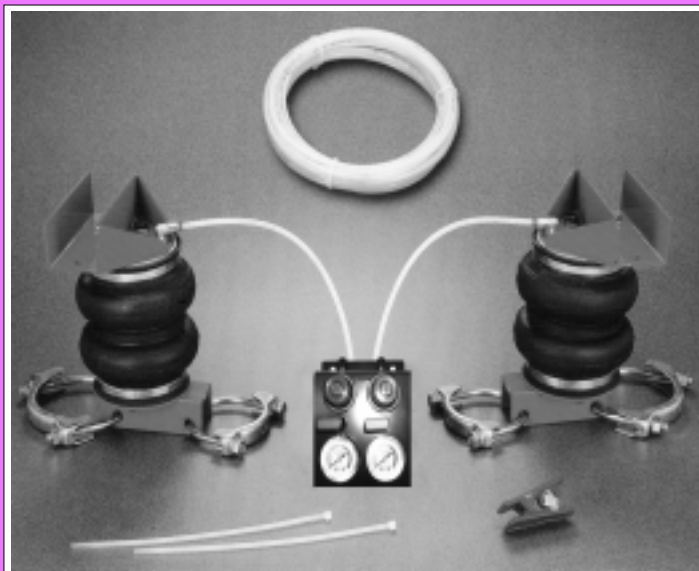

Ns.Rif. <i>Ns.Ref.</i>	Rif. O.E. <i>O.E. Ref.</i>	Taratura <i>Calibration</i>
103401	-	2,5 Bar
103401.1	-	4 Bar

Applicazione tipo veicolo
Vehicle type

DUCATO (1°serie dal 1994)
DUCATO (1°type to 1994)
PEUGEOT J5
CITROEN C25

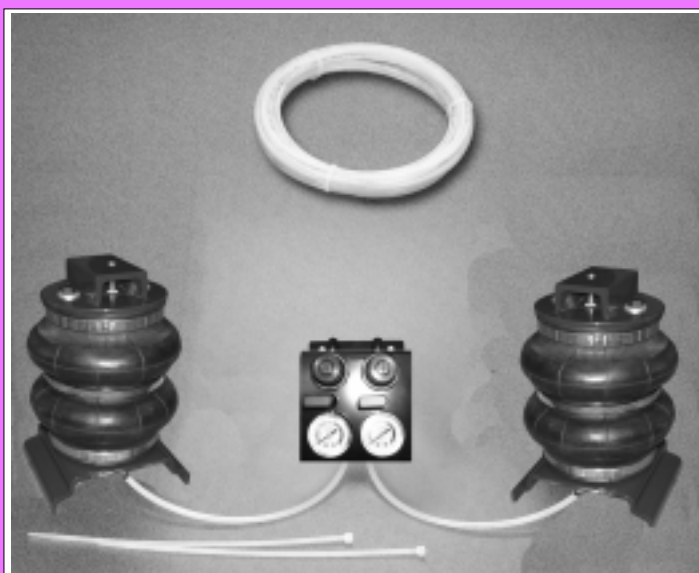

Ns.Rif. <i>Ns.Ref.</i>	Rif. O.E. <i>O.E. Ref.</i>	Taratura <i>Calibration</i>
103421	-	2,5 Bar
103421.1	-	4 Bar

Applicazione tipo veicolo
Vehicle type

DUCATO 2007

503410 Fiat Ducato 2800 JTD



(AD ESAURIMENTO)

TIPO DI VEICOLO / VEHICLE TYPE

TRANSIT (Impianto Bendix - Bendix system)
(Cerchi da 14" - Wheels 14" Autobus - Furgonato e pianale piatto)

2.0 - 2.5D - 2.5TD - 2.5TDI (09/91-03/00)

ILLUSTRAZIONE / ILLUSTRATION	NOSTRO RIFERIMENTO OUR REFERENCE	RIFERIMENTO COSTRUTTORE O.E. REFERENCE								
	960382	5025610 5029815								
DESCRIZIONE / DESCRIPTION										
<p>Disco freno assale anteriore Brake disc front axle</p> 										
ILLUSTRAZIONE / ILLUSTRATION	NOSTRO RIFERIMENTO OUR REFERENCE	RIFERIMENTO COSTRUTTORE O.E. REFERENCE								
	960868	6965579 7018202								
DESCRIZIONE / DESCRIPTION										
<p>Serie pastiglie freno anteriore - Set of brake pads front</p> <table border="1" data-bbox="643 1451 1233 1619"> <thead> <tr> <th>WVA</th> <th>Larghezza Width - mm.</th> <th>Altezza Height - mm.</th> <th>Spessore Thickness - mm.</th> </tr> </thead> <tbody> <tr> <td>21470</td> <td>139</td> <td>65</td> <td>19</td> </tr> </tbody> </table> 			WVA	Larghezza Width - mm.	Altezza Height - mm.	Spessore Thickness - mm.	21470	139	65	19
WVA	Larghezza Width - mm.	Altezza Height - mm.	Spessore Thickness - mm.							
21470	139	65	19							
ILLUSTRAZIONE / ILLUSTRATION	NOSTRO RIFERIMENTO OUR REFERENCE	RIFERIMENTO COSTRUTTORE O.E. REFERENCE								
	960869	6197739 6965580 - 7018203								
DESCRIZIONE / DESCRIPTION										
<p>Serie pastiglie freno anteriore - Set of brake pads front</p> <table border="1" data-bbox="643 1955 1217 2123"> <thead> <tr> <th>WVA</th> <th>Larghezza Width - mm.</th> <th>Altezza Height - mm.</th> <th>Spessore Thickness - mm.</th> </tr> </thead> <tbody> <tr> <td>21469</td> <td>139</td> <td>72</td> <td>19</td> </tr> </tbody> </table> 			WVA	Larghezza Width - mm.	Altezza Height - mm.	Spessore Thickness - mm.	21469	139	72	19
WVA	Larghezza Width - mm.	Altezza Height - mm.	Spessore Thickness - mm.							
21469	139	72	19							

TIPO DI VEICOLO / VEHICLE TYPE

TRANSIT (Impianto Bendix - Bendix system)
(Cerchi da 15" - Autobus - Furgonato e pianale piatto)
(Wheels 15" - Autobus - Van and Flat platform)

2.0 - 2.5D - 2.5TD - 2.5TDI (09/91-03/00)

ILLUSTRAZIONE / ILLUSTRATION

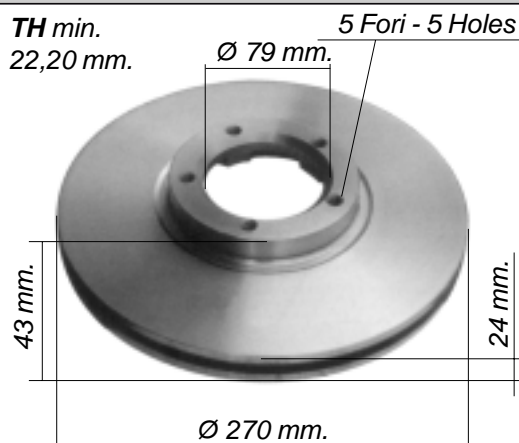

NOSTRO RIFERIMENTO OUR REFERENCE

960383

RIFERIMENTO COSTRUTTORE O.E. REFERENCE

5025611
5029816

DESCRIZIONE / DESCRIPTION

Disco freno assale anteriore
Brake disc front axle



ILLUSTRAZIONE / ILLUSTRATION



NOSTRO RIFERIMENTO OUR REFERENCE

960868

RIFERIMENTO COSTRUTTORE O.E. REFERENCE

6965579
7018202

DESCRIZIONE / DESCRIPTION

Serie pastiglie freno anteriore - Set of brake pads front

WVA	Larghezza Width - mm.	Altezza Height - mm.	Spessore Thickness - mm.
21470	139	65	19



ILLUSTRAZIONE / ILLUSTRATION



NOSTRO RIFERIMENTO OUR REFERENCE

960869

RIFERIMENTO COSTRUTTORE O.E. REFERENCE

6197739
6965580 - 7018203

DESCRIZIONE / DESCRIPTION

Serie pastiglie freno anteriore - Set of brake pads front

WVA	Larghezza Width - mm.	Altezza Height - mm.	Spessore Thickness - mm.
21469	139	72	19



TIPO DI VEICOLO / VEHICLE TYPE

TRANSIT (Impianto Bendix - Bendix system)

Autobus	(da 08/00 from 08/00)
Furgonato	2.0DI - 2.0TDCI - 2.3 16v - 2.4DI (da 08/00 from 08/00)
Pianale piatto	2.0 - 2.3 - 2.4 (da 08/00 from 08/00)

ILLUSTRAZIONE / ILLUSTRATION	NOSTRO RIFERIMENTO OUR REFERENCE	RIFERIMENTO COSTRUTTORE O.E. REFERENCE																				
	960384	4041427 4395257																				
DESCRIZIONE / DESCRIPTION																						
Disco freno assale anteriore Brake disc front axle 																						
ILLUSTRAZIONE / ILLUSTRATION	NOSTRO RIFERIMENTO OUR REFERENCE	RIFERIMENTO COSTRUTTORE O.E. REFERENCE																				
	960870	1135167 - 1144288 4095132 - 4114749																				
DESCRIZIONE / DESCRIPTION																						
Serie pastiglie freno anteriore - Set of brake pads front <table border="1" data-bbox="638 1444 1236 1624"> <thead> <tr> <th>WVA</th> <th>Larghezza Width - mm.</th> <th>Altezza Height - mm.</th> <th>Spessore Thickness - mm.</th> </tr> </thead> <tbody> <tr> <td>23840</td> <td>168,9</td> <td>65</td> <td>18,4</td> </tr> <tr> <td>23841</td> <td></td> <td></td> <td></td> </tr> <tr> <td>23434</td> <td></td> <td></td> <td></td> </tr> <tr> <td>23435</td> <td></td> <td></td> <td></td> </tr> </tbody> </table> 			WVA	Larghezza Width - mm.	Altezza Height - mm.	Spessore Thickness - mm.	23840	168,9	65	18,4	23841				23434				23435			
WVA	Larghezza Width - mm.	Altezza Height - mm.	Spessore Thickness - mm.																			
23840	168,9	65	18,4																			
23841																						
23434																						
23435																						
ILLUSTRAZIONE / ILLUSTRATION	NOSTRO RIFERIMENTO OUR REFERENCE	RIFERIMENTO COSTRUTTORE O.E. REFERENCE																				
DESCRIZIONE / DESCRIPTION																						

TIPO DI VEICOLO / VEHICLE TYPE

TRANSIT (Impianto Bendix - Bendix system)

Autobus	(da 01/00 from 01/00)
Furgonato	2.3 16v - 2.4DI (da 01/00 from 01/00)
Pianale piatto	2.3 - 2.4 (da 01/00 from 01/00)

ILLUSTRAZIONE / ILLUSTRATION

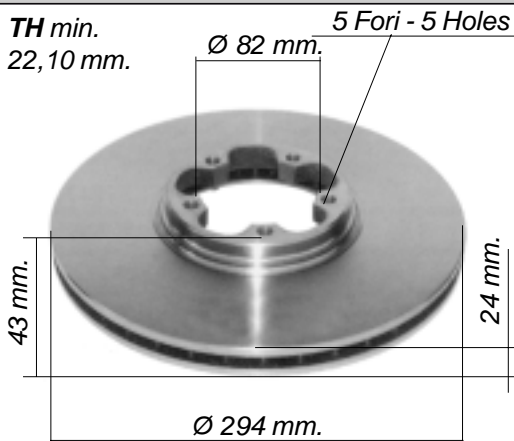

NOSTRO RIFERIMENTO OUR REFERENCE

960385

RIFERIMENTO COSTRUTTORE O.E. REFERENCE

4041428

DESCRIZIONE / DESCRIPTION

Disco freno assale anteriore
Brake disc front axle



ILLUSTRAZIONE / ILLUSTRATION



NOSTRO RIFERIMENTO OUR REFERENCE

960871

RIFERIMENTO COSTRUTTORE O.E. REFERENCE

4077636

DESCRIZIONE / DESCRIPTION

Serie pastiglie freno anteriore - Set of brake pads front

WVA	Larghezza Width - mm.	Altezza Height - mm.	Spessore Thickness - mm.
23577	168,9	65	18,4
23578			
23579			
23580			



ILLUSTRAZIONE / ILLUSTRATION

NOSTRO RIFERIMENTO OUR REFERENCE

RIFERIMENTO COSTRUTTORE O.E. REFERENCE

DESCRIZIONE / DESCRIPTION

TIPO DI VEICOLO / VEHICLE TYPE

TOURNEO Connect 1.8 16v - 1.8 Turbo DI (da 09/02 from 09/02)**TRANSIT Connect** 1.8 16v - 1.8 Turbo DI (da 09/02 from 09/02)

ILLUSTRAZIONE / ILLUSTRATION

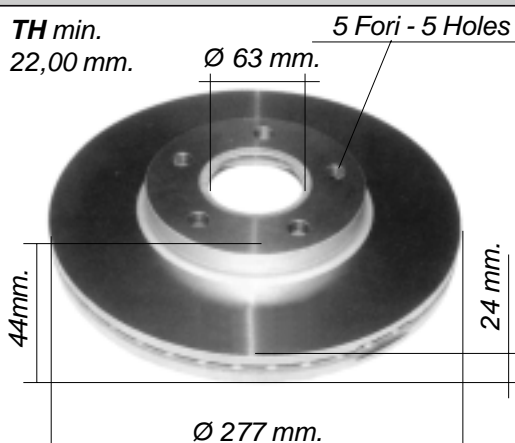
NOSTRO RIFERIMENTO
OUR REFERENCE**960386**RIFERIMENTO COSTRUTTORE
O.E. REFERENCE

4455980

4457985

DESCRIZIONE / DESCRIPTION

Disco freno assale anteriore e posteriore
Brake disc front and rear axle



ILLUSTRAZIONE / ILLUSTRATION

NOSTRO RIFERIMENTO
OUR REFERENCERIFERIMENTO COSTRUTTORE
O.E. REFERENCE





DESCRIZIONE / DESCRIPTION

WVA	Larghezza Width - mm.	Altezza Height - mm.	Spessore Thickness - mm.

ILLUSTRAZIONE / ILLUSTRATION

NOSTRO RIFERIMENTO
OUR REFERENCERIFERIMENTO COSTRUTTORE
O.E. REFERENCE

DESCRIZIONE / DESCRIPTION

	Ns Riferim. Our Ref.	Rif. Costr. O.E. Ref.	Descrizione/Tipo di veicolo Description/Vehicle Type
<p><i>Impianto / System BENDIX</i></p>  <p>AD ESAURIMENTO</p>	961058	6579150	<p>Serie ganasce freno posteriori 254 x 52 mm. Rear brake shoes set 254 x 52 mm.</p> <p>Transit 80D Transit 120D dal 1991</p>
<p><i>Impianto / System BENDIX</i></p>  <p>AD ESAURIMENTO</p>	961059	6733350	<p>Serie ganasce freno posteriori 280 x 65 mm. Rear brake shoes set 280 x 65 mm.</p> <p>Ford Transit 130D - 150D - 190D dal 1991</p>
<p><i>Impianto / System BENDIX</i></p>  <p>AD ESAURIMENTO</p>	961060	7125122	<p>Serie ganasce freno posteriori 254 x 52 mm. Rear brake shoes set 254 x 52 mm.</p> <p>Ford Transit 80 - 100L - 120 dal 1994</p>
<p><i>Impianto / System BENDIX</i></p>  <p>AD ESAURIMENTO</p>	961061	92VB2200BA	<p>Serie ganasce freno posteriori 280 x 65 mm. Rear brake shoes set 280 x 65 mm.</p> <p>Ford Transit 190L dal 1994</p>
<p><i>Impianto / System BENDIX</i></p>  <p>AD ESAURIMENTO</p>	961062	-	<p>Serie ganasce freno posteriori Rear brake shoes set</p> <p>Ford Transit dal 1999</p>

	Ns Riferim. Our Ref.	Rif. Costr. O.E. Ref.	Descrizione/Tipo di veicolo Description/Vehicle Type
 <p>AD ESAURIMENTO UNTILL OUT OF STOCK</p>	964026	6464705	<p><i>Cilindretto freno posteriore Ø 20.64 mm. Rear brake cylinder</i></p> <p>Transit 130 - 150 L/S dal/from 1991</p>

Illustrazione <i>Illustration</i>	Ns.Rif. <i>Our Ref.</i>	Rif.Costr. <i>O.E. Ref.</i>	Descrizione <i>Description</i>	Tipo di veicolo <i>Vehicle Type</i>
<p style="text-align: center;">Ø 24 mm</p> <p style="text-align: center;">Ø 350 mm</p>	907262	715F8600	Ventilatore aria nylon (7 pale) (elettroventola) Nylon blower (7 blade) <p style="text-align: center;">AD ESAURIMENTO UNTILL OUT OF STOCK</p>	TRANSIT Motore - Engine 2400 Diesel
<p style="text-align: center;">Ø 111 mm</p> <p style="text-align: center;">Ø 385 mm</p>	907264	84VB8600	Ventilatore aria nylon (7 pale) (elettroventola) Nylon blower (7blade) <p style="text-align: center;">AD ESAURIMENTO UNTILL OUT OF STOCK</p>	TRANSIT Motore - Engine 2500 Diesel



Ns.Rif. <i>Ns.Ref.</i>	Rif. O.E. <i>O.E. Ref.</i>	Taratura <i>Calibration</i>
103414	-	2,5 Bar
103414.1	-	4 Bar

Applicazione tipo veicolo
Vehicle type

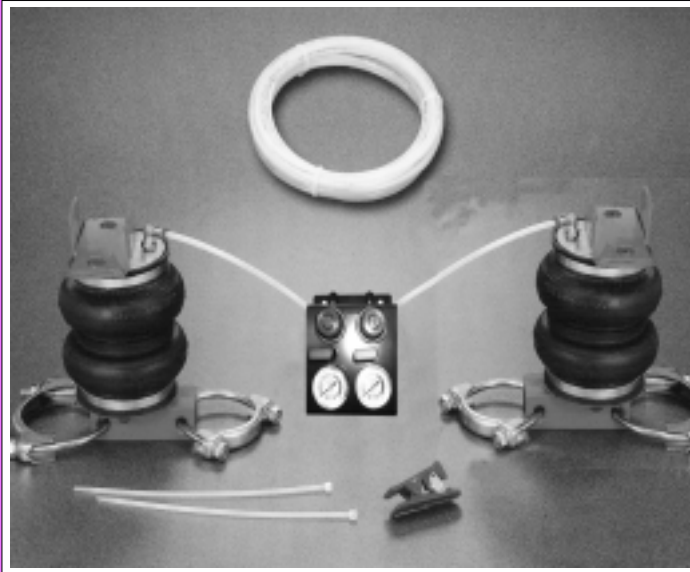
FORD TRANSIT
300-330-350SL (dal 2000)
Ponte tondo - Round axle
Ruota gemellata
Twin wheels

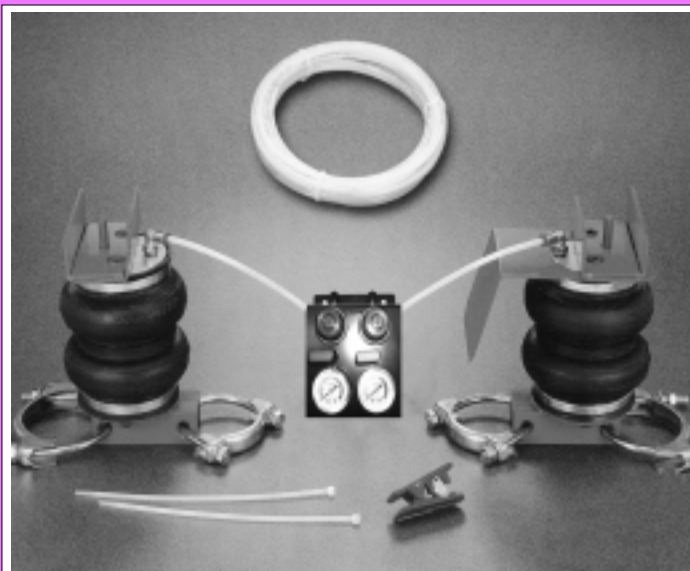

Ns.Rif. <i>Ns.Ref.</i>	Rif. O.E. <i>O.E. Ref.</i>	Taratura <i>Calibration</i>
103406	-	2,5 Bar
103406.1	-	4 Bar

Applicazione tipo veicolo
Vehicle type

FORD TRANSIT
80-100L-120-130-150-190
Ponte tondo
Round axle

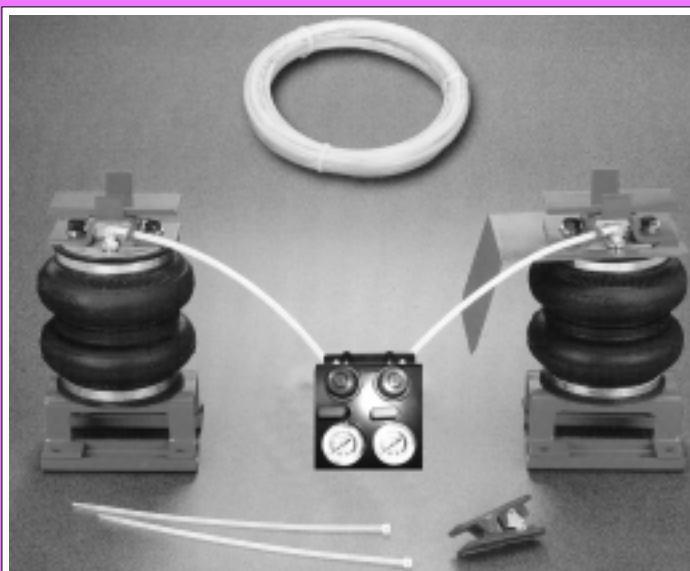

Ns.Rif. <i>Ns.Ref.</i>	Rif. O.E. <i>O.E. Ref.</i>	Taratura <i>Calibration</i>
103407	-	2,5 Bar
103407.1	-	4 Bar

Applicazione tipo veicolo
Vehicle type

FORD TRANSIT
80-100L-120-130-150-190
Ponte quadro
Square axle

(AD ESAURIMENTO)

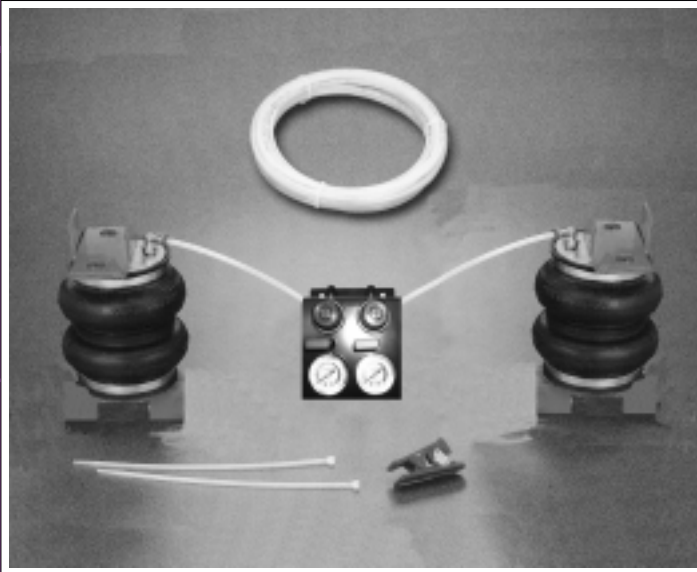

Ns.Rif. <i>Ns.Ref.</i>	Rif. O.E. <i>O.E. Ref.</i>	Taratura <i>Calibration</i>
103420	-	2,5 Bar
103420.1	-	4 Bar
Applicazione tipo veicolo <i>Vehicle type</i>		
FORD TRANSIT 2001 Ruota singola Single wheel Ponte quadro Square axle Trazione anteriore Front drive		

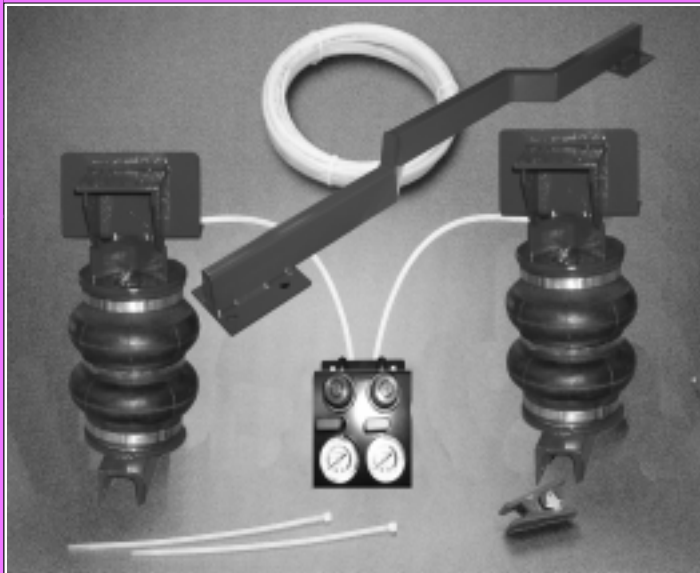

Ns.Rif. <i>Ns.Ref.</i>	Rif. O.E. <i>O.E. Ref.</i>	Taratura <i>Calibration</i>
103422	-	2,5 Bar
103422.1	-	4 Bar
Applicazione tipo veicolo <i>Vehicle type</i>		
FORD TRANSIT 2007 Ruota gemellata Twin wheels		

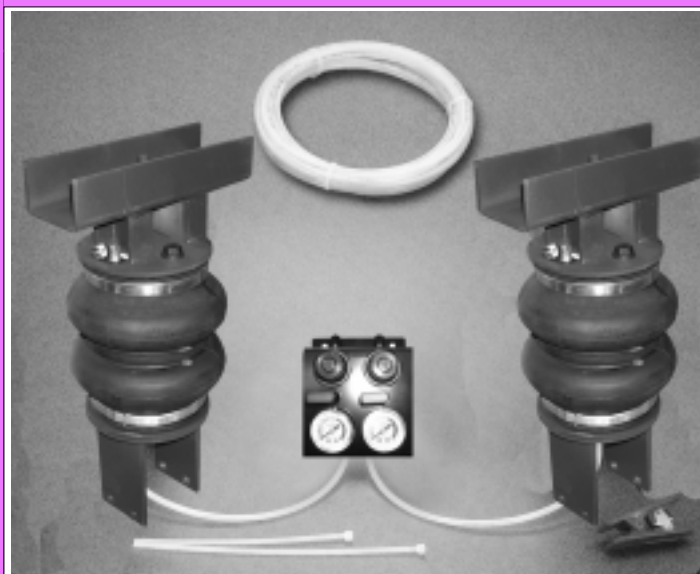

Ns.Rif. <i>Ns.Ref.</i>	Rif. O.E. <i>O.E. Ref.</i>	Taratura <i>Calibration</i>
103423	-	2,5 Bar
103423.1	-	4 Bar
Applicazione tipo veicolo <i>Vehicle type</i>		
FORD TRANSIT 2008 Ponte quadro Square axle		

503420 Ford Transit 300-330-350SL TD 2500 (>2000)**(AD ESAURIMENTO)**

TIPO DI VEICOLO / VEHICLE TYPE

GASOLONE

TS27 - TS28 (1°SERIE)

TSH35 - TSHT35 (U.T.)

ILLUSTRAZIONE / ILLUSTRATION

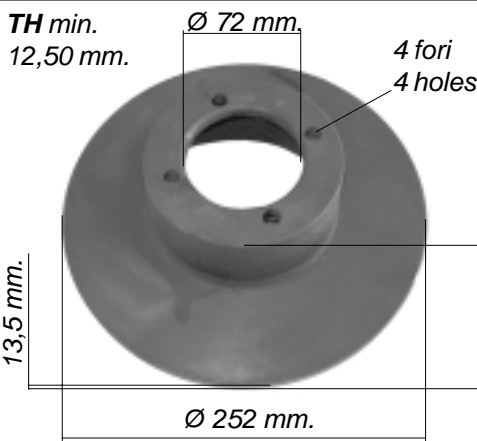
NOSTRO RIFERIMENTO
OUR REFERENCE**960243**RIFERIMENTO COSTRUTTORE
O.E. REFERENCE

60500015000

DESCRIZIONE / DESCRIPTION

Disco freno assale anteriore
Brake disc front axle

ILLUSTRAZIONE / ILLUSTRATION

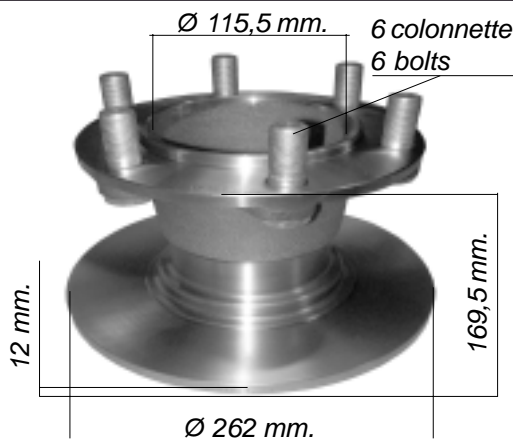
NOSTRO RIFERIMENTO
OUR REFERENCE**960256**RIFERIMENTO COSTRUTTORE
O.E. REFERENCE

80500001043

DESCRIZIONE / DESCRIPTION

Disco freno assale anteriore (U.T.)
Brake disc front axle (L.M.)

ILLUSTRAZIONE / ILLUSTRATION

**E3** 90RNOSTRO RIFERIMENTO
OUR REFERENCE**960244**RIFERIMENTO COSTRUTTORE
O.E. REFERENCE



R1410920100

DESCRIZIONE / DESCRIPTION

Serie pastiglie freno anteriorie - Set of brake pads front

WVA	Larghezza Width - mm.	Altezza Height - mm.	Spessore Thickness - mm.
-	110	73	18,30



	Ns Riferim. Our Ref.	Rif. Costr. O.E. Ref.	Descrizione/Tipo di veicolo Description/Vehicle Type
	<p>960025</p>	<p>80600001029</p>	<p><i>Tamburo freno posteriore</i> <i>Rear brake drum</i></p> <p>GASOLONE TS H35 TS H35 U.T. (euro4)</p> 

Copyright della EMMERRE S.r.l. - Settimo Torinese - Tutti i diritti sono riservati e depositati a norma di legge ed a norma delle convenzioni internazionali. - E' vietata la duplicazione o la riproduzione anche parziale senza la previa autorizzazione della EMMERRE S.r.l.

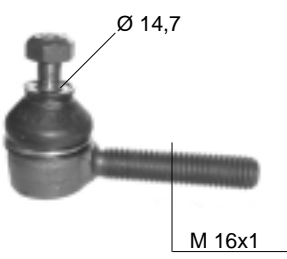
 <p>Ø 14,7</p> <p>M 16x1</p>	Ns.Rif. <i>Our Ref.</i>	Rif.Costr. <i>O.E. Ref.</i>	Tipo di veicolo <i>Vehicle Type</i>
	914254	60700015000	Gasolone

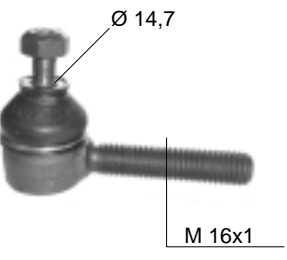
 <p>Ø 14,7</p> <p>M 16x1</p>	Ns.Rif. <i>Our Ref.</i>	Rif.Costr. <i>O.E. Ref.</i>	Tipo di veicolo <i>Vehicle Type</i>
	914255	60700014000	Gasolone

TIPO DI VEICOLO / VEHICLE TYPE

ISUZU NKR 3.0D - NPR
(35 TON. RUOTA SINGOLA - 1998)

ILLUSTRAZIONE / ILLUSTRATION

TH min.
37,00 mm.

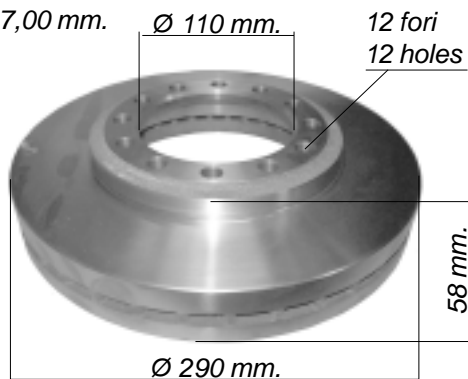

**NOSTRO RIFERIMENTO
OUR REFERENCE**

960519

**RIFERIMENTO COSTRUTTORE
O.E. REFERENCE**

8971686311
8973718760

DESCRIZIONE / DESCRIPTION

Disco freno assale anteriore
Brake disc front axle



ILLUSTRAZIONE / ILLUSTRATION



E3 90R

**NOSTRO RIFERIMENTO
OUR REFERENCE**

960410

**RIFERIMENTO COSTRUTTORE
O.E. REFERENCE**

8973292660

DESCRIZIONE / DESCRIPTION

Serie pastiglie freno anteriore
Set of brake pads front

WVA	Larghezza Width - mm.	Altezza Height - mm.	Spessore Thickness - mm.
-	206.10	74.80	20



ILLUSTRAZIONE / ILLUSTRATION

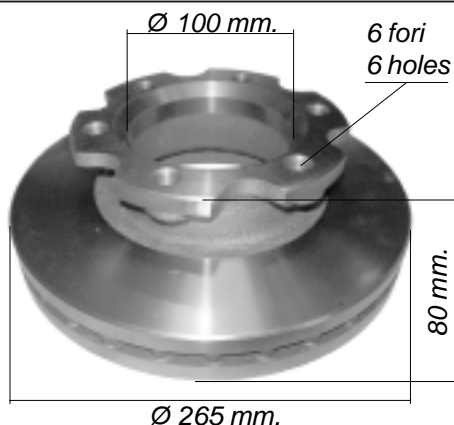

**NOSTRO RIFERIMENTO
OUR REFERENCE**

960518

**RIFERIMENTO COSTRUTTORE
O.E. REFERENCE**

897031007

DESCRIZIONE / DESCRIPTION

Disco freno assale posteriore
Brake disc rear axle



TIPO DI VEICOLO / VEHICLE TYPE

ISUZU NPR 4.8 D
ISUZU NQR (60/70 Q.LI)

ILLUSTRAZIONE / ILLUSTRATION

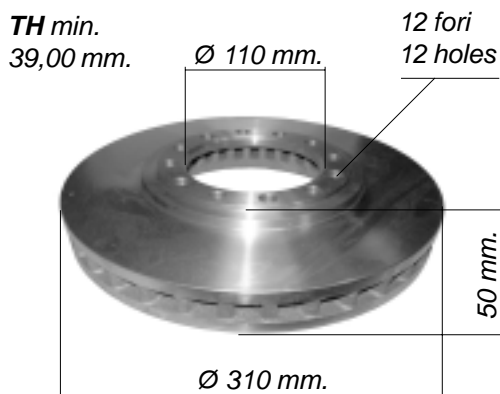
NOSTRO RIFERIMENTO
OUR REFERENCE**960520**RIFERIMENTO COSTRUTTORE
O.E. REFERENCE8973872280
8971686321

DESCRIZIONE / DESCRIPTION

Disco freno assale anteriore
Brake disc front axle
Isuzu NPR 4.8D - NQR (60-70q.)

ILLUSTRAZIONE / ILLUSTRATION

NOSTRO RIFERIMENTO
OUR REFERENCE**960411**RIFERIMENTO COSTRUTTORE
O.E. REFERENCE

8971686340

DESCRIZIONE / DESCRIPTION

Serie pastiglie freno anteriore
Set of brake pads front

WVA	Larghezza Width - mm.	Altezza Height - mm.	Spessore Thickness - mm.
-	206.10	80.10	20



ILLUSTRAZIONE / ILLUSTRATION

NOSTRO RIFERIMENTO
OUR REFERENCE**960412**RIFERIMENTO COSTRUTTORE
O.E. REFERENCE

8970947100

DESCRIZIONE / DESCRIPTION

WVA	Larghezza Width - mm.	Altezza Height - mm.	Spessore Thickness - mm.
-	183.20 238.20	69.80 93.40	21.70



TIPO DI VEICOLO / VEHICLE TYPE

ISUZU NQR 4.7 D
(7.5 TON - 1998)

ILLUSTRAZIONE / ILLUSTRATION

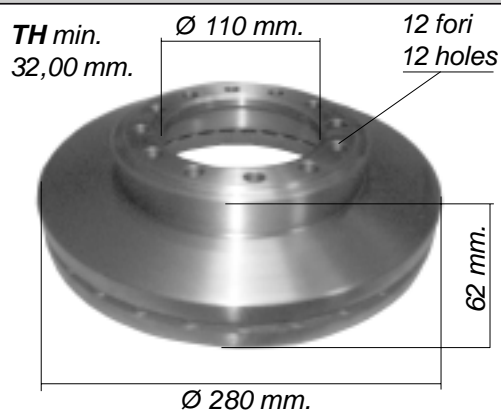

NOSTRO RIFERIMENTO OUR REFERENCE

960521

RIFERIMENTO COSTRUTTORE O.E. REFERENCE

8970158571

DESCRIZIONE / DESCRIPTION

Disco freno assale anteriore
Brake disc front axle
Isuzu NQR 4.7 D
(7.5 ton 1998)



ILLUSTRAZIONE / ILLUSTRATION



NOSTRO RIFERIMENTO OUR REFERENCE

960411

RIFERIMENTO COSTRUTTORE O.E. REFERENCE

8971686340

DESCRIZIONE / DESCRIPTION

Serie pastiglie freno anteriore
Set of brake pads front

WVA	Larghezza Width - mm.	Altezza Height - mm.	Spessore Thickness - mm.
-	206.10	80.10	20



ILLUSTRAZIONE / ILLUSTRATION

NOSTRO RIFERIMENTO OUR REFERENCE

RIFERIMENTO COSTRUTTORE O.E. REFERENCE

DESCRIZIONE / DESCRIPTION

TIPO DI VEICOLO / VEHICLE TYPE

DAILY RESTYLING 30.8
NEW DAILY 30.8
TURBODAILY 30.10
 (impianto BREMBO - BREMBO system)

ILLUSTRAZIONE / ILLUSTRATION

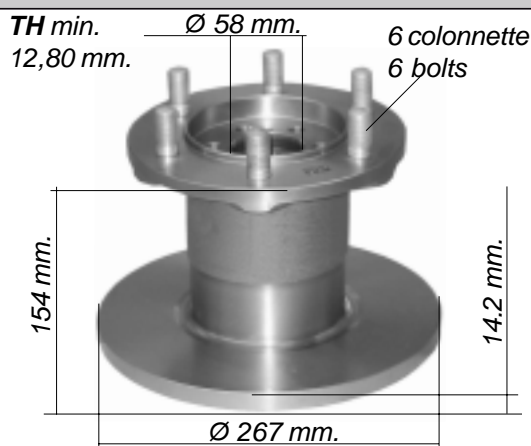
NOSTRO RIFERIMENTO
OUR REFERENCE**960021**RIFERIMENTO COSTRUTTORE
O.E. REFERENCE1904528
8582290

DESCRIZIONE / DESCRIPTION

Serie dischi freno assale anteriore
 Set of brake discs front axle



ILLUSTRAZIONE / ILLUSTRATION

Connettore tondo - Round connector



E3 90R

NOSTRO RIFERIMENTO
OUR REFERENCE**960913**RIFERIMENTO COSTRUTTORE
O.E. REFERENCE

1906158

DESCRIZIONE / DESCRIPTION

Serie pastiglie freno anteriore - Set of brake pads front

WVA	Larghezza Width - mm.	Altezza Height - mm.	Spessore Thickness - mm.
29038 29037	110	73	18,3



ILLUSTRAZIONE / ILLUSTRATION

NOSTRO RIFERIMENTO
OUR REFERENCERIFERIMENTO COSTRUTTORE
O.E. REFERENCE

DESCRIZIONE / DESCRIPTION

TIPO DI VEICOLO / VEHICLE TYPE

DAILY RESTYLING 35.8 - 35.10
NEW DAILY 35.8 - 40.8 - 35.10
TURBODAILY 35.10 - 35.12

ILLUSTRAZIONE / ILLUSTRATION

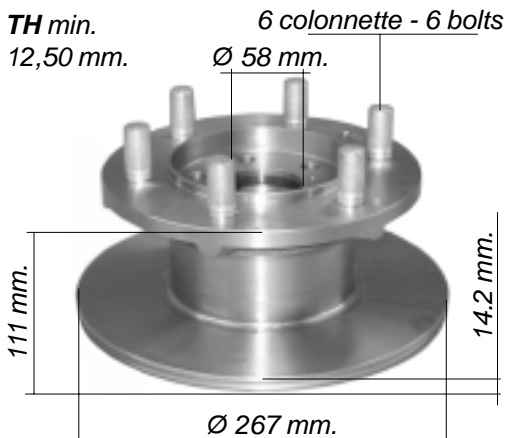

NOSTRO RIFERIMENTO OUR REFERENCE

960022

RIFERIMENTO COSTRUTTORE O.E. REFERENCE

1904529
93800492

DESCRIZIONE / DESCRIPTION

Serie dischi freno assale anteriore
Set of brake discs front axle



ILLUSTRAZIONE / ILLUSTRATION

Connettore tondo - Round connector

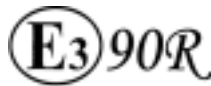

NOSTRO RIFERIMENTO OUR REFERENCE

960894

RIFERIMENTO COSTRUTTORE O.E. REFERENCE

1906159

DESCRIZIONE / DESCRIPTION

Serie pastiglie freno anteriore - Set of brake pads front
(impianto BREMBO 16" - BREMBO 16" system)

WVA	Larghezza Width - mm.	Altezza Height - mm.	Spessore Thickness - mm.
21048 29041	110	73	18,30



ILLUSTRAZIONE / ILLUSTRATION

Connettore tondo - Round connector

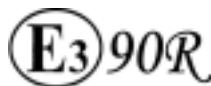

NOSTRO RIFERIMENTO OUR REFERENCE

960898

RIFERIMENTO COSTRUTTORE O.E. REFERENCE

1906157

DESCRIZIONE / DESCRIPTION

Serie pastiglie freno anteriore - Set of brake pads front
(impianto LOCKEED - LOCKEED system)

WVA	Larghezza Width - mm.	Altezza Height - mm.	Spessore Thickness - mm.
21160 20359	105	75	18



TIPO DI VEICOLO / VEHICLE TYPE

DAILY RESTYLING 35.8 - 35.10

NEW DAILY 35.8 - 40.8 - 35.10

TURBODAILY 35.10 - 35.12

ILLUSTRAZIONE / ILLUSTRATION

Connettore Tondo + Ovale
Round + Oval connector

E3 90R

NOSTRO RIFERIMENTO
OUR REFERENCE

960893

RIFERIMENTO COSTRUTTORE
O.E. REFERENCE

1906206

DESCRIZIONE / DESCRIPTION

Serie pastiglie freno anteriore - Set of brake pads front
(impianto BREMBO 16" - BREMBO 16" system)

WVA	Larghezza Width - mm.	Altezza Height - mm.	Spessore Thickness - mm.
21188 21048	110	73	18.3



ILLUSTRAZIONE / ILLUSTRATION

Connettore Tondo + Ovale
Round + Oval connector

E3 90R

NOSTRO RIFERIMENTO
OUR REFERENCE

960892

RIFERIMENTO COSTRUTTORE
O.E. REFERENCE

1906207

DESCRIZIONE / DESCRIPTION

Serie pastiglie freno anteriore - Set of brake pads front
(impianto LOCKEED - LOCKEED system)

WVA	Larghezza Width - mm.	Altezza Height - mm.	Spessore Thickness - mm.
20359 20653	105	75	18



ILLUSTRAZIONE / ILLUSTRATION

NOSTRO RIFERIMENTO
OUR REFERENCERIFERIMENTO COSTRUTTORE
O.E. REFERENCE

DESCRIZIONE / DESCRIPTION

TIPO DI VEICOLO / VEHICLE TYPE

DAILY RESTYLING 49.10
NEW DAILY 35.10 - 45.10 - 49.10
TURBODAILY 35.12 - 49.12

ILLUSTRAZIONE / ILLUSTRATION

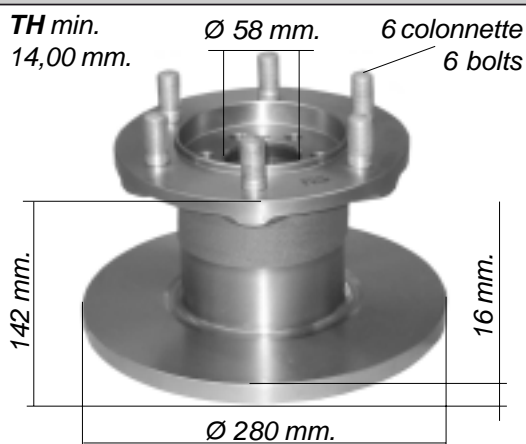

NOSTRO RIFERIMENTO OUR REFERENCE

960023

RIFERIMENTO COSTRUTTORE O.E. REFERENCE

1904531 - 8584182

DESCRIZIONE / DESCRIPTION

Serie dischi freno assale anteriore
Set of brake discs front axle



ILLUSTRAZIONE / ILLUSTRATION

Connettore tondo - Round connector



NOSTRO RIFERIMENTO OUR REFERENCE

960900

RIFERIMENTO COSTRUTTORE O.E. REFERENCE

1906040

DESCRIZIONE / DESCRIPTION

Serie pastiglie freno anteriore - Set of brake pads front
(impianto PERROT - PERROT system)

WVA	Larghezza Width - mm.	Altezza Height - mm.	Spessore Thickness - mm.
20465	149	69	18
29012			



ILLUSTRAZIONE / ILLUSTRATION

Connettore tondo - Round connector



NOSTRO RIFERIMENTO OUR REFERENCE

960941

RIFERIMENTO COSTRUTTORE O.E. REFERENCE

1906243

DESCRIZIONE / DESCRIPTION

Serie pastiglie freno anteriore - Set of brake pads front
(impianto PERROT - PERROT system)

WVA	Larghezza Width - mm.	Altezza Height - mm.	Spessore Thickness - mm.
20465	149	69	18
29040			



ILLUSTRAZIONE / ILLUSTRATION



Lunghezza/Length mm 190

NOSTRO RIFERIMENTO OUR REFERENCE

960876

RIFERIMENTO COSTRUTTORE O.E. REFERENCE

42530912 - 8198933

DESCRIZIONE / DESCRIPTION

Indicatore usura freno anteriore (pz 1)
Brake wear indicator front (1 pc)

TIPO DI VEICOLO / VEHICLE TYPE

TURBODAILY 59.12

ILLUSTRAZIONE / ILLUSTRATION	NOSTRO RIFERIMENTO OUR REFERENCE	RIFERIMENTO COSTRUTTORE O.E. REFERENCE												
<p>TH min. 23,00 mm.</p> <p>Ø 120 mm.</p> <p>6 colonnette 6 bolts</p>  <p>160 mm.</p> <p>25 mm.</p> <p>Ø 290 mm.</p>	960039	1904693												
DESCRIZIONE / DESCRIPTION														
<p>Serie dischi freno assale anteriore Set of brake discs front axle</p> <p>Fascia AUTOVENTILANTE SELF-VENTILATED Band</p> 														
ILLUSTRAZIONE / ILLUSTRATION	NOSTRO RIFERIMENTO OUR REFERENCE	RIFERIMENTO COSTRUTTORE O.E. REFERENCE												
<p>Connettore ovale- Oval connector</p>  <p>E3 90R</p>	960974	1906427												
DESCRIZIONE / DESCRIPTION														
<p>Serie pastiglie freno anteriore - Set of brake pads front (impianto PERROT - PERROT system)</p> <table border="1"> <thead> <tr> <th>WVA</th> <th>Larghezza Width - mm.</th> <th>Altezza Height - mm.</th> <th>Spessore Thickness - mm.</th> </tr> </thead> <tbody> <tr> <td>29001</td> <td>174</td> <td>69</td> <td>20</td> </tr> <tr> <td>29107</td> <td></td> <td></td> <td></td> </tr> </tbody> </table> 			WVA	Larghezza Width - mm.	Altezza Height - mm.	Spessore Thickness - mm.	29001	174	69	20	29107			
WVA	Larghezza Width - mm.	Altezza Height - mm.	Spessore Thickness - mm.											
29001	174	69	20											
29107														
ILLUSTRAZIONE / ILLUSTRATION	NOSTRO RIFERIMENTO OUR REFERENCE	RIFERIMENTO COSTRUTTORE O.E. REFERENCE												
<p>Connettore tondo- Round connector</p>  <p>E3 90R</p>	960940	1906183												
DESCRIZIONE / DESCRIPTION														
<p>Serie pastiglie freno anteriore - Set of brake pads front (impianto PERROT - PERROT system) - (fino al 1995)</p> <table border="1"> <thead> <tr> <th>WVA</th> <th>Larghezza Width - mm.</th> <th>Altezza Height - mm.</th> <th>Spessore Thickness - mm.</th> </tr> </thead> <tbody> <tr> <td>29001</td> <td>174,7</td> <td>69</td> <td>20</td> </tr> <tr> <td>29003</td> <td></td> <td></td> <td></td> </tr> </tbody> </table> 			WVA	Larghezza Width - mm.	Altezza Height - mm.	Spessore Thickness - mm.	29001	174,7	69	20	29003			
WVA	Larghezza Width - mm.	Altezza Height - mm.	Spessore Thickness - mm.											
29001	174,7	69	20											
29003														
ILLUSTRAZIONE / ILLUSTRATION	NOSTRO RIFERIMENTO OUR REFERENCE	RIFERIMENTO COSTRUTTORE O.E. REFERENCE												
 <p>Connettore tondo - Lungh. mm 190 Round connector - Length mm 190</p>	960876	42530912 - 8198933												
DESCRIZIONE / DESCRIPTION														
<p>Indicatore usura freno anteriore (pz 1) Brake wear indicator front (1 pc)</p>														

TIPO DI VEICOLO / VEHICLE TYPE

DAILY CITY 2000

35S9-35S11-35S13-35S15 (RUOTA SINGOLA)

ILLUSTRAZIONE / ILLUSTRATION

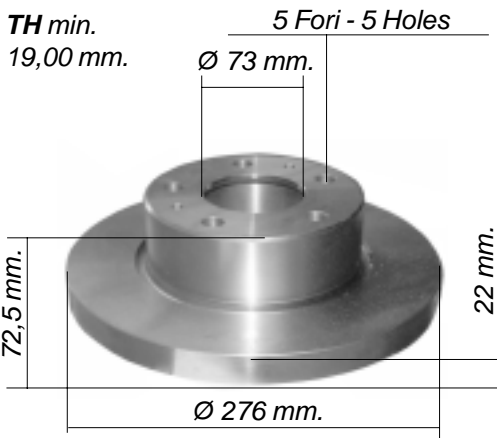

NOSTRO RIFERIMENTO OUR REFERENCE

960923

RIFERIMENTO COSTRUTTORE O.E. REFERENCE

42470836

DESCRIZIONE / DESCRIPTION

Serie dischi freno assale anteriore
Set of brake discs front axle



ILLUSTRAZIONE / ILLUSTRATION



NOSTRO RIFERIMENTO OUR REFERENCE

960910

RIFERIMENTO COSTRUTTORE O.E. REFERENCE

42470835

DESCRIZIONE / DESCRIPTION

Serie pastiglie freno anteriore - Set of brake pads front
(impianto BREMBO - BREMBO system)

WVA	Larghezza Width - mm.	Altezza Height - mm.	Spessore Thickness - mm.
29212 29121	164,8	66,5	18



ILLUSTRAZIONE / ILLUSTRATION

Connettore ovale - Lungh. mm. 295
Oval connector - Length mm. 295



NOSTRO RIFERIMENTO OUR REFERENCE

960879

RIFERIMENTO COSTRUTTORE O.E. REFERENCE

42548208 - 1908407 (1)

960864

42548195 - 2992393 (2)

DESCRIZIONE / DESCRIPTION

Kit segnalatori usura freno anteriore e posteriore (2 pz.)
Set of brake wear indicators front and rear (2 pcs)

Connettore ovale - Lungh. mm. 190
Oval connector - Length mm. 190

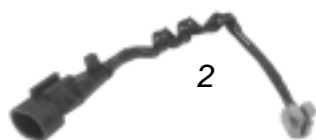





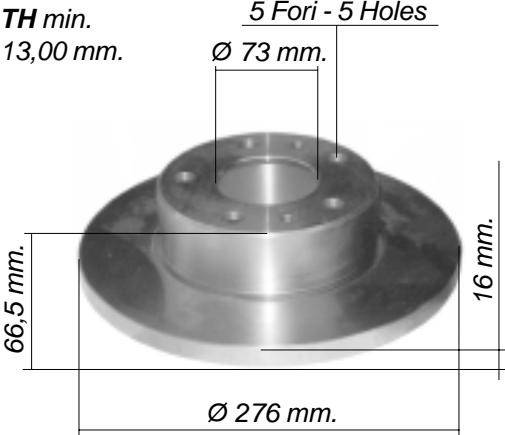

Kit segnalatori usura freno anteriore e posteriore (2 pz.)
Set of brake wear indicators front and rear (2 pcs)

TIPO DI VEICOLO / VEHICLE TYPE

DAILY CITY 2000

35S9-35S11-35S13-S15 (RUOTA SINGOLA)

ILLUSTRAZIONE / ILLUSTRATION	NOSTRO RIFERIMENTO OUR REFERENCE	RIFERIMENTO COSTRUTTORE O.E. REFERENCE								
<p>TH min. 13,00 mm.</p> <p>5 Fori - 5 Holes Ø 73 mm.</p>  <p>66,5 mm.</p> <p>Ø 276 mm.</p> <p>16 mm.</p>	960924	2991646								
DESCRIZIONE / DESCRIPTION										
Serie dischi freno assale posteriore Set of brake discs rear axle										
										
ILLUSTRAZIONE / ILLUSTRATION	NOSTRO RIFERIMENTO OUR REFERENCE	RIFERIMENTO COSTRUTTORE O.E. REFERENCE								
 <p>E3 90R</p>	960911	42470841								
DESCRIZIONE / DESCRIPTION										
Serie pastiglie freno posteriore - Set of brake pads rear (impianto BREMBO - BREMBO system)										
	<table border="1"> <thead> <tr> <th>WVA</th> <th>Larghezza Width - mm.</th> <th>Altezza Height - mm.</th> <th>Spessore Thickness - mm.</th> </tr> </thead> <tbody> <tr> <td>29123</td> <td>107</td> <td>61</td> <td>20</td> </tr> </tbody> </table>	WVA	Larghezza Width - mm.	Altezza Height - mm.	Spessore Thickness - mm.	29123	107	61	20	
WVA	Larghezza Width - mm.	Altezza Height - mm.	Spessore Thickness - mm.							
29123	107	61	20							
										
ILLUSTRAZIONE / ILLUSTRATION	NOSTRO RIFERIMENTO OUR REFERENCE	RIFERIMENTO COSTRUTTORE O.E. REFERENCE								
<p>Connettore ovale - Lungh. mm. 150 Oval connector - Length mm. 150</p>  <p>1</p>	960979	42548209 - 2991854 (1)								
<p>Connettore ovale - Lungh. mm. 150 Oval connector - Length mm. 150</p>  <p>2</p>	960863	42548196 - 2992394 (2)								
DESCRIZIONE / DESCRIPTION										
Kit segnalatori usura freno posteriore (2 pz.) Set of brake wear indicators rear (2 pcs)										
Kit segnalatori usura freno posteriore (2 pz.) Set of brake wear indicators rear (2 pcs)										

TIPO DI VEICOLO / VEHICLE TYPE

DAILY CITY 2000

35S9-35S11-35S13-S15 (RUOTA SINGOLA)

(PER VEICOLI CON ABS - VEHICLES WITH ABS)

ILLUSTRAZIONE / ILLUSTRATION

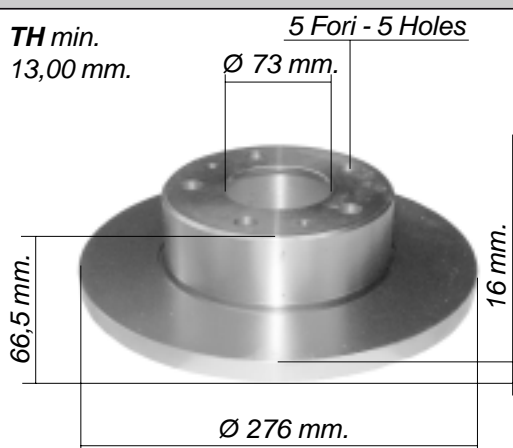

NOSTRO RIFERIMENTO OUR REFERENCE

960925

RIFERIMENTO COSTRUTTORE O.E. REFERENCE

2994066
42471034

DESCRIZIONE / DESCRIPTION

Serie dischi freno assale posteriore
Set of brake discs rear axle



ILLUSTRAZIONE / ILLUSTRATION



NOSTRO RIFERIMENTO OUR REFERENCE

960911

RIFERIMENTO COSTRUTTORE O.E. REFERENCE

42470841

DESCRIZIONE / DESCRIPTION

Serie pastiglie freno posteriore - Set of brake pads rear
(impianto BREMBO - BREMBO system)

WVA	Larghezza Width - mm.	Altezza Height - mm.	Spessore Thickness - mm.
29123	107	61	20



ILLUSTRAZIONE / ILLUSTRATION

Connettore ovale - Lungh. mm. 150
Oval connector - Length mm. 150



Connettore ovale - Lungh. mm. 150
Oval connector - Length mm. 150

NOSTRO RIFERIMENTO OUR REFERENCE

960979

960863

RIFERIMENTO COSTRUTTORE O.E. REFERENCE

42548209 - 2991854 (1)

42548196 - 2992394 (2)





DESCRIZIONE / DESCRIPTION

Kit segnalatori usura freno posteriore (2 pz.)
Set of brake wear indicators rear (2 pcs)

Kit segnalatori usura freno posteriore (2 pz.)
Set of brake wear indicators rear (2 pcs)

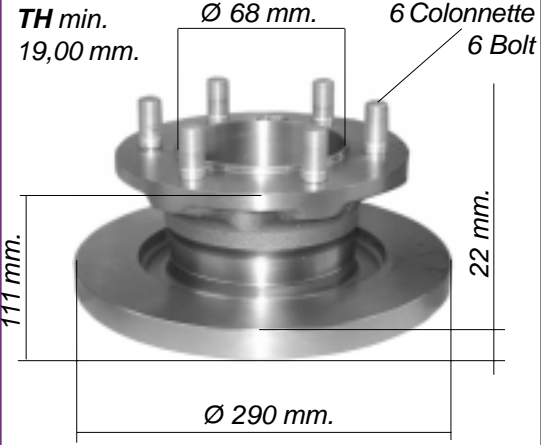
TIPO DI VEICOLO / VEHICLE TYPE

NEW DAILY (96) 35.8
TURBODAILY (96) 35.10-49.10-35.12-49.12
DAILY CITY 2000 35C9-35C11-35C13 - 50C11-50C13

ILLUSTRAZIONE / ILLUSTRATION	NOSTRO RIFERIMENTO OUR REFERENCE	RIFERIMENTO COSTRUTTORE O.E. REFERENCE								
	960050	42470842 - 1908772								
DESCRIZIONE / DESCRIPTION										
<p>Serie dischi freno assale anteriore Set of brake discs front axle</p> 										
	960051	42471111 - 1908773								
DESCRIZIONE / DESCRIPTION										
<p>Serie dischi freno assale posteriore Set of brake discs rear axle</p> 										
<p>(impianto BREMBO - BREMBO system)</p> 	960909	1906401								
DESCRIZIONE / DESCRIPTION										
<p>Serie pastiglie freno anteriore e posteriore Set of brake pads front and rear</p>										
<table border="1" data-bbox="638 2027 1228 2154"> <thead> <tr> <th>WVA</th> <th>Larghezza Width - mm.</th> <th>Altezza Height - mm.</th> <th>Spessore Thickness - mm.</th> </tr> </thead> <tbody> <tr> <td>29121</td> <td>164,8</td> <td>66,5</td> <td>20,3</td> </tr> </tbody> </table> 			WVA	Larghezza Width - mm.	Altezza Height - mm.	Spessore Thickness - mm.	29121	164,8	66,5	20,3
WVA	Larghezza Width - mm.	Altezza Height - mm.	Spessore Thickness - mm.							
29121	164,8	66,5	20,3							

TIPO DI VEICOLO / VEHICLE TYPE

NEW DAILY (96) 35.8
TURBODAILY (96) 35.10-49.10-35.12-49.12
DAILY CITY 2000 35C9-35C11-35C13 - 50C11-50C13

ILLUSTRAZIONE / ILLUSTRATION

(impianto BREMBO - BREMBO system)



E3 90R

NOSTRO RIFERIMENTO OUR REFERENCE

960992

RIFERIMENTO COSTRUTTORE O.E. REFERENCE

2992339

DESCRIZIONE / DESCRIPTION

Serie pastiglie freno anteriore e posteriore
Set of brake pads front and rear

WVA	Larghezza Width - mm.	Altezza Height - mm.	Spessore Thickness - mm.
29121	164,8	66,5	20



ILLUSTRAZIONE / ILLUSTRATION



Connettore ovale - Lungh. mm. 295
Oval connector - Length mm. 295

NOSTRO RIFERIMENTO OUR REFERENCE

960879

RIFERIMENTO COSTRUTTORE O.E. REFERENCE

42548208 - 1908407

DESCRIZIONE / DESCRIPTION

Kit segnalatori usura freno anteriore e posteriore (2 pz.)
Set of brake wear indicators front and rear (2 pcs)

ILLUSTRAZIONE / ILLUSTRATION



Connettore ovale - Lungh. mm. 190
Oval connector - Length mm. 190

NOSTRO RIFERIMENTO OUR REFERENCE

960864

RIFERIMENTO COSTRUTTORE O.E. REFERENCE

42548195 - 2992393

DESCRIZIONE / DESCRIPTION

Kit segnalatori usura freno anteriore e posteriore (2 pz.)
Set of brake wear indicators front and rear (2 pcs)

TIPO DI VEICOLO / VEHICLE TYPE

DAILY CITY 2000

35S9-35S11-35S13

35C9-35C11-35C13-35C15

35S10-35S12

35C10-35C12

(dal telaio n° 5484645/D239463)

(from chassis n° 5484645/D239463)

ILLUSTRAZIONE / ILLUSTRATION

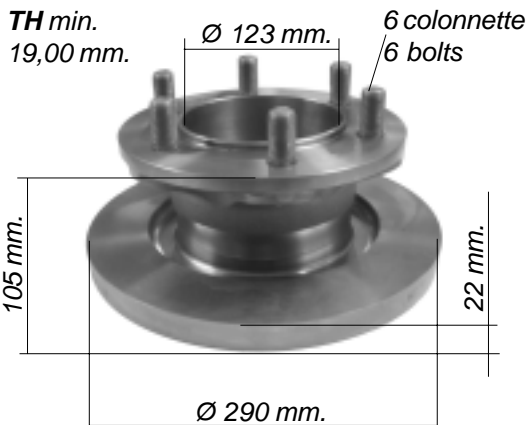
NOSTRO RIFERIMENTO
OUR REFERENCERIFERIMENTO COSTRUTTORE
O.E. REFERENCE**960501**

42546401

DESCRIZIONE / DESCRIPTION

Serie dischi freno assale anteriore
Set of brake discs front axle

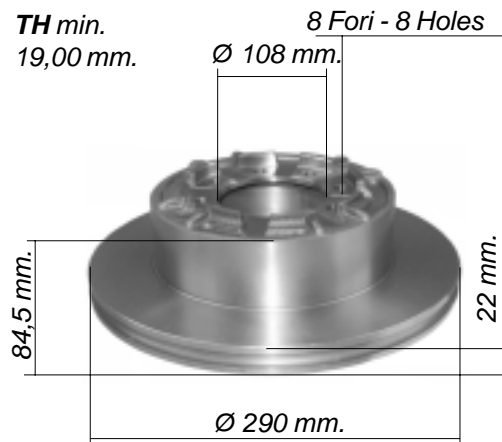

ILLUSTRAZIONE / ILLUSTRATION

NOSTRO RIFERIMENTO
OUR REFERENCERIFERIMENTO COSTRUTTORE
O.E. REFERENCE**960051**

42471111 - 1908773

DESCRIZIONE / DESCRIPTION

Serie dischi freno assale posteriore
Set of brake discs rear axle



ILLUSTRAZIONE / ILLUSTRATION

NOSTRO RIFERIMENTO
OUR REFERENCERIFERIMENTO COSTRUTTORE
O.E. REFERENCE

E3 90R

960502

2995632

DESCRIZIONE / DESCRIPTION

Serie pastiglie freno anteriore e posteriore
Set of brake pads front and rear

WVA	Larghezza Width - mm.	Altezza Height - mm.	Spessore Thickness - mm.
29160	164,50	69,80	20



TIPO DI VEICOLO / VEHICLE TYPE

DAILY CITY 2000

35S9-35S11-35S13

35C9-35C11-35C13-35C15

35S10-35S12

35C10-35C12

(dal telaio n° 5484645/D239463)

(from chassis n° 5484645/D239463)

ILLUSTRAZIONE / ILLUSTRATION



E3 90R

NOSTRO RIFERIMENTO OUR REFERENCE

960503

RIFERIMENTO COSTRUTTORE O.E. REFERENCE

2995633

DESCRIZIONE / DESCRIPTION

Serie pastiglie freno anteriore e posteriore
Set of brake pads front and rear

WVA	Larghezza Width - mm.	Altezza Height - mm.	Spessore Thickness - mm.
29121	165	67	20



ILLUSTRAZIONE / ILLUSTRATION



E3 90R

NOSTRO RIFERIMENTO OUR REFERENCE

960504

RIFERIMENTO COSTRUTTORE O.E. REFERENCE

2995693

DESCRIZIONE / DESCRIPTION

Serie pastiglie freno anteriore e posteriore
Set of brake pads front and rear

WVA	Larghezza Width - mm.	Altezza Height - mm.	Spessore Thickness - mm.
29121	164,80	66,50	20,30



ILLUSTRAZIONE / ILLUSTRATION

NOSTRO RIFERIMENTO OUR REFERENCE

RIFERIMENTO COSTRUTTORE O.E. REFERENCE

DESCRIZIONE / DESCRIPTION

TIPO DI VEICOLO / VEHICLE TYPE

DAILY CITY 2000 65C11 - 65C13 - 65C15

ILLUSTRAZIONE / ILLUSTRATION	NOSTRO RIFERIMENTO OUR REFERENCE	RIFERIMENTO COSTRUTTORE O.E. REFERENCE								
<p>TH min. 23,00 mm.</p> <p>9 Fori - 9 Holes</p> <p>Ø 80 mm.</p> <p>53 mm.</p> <p>26 mm.</p> <p>Ø 290 mm.</p> 	960107	42471214								
DESCRIZIONE / DESCRIPTION										
<p>Serie dischi freno assale anteriore Set of brake discs front axle</p> <p>Fascia AUTOVENTILANTE SELF-VENTILATED Band</p> 										
ILLUSTRAZIONE / ILLUSTRATION	NOSTRO RIFERIMENTO OUR REFERENCE	RIFERIMENTO COSTRUTTORE O.E. REFERENCE								
	960973	42536101								
DESCRIZIONE / DESCRIPTION										
<p>Serie pastiglie freno anteriore - Set of brake pads front (impianto BREMBO - BREMBO system)</p> <table border="1"> <thead> <tr> <th>WVA</th> <th>Larghezza Width - mm.</th> <th>Altezza Height - mm.</th> <th>Spessore Thickness - mm.</th> </tr> </thead> <tbody> <tr> <td>29160</td> <td>164,50</td> <td>67,80</td> <td>20</td> </tr> </tbody> </table> 			WVA	Larghezza Width - mm.	Altezza Height - mm.	Spessore Thickness - mm.	29160	164,50	67,80	20
WVA	Larghezza Width - mm.	Altezza Height - mm.	Spessore Thickness - mm.							
29160	164,50	67,80	20							
ILLUSTRAZIONE / ILLUSTRATION	NOSTRO RIFERIMENTO OUR REFERENCE	RIFERIMENTO COSTRUTTORE O.E. REFERENCE								
<p>Connettore ovale - Lungh. mm. 295 Oval connector - Length mm. 295</p> <p>1</p>  <p>Connettore ovale - Lungh. mm. 190 Oval connector - Length mm. 190</p> <p>2</p> 	<p>960879</p> <p>960864</p>	<p>42548208 - 1908407 (1)</p> <p>42548195 - 2992393 (2)</p>								
DESCRIZIONE / DESCRIPTION										
<p>Kit segnalatori usura freno anteriore e posteriore (2 pz.) Set of brake wear indicators front and rear (2 pcs)</p> <p>Kit segnalatori usura freno anteriore e posteriore (2 pz.) Set of brake wear indicators front and rear (2 pcs)</p>										

TIPO DI VEICOLO / VEHICLE TYPE

DAILY CITY 2000 65C11 - 65C13 - 65C15

ILLUSTRAZIONE / ILLUSTRATION

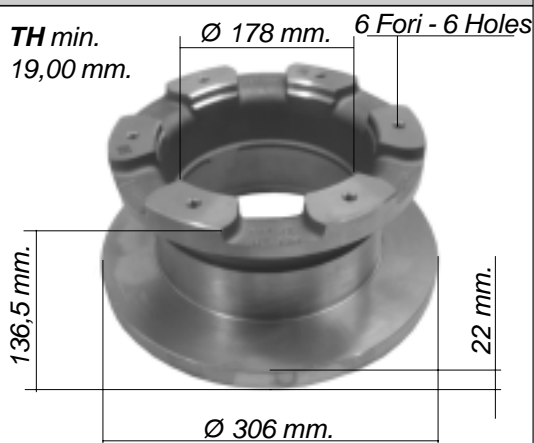

NOSTRO RIFERIMENTO OUR REFERENCE

960108

RIFERIMENTO COSTRUTTORE O.E. REFERENCE

42471150

DESCRIZIONE / DESCRIPTION

Serie dischi freno assale posteriore
Set of brake discs rear axle



ILLUSTRAZIONE / ILLUSTRATION

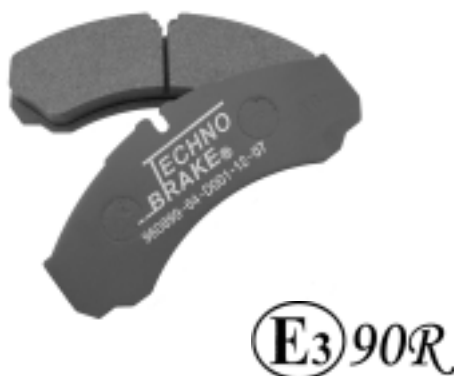

NOSTRO RIFERIMENTO OUR REFERENCE

960899

RIFERIMENTO COSTRUTTORE O.E. REFERENCE

42535791

DESCRIZIONE / DESCRIPTION

Serie pastiglie freno posteriore - Set of brake pads rear

WVA	Larghezza Width - mm.	Altezza Height - mm.	Spessore Thickness - mm.
29121 29357	164,8	66,5	20,3



ILLUSTRAZIONE / ILLUSTRATION

Connettore ovale - Lungh. mm. 295
Oval connector - Length mm. 295



1

Connettore ovale - Lungh. mm 190
Oval connector - Length mm. 190



2

NOSTRO RIFERIMENTO OUR REFERENCE

960879

960864

RIFERIMENTO COSTRUTTORE O.E. REFERENCE

42548208 - 1908407 (1)

42548195 - 2992393 (2)

DESCRIZIONE / DESCRIPTION

Kit segnalatori usura freno anteriore e posteriore (2 pz.)
Set of brake wear indicators front and rear (2 pcs)

Kit segnalatori usura freno anteriore e posteriore (2 pz.)
Set of brake wear indicators front and rear (2 pcs)

TIPO DI VEICOLO / VEHICLE TYPE

DAILY 2006 M.Y.
35C10/C12/C15/C18
35S14
50C15/C18

ILLUSTRAZIONE / ILLUSTRATION

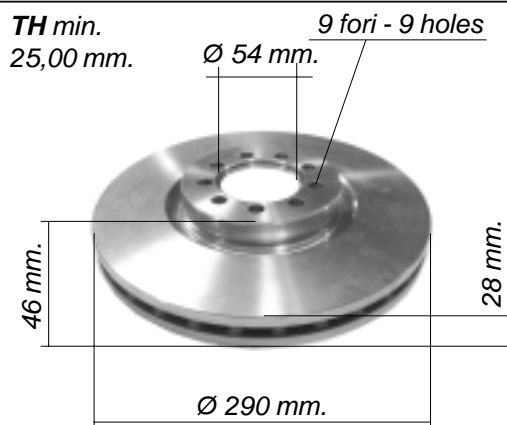
NOSTRO RIFERIMENTO
OUR REFERENCE**960512**RIFERIMENTO COSTRUTTORE
O.E. REFERENCE

2996121

DESCRIZIONE / DESCRIPTION

Serie dischi freno assale anteriore
Set of brake discs front axle



ILLUSTRAZIONE / ILLUSTRATION

NOSTRO RIFERIMENTO
OUR REFERENCE**960513**RIFERIMENTO COSTRUTTORE
O.E. REFERENCE

42555881

DESCRIZIONE / DESCRIPTION

Serie pastiglie freno anteriore - Set of brake pads front

WVA	Larghezza Width - mm.	Altezza Height - mm.	Spessore Thickness - mm.
29229	163,10	66,70	20,80



ILLUSTRAZIONE / ILLUSTRATION



Connettore ovale - Lungh. mm. 145
Oval connector - Length mm. 145

NOSTRO RIFERIMENTO
OUR REFERENCE**960514**RIFERIMENTO COSTRUTTORE
O.E. REFERENCE

42555634

DESCRIZIONE / DESCRIPTION

Kit indicatori usura freno anteriore (Pz. 2)
Set of brake wear indicators front (2 pcs.)

TIPO DI VEICOLO / VEHICLE TYPE

DAILY 2006 M.Y. (dal 05/2006 - from 05/2006)

29L10/L12/L14

35C10/C12/C14/C18

35S14

ILLUSTRAZIONE / ILLUSTRATION

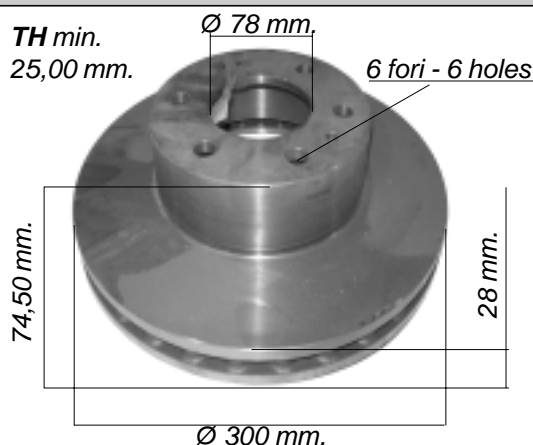

NOSTRO RIFERIMENTO OUR REFERENCE

960696

RIFERIMENTO COSTRUTTORE O.E. REFERENCE

2996131

DESCRIZIONE / DESCRIPTION

Serie dischi freno assale anteriore
Set of brake discs front axle



ILLUSTRAZIONE / ILLUSTRATION



NOSTRO RIFERIMENTO OUR REFERENCE

960513

RIFERIMENTO COSTRUTTORE O.E. REFERENCE

42555881

DESCRIZIONE / DESCRIPTION

Serie pastiglie freno anteriore - Set of brake pads front

WVA	Larghezza Width - mm.	Altezza Height - mm.	Spessore Thickness - mm.
29229	163,10	66,70	20,80



ILLUSTRAZIONE / ILLUSTRATION



Connettore ovale - Lungh. mm 145
Oval connector - Length mm. 145

NOSTRO RIFERIMENTO OUR REFERENCE

960514

RIFERIMENTO COSTRUTTORE O.E. REFERENCE

42555634

DESCRIZIONE / DESCRIPTION

Kit indicatori usura freno anteriore (Pz. 2)
Set of brake wear indicators front (2 pcs.)

TIPO DI VEICOLO / VEHICLE TYPE

DAILY 2006 M.Y.
35C14/C16/C18

CON ABS - WITH ABS

ILLUSTRAZIONE / ILLUSTRATION

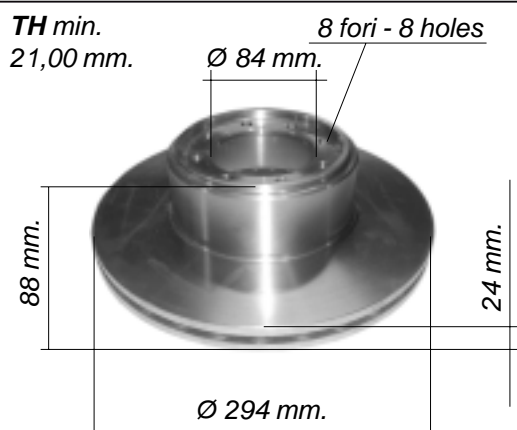
NOSTRO RIFERIMENTO
OUR REFERENCE

960515

RIFERIMENTO COSTRUTTORE
O.E. REFERENCE

2996043

DESCRIZIONE / DESCRIPTION

Serie dischi freno assale posteriore
Set of brake discs rear axle

ILLUSTRAZIONE / ILLUSTRATION

NOSTRO RIFERIMENTO
OUR REFERENCE

960516

RIFERIMENTO COSTRUTTORE
O.E. REFERENCE

42555917

DESCRIZIONE / DESCRIPTION

Serie pastiglie freno posteriore - Set of brake pads rear

WVA	Larghezza Width - mm.	Altezza Height - mm.	Spessore Thickness - mm.
29232	141,10	72,75	21



ILLUSTRAZIONE / ILLUSTRATION

Connettore ovale - Lungh. mm.295
Oval connector - Length mm. 295NOSTRO RIFERIMENTO
OUR REFERENCE

960517

RIFERIMENTO COSTRUTTORE
O.E. REFERENCE

42556205

DESCRIZIONE / DESCRIPTION

Kit indicatori usura freno posteriore (Pz. 2)
Set of brake wear indicators rear (2 pcs.)

TIPO DI VEICOLO / VEHICLE TYPE

DAILY 2006 M.Y.
35C14/C16/C18

SENZA ABS - WITHOUT ABS

ILLUSTRAZIONE / ILLUSTRATION

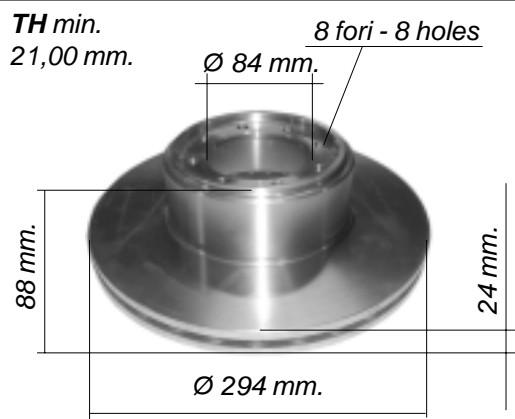

NOSTRO RIFERIMENTO OUR REFERENCE

960498

RIFERIMENTO COSTRUTTORE O.E. REFERENCE

2996033

DESCRIZIONE / DESCRIPTION

Serie dischi freno assale posteriore
Set of brake discs rear axle



ILLUSTRAZIONE / ILLUSTRATION



NOSTRO RIFERIMENTO OUR REFERENCE

960516

RIFERIMENTO COSTRUTTORE O.E. REFERENCE

42555917

DESCRIZIONE / DESCRIPTION

Serie pastiglie freno posteriore - Set of brake pads rear

WVA	Larghezza Width - mm.	Altezza Height - mm.	Spessore Thickness - mm.
29232	141,10	72,75	21



ILLUSTRAZIONE / ILLUSTRATION



Connettore ovale - Lungh. mm.295
Oval connector - Length mm. 295

NOSTRO RIFERIMENTO OUR REFERENCE

960517

RIFERIMENTO COSTRUTTORE O.E. REFERENCE

42556205

DESCRIZIONE / DESCRIPTION

Kit indicatori usura freno posteriore (Pz. 2)
Set of brake wear indicators rear (2 pcs.)

TIPO DI VEICOLO / VEHICLE TYPE

DAILY 2006 M.Y. (dal 05/2006 - from 05/2006)

35C10/C12/C14/C18

35S14

CON ABS - WITH ABS

ILLUSTRAZIONE / ILLUSTRATION

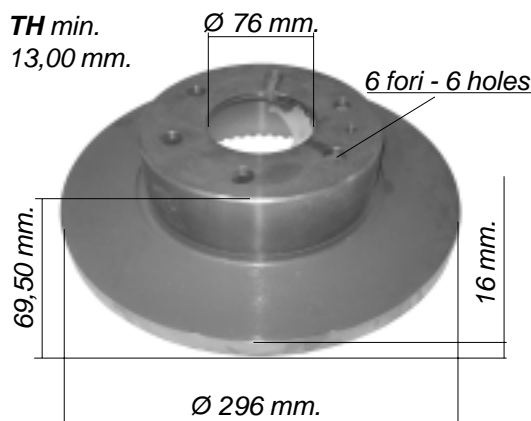
NOSTRO RIFERIMENTO
OUR REFERENCE**960695**RIFERIMENTO COSTRUTTORE
O.E. REFERENCE

2996027

DESCRIZIONE / DESCRIPTION

Serie dischi freno assale posteriore
Set of brake discs rear axle

ILLUSTRAZIONE / ILLUSTRATION

NOSTRO RIFERIMENTO
OUR REFERENCE**960516**RIFERIMENTO COSTRUTTORE
O.E. REFERENCE

42555917

DESCRIZIONE / DESCRIPTION

Serie pastiglie freno posteriore - Set of brake pads rear

WVA	Larghezza Width - mm.	Altezza Height - mm.	Spessore Thickness - mm.
29232	141,10	72,75	21



ILLUSTRAZIONE / ILLUSTRATION

Connettore ovale - Lungh. mm.295
Oval connector - Length mm. 295NOSTRO RIFERIMENTO
OUR REFERENCE**960517**RIFERIMENTO COSTRUTTORE
O.E. REFERENCE

42556205

DESCRIZIONE / DESCRIPTION

Kit indicatori usura freno posteriore (Pz. 2)
Set of brake wear indicators rear (2 pcs.)

TIPO DI VEICOLO / VEHICLE TYPE

DAILY 2006 M.Y. (dal 05/2006 - from 05/2006)
29L10/L12/L14
35C10/C12/C14/C18
35S10/S12/S14/S18

SENZA ABS - WITHOUT ABS

ILLUSTRAZIONE / ILLUSTRATION	NOSTRO RIFERIMENTO OUR REFERENCE	RIFERIMENTO COSTRUTTORE O.E. REFERENCE								
	960694	2996028								
DESCRIZIONE / DESCRIPTION										
<p>Serie dischi freno assale posteriore Set of brake discs rear axle</p>										
ILLUSTRAZIONE / ILLUSTRATION	NOSTRO RIFERIMENTO OUR REFERENCE	RIFERIMENTO COSTRUTTORE O.E. REFERENCE								
	960516	42555917								
DESCRIZIONE / DESCRIPTION										
<p>Serie pastiglie freno posteriore - Set of brake pads rear</p> <table border="1" data-bbox="644 1451 1232 1621"> <thead> <tr> <th>WVA</th> <th>Larghezza Width - mm.</th> <th>Altezza Height - mm.</th> <th>Spessore Thickness - mm.</th> </tr> </thead> <tbody> <tr> <td>29232</td> <td>141,10</td> <td>72,75</td> <td>21</td> </tr> </tbody> </table>			WVA	Larghezza Width - mm.	Altezza Height - mm.	Spessore Thickness - mm.	29232	141,10	72,75	21
WVA	Larghezza Width - mm.	Altezza Height - mm.	Spessore Thickness - mm.							
29232	141,10	72,75	21							
ILLUSTRAZIONE / ILLUSTRATION	NOSTRO RIFERIMENTO OUR REFERENCE	RIFERIMENTO COSTRUTTORE O.E. REFERENCE								
<p>Connettore ovale - Lungh. mm.295 Oval connector - Length mm. 295</p>	960517	42556205								
DESCRIZIONE / DESCRIPTION										
<p>Kit indicatori usura freno posteriore (Pz. 2) Set of brake wear indicators rear (2 pcs.)</p>										

TIPO DI VEICOLO / VEHICLE TYPE

DAILY 2006
50C15/C18
60C15/C18
65C15/C18

ILLUSTRAZIONE / ILLUSTRATION

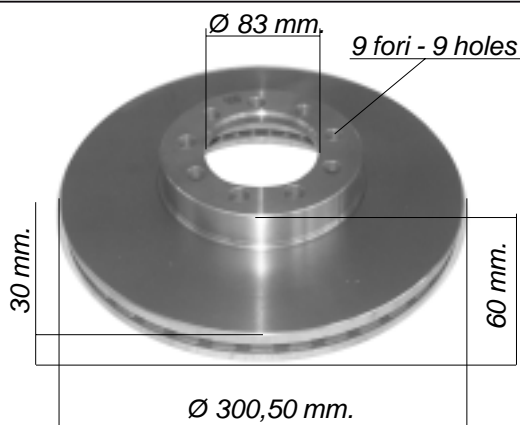
NOSTRO RIFERIMENTO
OUR REFERENCE**960697**RIFERIMENTO COSTRUTTORE
O.E. REFERENCE

2996122

DESCRIZIONE / DESCRIPTION

Serie dischi freno assale anteriore
Set of brake discs font axle

Fascia AUTOVENTILANTE
SELF-VENTILATED Band



ILLUSTRAZIONE / ILLUSTRATION

NOSTRO RIFERIMENTO
OUR REFERENCE**961015**RIFERIMENTO COSTRUTTORE
O.E. REFERENCE

42555669

DESCRIZIONE / DESCRIPTION

Serie pastiglie freno anteriore - Set of brake pads front

WVA	Larghezza Width - mm.	Altezza Height - mm.	Spessore Thickness - mm.
29122	174.60	85.40	22.00



ILLUSTRAZIONE / ILLUSTRATION



Connettore ovale - Lungh. mm. 190
Oval connector - Length mm. 190

NOSTRO RIFERIMENTO
OUR REFERENCE**960864**RIFERIMENTO COSTRUTTORE
O.E. REFERENCE

42548195 - 2992393

DESCRIZIONE / DESCRIPTION

Kit indicatori usura freno anteriore (Pz. 2)
Set of brake wear indicators front (2 pcs.)

TIPO DI VEICOLO / VEHICLE TYPE

DAILY 2006
50C15/C18
60C15/C18
65C15/C18

ILLUSTRAZIONE / ILLUSTRATION

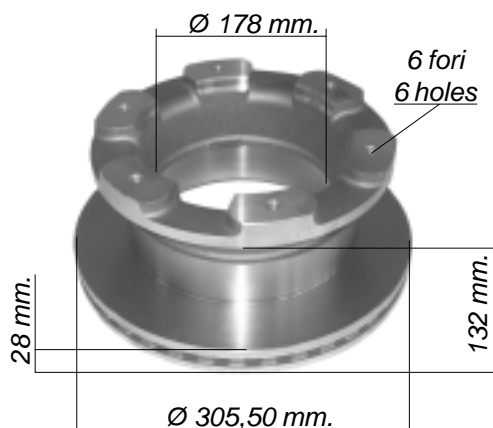

NOSTRO RIFERIMENTO OUR REFERENCE

960698

RIFERIMENTO COSTRUTTORE O.E. REFERENCE

2996049

DESCRIZIONE / DESCRIPTION

Serie dischi freno assale posteriore
Set of brake discs rear axle

Fascia AUTOVENTILANTE
SELF-VENTILATED Band



ILLUSTRAZIONE / ILLUSTRATION



NOSTRO RIFERIMENTO OUR REFERENCE

960895

RIFERIMENTO COSTRUTTORE O.E. REFERENCE

42555633

DESCRIZIONE / DESCRIPTION

Serie pastiglie freno posteriore - Set of brake pads rear

WVA	Larghezza Width - mm.	Altezza Height - mm.	Spessore Thickness - mm.
-	184.20	64.70	22.70



ILLUSTRAZIONE / ILLUSTRATION



Connettore ovale - Lungh. mm. 130
Oval connector - Length mm. 130

NOSTRO RIFERIMENTO OUR REFERENCE





960514





RIFERIMENTO COSTRUTTORE O.E. REFERENCE





42555634

DESCRIZIONE / DESCRIPTION





Kit indicatori usura freno posteriore (Pz. 2)
Set of brake wear indicators rear (2 pcs.)

	Ns Riferim. Our Ref.	Rif. Costr. O.E. Ref.	Descrizione/Tipo di veicolo Description/Vehicle Type
 <p>Senza pastiglie freno Without brake pads</p>	960373	42532363 99464095 93192367 93156970	<p><i>Pinza freno destra</i> <i>Brake caliper RH</i> (Per serie pastiglie rif. 960894) (Brake pads for set ref. 960894)</p> <p>Daily 35.8 - 35.10 - 35.12 (fino / tin 1996)</p>
 <p>Senza pastiglie freno Without brake pads</p>	960372	42532362 99464094 93192368 93156969	<p><i>Pinza freno sinistra</i> <i>Brake caliper LH</i> (Per serie pastiglie rif. 960894) (Brake pads for set ref. 960894)</p> <p>Daily 35.8 - 35.10 - 35.12 (fino / tin 1996)</p>
 <p>Con pastiglie freno With brake pads</p>	965056	99464101	<p><i>Pinza freno destra</i> <i>completa di pastiglie freno</i> <i>Brake caliper RH with brake pads</i></p> <p>Daily 45 - 49.10/12 (Brembo) Daily 45 - 49.10/12 4x4 (Perrot)</p>
 <p>Con pastiglie freno With brake pads</p>	965057	99464100	<p><i>Pinza freno sinistra</i> <i>completa di pastiglie freno</i> <i>Brake caliper LH with brake pads</i></p> <p>Daily 45 - 49.10/12 (Brembo) Daily 45 - 49.10/12 4x4 (Perrot)</p>



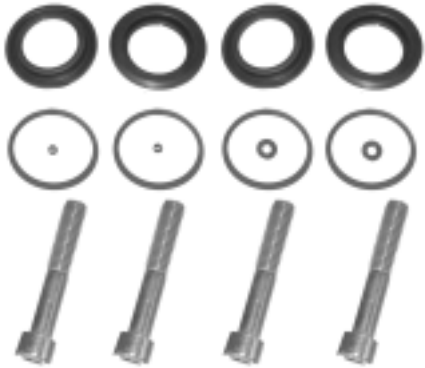

	Ns Riferim. Our Ref.	Rif. Costr. O.E. Ref.	Descrizione/Tipo di veicolo Description/Vehicle Type
 <p>Senza pastiglie freno Without brake pads</p>	975081	42536625 42536173 42548188 42470848	<p><i>Pinza freno anteriore destra</i> <i>Front brake caliper RH</i></p> <p>Daily City 2000 35C9-C11-C13 50C11-C13-C15</p> <p>Daily '96 35.8-35.10-35.12 - 49.10/12 (dal 09/00 - to 09/00)</p>
 <p>Senza pastiglie freno Without brake pads</p>	975080	42536624 42536172 42548187 42470847	<p><i>Pinza freno anteriore sinistra</i> <i>Front brake caliper LH</i></p> <p>Daily City 2000 35C9-C11-C13 50C11-C13-C15</p> <p>Daily '96 35.8-35.10-35.12 - 49.10/12 (dal 09/00 - from 09/00)</p>
 <p>Senza pastiglie freno Without brake pads</p>	975083	42536627 42536175 42548190	<p><i>Pinza freno posteriore destra</i> <i>Rear brake caliper RH</i></p> <p>Daily City 2000 35C9-C11-C13 50C11-C13-C15</p> <p>Daily '96 35.8-35.10-35.12 - 49.10/12 (dal 09/00 - from 09/00)</p>
 <p>Senza pastiglie freno Without brake pads</p>	975082	42536626 42536174 42548189	<p><i>Pinza freno posteriore sinistra</i> <i>Rear brake caliper LH</i></p> <p>Daily City 2000 35C9-C11-C13 50C11-C13-C15</p> <p>Daily '96 35.8-35.10-35.12 - 49.10/12 (dal 09/00 - from 09/00)</p>

	Ns Riferim. Our Ref.	Rif. Costr. O.E. Ref.	Descrizione/Tipo di veicolo Description/Vehicle Type
	975084	99465472	<i>Pinza freno anteriore sinistra</i> <i>Front brake caliper LH</i> Daily 59.12 Turbodaily '96
	975085	99465473	<i>Pinza freno anteriore destra</i> <i>Front brake caliper RH</i> Daily 59.12 Turbodaily '96
	975090	42554990	<i>Pinza freno posteriore sinistra</i> <i>Rear brake caliper SH</i> Daily MY 2006 65C14 / C15 / C18
	975091	42554991	<i>Pinza freno posteriore destra</i> <i>Rear brake caliper RH</i> Daily MY 2006 65C14 / C15 / C18





	Ns Riferim. Our Ref.	Rif. Costr. O.E. Ref.	Descrizione/Tipo di veicolo Description/Vehicle Type
	960930	1902316	<p><i>Kit pinza freni</i> <i>Brake caliper kit</i></p> <p>Daily Restyling 30.8-35.8-40.8-35.10 New Daily 35.8-40.8-35.10 TurboDaily 35.12</p>
	960889	1902317	<p><i>Kit pinza freni</i> <i>Brake caliper kit</i></p> <p>Daily Restyling 30.8-35.8-40.8-35.10 New Daily 30.8-35.8-40.8-35.10 TurboDaily 30.10-35.10-35.12</p>
	965055	-	<p><i>Kit revisione pinza freno</i> <i>(Per pinza Rif. 99464100 - 99464101)</i></p> <p><i>Brake caliper overhaul kit</i> <i>(for brake caliper Ref. 99464100 - 99464101)</i></p> <p>Daily 45 - 49.10/12 (Brembo) Daily 45 - 49.10/12 4x4 (Perrot)</p>
	960829	42530365	<p><i>Molla freno per pinza freno Rif:</i> <i>Brake spring for brake caliper Ref:</i> 42536624 - 42536625 42536626 - 42536627</p> <p>Daily City 2000 35C9-C11-C13 50C11-C13-C15 Daily '96 35.8-35.10-35.12 - 49.10/12 <i>(dal 09/00 - from 09/00)</i></p>

	Ns Riferim. Our Ref.	Rif. Costr. O.E. Ref.	Descrizione/Tipo di veicolo Description/Vehicle Type
	960830	93161567	Kit revisione guarnizioni ant. per pinze freno Rif. 42532362-42532363 Front gaskets repairing kit for brake calipers Ref. 42532362 - 42532363 Daily 35.8 - 35.10 - 35.12 (fino 1996)
	960832	93161188	Kit revisione guarnizioni ant. per pinze freno Rif. 99464100-99464101 Front gaskets repairing kit for brake calipers Ref. 99464100 - 99464101 Daily 45 - 49.10/12 (Brembo) Daily 45 - 49.10/12 4x4 (Perrot)
	960833	93162189	Kit revisione guarnizioni anteriori per pinze freno Rif. 42470837 - 42470838 Front gaskets repairing kit for brake calipers Ref. 42470837 - 42470838 Daily City 2000 35S9-35S11-35S13
	960834	93161847	Kit revisione guarnizioni per pinze freno anteriori Rif.42536624/625 posteriori Rif. 42536626/627 Gaskets repairing kit for brake calipers Front Ref.42536624/625 Rear Ref. 42536626/627 Daily City 2000 35C9-C11-C13 - 50C11-C13-C15 Daily '96 (dal 09/00 - to 09/00) 35.8-35.10-35.12 - 49.10/12

	Ns Riferim. Our Ref.	Rif. Costr. O.E. Ref.	Descrizione/Tipo di veicolo Description/Vehicle Type
	960835	42535784	<p>Kit revisione guarnizioni anteriori per pinze freno Rif. 42535599/600 Front gaskets repairing kit for brake calipers Ref. 42535599/600</p> <p>Daily City 2000 65C11-65C13-65C15</p>
	960836	42535792	<p>Kit revisione guarnizioni posteriori per pinze freno Rif. 42535438/439 Rear gaskets repairing kit for brake calipers Ref. 42535438/439</p> <p>Daily City 2000 65C11-65C13-65C15</p>
<p>Ø 42 mm</p>	960850	93161568	<p>Kit revisione pinza anteriore per pinze Rif. 42532362/363/364/365 Front repairing kit for brake calipers Ref. 42532362/363/364/365</p> <p>Daily 30.8 - 35.8 - 40.8 35.10 - 40.10 - 35.12 (1996)</p>
<p>Ø 44 mm</p>	960848	93161187	<p>Kit revisione pinza anteriore per pinze Rif. 99464100/101 Front repairing kit for brake calipers Ref. 99464100/101</p> <p>Daily 45.10 - 49.10 - 49.12</p>

	Ns Riferim. Our Ref.	Rif. Costr. O.E. Ref.	Descrizione/Tipo di veicolo Description/Vehicle Type
	960828	93161849	<p>Kit revisione pinza ant. e post. <i>Front and rear brake calipers repairing kit</i></p> <p>Daily - Daily 96 35.8 - 35.10 - 35.12 - 49.10 - 49.12</p> <p>Daily City 2000 35C9 - C11 - C13 50C11 - C13 - C15</p>
	960700	93161848	<p>Kit revisione pinza ant. e post. <i>per pinze Rif. 42536172/173/174/175</i> <i>Front and rear brake calipers repairing kit</i></p> <p>Ref. 42536172/173/174/175</p> <p>Daily 35.8 - 35.10 - 35.12 - 49.10 - 49.12</p> <p>Daily 96 Daily City 2000 35C9 - C11 - C13 50C11 - C13 - C15</p>
	960703	93162193	<p>Kit revisione pinza ant. e post. <i>per pinze Rif. 42536172/173/174/175</i> <i>Front and rear brake calipers repairing kit</i></p> <p>Ref. 42536172/173/174/175</p> <p>Daily - Daily 96 35.8 - 35.10 - 35.12 - 49.10 - 49.12</p> <p>Daily City 2000 35C9 - C11 - C13 35S9 - S11 - S13 - S15 50C11 - C13 - C15 65C11 - C13 - C15</p>
	960846	8121135	<p>Kit revisione pinza anteriore <i>per pinze Rif. 42532362/363/364/365</i> <i>Front brake calipers repairing kit</i></p> <p>Ref. 42532362/363/364/365</p> <p>Daily 30.8 - 35.8 - 40.8 - 35.10 - 35.12</p>

	Ns Riferim. Our Ref.	Rif. Costr. O.E. Ref.	Descrizione/Tipo di veicolo Description/Vehicle Type
<p>Ø 42 MM.</p>	960713	93156966	<p><i>Kit revisione pinza anteriore</i> <i>Front brake calipers repairing kit</i></p> <p>New Daily 30.8-35.8-35.10 Daily Restyling 30.8-35.8-35.10</p>
<p>Ø 52 MM.</p>	960714	42548325 42535785	<p><i>Kit revisione pinza anteriore</i> <i>Front brake calipers repairing kit</i></p> <p>Daily City 2000 65C11-65C13-65C15</p>
<p>Ø 46 MM.</p>	960715	42548326 42535793	<p><i>Kit revisione pinza posteriore</i> <i>Rear brake calipers repairing kit</i></p> <p>Daily City 2000 65C11-65C13-65C15</p>
	960716	42555882	<p><i>Kit revisione pinza anteriore</i> <i>Front brake calipers repairing kit</i></p> <p>Daily 2006 M. Y. 35C14/C16/C18</p>
	960717	42555883	<p><i>Kit revisione pinza anteriore</i> <i>Front brake calipers repairing kit</i></p> <p>Daily 2006 M. Y. 35C14/C16/C18</p>

	Ns Riferim. Our Ref.	Rif. Costr. O.E. Ref.	Descrizione/Tipo di veicolo Description/Vehicle Type
 <p>Ø 48 MM.</p>	960718	42555884	<p><i>Kit revisione pinza anteriore</i> <i>Front brake calipers repairing kit</i></p> <p>Daily 2006 M. Y. 35C14/C16/C18</p>
	960719	42555416	<p><i>Kit revisione pinza anteriore e post.</i> <i>Front and rear brake calipers repairing kit</i></p> <p>Daily 2006 M. Y. 35C14/C16/C18</p>
	960720	42555418	<p><i>Kit revisione pinza posteriore</i> <i>Rear brake calipers repairing kit</i></p> <p>Daily 2006 M. Y. 35C14/C16/C18</p>
	960721	42555419	<p><i>Kit revisione pinza posteriore</i> <i>Rear brake calipers repairing kit</i></p> <p>Daily 2006 M. Y. 35C14/C16/C18</p>

	Ns Riferim. Our Ref.	Rif. Costr. O.E. Ref.	Descrizione/Tipo di veicolo Description/Vehicle Type
	960015	42555636	Kit revisione guarnizioni pinza freni Brake caliper gaskets repairing kit Daily M.Y. 2006 65-C.14
	960016	42555417	Kit revisione pinza freni viti Brake caliper repairing kit screw Daily M.Y. 2006 65-C.14
	960017	93161181	Kit revisione pinza freni Brake caliper repairing kit Daily 59.12 (96)
	960026	93160387	Kit pistoni pinza Piston set for brake caliper TurboDaily 59.12 (96)

	Ns Riferim. Our Ref.	Rif. Costr. O.E. Ref.	Descrizione/Tipo di veicolo Description/Vehicle Type
	960014	42555637	Kit pistoni per pinza freni Piston set for brake caliper Daily M. Y. 2006 65-C.14
	960013	42555635	Kit ricambio molla pinza freni Spring brake caliper spare replacement kit Daily M. Y. 2006 65-C.14
	960090	93160388	Molla pinza freni Spring brake caliper TURBODAILY 59.12 (96)
	960091	93160389	Perno calibrato pinza Pin brake caliper TURBODAILY 59.12 (96)

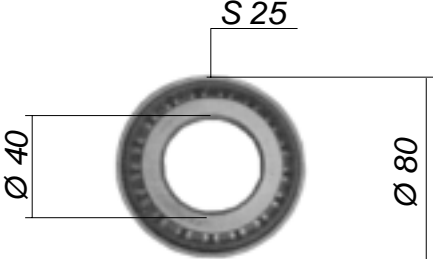
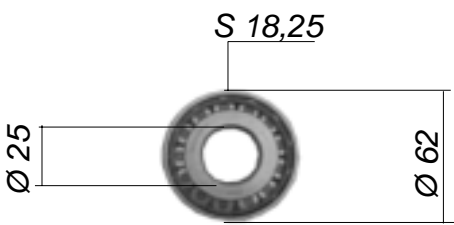
	Ns Riferim. Our Ref.	Rif. Costr. O.E. Ref.	Descrizione/Tipo di veicolo Description/Vehicle Type
	<p>931005</p>	<p>93813627</p>	<p><i>Mozzo anteriore completo di cuscinetti</i> <i>Front hub assy with bearings</i></p> <p>New Daily 30.8 - 35.8 - 40.8</p>
	<p>931009</p>	<p>26800140</p>	<p><i>Cuscinetto interno mozzo</i> <i>Inside bearing hub</i></p> <p>New Daily 30.8 - 35.8 - 40.8</p>
	<p>931010</p>	<p>26800330</p>	<p><i>Cuscinetto esterno mozzo</i> <i>Outward bearing hub</i></p> <p>New Daily 30.8 - 35.8 - 40.8</p>

	Ns Riferim. Our Ref.	Rif. Costr. O.E. Ref.	Descrizione/Tipo di veicolo Description/Vehicle Type
	931006	93813628	<p>Mozzo anteriore completo di cuscinetti Front hub assy with bearings</p> <p>New Daily 35.10 - 49.10 Turboaily 35.12 - 49.12 - 59.12</p>
	931011	8582739	<p>Cuscinetto interno mozzo Inside bearing hub</p> <p>New Daily 35.10 - 49.10 Turboaily 35.12 - 49.12 - 59.12</p>
	931012	8582740	<p>Cuscinetto esterno mozzo Outward bearing hub</p> <p>New Daily 35.10 - 49.10 Turboaily 35.12 - 49.12 - 59.12</p>





	Ns Riferim. Our Ref.	Rif. Costr. O.E. Ref.	Descrizione/Tipo di veicolo Description/Vehicle Type
	931004	93824579	<i>Mozzo anteriore completo di cuscinetti</i> <i>Front hub assy with bearings</i> Daily City 2000 35S9 - 35S11 - 35S13
	931000	42470845	<i>Kit mozzo ruota anteriore</i> <i>Front hub assy set</i> Daily City 2000 35S9 - 35S11 - 35S13
	931015	BTH1024C	<i>Cuscinetto mozzo ruota anteriore per mozzo Rif. 93824579 - 42470845</i> <i>Front wheel hub bearing for wheel hub Ref. 93824579 - 42470845</i> Daily City 2000 35S9 - 35S11 - 35S13

	Ns Riferim. Our Ref.	Rif. Costr. O.E. Ref.	Descrizione/Tipo di veicolo Description/Vehicle Type
	931001	93824580	<p>Mozzo anteriore completo di cuscinetti Front hub assy with bearings</p> <p>Daily City 2000 35C9-C11-C13 50C11-C13-C15 Daily '96 35.8-35.10-35.12 - 49.10/12 (dal 09/00 - to 09/00)</p>
	931013	98430602	<p>Corona dentata per mozzo ruota anteriore Plate wheel for front hub assy</p> <p>Daily City 2000 35C9-C11-C13 50C11-C13-C15 Daily '96 35.8-35.10-35.12 - 49.10/12 (dal 09/00 - to 09/00)</p>
	931002	42470834	<p>Kit mozzo ruota anteriore Front hub assy set</p> <p>Daily City 2000 35C9-C11-C13 50C11-C13-C15 Daily '96 35.8-35.10-35.12 - 49.10/12 (dal 09/00 - from 09/00)</p>
	931020	1861887	<p>Cuscinetto per mozzo ruota Rif. 42470834 Bearing for wheel hub Ref. 42470834</p> <p>Daily '96 Daily City 2000</p>



	Ns Riferim. Our Ref.	Rif. Costr. O.E. Ref.	Descrizione/Tipo di veicolo Description/Vehicle Type
	<p>931007</p>	<p>7169265 7168256</p>	<p>Mozzo ruota posteriore Rear wheel hub</p> <p>Daily Restyling 30.8 - 40.8 - 35.8 - 35.10 New Daily 30.8 - 40.8 - 35.8 - 35.10 Turbo Daily 35.12</p>
	<p>931008</p>	<p>7180049</p>	<p>Mozzo ruota posteriore Rear wheel hub</p> <p>New Daily 35.10 - 49.10 (1996) Turbo Daily 35.12 - 49.12 - 59.12 (1996)</p>
	<p>931014</p>	<p>7180066</p>	<p>Cuscinetto mozzo ruota posteriore per mozzo rif. 7169265-7180049 Rear wheel hub bearing for wheel hub Ref. 7169265 - 7180049</p> <p>Daily Restyling 30.8-40.8-35.8-35.10 New Daily 30.8-40.8-35.8-35.10 Turbo Daily 35.12 New Daily 35.10-49.10 (1996) Turbo Daily 35.12-49.12-59.12 (1996)</p>
	<p>962000</p>	<p>7180039</p>	<p>Ghiera mozzo ruote BST Wheel hub bush</p> <p>Iveco Daily T.T.</p>

	Ns Riferim. Our Ref.	Rif. Costr. O.E. Ref.	Descrizione/Tipo di veicolo Description/Vehicle Type
	931017	7181957	<i>Mozzo ruota posteriore</i> <i>Rear hub assy</i> Daily City 2000 65C11/C13/C15
	931018	1905220	<i>Cuscinetto per mozzo ruota</i> <i>Rif. 7181957</i> <i>Bearing for hub Ref. 7181957</i> Turbodaily 59.12 Daily City 2000 65C11/C13/C15 EUROCARGO 60-65-75 EUROCARGO TECTOR 75

	Ns Riferim. Our Ref.	Rif. Costr. O.E. Ref.	Descrizione/Tipo di veicolo Description/Vehicle Type
	931019	42471216	<p><i>Kit mozzo ruota anteriore completo di cuscinetto</i> <i>Front hub assy kit with bearing</i></p> <p>Daily City 2000 65C11/C13/C15</p>
	931021	BTH1053	<p><i>Cuscinetto per mozzo ruota anteriore per Rif. 42471216</i> <i>Front hub bearing for Ref. 42471216</i></p> <p>Daily City 2000 65C11/C13/C15</p>
	931016	500349833	<p><i>Mozzo ruota anteriore</i> <i>Front hub assy</i></p> <p>Daily City 2000 65C11/C13/C15</p>

	Ns Riferim. Our Ref.	Rif. Costr. O.E. Ref.	Descrizione/Tipo di veicolo Description/Vehicle Type
<p><i>Impianto / System</i> LOCKHEED</p>  <p><i>Cilindretto/Cylinder</i> Rif. 8121575 Ø 17.4 mm.</p>	963086	500300073	Massa frenante Sx Ø 254x89 mm. Wheel brake left Ø 254x89 mm.
	963087	500300075	Massa frenante Dx Ø 254x89 mm. Wheel brake right Ø 254x89 mm.
			Daily Restyling 35.8-35.10 New Daily 35.8-40.8-35.10-45.10-49.10
<p><i>Impianto / System</i> LOCKHEED</p>  <p><i>Cilindretto/Cylinder</i> Rif. 8121575 Ø 17.4 mm.</p>	963098	500300079	Massa frenante Sx Ø 254x89 mm. con segnalatore Wheel brake left Ø 254x89 mm. with brake wear indicator
	963097	500300080	Massa frenante Dx Ø 254x89 mm. con segnalatore Wheel brake right Ø 254x89 mm. with brake wear indicator
			New Daily 35.10 Turbo Daily 35.12
<p><i>Impianto / System</i> LOCKHEED</p>  <p><i>Cilindretto/Cylinder</i> Rif. 93160540 Ø 19.5 mm.</p>	963057	500300092	Massa frenante Sx Ø 254x89 mm. con segnalatore Wheel brake left Ø 254x89 mm. with brake wear indicator
	963056	500300093	Massa frenante Dx Ø 254x89 mm. con segnalatore Wheel brake right Ø 254x89 mm. with brake wear indicator
			New Daily 35.10-49.10 Turbo Daily 35.12
<p><i>Impianto / System</i> PERROT</p>  <p><i>Cilindretto/Cylinder</i> Rif. 93155720 Ø 20.6 mm.</p>	962075	99436612	Massa frenante Sx Ø 270x80 mm. Wheel brake left Ø 270x80 mm.
	962076	99436613	Massa frenante Dx Ø 270x80 mm. Wheel brake right Ø 270x80 mm.
			Daily Restyling 49.10 New Daily 35.8-45.10-49.10 Turbo Daily 49.12



	Ns Riferim. Our Ref.	Rif. Costr. O.E. Ref.	Descrizione/Tipo di veicolo Description/Vehicle Type
	970103	504060927 99431433	<p>Completivo freno a mano completo posteriore Dx Complete rear hand brake assembly RH</p>
	970104	504060926 99431432	<p>Completivo freno a mano completo posteriore Sx Complete rear hand brake assembly LH</p> <p>New Daily 96 35.8 Turbo Daily 96 35.10-49.10 - 35.12-49.12 Daily City 2000 35C9-35C11-35C13 Daily City 2000 50C11 - 50C13</p>
	970132	504093277	<p>Completivo freno a mano completo posteriore Dx Compleat rear hand brake assembly RH</p>
	970131	504093276	<p>Completivo freno a mano completo posteriore Sx Compleat rear hand brake assembly LH</p> <p>Daily M.Y. 2006</p>
	961010	1906403	<p>Serie ganasce freno a mano post. Rear brake shoes set for hand brake</p> <p>New Daily 96 35.8 TurboDaily 96 35.10-49.10-35.12-49.12 Daily City 2000 35C9-35C11-35C13 50C11-50C13</p>

	Ns Riferim. Our Ref.	Rif. Costr. O.E. Ref.	Descrizione/Tipo di veicolo Description/Vehicle Type
	970101	2992568	<p>Serie ganasce freno a mano posteriori Rear brake shoes set for hand brake</p> <p>New Daily 96 35.8 Turbo Daily 96 35.10-49.10 - 35.12-49.12 Daily City 2000 35C9-35C11-35C13 Daily City 2000 50C11 - 50C13</p>
	970120	2995817	<p>Serie ganasce freno a mano posteriori Rear brake shoes set for hand brake</p> <p>Daily M.Y. 2006</p>
	970102	42535858	<p>Serie ganasce freno a mano posteriori Rear brake shoes set for hand brake</p> <p>Daily City 2000 65C11-C13-C15</p>





	Ns Riferim. Our Ref.	Rif. Costr. O.E. Ref.	Descrizione/Tipo di veicolo Description/Vehicle Type
	961009	1906350	<p>Serie ganasce freno fascia 89 mm. senza segnalatore d'usura Brake shoes set h.89 mm. without brake wear indicator</p> <p>New Daily 35.8-40.8-35.10-45.10-49.10 Turbo Daily 35.12 Daily Restyling 35.8-35.10</p>
	961042	-	<p>Serie ganasce freno con ceppo maggiorato 10/10 Brake shoes set with brake lining increased 10/10</p> <p>New Daily 35.8-40.8-35.10-45.10-49.10 Turbo Daily 35.12 Daily Restyling 35.8-35.10</p>
 <p>Con segnalatore usura With brake wear indicator</p>	961011	1906351	<p>Serie ganasce freno fascia 89 mm. con segnalatore Brake shoes set h.89 mm. with brake wear indicator</p> <p>New Daily 35.8 - 35.10 Turbo Daily 35.10-35.12</p>
 <p>Fascia / Uning H 70 mm.</p>	961018	1906352	<p>Serie ganasce freno fascia 70 mm. Brake shoes set h.70 mm</p> <p>New Daily 30.8 Daily Restyling 30.8 Turbo Daily 30.10 (Ruota singola)</p>

	Ns Riferim. Our Ref.	Rif. Costr. O.E. Ref.	Descrizione/Tipo di veicolo Description/Vehicle Type
<p><i>Impianto / System</i> PERROT</p> 	961040	1906377	<p><i>Serie ganasce freno fascia 80 mm. Brake shoe set h.80 mm.</i></p> <p>Daily Restyling 49.10 New Daily 35.8-45.10-49.10 Turbo Daily 49.12</p>

	Ns Riferim. Our Ref.	Rif. Costr. O.E. Ref.	Descrizione/Tipo di veicolo Description/Vehicle Type
	963085	-	Kit revisione freno posteriore sinistro (LH) (una ruota) senza cilindretto x 500300073
	963084	-	Kit revisione freno posteriore destro (RH) (una ruota) senza cilindretto x 500300075 Rear brake repairing kit (one wheel) without cylinder Daily Restyling 30.8-35.8-40.8-35.10 New Daily 30.8-35.8-40.8-35.10 Turbo Daily 35.12
	963101	8124927	Kit revisione freno sinistro Brake repairing kit left
	963100	8124924	Kit revisione freno destro Brake repairing kit right Daily Restyling 30.8-35.8-40.8-35.10 New Daily 30.8-35.8-40.8-35.10 Turbo Daily 35.12
	963116	-	Kit revisione freno sinistro senza registro Brake repairing kit left without brake adjuster
	963117	-	Kit revisione freno destro senza registro Brake repairing kit right without brake adjuster Daily Restyling 30.8-35.8-40.8-35.10 New Daily 30.8-35.8-40.8-35.10 Turbo Daily 35.12
	960884	8124928	Kit leve freno sinistro Brake lever kit left
	960883	8124925	Kit leve freno destro Brake lever kit right Daily Restyling 30.8-35.8-40.8-35.10 New Daily 30.8-35.8-40.8-35.10 Turbo Daily 35.12

	Ns Riferim. Our Ref.	Rif. Costr. O.E. Ref.	Descrizione/Tipo di veicolo Description/Vehicle Type
	963089	93161124	Kit molle freno sinistro modifica con 5° molla Brake springs set left modified with fifth spring
	963088	93161123	Kit molle freno destro modifica con 5° molla Brake springs set right modified with fifth spring
			Daily Restyling 30.8-35.8-40.8-35.10 New Daily 30.8-35.8-40.8-35.10 Turbo Daily 35.12
	963099	-	Kit pernetto fermo ganascia Fixing shoe pin set
			Daily Restyling 30.8-35.8-40.8-35.10 New Daily 30.8-35.8-40.8-35.10 Turbo Daily 35.12
<p><i>Impianto / System</i> PERROT</p> 	961523	8124934	Kit molle freno Brake springs set
			Daily Restyling 45.10-49.10 New Daily 35.8-45.10-49.10 Turbo Daily 49.12

	Ns Riferim. Our Ref.	Rif. Costr. O.E. Ref.	Descrizione/Tipo di veicolo Description/Vehicle Type
	961045	42536259 93161850	<p><i>Kit di riparazione (freno a mano) Repairing kit (for hand brake)</i></p> <p>New Daily 96 35.8 TurboDaily 96 35.10-49.10-35.12-49.12 Daily City 2000 35C9-35C11-35C13 50C11-50C13</p>
	961046	93161851	<p><i>Kit di riparazione (freno a mano) Repairing kit (for hand brake)</i></p> <p>New Daily 96 35.8 TurboDaily 96 35.10-49.10-35.12-49.12 Daily City 2000 35C9-35C11-35C13 50C11-50C13</p>
	961047	93161852	<p><i>Kit di riparazione (freno a mano) Repairing kit (for hand brake)</i></p> <p>New Daily(96) 35.8 TurboDaily(96) 35.10-49.10-35.12-49.12 Daily 2000 35C9-35C11-35C13 - 50C11-50C13</p>

	Ns Riferim. Our Ref.	Rif. Costr. O.E. Ref.	Descrizione/Tipo di veicolo Description/Vehicle Type
	963525	42530368	Leva piatto freno a mano (Rif. 99431432 - 99431433) Lever for hand brake (Ref. 99431432-99431433) Daily '96 Daily City 2000 35C9/C10/C11/C12/C13/C15 50C11/C13/C15
	963598	42535860	Leva piatto freno a mano (Rif. 500369260 - 500369261) Lever for hand brake (Ref. 500369260 - 500369261) Daily City 2000 65C11/C13/C15
	963597	-	Kit leve freno a mano (per ganasce freno) Levers set for hand brake Daily Restyling 49.10 New Daily 35.8-45.10-49.10 Turbo Daily 49.12
	963618	42535859	Kit molle richiamo Spring set Daily City 2000 65C11/C13/C15

	Ns Riferim. Our Ref.	Rif. Costr. O.E. Ref.	Descrizione/Tipo di veicolo Description/Vehicle Type
 <p>Ø 254.4 H 122.4 n.fori 6</p>	960027	7165379	<p><i>Tamburo freno posteriore Rear brake drum</i></p> <p>Daily Restyling 35.8-40.8-35.10 New Daily 35.8-40.8-35.10 Turbo Daily 35.10-35.12</p> 
 <p>Ø 270 H 144 n.fori 6</p>	960028	7165402	<p><i>Tamburo freno posteriore Rear brake drum</i></p> <p>Daily Restyling 45.10 - 49.10 New Daily 35.10-45.10-49.10 Turbo Daily 49.12</p> 

KIT MASSA FRENANTE CON TAMBURO
WHEEL BRAKE SET WITH DRUM

Ns. Riferim. Our Ref.	Rif. Costrutt. O.E. Ref.	Descrizione Description	Tipo di veicolo Vehicle Type
962094	-	<i>Kit massa frenante sinistra con tamburo Ø 254x89 LH</i>	Daily Restyling 35.8-40.8-35.10
962093	-	<i>Kit massa frenante destra con tamburo Ø 254x89 RH</i> <i>Wheel brake kit with drum kit</i>	New Daily 35.8-40.8-35.10

**IMPIANTO LOCKHEED**
LOCKHEED SYSTEM**SENZA SEGNALATORE**
WITHOUT INDICATOR

Ns. Riferim. Our Ref.	Rif. Costrutt. O.E. Ref.	Descrizione Description	Tipo di veicolo Vehicle Type
962095	-	<i>Kit massa frenante sinistra c/segnalatore con tamburo Ø 254x89 LH</i>	New Daily 35.10 Turbo Daily 35.12
962096	-	<i>Kit massa frenante destra c/segnalatore con tamburo Ø 254x89 RH</i> <i>Wheel brake kit with indicator with drum</i>	

**IMPIANTO LOCKHEED**
LOCKHEED SYSTEM**CON SEGNALATORE**
WITH INDICATOR

KIT REVISIONE FRENI FRONT AND REAR COMPLETE REPAIRING BRAKE SYSTEM SET

Ns. Riferim. Our Ref.	Rif. Costrutt. O.E. Ref.	Descrizione Description	Tipo di veicolo Vehicle Type
964045	-	<i>Kit revisione impianto frenante completo anteriore e posteriore</i>	Daily Restyling 35.8-40.8-35.10 New Daily 35.8-40.8-35.10



**COMPLETO DI:
COMPLETE OF:**



1-500300073
1-500300075
1-1904529
2-7165379
1-1906159
2-40100483



Ns. Riferim. Our Ref.	Rif. Costrutt. O.E. Ref.	Descrizione Description	Tipo di veicolo Vehicle Type
964046	-	<i>Kit revisione impianto frenante completo anteriore e posteriore</i>	New Daily(96) 35.8 Turbo Daily(96) 35.10-49.10 - 35.12-49.12 Daily 2000 35C9-35C11 35C13-50C11



**COMPLETO DI:
COMPLETE OF:**

1-42470842
1-42471111
2-1906401
1-1906403
2-1908407





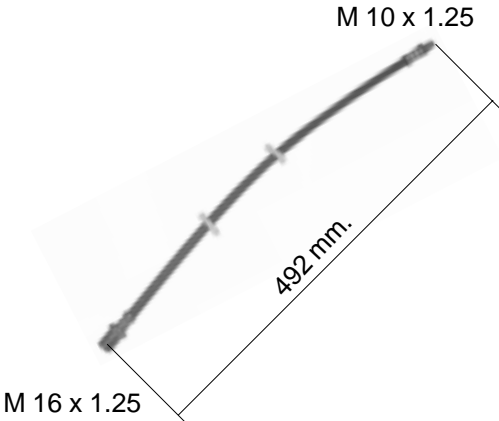
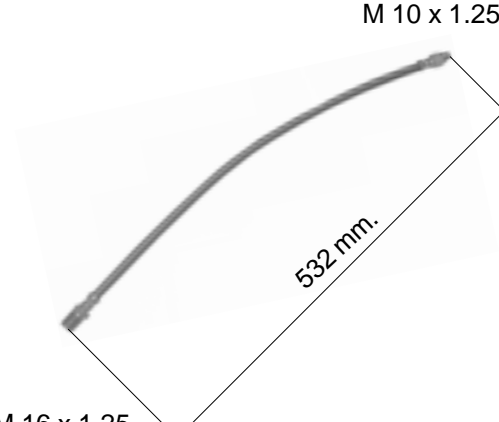
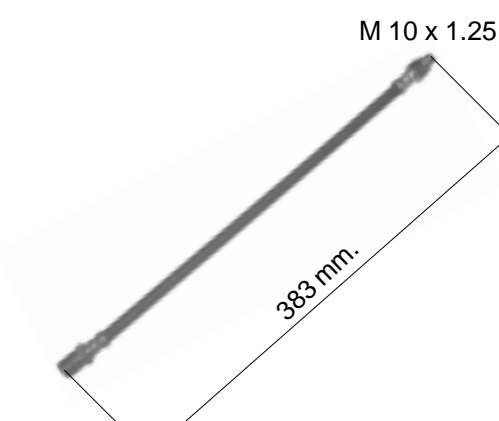
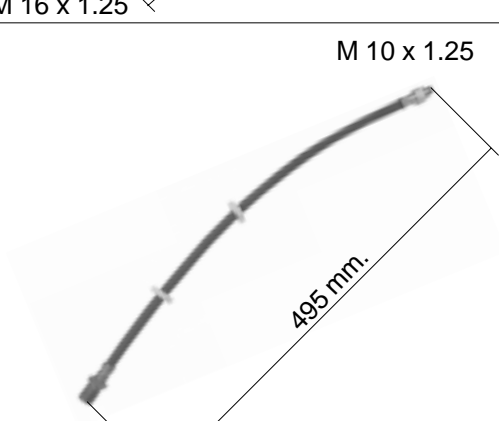

Tipo di materiale Materials type	Ns Riferim. Our Ref.	Rif. Costr. O.E. Ref.	Descrizione/Tipo di veicolo Description/Vehicle Type						
 <p>NITRILE (NBR)</p> <table border="1" data-bbox="84 613 611 719"> <thead> <tr> <th>Ø A mm.</th> <th>Ø B mm.</th> <th>H mm.</th> </tr> </thead> <tbody> <tr> <td>55</td> <td>80</td> <td>10</td> </tr> </tbody> </table>	Ø A mm.	Ø B mm.	H mm.	55	80	10	101400	93804576 (M12011409)	<p><i>Paraolio mozzo anteriore Front wheel hub oil seal</i></p> <p>New Daily 96 30.8-35.8-40.8 New Daily 96 35.10-45.10-49.10 Daily Restyling 30.8-35.8-40.8 Daily Restyling 35.10-45.10-49.10 Turbo Daily 96 35.10-35.12-49.12</p>
Ø A mm.	Ø B mm.	H mm.							
55	80	10							
<p>POLIACRILICO - POLYACRIL (ACM)</p>  <table border="1" data-bbox="84 1335 611 1440"> <thead> <tr> <th>Ø A mm.</th> <th>Ø B mm.</th> <th>H mm.</th> </tr> </thead> <tbody> <tr> <td>70</td> <td>90</td> <td>12</td> </tr> </tbody> </table>	Ø A mm.	Ø B mm.	H mm.	70	90	12	101401	40100483	<p><i>Paraolio mozzo posteriore Rear wheel hub oil seal</i></p> <p>New Daily 96 35.8-35.10 Turbo Daily 96 35.10-35.12 Eurocargo 60E10/E12/E14 65E10/E12/E14 75E12/E14/E15 80-100E15/E18/E21 180E21</p>
Ø A mm.	Ø B mm.	H mm.							
70	90	12							
 <p>VITON - VITON (FPM - FKM)</p> <table border="1" data-bbox="84 1917 611 2022"> <thead> <tr> <th>Ø A mm.</th> <th>Ø B mm.</th> <th>H mm.</th> </tr> </thead> <tbody> <tr> <td>70</td> <td>90</td> <td>13.5 - 14.5</td> </tr> </tbody> </table>	Ø A mm.	Ø B mm.	H mm.	70	90	13.5 - 14.5	101402	40102273	<p><i>Paraolio mozzo posteriore Rear wheel hub oil seal</i></p> <p>New Daily 96 30.8-35.8-35.10 Turbo Daily 96 35.10-35.12 Eurocargo 60E10/E12/E14 65E10/E12/E14 75E12/E14/E15 80-100E15/E18/E21 180E21</p>
Ø A mm.	Ø B mm.	H mm.							
70	90	13.5 - 14.5							





Tipo di materiale Materials type	Ns Riferim. Our Ref.	Rif. Costr. O.E. Ref.	Descrizione/Tipo di veicolo Description/Vehicle Type						
<div style="text-align: center;">  </div> <p>VITON - VITON (FPM - FKM)</p> <table border="1" data-bbox="84 674 611 768"> <thead> <tr> <th>Ø A mm.</th> <th>Ø B mm.</th> <th>H mm.</th> </tr> </thead> <tbody> <tr> <td>70</td> <td>100</td> <td>13.5</td> </tr> </tbody> </table>	Ø A mm.	Ø B mm.	H mm.	70	100	13.5	<p>101518</p>	<p>40102283</p>	<p><i>Paraolio mozzo posteriore interno</i> <i>Rear wheel oil seal hub int.side</i></p> <p>New Daily 35.8-35.10 45.10-49.10</p> <p>Turbo Daily 49.12</p>
Ø A mm.	Ø B mm.	H mm.							
70	100	13.5							
<div style="text-align: center;">  </div> <table border="1" data-bbox="84 1160 611 1254"> <thead> <tr> <th>Ø A mm.</th> <th>Ø B mm.</th> <th>H mm.</th> </tr> </thead> <tbody> <tr> <td>-</td> <td>-</td> <td>-</td> </tr> </tbody> </table>	Ø A mm.	Ø B mm.	H mm.	-	-	-	<p>101612</p>	<p>8870829 42534932</p>	<p><i>Paraolio scatola cambio</i> <i>Gear box oil seal</i></p> <p>Daily City 2000 35S13/S15 - 35C13/C15 50C11/C13/C15 - 65C11/C13/C15</p>
Ø A mm.	Ø B mm.	H mm.							
-	-	-							





Copyright della EMMERRE S.r.l. - Settimo Torinese - Tutti i diritti sono riservati e depositati a norma di legge ed a norma delle convenzioni internazionali. - E' vietata la duplicazione o la riproduzione anche parziale senza la previa autorizzazione della EMMERRE S.r.l.

	Ns Riferim. Our Ref.	Rif. Costr. O.E. Ref.	Descrizione/Tipo di veicolo Description/Vehicle Type
 <p>M 10 x 1.25 492 mm. M 16 x 1.25</p>	972104	93822393 8797513	<p><i>Tube flessibile freno anteriore</i> <i>Front brake pipes</i></p> <p>New Daily (96) 30.8-35.8 Turbo Daily (96) 30.10-35.10-35.12-49.10-49.12</p>
 <p>M 10 x 1.25 532 mm. M 16 x 1.25</p>	972105	8796958	<p><i>Tube flessibile freno anteriore</i> <i>Front brake pipes</i></p> <p>Daily Restyling 30.8-35.8-40.8 - 35.10</p>
 <p>M 10 x 1.25 383 mm. M 16 x 1.25</p>	972107	93822492 8796934	<p><i>Tube flessibile freno posteriore</i> <i>Rear brake pipes</i></p> <p>New Daily (96) 30.8-35.8 Turbo Daily (96) 30.10-35.10-35.12-49.10-49.12</p>
 <p>M 10 x 1.25 495 mm. M 10 x 1.25</p>	972106	8796885	<p><i>Tube flessibile freno posteriore</i> <i>Rear brake pipes</i></p> <p>Daily Restyling 30.8-35.8-40.8 - 35.10</p>

	Ns Riferim. Our Ref.	Rif. Costr. O.E. Ref.	Descrizione/Tipo di veicolo Description/Vehicle Type
 <p>Ø 15.8</p>	964202	8121576	<p><i>Cilindretto freni Dx/Sx Ø 15,8 mm. Brake cylinder right/left</i></p> <p>Daily Restyling 30.8 New Daily 30.8</p>
 <p>Ø 17.4</p>	964201	8121575	<p><i>Cilindretto freni Dx/Sx Ø 17,4 mm. Brake cylinder right/left</i></p> <p>Daily Restyling 30.8 New Daily 35.8 - 35.10</p>
 <p>Ø 19.5</p>	964203	93160540	<p><i>Cilindretto freni Dx/Sx Ø 19,5 mm. Brake cylinder right/left</i></p> <p>Turbodaily 35.12</p>
 <p>Ø 20.6</p>	964211	93155720	<p><i>Cilindretto freni Dx/Sx Impianto Perrot - Perrot System Ø 20,6 mm. Brake cylinder right/left</i></p> <p>Daily Restyling 45.10 - 49.10 New Daily 49.12 Turbodaily 49.12</p>
 <p>Ø 23.8</p>	964204	98452387	<p><i>Cilindretto freni Dx/Sx Ø 23,8 mm. Brake cylinder right/left</i></p> <p>TurboDaily 59.12</p>

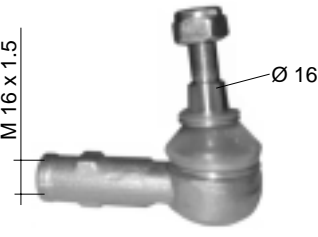
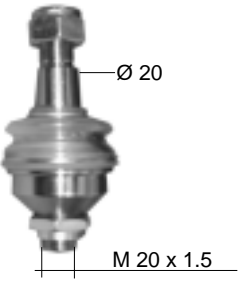

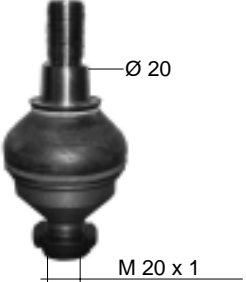

	Ns Riferim. Our Ref.	Rif. Costr. O.E. Ref.	Descrizione/Tipo di veicolo Description/Vehicle Type
	964013	9989017	<i>Pompa freno a flangia ovale</i> <i>Brake pump with oval flange</i> Daily Restyling 30-35-40.8 - 35.10 New Daily 30-35-40.8 - 35.10 Turbodaily 35.12
	964004	-	<i>Pompa freno a flangia quadra</i> <i>(adatt. servofreno 4797460)</i> <i>Brake pump with square flange</i> <i>(adaptable servobrake 4797460)</i> Daily Restyling 45.10 - 49.10
	964031	-	<i>Pompa freno</i> per servofreno 99463713 <i>Brake pump</i> <i>for servo brake 99463713</i> Turbodaily 59.12
	964032	-	<i>Pompa freno</i> per servofreno 99483920 <i>Brake pump</i> <i>for servo brake 99483920</i> Turbodaily 35.8 - 35.10 - 35.12 (05/96) 49.10 - 49.12 (05/96)
	964404	2991743	<i>Pompa freno</i> <i>Brake pump</i> Daily City 2000 35C9 - 35C11 - 35C13
	964033	2991745	<i>Pompa freno servofreno idraulico</i> <i>Rif. 99487840</i> <i>Brake pump for hydraulic servo brake</i> <i>Ref. 99487840</i> Daily City 2000 35S9 - 35S11 - 35S13 - 35S15



	Ns Riferim. Our Ref.	Rif. Costr. O.E. Ref.	Descrizione/Tipo di veicolo Description/Vehicle Type
	964011	4844302	<p>Servofreno completo Brake pump with servo brake</p> <p>Iveco Daily 30.8 - 35.8 - 40.8 35.10 - 40.10</p>
	964003	-	<p>Pompa freno x servofreno (rif. 500374416) Brake pump for servo brake (Ref. 500374416)</p> <p>Iveco Daily 50C11</p>
	964401	4792417	<p>Correttore di frenata Breaking control</p> <p>New Daily 30.8-35.8-40.8 Daily Restyling 35.10-49.10 Turbodaily 59.12 Zeta 50.9-65.9-79.14-95.14-109.14 TurboZeta 60.11-65.12-79.12</p>
	964402	4792418	<p>Correttore di frenata Breaking control</p> <p>New Daily 30.8-35.8-40.8 35.10-45.10-49.10 Daily Restyling 30.8-35.8-40.8 35.10-45.10-49.10 Turbodaily 35.12-49.12</p>

 <p>Lato Dx-Sx - Rh-Lh Side</p>	<p>Ns.Rif. <i>Our Ref.</i></p> <p>954015</p>	<p>Rif.Costr. <i>O.E. Ref.</i></p> <p>1903652 93804059 93800662</p>	<p>Tipo di veicolo <i>Vehicle Type</i></p> <p>DAILY RESTYLING 28.8-30.8-35.8-40.8-35.10-49.10 NEW DAILY 35.8-40.8-35.10-49.10 TURBO DAILY 35.12-49.12</p>
 <p>Lato Dx-Sx - Rh-Lh Side</p>	<p>Ns.Rif. <i>Our Ref.</i></p> <p>954017</p>	<p>Rif.Costr. <i>O.E. Ref.</i></p> <p>93807545</p>	<p>Tipo di veicolo <i>Vehicle Type</i></p> <p>Testa sospensione anteriore completa di ghiera (Front suspension ball joint with nut) DAILY RESTYLING 28.8-30.8-35.8-40.8-35.10-49.10 NEW DAILY 35.8-40.8-35.10-49.10 TURBO DAILY 35.12-49.12</p>
	<p>Ns.Rif. <i>Our Ref.</i></p> <p>954314</p>	<p>Rif.Costr. <i>O.E. Ref.</i></p> <p>93802356</p>	<p>Tipo di veicolo <i>Vehicle Type</i></p> <p>Ghiera per testa sospensione anteriore (rif.93807545) (Nut for front suspension ball joint) (rif.93807545)</p> <p>DAILY RESTYLING 28.8-30.8-35.8-40.8-35.10-49.10 NEW DAILY 35.8-40.8-35.10-49.10 TURBO DAILY 35.12-49.12</p>
 <p>Lato Dx-Sx - Rh-Lh Side</p>	<p>Ns.Rif. <i>Our Ref.</i></p> <p>954020</p>	<p>Rif.Costr. <i>O.E. Ref.</i></p> <p>504212586</p>	<p>Tipo di veicolo <i>Vehicle Type</i></p> <p>Testa sospensione anteriore (Front suspension ball joint with nut) DAILY M.Y. 2006</p>
	<p>Ns.Rif. <i>Our Ref.</i></p> <p>954315</p>	<p>Rif.Costr. <i>O.E. Ref.</i></p> <p>504212925</p>	<p>Tipo di veicolo <i>Vehicle Type</i></p> <p>Ghiera per testa sospensione anteriore (rif. 504212586) (Nut for front suspension ball joint) (rif. 504212586)</p> <p>DAILY M.Y. 2006</p>

 <p>M 20 x 1.5 Ø 20</p> <p>Lato Dx-Sx - Rh-Lh Side</p>	<p>Ns.Rif. Our Ref.</p> <p>954016</p>	<p>Rif.Costr. O.E. Ref.</p> <p>500310933 93802209</p>	<p>Tipo di veicolo Vehicle Type</p> <p>Testa per tirante sospensione anteriore (Drag link front suspension ball joint) DAILY RESTYLING 35.8 NEW DAILY 35.10 TURBO DAILY 35.12</p>
 <p>M 20 x 1.5 Ø 20</p> <p>Lato Dx-Sx - Rh-Lh Side</p>	<p>Ns.Rif. Our Ref.</p> <p>954014</p>	<p>Rif.Costr. O.E. Ref.</p> <p>500337201 8580735</p>	<p>Tipo di veicolo Vehicle Type</p> <p>DAILY RESTYLING 49.10 TURBO DAILY 49.12</p>
 <p>M 16 x 1.5 Ø 18</p> <p>Lato Dx-Sx - Rh-Lh Side</p>	<p>Ns.Rif. Our Ref.</p> <p>954011</p>	<p>Rif.Costr. O.E. Ref.</p> <p>42534911</p>	<p>Tipo di veicolo Vehicle Type</p> <p>DAILY CITY 2000 35S9/S11/S13/S15 35C9/C11/C13/C15 50C11/C13/C15 65C13/C15</p>
	<p>Ns.Rif. Our Ref.</p>	<p>Rif.Costr. O.E. Ref.</p>	<p>Tipo di veicolo Vehicle Type</p>
	<p>Ns.Rif. Our Ref.</p>	<p>Rif.Costr. O.E. Ref.</p>	<p>Tipo di veicolo Vehicle Type</p>

	Ns Riferim. Our Ref.	Rif. Costr. O.E. Ref.	Descrizione/Tipo di veicolo Description/Vehicle Type
	954305	500383975	<p>Testa a snodo DX Steering joint</p> <p>Daily City 2000 35S9/S11/S12/S13/S15</p>
	954306	500383976	<p>Testa a snodo SX Steering joint</p> <p>Daily City 2000 35S9/S11/S12/S13/S15</p>

	Ns Riferim. Our Ref.	Rif. Costr. O.E. Ref.	Descrizione/Tipo di veicolo Description/Vehicle Type
 <p>Ø 18</p> <p>Lunghezza - Lenght mm.420</p>	953033	93802065	DAILY RESTYLING 30.8 - 35.8 - 40.8
 <p>Ø 18</p> <p>Lunghezza - Lenght mm.400</p>	953034	8585982	DAILY RESTYLING 30.8 - 35.8 - 40.8 35.10 - 49.10
 <p>Ø 18</p> <p>Lunghezza - Lenght mm.390</p>	953030	93812112	NEW DAILY 30.8 - 35.8 - 40.8 35.10 - 49.10
 <p>Ø 18</p> <p>Lunghezza - Lenght mm.350</p>	953032	93802399	DAILY RESTYLING 30.8 - 35.8 - 40.8 35.10 - 49.10 NEW DAILY 35.10 - 49.10 TURBO DAILY 35.12 - 49.12

	Ns Riferim. Our Ref.	Rif. Costr. O.E. Ref.	Descrizione/Tipo di veicolo Description/Vehicle Type
 <p>Ø 17,5</p> <p>Ø 17,5</p> <p>Lunghezza mm.80</p>	953052	93806199	DAILY RESTYLING NEW DAILY TURBO DAILY
	103628	93803481	<i>Supporto albero sterzo</i> <i>(Steering shaft support)</i> NEW DAILY (96) DAILY RESTYLING TURBODAILY (96)
	953016	93806182	<i>Giunto elastico albero sterzo</i> <i>(Steering shaft flexible coupling)</i> NEW DAILY (96) DAILY RESTYLING TURBODAILY (96)

Ns. Riferimento <i>Ns. Ref.</i>	Rif. OE <i>OE Ref.</i>	Descrizione <i>Description</i>
908180	93807553	<i>Traversa sospensione anteriore</i> <i>Suspension gross member</i> NEW DAILY (96) 35.8-40.8-35.10-45.10-49.10 TURBODAILY (96) 35.10-49.10-35.12-49.12



Illustrazione - Illustration



Ns. Riferimento <i>Ns. Ref.</i>	Rif. OE <i>OE Ref.</i>	Descrizione <i>Description</i>
908181	93824293	<i>Traversa sospensione anteriore</i> <i>Suspension gross member</i> TURBODAILY (96) 59.12

Illustrazione - Illustration



	Ns Riferim. Our Ref.	Rif. Costr. O.E. Ref.	Descrizione/Tipo di veicolo Description/Vehicle Type
	908182	-	<p><i>Kit revisione traversa (rif. 93807553)</i> <i>composto da:</i> <i>Kit repair cross arm composed by:</i></p> <p>93807640 <i>Boccola inferiore</i> Pz. 6 93803299 <i>Tampone</i> Pz. 2 93810239 <i>Boccola barra</i> Pz. 2 93807567 <i>Supporto balestra</i> Pz. 2</p> <p>New Daily '96 35.8-40.8-35.10-45.10-49.10 Turbodaily '96 35.10-49.10-35.12-49.12</p>
	908183	-	<p><i>Kit revisione traversa (rif. 500350345)</i> <i>composto da:</i> <i>Kit repair cross arm composed by:</i></p> <p>500350342 <i>Boccola inferiore</i> Pz. 6 500350343 <i>Boccola superiore</i> Pz. 2 93810239 <i>Boccola barra</i> Pz. 2 93803299 <i>Tampone</i> Pz. 2 93807567 <i>Supporto balestra</i> Pz. 2</p> <p>Daily City 2000 65C11/C13/C15</p>

BARRE DI TORSIONE TORSION BARS

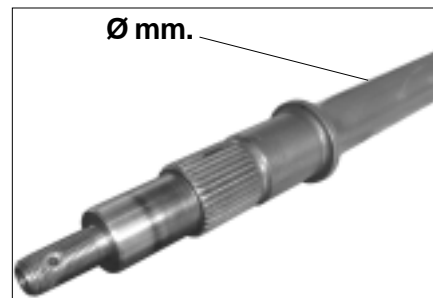

Ns.Rif. Our Ref.	Rif.Costr. O.E. Ref.	Descrizione Description	Ø mm. Ø mm.	Tipo di applicazione Application type
963562	93811176	Barra di torsione Torsion bar DX	Ø 27,50 mm.	NEW DAILY (96) 30.8 - 35.8 - 40.8 - 35.10 TURBODAILY (96) 35.10 - 35.12
963561	93811175	Barra di torsione Torsion bar SX	Ø 27,50 mm.	
963564	93812734	Barra di torsione Torsion bar DX	Ø 29,00 mm.	NEW DAILY (96) 30.8 - 35.8 - 40.8 35.10 - 45.10 - 49.10 TURBODAILY (96) 35.10 - 49.10 - 35.12 - 49.12 DAILY CITY 2000 35C9/C11/C13/C15 - 35C10/C12 50C11/C13/C15
963563	93812733	Barra di torsione Torsion bar SX	Ø 29,00 mm.	
963565	93810228	Barra di torsione Torsion bar DX	Ø 31,00 mm.	NEW DAILY (96) 49.10 TURBODAILY (96) 49.12 - 59.12
963566	93810229	Barra di torsione Torsion bar SX	Ø 31,00 mm.	
963568	60170736	Barra di torsione Torsion bar DX	Ø 33,00 mm.	DAILY CITY 2000 65C13 - 65C15
963567	60170737	Barra di torsione Torsion bar SX	Ø 33,00 mm.	

Ns. Riferimento Ns. Ref.	Rif. OE OE Ref.	Descrizione Description
973235	500379801 500344888-42551296	Braccio oscillante sospensione superiore Sx Upper swing arm suspension Right
973236	500379802 500344887-42551297	Braccio oscillante sospensione superiore Dx Upper swing arm suspension Left

Illustrazione Illustration	Tipo di veicolo Vehicle Type
-------------------------------	---------------------------------





 <p>BRACCIO SOSPENSIONE SUPERIORE UPPER SWING ARM SUSPENSION</p>	<p>DAILY CITY 2000 35S9/S11/S13/S15 35C9/C11/C13/C15 35S10/S12 35C10/C12</p> <p>DAILY 2006 35C10/C12/C15</p>
---	--

Ns. Riferimento Ns. Ref.	Rif. OE OE Ref.	Descrizione Description
973237	500334716 500334486-42551289	Braccio oscillante sospensione inferiore Dx Lower swing arm suspension Right
973238	500334717 500334487-42551290	Braccio oscillante sospensione inferiore Sx Lower swing arm suspension Left

Illustrazione Illustration	Tipo di veicolo Vehicle Type
-------------------------------	---------------------------------

 <p>BRACCIO SOSPENSIONE INFERIORE LOWER SWING ARM SUSPENSION</p>	<p>DAILY CITY 2000 35S9/S11/S13/S15 35C9/C11/C13/C15 35S10/S12 35C10/C12</p> <p>DAILY 2006 35C10/C12/C15</p>
--	--

	Ns Riferim. Our Ref.	Rif. Costr. O.E. Ref.	Descrizione/Tipo di veicolo Description/Vehicle Type
	<p>973242</p>	<p>-</p>	<p><i>Kit revisione bracci sospensione superiori (rif. 500379801/9802) composto da:</i> <i>Repairing set for upper swing arm suspension composed by:</i></p> <p>504039506 Pz. 4 500339201 Pz. 2 973252 Pz. 1 Daily City 2000</p>
	<p>973243</p>	<p>-</p>	<p><i>Kit revisione bracci sospensione inferiori (rif. 500334716/4717) composto da:</i> <i>Repairing kit for upper swing arm suspension composed by:</i></p> <p>504039506 Pz. 4 500339201 Pz. 2 973251 Pz. 1 Daily City 2000</p>







	Ns Riferim. Our Ref.	Rif. Costr. O.E. Ref.	Descrizione/Tipo di veicolo Description/Vehicle Type
	973250	504039506	<i>Silentblock braccio oscillante superiore ed inferiore</i> <i>Swing arm silentblock</i> DAILY CITY 2000 35S9/S11/S13/S15 35C9/C11/C13/C15 35S10/S12 35C10/C12
	973252	-	<i>Testina articolazione Dx-Sx per revisione bracci oscillanti</i> <i>ref. 500379801 - 500379802</i> <i>Head joint right - left for swing arm suspension</i> <i>ref. 500379801 - 500379802</i> DAILY CITY 2000 35S9/S11/S13/S15 35C9/C11/C13/C15 35S10/S12 35C10/C12
	973251	-	<i>Testina articolazione Dx-Sx per revisione bracci oscillanti</i> <i>ref. 500334716-500334717</i> <i>Head joint right - left for swing arm suspension</i> <i>ref. 500334716-500334717</i> DAILY CITY 2000 35S9/S11/S13/S15 35C9/C11/C13/C15 35S10/S12 35C10/C12
	963621	500315608	<i>Barra di torsione superiore</i> <i>Upper torsion bar</i> Daily City 2000 35S9/S11/S12/S13/S15

	Ns Riferim. Our Ref.	Rif. Costr. O.E. Ref.	Descrizione/Tipo di veicolo Description/Vehicle Type
	954310	93804572	<i>Fuso a snodo DX</i> <i>Stub axle</i> New Daily Daily Restyling Turbodaily
	954311	93804573	<i>Fuso a snodo SX</i> <i>Stub axle</i> New Daily Daily Restyling Turbodaily
	954312	93801772	<i>Leva fuso snodo DX</i> <i>Stub axle lever</i> New Daily Daily Restyling Turbodaily
	954313	93801773	<i>Leva fuso snodo SX</i> <i>Stub axle lever</i> New Daily Daily Restyling Turbodaily

	Ns Riferim. Our Ref.	Rif. Costr. O.E. Ref.	Descrizione/Tipo di veicolo Description/Vehicle Type
	973146	93822444	<i>Tirante filettato inferiore</i> <i>Lower threaded tie rod</i> DAILY 30.8-35.8-40.8 NEW DAILY '96 35-45.10 - 35-49.12
	973147	93822441	<i>Tirante filettato superiore</i> <i>Upper threaded tie rod</i> DAILY 30.8-35.8-40.8 NEW DAILY '96 35-45.10 - 35-49.12
	973144	504207331	<i>Tirante filettato inferiore</i> <i>Lower threaded tie rod</i> DAILY 65C18
	973145	93810223	<i>Tirante filettato superiore</i> <i>Upper threaded tie rod</i> DAILY 65C11-C13-C15-C18 DAILY 59.12 ('96)

	Ns Riferim. Our Ref.	Rif. Costr. O.E. Ref.	Descrizione/Tipo di veicolo Description/Vehicle Type
	973239	93807566	<i>Braccio oscillante sospensione anteriore (superiore)</i> <i>Front swing arm suspension (upper)</i> New Daily Turbodaily
	973249	93810157	<i>Braccio oscillante sospensione superiore DX-SX</i> <i>Upper front swing arm right-left</i> NEWDAILY 96 35.8/10 - 49.10 TURBODAILY 35.12/49.12 DAILY CITY 2000 35C9/C11/C13/C15 50C11/C13/C15
	973142	504207327	<i>Braccio oscillante superiore SX</i> <i>Upper swing arm suspension LH</i> DAILY 65C18
	973143	504213051	<i>Braccio oscillante superiore DX</i> <i>Upper swing arm suspension RH</i> DAILY 65C18

	Ns Riferim. Our Ref.	Rif. Costr. O.E. Ref.	Descrizione/Tipo di veicolo Description/Vehicle Type
	973131	93815026	Braccio oscillante sospensione superiore SX Upper swing arm Left
	973158	93815025	Braccio oscillante sospensione superiore DX Upper swing arm Right TURBODAILY 59.12 NEWDAILY 96 35.8/10 - 49.10 - 35.12 - 49.12 DAILY CITY 2000 35C9/C10/C11/C12/C13/C15 50C11/C13/C15
	973240	8574229	Braccio oscillante sospensione anteriore inferiore Lower swing arm suspension New Daily Daily Restyling Turbodaily
	973140	504207328	Braccio oscillante sospensione inferiore SX Lower swing arm suspension LH
	973141	504207329	Braccio oscillante sospensione inferiore DX Lower swing arm suspension RH DAILY 65C18

Ns. Riferimento Ns. Ref.	Tipo applicazione Application type	Pompa acqua completa Complete water pump
907169	Daily Restyling 30.8-35.8-40.8 - 35.10	
Rif. Costruttore OE. Ref.	NewDaily 30.8-35.8-40.8 - 35.10-49.10	
99440728 (ex. 99440726 - 7303009)		
Tipo motore Engine type		
Ns. Riferimento Ns. Ref.	Tipo applicazione Application type	Pompa acqua completa Complete water pump
907147	Daily Restyling 35.10 - 49.10	
Rif. Costruttore OE. Ref.		
2995627 99459755 (ex. 7303056)		
Tipo motore Engine type		
Ns. Riferimento Ns. Ref.	Tipo applicazione Application type	Pompa acqua completa Complete water pump
907170	NewDaily 30.8-35.8-40.8 - 35.10-49.10	
Rif. Costruttore OE. Ref.	TurboDaily 35.12 - 49.12 - 59.12	
2995629 99459757 (ex. 98435994)		
Tipo motore Engine type		

**Ns. Riferimento
Ns. Ref.**

907186

**Rif. Costruttore
OE. Ref.**

500361919
500361203
(ex. 500300476 - 99438900)

**Tipo motore
Engine type**

**Tipo applicazione
Application type**

NewDaily 1996
30.8-35.8-40.8 - 35.10 - 49.10
TurboDaily 1996
35.12 - 49.12 - 59.12

**Pompa acqua completa
Complete water pump**



**Ns. Riferimento
Ns. Ref.**

907185

**Rif. Costruttore
OE. Ref.**

500362859
(ex. 99479817)

**Tipo motore
Engine type**

**Tipo applicazione
Application type**

Daily City 2000
35S9/S11/S13/S15
35C9/C11/C13/C15
50C11/C13/C15
65C13/C15

**Pompa acqua completa
Complete water pump**



**Ns. Riferimento
Ns. Ref.**

907193

**Rif. Costruttore
OE. Ref.**

500362834

**Tipo motore
Engine type**

**Tipo applicazione
Application type**

Daily City 2000
35S9/S11/S13/S15
35C9/C11/C13/C15
50C11/C13/C15
65C13/C15

**Pompa acqua completa
Complete water pump**



Ns. Riferimento Ns. Ref.	Tipo applicazione Application type	<i>Pompa acqua Water pump</i> 
907140	Daily M.Y. 2006 29L10 / L12 / L14 35C10 / C12 35S10 / S12 / S14 40C10 / C12 / C14	
Rif. Costruttore OE. Ref.	504033770	
Tipo motore Engine type		

Ns. Riferimento Ns. Ref.	Tipo applicazione Application type	<i>Pompa acqua Water pump</i> 
907243	Daily M.Y. 2006 (MATERIALE IN GHISA (CAST IRON MATERIAL)) 35C15 / C18 40C15 / C18 45C15 / C18 50C15 / C18 60C15 / C18 65C15 / C18	
Rif. Costruttore OE. Ref.	504113544	
Tipo motore Engine type		

Ns. Riferimento Ns. Ref.	Tipo applicazione Application type	<i>Pompa acqua Water pump</i> 
907174	Daily M.Y. 2006 (MATERIALE IN ALLUMINIO (ALLUMINIUM MATERIAL)) 35C15 / C18 40C15 / C18 45C15 / C18 50C15 / C18 60C15 / C18 65C15 / C18	
Rif. Costruttore OE. Ref.	504087367	
Tipo motore Engine type		

Illustrazione <i>Illustration</i>	Ns.Rif. <i>Our Ref.</i>	Rif.Costr. <i>O.E. Ref.</i>	Descrizione <i>Description</i>	Tipo di veicolo <i>Vehicle Type</i>
	907213	4713940	Ventilatore aria nylon (6 pale) Nylon blower (6 blade)	DAILY RESTYLING 30.8 - 35.8 - 40.8
	907214	8586706	Ventilatore aria nylon (7 pale) Nylon blower (7 blade)	DAILY RESTYLING 30-35-40.8 - 35-45-49.10 NEW DAILY 30-35-40.8 - 35-45-49.10
	907220	93813264	Ventilatore aria nylon (7 pale) (elettroventola) Nylon blower (7 blade)	NEW DAILY 30-35-40.8 - 35-45-49.10 TURBODAILY 30-35.10 - 35-49-59.12
	907228	93811590	Ventilatore aria nylon (7 pale) (elettroventola) Nylon blower (7blade)	NEW DAILY 30-35.8 - 35.10 TURBODAILY 30-35-49.10 - 35-49-59.12

Illustrazione <i>Illustration</i>	Ns.Rif. <i>Our Ref.</i>	Rif.Costr. <i>O.E. Ref.</i>	Descrizione <i>Description</i>	Tipo di veicolo <i>Vehicle Type</i>
 <p>Ø 86 mm</p> <p>Ø 385 mm</p>	907235	504024647 500333136	Ventilatore aria nylon (12 pale) Nylon blower (12 blade)	DAILY CITY 2000 35C9/C11/C13/C15 35S9/S10/S11/S12/S13/S15 50C11 65C11
 <p>Ø 86 mm</p> <p>Ø 420 mm</p>	907225	504154349	Ventilatore aria nylon (9 pale) Nylon blower (9 blade)	DAILY 2006 M.Y. 35C14/C16/C18



Illustrazione <i>Illustration</i>	Ns.Rif. <i>Our Ref.</i>	Rif.Costr. <i>O.E. Ref.</i>	Descrizione <i>Description</i>	Tipo di veicolo <i>Vehicle Type</i>
	906926	1907918	Radiatore acqua (ex 93809326 - 93814567) Water radiator	NEW DAILY 30-35-40.8 - 35-45-49.10
	906929	93818439	Radiatore acqua Water radiator	NEW DAILY 96 35.8 - 35.10 TURBO DAILY 96 35.10/12 - 49.10/12 - 59.12
	906930	93817393	Intercooler Intercooler	DAILY 35.10 - 49.10 TURBO DAILY 35.12 - 49.12 - 59.12
	906931	93809190	Convogliatore aria Air Hood	NEW DAILY 30.8 - 35.8 - 40.8 35.10 - 45.10 - 49.10

Illustrazione <i>Illustration</i>	Ns.Rif. <i>Our Ref.</i>	Rif.Costr. <i>O.E. Ref.</i>	Descrizione <i>Description</i>	Tipo di veicolo <i>Vehicle Type</i>
	906927	93813747	Radiatore acqua Water radiator	NEW DAILY 35.10-49.10 TURBODAILY 35.12 - 49.12 - 59.12
	906928	500396428	Radiatore acqua Water radiator	DAILY CITY 2000 35S9/S11/S13/S15 35C9/C11/C15/C18 50C11/C13/C15
	906932	500396429	Radiatore acqua Water radiator	DAILY CITY 2000 35S9/S11/S13/S15 35C9/C11/C15/C18 50C11/C13/C15 65C13/C15
	906925	504045487	Radiatore acqua Water radiator	DAILY CITY 2000 35S9 / S11 35C11 MOTORI / ENGINES: 29L10V - 35S10V - 2.3 TD

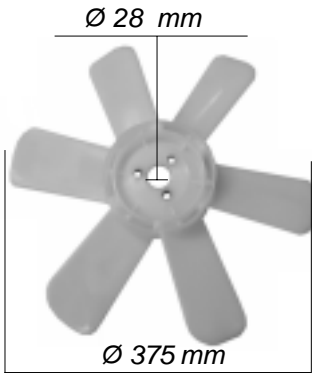
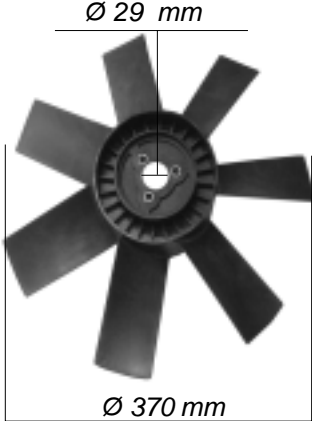
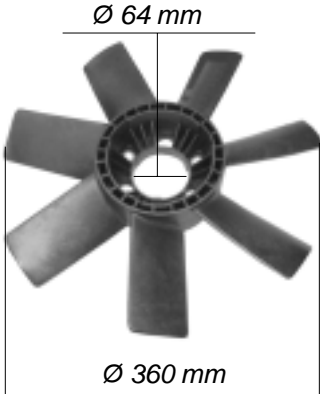
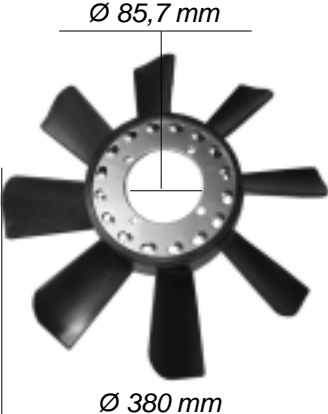

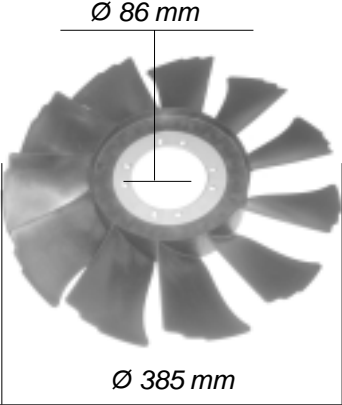
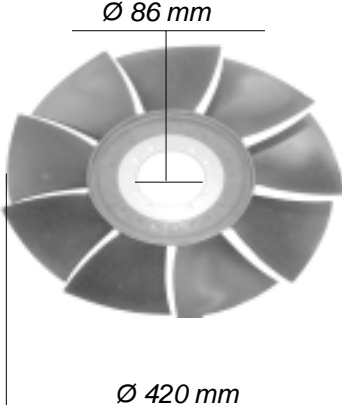
Illustrazione <i>Illustration</i>	Ns.Rif. <i>Our Ref.</i>	Rif.Costr. <i>O.E. Ref.</i>	Descrizione <i>Description</i>	Tipo di veicolo <i>Vehicle Type</i>
	906934	504008108	Radiatore acqua Water radiator	DAILY CITY 2000 29L11 - L9 35S11/C11 35S9-C9 50C11
	906907	99487905	Radiatore Radiator	DAILY CITY 2000 29L11 - L9 35S11/C11 35S9-C9 50C11 MOTORI / ENGINES: 29L11 - 35C11/35S11 50C 2.8TD
	906933	504084141	Radiatore acqua Water radiator	DAILY 2006 M.Y. 35C14/C16/C18
	906924	504152996	Radiatore acqua Water radiator	DAILY 2006 M.Y. MOTORI - ENGINES: 3.0C14 F1A EURO4



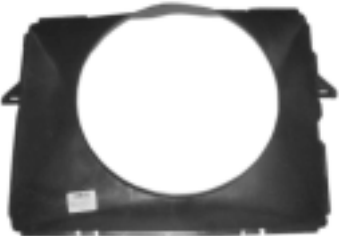

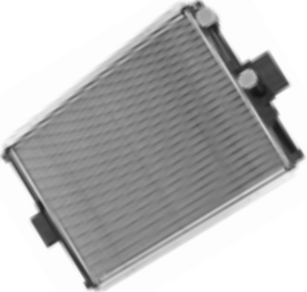
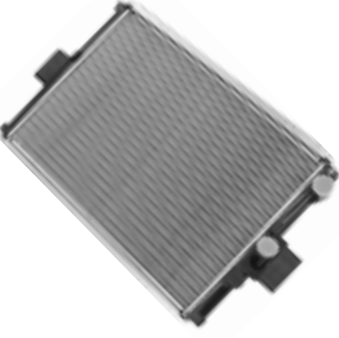
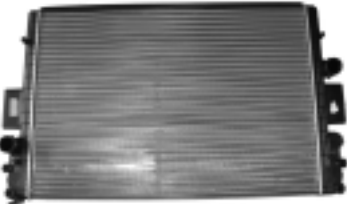
Illustrazione <i>Illustration</i>	Ns.Rif. <i>Our Ref.</i>	Rif.Costr. <i>O.E. Ref.</i>	Descrizione <i>Description</i>	Tipo di veicolo <i>Vehicle Type</i>
	906920	42530250	Rubinetto riscaldamento Heating tap	NEW DAILY 30.8 - 40.10 DAILY CITY 2000
	906908	93930693	Riscaldatore ventilatore completo	DAILY T.T. fino a 1996
	906878	93930676	Radiatore riscaldamento	DAILY T.T. fino a 1996
	906909	93930687	Ventilatore riscaldamento	DAILY T.T. fino a 1996

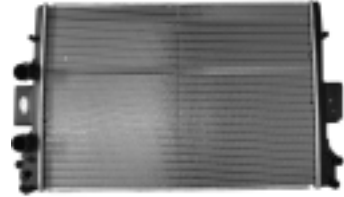
Illustrazione <i>Illustration</i>	Ns.Rif. <i>Our Ref.</i>	Rif.Costr. <i>O.E. Ref.</i>	Descrizione <i>Description</i>	Tipo di veicolo <i>Vehicle Type</i>
	906190	93902290	Serbatoio recupero acqua OE Water tank OE	DAILY 35.8 - 35.10
	907099	-	(1) Tappo vaschetta acqua Lock plug	TURBODAILY 35.10 - 35.12 (>1994)
	907130	-	(2) Tappo vaschetta acqua Lock plug	DAILY 30.8 - 35.8 TURBODAILY 35.10 - 40.10 35.12 - 49.12 - 59.12
	907254	7301254	Coperchio termostato Thermostat cover	DAILY RESTYLING 30-35-40.8 - 35-45-49.10 NEW DAILY 30-35-40.8 TURBODAILY 30-35-49.10 - 35-49-59.12
	907100	4809019	Termostato apertura 74° C Thermostat 74° C	DAILY 28-30-35-40.8 (1°serie)
	907104	98463638 4703088 4809509	Termostato apertura 79° C Thermostat 79° C	DAILY 30.8-35.8 NEW DAILY 35.10-49.10 TURBODAILY 35.10-45.10 ZETA 50.8-50.9-60.8 EUROCARGO 135E18 - 170E18 - 180E18 RENAULT MASTER - TRAFIC
	907126	98463637 4837166	Termostato apertura 79° C Thermostat 79° C	NEW DAILY 30-35-40.8 - 35-45-49.10 TURBODAILY 30.10-35.12-49.12-59.12 NEW DAILY 96 30-35.8 - 30-40-45-49.10 35-49-59.12 DAILY CITY 2000 35S9 - 35C9 FIAT DUCATO RENAULT MASTER - TRAFIC

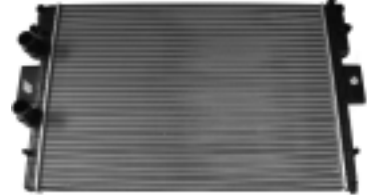

Illustrazione <i>Illustration</i>	Ns.Rif. <i>Our Ref.</i>	Rif.Costr. <i>O.E. Ref.</i>	Descrizione <i>Description</i>	Tipo di veicolo <i>Vehicle Type</i>
 	<p>907246</p> <p>907247</p>	<p>500345688 4828059</p> <p>500345691 500302581</p>	<p>Corpo portatermostato Thermostat cover</p> <p>Corpo portatermostato Thermostat cover</p>	<p>NEW DAILY DAILY RESTYLING TURBODAILY DAILY CITY 2000 35S11 - 35C11 - 50C11</p> <p>NEW DAILY TURBODAILY</p>

Illustrazione Illustration	Ns.Rif. Our Ref.	Rif.Costr. O.E. Ref.	Descrizione Description	Tipo di veicolo Vehicle Type
	907092 907094 - -	- 7302296 17278581 16866173	Kit tubetto al termostato in nylon composto da: Nylon thermostat threaded union kit composed by: Tubetto al termostato q.tà 1 Anello OR q.tà 4 Anello seeger q.tà 2	DAILY RESTYLING 30.8 - 35.8 - 40.8
	907019 - - -	- - 17278581 16866173	Kit tubetto al termostato (Ns modifica in alluminio) (sostituisce/replace 4279604) composto da: Aluminium thermostat threaded union kit Our modification composed by: Tubetto modificato q.tà 1 Anello OR q.tà 4 Anello seeger q.tà 2	DAILY RESTYLING 30.8 - 35.8 - 40.8
	907091 907095 - -	- 4697947 17278581 16866173	Kit tubetto al termostato in nylon composto da: Nylon thermostat threaded union kit composed by: Tubetto al termostato q.tà 1 Anello OR q.tà 4 Anello seeger q.tà 2	DAILY RESTYLING 35.10 - 45.10 - 49.10 NEW DAILY 30-35-40.8 - 35-45-49.10 TURBODAILY 35.12 - 49.12 - 59.12 DAILY 2000 35S9 - 35C9
	907020 - - -	- - 17278581 16866173	Kit tubetto al termostato (Ns modifica in alluminio) (sostituisce/replace 4697947) composto da: Aluminium thermostat threaded union kit Our modification composed by: Tubetto modificato q.tà 1 Anello OR q.tà 4 Anello seeger q.tà 2	DAILY RESTYLING 35.10 - 45.10 - 49.10 NEW DAILY 30-35-40.8 - 35-45-49.10 TURBODAILY 35.12 - 49.12 - 59.12 DAILY 2000 35S9 - 35C9

Illustrazione <i>Illustration</i>	Ns.Rif. <i>Our Ref.</i>	Rif.Costr. <i>O.E. Ref.</i>	Descrizione <i>Description</i>	Tipo di veicolo <i>Vehicle Type</i>
	907034 907035 - -	- 99443808 17278581 16866173	Kit tubetto al termostato composto da: Thermostat threaded union kit composed by: Tubetto al term. q.tà 1 Anello OR q.tà 4 Anello seeger q.tà 2	DAILY CITY 2000 35S9/S11/S13/S15 35C9/C11/C13/C15 50C11/C13/C15 65C13/C15
	907035	99443808	Tubetto al termostato Thermostat threaded	DAILY CITY 2000 35S9/S11/S13/S15 35C9/C11/C13/C15 50C11/C13/C15 65C13/C15





Illustrazione <i>Illustration</i>	Ns.Rif. <i>Our Ref.</i>	Rif.Costr. <i>O.E. Ref.</i>	Descrizione <i>Description</i>	Tipo di veicolo <i>Vehicle Type</i>
	907054	500326396	Tubo acqua Water pipe	DAILY CITY 2000 35S9/S11/S13/S15 35C9/C11/C13/C15 50C11/C13/C15 65C13/C15
	907055	4837163	Tubo acqua Water pipe	NEW DAILY 30.8 - 35.8 - 40.8
	907059	99443658	Tubo acqua Water pipe	NEW DAILY 30.8 - 35.8
	907062	99482735	Tubo acqua Water pipe	NEW DAILY 30.8 - 35.8 TURBODAILY 35.12



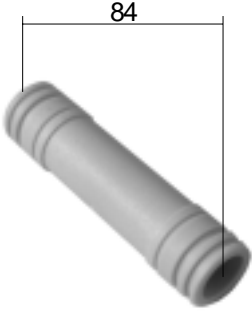



Illustrazione <i>Illustration</i>	Ns.Rif. <i>Our Ref.</i>	Rif.Costr. <i>O.E. Ref.</i>	Descrizione <i>Description</i>	Tipo di veicolo <i>Vehicle Type</i>
	907048	93805975	Tubo acqua Water pipe	DAILY RESTYLING 30.8 - 35.8 - 40.8
	907032	98410628	Tubo acqua Water pipe	NEW DAILY 30.8 - 35.8 - 40.8
	907033	7302947	Tubo acqua Water pipe	DAILY RESTYLING 35.10 - 45.10 - 49.10
	907060	98467958	Tubo acqua Water pipe	NEW DAILY 35.10 - 45.10 - 49.10 TURBODAILY 35.12 - 49.12 - 59.12

Illustrazione <i>Illustration</i>	Ns.Rif. <i>Our Ref.</i>	Rif.Costr. <i>O.E. Ref.</i>	Descrizione <i>Description</i>	Tipo di veicolo <i>Vehicle Type</i>
	907063	99457054	Tubo acqua Waterpipe	TURBODAILY 30.10 - 35.10 - 49.10 35.12 - 49.12 - 59.12
	907042	98434054	Tubo acqua Waterpipe	DAILY TURBODAILY

Ns. Riferimento
Ns. Ref.**101037**Rif. Costruttore
OE. Ref.

42470849

Applicazione
ApplicationDescrizione - Tipo di applicazione
Description - Application type

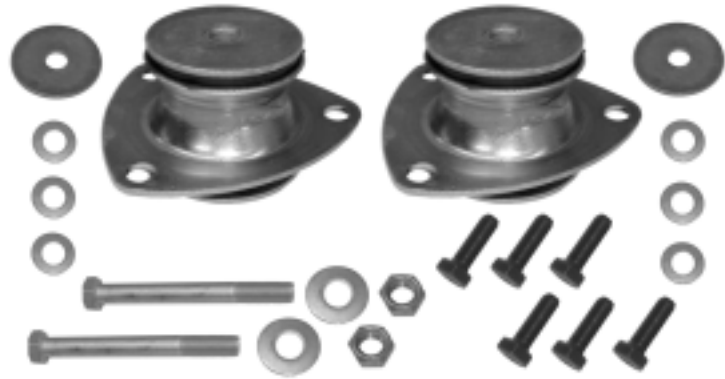
DAILY CITY 2000
35S9/S11/S13/S15
35C9/C11/C13/C15
35S10/S12
35C10/C12
50C11/C13/C15

KIT TASSELLI CABINA ANTERIORE
FRONT CABIN KIT DOWELS

Ns. Riferimento
Ns. Ref.**101038**Rif. Costruttore
OE. Ref.

42470850

Applicazione
ApplicationDescrizione - Tipo di applicazione
Description - Application type

DAILY CITY 2000
35S9/S11/S13/S15
35C9/C11/C13/C15
35S10/S12
35C10/C12
50C11/C13/C15
65C11/C13/C15

KIT TASSELLI CABINA POSTERIORE
REAR CABIN KIT DOWELS

	Ns Riferim. Our Ref.	Rif. Costr. O.E. Ref.	Descrizione/Tipo di veicolo Description/Vehicle Type
	101041	42471164	<p><i>Serie tasselli attacco anteriore cabina</i> <i>Front dowels set anchoring cabin</i></p> <p>Daily City 2000 65C13/C15</p>
	101042	42471165	<p><i>Serie tasselli attacco anteriore cabina</i> <i>Front dowels set anchoring cabin</i></p> <p>Daily City 2000 65C11/C13/C15</p>
	101043	42536919 42546400	<p><i>Serie tasselli attacco anteriore cabina</i> <i>Front dowels set anchoring cabin</i></p> <p>Daily City 2000 35S9/S11/S13/S15 35C9/C11/C13/C15 50C11/C13/C15</p>



Illustrazione <i>Illustration</i>	Ns.Rif. <i>Our Ref.</i>	Rif.Costr. <i>O.E. Ref.</i>	Descrizione <i>Description</i>	Tipo di veicolo <i>Vehicle Type</i>								
 <p>A = Ø esterno B = Ø interno</p> <p>Z = Numero di denti</p> <p>H = Spessore</p>	901153	4279804	Corona volano <i>Flywheel rim</i> <table border="1" data-bbox="754 504 1129 582"> <thead> <tr> <th>A</th> <th>B</th> <th>H</th> <th>Z</th> </tr> </thead> <tbody> <tr> <td>335</td> <td>306</td> <td>12</td> <td>119</td> </tr> </tbody> </table>	A	B	H	Z	335	306	12	119	DAILY RESTYLING 30-35-40.8 - 35-45-49.10 NEW DAILY 30-35-40.8 - 35-45-49.10 TURBODAILY 30.10-49.10 - 35-49-59.12 DAILY 2000 35S9/S11/S13 50C11/C13/C15 - 65C13/C15
A	B	H	Z									
335	306	12	119									
	906117	93827837 93811555 93825912	Filtro aria motore completo <i>Complete engine air filter</i>	NEW DAILY TURBODAILY								
	913000	98420643	Coppa olio motore <i>Engine oil sump</i>	NEW DAILY 30.8-35.8-40.8-35.10 45.10-49.10 TURBODAILY 35.12-49.12-59.12 (ANNO1996)								

Illustrazione <i>Illustration</i>	Ns.Rif. <i>Our Ref.</i>	Rif.Costr. <i>O.E. Ref.</i>	Descrizione <i>Description</i>	Tipo di veicolo <i>Vehicle Type</i>
	906110	7301484	Sfiato olio motore <i>Engine oil breather</i>	DAILY RESTYLING 30-35-40.8 - 35-45-49.10 NEW DAILY 30-35-40.8 - 35-45-49.10 TURBODAILY 30.10
	906245	99441839	Sfiato olio motore <i>Engine oil breather</i>	NEW DAILY 30-35-40.8 - 35-45-49.10
	906116	500302200	Sfiato olio motore in plastica <i>Engine plastic oil breather</i>	NEW DAILY TURBODAILY



906108 - Kit modifica sfiato olio motore
Engine oil breather modification kit

DAILY RESTYLING 35.10-49.10 - NEW DAILY 35.10-49.10 - TURBODAILY 35.12-49.12-59.12

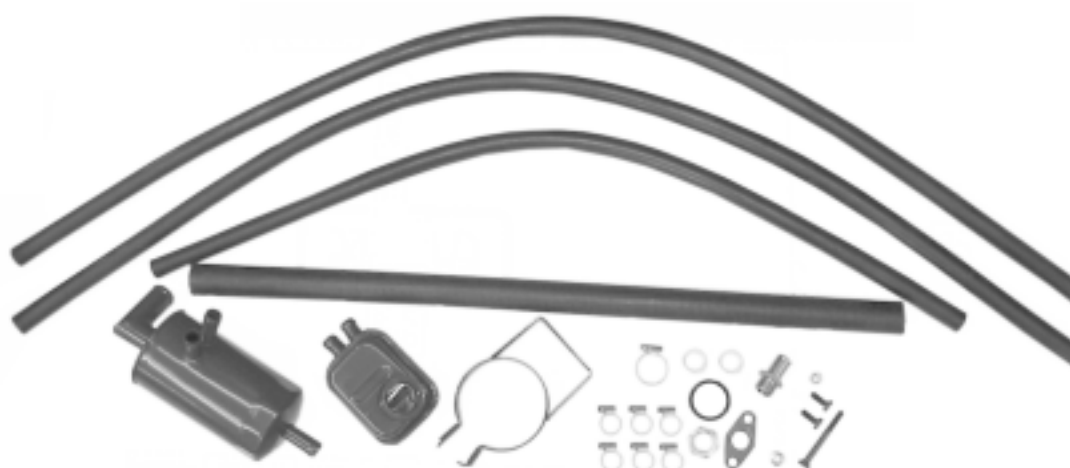
Illustrazione <i>Illustration</i>	Ns.Rif. <i>Our Ref.</i>	Rif.Costr. <i>O.E. Ref.</i>	Descrizione <i>Description</i>	Tipo di veicolo <i>Vehicle Type</i>
	901220	7303414	Cinghia distribuzione DAYCO 152 denti RH 300 <i>Timing belt (152 teeth)</i>	DAILY RESTYLING 30.8-35.8-40.8
	901224	99456476	Cinghia distribuzione DAYCO 152 denti RHDS 300 <i>Timing belt (152 teeth)</i>	DAILY CITY 2000 35S13/S15 - 35C13/C15 50C13/C15 - 65C15 FIAT DUCATO RENAULT MASTER - TRAFIC
	901221	7303415	Cinghia distribuzione DAYCO 153 denti RHX 300 (fino a motore < 1307400) <i>Timing belt (153 teeth)</i> (Up to engine < 1307400)	DAILY RESTYLING 35.10 - 45.10 - 49.10 NEW DAILY 30-35-40.8 - 35-45-49.10
	901222	500323627	Cinghia distribuzione DAYCO (ex.98415921) 153 denti RHDS 300 (da motore > 1307401) <i>Timing belt (153 teeth)</i> (From engine < 1307401)	DAILY RESTYLING 35.10 - 45.10 - 49.10 NEW DAILY 30-35-40.8 - 35-45-49.10 TURBODAILY 35.10 - 35.12 - 49.12 - 59.12 DAILY 2000 35S9 - 35C9
	901223	99456477	Cinghia distribuzione DAYCO 154 denti RHDS 300H <i>Timing belt (154 teeth)</i>	TURBODAILY 96 30-35-49.10 - 35-49-59.12 DAILY 2000 35S11 - 35C11 - 50C11
	901239	500371975	Cinghia distribuzione DAYCO 178 denti <i>Timing belt (178 teeth)</i>	DAILY CITY 2000 35C10/C12 - 35S10/S12 29L10/L12

Illustrazione <i>Illustration</i>	Ns.Rif. <i>Our Ref.</i>	Rif.Costr. <i>O.E. Ref.</i>	Descrizione <i>Description</i>	Tipo di veicolo <i>Vehicle Type</i>
	901206	-	Kit cinghia e cuscinetti distribuzione composto da: <i>Kit belt and timing belt tightener composed by:</i>	DAILY RESTYLING 30.8-35.8-40.8 - 35-45-49.10 NEW DAILY 30-35-40.8 - 35-45-49.10 DAILY 2000 35S11/S13 - 35C11/C13 50C11/C13/C15 - 65C13/C15
	-	98421275	Guarnizione piana q.tà 1	
	-	98454051	Anello tenuta q.tà 1	
	901333	2992484	Cuscinetto motore q.tà 1	
	901336	2992485	Cuscinetto motore q.tà 1	
901220	7303414	Cinghia 152 denti q.tà 1		
	901205	-	Kit cinghia e tendicinghia distribuzione composto da: <i>Kit belt and timing belt tightener composed by:</i>	DAILY RESTYLING 30.8-35.8-40.8
	-	98421275	Guarnizione piana q.tà 1	
	-	98454051	Anello tenuta q.tà 1	
	901302	7301661	Tendicinghia inf. q.tà 1	
	901301	7301662	Tendicinghia sup. q.tà 1	
901220	7303414	Cinghia 152 denti q.tà 1		
	901210	-	Kit cinghia e cuscinetti distribuzione (fino a motore < 1307400) composto da: <i>Kit belt and timing belt tightener composed by: (Up to engine < 1307400)</i>	DAILY RESTYLING 30-35-40.8 - 35-45-49.10 NEW DAILY 30-35-40.8 - 35-45-49.10 TURBODAILY 35.10 - 35-49-59.12 DAILY 2000 35S9/S11/S13 - 35C9/C11/C13 50C11/C13 - 65C13/C15
	901221	7303415	Cinghia 153 denti q.tà 1	
	901333	2992484	Cuscinetto motore q.tà 2	
	-	98454051	Anello tenuta q.tà 1	
	-	98421275	Guarnizione piana q.tà 1	
	901211	-	Kit cinghia e cuscinetti distribuzione (da motore > 1307401) composto da: <i>Kit belt and timing belt tightener composed by: (From engine > 1307401)</i>	DAILY RESTYLING 30-35-40.8 - 35-45-49.10 NEW DAILY 30-35-40.8 - 35-45-49.10 TURBODAILY 35.10 - 35-49-59.12 DAILY 2000 35S9/S11/S13 - 35C9/C11/C13 50C11/C13 - 65C13/C15
	901222	500323627	Cinghia 153 denti q.tà 1	
	901333	2992484	Cuscinetto motore q.tà 2	
	-	98454051	Anello tenuta q.tà 1	
	-	98421275	Guarnizione piana q.tà 1	





Illustrazione <i>Illustration</i>	Ns.Rif. <i>Our Ref.</i>	Rif.Costr. <i>O.E. Ref.</i>	Descrizione <i>Description</i>	Tipo di veicolo <i>Vehicle Type</i>
	901214	-	Kit cinghia e cuscinetti distribuzione composto da: <i>Kit belt and timing belt tightener composed by:</i>	DAILY CITY 2000 35S9/S11/S13/S15 35C9/C11/C13/C15 50C11/C13/C15 65C13/C15
	901224	99456476	Cinghia 152 denti q.tà 1	
	901333	2992484	Cuscinetto motore q.tà 1	
	901336	2992485	Cuscinetto motore q.tà 1	
	-	98454051	Anello tenuta q.tà 1	
-	98421275	Guarnizione piana q.tà 1		
	901215	-	Kit cinghia e cuscinetti distribuzione composto da: <i>Kit belt and timing belt tightener composed by:</i>	TURBODAILY 96 30.10 - 35.10 - 49.10 59.12 DAILY CITY 2000 35S11 - 35C11 50C11
	901223	99456477	Cinghia 154 denti q.tà 1	
	901333	2992484	Cuscinetto motore q.tà 2	
	-	98454051	Anello tenuta q.tà 1	
	-	98421275	Guarnizione piana q.tà 1	
  	901337	2992485 4740847	Cuscinetto tendicinghia <i>Belt tightener bearing</i>	DAILY RESTYLING 30.8-35.8-40.8 NEW DAILY 30.8-35.8-35.10 DAILY 2000 35S11/S13 - 35C11/C13 50C11/C13/C15 - 65C13/C15
	901333	2992484 99432547	Cuscinetto tendicinghia <i>Belt tightener bearing</i>	DAILY RESTYLING 30-35-40.8 - 35-45-49.10 NEW DAILY 30-35-40.8 - 35-45-49.10 TURBODAILY 35.10 - 35-49-59.12 DAILY 2000 35S9/S11/S13 - 35C9/C11/C13 50C11/C13 - 65C13/C15
	901311	4279745	Tendicinghia <i>Belt tightener</i>	DAILY RESTYLING 30-35-40.8 - 35-45-49.10 NEW DAILY 30-35-40.8 - 35-45-49.10 TURBODAILY 35.10 - 35-49-59.12 DAILY 2000 35S9/S11/S13 - 35C9/C11/C13 50C11/C13 - 65C13/C15

Illustrazione <i>Illustration</i>	Ns.Rif. <i>Our Ref.</i>	Rif.Costr. <i>O.E. Ref.</i>	Descrizione <i>Description</i>	Tipo di veicolo <i>Vehicle Type</i>
	901300	504000412	Puleggia tendicinghia <i>Belt tightener pulley</i>	DAILY CITY 2000 35S10/S12 35C10/C12
	901305	500393575	Puleggia tendicinghia <i>Belt tightener pulley</i>	DAILY CITY 2000 35S10/S12 35C10/C12
	901306	500388688	Puleggia tendicinghia <i>Belt tightener pulley</i>	DAILY CITY 2000 35S10/S12 35C10/C12
	901301	7301662	Tendicinghia distribuzione con cuscinetto 2992484 (superiore) <i>Tining belt tightener with bearing 2992484 (upper)</i>	DAILY RESTYLING 30.8-35.8-40.8
	901302	7301661	Tendicinghia distribuzione con cuscinetto 2992485 (inferiore) <i>Tining belt tightener with bearing 2992485 (lower)</i>	DAILY RESTYLING 30.8-35.8-40.8



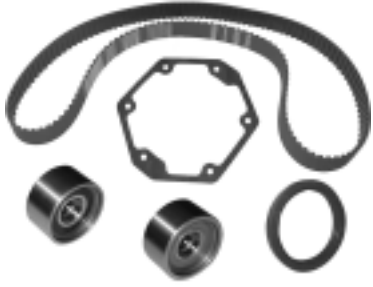

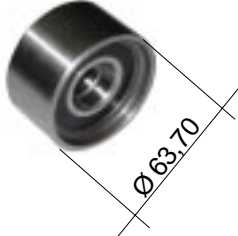
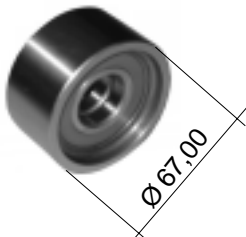
Illustrazione <i>Illustration</i>	Ns.Rif. <i>Our Ref.</i>	Rif.Costr. <i>O.E. Ref.</i>	Descrizione <i>Description</i>	Tipo di veicolo <i>Vehicle Type</i>
	901307	504010846	Puleggia tendicinghia <i>Belt tightener pulley</i>	DAILY CITY 2000 35S10/S12 35C10/C12
	901308	500332622 5010553544 5010284907	Tendicinghia completo <i>Complete belt tightener</i>	DAILY CITY 2000 35S9/S11/S13/S15 35C9/C11/C13/C15 50C11/C13/C15 65C13/C15 RENAULT MASCOTT 90-110-130-140
	901330	504086751	Tendicinghia completo <i>Complete belt tightener</i>	DAILY CITY 2000 35S10/S12 35C10/C12
	901345	504086948	Tendicinghia completo <i>Complete belt tightener</i>	DAILY MY 2006 35S15/S18 35C14/C5/C17/C18 50C14/C15/C18 65C15





Illustrazione <i>Illustration</i>	Ns.Rif. <i>Our Ref.</i>	Rif.Costr. <i>O.E. Ref.</i>	Descrizione <i>Description</i>	Tipo di veicolo <i>Vehicle Type</i>
	906206	4837950	Termocontatto 12 V <i>Switch 12V</i>	IVECO DAILY 30.8-35.8 (75cv) 35.10-49.10 (103cv) Duty 1991> (75cv)
	906207	99452677	Termocontatto <i>Switch 12V</i>	NEW DAILY 35.8 > 1996 TURBODAILY > 1996 30.10-35.10-49.10 35.12-49.12-59.12
	906208	9984319	Interruttore <i>Switch 12V</i>	IVECO DAILY 30.8-35.8 (75cv) 35.10-49.10 (103cv) Duty 30.8H 1991> (75cv)
	906222	4846676	Interruttore luci <i>Switch 12V</i>	DAILY 35.10 - 49.10 (103cv) 35.12 - 49.12 (116cv) > 1991
	906200	4856030	Interruttore luci <i>Switch 12V</i>	DAILY T.T. (96)





Illustrazione <i>Illustration</i>	Ns.Rif. <i>Our Ref.</i>	Rif.Costr. <i>O.E. Ref.</i>	Descrizione <i>Description</i>	Tipo di veicolo <i>Vehicle Type</i>
	906229	98469129 4422049	Interruttore pressione olio <i>Oil switch</i>	NEW DAILY '96 DAILY RESTYLING '96 TURBODAILY '96
	906225	99460557	Interruttore temperatura acqua <i>Water temperature switch</i>	NEW DAILY (96) 30.8-35.8-40.8 35.10-45.10-49.10 TURBODAILY (96) 35.10-49.10 35.12-49.12-59.12 DAILY CITY 2000 35S11 - 35C11 50C11
	906226	98435734	Interruttore temperatura acqua <i>Water temperature switch</i>	NEW DAILY (96) 30.8-35.8-40.8 35.10-45.10-49.10 TURBODAILY (96) 35.10-49.10 35.12-49.12-59.12
	906050	500310147	Trasmittitore acqua <i>Water temperature transmitter</i>	NEW DAILY (96) 30.8-35.8-40.8 35.10-45.10-49.10 TURBODAILY (96) 35.10-49.10 35.12-49.12-59.12



Illustrazione <i>Illustration</i>	Ns.Rif. <i>Our Ref.</i>	Rif.Costr. <i>O.E. Ref.</i>	Descrizione <i>Description</i>	Tipo di veicolo <i>Vehicle Type</i>
	906231	4825110	Trasmittitore elettronico <i>Electronic transmitter</i>	NEW DAILY - TURBODAILY
	906055	4834987	Trasmittitore elettronico <i>Electronic transmitter</i>	NEW DAILY (96) TURBODAILY (96)
	906223	4857248	Bulbo temperatura <i>Temperature transmitter</i>	IVECO DAILY 30.8-35.8 (75cv) 35.10-49.10 (103cv) Duty 1991> (75cv)

Illustrazione <i>Illustration</i>	Ns.Rif. <i>Our Ref.</i>	Rif.Costr. <i>O.E. Ref.</i>	Descrizione <i>Description</i>	Tipo di veicolo <i>Vehicle Type</i>
	906060	4862328	Sensore filtro gasolio <i>Fuel filter sensor</i>	NEW DAILY (96) 30.8-35.8-40.8 35.10-45.10-49.10 TURBODAILY (96) 35.10-49.10 35.12-49.12-59.12
	906061	4851417	Sensore filtro gasolio <i>Fuel filter sensor</i>	NEW DAILY (96) 30.8-35.8-40.8 35.10-45.10-49.10 TURBODAILY (96) 35.10-49.10 35.12-49.12-59.12
	906062	99468264	Sensore filtro gasolio <i>Fuel filter sensor</i>	DAILY CITY 2000
	902294	98494902 4832277	Elettrovalvola <i>Electro-valve</i>	TURBODAILY '96 35.12 DAILY CITY 2000 35S9/S11/S13/S15 35C9/C11/C13/C15 50C11/C13/C15 65C13/C15

Illustrazione <i>Illustration</i>	Ns.Rif. <i>Our Ref.</i>	Rif.Costr. <i>O.E. Ref.</i>	Descrizione <i>Description</i>	Tipo di veicolo <i>Vehicle Type</i>
	901339	500305943	Puleggia elettromagnete <i>Electro magnet pulley</i>	NEW DAILY TURBODAILY 30.8 - 35.8-35.10-49.10 35.12 - 49.12 (anno 1996)
	901340	99473900	Puleggia elettromagnete <i>Electro magnet pulley</i>	DAILY CITY 2000 35S9/S11/S13/S15 35C9/C11/C13/C15 50C11/C13/C15 65C13/C15



Illustrazione <i>Illustration</i>	Ns.Rif. <i>Our Ref.</i>	Rif.Costr. <i>O.E. Ref.</i>	Descrizione <i>Description</i>	Tipo di veicolo <i>Vehicle Type</i>
	900298	7303100	Distanziale collettore scarico <i>Exhaust manifold spacer</i> (AD ESAURIMENTO)	DAILY RESTYLING 35.10 - 49.10
	900297	7303099	Bullone collettore scarico <i>Exhaust manifold bolt</i> (AD ESAURIMENTO)	DAILY RESTYLING 35.10 - 49.10
	905625	99436004	Tubo in ghisa per passaggio aria turbina <i>Cast iron pipe for way out turbine's air</i>	TURBODAILY '96 35.10-35.12 49.10-49.12 - 59.12



Illustrazione <i>Illustration</i>	Ns.Rif. <i>Our Ref.</i>	Rif.Costr. <i>O.E. Ref.</i>	Descrizione <i>Description</i>	Tipo di veicolo <i>Vehicle Type</i>
	906244	99431083 4841844	Turbosoffiante Turbocharger MOTORE SOFIM 8140.27 85 Kw/3800 rpm	NEW DAILY 35.10-49.10 DAILY RESTYLING 35.10-49.10
	906129	99431084	Turbosoffiante Turbocharger MOTORE SOFIM 8140.47	NEW DAILY 35.10 - 49.10 TURBODAILY 96 35.12 - 49.12 - 59.12
	906243	99450704	Turbosoffiante Turbocharger	TURBODAILY 96 30.10 - 35.10 - 49.10



Illustrazione <i>Illustration</i>	Ns.Rif. <i>Our Ref.</i>	Rif.Costr. <i>O.E. Ref.</i>	Descrizione <i>Description</i>	Tipo di veicolo <i>Vehicle Type</i>
	906124	99450703	Turbosoffiante Turbocharger MOTORE SOFIM 8140.23	TURBODAILY 96 35.12 - 49.12 - 59.12
	906123	99499169	Turbosoffiante Turbocharger MOTORE SOFIM 8140.43 84 Kw/3500 rpm	DAILY



Illustrazione <i>Illustration</i>	Ns.Rif. <i>Our Ref.</i>	Rif.Costr. <i>O.E. Ref.</i>	Descrizione <i>Description</i>	Tipo di veicolo <i>Vehicle Type</i>
	905140	-	Serie guarnizioni turbocompr. <i>Gaskets kit for turbocompressor</i>  KKK 7302470 Garrett 7302941 Garrett 7303183	DAILY RESTYLING 35.10 - 49.10 (AD ESAURIMENTO)
	905157	-	Serie guarnizioni turbocompr. <i>Gaskets kit for turbocompressor</i>  KKK 98408871 Garrett 99431084	NEW DAILY 35.10 - 49.10 TURBO DAILY 35/49/59.12
	900445	4856612	Serie guarnizioni turbocompr. (senza prigionieri) <i>Gaskets kit for turbocompressor</i>  KKK 98408871 Garrett 99431084	NEW DAILY 35.10 - 49.10 TURBO DAILY 35/49/59.12
	905180	2992533 504049364	Serie guarnizioni turbocompr. <i>Gaskets kit for turbocompressor</i>	DAILY CITY 2000 35S10/S12 35C10/C12
	905181	99477121	Serie guarnizioni turbocompr. <i>Gaskets kit for turbocompressor</i>	TURBODAILY '96 35.10-35.12 49.10-49.12 59.12





Illustrazione <i>Illustration</i>	Ns.Rif. <i>Our Ref.</i>	Rif.Costr. <i>O.E. Ref.</i>	Descrizione <i>Description</i>	Tipo di veicolo <i>Vehicle Type</i>
	905201	500329488	Tubo scarico <i>Exhaust pipe</i>	DAILY CITY 2000 35C9 - 35S9
	905202	504033946	Tubo scarico <i>Exhaust pipe</i>	DAILY CITY 2000 35C9/C10/C11/C12/C13/C15 35S9/S10/S11/S12/S13/S15 50C11/C13/C15 65C13/C15
	905203	504033945	Tubo scarico <i>Exhaust pipe</i>	DAILY CITY 2000 35S11 - 35C11 - 50C11
	905669	504059011	Tubo scarico <i>Exhaust pipe</i>	DAILY CITY 2000

Illustrazione <i>Illustration</i>	Ns.Rif. <i>Our Ref.</i>	Rif.Costr. <i>O.E. Ref.</i>	Descrizione <i>Description</i>	Tipo di veicolo <i>Vehicle Type</i>
	905477	93811160	Silenziatore scarico <i>Exhaust silencer</i>	DAILY 28-40.8 (1°serie) NEW DAILY 28-40.8
	905475	93806921	Silenziatore scarico <i>Exhaust silencer</i> (AD ESAURIMENTO)	DAILY 30-35-40.8 (1°-2°serie)
	905478	93809509	Silenziatore scarico <i>Exhaust silencer</i>	DAILY 35-49.10 Turbo NEW 35-49.10 Turbo
	905671	93822669	Silenziatore scarico <i>Exhaust silencer</i>	NEW DAILY (96) 30.8 - 35.8
	905672	93822846	Silenziatore scarico <i>Exhaust silencer</i>	TURBODAILY 49.12 TURBODAILY (96) 30-35-49.10 35-49-59.12
	905677	500329483	Silenziatore scarico <i>Exhaust silencer</i>	DAILY CITY 2000 35S9/S11/S13 35C9/C11/C13 50C11/C13/C15 65C13/C15 35S10/S12 35C10/C12
	905670	93818452	Silenziatore scarico <i>Exhaust silencer</i>	DAILY 35.10-49.10-35.10(1996)
	905451	500329489	Silenziatore scarico <i>Exhaust silencer</i>	DAILY CITY 2000 35S9/S11 - 35C9/C11 50C11 - 65C11





Illustrazione <i>Illustration</i>	Ns.Rif. <i>Our Ref.</i>	Rif.Costr. <i>O.E. Ref.</i>	Descrizione <i>Description</i>	Tipo di veicolo <i>Vehicle Type</i>
	103615	93818454	Tassello sostegno marmitta <i>Silencer dowel support</i>	DAILY T.T.
	103612	-	Complessivo fissaggio silenziatore (anteriore) <i>Assy kit fixing exhaust silencer (front)</i>	DAILY T.T.
	103614	-	Complessivo fissaggio silenziatore (posteriore) <i>Assy kit fixing exhaust silencer (rear)</i>	DAILY T.T.
	103609	-	Complessivo fissaggio scarico completo <i>Assy kit fixing exhaust silencer (front and rear)</i>	DAILY T.T.
	103618	-	Kit fissaggio silenziatore composto da: Kit fixing exhaust silencer composed by:	DAILY CITY 2000
		500329485 8585923 8582510 16598424 17094914 16750221	Tassello in gomma Pz. 4 Collare di fissaggio Pz. 1 Collare di fissaggio Pz. 1 Vite fissaggio Pz. 2 Rondella Pz. 4 Dado M8 Pz. 2	





Illustrazione <i>Illustration</i>	Ns.Rif. <i>Our Ref.</i>	Rif.Costr. <i>O.E. Ref.</i>	Descrizione <i>Description</i>	Tipo di veicolo <i>Vehicle Type</i>
	908425	93800317	Grano forcella frizione <i>Clutch fork grub screw</i>	DAILY 28.8 - 30.8 - 35.8
	908424	93807414	Grano forcella frizione <i>Clutch fork grub screw</i>	DAILY RESTYLING 30-35-40.8 - 35-45-49.10 NEW DAILY 30-35-40.8 - 35-45-49.10
	908423	93807385	Perno registro cavo frizione <i>Clutch cable register pin</i>	DAILY RESTYLING 30-35-40.8 - 35-45-49.10 NEW DAILY 30-35-40.8 - 35-45-49.10 TURBODAILY 35-45-49-59.12
	908174	93801671	Leva distacco frizione (fino a telaio 420242) <i>Clutch lever</i> (Up to chassis 420242)	DAILY 28.8 - 35.8 - 40.8 DAILY RESTYLING 30.8 - 35.8 - 40.8
	908175	93807122	Leva distacco frizione (da telaio 420243) <i>Clutch lever</i> (From chassis 420243)	DAILY 28.8 - 35.8 - 40.8 DAILY RESTYLING 30-35-40.8 - 35-45-49.10 NEW DAILY 30-35-40.8 - 35-45-49.10





Illustrazione <i>Illustration</i>	Ns.Rif. <i>Our Ref.</i>	Rif.Costr. <i>O.E. Ref.</i>	Descrizione <i>Description</i>	Tipo di veicolo <i>Vehicle Type</i>
	908100	1908648 93811404	Leva distacco frizione <i>Clutch fork lever</i> (AD ESAURIMENTO)	NEW DAILY 30-35-40.8 - 35-45-49.10 TURBODAILY 30.10 - 35-45-49.12
	908131	42116734	Leva distacco frizione <i>Clutch fork lever</i>	NEW DAILY '96 30.8 - 35.8 TURBODAILY '96 30.10 - 35.10/12 - 49.10/12 59.12
	908061	1905318	Manicotto reggispinta frizione <i>Clutch thrust bearing sleeve</i>	DAILY 28-30-35.8 TURBODAILY 35.10 - 45.10 - 49.10
	908058	2992027	Manicotto reggispinta frizione (ex.1905290) <i>Clutch thrust bearing sleeve</i>	NEWDAILY 30-35-40.8 - 35-45-49.10 TURBODAILY 35-49.10 - 35.12-49.12-59.12 DAILY CITY 2000 35S9/S11/S13 35C9/C11/C13/C15 50C11/C13/C15 - 65C13/C15



Illustrazione <i>Illustration</i>	Ns.Rif. <i>Our Ref.</i>	Rif.Costr. <i>O.E. Ref.</i>	Descrizione <i>Description</i>	Tipo di veicolo <i>Vehicle Type</i>
	908001	2994035 2995703	Kit frizione completo di disco spingidisco e reggispinta (a tiro) Ø 235 mm. <i>Kit clutch complete with disc pressurplate and thrust bearing</i>	NEW DAILY 30.8-35.8-40.8 35.10-45.10-49.10
	908370	2995814	Kit frizione completo di disco spingidisco e reggispinta (a tiro) Ø 310 mm. <i>Kit clutch complete with disc pressurplate and thrust bearing</i>	DAILY
	908003	2992630 1908543	Kit frizione completo di disco spingidisco e reggispinta (a tiro) Ø 280 mm. <i>Kit clutch complete with disc pressurplate and thrust bearing</i>	TURBODAILY 96 35.12 - 49.12 - 59.12











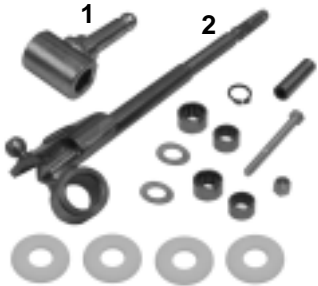

Illustrazione <i>Illustration</i>	Ns.Rif. <i>Our Ref.</i>	Rif.Costr. <i>O.E. Ref.</i>	Descrizione <i>Description</i>	Tipo di veicolo <i>Vehicle Type</i>
	908008	2994026 2992631 1908523	Kit frizione completo di disco spingidisco e reggispinta (a tiro) Ø 267 mm. <i>Kit clutch complete with disc pressureplate and thrust bearing</i>	NEW DAILY 35.10 - 49.10 TURBODAILY 35.12 - 49.12 - 59.12
	908009	2994028 1908521	Kit frizione completo di disco spingidisco e reggispinta (a spinta) Ø 267mm. <i>Kit clutch complete with disc pressureplate and thrust bearing</i>	NEW DAILY 35.10 - 44.10 - 49.10 DAILY CITY 2000 35S9/S11/S13 35C9/C11/C13 50C11/C13
	908036	93161953	Kit organi spinta frizione <i>Kit clutch complete</i>	NEW DAILY 35.10 TURBODAILY 35.12 - 49.12 - 59.12

Illustrazione <i>Illustration</i>	Ns.Rif. <i>Our Ref.</i>	Rif.Costr. <i>O.E. Ref.</i>	Descrizione <i>Description</i>	Tipo di veicolo <i>Vehicle Type</i>
	913724	1907909 8859616	Kit revisione cambio ridotto <i>Kit gear box turret</i>	NEW DAILY 96 30.8 - 35.8 - 40.8 35.10 - 45.10 - 49.10 DAILY RESTYLING 30.8 - 35.8/10 40.8 - 45.10 - 49.10 TURBODAILY 35.12 - 49.12 - 59.12
	913714	-	Kit leva marce montato e completo di leva Rif. 8859927 Gear lever kit assembled and complete of lever Ref. 8859927	DAILY '96
	913715	-	Kit leva marce Gear lever kit	DAILY CITY 2000
	913750	504040961	Bussola leva marce	(1)
	913751	504040962	Leva marce	(2)
	911048	8576824	Pomello leva marce Gear lever knob	DAILY RESTYLING 30.8 - 35.8 - 40.8 35.10 - 45.10 - 49.10 NEW DAILY 30.8 - 35.10

PARTI CAMBIO - GEAR BOX PARTS

IVECO

Illustrazione <i>Illustration</i>	Ns.Rif. <i>Our Ref.</i>	Rif.Costr. <i>O.E. Ref.</i>	Descrizione <i>Description</i>	Tipo di veicolo <i>Vehicle Type</i>
	913003	8859927	Leva comando marce <i>Shift lever</i> (AD ESAURIMENTO)	NEW DAILY DAILY RESTYLING TURBODAILY
	913737	9983325	Asta assale Dx/Sx (filettatura esterna M16x1,5) RHT Lungh. 340 mm. <i>Axle rod right/left</i>	NEW DAILY (96) 30.8-35.8-40.8 35.10-45.10-49.10 TURBODAILY (96) 35.10-49.10 35.12-49.12-59.12 DAILY CITY 2000 35S9/S11/S13 35C9/C11/C13
	913740	42532977	Asta assale Dx/Sx <i>Axle rod right/left</i>	TURBODAILY (96) 35.10-49.10 35.12-49.12-59.12 DAILY CITY 2000
	913739	2992593	Asta assale Dx/Sx <i>Axle rod right/left</i>	DAILY CITY 2000 35S9/S11/S13 35C9/C11/C13 50C11/C13/C15 65C11/C13/C15

925000	7170959	Ponte posteriore nudo <i>Rear axle body</i>	NEW DAILY (96) 35.8 - 40.8 35.10 - 45.10 TURBODAILY (96) 35.10 - 35.12
925001	7180037	Ponte posteriore nudo <i>Rear axle body</i>	NEW DAILY (96) 35.8 TURBODAILY (96) 35.10 - 35.12



925002	99455219 99455218	Albero di trasmissione completo di supporto scorrevole <i>Sliding propeller shaft complete of support</i>	TURBODAILY (96) 35.10 - 49.10 35.12 - 49.12
---------------	----------------------	---	--

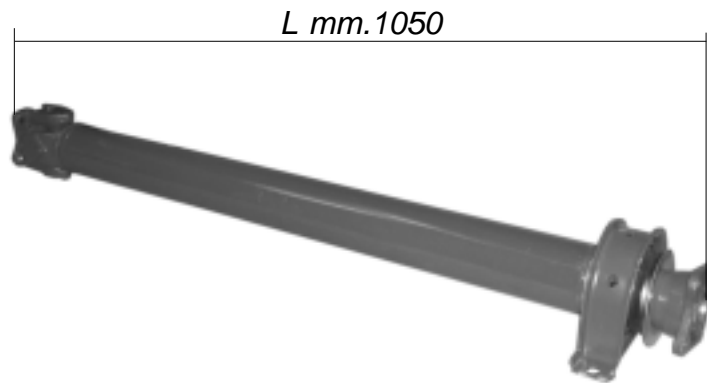

Lunghezza/Lenght - mm 1680 - 1750

Albero di trasmissione fisso completo di supporto
Fixed propeller shaft complete with support

L mm.1050

Ns Riferim. Our Ref.	Rif. Costr. O.E. Ref.	Tipo di veicolo - Vehicle Type
925038	99455579 99455578	Turbodaily '96 35.10 - 49.10 - 35.12 - 49.12

Differenziale - Differential

Ns Riferim. Our Ref.	Rif. Costr. O.E. Ref.	Tipo di veicolo - Vehicle Type
924999	7180038	DAILY ('96) DAILY CITY 2000 35C9/C10/C11/C12/C13/C15 50C11/C13/C15

Illustrazione Illustration	Ns.Rif. Our Ref.	Rif.Costr. O.E. Ref.	Descrizione Description	Tipo di veicolo Vehicle Type
	913005	7182665	Coperchio differenziale Differential cover	DAILY CITY 2000 35C9/C10/C11/C12/C13/C15 50C11/C13/C15





Illustrazione <i>Illustration</i>	Ns.Rif. <i>Our Ref.</i>	Rif.Costr. <i>O.E. Ref.</i>	Descrizione <i>Description</i>	Tipo di veicolo <i>Vehicle Type</i>						
	925024	42530546	Supporto oscill.trasmissione <i>Transmission support</i> <table border="1" data-bbox="767 456 1118 560"> <thead> <tr> <th>Ø mm.</th> <th>L mm.</th> <th>S mm.</th> </tr> </thead> <tbody> <tr> <td>40</td> <td>168</td> <td>18</td> </tr> </tbody> </table>	Ø mm.	L mm.	S mm.	40	168	18	TURBODAILY (96) 35.12 - 49.12 - 59.12
Ø mm.	L mm.	S mm.								
40	168	18								
	925023	93158202	Supporto oscill.trasmissione <i>Transmission support</i> <table border="1" data-bbox="767 983 1118 1086"> <thead> <tr> <th>Ø mm.</th> <th>L mm.</th> <th>S mm.</th> </tr> </thead> <tbody> <tr> <td>40</td> <td>168</td> <td>17</td> </tr> </tbody> </table>	Ø mm.	L mm.	S mm.	40	168	17	TURBODAILY (96) 35.12 - 49.12 - 59.12
Ø mm.	L mm.	S mm.								
40	168	17								
	925013	93156460	Supporto oscill.trasmissione <i>Transmission support</i> <table border="1" data-bbox="767 1451 1118 1554"> <thead> <tr> <th>Ø mm.</th> <th>L mm.</th> <th>S mm.</th> </tr> </thead> <tbody> <tr> <td>45</td> <td>168</td> <td>19</td> </tr> </tbody> </table>	Ø mm.	L mm.	S mm.	45	168	19	NEW DAILY 30.8-35.8-40.8 - 35.10-49.10 TURBODAILY 35.12-49.12-59.12 DAILY CITY 2000 35S9/S11/S13 35C9/C11/C13 50C11/C13 - 65C13
Ø mm.	L mm.	S mm.								
45	168	19								
	925020	42536526 4390495	Supporto oscill.trasmissione <i>Transmission support</i> <table border="1" data-bbox="767 1973 1118 2076"> <thead> <tr> <th>Ø mm.</th> <th>L mm.</th> <th>S mm.</th> </tr> </thead> <tbody> <tr> <td>35</td> <td>168</td> <td>17</td> </tr> </tbody> </table>	Ø mm.	L mm.	S mm.	35	168	17	NEW DAILY 30.8-35.8-40.8 DAILY RESTYLING 30.8-35.8-40.8 - 35.10-49.10
Ø mm.	L mm.	S mm.								
35	168	17								





Illustrazione <i>Illustration</i>	Ns.Rif. <i>Our Ref.</i>	Rif.Costr. <i>O.E. Ref.</i>	Descrizione <i>Description</i>	Tipo di veicolo <i>Vehicle Type</i>						
	925019	42541021 9984261	Supporto oscill.trasmissione <i>Transmission support</i>	DAILY RESTYLING 30.8-35.8-40.8 - 35.10-49.10 NEW DAILY 30.8-35.8-40.8 - 35.10-49.10 TURBODAILY 35.12-49.12-59.12 RENAULT MASTER B90 - JK60 - S100						
		5000560295								
	925031	42536726 93160324	Supporto oscill.trasmissione <i>Transmission support</i>	NEW DAILY (96) 30.8-35.8-40.8 - 35.10 TURBODAILY 30.10 - 35.10						
			<table border="1"> <thead> <tr> <th>Ø mm.</th> <th>L mm.</th> <th>S mm.</th> </tr> </thead> <tbody> <tr> <td>35</td> <td>168</td> <td>20</td> </tr> </tbody> </table>	Ø mm.	L mm.	S mm.	35	168	20	
Ø mm.	L mm.	S mm.								
35	168	20								
	925030	42535254	Supporto oscill.trasmissione <i>Transmission support</i>	DAILY CITY 2000 35S9/S11/S13/S15 35C9/C11/C13/C15 50C11/C13/C15 65C13/C15						
			<table border="1"> <thead> <tr> <th>Ø mm.</th> <th>L mm.</th> <th>S mm.</th> </tr> </thead> <tbody> <tr> <td>40</td> <td>170</td> <td>20</td> </tr> </tbody> </table>	Ø mm.	L mm.	S mm.	40	170	20	
Ø mm.	L mm.	S mm.								
40	170	20								
	925027	42538439	Supporto oscill.trasmissione <i>Transmission support</i>	DAILY CITY 2000						
			<table border="1"> <thead> <tr> <th>Ø mm.</th> <th>L mm.</th> <th>S mm.</th> </tr> </thead> <tbody> <tr> <td>45</td> <td>170</td> <td>20</td> </tr> </tbody> </table>	Ø mm.	L mm.	S mm.	45	170	20	
Ø mm.	L mm.	S mm.								
45	170	20								





Illustrazione <i>Illustration</i>	Ns.Rif. <i>Our Ref.</i>	Rif.Costr. <i>O.E. Ref.</i>	Descrizione <i>Description</i>	Tipo di veicolo <i>Vehicle Type</i>
	934019	42532985	Crociera completa Ø 27 x 74,60 Complet universal joint cross Ø 27 x 74,60	NEW DAILY 96 30.8 - 35.8 TURBO DAILY 96 30.10
	934016	1905986 9984381 93163407	Crociera completa Ø 27 x 81,7 Complet universal joint cross Ø 27 x 81,7	DAILY RESTYLING 30.8-35.8-40.8 - 35.10 NEW DAILY 30.8-35.8-40.8 - 35.10
	934014	42546332 42530886	Crociera completa Ø 30,17 x 82 Complet universal joint cross Ø 30,17 X 82	TURBODAILY 96 35.10-49.10 35.12-49.12-59.12
	934018	8197741	Crociera completa Ø 30,20 x 92.00 Complet universal joint cross Ø 30.20 x 92.00	NEW DAILY 96 30.8 - 35.8 TURBO DAILY 96 30.10
	934017	92601339 4675624	Crociera completa Complet universal joint cross Ø 30.17 X 106.28	DAILY RESTYLING 35.10-45.10-49.10 ZETA 50.9 - 65.9 TURBOZETA 60.11

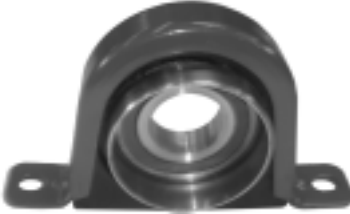

Illustrazione <i>Illustration</i>	Ns.Rif. <i>Our Ref.</i>	Rif.Costr. <i>O.E. Ref.</i>	Descrizione <i>Description</i>	Tipo di veicolo <i>Vehicle Type</i>
	934022	42541372 42535109	Crociera completa Ø 27 x 74,60 <i>Complet universal joint cross</i> Ø 27 x 74,60	DAILY CITY 2000 35S9/S11 35C9/C11 35S10/S12 35C10/C12
	934023	42541373 42535251	Crociera completa Ø 30,17 x 82 <i>Complet universal joint cross</i> Ø 30,17 X 82	DAILY CITY 2000 35S13/S15 35C13/C15 50C11/C13/C15 65C13/C15
	934024	42535253	Crociera completa Ø 30,17 x 106,28 <i>Complet universal joint cross</i> Ø 30,17 X 106,28	DAILY CITY 2000 35S13/S15 35C13/C15 50C11/C13/C15 65C11/C13/C15

Illustrazione <i>Illustration</i>	Ns.Rif. <i>Our Ref.</i>	Rif.Costr. <i>O.E. Ref.</i>	Descrizione <i>Description</i>	Tipo di veicolo <i>Vehicle Type</i>
	933400	93803594	Cerchio ruota 16" (tipo Gianetti 5JKX) Disc wheel 16" (type Gianetti 5JKX)	DAILY RESTYLING 35.8 - 40.8 35.10 - 45.10 - 49.10 NEW DAILY (96) 35.8 - 35.10 TURBODAILY (96) 35.10 - 35.12
	933401	98464866 500307777	Cerchio ruota 16" (tipo Gianetti 6J-16H2) Disc wheel 16" (type Gianetti 6J-16H2)	TURBODAILY (96) 59.12 DAILY CITY 2000 65C11/C13/C15
	933402	500330665	Cerchio ruota 5,5Jx16" H1 Disc wheel 5,5Jx16" H1 (con foro tondo) (with round hole)	DAILY CITY 2000 35C9/C11/C13 35C10/C12
	933403	504003565	Cerchio ruota 5,5Jx16" H1 Disc wheel 5,5Jx16" H1 (con foro rettangolare) (with rectangular hole)	DAILY CITY 2000 35C9/C11/C13 35C10/C12
	933408	93826384	Cerchio ruota 5 JKx16" (Gianetti) Disc wheel 5 JKx16" (Gianetti)	DAILY CITY 2000 35C9/C11/C13/C15 50C11/C13/C15

Illustrazione <i>Illustration</i>	Ns.Rif. <i>Our Ref.</i>	Rif.Costr. <i>O.E. Ref.</i>	Descrizione <i>Description</i>	Tipo di veicolo <i>Vehicle Type</i>
	972104	93822393 (8797513)	Tubo freno (L mm. 492) <i>Brake pipes (L mm. 492)</i>	NEW DAILY 96 30.8 - 35.8 TURBODAILY 96 30-35.10 - 35-49-59.12
	972105	8796958	Tubo freno (L mm. 532) <i>Brake pipes (L mm. 532)</i>	DAILY RESTYLING 30-35-40.8 - 35.10
	972107	93822492 (8796934)	Tubo freno (L mm. 383) <i>Brake pipes (L mm. 383)</i>	NEW DAILY 96 30.8 - 35.8 TURBODAILY 96 30-35.10 - 35-49-59.12
	972106	8796885	Tubo freno (L mm. 495) <i>Brake pipes (L mm. 495)</i>	DAILY RESTYLING 30-35-40.8 - 35.10





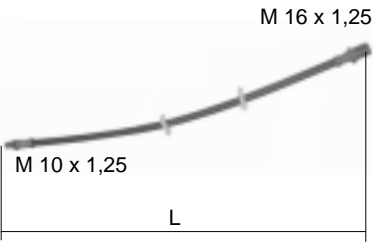
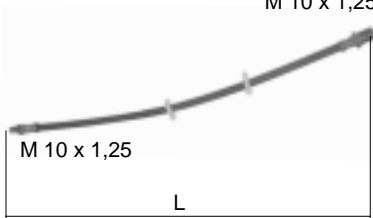
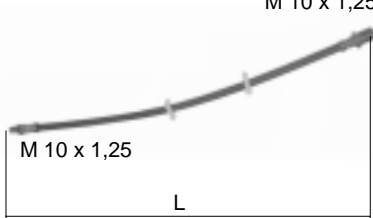
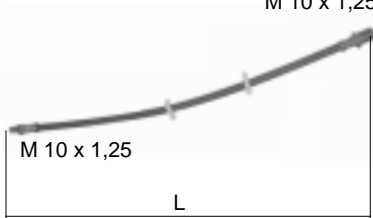



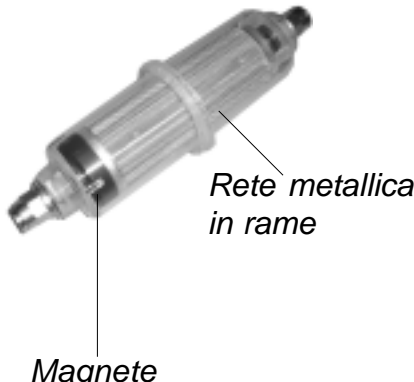
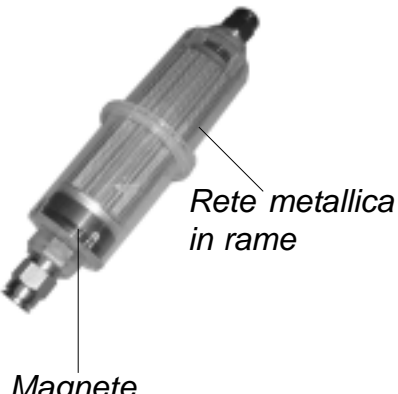

	Ns Riferim. Our Ref.	Rif. Costr. O.E. Ref.	Descrizione/Tipo di veicolo Description/Vehicle Type
 <p>Magnete</p> <p>Rete metallica in rame</p>	904063	-	<p><i>Prefiltro ad innesto rapido con valvola Ø 8 mm.</i> <i>Prefilter with quick coupling and valve Ø 8 mm.</i></p> <p>Veicoli commerciali ed industriali T.T. Commercial and industrial Vehicles</p> <p>(AD ESAURIMENTO)</p>
 <p>Magnete</p> <p>Rete metallica in rame</p>	904065	-	<p><i>Prefiltro ad innesto rapido con valvola Ø 10 mm.</i> <i>Prefilter with quick coupling and valve Ø 10 mm.</i></p> <p>Veicoli commerciali ed industriali T.T. Commercial and industrial Vehicles</p> <p>(AD ESAURIMENTO)</p>

Illustrazione <i>Illustration</i>	Ns.Rif. <i>Our Ref.</i>	Rif.Costr. <i>O.E. Ref.</i>	Descrizione <i>Description</i>	Tipo di veicolo <i>Vehicle Type</i>
	906904	99456723	Tappo serbatoio gasolio Ø 80 mm. chiusura a vite <i>Fuel tank plug Ø 80 mm.</i>	NEW DAILY 35.8 (1996) TURBO DAILY 35.10/12 - 49.10/12 - 59.12 EUROCARGO 95E15/E18/E21 - 135E18/E23
	906922	2993920	Tappo serbatoio gasolio Ø 60 mm. con chiave <i>Fuel tank plug Ø 60 mm.</i>	DAILY T.T. (fino al 1995)
	906919	2993923	Tappo serbatoio gasolio Ø 65 mm. con chiave <i>Fuel tank plug Ø 65 mm.</i>	DAILY CITY 2000
	906921	2993924	Tappo serbatoio gasolio Ø 80 mm. con chiave <i>Fuel tank plug Ø 80 mm.</i>	DAILY CITY 2000

	Ns Riferim. Our Ref.	Rif. Costr. O.E. Ref.	Descrizione/Tipo di veicolo Description/Vehicle Type
	906063	4838244	<p><i>Centralina portafusibili</i> <i>Fuse Box</i></p> <p>NEW DAILY (96) TURBODAILY (96)</p>
	990506	4836359 4836356	<p><i>Bloccasterzo</i> <i>Steering column lock</i></p> <p>NEW DAILY (96) TURBODAILY (96)</p>
	990505	99456701	<p><i>Devioguida</i> <i>Steering combi switch</i></p> <p>NEW DAILY(96) 30.8 - 35.8 - 40.8 35.10 - 45.10 - 49.10 TURBODAILY (96) 35.10 - 49.10 35.12 - 49.12 - 59.12</p>
	990502	500321203	<p><i>Devioguida</i> <i>Steering combi switch</i></p> <p>Daily City 2000 35S9/S10/S11/S12/S13/S15 35C9/C10/C11/C12/C13/C15 50C11/C13/C15 65C11/C13/C15</p>

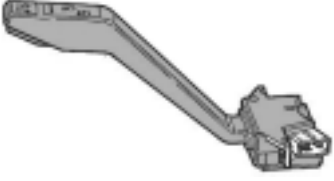
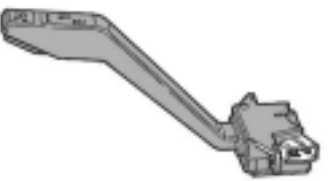
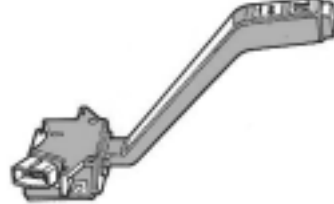
	Ns Riferim. Our Ref.	Rif. Costr. O.E. Ref.	Descrizione/Tipo di veicolo Description/Vehicle Type
	990510	504108890	<i>Devioguida</i> <i>Steering combi switch</i> Daily City 2000
	990511	500321204	<i>Devioguida</i> <i>Steering combi switch</i> DAILY CITY 2000 35C9/C10/C11/C12/C13/C15 35S9/S10/S11/S12/S13/S15 50C11/C13/C15 65C13/C15
	990514	42552534	<i>Leva devio</i> <i>Steering combi switch lever</i> DAILY CITY 2000 35C9/C11/C13 35S9/S11/S13 50C11/C13/C15 29L9/L11
	990513	42552535	<i>Leva devio SX</i> <i>Steering combi switch lever</i> DAILY CITY 2000 Serie S - Serie C
	990512	42552536	<i>Leva devio DX con cruise control</i> <i>Steering combi switch lever</i> DAILY CITY 2000 Serie S - Serie C

	Ns Riferim. Our Ref.	Rif. Costr. O.E. Ref.	Descrizione/Tipo di veicolo Description/Vehicle Type
	990300	T90204	<p>Sollevatore idraulico a bottiglia (portata 2 TON) Bottle hydraulic lifting (capacity 2 TON)</p> <p>Veicoli commerciali ed industriali T.T. Commercial and industrial Vehicles</p>
	990301	T90304	<p>Sollevatore idraulico a bottiglia (portata 3 TON) Bottle hydraulic lifting (capacity 3 TON)</p> <p>Veicoli commerciali ed industriali T.T. Commercial and industrial Vehicles</p>
	990302	T90504	<p>Sollevatore idraulico a bottiglia (portata 5 TON) Bottle hydraulic lifting (capacity 5 TON)</p> <p>Veicoli commerciali ed industriali T.T. Commercial and industrial Vehicles</p>

Illustrazione <i>Illustration</i>	Ns.Rif. <i>Our Ref.</i>	Rif.Costr. <i>O.E. Ref.</i>	Descrizione <i>Description</i>	Tipo di veicolo <i>Vehicle Type</i>
	902296	2997012 4856604	Valvola pressione olio <i>Oil pressure valve</i>	NEW DAILY 30.8 - 35.8/10 - 40.8 - 49.10 TURBODAILY 35.12 - 49.12 - 59.12
	902297	99438751	Valvola pressione olio <i>Oil pressure valve</i> (AD ESAURIMENTO)	DAILY CITY 2000 35S9/S11/S13/S15 35C9/C11/C13/C15 50C11/C13/C15 - 65C11
	902298	8796328	Valvola a più vie per impianto pneumatico freni <i>Multi-way valve for pneumatic brake system</i>	NEW DAILY 30.8 - 35.8 - 40.8 35.10 - 45.10 - 49.10 TURBODAILY 35.10 - 35.12 - 49.12
	954570	42548853 93193415	Serbatoio olio servosterzo	DAILY CITY 2000

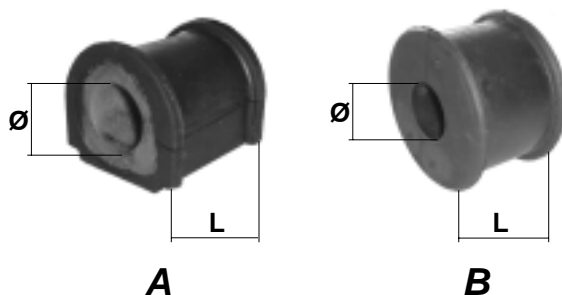

Tipo Type	Ø mm	L mm	Lato Side	Ns.Rif. Ns.Ref.	Rif.Costr. O.E. Ref.	Tipo di veicolo Vehicle Type
A	18	40	Post. Rear	100877	8581021	NEW DAILY 30.8-35.8-40.8 - 35.10 - 45.10 - 49.10 DAILY RESTYLING 30.8 - 35.10 - 45.10 - 49.10 TURBO DAILY 30.10 - 35.10 - 49.10 - 35.12 - 49.12 - 59.12
A	20	40	Post. Rear	100876	93802629	DAILY RESTYLING 40.8 NEW DAILY 35.8 - 40.8 - 35.10 - 49.10 TURBO DAILY 35.12 - 49.12 - 59.12
A	16	40	Post. Rear	100850	93803961	DAILY RESTYLING 35.8 - 35.10 NEW DAILY 35.8 - 35.10
A	22	40	Post. Rear	100878	93801556	DAILY RESTYLING 45.10 NEW DAILY 49.10 TURBO DAILY 49.12
B	20	35	Ant. Front	100800	93802248	NEW DAILY 30-35-40.8 - 35.10 - 49.10 DAILY RESTYLING 30-35-40.8 - 35.10 - 49.10 TURBO DAILY 35.12 - 49.12 - 59.12
B	35.5	34.5	Ant. Front	100827	8585819	TURBO DAILY 59.12
B	26	63	Post. Rear	100903	93814617	TURBO DAILY 96 49.12 - 59.12 DAILY CITY 2000 65C11/C13/C15
B	28	62	Post. Rear	100904	93814618	TURBO DAILY 96 59.12 DAILY CITY 2000 65C11/C13/C15

BOCCOLE BARRA STABILIZZATRICE E TORSIONE STABILIZER AND TORSION BAR RUBBER BUSH



Tipo Type	Ø1 mm	L mm	Ø2 mm	Ns.Rif. Ns.Ref.	Rif.Costr. O.E. Ref.	Tipo di veicolo Vehicle Type
A	29	25	52	100890	1391347	DAILY 30.8-35.8-40.8 DAILY RESTYLING 30.8-35.8-40.8 DAILY RESTYLING 35.10 - 49.10 (superiore - upper)
A	32	25	52	100891	1391348	DAILY 30.8-35.8-40.8 DAILY RESTYLING 30.8-35.8-40.8 DAILY RESTYLING 35.10 - 49.10 (inferiore - lower)
A	32	35	52	100892	93807641	NEW DAILY 30.8-35.8-40.8 - 35.10 TURBO DAILY 35.12 (superiore - upper)
A	37	35	57	100894	504277460 93810239	NEW DAILY 30.8-35.8-40.8 - 35.10-49.10 TURBO DAILY 35.12-49.12-59.12 (superiore - upper)
A	29	35	52	100893	504277459 93807640	NEW DAILY 30.8-35.8-40.8 - 35.10-49.10 TURBO DAILY 35.12-49.12-59.12 (inferiore - lower)

BOCCOLE ATTACCO BALESTRA
LEAF SPRINGS FASTENING BUSH

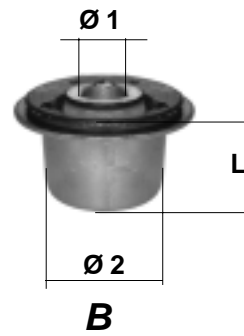

Tipo Type	Ø1 mm	L mm	Ø2 mm	Ns.Rif. Ns.Ref.	Rif.Costr. O.E. Ref.	Tipo di veicolo Vehicle Type
A	16	72	38.2	100950	93800193	DAILY 30.8-35.8-40.8 (ESAURIMENTO) DAILY RESTYLING 30.8-35.8-40.8 DAILY RESTYLING 35.10-49.10
B	16.5	30	40	100951	93808935	NEW DAILY 30.8-35.8-40.8 NEW DAILY 35.10-49.10 TURBO DAILY 35.12-49.12-59.12
B	16.2	36	40	100953	8587681	TURBO DAILY 59.12 (anteriore e posteriore - front and rear)

SILENT-BLOCK BARRA STABILIZZATRICE SILENTBLOCK STABILIZER BAR

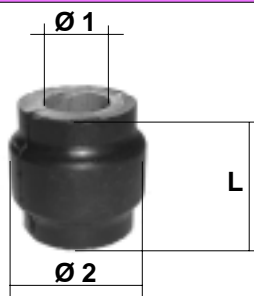

A

Tipo Type	Ø1 mm	L mm	Ø2 mm	Ns.Rif. Ns.Ref.	Rif.Costr. O.E. Ref.	Tipo di veicolo Vehicle Type
A	24	30	38	103682	93801623	DAILY RESTYLING 30.8-35.8-40.8 DAILY RESTYLING 35.10-49.10
A	16	30	38	103683	93803960	DAILY RESTYLING 35.8 DAILY RESTYLING 35.10
A	20	30	38	103673	93802631	DAILY RESTYLING 40.8
A	18	30	38	103674	8581022	DAILY RESTYLING 30.8 DAILY RESTYLING 35.10-49.10
A	22	30	38	103675	93801624	DAILY RESTYLING 45.10-49.10

**BOCCOLE BARRA SOSPENSIONI
SUSPENSION BAR BUSHING**













Illustrazione <i>Illustration</i>	Ns.Rif. <i>Our Ref.</i>	Rif.Costr. <i>O.E. Ref.</i>	Descrizione <i>Description</i>	Tipo di veicolo <i>Vehicle Type</i>
	100895	500350342	Boccola inferiore avantreno Fore-carriage lower bushing	DAILY CITY 2000 65C11/C13/C15
	100896	500350343	Boccola superiore avantreno Fore-carriage upper bushing	DAILY CITY 2000 65C11/C13/C15
	100900	500326957	Boccola sospensione Suspension bushing (ESAURIMENTO)	DAILY CITY 2000 35S9/S11/S13/S15 35C9/C11/C13/C15 50C11/C13/C15 65C13
	100902	504112266 504048721 504054600	Boccola balestra posteriore Rear leaf spring bushing	DAILY CITY 2000 35C9/C11/C13/C15 50C11/C13/C15

Illustrazione <i>Illustration</i>	Ns.Rif. <i>Our Ref.</i>	Rif.Costr. <i>O.E. Ref.</i>	Descrizione <i>Description</i>	Tipo di veicolo <i>Vehicle Type</i>
	902366	500315622	Biella sospensione con silentblock Suspension connecting rod with silentblock	DAILY CITY 2000 35S9/S11/S12/S13/S15
	100973	500336363	Supporto barra stabilizzatrice Anti-roll bar support	DAILY CITY 2000 35S9/S10/S11/S12/S13
	100974	500336364	Supporto barra stabilizzatrice Anti-roll bar support	DAILY CITY 2000 35S9/S10/S11/S12/S13
	100968	504112265 99469085	Silentblock sospensione Suspension silentblock	Daily City 2000 35S9/S10/S11/S12/S13/S15

BOCCOLE STERZO STEERING BUSHING

Illustrazione <i>Illustration</i>	Ns.Rif. <i>Our Ref.</i>	Rif.Costr. <i>O.E. Ref.</i>	Descrizione <i>Description</i>	Tipo di veicolo <i>Vehicle Type</i>
	103651	93802390	Boccola scatola sterzo Sx <i>Left steering box bushing</i>	DAILY RESTYLING 30.8-35.8-40.8 35.10 - 45.10 - 49.10 NEW DAILY 30.8 - 35.8 - 40.8 - 35.10 TURBODAILY 30/35.10 - 35.12
	103652	93802391	Boccola scatola sterzo Dx <i>Right steering box bushing</i>	DAILY RESTYLING 30.8 - 35.8 - 40.8 - 35.10 NEW DAILY 30.8 - 35.8 - 40.8 - 35.10 TURBODAILY 30.10 - 35.10
	103653	93802392	Boccola scatola sterzo destra/sinistra (Idroguida) <i>Right/Left steering box bushing</i>	DAILY RESTYLING 30.8 - 35.8 - 40.8 - 35.10 NEW DAILY 30.8 - 35.8 - 40.8 35.10 - 45.10 - 49.10 TURBODAILY 30.10 - 35.10 35.12 - 49.12 - 59.12



TASSELLO SOSTEGNO CABINA ANCHORS CABIN SUPPORT

	101018	4576957	Tassello anteriore e posteriore cabina <i>Front and rear dowel cabin (ESBURIMENTO)</i>	DAILY RESTYLING 30.8 - 35.8 - 40.8 35.10 - 49.10
---	---------------	---------	--	---

TASSELLI MOTORE ENGINE DOWELS

Illustrazione <i>Illustration</i>	Ns.Rif. <i>Our Ref.</i>	Rif.Costr. <i>O.E. Ref.</i>	Descrizione <i>Description</i>	Tipo di veicolo <i>Vehicle Type</i>
	100009	93803159	Tassello anteriore motore Dx <i>Engine right front dowel</i> (ESaurimento)	DAILY RESTYLING 30.8 - 35.8 - 40.8
	100011	8588903	Tassello anteriore motore Dx <i>Engine right front dowel</i>	NEW DAILY 30.8 - 35.8 - 40.8 35.10 - 45.10 - 49.10 DAILY RESTYLING 35.10-49.10 TURBO DAILY 30-35-49.10 35.12 - 49.12 - 59.12
	100012	8588904	Tassello anteriore motore Sx <i>Engine left front dowel</i>	NEW DAILY 30.8 - 35.8 - 40.8 35.10 - 45.10 - 49.10 DAILY RESTYLING 35.10-49.10 TURBO DAILY 30-35-49.10 35.12 - 49.12 - 59.12
	100003	504085410 500309459	Supporto motore posteriore <i>Engine rear support</i>	Daily City 2000 35S9/S11/S13/S15 35C9/C11/C13/C15 50C11/C13/C15 65C13/C15





TASSELLI MOTORE ENGINE DOWELS

Illustrazione <i>Illustration</i>	Ns.Rif. <i>Our Ref.</i>	Rif.Costr. <i>O.E. Ref.</i>	Descrizione <i>Description</i>	Tipo di veicolo <i>Vehicle Type</i>
	100061	8582425	Tassello posteriore motore <i>Engine rear dowel</i>	NEW DAILY 30.8 - 35.8 - 40.8 35.10 - 45.10 - 49.10 DAILY RESTYLING 35.10-49.10 TURBO DAILY 35.10 - 49.10 35.12 - 49.12 - 59.12
	100004	500342991	Supporto motore Sx <i>Engine left support</i>	DAILY CITY 2000 35S9/S11/S13/S15 35C9/C11/C13/C15 50C11/C13/C15 65C11/C13/C15
	100005	500342992	Supporto motore Dx <i>Engine right support</i>	DAILY CITY 2000 35S9/S11/S13/S15 35C9/C11/C13/C15 50C11/C13/C15 65C11/C13/C15





PARACOLPI SOSPENSIONI SUSPENSION BUFFERS

Illustrazione <i>Illustration</i>	Ns.Rif. <i>Our Ref.</i>	Rif.Costr. <i>O.E. Ref.</i>	Descrizione <i>Description</i>	Tipo di veicolo <i>Vehicle Type</i>
	100937	93803299	Tampone paracolpo superiore sospensione anteriore <i>Front suspension higher buffer</i>	DAILY RESTYLING 30-35-40.8 35.10 - 45.10 - 49.10 NEW DAILY 30-35-40.8 35.10 - 45.10 - 49.10 TURBO DAILY 35-49-59.12
	100908	93802207	Tampone paracolpo superiore sospensione anteriore <i>Front suspension higher buffer</i>	DAILY RESTYLING 30-35-40.8 35.10 - 45.10 - 49.10
	100909	93807567	Tampone paracolpo superiore sospensione anteriore <i>Front suspension lower buffer</i>	DAILY RESTYLING 45.10-49.10 NEW DAILY 30-35-40.8 35.10 - 45.10 - 49.10 TURBO DAILY 35-49-59.12
	100910	504060027 500362729	Tampone paracolpo superiore sospensione anteriore <i>Front suspension higher buffer</i>	DAILY CITY 2000 35S9/S11/S13/S15 35C9/C11/C13/C15 35S10/S12 35C10/C12
	100911	500306407	Tampone paracolpo inferiore sospensione anteriore <i>Front suspension lower buffer</i>	DAILY CITY 2000 35S9/S11/S13/S15 35C9/C11/C13/C15 35S10/S12 35C10/C12
	100008	504060351	Paracolpo balestra posteriore <i>Rear leaf spring buffer</i>	DAILY CITY 2000 35S9/S10/S11/S12/S13/S15

**PARACOLPI SOSPENSIONI
SUSPENSION BUFFERS**

Illustrazione <i>Illustration</i>	Ns.Rif. <i>Our Ref.</i>	Rif.Costr. <i>O.E. Ref.</i>	Descrizione <i>Description</i>	Tipo di veicolo <i>Vehicle Type</i>
	100013	99470924	Paracolpo balestra posteriore Rear leaf spring buffer (ESaurIMENTO)	DAILY CITY 2000 35S9/S10/S11/S12/S13
	100014	93803992	Paracolpo balestra posteriore Rear leaf spring buffer	NEW DAILY DAILY RESTYLING DAILY CITY 2000 35C9/C11/C13/C15 50C11/C13/C15
	100016	93814245	Paracolpo balestra posteriore Rear leaf spring buffer (ESaurIMENTO)	TURBODAILY '96 59.12 DAILY CITY 2000 65C11/C13/C15
	100912	500316838	Tampone paracolpo superiore sospensione anteriore <i>Front suspension higher</i> buffer	DAILY CITY 2000 35S9/S11/S13/S15 35C9/C11/C13/C15 35S10/S12 35C10/C12
	100913	500316841	Tampone paracolpo inferiore sospensione anteriore <i>Front suspension lower</i> buffer	DAILY CITY 2000 35S9/S11/S13/S15 35C9/C11/C13/C15 35S10/S12 35C10/C12
	100914	500320322	Tampone paracolpo sospensione posteriore <i>Rear suspension buffer</i>	DAILY CITY 2000 35C9/C10/C11/C12/C13/C15

ARTICOLI VARI VARIOUS PARTS

Illustrazione <i>Illustration</i>	Ns.Rif. <i>Our Ref.</i>	Rif.Costr. <i>O.E. Ref.</i>	Descrizione <i>Description</i>	Tipo di veicolo <i>Vehicle Type</i>
	100606	93911172	Cuffia leva marce <i>Gear lever protective hood</i>	DAILY T.T.
	953016	93806182	Giunto elastico sterzo <i>Steering flexible coupling</i>	DAILY T.T.
	100032	500329485	Tassello gomma sostegno silenziatore <i>Holding exhaust dowel</i>	DAILY CITY 2000 35S9/S11/S13/S15 35C9/C11/C13/C15 50C11/C13/C15 65C13/C15
	103613	4600893	Anello tenuta sfiato olio <i>Oil breather tightness ring</i>	DAILY T.T.

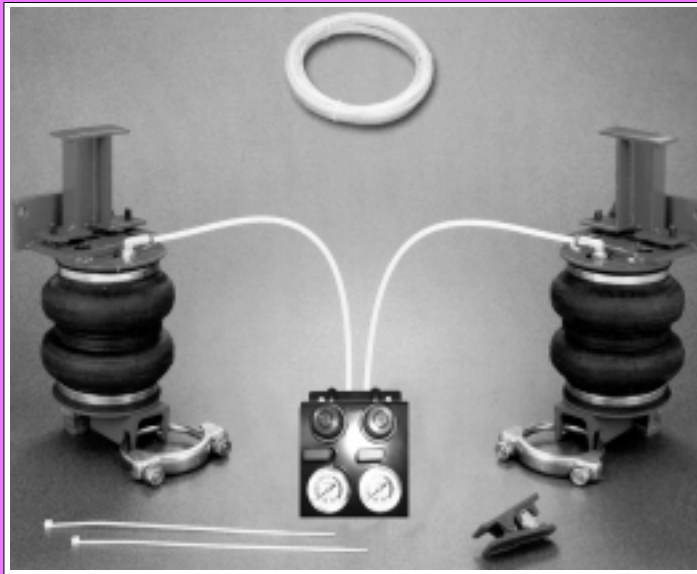

Ns.Rif. <i>Ns.Ref.</i>	Rif. O.E. <i>O.E. Ref.</i>	Taratura <i>Calibration</i>
103405	-	2,5 Bar
103405.1	-	4 Bar

Applicazione tipo veicolo
Vehicle type

DAILY M.Y. 2006
DAILY CITY 2000
35S9/S11/S13
35C9/C11/C13
DAILY RESTYLING
NEW DAILY
TURBO DAILY
DAILY 96

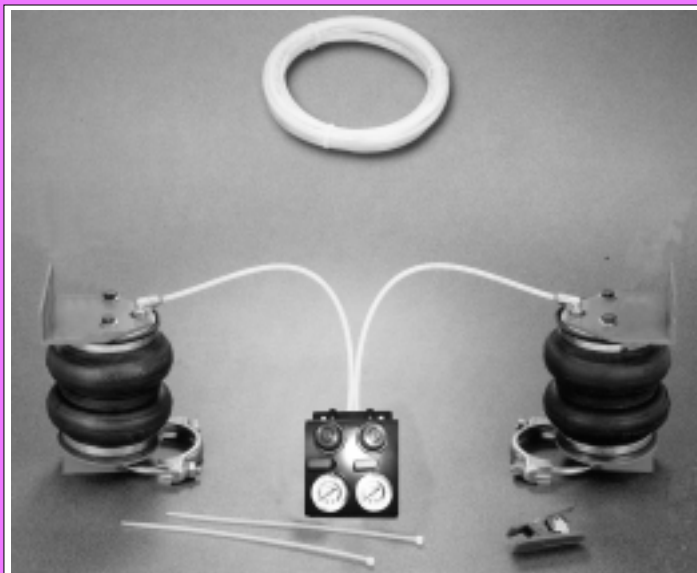

Ns.Rif. <i>Ns.Ref.</i>	Rif. O.E. <i>O.E. Ref.</i>	Taratura <i>Calibration</i>
103418	-	2,5 Bar
103418.1	-	4 Bar

Applicazione tipo veicolo
Vehicle type

DAILY CITY 2000
Ruota singola
Single wheel

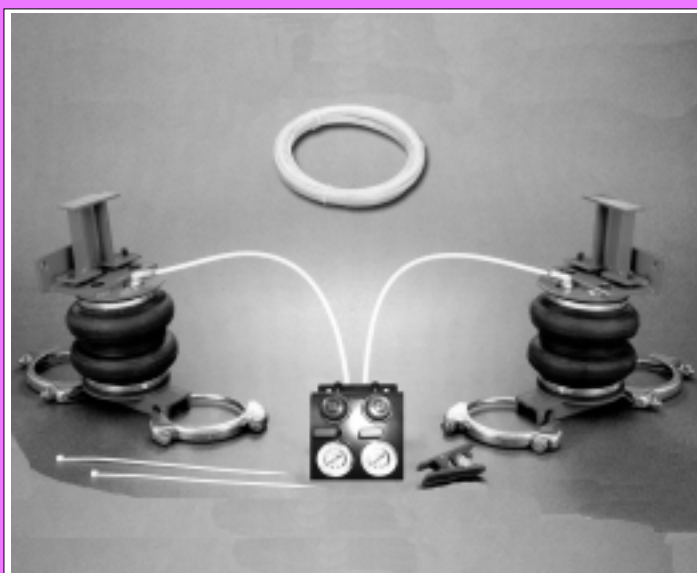

Ns.Rif. <i>Ns.Ref.</i>	Rif. O.E. <i>O.E. Ref.</i>	Taratura <i>Calibration</i>
103404	-	2,5 Bar
103404.1	-	4 Bar

Applicazione tipo veicolo
Vehicle type

TURBODAILY
59.12

**PARTI DI RICAMBIO
SPARE PARTS**

EMMERRE



**Ns.Rif.
Ns.Ref.**

**Rif. O.E.
O.E. Ref.**

103500

-

**Applicazione tipo veicolo
Vehicle type**

Torpress per veicoli leggeri
(Torpress for light vehicle)

**Ns.Rif.
Ns.Ref.**

**Rif. O.E.
O.E. Ref.**

**Taratura
Calibration**

103515.1

-

2,5 Bar

103515.2

-

4 Bar

**Applicazione tipo veicolo
Vehicle type**

Kit impianto pneumatico taratura (2,5 Bar)
Pneumatic system calibration (2,5 Bar)

Kit impianto pneumatico taratura (4 Bar)
Pneumatic system calibration (4 Bar)



KIT COMPRESSORE MONOCILINDRICO C/SERBATOIO 5 LT. - 12V
KIT MONO CYLINDRIC COMPRESSOR WITH TANC 5 LT - 12V

Ns.Rif.
Ns.Ref.

970008

Rif. O.E.
O.E. Ref.

-

Applicazione tipo veicolo
Vehicle type

 Veicoli leggeri T.T.
 Light vehicles

KIT COMPRESSORE BICILINDRICO C/SERBATOIO 5 LT. - 12V
KIT BICYLINDRIC COMPRESSOR WITH TANC 5 LT - 12V

Ns.Rif.
Ns.Ref.

970009

Rif. O.E.
O.E. Ref.

-

Applicazione tipo veicolo
Vehicle type

 Veicoli leggeri T.T.
 Light vehicles

KIT COMPRESSORI ARIA
KIT AIR COMPRESSOR

EMMERRE

KIT COMPRESSORE MONOCILINDRICO C/SERBATOIO 5 LT. - 24V
KIT MONO CYLINDRIC COMPRESSOR WITH TANC 5 LT - 24V



Ns.Rif. <i>Ns.Ref.</i>	Rif. O.E. <i>O.E. Ref.</i>	
970003	-	

Applicazione tipo veicolo
Vehicle type

Veicoli leggeri T.T.
Light vehicles

KIT COMPRESSORE BICILINDRICO C/SERBATOIO 5 LT. - 24V
KIT BICYLINDRIC COMPRESSOR WITH TANC 5 LT - 24V



Ns.Rif. <i>Ns.Ref.</i>	Rif. O.E. <i>O.E. Ref.</i>	
970005	-	

Applicazione tipo veicolo
Vehicle type

Veicoli leggeri T.T.
Light vehicles

EMMERRE *Presenta***AIR FREN***Freno motore ad aria per veicoli commerciali Common Rail*

I freni del vostro autocarro, a disco o a tamburo, singoli o doppi che siano, sono soggetti a forti sollecitazioni, possono quindi facilmente surriscaldarsi diminuendo le loro prestazioni sino a compromettere il livello di sicurezza del guidatore o del carico.

Il surriscaldamento provoca, inoltre, pericolose deformazioni nell'impianto con conseguente anomala usura dei freni che determina un'ulteriore, quanto irreversibile, diminuzione dell'efficienza dell'intero sistema frenante.

Risulta evidente come tutto ciò comporti un

notevole aumento dei costi. Il freno motore ad aria AIR FREN, applicato sui veicoli commerciali, integra l'azione del sistema frenante e contribuisce in misura determinante alla soluzione di questi problemi.

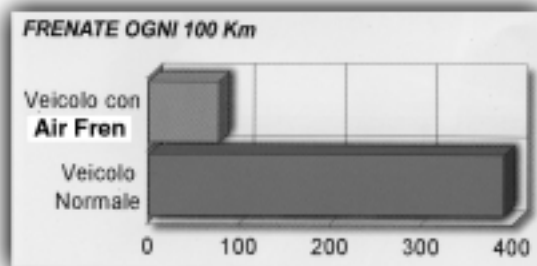

Il miglioramento è evidenziato anche dal fatto che il freno motore ad aria AIR FREN riduce drasticamente il numero di frenate necessarie per un percorso medio di 100 Km.

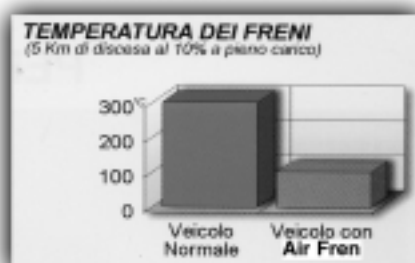

Test effettuati dimostrano come anche un breve tragitto in discesa, 5 Km, possa mettere seriamente in crisi il sistema frenante di un veicolo commerciale. L'utilizzo dell' AIR FREN consente di riportare la temperatura dei freni entro i normali limiti di funzionamento.

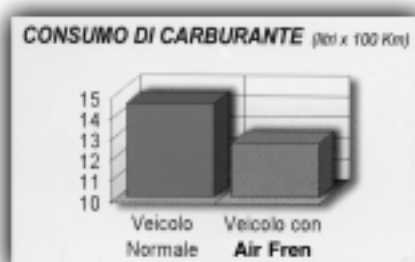

Grazie alla particolare azione sviluppata dal freno motore ad aria, vengono ridotti anche i consumi di carburante. I test dimostrano come un veicolo commerciale che utilizzi questo sistema sia in grado di risparmiare circa il 15% di carburante arrivando a percorrenze medie impensabili per i veicoli che ne sono sprovvisti.

FRENO MOTORE AD ARIA
AIR ENGINE BRAKE

EMMERRE

**503430 IVECO Daily 35C11-13-15 - 35S11-13-15
50C13 - 65C15**



(ADESAURIMENTO)

KIT FRENO MOTORE ELETTRICO
KIT ELECTRIC ENGINE BRAKE



Ns.Rif.
Ns.Ref.

304000

Rif. O.E.
O.E. Ref.

1411100

Applicazione tipo veicolo
Vehicle type

Veicoli leggeri T.T.
Light vehicles

TIPO DI VEICOLO / VEHICLE TYPE

MERCEDES VITO 108CDI 2.2 - 108D 2.3
(Autobus e Furgonato) 110CDI 2.2 - 110TD 2.3
 112CDI 2.2
 113 2.0
 114 2.3

ILLUSTRAZIONE / ILLUSTRATION

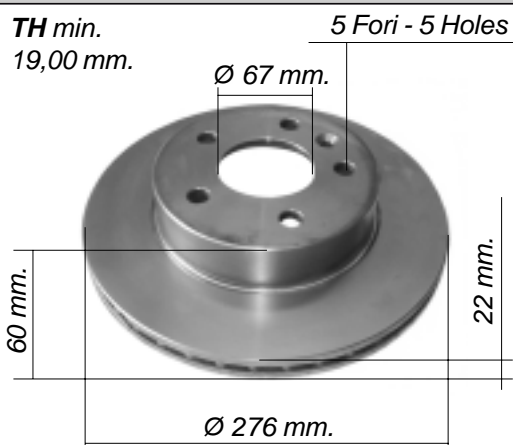
NOSTRO RIFERIMENTO
OUR REFERENCE**960333**RIFERIMENTO COSTRUTTORE
O.E. REFERENCE

6384210112

DESCRIZIONE / DESCRIPTION

Disco freno assale anteriore
 Brake disc front axle

Fascia AUTOVENTILANTE
 SELF-VENTILATED Band



ILLUSTRAZIONE / ILLUSTRATION

NOSTRO RIFERIMENTO
OUR REFERENCE**960921**RIFERIMENTO COSTRUTTORE
O.E. REFERENCE

0024203920
 0024209920

DESCRIZIONE / DESCRIPTION

Serie pastiglie freno anteriore - Set of brake pads front

WVA	Larghezza Width - mm.	Altezza Height - mm.	Spessore Thickness - mm.
21576 21577	156	64	20



ILLUSTRAZIONE / ILLUSTRATION

Tondo - Round

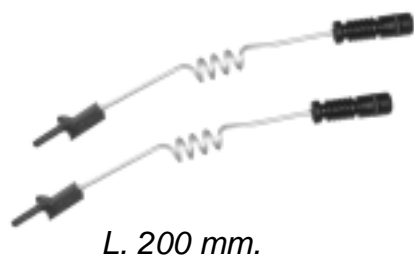
NOSTRO RIFERIMENTO
OUR REFERENCE**960915**RIFERIMENTO COSTRUTTORE
O.E. REFERENCE

9015400017
 9015400117

DESCRIZIONE / DESCRIPTION

Kit segnalatori usura freno anteriore e posteriore (2 pz)
 Set of brake wear indicators front and rear (2 pcs)

TIPO DI VEICOLO / VEHICLE TYPE

MERCEDES VITO 108CDI 2.2 - 108D 2.3
(Autobus e Furgonato) 110CDI 2.2 - 110TD 2.3
 112CDI 2.2
 113 2.0
 114 2.3

ILLUSTRAZIONE / ILLUSTRATION

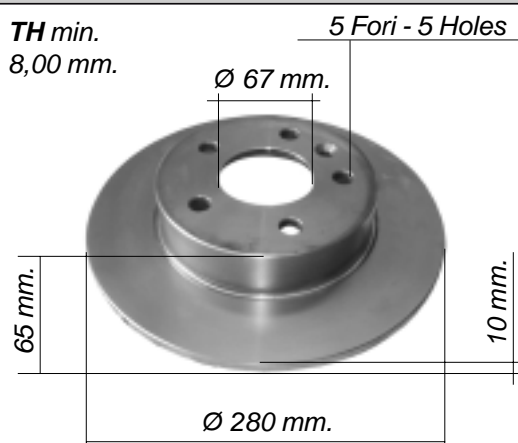

NOSTRO RIFERIMENTO OUR REFERENCE

960334

RIFERIMENTO COSTRUTTORE O.E. REFERENCE

6384230112

DESCRIZIONE / DESCRIPTION

Disco freno assale posteriore
 Brake disc rear axle



ILLUSTRAZIONE / ILLUSTRATION



NOSTRO RIFERIMENTO OUR REFERENCE

960926

RIFERIMENTO COSTRUTTORE O.E. REFERENCE

0024204820 - 003420020
 6384230110

DESCRIZIONE / DESCRIPTION

Serie pastiglie freno posteriore- Set of brake pads rear

WVA	Larghezza Width - mm.	Altezza Height -mm.	Spessore Thickness - mm.
21904 21278	63	57	17



ILLUSTRAZIONE / ILLUSTRATION

Tondo - Round

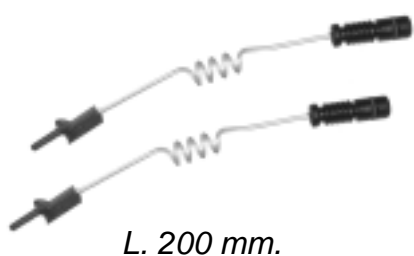

NOSTRO RIFERIMENTO OUR REFERENCE

960915

RIFERIMENTO COSTRUTTORE O.E. REFERENCE

9015400017
 9015400117

DESCRIZIONE / DESCRIPTION

Kit segnalatori usura freno anteriore e posteriore (2 pz)
 Set of brake wear indicators front and rear (2 pcs)

TIPO DI VEICOLO / VEHICLE TYPE

SPRINTER (Autobus - Furgonato e pianale piatto)

208CDI - 211CDI - 213CDI - 216CDI (dal 04/2000 - from 04/2000) - 308CDI - 311CDI - 313CDI
316CDI (dal 04/2000 - from 04/2000) - 411CDI - 413CDI - 416CDI (dal 04/2000 - from 04/2000)
214 - 314 - 414 (da 02/95 - from 02/95) - 408 - 411 - 413 - 414 - 416 (dal 04/00 - from 04/00)

ILLUSTRAZIONE / ILLUSTRATION	NOSTRO RIFERIMENTO OUR REFERENCE	RIFERIMENTO COSTRUTTORE O.E. REFERENCE												
	960324	9024210612 - 9024210412 9024210312 - 9024210712												
DESCRIZIONE / DESCRIPTION														
Disco freno assale anteriore Brake disc front axle														
Fascia AUTOVENTILANTE SELF-VENTILATED Band														
ILLUSTRAZIONE / ILLUSTRATION	NOSTRO RIFERIMENTO OUR REFERENCE	RIFERIMENTO COSTRUTTORE O.E. REFERENCE												
	960921	0024203920 - 0024209920												
DESCRIZIONE / DESCRIPTION														
Serie pastiglie freno anteriore - Set of brake pads front														
<table border="1"> <thead> <tr> <th>WVA</th> <th>Larghezza Width - mm.</th> <th>Altezza Height - mm.</th> <th>Spessore Thickness - mm.</th> </tr> </thead> <tbody> <tr> <td>21576</td> <td>156</td> <td>64</td> <td>20</td> </tr> <tr> <td>21577</td> <td></td> <td></td> <td></td> </tr> </tbody> </table>			WVA	Larghezza Width - mm.	Altezza Height - mm.	Spessore Thickness - mm.	21576	156	64	20	21577			
WVA	Larghezza Width - mm.	Altezza Height - mm.	Spessore Thickness - mm.											
21576	156	64	20											
21577														
ILLUSTRAZIONE / ILLUSTRATION	NOSTRO RIFERIMENTO OUR REFERENCE	RIFERIMENTO COSTRUTTORE O.E. REFERENCE												
	960920	0004237110 - 0024204120 0024204220 - 0034201720 9024210110												
DESCRIZIONE / DESCRIPTION														
Serie pastiglie freno anteriore e posteriore Set of brake pads front and rear														
<table border="1"> <thead> <tr> <th>WVA</th> <th>Larghezza Width - mm.</th> <th>Altezza Height - mm.</th> <th>Spessore Thickness - mm.</th> </tr> </thead> <tbody> <tr> <td>29076</td> <td>165</td> <td>73</td> <td>20</td> </tr> </tbody> </table>			WVA	Larghezza Width - mm.	Altezza Height - mm.	Spessore Thickness - mm.	29076	165	73	20				
WVA	Larghezza Width - mm.	Altezza Height - mm.	Spessore Thickness - mm.											
29076	165	73	20											
ILLUSTRAZIONE / ILLUSTRATION	NOSTRO RIFERIMENTO OUR REFERENCE	RIFERIMENTO COSTRUTTORE O.E. REFERENCE												
	960915	9015400017 - 9015400117												
DESCRIZIONE / DESCRIPTION														
Kit segnalatori usura freno anteriore e posteriore (2 pz) Set of brake wear indicators front and rear (2 pcs)														

TIPO DI VEICOLO / VEHICLE TYPE

SPRINTER (Autobus - Furgonato e pianale piatto)

208CDI - 211CDI - 213CDI - 216CDI (dal 04/2000 - from 04/2000)

308CDI - 311CDI - 313CDI - 316CDI (dal 04/2000 - from 04/2000)

411CDI - 413CDI - 416CDI (dal 04/2000 - from 04/2000)

214 - 314 - 414 (da 02/95 - from 02/95)

408 - 411 - 413 - 414 - 416 (dal 04/00 - from 04/00)

310D - 312D - 408D - 410D (05/97-08/02)

ILLUSTRAZIONE / ILLUSTRATION

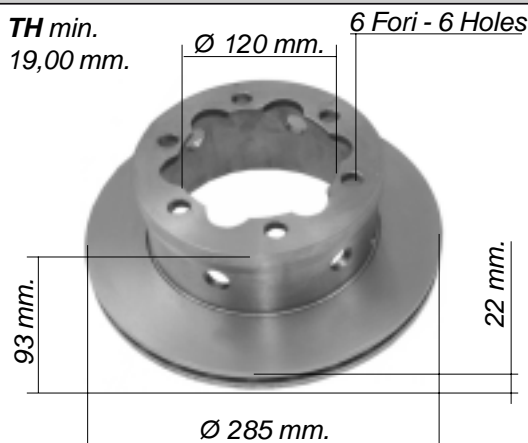

NOSTRO RIFERIMENTO OUR REFERENCE

960323

RIFERIMENTO COSTRUTTORE O.E. REFERENCE

9044230312
9044230212

DESCRIZIONE / DESCRIPTION

Disco freno assale posteriore
Brake disc rear axle

Fascia AUTOVENTILANTE
SELF-VENTILATED Band



ILLUSTRAZIONE / ILLUSTRATION



NOSTRO RIFERIMENTO OUR REFERENCE

960920

RIFERIMENTO COSTRUTTORE O.E. REFERENCE

0004237110 - 0024204120
0024204220 - 0034201720
9024210110

DESCRIZIONE / DESCRIPTION

Serie pastiglie freno anteriore e posteriore
Set of brake pads front and rear

WVA	Larghezza Width - mm.	Altezza Height - mm.	Spessore Thickness - mm.
29076	165	73	20



ILLUSTRAZIONE / ILLUSTRATION

Tondo - Round



L. 200 mm.

NOSTRO RIFERIMENTO OUR REFERENCE

960915

RIFERIMENTO COSTRUTTORE O.E. REFERENCE

9015400017
9015400117

DESCRIZIONE / DESCRIPTION

Kit segnalatori usura freno anteriore e posteriore (2 pz)
Set of brake wear indicators front and rear (2 pcs)

TIPO DI VEICOLO / VEHICLE TYPE

SPRINTER (Autobus - Furgonato e pianale piatto)

208CDI - 211CDI - 213CDI - 216CDI (dal 04/2000 - from 04/2000)

308CDI - 311CDI - 313CDI - 316CDI (dal 04/2000 - from 04/2000)

411CDI - 413CDI - 416CDI (dal 04/2000 - from 04/2000)

214 - 314 - 414 (da 02/95 - from 02/95)

408 - 411 - 413 - 414 - 416 (dal 04/00 - from 04/00)

310D - 312D - 408D - 410D (05/97-08/02)

ILLUSTRAZIONE / ILLUSTRATION

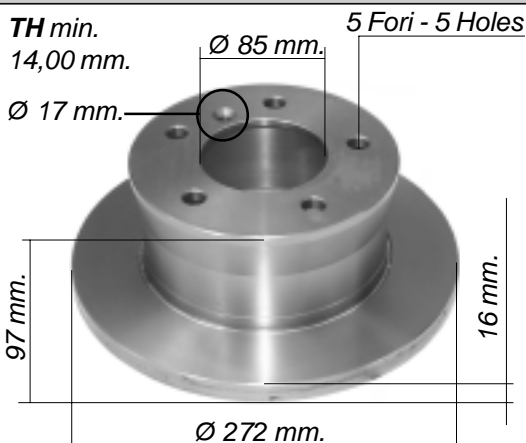
NOSTRO RIFERIMENTO
OUR REFERENCERIFERIMENTO COSTRUTTORE
O.E. REFERENCE**960325**

9024230312 - 9024230112

DESCRIZIONE / DESCRIPTION

Disco freno assale posteriore
Brake disc rear axle

ILLUSTRAZIONE / ILLUSTRATION

NOSTRO RIFERIMENTO
OUR REFERENCERIFERIMENTO COSTRUTTORE
O.E. REFERENCE**E3 90R****960922**0024204020 - 0024206020
9024230510

DESCRIZIONE / DESCRIPTION

Serie pastiglie freno posteriore - Set of brake pads rear

WVA	Larghezza Width - mm.	Altezza Height - mm.	Spessore Thickness - mm.
21592 21593	156	55	18



ILLUSTRAZIONE / ILLUSTRATION

NOSTRO RIFERIMENTO
OUR REFERENCERIFERIMENTO COSTRUTTORE
O.E. REFERENCE

Tondo-Round

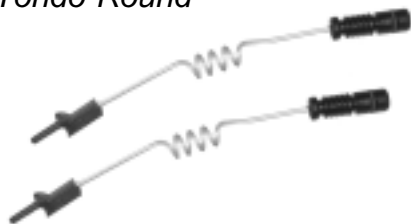

L. 200 mm.

9609159015400017
9015400117

DESCRIZIONE / DESCRIPTION

Kit segnalatori usura freno anteriore e posteriore (2 pz)
Set of brake wear indicators front and rear (2 pcs)

TIPO DI VEICOLO / VEHICLE TYPE

SPRINTER (Autobus - Furgonato e pianale piatto)

208CDI - 211CDI - 213CDI - 216CDI (dal 04/2000 - from 04/2000)

308CDI - 311CDI - 313CDI - 316CDI (dal 04/2000 - from 04/2000)

411CDI - 413CDI - 416CDI (dal 04/2000 - from 04/2000)

214 - 314 - 414 (da 02/95 - from 02/95)

408 - 411 - 413 - 414 - 416 (dal 04/00 - from 04/00)

310D - 312D - 408D - 410D (05/97-08/02)

ILLUSTRAZIONE / ILLUSTRATION

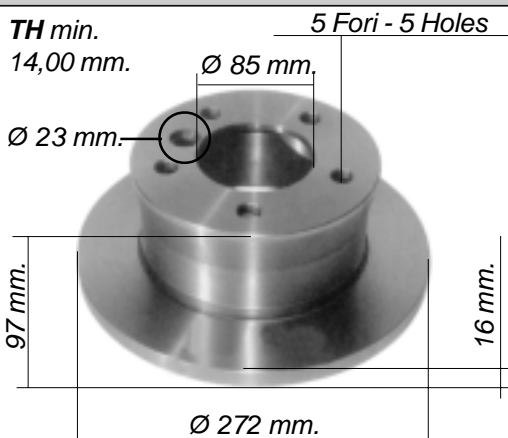

NOSTRO RIFERIMENTO OUR REFERENCE

960390

RIFERIMENTO COSTRUTTORE O.E. REFERENCE

9024230412
2D0615601D

DESCRIZIONE / DESCRIPTION

Disco freno assale posteriore
Brake disc rear axle



ILLUSTRAZIONE / ILLUSTRATION



E3 90R

NOSTRO RIFERIMENTO OUR REFERENCE

960922

RIFERIMENTO COSTRUTTORE O.E. REFERENCE

0024204020 - 0024206020
9024230510

DESCRIZIONE / DESCRIPTION

Serie pastiglie freno posteriore - Set of brake pads rear

WVA	Larghezza Width - mm.	Altezza Height - mm.	Spessore Thickness - mm.
21592	156	55	18
21593			



ILLUSTRAZIONE / ILLUSTRATION

Tondo-Round



L. 200 mm.

NOSTRO RIFERIMENTO OUR REFERENCE

960915

RIFERIMENTO COSTRUTTORE O.E. REFERENCE

9015400017
9015400117

DESCRIZIONE / DESCRIPTION

Kit segnalatori usura freno anteriore e posteriore (2 pz)
Set of brake wear indicators front and rear (2 pcs)

TIPO DI VEICOLO / VEHICLE TYPE

MERCEDES SPRINTER

208CDI - 211CDI - 213CDI - 214 - 214NGT - 216CDI

308CDI - 310D - 311CDI - 312CDI - 313CDI - 314CDI - 316CDI

408D - 410D - 411CDI - 412D - 413CDI - 414CDI - 416CDI

VOLKSWAGEN

LT 28-35 2.5 SDI-TDI - LT 28-46 2.5-2.8 TDI

ILLUSTRAZIONE / ILLUSTRATION

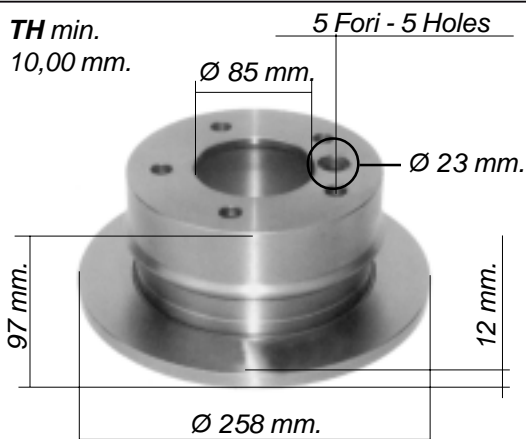
NOSTRO RIFERIMENTO
OUR REFERENCE**960391**RIFERIMENTO COSTRUTTORE
O.E. REFERENCE9014230812
2D0615601C

DESCRIZIONE / DESCRIPTION

Disco freno assale posteriore
Brake disc rear axle

ILLUSTRAZIONE / ILLUSTRATION

NOSTRO RIFERIMENTO
OUR REFERENCE**960922**RIFERIMENTO COSTRUTTORE
O.E. REFERENCE0024204020 - 0024206020
9024230510

DESCRIZIONE / DESCRIPTION

Serie pastiglie freno posteriore - Set of brake pads rear

WVA	Larghezza Width - mm.	Altezza Height - mm.	Spessore Thickness - mm.
21592 21593	156	55	18



ILLUSTRAZIONE / ILLUSTRATION

Tondo - Round

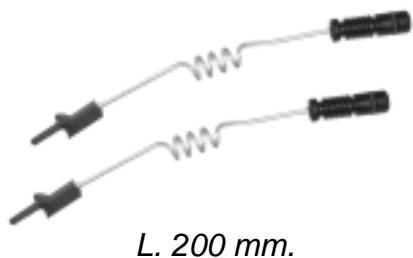

L. 200 mm.

NOSTRO RIFERIMENTO
OUR REFERENCE**960915**RIFERIMENTO COSTRUTTORE
O.E. REFERENCE9015400017
9015400117

DESCRIZIONE / DESCRIPTION

Kit segnalatori usura freno anteriore e posteriore (2 pz)
Set of brake wear indicators front and rear (2 pcs)

TIPO DI VEICOLO / VEHICLE TYPE

MERCEDES SPRINTER U.T.

209CDI - 211CDI - 215CDI - 218CDI - 309CDI - 311D - 315CDI - 318CDI
509CDI - 511CDI - 515CDI - 518CDI
(DAL 06/2006 - FROM 06/2006)

ILLUSTRAZIONE / ILLUSTRATION

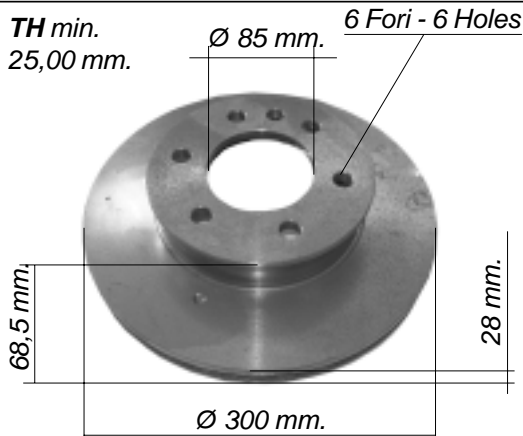

NOSTRO RIFERIMENTO OUR REFERENCE

960564

RIFERIMENTO COSTRUTTORE O.E. REFERENCE

9064210012

DESCRIZIONE / DESCRIPTION

Disco freno assale anteriore
Brake disc front axle

Fascia AUTOVENTILANTE
SELF-VENTILATED Band



ILLUSTRAZIONE / ILLUSTRATION



NOSTRO RIFERIMENTO OUR REFERENCE

960890

RIFERIMENTO COSTRUTTORE O.E. REFERENCE

0054205220 - 0044208320

DESCRIZIONE / DESCRIPTION

Serie pastiglie freno anteriore - Set of brake pads front

WVA	Larghezza Width - mm.	Altezza Height - mm.	Spessore Thickness - mm.
29192	163.30	67.10	20.9



ILLUSTRAZIONE / ILLUSTRATION



PER VERSIONE - FOR VERSION
509CDI - 511CDI - 515CDI - 518CDI (2006)

NOSTRO RIFERIMENTO OUR REFERENCE

960427

RIFERIMENTO COSTRUTTORE O.E. REFERENCE

0044208220

DESCRIZIONE / DESCRIPTION

Serie pastiglie freno anteriore
Set of brake pads front

WVA	Larghezza Width - mm.	Altezza Height - mm.	Spessore Thickness - mm.
29200	169,10	73,20	20,80



ILLUSTRAZIONE / ILLUSTRATION



NOSTRO RIFERIMENTO OUR REFERENCE

960824

RIFERIMENTO COSTRUTTORE O.E. REFERENCE







9065401417 - 9065401517

DESCRIZIONE / DESCRIPTION

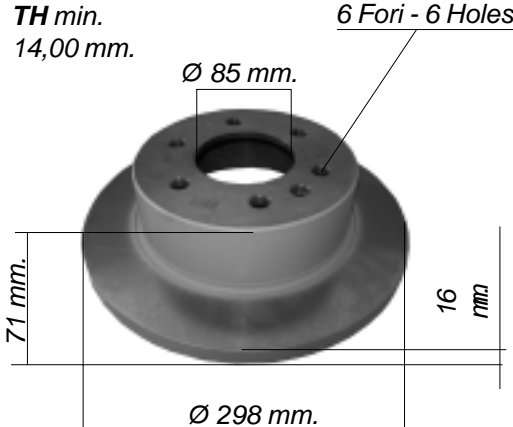
Kit segnalatori usura freno anteriore (2 pz)
Set of brake wear indicator front (2 pcs)

TIPO DI VEICOLO / VEHICLE TYPE

MERCEDES SPRINTER U.T.
209CDI - 211CDI - 215CDI - 218CDI
309CDI - 311D - 315CDI - 318CDI

ILLUSTRAZIONE / ILLUSTRATION	NOSTRO RIFERIMENTO OUR REFERENCE	RIFERIMENTO COSTRUTTORE O.E. REFERENCE								
	960565	9064230012								
DESCRIZIONE / DESCRIPTION										
<p>Disco freno assale posteriore Brake disc rear axle</p> 										
ILLUSTRAZIONE / ILLUSTRATION	NOSTRO RIFERIMENTO OUR REFERENCE	RIFERIMENTO COSTRUTTORE O.E. REFERENCE								
	960890	0054205220 - 0044208320								
DESCRIZIONE / DESCRIPTION										
<p>Serie pastiglie freno anteriore - Set of brake pads front</p> <table border="1" data-bbox="638 1254 1236 1377"> <thead> <tr> <th>WVA</th> <th>Larghezza Width - mm.</th> <th>Altezza Height - mm.</th> <th>Spessore Thickness - mm.</th> </tr> </thead> <tbody> <tr> <td>29192</td> <td>163.30</td> <td>67.10</td> <td>20.9</td> </tr> </tbody> </table> 			WVA	Larghezza Width - mm.	Altezza Height - mm.	Spessore Thickness - mm.	29192	163.30	67.10	20.9
WVA	Larghezza Width - mm.	Altezza Height - mm.	Spessore Thickness - mm.							
29192	163.30	67.10	20.9							
ILLUSTRAZIONE / ILLUSTRATION	NOSTRO RIFERIMENTO OUR REFERENCE	RIFERIMENTO COSTRUTTORE O.E. REFERENCE								
	960825	6395401417 6395401517								
DESCRIZIONE / DESCRIPTION										
<p>Kit segnalatori usura freno posteriore (2 pz) Set of brake wear indicators rear (2 pcs)</p>										
ILLUSTRAZIONE / ILLUSTRATION	NOSTRO RIFERIMENTO OUR REFERENCE	RIFERIMENTO COSTRUTTORE O.E. REFERENCE								
	960435	9015400317								
DESCRIZIONE / DESCRIPTION										
<p>Kit segnalatori usura freno (2 pz) Set of brake wear indicators (2 pcs)</p>										

TIPO DI VEICOLO / VEHICLE TYPE

MERCEDES SPRINTER U.T.
509CDI - 511CDI - 515CDI - 518CDI
(DAL 06/2006 - FROM 06/2006)

ILLUSTRAZIONE / ILLUSTRATION

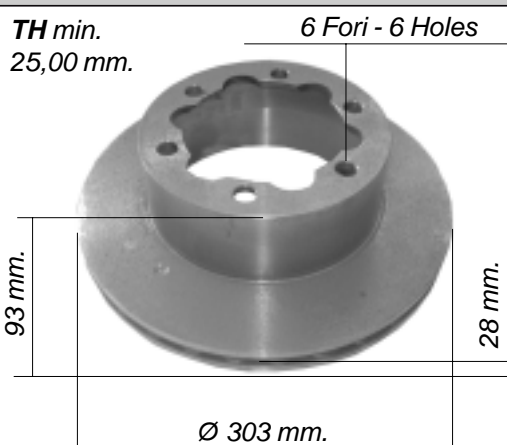

NOSTRO RIFERIMENTO OUR REFERENCE

960422

RIFERIMENTO COSTRUTTORE O.E. REFERENCE

9064230112

DESCRIZIONE / DESCRIPTION

Disco freno assale posteriore
Brake disc rear axle



ILLUSTRAZIONE / ILLUSTRATION



NOSTRO RIFERIMENTO OUR REFERENCE

960896

RIFERIMENTO COSTRUTTORE O.E. REFERENCE

0044208120

DESCRIZIONE / DESCRIPTION

Serie pastiglie freno posteriore - Set of brake pads rear

WVA	Larghezza Width - mm.	Altezza Height - mm.	Spessore Thickness - mm.
29122	165	79	20,80



ILLUSTRAZIONE / ILLUSTRATION



NOSTRO RIFERIMENTO OUR REFERENCE

960825

RIFERIMENTO COSTRUTTORE O.E. REFERENCE

6395401417
6395401517

DESCRIZIONE / DESCRIPTION

Kit segnalatori usura freno posteriore (2 pz)
Set of brake wear indicators rear (2 pcs)

TIPO DI VEICOLO / VEHICLE TYPE

MERCEDES (Autobus - Furgonato e pianale piatto)

207D 2.4 - 208 2.3 - 208D 2.3 - 210 2.3 - 210D 2.8 (05/77-02/96)

308D 2.3 - 310D 2.9 (06/89-02/96)

ILLUSTRAZIONE / ILLUSTRATION

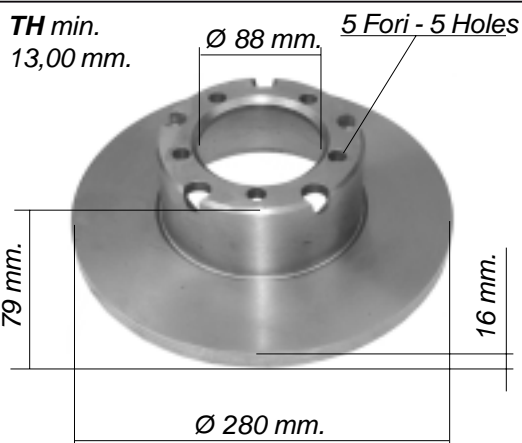
NOSTRO RIFERIMENTO
OUR REFERENCERIFERIMENTO COSTRUTTORE
O.E. REFERENCE**960326**6014200272 - 6014200072
6014215112

DESCRIZIONE / DESCRIPTION

Disco freno assale anteriore
Brake disc front axle

ILLUSTRAZIONE / ILLUSTRATION

NOSTRO RIFERIMENTO
OUR REFERENCERIFERIMENTO COSTRUTTORE
O.E. REFERENCE**960967**

6694210008 - 6015860042

DESCRIZIONE / DESCRIPTION

Serie pastiglie freno anteriore - Set of brake pads front

WVA	Larghezza Width - mm.	Altezza Height - mm.	Spessore Thickness - mm.
20784	149	75	18

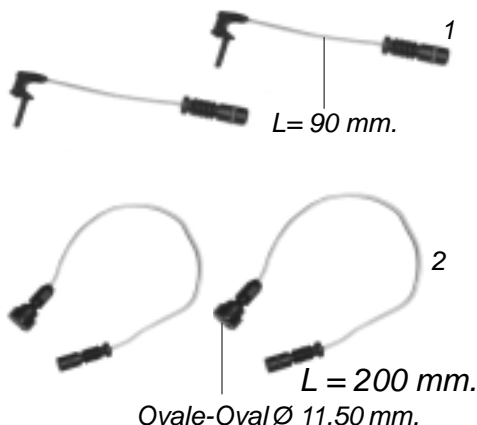

ILLUSTRAZIONE / ILLUSTRATION

NOSTRO RIFERIMENTO
OUR REFERENCERIFERIMENTO COSTRUTTORE
O.E. REFERENCE**960842**

0005400217 - 1405401217 (1)

960813

6015400617 (2)

DESCRIZIONE / DESCRIPTION

Kit segnalatori usura freno anteriore (2 pz.)
Set of brake wear indicators front (2 pcs)Kit segnalatori usura freno a tamburo posteriore (2 pz.)
Set of brake wear indicators rear for brake drum (2 pcs)

TIPO DI VEICOLO / VEHICLE TYPE

MERCEDES

508D (03/89-12/94)
510 (04/86-12/94)
L 608D (01/70-12/88)
L 613D (04/77-12/88)

ILLUSTRAZIONE / ILLUSTRATION

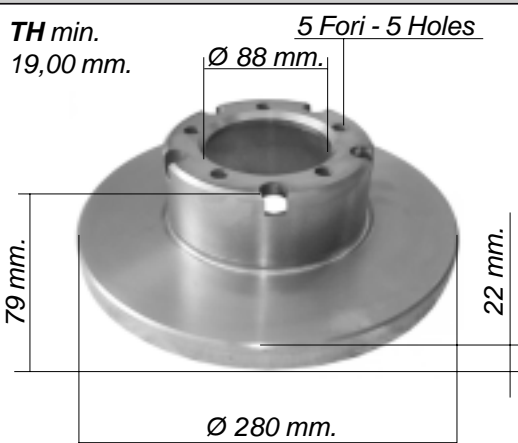

NOSTRO RIFERIMENTO
OUR REFERENCE

960335

RIFERIMENTO COSTRUTTORE
O.E. REFERENCE

6014200372 - 6014200172
6014210312

DESCRIZIONE / DESCRIPTION

Disco freno assale anteriore
Brake disc front axle



ILLUSTRAZIONE / ILLUSTRATION



NOSTRO RIFERIMENTO
OUR REFERENCE

960967

RIFERIMENTO COSTRUTTORE
O.E. REFERENCE

6694210008

DESCRIZIONE / DESCRIPTION

Serie pastiglie freno anteriore - Set of brake pads front

WVA	Larghezza Width - mm.	Altezza Height - mm.	Spessore Thickness - mm.
20784	149	75	18



ILLUSTRAZIONE / ILLUSTRATION

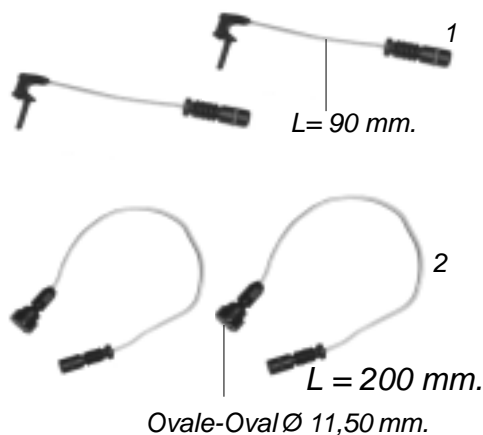

NOSTRO RIFERIMENTO
OUR REFERENCE

960842

960813

RIFERIMENTO COSTRUTTORE
O.E. REFERENCE

0005400217 - 1405401217 (1)

6015400617 (2)

DESCRIZIONE / DESCRIPTION

Kit segnalatori usura freno anteriore (2 pz.)
Set of brake wear indicators front (2 pcs)

Kit segnalatori usura freno a tamburo posteriore (2 pz.)
Set of brake wear indicators rear for brake drum (2 pcs)

TIPO DI VEICOLO / VEHICLE TYPE

MERCEDES

609D - 709D - 711D (03/1985)

ILLUSTRAZIONE / ILLUSTRATION

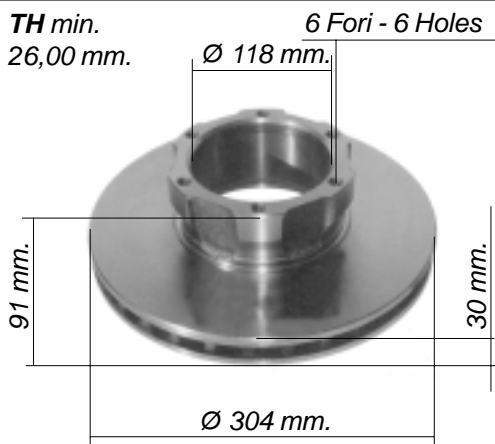
NOSTRO RIFERIMENTO
OUR REFERENCE**960319**RIFERIMENTO COSTRUTTORE
O.E. REFERENCE66942 10612
66942 10112

DESCRIZIONE / DESCRIPTION

Disco freno assale anteriore
Brake disc front axleFascia AUTOVENTILANTE
SELF-VENTILATED Band

ILLUSTRAZIONE / ILLUSTRATION

NOSTRO RIFERIMENTO
OUR REFERENCE**960946**RIFERIMENTO COSTRUTTORE
O.E. REFERENCE6704202820 - 6694200020
6694200120

DESCRIZIONE / DESCRIPTION

Serie pastiglie freno anteriore - Set of brake pads front

WVA	Larghezza Width - mm.	Altezza Height - mm.	Spessore Thickness - mm.
29835	175	85	22

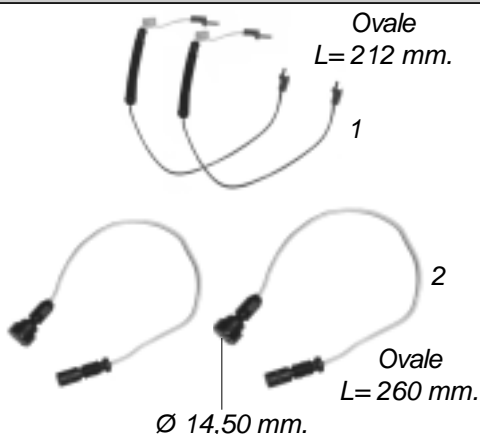

ILLUSTRAZIONE / ILLUSTRATION

NOSTRO RIFERIMENTO
OUR REFERENCE**960916****960809**RIFERIMENTO COSTRUTTORE
O.E. REFERENCE

6695400417 (1)

6705400017 (2)

DESCRIZIONE / DESCRIPTION

Kit segnalatori usura freno anteriore (2 pz.)
Set of brake wear indicators front (2 pcs)Kit segnalatori usura freno a tamburo posteriore (2 pz.)
Set of brake wear indicators rear for brake drum (2 pcs)

TIPO DI VEICOLO / VEHICLE TYPE

MERCEDES
809D - 811D (03/1985)

ILLUSTRAZIONE / ILLUSTRATION

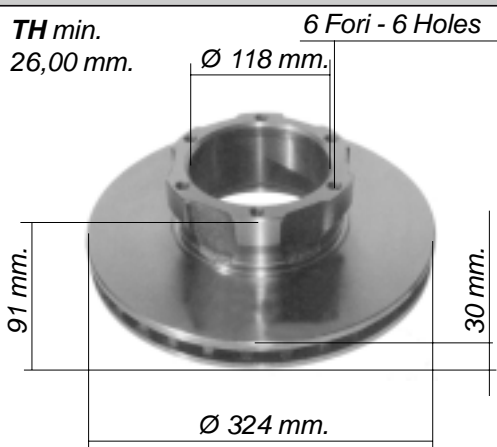

NOSTRO RIFERIMENTO
OUR REFERENCE

960318

RIFERIMENTO COSTRUTTORE
O.E. REFERENCE

6704210312
6704210112 - 6684210212

DESCRIZIONE / DESCRIPTION

Disco freno assale anteriore
Brake disc front axle

Fascia AUTOVENTILANTE
SELF-VENTILATED Band



ILLUSTRAZIONE / ILLUSTRATION



NOSTRO RIFERIMENTO
OUR REFERENCE

960946

RIFERIMENTO COSTRUTTORE
O.E. REFERENCE

6704202820 - 6694200020
6694200120

DESCRIZIONE / DESCRIPTION

Serie pastiglie freno anteriore - Set of brake pads front

WVA	Larghezza Width - mm.	Altezza Height - mm.	Spessore Thickness - mm.
29835	175	85	22



ILLUSTRAZIONE / ILLUSTRATION

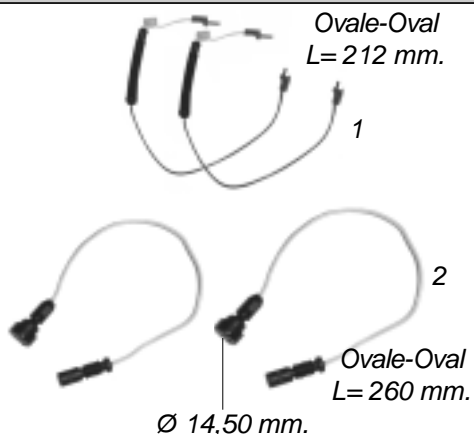

NOSTRO RIFERIMENTO
OUR REFERENCE

960916

RIFERIMENTO COSTRUTTORE
O.E. REFERENCE

6695400417 (1)

960809

6705400017 (2)

DESCRIZIONE / DESCRIPTION

Kit segnalatori usura freno anteriore (2 pz.)
Set of brake wear indicators front (2 pcs)

Kit segnalatori usura freno a tamburo posteriore (2 pz.)
Set of brake wear indicators rear for brake drum (2 pcs)



	Ns Riferim. Our Ref.	Rif. Costr. O.E. Ref.	Descrizione/Tipo di veicolo Description/Vehicle Type
<p><i>Impianto / System ATE</i></p>  <p>AD ESAURIMENTO</p>	962543	-	<p><i>Serie ganasce freno posteriori</i> <i>Rear brake shoe set</i></p> <p>Sprinter dal / from 1995</p>
<p><i>Impianto / System GIRLING</i></p>  <p>AD ESAURIMENTO</p>	962544	113602P	<p><i>Serie ganasce freno posteriori</i> <i>Rear brake shoe set</i></p> <p>MB 80 <i>dal/from 1993 al/to 10/1995</i></p> <p>MB 100 - 140 - 180 <i>dal/from 1988 al/to 10/1995</i></p>

Illustrazione <i>Illustration</i>	Ns.Rif. <i>Our Ref.</i>	Rif.Costr. <i>O.E. Ref.</i>	Descrizione <i>Description</i>	Tipo di veicolo <i>Vehicle Type</i>
 <p>Ø 156 mm</p> <p>Ø 460 mm</p>	907270	0032050306	Ventilatore aria nylon (9 pale) Nylon blower (9 blade) AD ESAURIMENTO UNTILL OUT OF STOCK	SPRINTER 210D - 212D 310D - 312D 412D
 <p>Ø 160 mm</p> <p>Ø 460 mm</p>	907271	0032051306	Ventilatore aria nylon (9 pale) Nylon blower (9 blade)	SPRINTER 210D - 212D 310D - 312D 410D - 412D
 <p>Ø 135 mm</p> <p>Ø 428 mm</p>	907274	1032000423	Ventilatore aria nylon (9 pale) Nylon blower (9 blade) AD ESAURIMENTO UNTILL OUT OF STOCK	SPRINTER CDI 124 - 126 201 - 202



Ns.Rif. <i>Ns.Ref.</i>	Rif. O.E. <i>O.E. Ref.</i>	Taratura <i>Calibration</i>
103402	-	2,5 Bar
103402.1	-	4 Bar

Applicazione tipo veicolo
Vehicle type

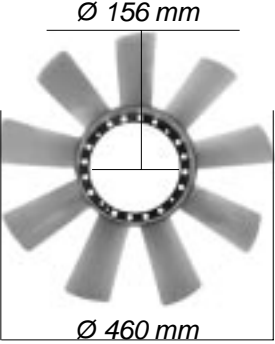
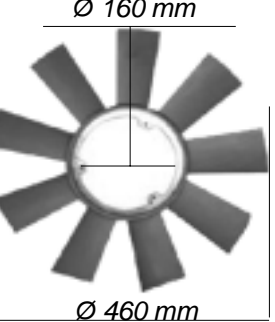
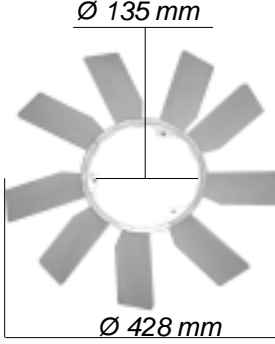
MERCEDES SPRINTER

Ruota singola

Single wheel

WOLKSVAGEN LT35 U.T

Ruota singola dal 1997

Single wheel dal 1997

Ns.Rif. <i>Ns.Ref.</i>	Rif. O.E. <i>O.E. Ref.</i>	Taratura <i>Calibration</i>
103403	-	2,5 Bar
103403.1	-	4 Bar

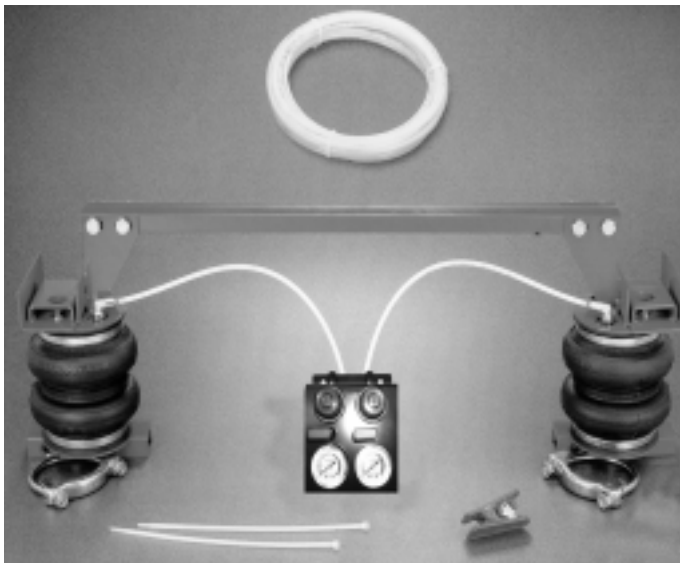

Applicazione tipo veicolo
Vehicle type

MERCEDES SPRINTER

Ruota gemellata

Coupled wheels

WOLKSVAGEN LT35/46

Ruota gemellata dal 1997

Coupled wheels to 1997

503440 MERCEDES Sprinter



TIPO DI VEICOLO / VEHICLE TYPE

NISSAN
TRADE - CABSTAR

ILLUSTRAZIONE / ILLUSTRATION

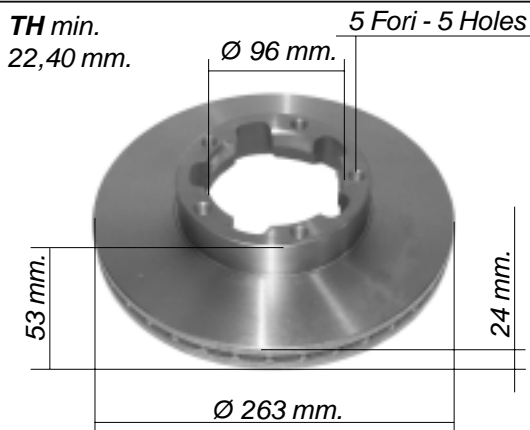
NOSTRO RIFERIMENTO
OUR REFERENCE

960055

RIFERIMENTO COSTRUTTORE
O.E. REFERENCE

40206F3902

DESCRIZIONE / DESCRIPTION

Disco freno assale anteriore
Brake disc front axleFascia AUTOVENTILANTE
SELF-VENTILATED Band

ILLUSTRAZIONE / ILLUSTRATION

NOSTRO RIFERIMENTO
OUR REFERENCE

960872

RIFERIMENTO COSTRUTTORE
O.E. REFERENCE

-06903100-0

DESCRIZIONE / DESCRIPTION

Serie pastiglie freno anteriore
Set of brake pads front

WVA	Larghezza Width - mm.	Altezza Height - mm.	Spessore Thickness - mm
29034	166	62	17
29035			
29706			



ILLUSTRAZIONE / ILLUSTRATION

NOSTRO RIFERIMENTO
OUR REFERENCERIFERIMENTO COSTRUTTORE
O.E. REFERENCE

DESCRIZIONE / DESCRIPTION

TIPO DI VEICOLO / VEHICLE TYPE

NISSAN
CABSTAR
ECO T100 - ATLEON 100-120

ILLUSTRAZIONE / ILLUSTRATION

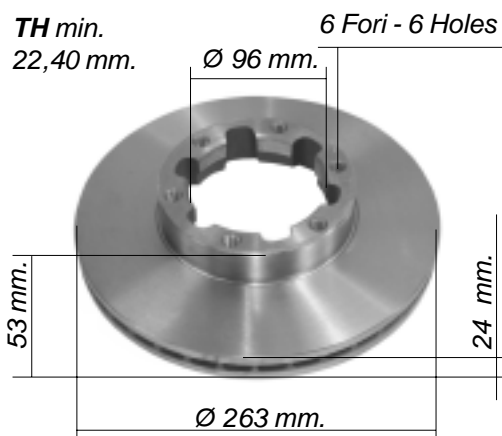

NOSTRO RIFERIMENTO
OUR REFERENCE

960056

RIFERIMENTO COSTRUTTORE
O.E. REFERENCE

40206F3901

DESCRIZIONE / DESCRIPTION

Disco freno assale anteriore
Brake disc front axle

Fascia AUTOVENTILANTE
SELF-VENTILATED Band



ILLUSTRAZIONE / ILLUSTRATION



NOSTRO RIFERIMENTO
OUR REFERENCE

960872

RIFERIMENTO COSTRUTTORE
O.E. REFERENCE

-06903100-0

DESCRIZIONE / DESCRIPTION

Serie pastiglie freno anteriore
Set of brake pads front

WVA	Larghezza Width - mm.	Altezza Height - mm.	Spessore Thickness - mm
29034	166	62	17
29035			
29706			



ILLUSTRAZIONE / ILLUSTRATION

NOSTRO RIFERIMENTO
OUR REFERENCE

RIFERIMENTO COSTRUTTORE
O.E. REFERENCE

DESCRIZIONE / DESCRIPTION

TIPO DI VEICOLO / VEHICLE TYPE

NISSAN
CABSTAR 120 U.T.

ILLUSTRAZIONE / ILLUSTRATION

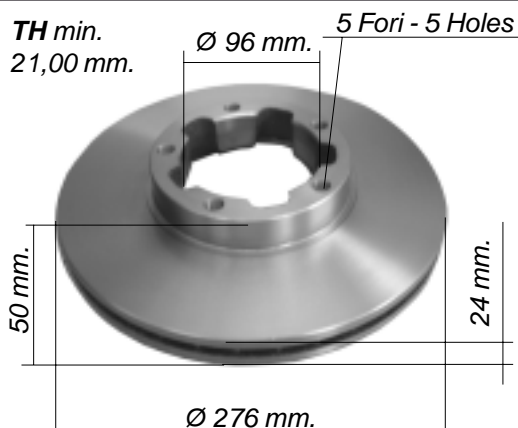
NOSTRO RIFERIMENTO
OUR REFERENCE

960059

RIFERIMENTO COSTRUTTORE
O.E. REFERENCE

402069X200

DESCRIZIONE / DESCRIPTION

Disco freno assale anteriore
Brake disc front axleFascia AUTOVENTILANTE
SELF-VENTILATED Band

ILLUSTRAZIONE / ILLUSTRATION

NOSTRO RIFERIMENTO
OUR REFERENCE

960874

RIFERIMENTO COSTRUTTORE
O.E. REFERENCE

410609X226

DESCRIZIONE / DESCRIPTION

Serie pastiglie freno anteriore e posteriore
Set of brake pads front and rear

WVA	Larghezza Width - mm.	Altezza Height - mm.	Spessore Thickness - mm
23435	169	65	18



ILLUSTRAZIONE / ILLUSTRATION

NOSTRO RIFERIMENTO
OUR REFERENCERIFERIMENTO COSTRUTTORE
O.E. REFERENCE

DESCRIZIONE / DESCRIPTION

TIPO DI VEICOLO / VEHICLE TYPE

NISSAN
ATLEON 120 (DAL / FROM 05-2003)

ILLUSTRAZIONE / ILLUSTRATION

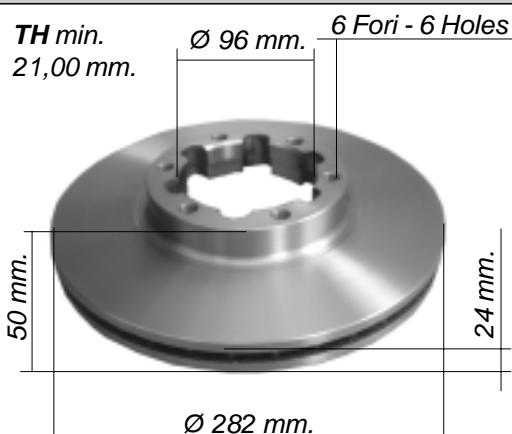

NOSTRO RIFERIMENTO OUR REFERENCE

960057

RIFERIMENTO COSTRUTTORE O.E. REFERENCE

432069X401

DESCRIZIONE / DESCRIPTION

Disco freno assale anteriore
Brake disc front axle

Fascia AUTOVENTILANTE
SELF-VENTILATED Band



ILLUSTRAZIONE / ILLUSTRATION



NOSTRO RIFERIMENTO OUR REFERENCE

960875

RIFERIMENTO COSTRUTTORE O.E. REFERENCE

410609X126

DESCRIZIONE / DESCRIPTION

Serie pastiglie freno anteriore e posteriore
Set of brake pads front and rear

WVA	Larghezza Width - mm.	Altezza Height - mm.	Spessore Thickness - mm
29121	164,8	66,5	20,3



ILLUSTRAZIONE / ILLUSTRATION





NOSTRO RIFERIMENTO OUR REFERENCE

RIFERIMENTO COSTRUTTORE O.E. REFERENCE

DESCRIZIONE / DESCRIPTION

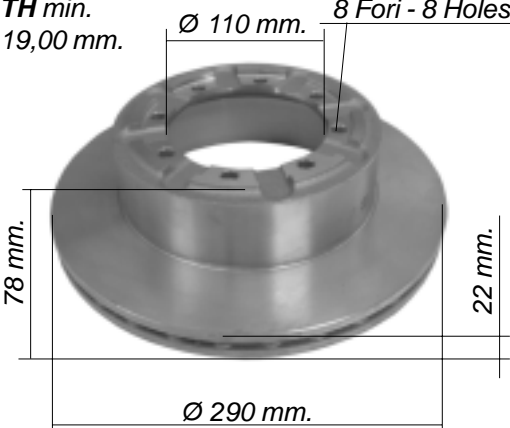
TIPO DI VEICOLO / VEHICLE TYPE

NISSAN
ATLEON 120 (DAL / FROM 05-2003)

ILLUSTRAZIONE / ILLUSTRATION	NOSTRO RIFERIMENTO OUR REFERENCE	RIFERIMENTO COSTRUTTORE O.E. REFERENCE								
 <p>TH min. 19,00 mm.</p> <p>Ø 110 mm.</p> <p>8 Fori - 8 Holes</p> <p>78 mm.</p> <p>22 mm.</p> <p>Ø 290 mm.</p>	960058	402079X100								
DESCRIZIONE / DESCRIPTION										
<p>Disco freno posteriore Brake disc rear</p> <p>Fascia AUTOVENTILANTE SELF-VENTILATED Band</p> 										
ILLUSTRAZIONE / ILLUSTRATION	NOSTRO RIFERIMENTO OUR REFERENCE	RIFERIMENTO COSTRUTTORE O.E. REFERENCE								
 <p>TECHNO BRAKE</p> <p>160909-04-1001-04-08</p> <p>E3 90R</p>	960875	410609X126								
DESCRIZIONE / DESCRIPTION										
<p>Serie pastiglie freno anteriore e posteriore Set of brake pads front and rear</p> <table border="1" data-bbox="644 1456 1232 1617"> <thead> <tr> <th>WVA</th> <th>Larghezza Width - mm.</th> <th>Altezza Height - mm.</th> <th>Spessore Thickness - mm</th> </tr> </thead> <tbody> <tr> <td>29121</td> <td>164,8</td> <td>66,5</td> <td>20,3</td> </tr> </tbody> </table> 			WVA	Larghezza Width - mm.	Altezza Height - mm.	Spessore Thickness - mm	29121	164,8	66,5	20,3
WVA	Larghezza Width - mm.	Altezza Height - mm.	Spessore Thickness - mm							
29121	164,8	66,5	20,3							
ILLUSTRAZIONE / ILLUSTRATION	NOSTRO RIFERIMENTO OUR REFERENCE	RIFERIMENTO COSTRUTTORE O.E. REFERENCE								
DESCRIZIONE / DESCRIPTION										

TIPO DI VEICOLO / VEHICLE TYPE

NISSAN
ATLEON 120 DAL / FROM 2004

ILLUSTRAZIONE / ILLUSTRATION

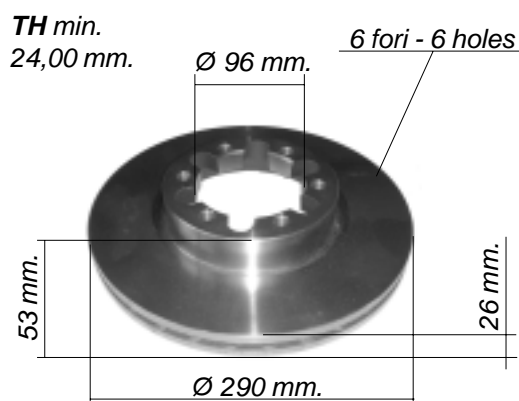

NOSTRO RIFERIMENTO OUR REFERENCE

960522

RIFERIMENTO COSTRUTTORE O.E. REFERENCE

402069X403

DESCRIZIONE / DESCRIPTION

Disco freno anteriore
Brake disc front

Fascia AUTOVENTILANTE
SELF-VENTILATED Band



ILLUSTRAZIONE / ILLUSTRATION



NOSTRO RIFERIMENTO OUR REFERENCE

960875

RIFERIMENTO COSTRUTTORE O.E. REFERENCE

410609X126

DESCRIZIONE / DESCRIPTION

Serie pastiglie freno anteriore e posteriore
Set of brake pads front and rear

WVA	Larghezza Width - mm.	Altezza Height - mm.	Spessore Thickness - mm
29121	164,8	66,5	20,3



ILLUSTRAZIONE / ILLUSTRATION

NOSTRO RIFERIMENTO OUR REFERENCE

RIFERIMENTO COSTRUTTORE O.E. REFERENCE

DESCRIZIONE / DESCRIPTION

TIPO DI VEICOLO / VEHICLE TYPE

NISSAN
ATLEON 140 U.T.

(CON ABS - WITH ABS)

ILLUSTRAZIONE / ILLUSTRATION

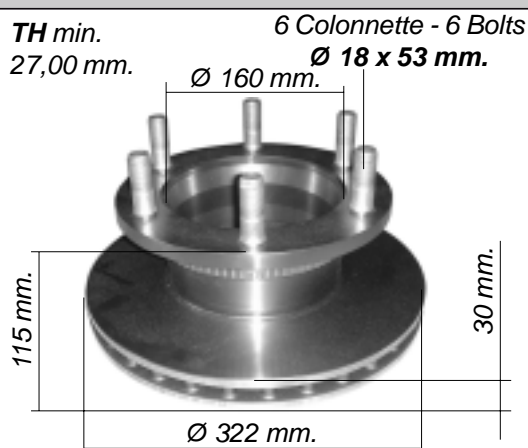
NOSTRO RIFERIMENTO
OUR REFERENCE

960526

RIFERIMENTO COSTRUTTORE
O.E. REFERENCE

402069X407

DESCRIZIONE / DESCRIPTION

Disco freno anteriore
Brake disc frontFascia AUTOVENTILANTE
SELF-VENTILATED Band

ILLUSTRAZIONE / ILLUSTRATION

NOSTRO RIFERIMENTO
OUR REFERENCE

960947

RIFERIMENTO COSTRUTTORE
O.E. REFERENCE

-06902964-0

DESCRIZIONE / DESCRIPTION

Serie pastiglie freno anteriore e posteriore
Set of brake pads front and rear

WVA	Larghezza Width - mm.	Altezza Height - mm.	Spessore Thickness - mm
29039	175	78	22
21302			
29302			



ILLUSTRAZIONE / ILLUSTRATION

NOSTRO RIFERIMENTO
OUR REFERENCERIFERIMENTO COSTRUTTORE
O.E. REFERENCE

DESCRIZIONE / DESCRIPTION

TIPO DI VEICOLO / VEHICLE TYPE

NISSAN

ATLEON 140 U.T. (POSTERIORE - REAR)

NISSAN ATLEON 160 - 165 - 210 (DAL 09/99 - FROM 09/99)

(CON ABS - WITH ABS)

ILLUSTRAZIONE / ILLUSTRATION

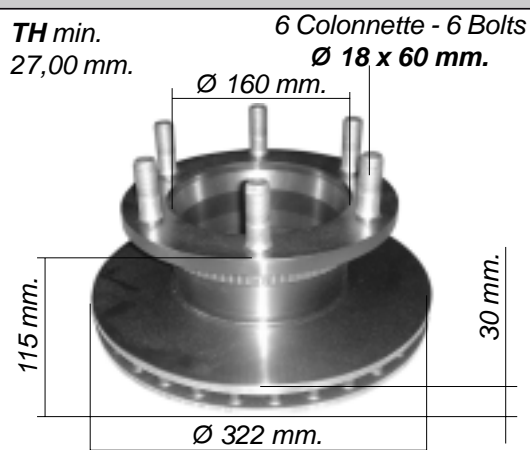

NOSTRO RIFERIMENTO
OUR REFERENCE

960527

RIFERIMENTO COSTRUTTORE
O.E. REFERENCE

402069X001

DESCRIZIONE / DESCRIPTION

Disco freno anteriore e posteriore
Brake disc front and rear axle

Fascia AUTOVENTILANTE
SELF-VENTILATED Band



ILLUSTRAZIONE / ILLUSTRATION



NOSTRO RIFERIMENTO
OUR REFERENCE

960947

RIFERIMENTO COSTRUTTORE
O.E. REFERENCE

-06902964-0

DESCRIZIONE / DESCRIPTION

Serie pastiglie freno anteriore e posteriore
Set of brake pads front and rear

WVA	Larghezza Width - mm.	Altezza Height - mm.	Spessore Thickness - mm
29039	175	78	22
21302			
29302			



ILLUSTRAZIONE / ILLUSTRATION

NOSTRO RIFERIMENTO
OUR REFERENCE

RIFERIMENTO COSTRUTTORE
O.E. REFERENCE

DESCRIZIONE / DESCRIPTION

TIPO DI VEICOLO / VEHICLE TYPE

NISSAN
ECO T135 - ATLEON 140 - ECO L60 - ECO L70

(SENZA ABS - WITHOUT ABS)

ILLUSTRAZIONE / ILLUSTRATION

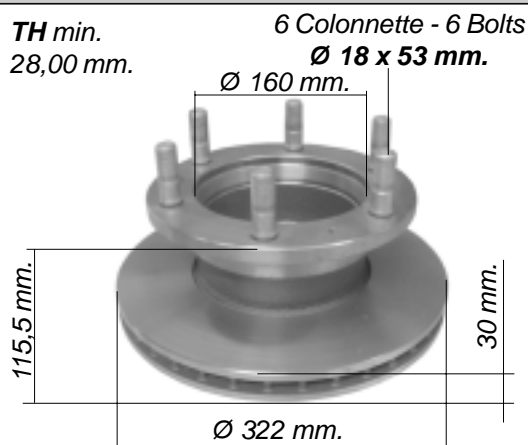
NOSTRO RIFERIMENTO
OUR REFERENCE

960235

RIFERIMENTO COSTRUTTORE
O.E. REFERENCE

-06100420-0

DESCRIZIONE / DESCRIPTION

Disco freno anteriore
Brake disc front

Fascia AUTOVENTILANTE
SELF-VENTILATED Band



ILLUSTRAZIONE / ILLUSTRATION

NOSTRO RIFERIMENTO
OUR REFERENCE

960947

RIFERIMENTO COSTRUTTORE
O.E. REFERENCE

-06902964-0

DESCRIZIONE / DESCRIPTION

Serie pastiglie freno anteriore e posteriore
Set of brake pads front and rear

WVA	Larghezza Width - mm.	Altezza Height - mm.	Spessore Thickness - mm
29039	175	78	22
21302			
29302			



ILLUSTRAZIONE / ILLUSTRATION

NOSTRO RIFERIMENTO
OUR REFERENCERIFERIMENTO COSTRUTTORE
O.E. REFERENCE

DESCRIZIONE / DESCRIPTION

TIPO DI VEICOLO / VEHICLE TYPE

NISSAN

ECO T135 - ATLEON 140 - ECO L60 - ECO L70

(SENZA ABS - WITHOUT ABS)

ILLUSTRAZIONE / ILLUSTRATION

NOSTRO RIFERIMENTO OUR REFERENCE

RIFERIMENTO COSTRUTTORE O.E. REFERENCE

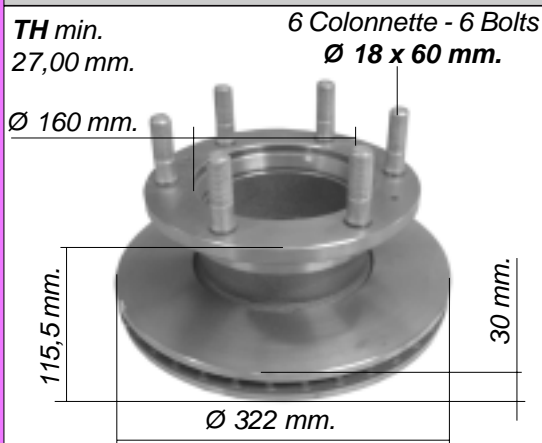

960236

-06200438-0

DESCRIZIONE / DESCRIPTION

Disco freno posteriore
Brake disc rear

Fascia AUTOVENTILANTE
SELF-VENTILATED Band



ILLUSTRAZIONE / ILLUSTRATION

NOSTRO RIFERIMENTO OUR REFERENCE

RIFERIMENTO COSTRUTTORE O.E. REFERENCE



960947

-06902964-0

DESCRIZIONE / DESCRIPTION

Serie pastiglie freno anteriore e posteriore
Set of brake pads front and rear

WVA	Larghezza Width - mm.	Altezza Height - mm.	Spessore Thickness - mm
29039	175	78	22
21302			
29302			



ILLUSTRAZIONE / ILLUSTRATION

NOSTRO RIFERIMENTO OUR REFERENCE

RIFERIMENTO COSTRUTTORE O.E. REFERENCE

DESCRIZIONE / DESCRIPTION

TIPO DI VEICOLO / VEHICLE TYPE

NISSAN
ECO T 160

ILLUSTRAZIONE / ILLUSTRATION

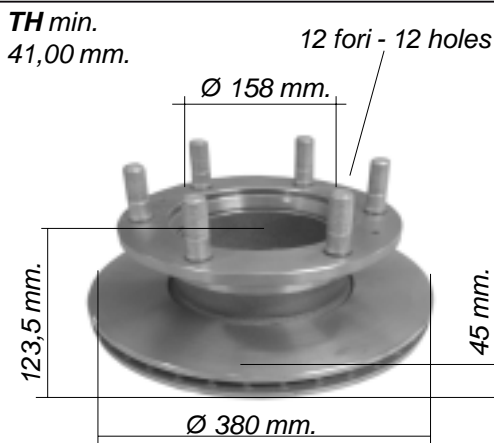
NOSTRO RIFERIMENTO
OUR REFERENCE**960054**RIFERIMENTO COSTRUTTORE
O.E. REFERENCE

40206D9200

DESCRIZIONE / DESCRIPTION

Disco freno anteriore
Brake disc frontFascia AUTOVENTILANTE
SELF-VENTILATED Band

ILLUSTRAZIONE / ILLUSTRATION

NOSTRO RIFERIMENTO
OUR REFERENCE**960947**RIFERIMENTO COSTRUTTORE
O.E. REFERENCE

-06902964-0

DESCRIZIONE / DESCRIPTION

Serie pastiglie freno anteriore e posteriore
Set of brake pads front and rear

WVA	Larghezza Width - mm.	Altezza Height - mm.	Spessore Thickness - mm
29039	175	78	22
21302			
29302			



ILLUSTRAZIONE / ILLUSTRATION



NOSTRO RIFERIMENTO
OUR REFERENCERIFERIMENTO COSTRUTTORE
O.E. REFERENCE

DESCRIZIONE / DESCRIPTION

NISSAN

MOZZI RUOTA WHEEL HUBS

EMMERRE

	Ns Riferim. Our Ref.	Rif. Costr. O.E. Ref.	Descrizione/Tipo di veicolo Description/Vehicle Type
	931700	402029x100	<i>Mozzo ruota anteriore</i> Completo di cuscinetti <i>Front wheel hub with bearings</i>
	931701	43202F3903	<i>Mozzo ruota posteriore</i> Completo di cuscinetti <i>Rear wheel hub with bearings</i>



NISSAN

SERIE GANASCE BRAKE SHOES SET

EMMERRE

	Ns Riferim. Our Ref.	Rif. Costr. O.E. Ref.	Descrizione/Tipo di veicolo Description/Vehicle Type
	960873	-06905320-0	<i>Serie ganasce freno posteriori</i> <i>Rear brake shoe set</i>

	Ns Riferim. Our Ref.	Rif. Costr. O.E. Ref.	Descrizione/Tipo di veicolo Description/Vehicle Type
	960203	43206F3600	Tamburo freno posteriore Rear brake drum Trade - Cabstar 
	960220	432069x201	Tamburo freno posteriore Rear brake drum Cabstar 120 
	960204	-06200387-0	Tamburo freno posteriore Rear brake drum Eco T100 - Atleon 100-120 

	Ns Riferim. Our Ref.	Rif. Costr. O.E. Ref.	Descrizione/Tipo di veicolo Description/Vehicle Type
	964222	-06902174-0	<p><i>Cilindretto freno posteriore Ø 25,40 mm. Rear brake cylinder</i></p> <p>Trade 2.0 D (dal 1991 from 1991)</p>
	964223	-06902317-0	<p><i>Cilindretto freno posteriore Ø 25,40 mm. Rear brake cylinder</i></p> <p>Atleon ECO T</p>

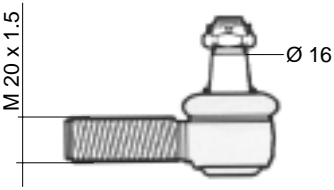
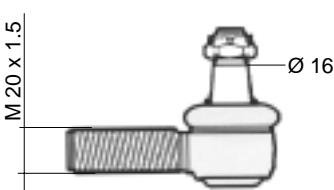
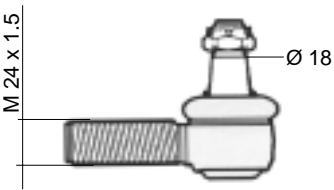
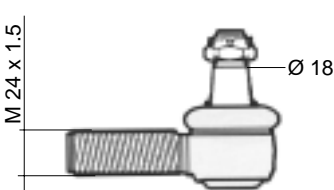
 <p>Dx-Right</p>	Ns.Rif. Our Ref. 954037	Rif.Costr. O.E. Ref. -48647-9X62A 11200361-0	Tipo di veicolo Vehicle Type Testa sterzo Dx Ball joint Right TRADE L35 ECO T 100 CABSTAR ATLEON
 <p>Sx-Left</p>	Ns.Rif. Our Ref. 954036	Rif.Costr. O.E. Ref. -48527-9X62A 11200360-0	Tipo di veicolo Vehicle Type Testa sterzo Sx Ball joint Left TRADE L35 ECO T 100 CABSTAR ATLEON
 <p>Dx-Right</p>	Ns.Rif. Our Ref. 954045	Rif.Costr. O.E. Ref. -11500307-0	Tipo di veicolo Vehicle Type Testa sterzo Dx Ball joint Right NISSAN ECOT 135 - L701 - L80
 <p>Sx-Left</p>	Ns.Rif. Our Ref. 954044	Rif.Costr. O.E. Ref. -11500373-0	Tipo di veicolo Vehicle Type Testa sterzo Sx Ball joint Left NISSAN ECOT 135 - L701 - L80
	Ns.Rif. Our Ref.	Rif.Costr. O.E. Ref.	Tipo di veicolo Vehicle Type

L1 810 mm.		
L2 780 mm.		
Ns Riferim. Our Ref.	Rif. Costr. O.E. Ref.	Tipo di veicolo - Vehicle Type
954400	485109x101 11200454-0	ATLEON

L1 787 mm.		
L2 755 mm.		
Ns Riferim. Our Ref.	Rif. Costr. O.E. Ref.	Tipo di veicolo - Vehicle Type
954401	485109x102	ECO L60/70 - 0.95 ECO

L1 667 mm.		
L2 635 mm.		
Ns Riferim. Our Ref.	Rif. Costr. O.E. Ref.	Tipo di veicolo - Vehicle Type
954402	48510F3900	CABSTAR 110-120

Ns Riferim. Our Ref.	Rif. Costr. O.E. Ref.	Tipo di veicolo - Vehicle Type

Ns. Riferimento Ns. Ref.	Tipo applicazione Application type	<p>Pompa acqua Water pump</p> 
907145	ECO L35.085 ECO T100 ATLEON 110/120 TRADE 30/100	
Rif. Costruttore OE. Ref.		
2101069T02		
Tipo motore Engine type		
BD 30		

Ns. Riferimento Ns. Ref.	Tipo applicazione Application type	
Rif. Costruttore OE. Ref.		
Tipo motore Engine type		

Ns. Riferimento Ns. Ref.	Tipo applicazione Application type	
Rif. Costruttore OE. Ref.		
Tipo motore Engine type		

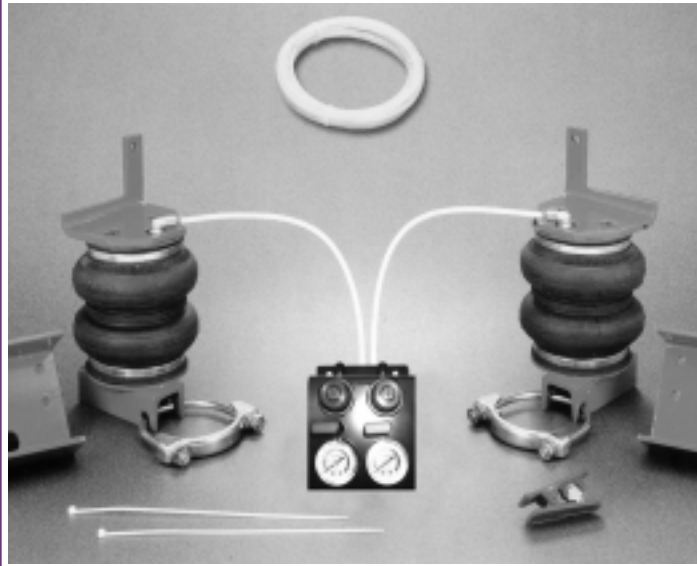

Ns.Rif. <i>Ns.Ref.</i>	Rif. O.E. <i>O.E. Ref.</i>	Taratura <i>Calibration</i>
103416	-	2,5 Bar
103416.1	-	4 Bar

Applicazione tipo veicolo
Vehicle type

NISSAN ATLEON
110HD

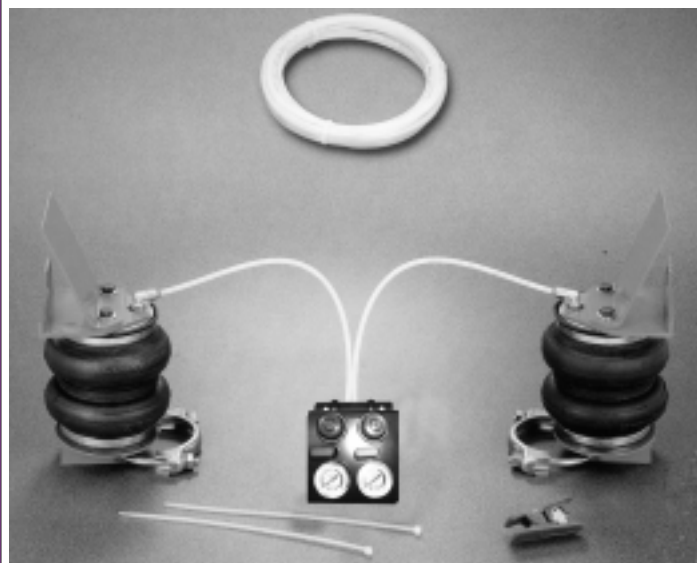

Ns.Rif. <i>Ns.Ref.</i>	Rif. O.E. <i>O.E. Ref.</i>	Taratura <i>Calibration</i>
103415	-	2,5 Bar
103415.1	-	4 Bar

Applicazione tipo veicolo
Vehicle type

NISSAN CABSTAR
E110

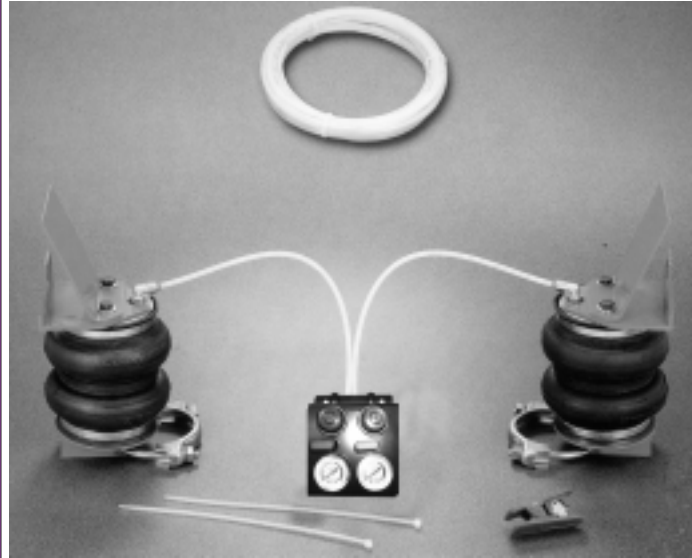
Ns.Rif.
Ns.Ref.Rif. O.E.
O.E. Ref.Taratura
Calibration

103412

-

2,5 Bar

103412.1

-

4 Bar

Applicazione tipo veicolo
Vehicle type

NISSAN TRADE 100

Ns.Rif.
Ns.Ref.Rif. O.E.
O.E. Ref.Taratura
Calibration

103413

-

2,5 Bar

103413.1

-

4 Bar

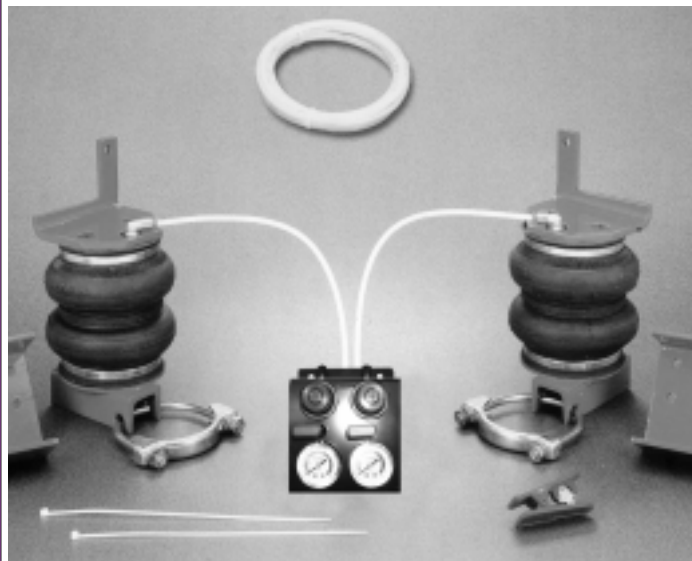
Applicazione tipo veicolo
Vehicle typeNISSAN ECO T100
ATLEON 110

TIPO DI VEICOLO / VEHICLE TYPE

MOVANO (Ruota da 16")**COMBI** 1.9DTI - 2.2DTI - 2.5DTI - 2.5D**FURGONATO** 1.9DTI - 2.2DTI - 2.5DTI - 2.8DTI - 2.5D**PIANALE PIATTO** 2.2DTI - 2.5DTI - 2.8DTI

ILLUSTRAZIONE / ILLUSTRATION

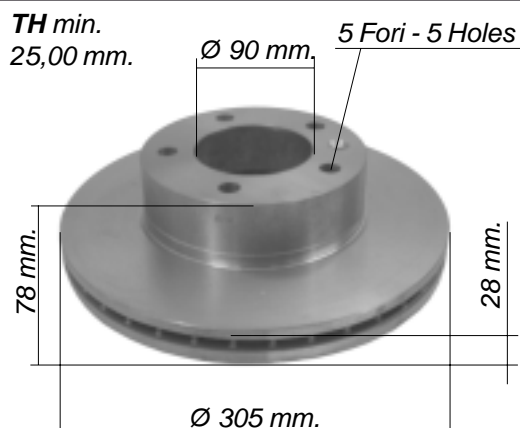
NOSTRO RIFERIMENTO
OUR REFERENCE**960233**RIFERIMENTO COSTRUTTORE
O.E. REFERENCE

4403038

DESCRIZIONE / DESCRIPTION

Disco freno assale anteriore
Brake disc front axleFascia AUTOVENTILANTE
SELF-VENTILATED Band

ILLUSTRAZIONE / ILLUSTRATION

NOSTRO RIFERIMENTO
OUR REFERENCE**960986**RIFERIMENTO COSTRUTTORE
O.E. REFERENCE4502797
4501150

DESCRIZIONE / DESCRIPTION

Serie pastiglie freno anteriore
Set of brake pads front

WVA	Larghezza Width - mm.	Altezza Height - mm.	Spessore Thickness - mm
23302	139	68	18



ILLUSTRAZIONE / ILLUSTRATION

NOSTRO RIFERIMENTO
OUR REFERENCERIFERIMENTO COSTRUTTORE
O.E. REFERENCE

DESCRIZIONE / DESCRIPTION

TIPO DI VEICOLO / VEHICLE TYPE

MOVANO

COMBI	1.9DTI - 2.2DTI - 2.5DTI - 2.5D
FURGONATO	1.9DTI - 2.2DTI - 2.5DTI - 2.8DTI - 2.5D
PIANALE PIATTO	2.2DTI - 2.5DTI - 2.8DTI

ILLUSTRAZIONE / ILLUSTRATION

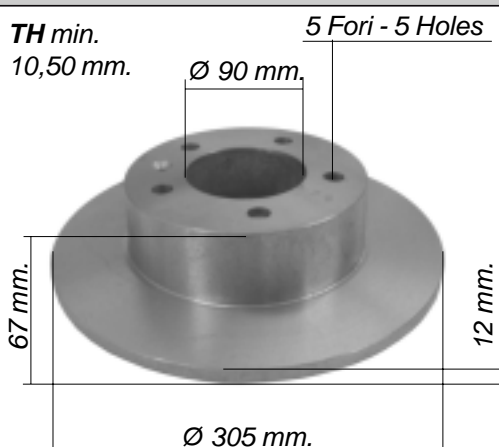

NOSTRO RIFERIMENTO OUR REFERENCE

960231

RIFERIMENTO COSTRUTTORE O.E. REFERENCE

4403045

DESCRIZIONE / DESCRIPTION

Disco freno assale posteriore
Brake disc rear axle



ILLUSTRAZIONE / ILLUSTRATION



NOSTRO RIFERIMENTO OUR REFERENCE

960985

RIFERIMENTO COSTRUTTORE O.E. REFERENCE

4403467

DESCRIZIONE / DESCRIPTION

Serie pastiglie freno posteriore
Set of brake pads rear

WVA	Larghezza Width - mm.	Altezza Height - mm.	Spessore Thickness - mm
23669	115.8	51.3	16.8



ILLUSTRAZIONE / ILLUSTRATION

NOSTRO RIFERIMENTO OUR REFERENCE

RIFERIMENTO COSTRUTTORE O.E. REFERENCE

DESCRIZIONE / DESCRIPTION

TIPO DI VEICOLO / VEHICLE TYPE

MASTER
DAL / FROM 11-1997

ILLUSTRAZIONE / ILLUSTRATION	NOSTRO RIFERIMENTO OUR REFERENCE	RIFERIMENTO COSTRUTTORE O.E. REFERENCE								
<p>TH min. 21,00 mm.</p> <p>6 Fori - 6 Holes Ø 79,50 mm.</p>  <p>Ø 280 mm.</p>	960234	7700302128								
DESCRIZIONE / DESCRIPTION										
<p>Disco freno assale anteriore Brake disc front axle</p> <p>Fascia AUTOVENTILANTE SELF-VENTILATED Band</p> 										
ILLUSTRAZIONE / ILLUSTRATION	NOSTRO RIFERIMENTO OUR REFERENCE	RIFERIMENTO COSTRUTTORE O.E. REFERENCE								
 <p>E3 90R</p>	960986	7701207166								
DESCRIZIONE / DESCRIPTION										
<p>Serie pastiglie freno anteriore Set of brake pads front</p> <table border="1"> <thead> <tr> <th>WVA</th> <th>Larghezza Width - mm.</th> <th>Altezza Height - mm.</th> <th>Spessore Thickness - mm.</th> </tr> </thead> <tbody> <tr> <td>23302</td> <td>139</td> <td>68</td> <td>18</td> </tr> </tbody> </table> 			WVA	Larghezza Width - mm.	Altezza Height - mm.	Spessore Thickness - mm.	23302	139	68	18
WVA	Larghezza Width - mm.	Altezza Height - mm.	Spessore Thickness - mm.							
23302	139	68	18							
ILLUSTRAZIONE / ILLUSTRATION	NOSTRO RIFERIMENTO OUR REFERENCE	RIFERIMENTO COSTRUTTORE O.E. REFERENCE								
DESCRIZIONE / DESCRIPTION										

TIPO DI VEICOLO / VEHICLE TYPE

MASTER DAL / FROM 11-1997
MASTER II DAL / FROM 10-2003

ILLUSTRAZIONE / ILLUSTRATION

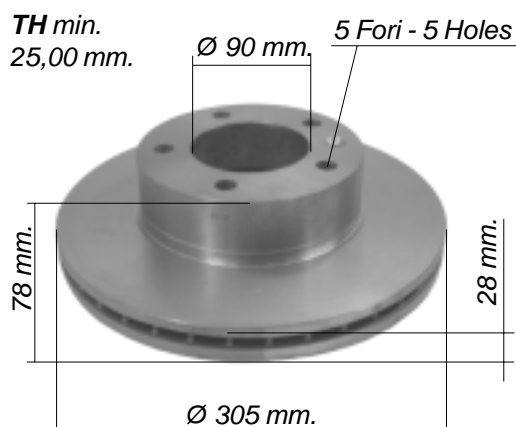

NOSTRO RIFERIMENTO
OUR REFERENCE

960233

RIFERIMENTO COSTRUTTORE
O.E. REFERENCE

7700314064

DESCRIZIONE / DESCRIPTION

Disco freno assale anteriore
Brake disc front axle

Fascia AUTOVENTILANTE
SELF-VENTILATED Band



ILLUSTRAZIONE / ILLUSTRATION



NOSTRO RIFERIMENTO
OUR REFERENCE

960988

RIFERIMENTO COSTRUTTORE
O.E. REFERENCE

7701207339

DESCRIZIONE / DESCRIPTION

Serie pastiglie freno anteriore
Set of brake pads front

WVA	Larghezza Width - mm.	Altezza Height - mm.	Spessore Thickness - mm.
23613	138,8	79,7	17,6



ILLUSTRAZIONE / ILLUSTRATION

NOSTRO RIFERIMENTO
OUR REFERENCE

RIFERIMENTO COSTRUTTORE
O.E. REFERENCE

DESCRIZIONE / DESCRIPTION

TIPO DI VEICOLO / VEHICLE TYPE

MASTER DAL / FROM 11-1997
MASTER II DAL / FROM 10-2003

ILLUSTRAZIONE / ILLUSTRATION

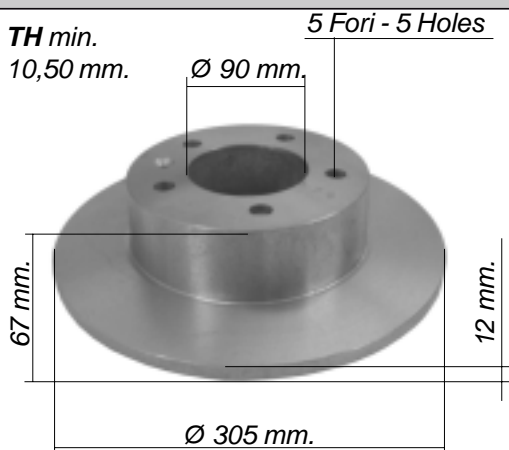
NOSTRO RIFERIMENTO
OUR REFERENCE**960231**RIFERIMENTO COSTRUTTORE
O.E. REFERENCE

7700314107

DESCRIZIONE / DESCRIPTION

Disco freno assale posteriore
 Brake disc rear axle



ILLUSTRAZIONE / ILLUSTRATION

NOSTRO RIFERIMENTO
OUR REFERENCE**960985**RIFERIMENTO COSTRUTTORE
O.E. REFERENCE

7701206763

DESCRIZIONE / DESCRIPTION

Serie pastiglie freno posteriore
 Set of brake pads rear

WVA	Larghezza Width - mm.	Altezza Height - mm.	Spessore Thickness - mm.
23669	115,8	51,3	16,8



ILLUSTRAZIONE / ILLUSTRATION

NOSTRO RIFERIMENTO
OUR REFERENCERIFERIMENTO COSTRUTTORE
O.E. REFERENCE

DESCRIZIONE / DESCRIPTION

TIPO DI VEICOLO / VEHICLE TYPE

MASCOTT

90.35 - 110.35 - 110.50 - 130.35 - 150.35 (01/99)

ILLUSTRAZIONE / ILLUSTRATION	NOSTRO RIFERIMENTO OUR REFERENCE	RIFERIMENTO COSTRUTTORE O.E. REFERENCE								
	960230	5010260604								
DESCRIZIONE / DESCRIPTION										
<p>Disco freno assale anteriore Brake disc front axle</p> <p>Fascia AUTOVENTILANTE SELF-VENTILATED Band</p>										
ILLUSTRAZIONE / ILLUSTRATION	NOSTRO RIFERIMENTO OUR REFERENCE	RIFERIMENTO COSTRUTTORE O.E. REFERENCE								
	960987	5001850859 5001844747								
DESCRIZIONE / DESCRIPTION										
<p>Serie pastiglie freno anteriore e posteriore Set of brake pads front and rear</p> <table border="1"> <thead> <tr> <th>WVA</th> <th>Larghezza Width - mm.</th> <th>Altezza Height - mm.</th> <th>Spessore Thickness - mm.</th> </tr> </thead> <tbody> <tr> <td>29121</td> <td>164,80</td> <td>66,50</td> <td>20</td> </tr> </tbody> </table>			WVA	Larghezza Width - mm.	Altezza Height - mm.	Spessore Thickness - mm.	29121	164,80	66,50	20
WVA	Larghezza Width - mm.	Altezza Height - mm.	Spessore Thickness - mm.							
29121	164,80	66,50	20							
ILLUSTRAZIONE / ILLUSTRATION	NOSTRO RIFERIMENTO OUR REFERENCE	RIFERIMENTO COSTRUTTORE O.E. REFERENCE								
	960972	5001844748								
DESCRIZIONE / DESCRIPTION										
<p>Serie pastiglie freno anteriore e posteriore Set of brake pads front and rear</p> <table border="1"> <thead> <tr> <th>WVA</th> <th>Larghezza Width - mm.</th> <th>Altezza Height - mm.</th> <th>Spessore Thickness - mm.</th> </tr> </thead> <tbody> <tr> <td>29160</td> <td>164,5</td> <td>67,80</td> <td>20</td> </tr> </tbody> </table>			WVA	Larghezza Width - mm.	Altezza Height - mm.	Spessore Thickness - mm.	29160	164,5	67,80	20
WVA	Larghezza Width - mm.	Altezza Height - mm.	Spessore Thickness - mm.							
29160	164,5	67,80	20							
ILLUSTRAZIONE / ILLUSTRATION	NOSTRO RIFERIMENTO OUR REFERENCE	RIFERIMENTO COSTRUTTORE O.E. REFERENCE								
<p>Puntale - Tag</p> <p>L = 260 mm.</p>	960819	5001850859/A 5001844747/A								
DESCRIZIONE / DESCRIPTION										
<p>Kit segnalatori usura freno anteriore e posteriore (2 pz.) Set of brake wear indicators front and rear (2 pcs)</p>										

TIPO DI VEICOLO / VEHICLE TYPE

MASCOTT

90.35 - 110.35 - 110.50 - 130.35 - 150.35 (01/99)



ILLUSTRAZIONE / ILLUSTRATION	NOSTRO RIFERIMENTO OUR REFERENCE	RIFERIMENTO COSTRUTTORE O.E. REFERENCE								
<p>TH min. 19,00 mm.</p> <p>8 Fori - 8 Holes</p> <p>Ø 150 mm.</p> <p>78 mm.</p> <p>22 mm.</p> <p>Ø 290 mm.</p> 	960229	5010260609								
DESCRIZIONE / DESCRIPTION										
<p>Disco freno assale posteriore Brake disc rear axle</p> <p>Fascia AUTOVENTILANTE SELF-VENTILATED Band</p> 										
ILLUSTRAZIONE / ILLUSTRATION	NOSTRO RIFERIMENTO OUR REFERENCE	RIFERIMENTO COSTRUTTORE O.E. REFERENCE								
 <p>E3 90R</p>	960987	5001850859 5001844747								
DESCRIZIONE / DESCRIPTION										
<p>Serie pastiglie freno anteriore e posteriore Set of brake pads front and rear</p> <table border="1"> <thead> <tr> <th>WVA</th> <th>Larghezza Width - mm.</th> <th>Altezza Height - mm.</th> <th>Spessore Thickness - mm.</th> </tr> </thead> <tbody> <tr> <td>29121</td> <td>164,80</td> <td>66,50</td> <td>20</td> </tr> </tbody> </table> 			WVA	Larghezza Width - mm.	Altezza Height - mm.	Spessore Thickness - mm.	29121	164,80	66,50	20
WVA	Larghezza Width - mm.	Altezza Height - mm.	Spessore Thickness - mm.							
29121	164,80	66,50	20							
ILLUSTRAZIONE / ILLUSTRATION	NOSTRO RIFERIMENTO OUR REFERENCE	RIFERIMENTO COSTRUTTORE O.E. REFERENCE								
 <p>E3 90R</p>	960972	5001844748								
DESCRIZIONE / DESCRIPTION										
<p>Serie pastiglie freno anteriore e posteriore Set of brake pads front and rear</p> <table border="1"> <thead> <tr> <th>WVA</th> <th>Larghezza Width - mm.</th> <th>Altezza Height - mm.</th> <th>Spessore Thickness - mm.</th> </tr> </thead> <tbody> <tr> <td>29160</td> <td>164,5</td> <td>67,80</td> <td>20</td> </tr> </tbody> </table> 			WVA	Larghezza Width - mm.	Altezza Height - mm.	Spessore Thickness - mm.	29160	164,5	67,80	20
WVA	Larghezza Width - mm.	Altezza Height - mm.	Spessore Thickness - mm.							
29160	164,5	67,80	20							
ILLUSTRAZIONE / ILLUSTRATION	NOSTRO RIFERIMENTO OUR REFERENCE	RIFERIMENTO COSTRUTTORE O.E. REFERENCE								
<p>Puntale - Tag</p>  <p>L = 260 mm.</p>	960819	5001850859/A 5001844747/A								
DESCRIZIONE / DESCRIPTION										
<p>Kit segnalatori usura freno anteriore e posteriore (2 pz.) Set of brake wear indicators front and rear (2 pcs)</p>										

TIPO DI VEICOLO / VEHICLE TYPE

MASCOTT



110.55 - 110.60 - 130.55 - 130.65 - 140.55 - 140.65 (01/99)

ILLUSTRAZIONE / ILLUSTRATION	NOSTRO RIFERIMENTO OUR REFERENCE	RIFERIMENTO COSTRUTTORE O.E. REFERENCE								
	960392	5010260603								
DESCRIZIONE / DESCRIPTION										
<p>Disco freno assale anteriore Brake disc front axle</p> <p>Fascia AUTOVENTILANTE SELF-VENTILATED Band</p>										
ILLUSTRAZIONE / ILLUSTRATION	NOSTRO RIFERIMENTO OUR REFERENCE	RIFERIMENTO COSTRUTTORE O.E. REFERENCE								
	960987	5001850859 5001844747								
DESCRIZIONE / DESCRIPTION										
<p>Serie pastiglie freno anteriore e posteriore Set of brake pads front and rear</p> <table border="1"> <thead> <tr> <th>WVA</th> <th>Larghezza Width - mm.</th> <th>Altezza Height - mm.</th> <th>Spessore Thickness - mm.</th> </tr> </thead> <tbody> <tr> <td>29121</td> <td>164,80</td> <td>66,50</td> <td>20</td> </tr> </tbody> </table>			WVA	Larghezza Width - mm.	Altezza Height - mm.	Spessore Thickness - mm.	29121	164,80	66,50	20
WVA	Larghezza Width - mm.	Altezza Height - mm.	Spessore Thickness - mm.							
29121	164,80	66,50	20							
ILLUSTRAZIONE / ILLUSTRATION	NOSTRO RIFERIMENTO OUR REFERENCE	RIFERIMENTO COSTRUTTORE O.E. REFERENCE								
	960972	5001844748								
DESCRIZIONE / DESCRIPTION										
<p>Serie pastiglie freno anteriore e posteriore Set of brake pads front and rear</p> <table border="1"> <thead> <tr> <th>WVA</th> <th>Larghezza Width - mm.</th> <th>Altezza Height - mm.</th> <th>Spessore Thickness - mm.</th> </tr> </thead> <tbody> <tr> <td>29160</td> <td>164,5</td> <td>67,80</td> <td>20</td> </tr> </tbody> </table>			WVA	Larghezza Width - mm.	Altezza Height - mm.	Spessore Thickness - mm.	29160	164,5	67,80	20
WVA	Larghezza Width - mm.	Altezza Height - mm.	Spessore Thickness - mm.							
29160	164,5	67,80	20							
ILLUSTRAZIONE / ILLUSTRATION	NOSTRO RIFERIMENTO OUR REFERENCE	RIFERIMENTO COSTRUTTORE O.E. REFERENCE								
<p>Puntale - Tag</p> <p>L = 260 mm.</p>	960819	5001850859/A 5001844747/A								
DESCRIZIONE / DESCRIPTION										
<p>Kit segnalatori usura freno anteriore e posteriore (2 pz.) Set of brake wear indicators front and rear (2 pcs)</p>										

	Ns Riferim. Our Ref.	Rif. Costr. O.E. Ref.	Descrizione/Tipo di veicolo Description/Vehicle Type
	963090	5010145932	<i>Massa frenante completa DX</i> <i>Complete wheel brake RH</i> <i>(Adattabile / Adaptable</i> <i>BOSCH 204111052)</i> RENAULT FN80
	963091	5010145933	<i>Massa frenante completa SX</i> <i>Complete wheel brake LH</i> <i>(Adattabile / Adaptable</i> <i>BOSCH 204111051)</i> RENAULT FN80
	963093	5010145931	<i>Massa frenante completa DX</i> <i>Complete wheel brake RH</i> <i>(Adattabile / Adaptable</i> <i>BOSCH 204111092)</i> RENAULT FN60
	963092	5010145930	<i>Massa frenante completa SX</i> <i>Complete wheel brake LH</i> <i>(Adattabile / Adaptable</i> <i>BOSCH 204111091)</i> RENAULT FN60
DISPONIBILE A MAGAZZINO AVAILABLE ON STOCK	963096	5001829350	<i>Serie ganasce freno DX/SX</i> <i>Brake shoes set RH/LH</i>

	Ns Riferim. Our Ref.	Rif. Costr. O.E. Ref.	Descrizione/Tipo di veicolo Description/Vehicle Type
	<p>970100</p>	<p>5001860144</p>	<p>Serie ganasce freno a mano posteriori Rear brake shoes set for hand brake</p> <p>Mascott 1999</p>

Copyright della EMMERRE S.r.l. - Settimo Torinese - Tutti i diritti sono riservati e depositati a norma di legge ed a norma delle convenzioni internazionali. - E' vietata la duplicazione o la riproduzione anche parziale senza la previa autorizzazione della EMMERRE S.r.l.

	Ns Riferim. Our Ref.	Rif. Costr. O.E. Ref.	Descrizione/Tipo di veicolo Description/Vehicle Type
 <p>AD ESAURIMENTO UNTILL OUT OF STOCK</p>	964232	77.01.034.172	<p><i>Cilindretto freno posteriore Ø 25,40 mm. Rear brake cylinder</i></p> <p>Trafic 2.1D - T900D - T1100D</p>
 <p>AD ESAURIMENTO UNTILL OUT OF STOCK</p>	964233	77.01.030.155	<p><i>Cilindretto freno posteriore Ø 25,40 mm. Rear brake cylinder</i></p> <p>Trafic 2.1D - P1400 2.2 I - T900 - T1100 - T1400 V1100 - 2.4D T1000 - T1400D - V1100D Bus</p>

Ns. Riferimento
Ns. Ref.

907365

Rif. Costruttore
OE. Ref.

7701468342
5001001274
7701462808

Tipo motore
Engine type

Tipo applicazione
Application type

TRAFIC
2.5 D 4X4 - 2.5 D
MASTER

Pompa acqua completa
Complete water pump



Ns. Riferimento
Ns. Ref.

Rif. Costruttore
OE. Ref.

Tipo motore
Engine type

Tipo applicazione
Application type

Ns. Riferimento
Ns. Ref.

Rif. Costruttore
OE. Ref.

Tipo motore
Engine type

Tipo applicazione
Application type

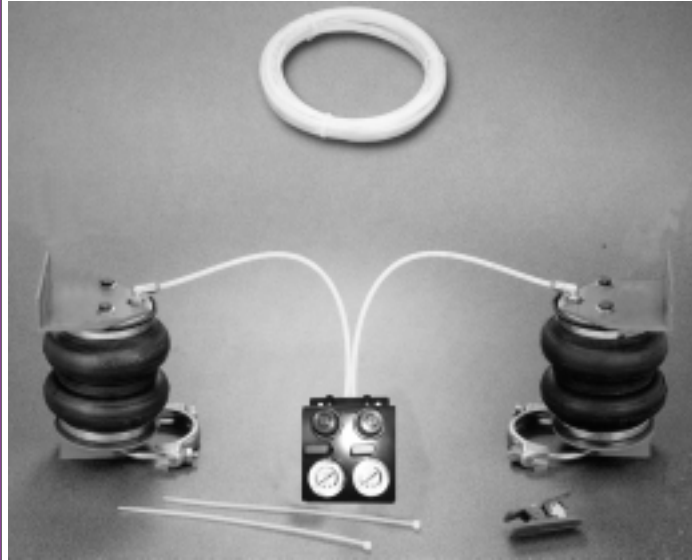
Ns.Rif.
Ns.Ref.Rif. O.E.
O.E. Ref.Taratura
Calibration

103419

-

2,5 Bar

103419.1

-

4 Bar

Applicazione tipo veicolo
Vehicle type

RENAULT MASCOTT

Ns.Rif.
Ns.Ref.Rif. O.E.
O.E. Ref.Taratura
Calibration

103417

-

2,5 Bar

103417.1

-

4 Bar

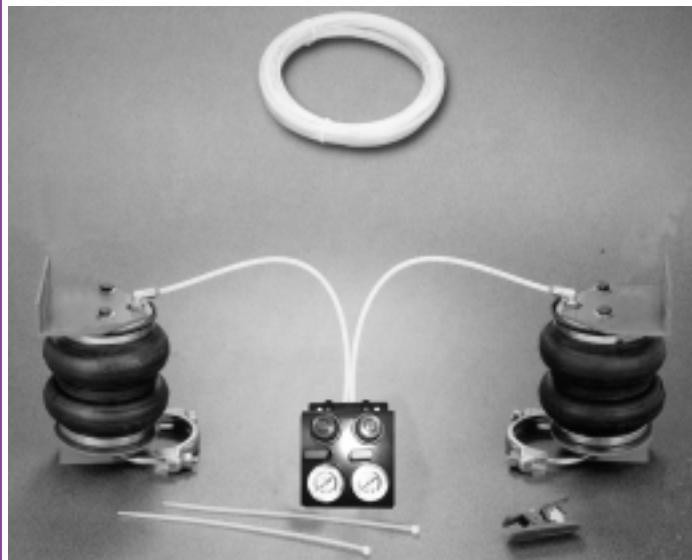
Applicazione tipo veicolo
Vehicle typeRENAULT MASCOTT U.T.
160 (DAL 2005 - FROM 2005)

Ns.Rif. <i>Ns.Ref.</i>	Rif. O.E. <i>O.E. Ref.</i>	Taratura <i>Calibration</i>
103408	-	2,5 Bar
103408.1	-	4 Bar

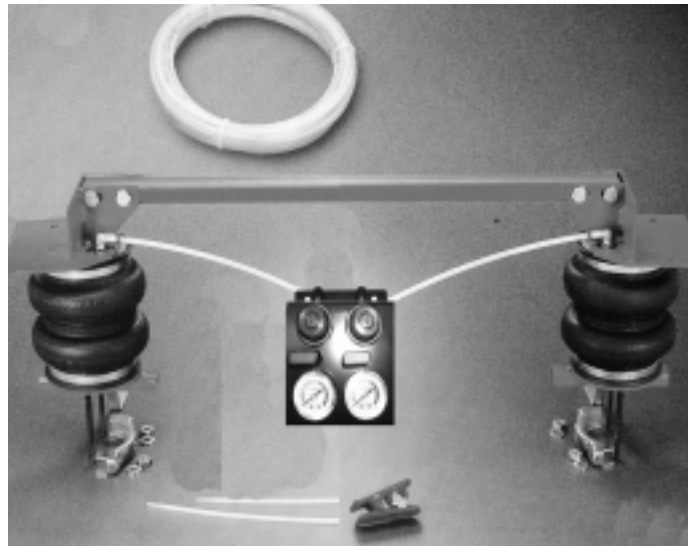

**Applicazione tipo veicolo
*Vehicle type***

RENAULT MASTER 35 U.T.

Ns.Rif. <i>Ns.Ref.</i>	Rif. O.E. <i>O.E. Ref.</i>	Taratura <i>Calibration</i>
103409	-	2,5 Bar
103409.1	-	4 Bar

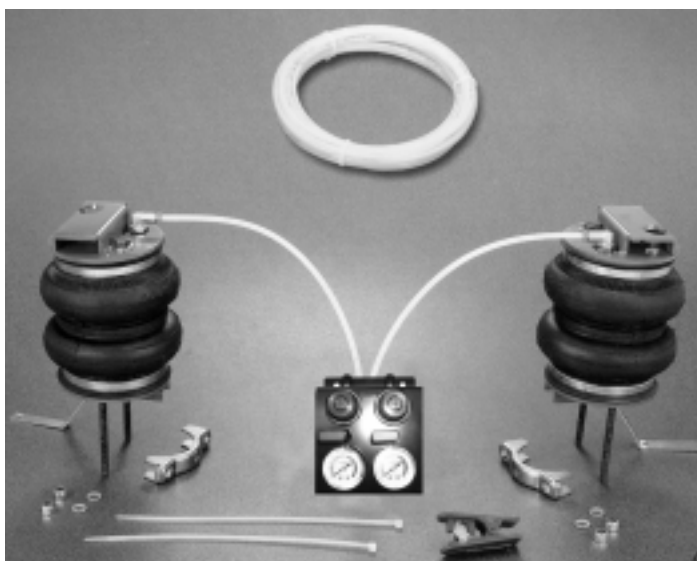

**Applicazione tipo veicolo
*Vehicle type***

RENAULT TRAFIC

EMMERDE

LISTINO PREZZI GENERALE GENERAL PRICE LIST MAGGIO - MAY 2009



REG FUTURE

FREDDAMENTO
COOLING SYSTEM
FROIDISSEMENT
REFRIGERACION
KUHLSYSTEM
Охлаждения
نظام التبريد

LINEA VARIE
DIVERSE PARTS
DIVERS
DIVERSOS RECAMBIOS
DIVERSE ARTIKELN
DIVERSE КОМПОНЕНТЫ

LINEA STERZO
STEERING LINE
DE DIRECTION
DE DIRECCION
LENKSYSTEM
Система управления
نظام القيادة

**TECHNO
BRAKE®**
LINEA FRENO
BRAKE SYSTEM
SYSTEME DE FREINAGE
LINEA DE FRENOS
BREMSSYSTEM
ТОРМОЗНАЯ СИСТЕМА
نظام الفرامل



EMMERDE

**TECHNO
BRAKE®**

LINEA DISCHI E PASTIGLIE FRENO
BRAKE DISC AND BRAKE PADS LINE

LISTINO PREZZI IN PROGRESSIONE RIFERIMENTI 
PRICE LIST IN ORDER OF  REFERENCE

	Rif.Originale Original Ref.	Adattabile a: Adaptable to:	Tipo Cat. Cat. Type	Pagina Page	Qtà/Conf. Q.ty/Pck.	OE	Cat. D	Listino Price L. €
100001	41028594	IVECO	Varie	38	1			19,90
100002	4617444	IVECO	Varie	251	1			18,00
100003	504085410	IVECO	Varie	250	1			15,00
100004	500342991	IVECO	Varie	251	1			49,00
100005	500342992	IVECO	Varie	251	1			49,00
100007	8557402	IVECO	Varie	251	1			12,00
100008	504060351	IVECO	Varie	253	1			17,00
100009	93803159	IVECO	Varie	250	1			22,00
100011	8588903	IVECO	Varie	250	1			19,00
100012	8588904	IVECO	Varie	250	1			19,00
100013	99470924	IVECO	Varie	253	1			14,00
100014	93803992	IVECO	Varie	253	1			5,50
100016	93814245	IVECO	Varie	253	1			17,00
100018	500398156	IVECO	Varie	244	1			32,00
100020	504004369	IVECO	Varie	244	1			32,00
100030	98401286	IVECO	Varie	254	1			11,50
100031	98405404	IVECO	Varie	254	1			11,50
100032	500329485	IVECO	Varie	260	1			2,98
100033	4714376	IVECO	Varie	254	1			23,00
100034	41003278	IVECO	Varie	38	1			17,00
100035	0003250496	MERCEDES	Varie	255	1			178,00
100036	0003250596	MERCEDES	Varie	255	1			130,00
100038	0003250896	MERCEDES	Varie	255	1			139,00
100039	1586089	VOLVO	Varie	256	1			136,00
100040	1609657	VOLVO	Varie	256	1			126,00
100041	1629553	VOLVO	Varie	256	1			126,00
100053	81962100554	MAN	Varie	255	1			250,00
100061	8582425	IVECO	Varie	250	1			37,00
100091	4467652	IVECO	Varie	251	1			90,00
100601	4654040	IVECO	Varie	259	1			12,00
100602	4725239	IVECO	Varie	259	1			9,50
100604	8584807	IVECO	Varie	259	1			4,50
100606	93911172	IVECO	Varie	259	1			23,50
100800	93802248	IVECO	Varie	227	2			1,75
100801	8557780	IVECO	Varie	228	2			5,00
100802	8563414	IVECO	Varie	228	2			5,50
100803	8125527	IVECO	Varie	229	2			7,90
100804	8558110	IVECO	Varie	228	2			7,50
100807	98431946	IVECO	Varie	230	2			9,00
100808	9703170112	MERCEDES	Varie	239	1			40,00
100809	4700488	IVECO	Varie	231	2			6,00
100810	4754678	IVECO	Varie	231	2			11,80
100811	4731981	IVECO	Varie	231	2			10,60
100812	2520448	IVECO	Varie	232	2			10,60
100813	8581295	IVECO	Varie	228	2			5,40
100814	8584196	IVECO	Varie	228	2			7,00
100816	4792127	IVECO	Varie	229	2			5,60
100819	98415468	IVECO	Varie	230	2			9,20
100820	8127910	IVECO	Varie	230	2			8,00
100821	98415469	IVECO	Varie	230	2			7,50
100822	8189831	IVECO	Varie	232	2			10,00
100823	8572709	IVECO	Varie	228	2			10,40
100824	98469634	IVECO	Varie	232	2			10,00
100825	98469635	IVECO	Varie	231	2			12,00
100826	9413260050	MERCEDES	Varie	239	2			40,00
100827	8585819	IVECO	Varie	227	2			2,50

LISTINO PREZZI IN PROGRESSIONE RIFERIMENTI EMMERRE
PRICE LIST IN ORDER OF EMMERRE REFERENCE

	Rif.Originale Original Ref.	Adattabile a: Adaptable to:	Tipo Cat. Cat. Type	Pagina Page	Qtà/Conf. Q.ty/Pck.	OE	Cat. D	Listino Price L. €
100830	4848464	IVECO	Varie	229	2			9,80
100831	8125528	IVECO	Varie	230	2			7,60
100832	98466340	IVECO	Varie	231	2			15,00
100832	98466340	IVECO	Varie	232	2			15,00
100850	93803961	IVECO	Varie	227	2			3,70
100853	8569607	IVECO	Varie	227	2			10,00
100854	8127423	IVECO	Varie	233	2			5,00
100855	8125490	IVECO	Varie	229	2			13,00
100856	8125491	IVECO	Varie	229	2			10,00
100857	8127383	IVECO	Varie	229	2			9,00
100858	8560291	IVECO	Varie	228	2			8,50
100859	4688153	IVECO	Varie	231	2		D	7,00
100860	4796745	IVECO	Varie	229	2			23,00
100861	4796746	IVECO	Varie	229	2			9,50
100862	98407169	IVECO	Varie	230	2			11,80
100863	98407168	IVECO	Varie	230	2			11,80
100864	8584626	IVECO	Varie	228	2			9,40
100865	8125492	IVECO	Varie	230	2			10,00
100867	8127381	IVECO	Varie	230	2			10,00
100868	4796971	IVECO	Varie	229	2			17,00
100869	4735723	IVECO	Varie	231	2			18,00
100870	2521481	IVECO	Varie	232	2			13,50
100871	4740646	IVECO	Varie	232	2			13,20
100872	4739171	IVECO	Varie	233	2			10,00
100873	2521850	IVECO	Varie	232	2			13,60
100874	41015581	IVECO	Varie	232	2			15,00
100875	8169892	IVECO	Varie	232	2			15,00
100876	93802629	IVECO	Varie	227	2			3,20
100877	8581021	IVECO	Varie	227	2			2,90
100878	93801556	IVECO	Varie	227	2			2,90
100879	8569596	IVECO	Varie	228	2			10,80
100880	98456259	IVECO	Varie	231	2			13,00
100881	98444831	IVECO	Varie	230	2			13,00
100882	98444833	IVECO	Varie	232	2			14,50
100883	98444832	IVECO	Varie	231	2			15,00
100884	81.43722.0087	MAN	Varie	234	2			43,00
100890	1391347	IVECO	Varie	233	2			5,50
100891	1391348	IVECO	Varie	233	2			5,50
100892	93807641	IVECO	Varie	233	2			6,00
100893	93807640	IVECO	Varie	233	2			6,00
100894	93810239	IVECO	Varie	233	2			6,00
100895	500350342	IVECO	Varie	241	2			10,00
100896	500350343	IVECO	Varie	241	2			9,00
100900	500326957	IVECO	Varie	241	2			2,50
100902	504112266	IVECO	Varie	241	2			14,00
100903	93814617	IVECO	Varie	227	2			9,60
100904	93814618	IVECO	Varie	227	2			9,60
100905	2521482	IVECO	Varie	232	2			18,00
100906	0010761	DAF	Varie	236	2			14,90
100907	9013230285	MERCEDES	Varie	236	2		D	0,88
100908	93802207	IVECO	Varie	252	1			6,50
100909	93807567	IVECO	Varie	252	1			4,80
100910	504060027	IVECO	Varie	252	1			11,00
100911	500306407	IVECO	Varie	252	1			11,00
100912	500316838	IVECO	Varie	253	1			8,40
100913	500316841	IVECO	Varie	253	1			6,80

LISTINO PREZZI IN PROGRESSIONE RIFERIMENTI 
PRICE LIST IN ORDER OF  **REFERENCE**

	Rif.Originale Original Ref.	Adattabile a: Adaptable to:	Tipo Cat. Cat. Type	Pagina Page	Qtà/Conf. Q.ty/Pck.	OE	Cat. D	Listino Price L. €
100914	500320322	IVECO	Varie	254	1			6,80
100915	9013260081	MERCEDES	Varie	236	2			1,90
100916	9013230185	MERCEDES	Varie	236	2			2,00
100917	9043230085	MERCEDES	Varie	236	2			2,00
100918	9043260881	MERCEDES	Varie	237	2			5,20
100919	3093200073	MERCEDES	Varie	237	2			3,00
100920	3183200073	MERCEDES	Varie	237	2			5,20
100921	0003232885	MERCEDES	Varie	237	2			1,80
100922	9743280181	MERCEDES	Varie	237	2			8,60
100923	9703231585	MERCEDES	Varie	238	2			4,50
100924	9743230285	MERCEDES	Varie	238	2			11,00
100927	9743230385	MERCEDES	Varie	238	2			11,00
100928	0003236285	MERCEDES	Varie	238	2			10,90
100930	0003262481	MERCEDES	Varie	238	2			11,00
100931	9413230350	MERCEDES	Varie	239	2			3,00
100932	0003262681	MERCEDES	Varie	239	2			11,50
100933	0003250685	MERCEDES	Varie	239	2			12,80
100934	0003264481	MERCEDES	Varie	239	2			12,80
100935	98404961	IVECO	Varie	254	1			58,00
100936	1075188	VOLVO	Varie	239	2			16,90
100937	93803299	IVECO	Varie	252	1			3,60
100938	1629169	VOLVO	Varie	240	2			12,50
100940	9519245	VOLVO	Varie	240	2			32,00
100942	1079256	VOLVO	Varie	240	2			33,00
100943	1077594	VOLVO	Varie	240	2			33,00
100944	1622838	VOLVO	Varie	240	2			23,00
100945	42078196	IVECO	Varie	249	1			46,00
100946	42078032	IVECO	Varie	249	1			41,00
100947	500398363	IVECO	Varie	34	2			14,00
100948	500398364	IVECO	Varie	34	2			11,00
100949	98482540	IVECO	Varie	234	2			5,50
100950	93800193	IVECO	Varie	234	2			6,80
100951	93808935	IVECO	Varie	234	2			4,50
100952	9425000050	MERCEDES	Varie	36	2			36,00
100953	8587681	IVECO	Varie	234	2			5,00
100954	9423100049	MERCEDES	Varie	36	2			35,00
100955	5010269380	RENAULT	Varie	36	2			7,40
100956	8160686	IVECO	Varie	234	2			23,50
100957	8160687	IVECO	Varie	234	2			25,00
100958	8162280	IVECO	Varie	234	2			10,00
100959	98413939	IVECO	Varie	234	2			17,00
100960	98413847	IVECO	Varie	234	2			11,00
100961	5000789265	RENAULT	Varie	37	2			8,50
100962	5010316015	RENAULT	Varie	37	2			15,40
100963	1744211	SCANIA	Varie	37	2			60,00
100964	0295726	DAF	Varie	242	1			24,80
100965	500343454	IVECO	Varie	242	2			26,00
100966	4746348	IVECO	Varie	242	2			27,50
100968	504112265	IVECO	Varie	242	1			16,00
100973	500336363	IVECO	Varie	244	1			28,00
100974	500336364	IVECO	Varie	244	1			24,50
100975	504011462	IVECO	Varie	234	1			16,80
101006	4694227	IVECO	Varie	34-246	2			20,00
101007	500357265	IVECO	Varie	35-247	1			17,50
101010	500351393	IVECO	Varie	35-247	1			47,00
101016	9423172312	MERCEDES	Varie	36-248	2			43,00

LISTINO PREZZI IN PROGRESSIONE RIFERIMENTI EMMERRE
PRICE LIST IN ORDER OF EMMERRE REFERENCE

	Rif.Originale Original Ref.	Adattabile a: Adaptable to:	Tipo Cat. Cat. Type	Pagina Page	Qtà/Conf. Q.ty/Pck.	OE	Cat. D	Listino Price L. €
101018	4576957	IVECO	Varie	245	1			14,50
101020	8141758	IVECO	Varie	245	1			25,00
101021	5010316874	RENAULT	Varie	38	1			45,00
101027	40101113	IVECO	Freno	371	1			35,00
101031	504021532	IVECO	Varie	35-247	1			47,00
101032	9403171112	MERCEDES	Varie	248	1			69,00
101034	8141581	IVECO	Varie	34	1			44,00
101035	1907808	IVECO	Varie	16-247	1			24,00
101036	1908221	IVECO	Varie	17-247	1			27,50
101037	42470849	IVECO	Varie	19	1			48,00
101038	42470850	IVECO	Varie	19	1		D	33,00
101039	42070674	IVECO	Varie	34-246	2			8,00
101040	42105574	IVECO	Varie	34-246	2			8,50
101041	42471164	IVECO	Varie	20	1			65,00
101042	42471165	IVECO	Varie	20	1			65,00
101043	42536919	IVECO	Varie	20	1		D	41,00
101045	42052453	IVECO	Varie	26	1			94,00
101047	500331831	IVECO	Varie	35-246	1			28,50
101048	41009544	IVECO	Varie	35-247	1			19,00
101049	42070675	IVECO	Varie	35-246	2			4,90
101050	61596842	IVECO	Varie	257	1			29,00
101051	42040707	IVECO	Varie	257	1			25,00
101053	8141955	IVECO	Varie	257	1			32,00
101054	98479283	IVECO	Varie	258	1			125,00
101055	-	IVECO	Varie	34-246	1			19,00
101056	98473621	IVECO	Varie	258	1			130,00
101400	93804576	IVECO	Freno	364	10			3,00
101401	40100483	IVECO	Freno	365	10			7,50
101402	40102273	IVECO	Freno	365	10			13,00
101403	40001883	IVECO	Freno	366	10			4,60
101403	0029978447	MERCEDES	Freno	377	10			4,60
101404	40001903	IVECO	Freno	367	10			4,50
101405	40001030	IVECO	Freno	368	10			6,50
101406	40001933	IVECO	Freno	369	10			6,60
101500	40100653	IVECO	Freno	370	10			11,00
101501	40100113	IVECO	Freno	367	10			7,00
101502	40100103	IVECO	Freno	371	10			12,00
101504	40001913	IVECO	Freno	370	10			6,00
101505	40001790	IVECO	Freno	370	2			7,00
101506	40100443	IVECO	Freno	372	10			10,00
101507	40100673	IVECO	Freno	373	10			30,00
101508	40101733	IVECO	Freno	373	2			36,00
101509	40000950	IVECO	Freno	371	10			10,00
101510	40000690	IVECO	Freno	372	10			11,00
101511	40102941	IVECO	Freno	372	2			54,00
101512	42127773	IVECO	Freno	373	2			27,50
101513	40001060	IVECO	Freno	368	10			6,00
101514	40001050	IVECO	Freno	371	10			9,00
101515	0139979447	MERCEDES	Freno	377	2			11,00
101516	0169975647	MERCEDES	Freno	377	2			9,00
101517	40102263	IVECO	Freno	392	10			18,00
101518	40102283	IVECO	Freno	366	10			18,50
101519	42127526	IVECO	Freno	372	10			15,00
101520	300278	SCANIA	Freno	381	2			6,50
101521	40102301	IVECO	Freno	366	10			39,50
101522	40101540	IVECO	Freno	393	10			21,00

LISTINO PREZZI IN PROGRESSIONE RIFERIMENTI 
PRICE LIST IN ORDER OF  **REFERENCE**

	Rif.Originale Original Ref.	Adattabile a: Adaptable to:	Tipo Cat. Cat. Type	Pagina Page	Qtà/Conf. Q.ty/Pck.	OE	Cat. D	Listino Price L. €
101523	647330	DAF	Freno	363	2			5,00
101524	1334535	SCANIA	Freno	381	2			7,00
101525	01001200	CARDI	Freno	387	2		D	4,30
101526	173320	SCANIA	Freno	381	2			6,50
101527	159496	SCANIA	Freno	382	2			8,00
101528	40100463	IVECO	Freno	370	10			11,00
101529	370076	SCANIA	Freno	382	2			9,00
101530	375086	SCANIA	Freno	382	2			6,00
101531	375087	SCANIA	Freno	381	2			4,00
101532	1610765	VOLVO	Freno	385	2			38,00
101533	1672283	VOLVO	Freno	384	2			39,00
101534	1089552	VOLVO	Freno	383	2			27,00
101535	944667	VOLVO	Freno	384	2			6,00
101536	1610078	VOLVO	Freno	383	2			6,50
101537	21200321/A	ROR	Freno	388	2			15,00
101538	21220158	ROR	Freno	388	2			12,00
101539	02.5664.57.00	BPW	Freno	386	2			6,80
101540	02.5664.58.00	BPW	Freno	386	2			7,50
101545	40002160	IVECO	Freno	392	10			4,00
101550	40102333	IVECO	Freno	369	2			46,00
101551	40102321	IVECO	Freno	368	2			45,00
101559	7185250	IVECO	Freno	367	10			25,50
101560	40102143	IVECO	Freno	367	10			25,50
101563	292766	DAF	Freno	363	2			41,50
101564	259940	DAF	Freno	363	2			20,00
101565	40102093	IVECO	Freno	365	10			15,00
101566	40102503	IVECO	Freno	365	10			24,00
101567	40102103	IVECO	Freno	369	10			38,50
101568	9403500335	MERCEDES	Freno	379	2			58,00
101568	6243560080S	MAN	Freno	375	2			58,00
101569	9403500035	MERCEDES	Freno	380	2			76,00
101569	6593500135S	MAN	Freno	375	2			76,00
101570	06562890038	MAN	Freno	376	2			7,00
101571	0209973947	MERCEDES	Freno	378	2			25,00
101575	948448	VOLVO	Freno	383	2			11,00
101576	948642	VOLVO	Freno	383	2			11,00
101578	1522372	VOLVO	Freno	384	2			33,00
101579	944665	VOLVO	Freno	385	2			11,00
101580	273394	VOLVO	Freno	385	2			30,00
101581	40102133	IVECO	Freno	392	10			22,00
101582	40102053	IVECO	Freno	392	10			18,50
101583	40101623	IVECO	Freno	393	10			25,70
101584	42031684	IVECO	Freno	393	10			6,00
101585	1522895	VOLVO	Freno	394	2			15,00
101586	1522894	VOLVO	Freno	394	2			27,00
101600	40001670	IVECO	Freno	366-391	10			4,20
101601	40000610	IVECO	Freno	391	10			5,50
101602	40000410	IVECO	Freno	390	10			4,50
101603	40000283	IVECO	Freno	390	10			3,50
101605	40000520	IVECO	Freno	390	10			3,50
101606	40001320	IVECO	Freno	389	10			5,50
101607	40000490	IVECO	Freno	389	10			3,80
101608	40000583	IVECO	Freno	389	10			2,95
101609	595985	IVECO	Freno	389	10			3,00
101610	8121803	IVECO	Freno	391	10			15,00
101611	1905085	IVECO	Freno	391	10			13,00

LISTINO PREZZI IN PROGRESSIONE RIFERIMENTI EMMERRE
PRICE LIST IN ORDER OF EMMERRE REFERENCE

	Rif.Originale Original Ref.	Adattabile a: Adaptable to:	Tipo Cat. Cat. Type	Pagina Page	Qtà/Conf. Q.ty/Pck.	OE	Cat. D	Listino Price L. €
101612	8870829	IVECO	Freno	389	1			8,00
102375	42088612	IVECO	Varie	262	1			60,00
102377	42088622	IVECO	Varie	262	1			85,00
102378	42106780	IVECO	Varie	262	1			85,00
102379	42106779	IVECO	Varie	262	1			85,00
102393	42088621	IVECO	Varie	262	1			76,00
102394	8134300	IVECO	Varie	262	1			80,00
103400	-	FIAT	Varie	263	1		D	460,00
103400.1	-	FIAT	Varie	263	1		D	460,00
103401	-	FIAT	Varie	263	1		D	460,00
103401.1	-	FIAT	Varie	263	1		D	460,00
103402	-	MERCEDES	Varie	267	1		D	460,00
103402.1	-	MERCEDES	Varie	267	1		D	460,00
103403	-	MERCEDES	Varie	267	1		D	460,00
103403.1	-	MERCEDES	Varie	267	1		D	460,00
103404	-	IVECO	Varie	266	1		D	460,00
103404.1	-	IVECO	Varie	266	1		D	460,00
103405	-	IVECO	Varie	266	1		D	460,00
103405.1	-	IVECO	Varie	266	1		D	460,00
103406	-	FORD	Varie	264	1		D	460,00
103406.1	-	FORD	Varie	264	1		D	460,00
103407	-	FORD	Varie	264	1		D	460,00
103407.1	-	FORD	Varie	264	1		D	460,00
103408	-	RENAULT	Varie	269	1		D	460,00
103408.1	-	RENAULT	Varie	269	1		D	460,00
103409	-	RENAULT	Varie	270	1		D	460,00
103409.1	-	RENAULT	Varie	270	1		D	460,00
103412	-	NISSAN	Varie	268	1		D	460,00
103412.1	-	NISSAN	Varie	268	1		D	460,00
103413	-	NISSAN	Varie	268	1		D	460,00
103413.1	-	NISSAN	Varie	268	1		D	460,00
103414	-	FORD	Varie	264	1		D	460,00
103414.1	-	FORD	Varie	264	1		D	460,00
103415	-	NISSAN	Varie	268	1		D	460,00
103415.1	-	NISSAN	Varie	268	1		D	460,00
103416	-	MERCEDES	Varie	267	1		D	460,00
103416.1	-	MERCEDES	Varie	267	1		D	460,00
103417	-	RENAULT	Varie	269	1		D	460,00
103417.1	-	RENAULT	Varie	269	1		D	460,00
103418	-	IVECO	Varie	266	1		D	460,00
103418.1	-	IVECO	Varie	266	1		D	460,00
103419	-	RENAULT	Varie	269	1		D	460,00
103419.1	-	RENAULT	Varie	269	1		D	460,00
103420	-	FORD	Varie	264	1		D	460,00
103420.1	-	FORD	Varie	264	1		D	460,00
103421	-	FIAT	Varie	263	1		D	460,00
103421.1	-	FIAT	Varie	263	1		D	460,00
103422	-	FORD	Varie	265	1		D	460,00
103422.1	-	FORD	Varie	265	1		D	460,00
103423	-	FORD	Varie	265	1		D	460,00
103423.1	-	FORD	Varie	265	1		D	460,00
103500	-	VARI	Varie	270	1		D	132,00
103515.1	-	VARI	Varie	270	1		D	125,00
103515.2	-	VARI	Varie	270	1		D	125,00
103600	4601722	IVECO	Varie	235	2			8,00
103602	4606624	IVECO	Varie	235	2			8,00

LISTINO PREZZI IN PROGRESSIONE RIFERIMENTI 
PRICE LIST IN ORDER OF  **REFERENCE**

	Rif.Originale Original Ref.	Adattabile a: Adaptable to:	Tipo Cat. Cat. Type	Pagina Page	Qtà/Conf. Q.ty/Pck.	OE	Cat. D	Listino Price L. €
103603	4791448	IVECO	Varie	235	2			7,50
103606	98481106	IVECO	Varie	261	4			1,90
103607	98481105	IVECO	Varie	261	4			3,50
103608	61315069	IVECO	Varie	260	1			21,00
103609	-	IVECO	Varie	121	1			17,50
103610	4733157	IVECO	Varie	260	1			20,00
103611	4771078	IVECO	Varie	260	1			18,50
103612	-	IVECO	Varie	121	1			11,70
103613	4600893	IVECO	Varie	261	2			0,50
103614	-	IVECO	Varie	121	1			12,20
103615	93818454	IVECO	Varie	121	2			1,80
103618	-	IVECO	Varie	121	1			29,00
103619	-	IVECO	Varie	122	2			9,00
103621	-	IVECO	Varie	122	2			9,30
103628	93803481	IVECO	Sterzo	115	1			35,00
103631	4625614	IVECO	Varie	260	2			12,90
103634	9921902	IVECO	Sterzo	115	2			9,50
103634	9921902	IVECO	Varie	260	2			9,50
103635	42061628	IVECO	Varie	261	10			4,30
103637	42026473	IVECO	Varie	187	2			3,80
103639	4459785	IVECO	Varie	187	2			5,50
103640	42118229	IVECO	Varie	186	2			5,50
103647	42493640	IVECO	Freno	396	10			0,98
103648	42480064	IVECO	Freno	396	10			0,83
103651	93802390	IVECO	Varie	243	2			5,00
103652	93802391	IVECO	Varie	243	2			5,00
103653	93802392	IVECO	Varie	243	2			4,50
103673	93802631	IVECO	Varie	235	2			3,00
103674	8581022	IVECO	Varie	235	2			4,00
103675	93801624	IVECO	Varie	235	2			4,00
103676	8162306	IVECO	Varie	235	2			12,00
103678	500336108	IVECO	Varie	235	2			20,00
103680	500343453	IVECO	Varie	242	2			15,00
103682	93801623	IVECO	Varie	235	2			3,50
103683	93803960	IVECO	Varie	235	2			3,80
304000	1411100	IVECO	Varie	276	1		D	568,00
503410	-	FIAT	Varie	274	1		D	780,00
503420	-	FORD	Varie	274	1		D	780,00
503430	-	IVECO	Varie	275	1		D	780,00
503440	-	MERCEDES	Varie	275	1		D	780,00
900210	4713556	IVECO	Varie	41	4			4,00
900222	113811	IVECO	Varie	41	4			13,50
900223	554876	IVECO	Varie	41	4			13,50
900224	555783	IVECO	Varie	41	4			13,50
900225	4718317	IVECO	Varie	41	4			13,50
900226	4718320	IVECO	Varie	41	4			13,50
900227	98444872	IVECO	Varie	41	4			13,50
900228	4720310	IVECO	Varie	41	4			13,50
900229	98444904	IVECO	Varie	41	4			6,40
900230	8827057	IVECO	Varie	41	4			13,50
900231	8827066	IVECO	Varie	41	4			13,50
900232	8827086	IVECO	Varie	41	4			13,50
900233	8504683	IVECO	Varie	41	4			13,50
900234	8504930	IVECO	Varie	41	4			13,50
900235	4720307	IVECO	Varie	41	4			17,50
900271	98490937	IVECO	Varie	79	10			4,00

LISTINO PREZZI IN PROGRESSIONE RIFERIMENTI EMMERRE
PRICE LIST IN ORDER OF EMMERRE REFERENCE

	Rif.Originale Original Ref.	Adattabile a: Adaptable to:	Tipo Cat. Cat. Type	Pagina Page	Qtà/Conf. Q.ty/Pck.	OE	Cat. D	Listino Price L. €
900290	4693033	IVECO	Varie	42	4			15,00
900293	4756200	IVECO	Varie	79	10			2,40
900297	7303099	IVECO	Varie	79	10			3,60
900298	7303100	IVECO	Varie	79	10			0,88
900438	-	IVECO	Varie	87	1			40,50
900439	-	IVECO	Varie	87	1			40,50
900440	-	IVECO	Varie	83	1			47,00
900441	-	IVECO	Varie	85	1			47,00
900442	-	IVECO	Varie	85	1			57,00
900443	-	IVECO	Varie	86	1			42,00
900445	4856612	IVECO	Varie	82	1			8,90
900446	-	IVECO	Varie	85	1			70,00
900448	-	IVECO	Varie	85	1			42,00
900512	8162322	IVECO	Varie	108	1			98,00
900513	98452488	IVECO	Varie	108	1			104,00
900600	-	IVECO	Varie	88	1			75,00
900601	-	IVECO	Varie	83	1			75,00
900602	-	IVECO	Varie	84	1			75,00
900603	-	IVECO	Varie	83	1			57,00
900605	-	IVECO	Varie	84	1			65,00
900606	-	IVECO	Varie	84	1			65,00
900608	-	IVECO	Varie	88	1			75,00
900609	-	IVECO	Varie	89	1			75,00
900620	-	IVECO	Varie	89	1			60,00
900660	-	IVECO	Varie	88	1			60,00
900661	-	IVECO	Varie	88	1			63,00
900700	8188890	IVECO	Varie	91	1			220,00
900701	42124998	IVECO	Varie	91	1			190,00
900702	500364392	IVECO	Varie	93	1			186,00
900703	42536146	IVECO	Varie	93	1			98,00
901151	99433386	IVECO	Varie	45	1			125,00
901152	8819789	IVECO	Varie	44	1			42,00
901153	4279804	IVECO	Varie	44	1			15,00
901154	4602143	IVECO	Varie	44	1			35,00
901156	4602203	IVECO	Varie	45	1			33,50
901157	4718356	IVECO	Varie	45	1			56,00
901158	4672334	IVECO	Varie	45	1			74,00
901159	8819718	IVECO	Varie	44	1			46,00
901160	4862411	IVECO	Varie	44	1			45,00
901205	-	IVECO	Varie	52	1			140,00
901206	-	IVECO	Varie	52	1			132,00
901210	-	IVECO	Varie	52	1			114,00
901211	-	IVECO	Varie	52	1			124,00
901214	-	IVECO	Varie	53	1			148,00
901215	-	IVECO	Varie	53	1			142,00
901216	500341808	IVECO	Varie	50	1			76,00
901217	500341810	IVECO	Varie	50	1	OE	D	68,00
901218	500328020	IVECO	Varie	50	1	OE	D	50,00
901220	7303414	IVECO	Varie	51	1	OE	D	30,00
901221	7303415	IVECO	Varie	51	1	OE	D	30,00
901222	500323627	IVECO	Varie	51	1	OE	D	73,00
901223	99456477	IVECO	Varie	51	1			73,00
901224	99456476	IVECO	Varie	51	1			73,00
901239	500371975	IVECO	Varie	51	1		D	79,00
901245	4672177	IVECO	Varie	43	32			1,50
901300	504000412	IVECO	Varie	54	1			35,00

LISTINO PREZZI IN PROGRESSIONE RIFERIMENTI 
PRICE LIST IN ORDER OF  **REFERENCE**

	Rif.Originale Original Ref.	Adattabile a: Adaptable to:	Tipo Cat. Cat. Type	Pagina Page	Qtà/Conf. Q.ty/Pck.	OE	Cat. D	Listino Price L. €
901301	7301662	IVECO	Varie	54	1			32,00
901302	7301661	IVECO	Varie	54	1			32,00
901303	4803462	IVECO	Varie	55	1			45,00
901304	-	IVECO	Varie	56	1			109,00
901305	500393575	IVECO	Varie	54	1			32,00
901306	500388688	IVECO	Varie	54	1			28,00
901307	504010846	IVECO	Varie	55	1			49,00
901308	500332622	IVECO	Varie	55	1			62,50
901309	4891116	IVECO	Varie	56	1			75,00
901310	504006261	IVECO	Varie	58	1			85,00
901311	4279745	IVECO	Varie	53	1			8,50
901312	98480740	IVECO	Varie	57	1		D	110,00
901313	500301088	IVECO	Varie	57	1		D	120,00
901314	4616156	IVECO	Varie	55	1			50,00
901315	4606784	IVECO	Varie	56	1			125,00
901316	4831072	IVECO	Varie	56	1			110,00
901317	504046191	IVECO	Varie	58	1			75,00
901318	99449176	IVECO	Varie	58	1			58,00
901319	500350419	IVECO	Varie	58	1			65,00
901320	500346227	IVECO BUS	Varie	59	1		D	110,00
901321	504029278	IVECO BUS	Varie	59	1		D	110,00
901323	4897031	IVECO	Varie	57	1			20,00
901324	9062002070	MERCEDES	Varie	60	1		D	100,00
901326	1383564	SCANIA	Varie	60	1		D	65,00
901327	1545982	SCANIA	Varie	60	1		D	105,00
901328	1432743	SCANIA	Varie	60	1		D	135,00
901329	3979980	VOLVO	Varie	60	1			166,00
901330	504086751	IVECO	Varie	55	1			62,00
901331	504065874	IVECO	Varie	56	1			70,00
901332	504065877	IVECO	Varie	57	1			40,00
901333	2992484	IVECO	Varie	53	1			25,00
901337	2992485	IVECO	Varie	53	1			22,50
901338	504065878	IVECO	Varie	57	1			40,00
901339	500305943	IVECO	Varie	74	1			237,00
901340	99473900	IVECO	Varie	74	1		D	140,00
901345	504086948	IVECO	Varie	55	1			52,00
901504	-	IVECO	Varie	61	1			21,00
901512	-	IVECO	Varie	61	1			16,50
901543	-	IVECO	Varie	61	1			44,00
902000	4866350	IVECO	Varie	61	1			85,00
902001	4774412	IVECO	Varie	62	4			9,00
902004	4724601	IVECO	Varie	62	1			18,50
902005	4724604	IVECO	Varie	62	1			18,50
902006	4724603	IVECO	Varie	62	1			19,50
902007	500314583	IVECO	Varie	62	1			60,00
902012	99444499	IVECO	Varie	62	1			80,00
902285	569308	IVECO	Varie	42	4			10,50
902288	576615	IVECO	Varie	42	4			10,50
902289	98471524	IVECO	Varie	42	4		D	10,00
902291	4753580	IVECO	Varie	42	4			18,00
902293	4733350	IVECO	Varie	42	8			8,50
902294	98494902	IVECO	Varie	72	1			43,00
902295	4672175	IVECO	Varie	43	16			18,50
902296	4856604	IVECO	Varie	220	1			27,50
902297	99438751	IVECO	Varie	220	1		D	13,40
902298	8796328	IVECO	Varie	220	1			48,00

LISTINO PREZZI IN PROGRESSIONE RIFERIMENTI EMMERRE
PRICE LIST IN ORDER OF EMMERRE REFERENCE

	Rif.Originale Original Ref.	Adattabile a: Adaptable to:	Tipo Cat. Cat. Type	Pagina Page	Qtà/Conf. Q.ty/Pck.	OE	Cat. D	Listino Price L. €
902299	42008943	VARI	Varie	221	1			35,00
902363	500339316	IVECO	Varie	212	1			55,00
902364	4799471	IVECO	Varie	212	1			206,00
902365	4799472	IVECO	Varie	49	1			74,00
902366	500315622	IVECO	Varie	244	1			75,00
902374	4822328	IVECO	Varie	49	1			74,00
902378	4706366	IVECO	Varie	49	1			80,00
902908	4770859	IVECO	Varie	43	2			12,50
902925	4679070	IVECO	Varie	43	2			22,00
902930	-	IVECO	Varie	43	16			25,00
903009	8548351	IVECO	Varie	224	1		D	20,00
903039	41029915	IVECO	Varie	49	1			195,00
903040	98416091	IVECO	Varie	49	1			49,50
904055	-	VARI	Varie	206	1			17,00
904057	-	IVECO	Varie	207	2			13,50
904058	-	IVECO	Varie	207	2			14,50
904059	-	IVECO	Varie	207	2			15,50
904060	RT 06	IVECO	Varie	207	20			3,10
904061	RT 16	IVECO	Varie	207	10			2,30
904063	-	IVECO	Varie	208	2			33,00
904065	-	IVECO	Varie	208	2			35,00
905012	-	IVECO	Varie	112	1			250,00
905066	4751355	IVECO	Varie	101	1			74,00
905067	4751356	IVECO	Varie	101	1			74,00
905084	4836361	IVECO	Varie	77	1			17,50
905085	4839530	IVECO	Varie	77	1			14,50
905089	-	IVECO	Varie	77	1			18,00
905090	-	IVECO	Varie	77	1			18,00
905091	4745192	IVECO	Varie	70	1			45,00
905092	4741946	IVECO	Varie	71	1			45,00
905140	-	IVECO	Varie	82	1			17,50
905141	-	IVECO	Varie	83	1			31,00
905142	-	IVECO	Varie	84	1			33,50
905143	-	IVECO	Varie	85	1			85,00
905144	-	IVECO	Varie	86	1			85,00
905145	-	IVECO	Varie	86	1			47,50
905146	-	IVECO	Varie	86	1			33,00
905148	-	IVECO	Varie	87	1			38,50
905152	-	IVECO	Varie	89	1			73,00
905157	-	IVECO	Varie	82	1			25,00
905159	-	IVECO	Varie	84	1			85,00
905160	-	IVECO	Varie	89	1			44,00
905178	-	IVECO	Varie	87	1			85,00
905179	-	IVECO	Varie	86	1			60,00
905180	2992533	IVECO	Varie	82	1			5,30
905181	99477121	IVECO	Varie	83	1			12,40
905201	500329488	IVECO	Varie	102	1			280,00
905202	504033946	IVECO	Varie	102	1		D	120,00
905203	504033945	IVECO	Varie	102	1			130,00
905204	41007585	IVECO	Varie	104	1			255,00
905205	41210818	IVECO	Varie	104	1			290,00
905206	41210895	IVECO	Varie	104	1			290,00
905208	500388499	IVECO	Varie	103	1			270,00
905214	500369619	IVECO	Varie	103	1			245,00
905215	500369621	IVECO	Varie	103	1			245,00
905216	500370057	IVECO	Varie	104	1			235,00

LISTINO PREZZI IN PROGRESSIONE RIFERIMENTI 
PRICE LIST IN ORDER OF  **REFERENCE**

	Rif.Originale Original Ref.	Adattabile a: Adaptable to:	Tipo Cat. Cat. Type	Pagina Page	Qtà/Conf. Q.ty/Pck.	OE	Cat. D	Listino Price L. €
905218	500340797	IVECO	Varie	102	1			235,00
905219	99481953	IVECO	Varie	103	1			250,00
905221	98453453	IVECO	Varie	107	1			90,00
905222	500322473	IVECO	Varie	104	1			200,00
905254	98495744	IVECO	Varie	108	1			155,00
905255	42075873	IVECO	Varie	109	1			115,00
905256	42075874	IVECO	Varie	109	1			115,00
905257	4812644	IVECO	Varie	109	1			200,00
905260	42092909	IVECO	Varie	112	1			104,00
905306	42091273	IVECO	Varie	101	1			100,00
905311	-	IVECO	Varie	122	1			13,50
905312	-	IVECO	Varie	122	1			21,00
905314	4643918	IVECO	Varie	123	2			4,80
905316	8564147	IVECO	Varie	123	2			3,30
905317	4066081	IVECO	Varie	123	2			3,60
905328	2513647	IVECO	Varie	101	1			22,00
905403	41210965	IVECO	Varie	116	1			620,00
905404	41020590	IVECO	Varie	117	1			670,00
905409	4760902	IVECO	Varie	118	1			24,00
905419	-	IVECO	Varie	110	1			65,00
905420	-	IVECO	Varie	111	1			65,00
905421	-	IVECO	Varie	110	1			65,00
905422	-	IVECO	Varie	111	1			71,00
905424	-	IVECO	Varie	112	1			170,00
905428	42090557	IVECO	Varie	116	1			260,00
905432	-	IVECO	Varie	110	1			40,00
905433	-	IVECO	Varie	111	1			42,00
905435	-	IVECO	Varie	112	1			32,00
905436	-	IVECO	Varie	107	1			49,00
905444	42092241	IVECO	Varie	108	1			100,00
905445	4020316	IVECO	Varie	105	1			14,50
905446	4555085	IVECO	Varie	106	1			15,00
905447	4776196	IVECO	Varie	106	1			22,50
905448	8569477	IVECO	Varie	105	1			16,00
905449	8569057	IVECO	Varie	105	1			25,50
905451	500329489	IVECO	Varie	114	1			185,00
905452	99456851	IVECO	Varie	114	1			195,00
905455	99461871	IVECO	Varie	115	1			280,00
905456	500370650	IVECO	Varie	114	1			260,00
905457	500370649	IVECO	Varie	115	1			260,00
905458	-	IVECO	Varie	105	1			48,00
905459	-	IVECO	Varie	105	1			48,00
905461	42092927	IVECO	Varie	106	1			80,00
905464	8590315	IVECO	Varie	114	1			90,00
905465	8590408	IVECO	Varie	114	1			92,00
905471	42090050	IVECO	Varie	107	1			76,00
905472	42093015	IVECO	Varie	107	1			90,00
905473	4837896	IVECO	Varie	115	1			205,00
905475	93806921	IVECO	Varie	113	1		D	50,00
905476	98429580	IVECO	Varie	115	1			150,00
905477	93811160	IVECO	Varie	113	1			120,00
905478	93809509	IVECO	Varie	113	1			120,00
905480	42094745	IVECO	Varie	106	1			95,00
905488	-	IVECO	Varie	111	1			130,00
905506	4634888	IVECO	Varie	94	1			115,00
905508	-	IVECO	Varie	95	1			70,00

LISTINO PREZZI IN PROGRESSIONE RIFERIMENTI EMMERRE
PRICE LIST IN ORDER OF EMMERRE REFERENCE

	Rif.Originale Original Ref.	Adattabile a: Adaptable to:	Tipo Cat. Cat. Type	Pagina Page	Qtà/Conf. Q.ty/Pck.	OE	Cat. D	Listino Price L. €
905510	4616372	IVECO	Varie	94	1			98,00
905517	61319208	IVECO	Varie	77	5			2,50
905527	98409494	IVECO	Varie	77	5			3,80
905533	98433292	IVECO	Varie	78	5			5,00
905534	4677101	IVECO	Varie	94	1			72,00
905538	8589637	IVECO	Varie	78	2			2,30
905539	4512366	IVECO	Varie	78	2			3,10
905541	4733026	IVECO	Varie	78	2			4,00
905542	4729026	IVECO	Varie	78	2			5,00
905543	4722894	IVECO	Varie	78	2			2,80
905550	98489690	IVECO	Varie	77	5			2,30
905555	98491312	IVECO	Varie	79	10			4,50
905558	4782794	IVECO	Varie	96	1			22,00
905562	3091751	VOLVO	Varie	220	1	OE	D	200,00
905566	98428396	IVECO	Varie	78	2			3,20
905569	4758497	IVECO	Varie	92	1			210,00
905570	4758498	IVECO	Varie	92	1			210,00
905571	4722854	IVECO	Varie	94	1			72,00
905576	42070533	IVECO	Varie	97	1			14,00
905577	93191098	IVECO	Varie	97	1			16,00
905579	42491686	IVECO	Varie	97	1			25,00
905590	42491687	IVECO	Varie	95	2			6,00
905595	42051740	IVECO	Varie	92	1			170,00
905596	42070537	IVECO	Varie	92	1			100,00
905597	4791129	IVECO	Varie	90	1			220,00
905600	42124922	IVECO	Varie	91	1			112,00
905602	4700966	IVECO	Varie	98	1			69,00
905603	93159509	IVECO	Varie	93	1			86,00
905605	4695111	IVECO	Varie	98	1			80,00
905608	42075987	IVECO	Varie	78	2			4,40
905609	500322095	IVECO	Varie	93	1			180,00
905612	42086121	IVECO	Varie	91	1			205,00
905619	-	IVECO	Varie	99	1			65,00
905620	-	IVECO	Varie	99	1			75,00
905621	42042638	IVECO	Varie	98	1			36,00
905622	41022031	IVECO	Varie	98	1			33,00
905623	7981576	IVECO	Varie	98	1			33,00
905624	41022032	IVECO	Varie	98	1			33,00
905625	99436004	IVECO	Varie	81	1			49,00
905629	42126564	IVECO	Varie	98	1			44,00
905630	81157016080	IVECO	Varie	99	1			70,00
905631	81157016112	IVECO	Varie	99	1			108,00
905632	735121	DAF	Varie	99	1			46,00
905632	88157016202	MAN	Varie	99	1			46,00
905634	0004300126	MERCEDES	Varie	100	1			44,00
905634	0482006009	MERCEDES	Varie	100	1			44,00
905635	0003530255	MERCEDES	Varie	100	1			94,00
905636	0001400459	MERCEDES	Varie	100	1			96,00
905645	98418118	IVECO	Varie	93	1			250,00
905646	98439693	IVECO	Varie	92	1			165,00
905651	-	IVECO	Varie	112	1			520,00
905660	0004343801	MERCEDES	Varie	96	1			34,00
905661	0004342401	MERCEDES	Varie	96	1			20,00
905664	8193845	IVECO	Varie	90	1			128,00
905665	93159929	IVECO	Varie	93	1			144,00
905669	504059011	IVECO	Varie	102	1			192,00

LISTINO PREZZI IN PROGRESSIONE RIFERIMENTI EMMERRE
PRICE LIST IN ORDER OF EMMERRE REFERENCE

	Rif.Originale Original Ref.	Adattabile a: Adaptable to:	Tipo Cat. Cat. Type	Pagina Page	Qtà/Conf. Q.ty/Pck.	OE	Cat. D	Listino Price L. €
905670	93818452	IVECO	Varie	113	1			207,00
905671	93822669	IVECO	Varie	113	1			200,00
905672	93822846	IVECO	Varie	113	1			200,00
905675	41019045	IVECO	Varie	116	1			450,00
905676	41019322	IVECO	Varie	116	1			550,00
905677	500329483	IVECO	Varie	113	1			175,00
905678	41213998	IVECO	Varie	117	1	OE		1.400,00
905680	41214000	IVECO	Varie	117	1	OE		1.450,00
905731	-	IVECO	Varie	95	2			10,00
905732	-	IVECO	Varie	95	2			10,00
905733	-	IVECO	Varie	95	2			10,00
905734	-	IVECO	Varie	95	2			10,00
905735	-	IVECO	Varie	95	2			10,00
905736	-	IVECO	Varie	95	2			10,00
905739	18007911	IVECO	Varie	95	2			3,90
905748	93191099	IVECO	Varie	97	1			16,00
905749	4802797	IVECO	Varie	97	1			29,00
905755	42090446	IVECO	Varie	106	1			82,00
905757	42094753	IVECO	Varie	107	1			98,00
905870	93160305	IVECO	Varie	92	1			96,00
905882	-	IVECO	Varie	118	1			12,00
905883	-	IVECO	Varie	118	1			12,00
905884	-	IVECO	Varie	118	1			12,50
905901	98435271	IVECO	Varie	123	1			6,90
905902	41015983	IVECO	Varie	125	1			16,00
905904	8540133	IVECO	Varie	118	2			4,40
905905	93801183	IVECO	Varie	118	2			6,20
905906	4722405	IVECO	Varie	123	1			12,00
905907	8586089	IVECO	Varie	118	2			5,20
905909	61597791	IVECO	Varie	119	2			9,50
905910	42090154	IVECO	Varie	119	2			9,50
905911	2491711	IVECO	Varie	119	2			15,50
905912	42075535	IVECO	Varie	123	1			12,00
905933	41800522	IVECO	Varie	119	2			9,40
905935	4751044	IVECO	Varie	118	1			59,00
905940	42090027	IVECO	Varie	124	1			8,50
905942	-	IVECO	Varie	125	1			23,00
905943	-	IVECO	Varie	124	1			10,00
905944	-	IVECO	Varie	124	1			12,50
905955	41028424	IVECO	Varie	119	2			9,00
905957	-	IVECO	Varie	125	1			26,00
905960	-	IVECO	Varie	119	2			6,00
905967	-	IVECO	Varie	119	2			7,90
905973	-	IVECO	Varie	119	2			8,90
905977	-	IVECO	Varie	125	1			18,50
905986	41015925	IVECO	Varie	124	1			21,00
905988	-	IVECO	Varie	124	1			15,00
905990	-	IVECO	Varie	120	1			370,00
906030	-	IVECO	Varie	120	10			2,65
906031	-	IVECO	Varie	120	10			2,65
906032	-	IVECO	Varie	120	10			2,70
906033	-	IVECO	Varie	120	10			2,70
906034	-	IVECO	Varie	120	10			2,80
906035	-	IVECO	Varie	120	10			2,99
906036	-	IVECO	Varie	120	10			3,30
906037	-	IVECO	Varie	120	10			3,50

Copyright della EMMERRE S.r.l. - Settimo Torinese - Tutti i diritti sono riservati e depositati a norma di legge ed a norma delle convenzioni internazionali. - E' vietata la duplicazione o la riproduzione anche parziale senza la previa autorizzazione della EMMERRE S.r.l.

LISTINO PREZZI IN PROGRESSIONE RIFERIMENTI EMMERRE
PRICE LIST IN ORDER OF EMMERRE REFERENCE

	Rif. Originale Original Ref.	Adattabile a: Adaptable to:	Tipo Cat. Cat. Type	Pagina Page	Qtà/Conf. Q.ty/Pck.	OE	Cat. D	Listino Price L. €
906038	-	IVECO	Varie	120	10			3,90
906039	-	IVECO	Varie	120	10			4,40
906040	-	IVECO	Varie	120	10			4,60
906041	-	IVECO	Varie	120	10			4,80
906042	-	IVECO	Varie	120	10			4,80
906043	-	IVECO	Varie	120	10			4,90
906044	-	IVECO	Varie	120	10			5,00
906045	-	IVECO	Varie	120	10			5,00
906046	-	IVECO	Varie	120	10			5,10
906047	-	IVECO	Varie	120	10			5,20
906048	-	IVECO	Varie	120	10			6,00
906050	500310147	IVECO	Varie	69	2			18,00
906051	4171667	IVECO	Varie	70	2			8,70
906052	4837951	IVECO	Varie	69	2			23,00
906053	4151564	IVECO	Varie	68	2			7,75
906054	4151891	IVECO	Varie	68	1			3,50
906055	4834987	IVECO	Varie	70	1			100,00
906059	99457634	IVECO	Varie	214	1	OE	D	89,00
906060	4862328	IVECO	Varie	72	1			48,00
906061	4851417	IVECO	Varie	72	1			43,00
906062	99468264	IVECO	Varie	72	1			55,00
906063	4838244	IVECO	Varie	214	1			125,00
906064	500304249	IVECO	Varie	72	1			20,50
906065	500325434	IVECO	Varie	214	1		D	220,00
906066	99484737	IVECO	Varie	214	1			135,00
906101	4745193	IVECO	Varie	71	1			45,00
906102	4741945	IVECO	Varie	71	1			45,00
906108	-	IVECO	Varie	48	1			125,00
906110	7301484	IVECO	Varie	46	1			20,00
906115	4624515	IVECO	Varie	47	1			42,00
906116	500302200	IVECO	Varie	47	1		D	12,50
906117	93827837	IVECO	Varie	46	1			75,00
906120	4769877	IVECO	Varie	47	1			30,00
906123	99499169	IVECO	Varie	81	1			450,00
906124	99450703	IVECO	Varie	81	1			450,00
906129	99431084	IVECO	Varie	80	1			528,00
906190	93902290	IVECO	Acqua	69	1	OE	D	32,00
906191	42107120	IVECO	Acqua	69	1	OE	D	195,00
906192	41215631	IVECO	Acqua	69	1	OE	D	182,00
906200	4856030	IVECO	Varie	63	1			10,00
906202	500320913	IVECO	Varie	63	1			22,80
906203	98444203	IVECO	Varie	64	1			42,00
906204	98449548	IVECO	Varie	64	1			45,00
906206	4837950	IVECO	Varie	62	1			19,80
906207	99452677	IVECO	Varie	63	1			17,50
906208	9984319	IVECO	Varie	63	1			15,00
906209	98444205	IVECO	Varie	64	1			42,00
906210	98462385	IVECO	Varie	64	1			40,00
906211	98449549	IVECO	Varie	64	1			38,00
906212	98449552	IVECO	Varie	64	1			42,00
906213	99445841	IVECO	Varie	64	1			38,50
906214	500315209	IVECO	Varie	65	1			39,50
906215	41200636	IVECO	Varie	65	1			28,00
906216	41200637	IVECO	Varie	65	1			27,50
906217	500353028	IVECO	Varie	65	1			34,00
906218	98444201	IVECO	Varie	65	1			37,00

LISTINO PREZZI IN PROGRESSIONE RIFERIMENTI **EMMERRE**
PRICE LIST IN ORDER OF **EMMERRE** **REFERENCE**

EMMERRE	Rif.Originale Original Ref.	Adattabile a: Adaptable to:	Tipo Cat. Cat. Type	Pagina Page	Qtà/Conf. Q.ty/Pck.	OE	Cat. D	Listino Price L. €
906219	41200709	IVECO	Varie	65	1			29,00
906220	98449547	IVECO	Varie	67	1			70,00
906221	98449550	IVECO	Varie	67	1			82,00
906222	4846676	IVECO	Varie	63	1			15,80
906223	4857248	IVECO	Varie	71	1			18,00
906224	500339377	IVECO	Varie	67	1			58,00
906225	99460557	IVECO	Varie	69	1		D	8,00
906226	98435734	IVECO	Varie	69	1			23,00
906227	41200710	IVECO	Varie	66	1			25,00
906228	98444199	IVECO	Varie	66	1			49,00
906229	98469129	IVECO	Varie	67	1			6,80
906230	98442879	IVECO	Varie	67	1			8,20
906231	4825110	IVECO	Varie	70	1			94,00
906232	4647981	IVECO	Varie	48	1			100,00
906233	4746856	IVECO	Varie	69	1			18,00
906234	500388626	IVECO	Varie	63	1			26,00
906235	42047142	IVECO	Varie	70	1			45,00
906236	4859914	IVECO	Varie	68	1			11,00
906237	4840434	IVECO	Varie	70	1			18,40
906238	4746909	IVECO	Varie	68	1			19,00
906239	4746907	IVECO	Varie	67	1			20,00
906240	4736265	IVECO	Varie	48	1			56,00
906241	99469897	IVECO	Varie	71	1		D	120,00
906241	504084761	IVECO	Varie	71	1		D	120,00
906242	98453557	IVECO	Varie	70	1			52,00
906243	99450704	IVECO	Varie	80	1			450,00
906244	99431083	IVECO	Varie	80	1			528,00
906245	99441839	IVECO	Varie	47	1			35,00
906878	93930676	IVECO	Acqua	68	1		D	49,00
906901	500302656	IVECO	Varie	209	1			34,00
906904	99456723	IVECO	Varie	209	1			10,00
906907	99487905	IVECO	Acqua	67	1		D	180,00
906908	93930693	IVECO	Acqua	68	1			325,00
906909	93930687	IVECO	Acqua	68	1			150,00
906919	2993923	IVECO	Varie	209	1		D	21,00
906920	42530250	IVECO	Acqua	68	1		D	9,50
906921	2993924	IVECO	Varie	209	1		D	20,50
906922	2993920	IVECO	Varie	209	1		D	20,00
906924	504152996	IVECO	Acqua	67	1		D	200,00
906925	504045487	IVECO	Acqua	66	1		D	155,00
906926	1907918	IVECO	Acqua	65	1			199,00
906927	93813747	IVECO	Acqua	66	1			280,00
906928	500396428	IVECO	Acqua	66	1			235,00
906929	93818439	IVECO	Acqua	65	1			210,00
906930	93817393	IVECO	Acqua	65	1			188,00
906931	93809190	IVECO	Acqua	65	1			15,00
906932	500396429	IVECO	Acqua	66	1			235,00
906933	504084141	IVECO	Acqua	67	1		D	160,00
906934	504008108	IVECO	Acqua	67	1		D	135,00
907019	-	IVECO	Acqua	75	2			7,00
907020	-	IVECO	Acqua	75	2			7,00
907021	-	IVECO	Acqua	79	2			25,00
907022	-	IVECO	Acqua	78	2			24,00
907023	-	IVECO	Acqua	77	2			24,00
907030	-	IVECO	Acqua	73	1			14,00
907031	-	IVECO	Acqua	73	1			21,00

LISTINO PREZZI IN PROGRESSIONE RIFERIMENTI EMMERRE
PRICE LIST IN ORDER OF EMMERRE REFERENCE

	Rif.Originale Original Ref.	Adattabile a: Adaptable to:	Tipo Cat. Cat. Type	Pagina Page	Qtà/Conf. Q.ty/Pck.	OE	Cat. D	Listino Price L. €
907032	98410628	IVECO	Acqua	81	1			25,00
907033	7302947	IVECO	Acqua	81	1			25,00
907034	-	IVECO	Acqua	76	2			3,10
907035	99443808	IVECO	Acqua	76	1			1,40
907038	-	IVECO	Acqua	78	2			4,00
907039	-	IVECO	Acqua	77	2			3,50
907041	98451994	IVECO	Acqua	84	1			28,00
907042	98434054	IVECO	Acqua	82	1			12,00
907043	4713436	IVECO	Acqua	84	1			52,00
907048	93805975	IVECO	Acqua	81	1			35,00
907052	4671034	IVECO	Acqua	85	1			22,50
907053	4615459	IVECO	Acqua	83	1			15,00
907054	500326396	IVECO	Acqua	80	1			49,00
907055	4837163	IVECO	Acqua	80	1			38,00
907056	4615461	IVECO	Acqua	83	1			8,50
907057	8827468	IVECO	Acqua	83	1			20,00
907058	8826137	IVECO	Acqua	83	1			28,00
907059	99443658	IVECO	Acqua	80	1			30,00
907060	98467958	IVECO	Acqua	81	1			24,00
907062	99482735	IVECO	Acqua	80	1			13,50
907063	99457054	IVECO	Acqua	82	1			26,00
907064	4674672	IVECO	Acqua	82	1			51,00
907067	4675739	IVECO	Acqua	84	1			24,00
907071	4644373	IVECO	Varie	73	1			32,00
907074	4649176	IVECO	Varie	73	1			27,00
907078	4640382	IVECO	Acqua	84	1			14,00
907081	98450713	IVECO	Acqua	85	1			31,00
907082	4717885	IVECO	Varie	73	1			22,50
907083	4622832	IVECO	Acqua	84	1			198,00
907090	51.06500.6515	MAN	Acqua	26	1			285,00
907091	-	IVECO	Acqua	75	2			2,80
907092	-	IVECO	Acqua	75	2			2,80
907093	-	IVECO	Acqua	79	2			4,00
907096	4774405	IVECO	Acqua	79	1			3,00
907097	4673807	IVECO	Acqua	77	1			2,10
907098	4772057	IVECO	Acqua	78	1			2,90
907100	4809019	IVECO	Acqua	71	1			18,00
907101	9073710	IVECO	Acqua	70	1			61,00
907104	98463638	IVECO	Acqua	71	4			18,00
907106	51.06500.6612	MAN	Acqua	27	1			415,00
907107	51.06500.6537	MAN	Acqua	27	1			275,00
907108	51.06500.6492	MAN	Acqua	26	1			300,00
907109	8170305	VOLVO	Acqua	45	1			350,00
907111	-	DAF	Acqua	72	1			13,00
907112	422.200.1001	MERCEDES	Acqua	35	1			220,00
907113	-	FORD	Acqua	72	1			13,50
907114	-	VOLKSWAGEN	Acqua	72	1			13,50
907115	-	VOLKSWAGEN	Acqua	72	1			13,50
907119	-	RENAULT	Acqua	72	1			13,50
907120	3183908	VOLVO	Acqua	44	1			330,00
907122	907122	MAN	Acqua	72	1			13,50
907124	51.06500.6479	MAN	Acqua	28	1			248,00
907126	98463637	IVECO	Acqua	71	1			14,50
907127	51.06500.6282	MAN	Acqua	28	1			190,00
907130	907130	IVECO	Acqua	70	1			9,00
907134	51.06500.6476	MAN	Acqua	26	1			280,00

LISTINO PREZZI IN PROGRESSIONE RIFERIMENTI 
PRICE LIST IN ORDER OF  **REFERENCE**

	Rif.Originale Original Ref.	Adattabile a: Adaptable to:	Tipo Cat. Cat. Type	Pagina Page	Qtà/Conf. Q.ty/Pck.	OE	Cat. D	Listino Price L. €
907136	5422002001	MERCEDES	Acqua	30	1			230,00
907137	51.06500.6495	MAN	Acqua	27	1			285,00
907138	99483937	IVECO	Acqua	17	1			200,00
907139	500356553	IVECO	Acqua	17	1			210,00
907140	504033770	IVECO	Acqua	6	1			140,00
907141	51.06500.6546	MAN	Acqua	24	1			255,00
907143	51.06500.7066	MAN	Acqua	28	1			740,00
907144	1549482	SCANIA	Acqua	41	1			385,00
907145	2101069T02	NISSAN	Acqua	38	1			118,00
907146	51.06500.6547	MAN	Acqua	25	1			276,00
907147	2995627	IVECO	Acqua	4	1			60,00
907149	93191101	IVECO	Acqua	7	1			87,00
907150	98497115	IVECO	Acqua	10	1			195,00
907151	4813370	IVECO	Acqua	9	1			110,00
907152	4606023	IVECO	Acqua	10	1			255,00
907153	98468830	IVECO	Acqua	13	1			250,00
907154	4764156	IVECO	Acqua	12	1			270,00
907155	500300470	IVECO	Acqua	12	1			312,00
907156	1353072	SCANIA	Acqua	43	1			220,00
907157	4538058	IVECO	Acqua	11	1			180,00
907158	98415831	IVECO	Acqua	14	1			228,00
907159	1365841	SCANIA	Acqua	43	1			220,00
907161	8829154	IVECO	Acqua	9	1			155,00
907162	8829770	IVECO	Acqua	7	1			155,00
907163	4796535	IVECO	Acqua	7	1			225,00
907166	4838676	IVECO	Acqua	14	1			168,00
907167	98497117	IVECO	Acqua	10	1			105,00
907169	99440728	IVECO	Acqua	4	1			70,00
907170	2995629	IVECO	Acqua	4	1			67,00
907172	4752137	IVECO	Acqua	11	1			340,00
907174	504087367	IVECO	Acqua	6	1			110,00
907179	42530033	IVECO	Acqua	14	1			149,00
907180	42530032	IVECO	Acqua	13	1			165,00
907181	98439476	IVECO	Acqua	15	1		D	215,00
907182	500350798	IVECO	Acqua	16	1			165,00
907183	42535615	IVECO	Acqua	15	1			165,00
907184	500350785	IVECO	Acqua	17-21	1			165,00
907185	500362859	IVECO	Acqua	5	1			80,00
907186	500361919	IVECO	Acqua	5	1			80,00
907187	93191103	IVECO	Acqua	9	1			100,00
907188	4710552	IVECO	Acqua	11	1			273,00
907189	93190288	IVECO	Acqua	12	1			160,00
907190	61318939	IVECO	Acqua	16	1			272,00
907191	98447661	IVECO	Acqua	16	1			340,00
907192	422.200.11.01	MERCEDES	Acqua	34	1			205,00
907193	500362834	IVECO	Acqua	5	1			88,00
907194	98468832	IVECO	Acqua	13	1			295,00
907196	353.200.36.01	MERCEDES	Acqua	32	1			180,00
907197	364.200.20.01	MERCEDES	Acqua	33	1			168,00
907198	1375839	SCANIA	Acqua	42	1			310,00
907199	1545.261	VOLVO	Acqua	44	1			380,00
907200	51.06500.6426	MAN	Acqua	24	1			250,00
907201	51.06500.6228	MAN	Acqua	25	1			250,00
907202	403.200.71.01	MERCEDES	Acqua	31	1			192,00
907203	353.200.56.01	MERCEDES	Acqua	32	1			175,00
907204	353.200.37.01	MERCEDES	Acqua	32	1			170,00

Copyright della EMMERRE S.r.l. - Settimo Torinese - Tutti i diritti sono riservati e depositati a norma di legge ed a norma delle convenzioni internazionali. - E' vietata la duplicazione o la riproduzione anche parziale senza la previa autorizzazione della EMMERRE S.r.l.

LISTINO PREZZI IN PROGRESSIONE RIFERIMENTI EMMERRE
PRICE LIST IN ORDER OF EMMERRE REFERENCE

	Rif. Originale Original Ref.	Adattabile a: Adaptable to:	Tipo Cat. Cat. Type	Pagina Page	Qtà/Conf. Q.ty/Pck.	OE	Cat. D	Listino Price L. €
907205	366.200.59.01	MERCEDES	Acqua	33	1			200,00
907206	403.200.70.01	MERCEDES	Acqua	34	1			220,00
907207	403.200.73.01	MERCEDES	Acqua	33	1			225,00
907208	422.200.12.01	MERCEDES	Acqua	35	1			270,00
907209	1314406	SCANIA	Acqua	41	1			215,00
907210	320592	SCANIA	Acqua	41	1			275,00
907211	382183	SCANIA	Acqua	42	1			295,00
907212	4629725	IVECO	Acqua	55	1			50,00
907213	4713940	IVECO	Acqua	51	1			18,00
907214	8586706	IVECO	Acqua	51	1			15,00
907215	4595546	IVECO	Acqua	53	1			15,00
907216	8033778	IVECO	Acqua	53	1			33,00
907218	4698188	IVECO	Acqua	54	1			48,00
907220	93813264	IVECO	Acqua	51	1			10,00
907222	8831375	IVECO	Acqua	53	1			40,00
907223	4842341	IVECO	Acqua	53	1			50,00
907224	4782877	IVECO	Acqua	54	1			60,00
907225	504154349	IVECO	Acqua	52	1			25,00
907226	4800475	IVECO	Acqua	54	1			50,00
907227	4800473	IVECO	Acqua	53	1			40,00
907228	93811590	IVECO	Acqua	51	1			35,00
907229	500300559	IVECO	Acqua	55	1			54,00
907230	98468151	IVECO	Acqua	54	1			94,00
907231	500353523	IVECO	Acqua	54	1		D	78,00
907232	1448197	DAF	Acqua	49	1			150,00
907233	4601938	IVECO	Acqua	74	1		D	3,50
907234	4669837	IVECO	Acqua	74	1			7,00
907235	504024647	IVECO	Acqua	52	1			27,00
907236	4626879	IVECO	Acqua	74	1			36,00
907238	4670703	IVECO	Acqua	74	1			34,00
907239	4620273	IVECO	Acqua	74	1			44,00
907240	1338736	DAF	Acqua	49	1			150,00
907241	98431829	IVECO	Acqua	74	1		D	36,00
907242	4677550	IVECO	Acqua	74	1			65,00
907243	504113544	IVECO	Acqua	6	1			105,00
907245	4670702	IVECO	Acqua	74	1			34,00
907246	500345688	IVECO	Acqua	73	1			19,50
907247	500345691	IVECO	Acqua	73	1			12,00
907248	4697838	IVECO	Acqua	70	1			6,80
907249	1315854	DAF	Acqua	49	1			110,00
907250	4627601	IVECO	Acqua	71	1			25,00
907251	4605519	IVECO	Acqua	70	1			11,00
907252	4626878	IVECO	Acqua	70	1			14,50
907253	4772996	IVECO	Acqua	71	1			13,50
907254	7301254	IVECO	Acqua	70	1			9,50
907255	9042004901	MERCEDES	Acqua	29	1			240,00
907256	99450016	IVECO	Acqua	55	1			220,00
907257	4804320	IVECO	Acqua	71	1			23,50
907258	98434833	IVECO	Acqua	74	1			30,00
907259	5412001201	MERCEDES	Acqua	29	1		D	225,00
907260	505347	DAF	Acqua	49	1			66,00
907261	655158	DAF	Acqua	49	1			79,00
907262	715F8600	FORD	Acqua	50	1			20,00
907263	20431484	VOLVO	Acqua	45	1			330,00
907264	84VB8600	FORD	Acqua	50	1			28,00
907265	51066010172	MAN	Acqua	56	1			95,00

LISTINO PREZZI IN PROGRESSIONE RIFERIMENTI **EMMERRE**
PRICE LIST IN ORDER OF **EMMERRE** **REFERENCE**

EMMERRE	Rif.Originale Original Ref.	Adattabile a: Adaptable to:	Tipo Cat. Cat. Type	Pagina Page	Qtà/Conf. Q.ty/Pck.	OE	Cat. D	Listino Price L. €
907266	51066010200	MAN	Acqua	56	1			80,00
907267	51066010107	MAN	Acqua	56	1			80,00
907268	51066010102	MAN	Acqua	56	1			80,00
907269	51006010256	MAN	Acqua	57	1			180,00
907270	0032050306	MERCEDES	Acqua	58	1			35,00
907271	0032051306	MERCEDES	Acqua	58	1			45,00
907272	0032050006	MERCEDES	Acqua	58	1			120,00
907273	0032050106	MERCEDES	Acqua	58	1			205,00
907275	9042050406	MERCEDES	Acqua	59	1			140,00
907276	0032053606	MERCEDES	Acqua	59	1			165,00
907277	87480660	MERCEDES	Acqua	59	1			190,00
907278	0032054206	MERCEDES	Acqua	59	1			195,00
907290	5422001901	MERCEDES	Acqua	30	1		D	205,00
907299	504062854	IVECO	Acqua	15	1		D	100,00
907315	4032007101	MERCEDES	Acqua	37	1			192,00
907333	4032007601	MERCEDES	Acqua	37	1			210,00
907336	4412000201	MERCEDES	Acqua	36	1		D	138,00
907342	4572000501	MERCEDES	Acqua	36	1			225,00
907351	9062006101	MERCEDES	Acqua	36	1			335,00
907352	259.065	SCANIA	Acqua	42	1			235,00
907353	51066010275	MAN	Acqua	57	1			175,00
907354	1412398	SCANIA	Acqua	60	1			150,00
907355	1393424	SCANIA	Acqua	60	1			150,00
907356	1422502	SCANIA	Acqua	60	1			150,00
907357	1674865	VOLVO	Acqua	61	1			140,00
907358	5001857427	RENAULT	Acqua	40	1			330,00
907359	1778280	DAF	Acqua	3	1			485,00
907360	683338	DAF	Acqua	3	1			595,00
907361	5010323187	RENAULT	Acqua	40	1			195,00
907362	5010248921	RENAULT	Acqua	40	1			195,00
907363	8829787	IVECO	Acqua	8	1		D	185,00
907364	0683225	DAF	Acqua	3	1			300,00
907364	0683586	DAF	Acqua	3	1			300,00
907364	1609871	DAF	Acqua	3	1			300,00
907365	7701468342	RENAULT	Acqua	39	1			70,00
908000	4725884	IVECO	Varie	132	1			135,00
908001	2994035	IVECO	Varie	133	1			148,00
908001	2995703	IVECO	Varie	133	1			148,00
908003	2992630	IVECO	Varie	133	1			220,00
908007	5001830936	RENAULT	Varie	135	1			500,00
908008	2994026	IVECO	Varie	134	1			250,00
908009	2994028	IVECO	Varie	134	1			220,00
908010	42061921	IVECO	Varie	140	1			175,00
908011	42062095	IVECO	Varie	140	1			220,00
908012	8193332	SCANIA	Varie	143	1		D	550,00
908013	500305439	IVECO	Varie	140	1			190,00
908020	93162071	IVECO	Varie	135	1			20,00
908026	93162073	IVECO	Varie	135	1			22,50
908036	93161953	IVECO	Varie	134	1			42,00
908042	8588954	IVECO	Varie	136	1			50,00
908050	1905282	IVECO	Varie	140	1			190,00
908051	4614120	IVECO	Varie	137	1			24,00
908052	4675390	IVECO	Varie	139	1			40,00
908053	4675388	IVECO	Varie	139	1			38,00
908054	1905136	IVECO	Varie	138	1			22,00
908055	8587214	IVECO	Varie	137	1			40,00

LISTINO PREZZI IN PROGRESSIONE RIFERIMENTI EMMERRE
PRICE LIST IN ORDER OF EMMERRE REFERENCE

	Rif.Originale Original Ref.	Adattabile a: Adaptable to:	Tipo Cat. Cat. Type	Pagina Page	Qtà/Conf. Q.ty/Pck.	OE	Cat. D	Listino Price L. €
908057	8588952	IVECO	Varie	136	1			120,00
908058	2992027	IVECO	Varie	136	1			32,00
908060	4769156	IVECO	Varie	138	1			150,00
908061	1905318	IVECO	Varie	136	1			38,40
908062	4605181	IVECO	Varie	137	1			36,00
908063	8582291	IVECO	Varie	137	1			41,50
908065	4605262	IVECO	Varie	137	1			40,00
908066	8564269	IVECO	Varie	138	1			51,00
908068	908068	IVECO	Varie	139	1			80,00
908069	42063184	IVECO	Varie	139	1			78,00
908069	3151007303	DAF	Varie	139	1			78,00
908069	3151007303	SCANIA	Varie	139	1			78,00
908069	813055000035	MAN	Varie	139	1			78,00
908070	1905469	IVECO	Varie	141	1			150,00
908071	1905470	IVECO	Varie	141	1			130,00
908074	8585082	IVECO	Varie	136	1			90,00
908075	4787273	IVECO	Varie	138	1			100,00
908078	4727742	IVECO	Varie	141	1			135,00
908090	500335068	IVECO	Varie	142	1			190,00
908090	5010452822	RENAULT	Varie	142	1			190,00
908090	81305500097	MAN	Varie	142	1			190,00
908099	4605177	IVECO	Varie	132	1			48,00
908100	1908648	IVECO	Varie	130	1			38,00
908101	4702081	IVECO	Varie	131	1			71,00
908103	8586051	IVECO	Varie	130	1			50,00
908106	4605265	IVECO	Varie	131	1			54,00
908107	4773745	IVECO	Varie	131	1			68,00
908109	4746189	IVECO	Varie	131	1			78,00
908111	42003011	IVECO	Varie	131	1			75,00
908113	4605179	IVECO	Varie	130	1			39,00
908114	42115302	IVECO	Varie	131	1			67,00
908115	8566391	IVECO	Varie	130	1			54,00
908117	8586388	IVECO	Varie	130	1			45,00
908118	4787275	IVECO	Varie	138	1			110,00
908131	42116734	IVECO	Varie	130	1			69,50
908141	4459817	IVECO	Varie	132	1			2,00
908174	93801671	IVECO	Varie	129	1			14,00
908175	93807122	IVECO	Varie	129	1			15,00
908177	4739513	IVECO	Varie	132	1			114,00
908179	4708356	IVECO	Varie	132	1			71,00
908180	93807553	IVECO	Sterzo	116	1			750,00
908181	93824293	IVECO	Sterzo	116	1			750,00
908182	-	IVECO	Sterzo	117	1			65,00
908183	-	IVECO	Sterzo	117	1			130,00
908366	4752909	IVECO	Varie	132	2			0,40
908370	2995814	IVECO	Varie	133	1		D	340,00
908423	93807385	IVECO	Varie	129	2			3,80
908424	93807414	IVECO	Varie	129	2		D	1,60
908425	93800317	IVECO	Varie	129	2			3,90
908428	4593876	IVECO	Varie	129	2			14,00
908799	42063311	IVECO	Freno	416	1			62,00
908800	42100180	IVECO	Freno	416	1			88,50
908803	4219866	IVECO	Freno	419	1			45,00
908804	4657683	IVECO	Freno	419	1			50,00
908807	4853408	IVECO	Freno	420	1			50,00
908808	4854828	IVECO	Freno	417	1			50,00

LISTINO PREZZI IN PROGRESSIONE RIFERIMENTI 
PRICE LIST IN ORDER OF  **REFERENCE**

	Rif.Originale Original Ref.	Adattabile a: Adaptable to:	Tipo Cat. Cat. Type	Pagina Page	Qtà/Conf. Q.ty/Pck.	OE	Cat. D	Listino Price L. €
908809	4292543	IVECO	Freno	418	1			45,00
908810	4726714	IVECO	Freno	421	1			85,00
908811	4853409	IVECO	Freno	416	1			55,00
908812	4797845	IVECO	Freno	418	1			26,00
908813	41211005	IVECO	Freno	421	1		D	140,00
908815	4800161	IVECO	Freno	418	1			35,00
908820	4774874	IVECO	Freno	419	1			45,00
908823	41211006	IVECO	Freno	421	1			145,00
908902	4311345	IVECO	Freno	416	1			19,00
908903	4191164	IVECO	Freno	416	1			17,00
908905	4271838	IVECO	Freno	417	1			31,00
908906	4271840	IVECO	Freno	416	1			41,00
908910	4848576	IVECO	Freno	417	1			21,00
908911	4777521	IVECO	Freno	417	1			45,00
910104	4639203	IVECO	Varie	145	1			10,50
910106	4647688	IVECO	Varie	145	1			10,50
910113	4663102	IVECO	Varie	145	1			60,00
911045	8857922	IVECO	Varie	153	2			20,00
911048	8576824	IVECO	Varie	148	1			15,00
911049	4541695	IVECO	Varie	153	2			30,00
911050	8132189	IVECO	Varie	156	1			150,00
913000	98420643	IVECO	Varie	46	1			100,00
913003	8859927	IVECO	Varie	149	1			88,00
913004	8858515	IVECO	Varie	145	1			55,00
913005	7182665	IVECO	Varie	168	1			36,00
913006	99465843	IVECO	Varie	149	1			60,00
913010	41271992	IVECO	Varie	150	1			95,00
913018	41271991	IVECO	Varie	150	1			95,00
913019	41226954	IVECO	Varie	150	1			85,00
913037	4611922	IVECO	Varie	148	1			19,00
913042	4784426	IVECO	Varie	148	1			5,90
913043	990738	IVECO	Varie	148	1			6,00
913211	4683737	IVECO	Varie	158	1			79,00
913213	4725393	IVECO	Varie	158	1			75,00
913215	4698044	IVECO	Varie	157	1			80,00
913410	4611917	IVECO	Varie	148	1			2,50
913411	4611918	IVECO	Varie	148	1			2,50
913519	500322689	IVECO	Varie	154	2			42,50
913520	41013876	IVECO	Varie	155	1			14,00
913552	4611915	IVECO	Varie	148	1			34,00
913557	4642345	IVECO	Varie	148	1			37,00
913644	38555888	IVECO	Varie	152	2			4,00
913700	-	IVECO	Varie	145	1			185,00
913701	-	IVECO	Varie	145	1			185,00
913703	-	IVECO	Varie	145	1			185,00
913707	-	IVECO	Varie	145	1			200,00
913712	-	IVECO	Varie	145	1			200,00
913714	-	IVECO	Varie	146	1			100,00
913715	-	IVECO	Varie	146	1			135,00
913716	41210621	IVECO	Varie	150	1			78,00
913717	-	IVECO	Varie	147	1			137,00
913718	-	IVECO	Varie	147	1			95,00
913719	-	IVECO	Varie	147	1			95,00
913720	-	IVECO	Varie	147	1			120,00
913721	-	IVECO	Varie	147	1			160,00
913722	4840325	IVECO	Varie	149	1			125,00

Copyright della EMMERRE S.r.l. - Settimo Torinese - Tutti i diritti sono riservati e depositati a norma di legge ed a norma delle convenzioni internazionali. - E' vietata la duplicazione o la riproduzione anche parziale senza la previa autorizzazione della EMMERRE S.r.l.

LISTINO PREZZI IN PROGRESSIONE RIFERIMENTI EMMERRE
PRICE LIST IN ORDER OF EMMERRE REFERENCE

	Rif.Originale Original Ref.	Adattabile a: Adaptable to:	Tipo Cat. Cat. Type	Pagina Page	Qtà/Conf. Q.ty/Pck.	OE	Cat. D	Listino Price L. €
913723	8139205	IVECO	Varie	150	1			82,00
913724	1907909	IVECO	Varie	146	1			25,00
913726	-	IVECO	Varie	155	1			40,00
913727	-	IVECO	Varie	155	1			42,00
913728	41001729	IVECO	Varie	149	1			82,00
913729	41001730	IVECO	Varie	149	1			82,00
913731	41210795	IVECO	Varie	157	1			20,00
913732	8131641	IVECO	Varie	156	1			45,00
913733	42108656	IVECO	Varie	151	1			45,00
913734	93159298	IVECO	Varie	151	1			225,00
913734	81521706128	MAN	Varie	151	1			225,00
913734	0012606757	MERCEDES	Varie	151	1			225,00
913736	42040672	IVECO	Varie	152	1			49,00
913737	9983325	IVECO	Varie	152	1			28,00
913738	4834271	IVECO	Varie	157	1		D	28,00
913739	2992593	IVECO	Varie	152	1			35,00
913740	42532977	IVECO	Varie	152	1			35,00
913750	504040961	IVECO	Varie	146	1			24,00
913751	504040962	IVECO	Varie	146	1		D	28,00
913801	-	IVECO	Varie	153	1			72,00
913803	-	IVECO	Varie	153	1			90,00
913804	-	IVECO	Varie	153	1			49,00
913805	-	IVECO	Varie	153	1			29,00
913806	-	IVECO	Varie	153	1			50,00
913807	-	IVECO	Varie	153	1			50,00
913808	-	IVECO	Varie	153	1			25,00
913809	-	IVECO	Varie	153	1			52,00
913923	8556739	IVECO	Varie	164	1			30,00
914203	-	IVECO	Varie	146	1			20,00
914219	38555769	IVECO	Varie	154	1			8,50
914220	8575077	IVECO	Varie	146	2			1,60
914221	41218482	IVECO	Sterzo	105	2			10,00
914222	8550139	IVECO	Sterzo	103	2			10,00
914223	8564527	IVECO	Sterzo	103	2			12,50
914224	8558220	IVECO	Sterzo	103	2			10,00
914225	4634735	IVECO	Varie	158	1			60,00
914226	8564607	IVECO	Varie	158	2			30,00
914227	4607716	IVECO	Varie	158	1			58,00
914230	0009966645	MERCEDES	Varie	163	1			15,00
914231	0009966745	MERCEDES	Varie	163	1			15,00
914232	0009966845	MERCEDES	Varie	163	1			15,00
914233	5000673571	IVECO	Varie	151	1			124,00
914234	8578493	IVECO	Sterzo	104	2			12,50
914235	8582313	IVECO	Sterzo	104	2			12,00
914237	8578492	IVECO	Sterzo	103	2			12,50
914238	41011049	IVECO	Varie	154	1			2,00
914240	41005523	IVECO	Sterzo	106	2			29,00
914245	42487482	IVECO	Sterzo	104	2			16,00
914246	350270	SCANIA	Sterzo	106	2			15,00
914247	8188188	IVECO	Sterzo	106	2			8,00
914248	8188187	IVECO	Sterzo	106	2			8,00
914250	8121825	IVECO	Varie	151	2			29,80
914254	60700015000	GASOLONE	Sterzo	107	2			32,00
914255	60700014000	GASOLONE	Sterzo	107	2			32,00
914286	42079838	IVECO	Sterzo	105	2			8,00
914287	42079837	IVECO	Sterzo	104	2			8,00

LISTINO PREZZI IN PROGRESSIONE RIFERIMENTI **EMMERRE**
PRICE LIST IN ORDER OF **EMMERRE** **REFERENCE**

EMMERRE	Rif.Originale Original Ref.	Adattabile a: Adaptable to:	Tipo Cat. Cat. Type	Pagina Page	Qtà/Conf. Q.ty/Pck.	OE	Cat. D	Listino Price L. €
914288	41203864	IVECO	Sterzo	105	2			7,50
914289	41203863	IVECO	Sterzo	105	2			7,50
914292	1383405	SCANIA	Sterzo	107	2			28,00
914294	1527234	VOLVO	Sterzo	107	2			29,00
923104	93190028	IVECO	Varie	180	1			60,00
924999	7180038	IVECO	Varie	168	1			198,00
925000	7170959	IVECO	Varie	167	1			980,00
925001	7180037	IVECO	Varie	167	1			720,00
925002	99455219	IVECO	Varie	167	1			490,00
925003	42538366	IVECO	Varie	171	1			45,00
925004	42536963	IVECO	Varie	174	1			125,00
925005	42538367	IVECO	Varie	171	1			45,00
925006	42541440	IVECO	Varie	172	1			33,00
925007	42541438	IVECO	Varie	172	1		D	50,00
925008	42536525	IVECO	Varie	173	1			95,00
925009	8194600	IVECO	Varie	171	1			35,00
925009	42536524	IVECO	Varie	171	1			35,00
925010	4765836	IVECO	Varie	172	1			35,00
925011	42536961	IVECO	Varie	173	1			95,00
925013	93156460	IVECO	Varie	170	1			35,00
925014	42536962	IVECO	Varie	173	1			145,00
925015	8171366	VOLVO	Varie	176	1			70,00
925016	42087542	IVECO	Varie	173	1			90,00
925017	42536523	IVECO	Varie	170	1			28,50
925019	42541021	IVECO	Varie	169	1			20,00
925020	42536526	IVECO	Varie	169	1			20,00
925021	42536965	IVECO	Varie	170	1			25,00
925023	93158202	IVECO	Varie	169	1			30,00
925024	42530546	IVECO	Varie	169	1			35,00
925025	93194978	IVECO	Varie	171	1			70,00
925026	93192009	IVECO	Varie	172	1			175,00
925027	42538439	IVECO	Varie	170	1			35,00
925028	42541437	IVECO	Varie	174	1			105,00
925029	93192572	IVECO	Varie	174	1			105,00
925030	42535254	IVECO	Varie	170	1			35,00
925031	42536726	IVECO	Varie	169	1			33,00
925032	93158251	IVECO	Varie	171	1			45,00
925033	973410022	MERCEDES	Varie	175	1			110,00
925034	655410022	MERCEDES	Varie	175	1			120,00
925035	42538361	IVECO	Varie	174	1		D	70,00
925036	81394106019	MAN	Varie	175	1			70,00
925037	6014102110	MERCEDES	Varie	175	1			52,00
925038	99455579	IVECO	Varie	168	1			200,00
925039	42536078	IVECO	Varie	172	1		D	100,00
925040	6564110012	MERCEDES	Varie	176	1			100,00
926002	1696389	VOLVO	Varie	176	1			83,00
931000	42470845	IVECO	Freno	258	1			125,00
931001	93824580	IVECO	Freno	259	1			175,00
931002	42470834	IVECO	Freno	259	1			155,00
931003	93804574	IVECO	Freno	259	1			50,00
931004	93824579	IVECO	Freno	258	1			130,00
931005	93813627	IVECO	Freno	256	1			145,00
931006	93813628	IVECO	Freno	257	1			160,00
931007	7169265	IVECO	Freno	260	1			55,00
931008	7180049	IVECO	Freno	260	1			65,00
931009	26800140	IVECO	Freno	256	1			20,00

LISTINO PREZZI IN PROGRESSIONE RIFERIMENTI EMMERRE
PRICE LIST IN ORDER OF EMMERRE REFERENCE

	Rif.Originale Original Ref.	Adattabile a: Adaptable to:	Tipo Cat. Cat. Type	Pagina Page	Qtà/Conf. Q.ty/Pck.	OE	Cat. D	Listino Price L. €
931010	26800330	IVECO	Freno	256	1			13,00
931011	8582739	IVECO	Freno	257	1			26,50
931012	8582740	IVECO	Freno	257	1			25,00
931013	98430602	IVECO	Freno	259	1			45,00
931014	7180066	IVECO	Freno	260	1			90,00
931015	BTH1024C	IVECO	Freno	258	1			60,00
931016	500349833	IVECO	Freno	262	1			175,00
931017	7181957	IVECO	Freno	261	1			175,00
931018	1905220	IVECO	Freno	261	1			75,00
931019	42471216	IVECO	Freno	262	1			210,00
931020	1861887	IVECO	Freno	259	1			60,00
931021	BTH1053	IVECO	Freno	262	1			60,00
931023	7182032	IVECO	Freno	266	1			310,00
931024	7166472	IVECO	Varie	186	1			15,00
931030	7168586	IVECO	Freno	263	1			210,00
931031	7168464	IVECO	Freno	263	1			340,00
931032	42104691	IVECO	Freno	263	1			275,00
931033	7173747	IVECO	Freno	264	1			215,00
931034	7173314	IVECO	Freno	264	1			340,00
931035	7173696	IVECO	Freno	264	1			230,00
931036	7182040	IVECO	Freno	264	1			270,00
931037	42115016	IVECO	Freno	265	1			230,00
931038	7180909	IVECO	Freno	265	1			300,00
931039	7172993	IVECO	Freno	265	1			140,00
931040	42101362	IVECO	Freno	263	1			248,00
931041	7180797	IVECO	Freno	265	1			250,00
931042	7179929	IVECO	Freno	266	1			320,00
931043	7179777	IVECO	Freno	266	1			315,00
931044	42101918	IVECO	Freno	266	1			300,00
931200	59520004	CARDI	Freno	272	1			198,00
931201	59510104	CARDI	Freno	272	1			210,00
931207	3555488	IVECO	Varie	187	2			12,00
931250	23114100	O/CAVA	Freno	273	1			185,00
931251	23115100	O/CAVA	Freno	273	1			215,00
931300	125699112	ADIGE VIBERTI	Freno	269	1			210,00
931315	8123663	IVECO	Freno	374	1			100,00
931317	2475977	IVECO - ASTRA	Freno	374	1			100,00
931320	4460212	IVECO	Freno	374	1			85,00
931400	0327248460	BPW	Freno	270	1			155,00
931401	0327230410	BPW	Freno	270	1			160,00
931402	0980106050	BPW	Freno	271	1			285,00
931403	0980106580	BPW	Freno	271	1			375,00
931404	0980106030	BPW	Freno	270	1			310,00
931406	0327243100	BPW	Freno	270	1			160,00
931500	14204562	ROR	Freno	275	1			300,00
931501	14225425	ROR	Freno	275	1			350,00
931502	14224748	ROR	Freno	275	1			330,00
931503	14219784	ROR	Freno	276	1			300,00
931504	14203219	ROR	Freno	276	1			310,00
931505	14210885	ROR	Freno	276	1			300,00
931506	14226121	ROR	Freno	277	1			380,00
931507	14227483	ROR	Freno	277	1			380,00
931508	14226120	ROR	Freno	277	1			380,00
931600	3434365000	SAF	Freno	278	1			290,00
931601	1146200402	SAF	Freno	278	1			200,00
931700	402029X100	NISSAN	Freno	267	1			250,00

LISTINO PREZZI IN PROGRESSIONE RIFERIMENTI 
PRICE LIST IN ORDER OF  **REFERENCE**

	Rif.Originale Original Ref.	Adattabile a: Adaptable to:	Tipo Cat. Cat. Type	Pagina Page	Qtà/Conf. Q.ty/Pck.	OE	Cat. D	Listino Price L. €
931701	43202F3903	NISSAN	Freno	267	1			168,00
931750	016973460	DAF	Freno	255	1			450,00
931751	013916170	DAF	Freno	255	1			580,00
931800	1382884	SCANIA	Freno	268	1			850,00
931801	1480933	SCANIA	Freno	268	1			650,00
931802	1414154	SCANIA	Freno	268	1			620,00
931820	0003500535	ASSALI MERCEDES	Freno	274	1			450,00
933400	93803594	IVECO	Varie	193	1			110,00
933401	98464866	IVECO	Varie	193	1			125,00
933402	500330665	IVECO	Varie	193	1			110,00
933403	504003565	IVECO	Varie	193	1			110,00
933404	42064798	IVECO	Varie	185	3			75,00
933405	42159023	IVECO	Varie	185	3			60,00
933406	4459828	IVECO	Varie	184	1			80,00
933407	42064799	IVECO	Varie	184	1			148,00
933408	93826384	IVECO	Varie	193	1			115,00
933412	42064785	IVECO	Varie	186	3			55,00
933413	42037779	IVECO	Varie	192	1			7,00
933414	42037552	IVECO	Varie	192	1			18,00
933415	2477919	IVECO	Varie	186	3			45,00
933434	42118227	IVECO	Varie	182	1			250,00
933435	42037489	IVECO	Varie	182	1			250,00
933436	-	IVECO	Varie	188	1			740,00
933437	-	IVECO	Varie	188	1			700,00
933442	-	IVECO	Varie	189	1			850,00
933444	42118478	IVECO	Varie	187	2			4,50
933454	42118606	IVECO	Varie	183	1		D	75,00
933455	42118921	IVECO	Varie	183	1		D	75,00
933459	-	IVECO	Varie	190	1			800,00
933470	-	IVECO	Varie	187	2			8,00
933471	-	IVECO	Varie	187	2			8,00
933475	-	IVECO	Varie	190	1			850,00
934014	42546332	IVECO	Varie	177	1			17,50
934015	967265	IVECO	Varie	177	1			11,00
934016	1905986	IVECO	Varie	177	1			12,00
934017	92601339	IVECO	Varie	178	1			14,00
934018	8197741	IVECO	Varie	177	1			16,00
934019	42532985	IVECO	Varie	177	1			11,00
934021	42546224	IVECO	Varie	178	1			36,20
934021	93160221	IVECO	Varie	178	1			36,20
934022	42541372	IVECO	Varie	177	1			11,00
934023	42541373	IVECO	Varie	178	1			17,50
934024	42535253	IVECO	Varie	178	1			14,00
934027	8198583	IVECO	Varie	179	1			72,00
934028	337058	SCANIA	Varie	181	1			106,00
934029	294383	SCANIA	Varie	181	1			106,00
934030	264043	SCANIA	Varie	181	1			60,00
934032	93160225	IVECO	Varie	178	1			23,00
934033	42532346	IVECO	Varie	179	1			50,00
934034	93160516	IVECO	Varie	179	1			60,00
934035	42533841	IVECO	Varie	179	1			45,00
934037	93192015	IVECO	Varie	179	1			75,00
934038	42533410	IVECO	Varie	180	1			75,00
934039	42537896	IVECO	Varie	180	1			75,00
934040	93157114	IVECO	Varie	180	1			75,00
934041	93159498	IVECO	Varie	180	1			90,00

LISTINO PREZZI IN PROGRESSIONE RIFERIMENTI EMMERRE
PRICE LIST IN ORDER OF EMMERRE REFERENCE

	Rif.Originale Original Ref.	Adattabile a: Adaptable to:	Tipo Cat. Cat. Type	Pagina Page	Qtà/Conf. Q.ty/Pck.	OE	Cat. D	Listino Price L. €
941510	-	IVECO	Varie	194	25			0,80
941511	-	IVECO	Varie	194	25			0,80
941512	-	IVECO	Varie	194	25			0,80
941513	-	IVECO	Varie	194	25			0,80
941514	-	IVECO	Varie	194	25			0,80
941515	-	IVECO	Varie	194	25			0,80
941516	-	IVECO	Varie	194	25			0,80
941517	-	IVECO	Varie	194	25			0,80
941518	-	IVECO	Varie	194	25			0,80
941519	-	IVECO	Varie	194	25			0,80
941520	-	IVECO	Varie	194	25			0,80
941521	-	IVECO	Varie	194	25			0,80
941522	-	IVECO	Varie	194	25			0,80
941524	-	IVECO	Varie	194	25			0,80
941525	-	IVECO	Varie	194	25			0,80
941526	-	IVECO	Varie	194	25			0,80
941528	-	IVECO	Varie	194	25			0,80
941529	-	IVECO	Varie	194	25			0,80
941530	-	IVECO	Varie	194	25			0,80
941531	-	IVECO	Varie	194	25			0,80
941532	-	IVECO	Varie	194	25			0,80
941533	-	IVECO	Varie	194	25			0,80
941534	-	IVECO	Varie	194	25			0,80
941535	-	IVECO	Varie	194	25			0,80
941537	-	IVECO	Varie	194	25			0,80
941538	-	IVECO	Varie	194	25			0,80
941539	-	IVECO	Varie	194	25			1,00
941550	-	IVECO	Varie	194	25			1,00
941551	-	IVECO	Varie	194	25			1,00
941552	-	IVECO	Varie	194	25			1,00
941553	-	IVECO	Varie	194	25			1,00
941554	-	IVECO	Varie	194	25			1,00
941555	-	IVECO	Varie	194	25			1,00
953001	8580540	IVECO	Sterzo	111	1			360,00
953002	8580539	IVECO	Sterzo	111	1			360,00
953003	8581856	IVECO	Sterzo	111	1			360,00
953006	504035805	IVECO	Sterzo	112	1	OE	D	240,00
953009	8139398	IVECO	Sterzo	112	1	OE		575,00
953010	4722013	IVECO	Sterzo	115	1			28,00
953013	500393296	IVECO	Sterzo	112	1	OE		345,00
953014	504051709	IVECO	Sterzo	113	1	OE	D	250,00
953015	504051707	IVECO	Sterzo	113	1	OE		320,00
953016	93806182	IVECO	Sterzo	115	2			6,00
953020	41025213	IVECO	Sterzo	115	1			25,00
953030	93812112	IVECO	Sterzo	110	1		D	118,00
953031	4834295	IVECO	Sterzo	111	1			360,00
953032	93802399	IVECO	Sterzo	110	1			155,00
953033	93802065	IVECO	Sterzo	110	1			140,00
953034	8585982	IVECO	Sterzo	110	1			170,00
953048	42552567	IVECO	Sterzo	114	1			65,00
953049	4835930	IVECO	Sterzo	112	1		D	280,00
953050	4679363	IVECO	Sterzo	114	1			100,00
953051	4715667	IVECO	Sterzo	114	1			100,00
953052	93806199	IVECO	Sterzo	114	1			56,00
953200	7184090	IVECO	Varie	192	1			22,50
953201	7184091	IVECO	Varie	191	1			24,00

LISTINO PREZZI IN PROGRESSIONE RIFERIMENTI 
PRICE LIST IN ORDER OF  **REFERENCE**

	Rif.Originale Original Ref.	Adattabile a: Adaptable to:	Tipo Cat. Cat. Type	Pagina Page	Qtà/Conf. Q.ty/Pck.	OE	Cat. D	Listino Price L. €
953202	7184092	IVECO	Varie	192	1			18,00
953310	4826461	IVECO	Varie	197	2			20,00
953313	93808619	IVECO	Varie	197	2			60,00
954000	500340769	IVECO	Sterzo	38	1			67,00
954003	0067389	DAF	Sterzo	5	1			80,00
954004	0067303	DAF	Sterzo	5	1			80,00
954005	1699401	VOLVO	Sterzo	94	1			87,00
954006	1699400	VOLVO	Sterzo	94	1			87,00
954007	0013302635	MERCEDES	Sterzo	54	1			82,00
954008	0013302735	MERCEDES	Sterzo	54	1			82,00
954009	9750079980	FIAT	Sterzo	11	2			14,00
954010	1306716080	FIAT	Sterzo	11	2			14,00
954011	42534911	IVECO	Sterzo	14	2			16,50
954012	113254	ASTRA	Sterzo	1	2			32,00
954012	698450	DAF	Sterzo	4	2			32,00
954012	1358793	SCANIA	Sterzo	87	2			32,00
954012	4833822	IVECO	Sterzo	20	2			32,00
954012	5010832582	RENAULT	Sterzo	80	2			32,00
954012	81953016234	MAN	Sterzo	39	2			32,00
954012	0004602948	MERCEDES	Sterzo	51	2			32,00
954013	113253	ASTRA	Sterzo	1	2			32,00
954013	1228115	DAF	Sterzo	4	2			32,00
954013	1358792	SCANIA	Sterzo	87	2			32,00
954013	4833823	IVECO	Sterzo	20	2			32,00
954013	5010832583	RENAULT	Sterzo	80	2			32,00
954013	81953016179	MAN	Sterzo	39	2			32,00
954013	0004603548	MERCEDES	Sterzo	51	2			32,00
954014	500337201	IVECO	Sterzo	14	1			27,00
954015	1903652	IVECO	Sterzo	13	2			13,00
954016	500310933	IVECO	Sterzo	14	2			22,00
954017	93807545	IVECO	Sterzo	13	1			14,00
954018	4579231	IVECO	Sterzo	14	2			10,00
954019	4579232	IVECO	Sterzo	14	2			10,00
954020	504212586	IVECO	Sterzo	13	1		D	17,50
954022	1696919	VOLVO	Sterzo	93	2			24,00
954022	8558527	IVECO	Sterzo	15	2			24,00
954022	0003309935	MERCEDES	Sterzo	52	2			24,00
954023	1696920	VOLVO	Sterzo	93	2			24,00
954023	8558524	IVECO	Sterzo	15	2			24,00
954023	0003309835	MERCEDES	Sterzo	53	2			24,00
954026	607453	DAF	Sterzo	3	2			24,00
954026	1698191	VOLVO	Sterzo	93	2			24,00
954026	4833825	IVECO	Sterzo	17	2			24,00
954026	5001825687	RENAULT	Sterzo	79	2			24,00
954026	81953016249	MAN	Sterzo	40	2			24,00
954026	0003309535	MERCEDES	Sterzo	52	2			24,00
954027	607452	DAF	Sterzo	3	2			24,00
954027	1698190	VOLVO	Sterzo	94	2			24,00
954027	4833826	IVECO	Sterzo	17	2			24,00
954027	5000823997	RENAULT	Sterzo	79	2			24,00
954027	81953016222	MAN	Sterzo	40	2			24,00
954027	0003309635	MERCEDES	Sterzo	52	2			24,00
954028	4663787	IVECO	Sterzo	15	2			19,00
954029	4663791	IVECO	Sterzo	15	2			19,00
954030	4663972	IVECO	Sterzo	15	1			40,00
954031	4663974	IVECO	Sterzo	16	1			40,00

LISTINO PREZZI IN PROGRESSIONE RIFERIMENTI EMMERRE
PRICE LIST IN ORDER OF EMMERRE REFERENCE

	Rif.Originale Original Ref.	Adattabile a: Adaptable to:	Tipo Cat. Cat. Type	Pagina Page	Qtà/Conf. Q.ty/Pck.	OE	Cat. D	Listino Price L. €
954032	4688941	IVECO	Sterzo	18	2			30,00
954033	4688942	IVECO	Sterzo	18	2			30,00
954034	4664349	IVECO	Sterzo	16	1			55,00
954035	4664347	IVECO	Sterzo	16	1			55,00
954036	-48527-9X62A	NISSAN	Sterzo	77	2			25,00
954037	-48647-9X62A	NISSAN	Sterzo	77	2			25,00
954038	4732041	IVECO	Sterzo	17	1			82,00
954039	4732042	IVECO	Sterzo	17	1			82,00
954040	10229	ASTRA	Sterzo	1	2			34,00
954040	4688948	IVECO	Sterzo	18	2			34,00
954041	30042	ASTRA	Sterzo	1	2			34,00
954041	4688949	IVECO	Sterzo	18	2			34,00
954044	-11500373-0	NISSAN	Sterzo	77	2			28,00
954045	-11500307-0	NISSAN	Sterzo	77	2			28,00
954050	1205215	DAF	Sterzo	4	1			150,00
954051	1205248	DAF	Sterzo	4	1			150,00
954052	2460515	IVECO	Sterzo	17	1			65,00
954053	98475709	IVECO	Sterzo	25	1			220,00
954054	4664586	IVECO	Sterzo	16	1			40,00
954055	98473328	IVECO	Sterzo	25	1			195,00
954056	98493054	IVECO	Sterzo	26	1			185,00
954057	98469650	IVECO	Sterzo	26	1			165,00
954058	500397738	IVECO	Sterzo	27	1			215,00
954059	41005475	IVECO	Sterzo	27	1			170,00
954060	8559559	IVECO	Sterzo	23	1			100,00
954061	41215165	IVECO	Sterzo	27	1			170,00
954063	8567618	IVECO	Sterzo	23	1			145,00
954065	8570528	IVECO	Sterzo	22	1			135,00
954066	8564248	IVECO	Sterzo	23	1			98,00
954071	61595957	IVECO	Sterzo	22	1			130,00
954072	41028269	IVECO	Sterzo	28	1			170,00
954073	98402553	IVECO	Sterzo	29	1			148,00
954074	4773359	IVECO	Sterzo	22	1			125,00
954076	4854871	IVECO	Sterzo	29	1			166,00
954077	98470968	IVECO	Sterzo	29	1			230,00
954078	85466106140	MAN	Sterzo	41	1			140,00
954079	85466106104	MAN	Sterzo	41	1			140,00
954080	81466116197	MAN	Sterzo	42	1			185,00
954081	0014602905	MERCEDES	Sterzo	58	1			173,00
954082	9704600705	MERCEDES	Sterzo	59	1		D	100,00
954083	9453300003	MERCEDES	Sterzo	67	1			390,00
954084	9724601405	MERCEDES	Sterzo	59	1		D	100,00
954085	9724601805	MERCEDES	Sterzo	59	1			145,00
954086	9744601005	MERCEDES	Sterzo	59	1			160,00
954087	0024604905	MERCEDES	Sterzo	60	1			160,00
954088	0014607005	MERCEDES	Sterzo	60	1			160,00
954089	0014608105	MERCEDES	Sterzo	63	1			160,00
954090	0014608505	MERCEDES	Sterzo	63	1			160,00
954091	0014608605	MERCEDES	Sterzo	61	1			160,00
954092	0024604605	MERCEDES	Sterzo	62	1			148,00
954094	5010294288	RENAULT	Sterzo	85	1			170,00
954095	5010294289	RENAULT	Sterzo	85	1			225,00
954096	9493301203	MERCEDES	Sterzo	65	1			205,00
954097	9753300803	MERCEDES	Sterzo	64	1			200,00
954098	4747961	IVECO	Sterzo	24	1			120,00
954099	9453300503	MERCEDES	Sterzo	65	1			185,00

LISTINO PREZZI IN PROGRESSIONE RIFERIMENTI **EMMERRE**
PRICE LIST IN ORDER OF **EMMERRE** **REFERENCE**

EMMERRE	Rif.Originale Original Ref.	Adattabile a: Adaptable to:	Tipo Cat. Cat. Type	Pagina Page	Qtà/Conf. Q.ty/Pck.	OE	Cat. D	Listino Price L. €
954100	42042950	IVECO	Sterzo	24	1			145,00
954101	42001326	IVECO	Sterzo	24	1			130,00
954102	9493300903	MERCEDES	Sterzo	66	1			220,00
954103	1305012	SCANIA	Sterzo	89	1			185,00
954104	278665	SCANIA	Sterzo	90	1			145,00
954105	1112511	SCANIA	Sterzo	89	1			182,00
954106	3164600805	MERCEDES	Sterzo	55	1			120,00
954107	1698840	VOLVO	Sterzo	93	1			43,00
954108	3092472	VOLVO	Sterzo	94	1			39,00
954109	3092471	VOLVO	Sterzo	94	1			39,00
954110	607998	DAF	Sterzo	3	2			31,00
954110	4833828	IVECO	Sterzo	19	2			31,00
954110	3023300335	MERCEDES	Sterzo	51	2			31,00
954110	5000295215	RENAULT	Sterzo	79	2			31,00
954110	81953016163	MAN	Sterzo	39	2			31,00
954111	0004607105	MERCEDES	Sterzo	61	1			138,00
954112	698609	DAF	Sterzo	3	2			31,00
954112	4833827	IVECO	Sterzo	19	2			31,00
954112	5000295214	RENAULT	Sterzo	79	2			31,00
954112	81953016272	MAN	Sterzo	39	2			31,00
954112	0013300135	MERCEDES	Sterzo	51	2			31,00
954113	0014606905	MERCEDES	Sterzo	61	1			160,00
954114	1698846	VOLVO	Sterzo	93	2			39,00
954115	1698847	VOLVO	Sterzo	93	2			39,00
954116	1695776	VOLVO	Sterzo	93	2			39,00
954118	113252	ASTRA	Sterzo	2	1			75,00
954119	113251	ASTRA	Sterzo	2	1			75,00
954120	310980	SCANIA	Sterzo	88	1			100,00
954120	5000288362	RENAULT	Sterzo	80	1			100,00
954121	310979	SCANIA	Sterzo	88	1			100,00
954121	5000288363	RENAULT	Sterzo	80	1			100,00
954122	1337366	SCANIA	Sterzo	87	1			64,00
954123	1337367	SCANIA	Sterzo	87	1			64,00
954124	0013302135	MERCEDES	Sterzo	53	1			82,00
954125	0013302235	MERCEDES	Sterzo	53	1			82,00
954126	606923	DAF	Sterzo	5	1			110,00
954127	606922	DAF	Sterzo	5	1			110,00
954128	0014607648	MERCEDES	Sterzo	52	1			42,00
954129	0014601348	MERCEDES	Sterzo	52	1			42,00
954131	8165309	IVECO	Sterzo	30	1			285,00
954132	41036943	IVECO	Sterzo	30	1			198,00
954133	8163773	IVECO	Sterzo	30	1			198,00
954134	0024604405	MERCEDES	Sterzo	62	1			125,00
954135	500324282	IVECO	Sterzo	26	1			142,00
954136	98402544	IVECO	Sterzo	25	1			125,00
954137	4854874	IVECO	Sterzo	25	1			135,00
954138	98446354	IVECO	Sterzo	26	1			175,00
954139	41005463	IVECO	Sterzo	27	1			140,00
954140	4711108	IVECO	Sterzo	38	1			180,00
954141	0004609805	MERCEDES	Sterzo	58	1			160,00
954143	6734600605	MERCEDES	Sterzo	55	1			105,00
954144	6754602405	MERCEDES	Sterzo	56	1			130,00
954145	6754602205	MERCEDES	Sterzo	56	1			125,00
954146	6764601105	MERCEDES	Sterzo	56	1			128,00
954147	3834601405	MERCEDES	Sterzo	57	1			150,00
954148	6194602905	MERCEDES	Sterzo	57	1			170,00

Copyright della EMMERRE S.r.l. - Settimo Torinese - Tutti i diritti sono riservati e depositati a norma di legge ed a norma delle convenzioni internazionali. - E' vietata la duplicazione o la riproduzione anche parziale senza la previa autorizzazione della EMMERRE S.r.l.

LISTINO PREZZI IN PROGRESSIONE RIFERIMENTI EMMERRE
PRICE LIST IN ORDER OF EMMERRE REFERENCE

	Rif.Originale Original Ref.	Adattabile a: Adaptable to:	Tipo Cat. Cat. Type	Pagina Page	Qtà/Conf. Q.ty/Pck.	OE	Cat. D	Listino Price L. €
954149	6474600105	MERCEDES	Sterzo	57	1			150,00
954150	6204602805	MERCEDES	Sterzo	57	1			150,00
954151	3004600605	MERCEDES	Sterzo	63	1			120,00
954152	3004600405	MERCEDES	Sterzo	63	1			115,00
954153	5010060764	RENAULT	Sterzo	83	1			138,00
954154	0094029	DAF	Sterzo	6	1			160,00
954155	0094038	DAF	Sterzo	7	1			160,00
954156	0024604705	MERCEDES	Sterzo	62	1			165,00
954157	81466106722	MAN	Sterzo	42	1			155,00
954158	0014609805	MERCEDES	Sterzo	60	1			165,00
954159	6014601505	MERCEDES	Sterzo	55	1			100,00
954160	5010130453	RENAULT	Sterzo	82	1			175,00
954161	1283211	DAF	Sterzo	6	1			160,00
954162	1283212	DAF	Sterzo	6	1			160,00
954163	5010130344	RENAULT	Sterzo	84	1			185,00
954164	6014600305	MERCEDES	Sterzo	55	1			90,00
954165	390784	SCANIA	Sterzo	89	1			135,00
954166	9413300203	MERCEDES	Sterzo	66	1			240,00
954167	1384025	SCANIA	Sterzo	90	1			165,00
954168	6174602805	MERCEDES	Sterzo	56	1			158,00
954169	1628636	VOLVO	Sterzo	97	1			170,00
954170	20393061	VOLVO	Sterzo	98	1			168,00
954171	9423300903	MERCEDES	Sterzo	64	1			240,00
954172	20393069	VOLVO	Sterzo	97	1			150,00
954173	1626751	VOLVO	Sterzo	96	1			135,00
954174	1606283	VOLVO	Sterzo	96	1			148,00
954175	9443301703	MERCEDES	Sterzo	64	1		D	250,00
954176	81467106904	MAN	Sterzo	44	1			210,00
954177	0094016	DAF	Sterzo	6	1		D	115,00
954178	1592939	VOLVO	Sterzo	95	1		D	115,00
954179	4815933	IVECO	Sterzo	22	1			135,00
954180	1304569	SCANIA	Sterzo	89	1			160,00
954181	9413300007	MERCEDES	Sterzo	71	1			250,00
954182	9423300003	MERCEDES	Sterzo	67	1			285,00
954183	1075005	VOLVO	Sterzo	97	1			155,00
954184	1291060	DAF	Sterzo	7	1			180,00
954185	8591222	IVECO	Sterzo	23	1			100,00
954186	41016964	IVECO	Sterzo	28	1			258,00
954187	6253302503	MERCEDES	Sterzo	66	1			230,00
954188	81466106328	MAN	Sterzo	41	1			175,00
954190	81467116725	MAN	Sterzo	44	1			200,00
954191	5010130456	RENAULT	Sterzo	83	1			150,00
954192	5010130393	RENAULT	Sterzo	84	1			130,00
954193	5000541230	RENAULT	Sterzo	83	1			166,00
954194	5010294199	RENAULT	Sterzo	83	1			235,00
954195	9493301703	MERCEDES	Sterzo	65	1			230,00
954196	5010138446	RENAULT	Sterzo	82	1			175,00
954197	5010294287	RENAULT	Sterzo	84	1			160,00
954198	5010144552	RENAULT	Sterzo	82	1			145,00
954199	1343266	SCANIA	Sterzo	91	1			180,00
954200	5010239387	RENAULT	Sterzo	82	1			205,00
954201	5010383203	RENAULT	Sterzo	84	1			180,00
954202	388943	SCANIA	Sterzo	91	1			155,00
954203	1397866	SCANIA	Sterzo	92	1			195,00
954204	1385251	SCANIA	Sterzo	92	1			240,00
954207	1197338	VOLVO	Sterzo	98	1			225,00

LISTINO PREZZI IN PROGRESSIONE RIFERIMENTI **EMMERRE**
PRICE LIST IN ORDER OF **EMMERRE** **REFERENCE**

EMMERRE	Rif.Originale Original Ref.	Adattabile a: Adaptable to:	Tipo Cat. Cat. Type	Pagina Page	Qtà/Conf. Q.ty/Pck.	OE	Cat. D	Listino Price L. €
954208	1626749	VOLVO	Sterzo	97	1		D	120,00
954209	1083744	VOLVO	Sterzo	96	1			160,00
954210	1626493	VOLVO	Sterzo	96	1			145,00
954211	1395614	SCANIA	Sterzo	92	1			340,00
954212	6790572	VOLVO	Sterzo	95	1			145,00
954213	6799190	VOLVO	Sterzo	95	1			145,00
954214	3124480	VOLVO	Sterzo	95	1			140,00
954215	81467116759	MAN	Sterzo	44	1			155,00
954215	81467116761	MAN	Sterzo	44	1			155,00
954216	5000814096	RENAULT	Sterzo	81	2			32,00
954216	81953016141	MAN	Sterzo	40	2			32,00
954216	81953016141	VOLVO	Sterzo	94	2			32,00
954216	0003308635	MERCEDES	Sterzo	53	2			32,00
954217	5000814097	RENAULT	Sterzo	81	2			32,00
954217	81953016142	MAN	Sterzo	40	2			32,00
954217	81953016142	VOLVO	Sterzo	94	2			32,00
954217	0003308535	MERCEDES	Sterzo	53	2			32,00
954218	0014600305	MERCEDES	Sterzo	58	1			155,00
954219	6204602905	MERCEDES	Sterzo	58	1			155,00
954219	6204603005	MERCEDES	Sterzo	58	1			155,00
954221	3986452	VOLVO	Sterzo	98	1			178,00
954222	81466116004	MAN	Sterzo	42	1			200,00
954223	85466106102	MAN	Sterzo	43	1			142,00
954224	1351734	DAF	Sterzo	7	1			170,00
954230	1080792	VOLVO	Sterzo	99	1			225,00
954231	3962343	VOLVO	Sterzo	99	1			225,00
954232	5010600822	RENAULT	Sterzo	86	1		D	225,00
954233	5010439022	RENAULT	Sterzo	86	1			350,00
954234	5010566063	RENAULT	Sterzo	86	1			350,00
954252	98489741	IVECO	Sterzo	38	1			280,00
954299	42533073	IVECO	Sterzo	21	1			170,00
954300	93192809	IVECO	Sterzo	21	1			90,00
954301	42533101	IVECO	Sterzo	21	1			90,00
954303	42533102	IVECO	Sterzo	21	1			90,00
954305	500383975	IVECO	Sterzo	109	2			22,50
954306	500383976	IVECO	Sterzo	109	2			22,50
954309	81467116860	MAN	Sterzo	44	1			215,00
954310	93804572	IVECO	Sterzo	122	1			360,00
954311	93804573	IVECO	Sterzo	122	1			360,00
954312	93801772	IVECO	Sterzo	122	1			90,00
954313	93801773	IVECO	Sterzo	122	1			90,00
954314	93802356	IVECO	Sterzo	13	1			3,20
954315	504212925	IVECO	Sterzo	13	1			3,20
954316	9724602805	MERCEDES	Sterzo	60	1		D	115,00
954317	1357674	SCANIA	Sterzo	88	1			50,00
954318	1384027	SCANIA	Sterzo	90	1			200,00
954319	1394884	SCANIA	Sterzo	90	1			185,00
954320	1621419	VOLVO	Sterzo	101	1			295,00
954400	485109X101	NISSAN	Sterzo	78	1			132,00
954401	485109X102	NISSAN	Sterzo	78	1			132,00
954402	48510F3900	NISSAN	Sterzo	78	1			132,00
954550	1394443	SCANIA	Sterzo	88	1		D	90,00
954551	1394444	SCANIA	Sterzo	88	1		D	90,00
954552	817824	DAF	Sterzo	5	1			130,00
954552	9281792	IVECO	Sterzo	21	1			130,00
954552	5000792132	RENAULT	Sterzo	81	1			130,00

LISTINO PREZZI IN PROGRESSIONE RIFERIMENTI EMMERRE
PRICE LIST IN ORDER OF EMMERRE REFERENCE

	Rif.Originale Original Ref.	Adattabile a: Adaptable to:	Tipo Cat. Cat. Type	Pagina Page	Qtà/Conf. Q.ty/Pck.	OE	Cat. D	Listino Price L. €
954552	82953010011	MAN	Sterzo	40	1			130,00
954570	42548853	IVECO	Varie	221	1			78,00
955351	4648354	IVECO	Varie	220	1			250,00
960002	1904534	IVECO BUS	Freno	176	1			480,00
960002.1	-	IVECO BUS	Freno	176	1			120,00
960003	93161407	IVECO BUS	Freno	177	1			495,00
960003.1	-	IVECO BUS	Freno	177	1			123,75
960004	93191658	IVECO	Freno	236	1			19,50
960005	93191659	IVECO	Freno	237	1			16,00
960007	1907764	IVECO BUS	Freno	175	1			460,00
960007.1	-	IVECO BUS	Freno	175	1			230,00
960009	93162033	IVECO	Freno	236	1			98,00
960011	1906216	IVECO BUS	Freno	175	1			200,00
960013	42555635	IVECO	Freno	230	1			10,00
960014	42555637	IVECO	Freno	230	1			37,00
960015	42555636	IVECO	Freno	229	1			25,00
960016	42555417	IVECO	Freno	229	1			7,80
960017	93161181	IVECO	Freno	229	1			98,00
960019	2992477	IVECO	Freno	77	1			340,00
960019.1	-	IVECO	Freno	77	1			170,00
960020	2992291	IVECO	Freno	67	1			320,00
960020.1	-	IVECO	Freno	67	1			160,00
960021	1904528	IVECO	Freno	34	1			128,00
960021.1	-	IVECO	Freno	34	1			64,00
960022	1904529	IVECO	Freno	35	1			90,00
960022.1	-	IVECO	Freno	35	1			45,00
960023	1904531	IVECO	Freno	37	1			142,00
960023.1	-	IVECO	Freno	37	1			71,00
960024	1904532	IVECO	Freno	56	1			150,00
960024.1	-	IVECO	Freno	56	1			75,00
960025	80600001029	VEICOLO GASOLONE	Freno	359	1			78,00
960026	93160387	IVECO	Freno	229	1			135,00
960027	7165379	IVECO	Freno	357	1			39,50
960028	7165402	IVECO	Freno	357	1			70,00
960029	1906298	IVECO	Freno	58	1			57,00
960032	1907765	IVECO	Freno	57	1			190,00
960032.1	-	IVECO	Freno	57	1			95,00
960033	2991979	IVECO	Freno	71	1			298,00
960034	2991979.0001	IVECO	Freno	71	1			135,00
960036	1908577	IVECO	Freno	58	1			124,00
960036.1	-	IVECO	Freno	58	1			62,00
960037	1908578	IVECO	Freno	60	1			140,00
960037.1	-	IVECO	Freno	60	1			70,00
960038	2992470	IVECO	Freno	75	1			315,00
960038.1	-	IVECO	Freno	75	1			157,50
960039	1904693	IVECO	Freno	38	1			220,00
960039.1	-	IVECO	Freno	38	1			110,00
960048	1907568	IVECO	Freno	62	1			300,00
960048.1	-	IVECO	Freno	62	1			150,00
960049	1907569	IVECO	Freno	63	1			310,00
960049.1	-	IVECO	Freno	63	1			155,00
960050	42470842	IVECO	Freno	42	1			140,00
960050.1	-	IVECO	Freno	42	1			70,00
960051	42471111	IVECO	Freno	42-44	1			88,00
960051.1	-	IVECO	Freno	42-44	1			44,00
960052	1386686	SCANIA	Freno	162	1			128,00

LISTINO PREZZI IN PROGRESSIONE RIFERIMENTI **EMMERRE**
PRICE LIST IN ORDER OF **EMMERRE** **REFERENCE**

EMMERRE	Rif.Originale Original Ref.	Adattabile a: Adaptable to:	Tipo Cat. Cat. Type	Pagina Page	Qtà/Conf. Q.ty/Pck.	OE	Cat. D	Listino Price L. €
960052	1402272	SCANIA	Freno	162	1			128,00
960053	1906461	IVECO	Freno	73	1			294,00
960053.1	-	IVECO	Freno	73	1			147,00
960054	40206D9200	NISSAN	Freno	131	1			125,00
960055	40206F3902	NISSAN	Freno	121	1			45,00
960056	40206F3901	NISSAN	Freno	122	1			45,00
960057	432069X401	NISSAN	Freno	124	1			55,00
960058	402079X100	NISSAN	Freno	125	1			55,00
960059	402069X200	NISSAN	Freno	123	1			55,00
960077	93161429	IVECO	Freno	237	1			57,00
960078	93162044	IVECO	Freno	237	1		D	21,50
960079	93159285	IVECO	Freno	237	1			120,00
960080	93161244	IVECO	Freno	238	1			225,00
960081	42538003	IVECO	Freno	238	1		D	45,00
960082	8124735	IVECO	Freno	238	1			39,00
960083	93161471	IVECO	Freno	238	1			75,00
960084	93161475	IVECO	Freno	239	1			85,00
960085	93161908	IVECO	Freno	239	1			65,00
960086	93161559	IVECO	Freno	239	1			57,00
960087	93161192	IVECO	Freno	239	1			70,00
960088	93161189	IVECO	Freno	240	1			110,00
960090	93160388	IVECO	Freno	230	1			12,00
960091	93160389	IVECO	Freno	230	1			3,50
960100	81508030041	MAN	Freno	94	1		D	110,00
960102	3057008400	SAF	Freno	212-213	1			147,00
960104	2992271	IVECO	Freno	66	1			336,00
960104.1	-	IVECO	Freno	66	1			168,00
960107	42471214	IVECO	Freno	46	1			86,00
960107.1	-	IVECO	Freno	46	1			43,00
960108	42471150	IVECO	Freno	47	1			160,00
960108.1	-	IVECO	Freno	47	1			80,00
960110	21227349	ROR	Freno	199	1			142,00
960157	3092329	VOLVO	Freno	250	1			70,00
960180	51728378	FIAT	Freno	19	1			72,00
960181	77364014	FIAT	Freno	19	1			58,00
960182	77364318	FIAT	Freno	19	1			58,00
960183	51705749	FIAT	Freno	21	1			72,00
960184	77364160	FIAT	Freno	21	1			58,00
960185	51705758	FIAT	Freno	22	1			72,00
960186	77364319	FIAT	Freno	22	1			58,00
960188	71740118	FIAT	Freno	23	1			65,00
960189	71740117	FIAT	Freno	24	1			65,00
960190	77362274	FIAT	Freno	23-24	1			58,00
960201	1300501080	FIAT	Freno	16	1			34,00
960202	1307356080	FIAT	Freno	18	1			46,00
960203	43206F3600	NISSAN	Freno	358	1			55,00
960204	-06200387-0	NISSAN	Freno	358	1			115,00
960220	432069X201	NISSAN	Freno	358	1			85,00
960221	5001860184	IVECO BUS	Freno	180	1			210,00
960222	2994031	IVECO BUS	Freno	178	1			600,00
960222.1	-	IVECO BUS	Freno	178	1			300,00
960224	2994084	IVECO BUS	Freno	179	1			600,00
960224.1	-	IVECO BUS	Freno	179	1			300,00
960225	050018644980	RENAULT	Freno	161	1			198,00
960226	5010422364	RENAULT	Freno	160	1			200,00
960227	5010260102	RENAULT	Freno	142	1			135,00

LISTINO PREZZI IN PROGRESSIONE RIFERIMENTI EMMERRE
PRICE LIST IN ORDER OF EMMERRE REFERENCE

	Rif.Originale Original Ref.	Adattabile a: Adaptable to:	Tipo Cat. Cat. Type	Pagina Page	Qtà/Conf. Q.ty/Pck.	OE	Cat. D	Listino Price L. €
960228	5010260218	RENAULT	Freno	144-145	1			140,00
960229	5010260609	RENAULT	Freno	138	1			52,00
960230	5010260604	RENAULT	Freno	137	1			48,00
960231	4403045	OPEL	Freno	133	1			46,00
960231	7700314107	RENAULT	Freno	136	1			46,00
960232	1906466	IVECO	Freno	65	1			212,00
960232.1	-	IVECO	Freno	65	1			106,00
960233	4403038	OPEL	Freno	132	1			64,00
960233	7700314064	RENAULT	Freno	135	1			64,00
960234	7700302128	RENAULT	Freno	134	1			44,00
960235	-06100420-0	NISSAN	Freno	129	1			110,00
960236	-06200438-0	NISSAN	Freno	130	1			110,00
960237	5010525308	RENAULT	Freno	146	1			110,00
960238	5010422263	RENAULT	Freno	148	1			132,00
960239	5010525014	RENAULT	Freno	150	1			130,00
960240	5010525362	RENAULT	Freno	152	1			150,00
960241	5010848607	RENAULT	Freno	146-154	1			80,00
960242	5010525364	RENAULT	Freno	154	1			165,00
960243	60500015000	GASOLONE	Freno	30	1			65,00
960244	R1410920100	GASOLONE	Freno	30	1			52,00
960256	80500001043	GASOLONE	Freno	30	1			287,00
960257	3092261	VOLVO	Freno	250	1			70,00
960258	85102095	VOLVO	Freno	250	1			125,00
960259	85102096	VOLVO	Freno	249	1			125,00
960260	85102093	VOLVO	Freno	249	1			125,00
960261	3092267	VOLVO	Freno	249	1			125,00
960262	3092262	MERITOR - VOLVO	Freno	249	1			280,00
960263	3092263	MERITOR - VOLVO	Freno	248	1			280,00
960264	3095626	MERITOR	Freno	248	1			42,00
960265	85102094	MERITOR-ROR-VOLVO	Freno	248	1			108,00
960266	85102092	MERITOR-RENAULT	Freno	248	1			112,00
960267	3092264	MERITOR-VOLVO-ROR	Freno	247	1		D	42,00
960268	-	MERITOR-RENAULT	Freno	247	1			APPR.
960269	-	MERITOR-MAN	Freno	247	1			165,00
960270	5001864365	RENAULT	Freno	146-154	4			185,00
960271	20568712	VOLVO	Freno	169	1			185,00
960272	5001855902	RENAULT	Freno	147-155	4			170,00
960273	-	MERITOR-MAN-RENAULT	Freno	247	1			APPR.
960274	-	MERITOR-IRISBUS-MAN	Freno	246	1			APPR.
960275	-	MERITOR-IRISBUS-MAN	Freno	246	1			495,00
960276	-	MERITOR-MAN-RENAULT	Freno	246	1			330,00
960277	-	MERITOR-RENAULT	Freno	246	1			168,00
960278	-	MERITOR-MERCEDES	Freno	245	1			168,00
960279	-	MERITOR-MERCEDES	Freno	245	1			168,00
960280	-	KNORR	Freno	241	1			60,00
960281	-	KNORR	Freno	241	1			230,00
960282	-	KNORR	Freno	241	1			230,00
960283	-	KNORR	Freno	241	1			145,00
960284	-	DAF-IVECO-MERCEDES	Freno	242	1			145,00
960285	-	DAF-IVECO-MERCEDES	Freno	242	1			140,00
960286	-	MERCEDES-SCANIA	Freno	242	1			140,00
960287	-	MERCEDES-SCANIA	Freno	242	1			140,00
960288	-	WABCO-SAF-DAF	Freno	243	1			145,00
960289	-	WABCO-SAF-DAF	Freno	243	1			110,00
960290	-	WABCO/PAN17-19	Freno	243	1			100,00
960291	-	MERCEDES-RENAULT	Freno	243	1			129,00

LISTINO PREZZI IN PROGRESSIONE RIFERIMENTI 
PRICE LIST IN ORDER OF  **REFERENCE**

	Rif.Originale Original Ref.	Adattabile a: Adaptable to:	Tipo Cat. Cat. Type	Pagina Page	Qtà/Conf. Q.ty/Pck.	OE	Cat. D	Listino Price L. €
960292	-	MAN - MERCEDES	Freno	244	1			APPR.
960293	-	MAN - MERCEDES	Freno	244	1			APPR.
960294	-	MAN - MERCEDES	Freno	244	1			97,00
960295	-	MAN - MERCEDES	Freno	244	1			97,00
960296	-	MERITOR-RENAULT	Freno	245	1			137,00
960297	-	MERITOR-RENAULT	Freno	245	1			137,00
960298	4079000400	SAF	Freno	205	1			145,00
960299	016405610	DAF	Freno	11	1			149,00
960300	MBR9004	ROR	Freno	204	1			169,00
960301	21224263	ROR	Freno	200	1			150,00
960302	-	KNORR - SCANIA	Freno	251	1			115,00
960303	PAK3546	DAF	Freno	4	1			66,00
960304	PAK3545	DAF	Freno	3	1			65,00
960305	5000396612	RENAULT	Freno	141	1			75,00
960306	5010216548	RENAULT	Freno	156	1			136,00
960307	5010216437	RENAULT	Freno	157-158	1			145,00
960308	5000450158	RENAULT	Freno	143	1			74,00
960310	6779208	VOLVO	Freno	164	1			72,00
960311	6774686	VOLVO	Freno	166	1			74,00
960312	6779209	VOLVO	Freno	165	1			150,00
960313	056.101-00	KASSBOHRER BUS	Freno	183	1			160,00
960314	8285390000	KASSBOHRER BUS	Freno	184	1			170,00
960315	3564210312	MERCEDES BUS	Freno	181	1			175,00
960316	9424212112	MERCEDES	Freno	117	1			128,00
960317	9434210312	MERCEDES	Freno	119	1			195,00
960318	6704210312	MERCEDES	Freno	110	1			62,00
960319	6694210612	MERCEDES	Freno	109	1			62,00
960320	81508030010	MAN	Freno	83	1			67,00
960321	81508030040	MAN	Freno	93	1		D	100,00
960322	81508030009	MAN	Freno	92	1			150,00
960323	9044230312	MERCEDES	Freno	100	1			45,00
960324	9024210612	MERCEDES	Freno	99	1			46,00
960325	9024230312	MERCEDES	Freno	101	1			42,00
960326	6014200272	MERCEDES	Freno	107	1		D	40,00
960328	81508030026	MAN	Freno	85	1			98,00
960329	81508030057	MAN	Freno	91	1			126,00
960330	-	IVECO	Freno	395	2			42,00
960331	-	IVECO	Freno	395	2			42,00
960333	6384210112	MERCEDES	Freno	97	1			32,00
960334	6384230112	MERCEDES	Freno	98	1			30,00
960335	6014200372	MERCEDES	Freno	108	1		D	40,00
960336	9704210612	MERCEDES	Freno	111	1			85,00
960337	9704230612	MERCEDES	Freno	112	1			90,00
960338	9704230712	MERCEDES	Freno	113	1			89,00
960339	9754210112	MERCEDES	Freno	115	1			110,00
960340	-	KNORR - SCANIA	Freno	251	1			115,00
960341	9754230612	MERCEDES	Freno	116	1			118,00
960342	5010216433	RENAULT	Freno	140	1			45,00
960343	81508030061	MAN	Freno	87	1			95,00
960344	81508030042	MAN	Freno	96	1			90,00
960345	81508030039	MAN	Freno	89	1			95,00
960346	9704230212	MERCEDES	Freno	114	1			95,00
960347	3093532	VOLVO	Freno	174	1			150,00
960349	3099533	VOLVO	Freno	170-171	1			150,00
960350	MBR9001	ROR	Freno	202	1			190,00
960351	MBR9014	ROR	Freno	201	1			175,00

LISTINO PREZZI IN PROGRESSIONE RIFERIMENTI EMMERRE
PRICE LIST IN ORDER OF EMMERRE REFERENCE

	Rif.Originale Original Ref.	Adattabile a: Adaptable to:	Tipo Cat. Cat. Type	Pagina Page	Qtà/Conf. Q.ty/Pck.	OE	Cat. D	Listino Price L. €
960352	0308834010	BPW	Freno	187	1			140,00
960353	4079000300	SAF	Freno	208	1			185,00
960354	-	ASSALI MERCEDES	Freno	196	1			128,00
960355	03.088.35.01.0	BPW	Freno	192	1			155,00
960356	03.088.35.03.0	BPW	Freno	193	1			155,00
960358	03.088.34.04.0	BPW	Freno	185	1			135,00
960359	03.088.34.08.0	BPW	Freno	189	1			135,00
960360	03.088.34.03.0	BPW	Freno	186	1			140,00
960361	03.088.34.07.0	BPW	Freno	188	1			135,00
960362	4079000502	SAF	Freno	210	1		D	110,00
960363	449445	SMB	Freno	215	1			165,00
960364	449418	SMB	Freno	214	1			144,00
960366	03.088.34.10.7	BPW	Freno	190	1			160,00
960367	03.088.35.05.0	BPW	Freno	194	1			170,00
960368	1408670	DAF	Freno	6	1			110,00
960369	1408672	DAF	Freno	7	1			110,00
960370	0851038030	VOLVO	Freno	170-172	1			198,00
960371	4079000701	SAF	Freno	207	1			118,00
960372	42532362	IVECO	Freno	219	1			165,00
960373	42532363	IVECO	Freno	219	1			165,00
960374	03092710	VOLVO	Freno	171-173	1			198,00
960375	1403758	DAF	Freno	8	1			116,00
960376	1400069	DAF	Freno	9	1			116,00
960377	1400284	DAF	Freno	10	1			136,00
960378	4450931	FIAT	Freno	13	1			26,00
960379	7531819	FIAT	Freno	14	1			32,00
960380	1300500080	FIAT	Freno	15	1			50,00
960381	7538682	FIAT	Freno	17	1			50,00
960382	5025610	FORD	Freno	25	1			35,00
960383	5025611	FORD	Freno	26	1			30,00
960384	4041427	FORD	Freno	27	1			30,00
960385	4041428	FORD	Freno	28	1			30,00
960386	4455980	FORD	Freno	29	1			30,00
960387	6775227	VOLVO	Freno	167	1			95,00
960388	6796864	VOLVO	Freno	168	1		D	170,00
960389	AMPA014	DAF	Freno	5	1			140,00
960390	9024230412	MERCEDES	Freno	102	1			45,00
960391	9014230812	MERCEDES	Freno	103	1			42,00
960392	5010260603	RENAULT	Freno	139	1			50,00
960393	81508030048	MAN	Freno	95	1			185,00
960394	68324665	ROR	Freno	201-202	1			145,00
960395	040790010010	SAF	Freno	212	1			168,00
960396	040790013000	SAF	Freno	213	1			194,00
960397	120015000188	LECINENA	Freno	197	1			180,00
960399	120015000005.V	LECINENA	Freno	198	1			180,00
960400	3092270	MERITOR - VOLVO	Freno	251	1			37,00
960401	3095669	MERITOR - VOLVO	Freno	251	1			39,00
960402	2995894	IVECO	Freno	68	1			350,00
960402.1	-	IVECO	Freno	68	1			175,00
960403	3092269	MERITOR - ROR - VOLVO	Freno	252	1			37,00
960404	2996327	IVECO	Freno	78	1			380,00
960404.1	-	IVECO	Freno	78	1			190,00
960405	2996328	IVECO	Freno	79	1			530,00
960405.1	-	IVECO	Freno	79	1			265,00
960406	2996329	IVECO	Freno	80	1			470,00
960406.1	-	IVECO	Freno	80	1			235,00

LISTINO PREZZI IN PROGRESSIONE RIFERIMENTI 
PRICE LIST IN ORDER OF  **REFERENCE**

	Rif.Originale Original Ref.	Adattabile a: Adaptable to:	Tipo Cat. Cat. Type	Pagina Page	Qtà/Conf. Q.ty/Pck.	OE	Cat. D	Listino Price L. €
960407	3095673	VOLVO	Freno	169	1			327,00
960409	1908179	IVECO	Freno	64	1			450,00
960409.1	-	IVECO	Freno	64	1			225,00
960410	8973292660	ISUZU	Freno	31	1			98,00
960411	8971686340	ISUZU	Freno	32-33	1			116,00
960412	8970947100	ISUZU	Freno	32	1			116,00
960415	-	WABCO-SAF	Freno	252	1			98,00
960416	-	MAN - MERCEDES	Freno	252	1			46,00
960420	-	MAN - MERCEDES	Freno	252	1			112,00
960422	9064230112	MERCEDES	Freno	106	1			65,00
960427	0044208220	MERCEDES	Freno	104	1			69,00
960428	77362216	FIAT	Freno	20-21-22	1			58,00
960434	68325408	RENAULT	Freno	159-160	1			50,00
960435	9015400317	MERCEDES	Freno	105	1			14,00
960439	1267426	IVECO	Freno	396	10			2,00
960440	-	RENAULT	Freno	147-155	1			12,00
960442	9925629	IVECO	Freno	396	10			2,50
960443	8528778	IVECO	Freno	396	2			2,20
960498	2996033	IVECO	Freno	51	1			194,00
960498.1	-	IVECO	Freno	51	1			97,00
960500	5010422593	RENAULT	Freno	159	1			156,00
960501	42546401	IVECO	Freno	44	1			195,00
960501.1	-	IVECO	Freno	44	1			97,50
960502	2995632	IVECO	Freno	44	1			62,00
960503	2995633	IVECO	Freno	45	1			54,00
960504	2995693	IVECO	Freno	45	1			54,00
960506	2992635	IVECO	Freno	69	1			360,00
960506.1	-	IVECO	Freno	69	1			180,00
960507	2992636	IVECO	Freno	70	1			360,00
960507.1	-	IVECO	Freno	70	1			180,00
960508	42539439	IVECO BUS	Freno	175-177	1		D	15,00
960511	42537942	IVECO	Freno	307	1			75,00
960512	2996121	IVECO	Freno	48	1			138,00
960512.1	-	IVECO	Freno	48	1			69,00
960513	42555881	IVECO	Freno	48-49	1			68,00
960514	42555634	IVECO	Freno	48-55	1			19,00
960515	2996043	IVECO	Freno	50	1			204,00
960515.1	-	IVECO	Freno	50	1			102,00
960516	42555917	IVECO	Freno	50-53	1			68,00
960517	42556205	IVECO	Freno	50-53	1			16,50
960518	897031007	ISUZU	Freno	31	1			57,00
960519	8971686311	ISUZU	Freno	31	1			57,00
960520	8973872280	ISUZU	Freno	32	1			57,00
960521	8970158571	ISUZU	Freno	33	1			57,00
960522	402069X403	NISSAN	Freno	126	1			58,00
960523	-	DAF	Freno	12	1			48,00
960523	-	SAF	Freno	209-211	1			48,00
960523	-	SCANIA	Freno	163	1			48,00
960523	-	VOLVO	Freno	174	1			48,00
960523	000824.1	ASSALI MERCEDES	Freno	196	1			48,00
960523	000824.1	BPW	Freno	185-195	1			48,00
960523	000824.1	SAF	Freno	206-213	1			48,00
960523	000824.1	SMB	Freno	214-216	1			48,00
960524	3424200600	SAF	Freno	209-211	1			51,00
960525	-	ROR	Freno	199-202	1			57,00
960525	-	VOLVO	Freno	169	1			57,00

LISTINO PREZZI IN PROGRESSIONE RIFERIMENTI EMMERRE
PRICE LIST IN ORDER OF EMMERRE REFERENCE

	Rif.Originale Original Ref.	Adattabile a: Adaptable to:	Tipo Cat. Cat. Type	Pagina Page	Qtà/Conf. Q.ty/Pck.	OE	Cat. D	Listino Price L. €
960526	402069X407	NISSAN	Freno	127	1			130,00
960527	402069X001	NISSAN	Freno	128	1			138,00
960529	-	BPW	Freno	191	1			50,00
960530	-	ROR	Freno	203	1			82,00
960531	-	ROR	Freno	203	1			75,00
960532	-	ROR	Freno	203	1			75,00
960551	68323004	DAF	Freno	9-10	1			42,00
960553	81508226015	MAN	Freno	84-96	1			45,00
960559	1906033	IVECO	Freno	314	1			280,00
960560	1906034	IVECO	Freno	314	1			280,00
960561	2992448	IVECO	Freno	341	1			699,00
960564	9064210012	MERCEDES	Freno	104	1			54,00
960565	9064230012	MERCEDES	Freno	105	1			54,00
960601	42538062	IVECO	Freno	307	1			57,00
960603	42538066	IVECO	Freno	307	1			75,00
960676	2995553	IVECO BUS	Freno	178-179	1			75,00
960694	2996028	IVECO	Freno	53	1			108,00
960694.1	-	IVECO	Freno	53	1			54,00
960695	2996027	IVECO	Freno	52	1			168,00
960695.1	-	IVECO	Freno	52	1			84,00
960696	2996131	IVECO	Freno	49	1			138,00
960696.1	-	IVECO	Freno	49	1			69,00
960697	2996122	IVECO	Freno	54	1			142,00
960697.1	-	IVECO	Freno	54	1			71,00
960698	2996049	IVECO	Freno	55	1			210,00
960698.1	-	IVECO	Freno	55	1			105,00
960700	93161848	IVECO	Freno	226	1			36,50
960702	68321484	RENAULT	Freno	145	1			68,00
960703	93162193	IVECO	Freno	226	1			35,00
960705	93161976	IVECO	Freno	234	1			16,00
960706	93161977	IVECO	Freno	234	1			45,00
960707	93162050	IVECO	Freno	234	1			80,00
960708	42538002	IVECO	Freno	235	1			120,00
960709	42541413	IVECO	Freno	235	1			86,00
960710	42541412	IVECO	Freno	235	1			135,00
960711	42530519	IVECO	Freno	236	1			38,00
960712	42530520	IVECO	Freno	236	1			98,00
960713	93156966	IVECO	Freno	227	1			62,00
960714	42548325	IVECO	Freno	227	1			62,00
960715	42548326	IVECO	Freno	227	1			48,00
960716	42555882	IVECO	Freno	227	1			11,00
960717	42555883	IVECO	Freno	227	1			16,00
960718	42555884	IVECO	Freno	228	1			56,00
960719	42555416	IVECO	Freno	228	1			49,00
960720	42555418	IVECO	Freno	228	1			6,60
960721	42555419	IVECO	Freno	228	1			25,00
960722	93193784	IVECO	Freno	231	1			46,00
960723	93193785	IVECO	Freno	231	1			46,00
960724	42541464	IVECO	Freno	231	1			47,00
960725	8124032	IVECO	Freno	231	1			130,00
960732	42072790	IVECO	Varie	224	2			25,00
960733	4691818	IVECO	Varie	261	2			3,50
960801	-	DAF	Freno	6-7-8	1			46,00
960803	81508226014	MAN	Freno	84-90	1			38,00
960805	42536956	IVECO	Freno	65	1			45,00
960806	5010848607/A	RENAULT	Freno	147-153	1			49,00

LISTINO PREZZI IN PROGRESSIONE RIFERIMENTI **EMMERRE**
PRICE LIST IN ORDER OF **EMMERRE** **REFERENCE**

EMMERRE	Rif.Originale Original Ref.	Adattabile a: Adaptable to:	Tipo Cat. Cat. Type	Pagina Page	Qtà/Conf. Q.ty/Pck.	OE	Cat. D	Listino Price L. €
960807	68324072	MAN	Freno	93-95	1			50,00
960808	6775400717	MERCEDES	Freno	118-120	1			32,00
960809	6705400017	MERCEDES	Freno	109-110	1			30,00
960810	6775400817	MERCEDES	Freno	111-114	1			30,00
960811	81508226016	MAN	Freno	91	1			50,00
960813	6015400617	MERCEDES	Freno	107-108	1			28,00
960814	5001822987/A	RENAULT	Freno	157-160	1			23,00
960819	5001850859/A	RENAULT	Freno	137-139	1			8,00
960821	42537941	IVECO	Freno	66-70	1			40,00
960822	81259376012	MAN	Freno	92-95	1			42,00
960824	9065401417	MERCEDES	Freno	104	1		D	10,00
960825	6395401417	MERCEDES	Freno	105-106	1		D	10,00
960828	93161849	IVECO	Freno	226	1			45,00
960829	42530365	IVECO	Freno	223	1			10,00
960830	93161567	IVECO	Freno	224	1			20,00
960832	93161188	IVECO	Freno	224	1			25,50
960833	93162189	IVECO	Freno	224	1			16,00
960834	93161847	IVECO	Freno	224	1			16,80
960835	42535784	IVECO	Freno	225	1			16,80
960836	42535792	IVECO	Freno	225	1			14,50
960837	93162075	IVECO	Freno	232	1			15,00
960838	1388953	SCANIA	Freno	163	1			25,00
960839	2992666	IVECO	Freno	69-80	1			40,00
960840	4819706	IVECO	Freno	356	1			26,00
960841	93162076	IVECO	Freno	232	1			14,50
960842	0005400217	MERCEDES	Freno	107-108	1			4,60
960843	93162043	IVECO	Freno	232	1			15,00
960844	-	IVECO	Freno	355	1			22,00
960845	-	IVECO	Freno	355	1			22,00
960846	8121135	IVECO	Freno	226	1			25,00
960847	93161757	IVECO	Freno	232	1			8,50
960848	93161187	IVECO	Freno	225	1			60,00
960849	93161759	IVECO	Freno	233	1			41,00
960850	93161568	IVECO	Freno	225	1			62,00
960852	42552778	IVECO	Freno	64	1			22,00
960855	8528686	IVECO	Freno	355	1			15,00
960856	-	IVECO	Freno	356	1			28,50
960857	7170420	IVECO	Freno	356	1			26,00
960858	8547781	IVECO	Freno	356	1			98,00
960859	4851782	IVECO	Freno	355	1			26,00
960860	93192155	IVECO	Freno	355	1			30,00
960861	9927529	IVECO	Freno	397	1			35,00
960862	9945070	FIAT	Freno	13-14	1			55,00
960863	42548196	IVECO	Freno	40-41	1			18,50
960864	42548195	IVECO	Freno	39-54	1			15,00
960866	9927555	IVECO	Freno	397	2			1,50
960867	9945076	FIAT	Freno	13-14	1			60,00
960868	6965579	FORD	Freno	25-26	1			39,00
960869	6197739	FORD	Freno	25-26	1			39,00
960870	1135167	FORD	Freno	27	1			55,00
960871	4077636	FORD	Freno	28	1			55,00
960872	-06903100-0	NISSAN	Freno	121-122	1			56,00
960873	-06905320-0	NISSAN	Freno	350	1			50,00
960874	410609X226	NISSAN	Freno	123	1			70,00
960875	410609X126	NISSAN	Freno	124-126	1			35,00
960876	42530912	IVECO	Freno	37-38	1		D	12,00

LISTINO PREZZI IN PROGRESSIONE RIFERIMENTI EMMERRE
PRICE LIST IN ORDER OF EMMERRE REFERENCE

	Rif.Originale Original Ref.	Adattabile a: Adaptable to:	Tipo Cat. Cat. Type	Pagina Page	Qtà/Conf. Q.ty/Pck.	OE	Cat. D	Listino Price L. €
960877	1908825	IVECO	Freno	59-61	1			12,00
960878	1908231	IVECO	Freno	62-72	1			17,00
960879	1908407	IVECO	Freno	39-61	1			13,00
960879	42548208	IVECO	Freno	39-61	1			13,00
960880	1907956	IVECO	Freno	62-72	1			16,50
960881	1906468	IVECO	Freno	65	1			27,50
960883	8124925	IVECO	Freno	285	1			8,00
960884	8124928	IVECO	Freno	285	1			8,00
960886	42532204	IVECO	Freno	81	1			19,00
960887	42539438	IVECO	Freno	81	1			24,00
960888	1906462	IVECO	Freno	59-61	1			14,00
960889	1902317	IVECO	Freno	223	1			9,00
960890	0054205220	MERCEDES	Freno	104-105	1			62,00
960892	1906207	IVECO	Freno	36	1			32,00
960893	1906206	IVECO	Freno	36	1			32,00
960894	1906159	IVECO	Freno	35	1			33,00
960895	42555633	IVECO	Freno	55	1			150,00
960896	0044208120	MERCEDES	Freno	106	1			62,00
960897	1906353	IVECO	Freno	64	1			150,00
960898	1906157	IVECO	Freno	35	1			32,00
960899	42535791	IVECO	Freno	47	1			35,00
960900	1906040	IVECO	Freno	37	1			38,00
960901	2995552	IVECO BUS	Freno	178-179	1			300,00
960902	1906043	IVECO	Freno	60	1			62,00
960903	1906070	IVECO	Freno	56	1			67,00
960904	1906345	IVECO	Freno	56	1			63,00
960905	42530550	IVECO	Freno	82	1			24,00
960907	42530551	IVECO	Freno	82	1			2,80
960908	1903651	IVECO	Freno	72-80	1			56,00
960909	1906401	IVECO	Freno	42	1			35,00
960910	42470835	IVECO	Freno	39	1			38,50
960911	42470841	IVECO	Freno	40-41	1			38,00
960912	1906416	IVECO	Freno	58	1			59,00
960913	1906158	IVECO	Freno	34	1			32,00
960914	3565400017	MERCEDES BUS	Freno	181	1			10,00
960915	9015400017	MERCEDES	Freno	97-103	1			6,80
960916	6695400417	MERCEDES	Freno	109-110	1			7,00
960917	5000297198/A	RENAULT	Freno	156	1			9,00
960918	68320909	RENAULT	Freno	142-144	1			28,00
960919	5001822897	RENAULT	Freno	140-141	1			19,00
960920	0004237110	MERCEDES	Freno	99-100	1			52,00
960921	0024203920	MERCEDES	Freno	97-99	1			52,00
960922	0024204020	MERCEDES	Freno	101-103	1			46,00
960923	42470836	IVECO	Freno	39	1			80,00
960923.1	-	IVECO	Freno	39	1			40,00
960924	2991646	IVECO	Freno	40	1			74,00
960924.1	-	IVECO	Freno	40	1			37,00
960925	2994066	IVECO	Freno	41	1			74,00
960925.1	-	IVECO	Freno	41	1			37,00
960926	0024204820	MERCEDES	Freno	98	1			35,00
960927	2761476	VOLVO	Freno	164-168	1			78,00
960928	MDP5076	ROR	Freno	199-200	1			140,00
960929	77362212	FIAT	Freno	15-18	1			45,00
960930	1902316	IVECO	Freno	223	1			8,20
960931	4823690	IVECO BUS	Freno	175-177	1			18,50
960932	1907942	IVECO	Freno	57-61	1			16,00

LISTINO PREZZI IN PROGRESSIONE RIFERIMENTI 
PRICE LIST IN ORDER OF  **REFERENCE**

	Rif.Originale Original Ref.	Adattabile a: Adaptable to:	Tipo Cat. Cat. Type	Pagina Page	Qtà/Conf. Q.ty/Pck.	OE	Cat. D	Listino Price L. €
960933	5001834075/A	RENAULT	Freno	157	1			28,00
960935	9945810	FIAT	Freno	15-18	1			45,00
960935	9948629	FIAT	Freno	15-18	1			45,00
960937	1906459	IVECO	Freno	71	1			120,00
960937	2992479	IVECO	Freno	71	1			120,00
960938	1906170	IVECO	Freno	62-63	1			98,00
960939	1906297	IVECO	Freno	57-60	1			65,00
960940	1906183	IVECO	Freno	38	1			46,00
960941	1906243	IVECO	Freno	37	1			38,00
960942	BBU8177	DAF	Freno	3-4	1			77,00
960943	AMPA694	DAF	Freno	5	1			160,00
960944	449437	SMB	Freno	215	1			135,00
960944	1390428	SCANIA	Freno	162	1			135,00
960944	1439324	DAF	Freno	11	1			135,00
960944	3057007700	SAF	Freno	208-210	1			135,00
960944	-	ASSALI MERCEDES	Freno	196	1			135,00
960944	-	LECINENA	Freno	197-198	1			135,00
960944	0034201620	MERCEDES	Freno	117-119	1			135,00
960944	09.801.06.96.0	BPW	Freno	192-193	1			135,00
960944	1906439	IVECO	Freno	73-75	1			135,00
960944/C	-	ASSALI MERCEDES	Freno	196	1			145,00
960944/C	-	BPW	Freno	192-193	1			145,00
960944/C	-	DAF	Freno	11	1			145,00
960944/C	-	IVECO	Freno	74-76	1			145,00
960944/C	-	LECINENA	Freno	197-198	1			145,00
960944/C	-	MERCEDES	Freno	118-120	1			145,00
960944/C	-	SAF	Freno	208-210	1			145,00
960944/C	-	SCANIA	Freno	162	1			145,00
960944/C	-	SMB	Freno	215	1			145,00
960945	1440504	DAF	Freno	9-10	1			165,00
960946	6704202820	MERCEDES	Freno	109-110	1			70,00
960947	-06902964-0	NISSAN	Freno	127-131	1			78,00
960948	449412	SMB	Freno	214	1			130,00
960948	3057007800	SAF	Freno	205-207	1			130,00
960948	81508206022	MAN	Freno	91	1			130,00
960948	0024207820	MERCEDES	Freno	115-116	1			130,00
960948	09.801.02.93.0	BPW	Freno	185-189	1			130,00
960948/C	-	BPW	Freno	185-189	1			140,00
960948/C	-	MAN	Freno	91	1			140,00
960948/C	-	MERCEDES	Freno	115-116	1			140,00
960948/C	-	SAF	Freno	205-207	1			140,00
960948/C	-	SMB	Freno	214	1			140,00
960949	3057317900	SAF	Freno	209-211	1			145,00
960950	1906118	IVECO BUS	Freno	180	1			165,00
960951	42538063	IVECO	Freno	306	1			50,00
960952	42536301	IVECO BUS	Freno	176-177	1			210,00
960955	81508206011	MAN	Freno	83-89	1			75,00
960956	0024200820	MERCEDES BUS	Freno	181	1			120,00
960956	5001823000	RENAULT	Freno	157	1			120,00
960956	81508206014	MAN	Freno	92-93	1			120,00
960957	5000297808	RENAULT	Freno	143	1			80,00
960958	5000294357	RENAULT	Freno	156	1			106,00
960959	5000295329	RENAULT	Freno	140-141	1			56,00
960960	8284000197	KASSBOHRER BUS	Freno	184	1			210,00
960961	8284000209	KASSBOHRER BUS	Freno	183	1			240,00
960963	3090048	VOLVO	Freno	164-168	1			78,00

Copyright della EMMERRE S.r.l. - Settimo Torinese - Tutti i diritti sono riservati e depositati a norma di legge ed a norma delle convenzioni internazionali. - E' vietata la duplicazione o la riproduzione anche parziale senza la previa autorizzazione della EMMERRE S.r.l.

LISTINO PREZZI IN PROGRESSIONE RIFERIMENTI EMMERRE
PRICE LIST IN ORDER OF EMMERRE REFERENCE

	Rif. Originale Original Ref.	Adattabile a: Adaptable to:	Tipo Cat. Cat. Type	Pagina Page	Qtà/Conf. Q.ty/Pck.	OE	Cat. D	Listino Price L. €
960964	3093919	VOLVO BUS	Freno	182	1			160,00
960965	42538064	IVECO	Freno	306	1			45,00
960967	6694210008	MERCEDES	Freno	107-108	1			42,00
960969	1436901	DAF	Freno	6-7-8	1			80,00
960969	1906467	IVECO	Freno	65	1			80,00
960969	81508206020	MAN	Freno	83-89	1			80,00
960970	2992336	IVECO	Freno	66-70	1			120,00
960971	2995637	IVECO	Freno	77-80	1			125,00
960972	5001844748	RENAULT	Freno	137-139	1			50,00
960973	42536101	IVECO	Freno	46	1			49,50
960974	1906427	IVECO	Freno	38	1			56,00
960975	-	KASSBOHRER BUS	Freno	183	1			44,00
960975	-	SCANIA	Freno	163	1			44,00
960976	81508110004	KASSBOHRER BUS	Freno	184	1			15,00
960976	81508110004	MAN	Freno	92	1			15,00
960977	3118128	VOLVO BUS	Freno	182	1			60,00
960977	68321348	RENAULT	Freno	158	1			60,00
960978	-	VOLVO	Freno	164-168	1			5,00
960979	42548209	IVECO	Freno	40-41	1			13,00
960982	5001846034	RENAULT	Freno	158	1			160,00
960983	5001855646	RENAULT	Freno	159-160	1			148,00
960984	81508206041	MAN	Freno	94-95	1			148,00
960985	4403467	OPEL	Freno	133	1			36,00
960985	7701206763	RENAULT	Freno	136	1			36,00
960986	4502797	OPEL	Freno	132	1			39,00
960986	7701207166	RENAULT	Freno	134	1			39,00
960987	5001850859	RENAULT	Freno	137-139	1			49,00
960988	7701207339	RENAULT	Freno	135	1			50,00
960989	5001864363	RENAULT	Freno	161	1			165,00
960990	5001014704	RENAULT	Freno	144	1			65,00
960991	5001857615	RENAULT	Freno	145	1			130,00
960992	2992339	IVECO	Freno	43	1			35,00
960993	3095396	VOLVO	Freno	170-171	1			160,00
960994	09.801.06.43.0	BPW	Freno	190	1			150,00
960994/C	-	BPW	Freno	190	1			160,00
960996	09.801.06.44.0	BPW	Freno	194	1			150,00
960996/C	-	BPW	Freno	194	1			160,00
960997	09.801.06.45.0	BPW	Freno	195	1			150,00
960997/C	-	BPW	Freno	195	1			160,00
960998	81508206043	MAN	Freno	96	1			142,00
960998	0034201120	MERCEDES	Freno	111-114	1			142,00
960999	3057008000	SAF	Freno	206-207	1			120,00
960999/C	-	SAF	Freno	240	1			20,00
961000	9945884	FIAT	Freno	348	1			48,00
961001	-	MAN-RENAULT - ROR	Freno	253	1			APPR.
961002	3090997	VOLVO	Freno	253	1			65,00
961003	3090998	VOLVO	Freno	253	1			65,00
961008	1906128	IVECO	Freno	295	1			385,00
961009	1906350	IVECO	Freno	283	1			41,00
961010	1906403	IVECO	Freno	289	1			46,00
961011	1906351	IVECO	Freno	283	1			55,00
961012	9945885	FIAT	Freno	348	1			48,00
961013	1906032	IVECO	Freno	314	1			250,00
961015	42555669	IVECO	Freno	54	1			65,00
961018	1906352	IVECO	Freno	283	1			48,00
961031	1906347	IVECO	Freno	395	1			150,00

LISTINO PREZZI IN PROGRESSIONE RIFERIMENTI EMMERRE
PRICE LIST IN ORDER OF EMMERRE REFERENCE

	Rif.Originale Original Ref.	Adattabile a: Adaptable to:	Tipo Cat. Cat. Type	Pagina Page	Qtà/Conf. Q.ty/Pck.	OE	Cat. D	Listino Price L. €
961040	1906377	IVECO	Freno	284	1			168,00
961042	-	IVECO	Freno	283	1			56,00
961043	93161954	IVECO	Freno	306	1			36,50
961044	-	FIAT	Freno	348	1			25,00
961045	42536259	IVECO	Freno	291	1			10,00
961046	93161851	IVECO	Freno	291	1			12,50
961047	93161852	IVECO	Freno	291	1			10,00
961050	77363479	FIAT	Freno	348	1			60,00
961055	-	IVECO	Freno	314	1			32,00
961056	-	IVECO	Freno	295	1			40,00
961057	9566949580	FIAT	Freno	348	1			45,00
961058	6579150	FORD	Freno	349	1			35,00
961059	6733350	FORD	Freno	349	1			35,00
961060	7125122	FORD	Freno	349	1			35,00
961061	92VB2200BA	FORD	Freno	349	1			35,00
961062	-	FORD	Freno	349	1			67,00
961523	8124934	IVECO	Freno	286	1			22,00
962000	7180039	IVECO	Freno	260	1			8,50
962042	2969248	IVECO	Freno	397	2			4,00
962046	9925639	IVECO	Freno	397	10			2,00
962050	4572054	IVECO	Freno	397	2			2,00
962054	9927561	IVECO	Freno	397	2			4,00
962075	99436612	IVECO	Freno	282	1			300,00
962076	99436613	IVECO	Freno	282	1			300,00
962093	-	IVECO	Freno	287	1			155,00
962094	-	IVECO	Freno	287	1			155,00
962095	-	IVECO	Freno	287	1			158,00
962096	-	IVECO	Freno	287	1			158,00
962098	5010098945	RENAULT	Freno	398	2			16,50
962099	5010097340	RENAULT	Freno	398	2			13,70
962100	5010097089	RENAULT	Freno	398	2			10,00
962501	42064491	IVECO	Freno	345	1			19,50
962504	4756032	IVECO	Freno	345	1			8,50
962505	93163852	IVECO	Freno	345	1			19,50
962543	-	MERCEDES	Freno	350	1			54,50
962544	113602P	MERCEDES	Freno	350	1			39,50
963001	42491950	IVECO	Freno	302-316	1			98,50
963002	8124031	IVECO	Freno	299	1			17,00
963003	8124815	IVECO	Freno	299	1			89,00
963004	42488208	IVECO	Freno	344	1			26,50
963005	42480059	IVECO	Freno	301-315	2			10,00
963006	42480058	IVECO	Freno	301-315	2			9,00
963007	42480060	IVECO	Freno	301-316	2			15,00
963009	42531676	IVECO	Freno	324	2			22,00
963010	42480056	IVECO	Freno	305-319	4			3,00
963011	42488736	IVECO	Freno	305-319	10			3,00
963012	42488737	IVECO	Freno	305-319	10			3,00
963013	41817599	IVECO	Freno	304-319	1			3,00
963014	7984216	IVECO	Freno	309-320	1			19,00
963015	7984217	IVECO	Freno	309-320	1			19,00
963016	42488484	IVECO	Freno	309-320	4			3,70
963017	42480062	IVECO	Freno	309-320	2			19,50
963019	93161254	IVECO	Freno	296-311	1			70,00
963020	42491974	IVECO	Freno	304-318	2			30,00
963021	8124814	IVECO	Freno	298	1			105,00
963022	7980405	IVECO	Freno	303-317	1			55,00

Copyright della EMMERRE S.r.l. - Settimo Torinese - Tutti i diritti sono riservati e depositati a norma di legge ed a norma delle convenzioni internazionali. - E' vietata la duplicazione o la riproduzione anche parziale senza la previa autorizzazione della EMMERRE S.r.l.

LISTINO PREZZI IN PROGRESSIONE RIFERIMENTI EMMERRE
PRICE LIST IN ORDER OF EMMERRE REFERENCE

	Rif. Originale Original Ref.	Adattabile a: Adaptable to:	Tipo Cat. Cat. Type	Pagina Page	Qtà/Conf. Q.ty/Pck.	OE	Cat. D	Listino Price L. €
963023	7980406	IVECO	Freno	303-317	1			55,00
963024	7980407	IVECO	Freno	302-316	1			52,00
963025	7980408	IVECO	Freno	303-318	1			36,00
963026	7980687	IVECO	Freno	304-318	2			18,00
963027	42536176	IVECO	Freno	308-327	1			7,00
963028	42063178	IVECO	Freno	345	2			23,00
963029	-	IVECO	Freno	345	2			23,00
963056	500300093	IVECO	Freno	282	1			125,00
963057	500300092	IVECO	Freno	282	1			125,00
963068	42101964	IVECO	Freno	313	1			465,00
963069	42101963	IVECO	Freno	313	1			465,00
963084	-	IVECO	Freno	285	1			47,50
963085	-	IVECO	Freno	285	1			47,50
963086	500300073	IVECO	Freno	282	1			115,00
963087	500300075	IVECO	Freno	282	1			115,00
963088	93161123	IVECO	Freno	286	1			13,00
963089	93161124	IVECO	Freno	286	1			13,00
963090	5010145932	RENAULT	Freno	346	1			150,00
963091	5010145933	RENAULT	Freno	346	1			150,00
963092	5010145930	RENAULT	Freno	346	1			150,00
963093	5010145931	RENAULT	Freno	346	1			150,00
963096	5001829350	RENAULT	Freno	346	1			160,00
963097	500300080	IVECO	Freno	282	1			119,00
963098	500300079	IVECO	Freno	282	1			119,00
963099	-	IVECO	Freno	286	1			5,50
963100	8124924	IVECO	Freno	285	1			17,00
963101	8124927	IVECO	Freno	285	1			17,00
963106	42480411	IVECO	Freno	315	1			250,00
963110	4815279	IVECO	Freno	293	1			495,00
963111	4815280	IVECO	Freno	293	1			495,00
963116	-	IVECO	Freno	285	1			13,00
963117	-	IVECO	Freno	285	1			13,00
963456	41022772	IVECO	Freno	321	1			520,00
963457	41022771	IVECO	Freno	321	1			520,00
963500	159040	ASTRA	Freno	281	1	OE	D	670,00
963501	159038	ASTRA	Freno	281	1	OE	D	670,00
963502	-	ASTRA	Freno	281	1	OE	D	895,00
963503	-	ASTRA	Freno	281	1	OE	D	895,00
963518	42550957	IVECO	Freno	340	1			42,00
963520	-	IVECO	Freno	323	1			55,00
963521	-	IVECO	Freno	323	1			55,00
963522	-	IVECO	Freno	330	1		D	60,00
963525	42530368	IVECO	Freno	292	1			20,00
963526	1906361	IVECO	Freno	310	1			360,00
963529	1906404	IVECO	Freno	323	1			380,00
963531	1906410	IVECO	Freno	324	1			390,00
963532	93192915	IVECO	Freno	324	1			280,00
963533	93162114	IVECO	Freno	325	1			165,00
963534	93161623	IVECO	Freno	325	1			82,00
963535	93161625	IVECO	Freno	326	1			18,00
963536	93161621	IVECO	Freno	325	1			75,00
963537	93161863	IVECO	Freno	327	1			39,00
963538	93161864	IVECO	Freno	327	1			39,00
963539	93162113	IVECO	Freno	327	1			28,00
963540	93161626	IVECO	Freno	339-344	1			20,00
963541	42531677	IVECO	Freno	326	10			4,20

LISTINO PREZZI IN PROGRESSIONE RIFERIMENTI EMMERRE
PRICE LIST IN ORDER OF EMMERRE REFERENCE

	Rif.Originale Original Ref.	Adattabile a: Adaptable to:	Tipo Cat. Cat. Type	Pagina Page	Qtà/Conf. Q.ty/Pck.	OE	Cat. D	Listino Price L. €
963545	1906354	IVECO	Freno	310	1			280,00
963547	93161353	IVECO	Freno	302-317	1			52,00
963548	93161256	IVECO	Freno	332	1			85,00
963549	1908484	IVECO	Freno	295	1	OE	D	650,00
963550	1908485	IVECO	Freno	295	1	OE	D	650,00
963551	41022773	IVECO	Freno	322	1			585,00
963552	41022774	IVECO	Freno	322	1			585,00
963553	93161768	IVECO	Freno	332	1			110,00
963554	93161267	IVECO	Freno	297-312	1			100,00
963555	93161872	IVECO	Freno	333	1			37,00
963556	93161260	IVECO	Freno	333	1			36,00
963557	41025289	IVECO	Freno	329	1	OE	D	700,00
963558	41025290	IVECO	Freno	329	1	OE	D	700,00
963559	2991759	IVECO	Freno	330	1			460,00
963560	42536192	IVECO	Freno	340-344	1			24,00
963561	93811175	IVECO	Sterzo	118	1			335,00
963562	93811176	IVECO	Sterzo	118	1			335,00
963563	93812733	IVECO	Sterzo	118	1			340,00
963564	93812734	IVECO	Sterzo	118	1			340,00
963565	93810228	IVECO	Sterzo	118	1			294,00
963566	93810229	IVECO	Sterzo	118	1			294,00
963567	60170737	IVECO	Sterzo	118	1		D	405,00
963568	60170736	IVECO	Sterzo	118	1		D	405,00
963569	42537366	IVECO	Freno	337-342	1			130,00
963570	41211321	IVECO	Freno	335	1	OE		1.100,00
963571	41211322	IVECO	Freno	335	1	OE		1.100,00
963572	41211318	IVECO	Freno	334	1	OE	D	895,00
963573	41211319	IVECO	Freno	334	1	OE	D	895,00
963574	42537884	IVECO	Freno	338-343	1			45,00
963575	42537758	IVECO	Freno	339-343	1			28,00
963576	42537841	IVECO	Freno	339-343	10			7,50
963584	8550977	VOLVO	Freno	353	1			140,00
963585	8550978	VOLVO	Freno	353	1			140,00
963586	276097	VOLVO	Freno	353	1			6,90
963587	276098	VOLVO	Freno	353	1			6,90
963588	272906	VOLVO	Freno	353	1			38,00
963589	272907	VOLVO	Freno	354	1			38,00
963590	2992375	IVECO	Freno	336	1			690,00
963591	2992378	IVECO	Freno	336	1			699,00
963593	42536194	IVECO	Freno	338-342	1			75,00
963594	42536197	IVECO	Freno	337-341	1			165,00
963595	42537365	IVECO	Freno	337-341	1			130,00
963596	42536195	IVECO	Freno	338-342	1			82,00
963597	-	IVECO	Freno	292	1			20,00
963598	42535860	IVECO	Freno	292	1			28,00
963599	93161257	IVECO	Freno	296-311	1			14,00
963601	1696450	VOLVO	Freno	351	1			2,00
963602	272905	VOLVO	Freno	351	1			12,00
963604	3090954	VOLVO	Freno	351	1			6,00
963605	272904	VOLVO	Freno	351	1			8,00
963606	272910	VOLVO	Freno	351	1			34,00
963607	1696446	VOLVO	Freno	352	1			6,00
963608	3097299	VOLVO	Freno	352	1			8,00
963609	3097092	VOLVO	Freno	352	1			24,00
963610	1696924	VOLVO	Freno	352	1			39,50
963611	1696925	VOLVO	Freno	352	1			39,50

LISTINO PREZZI IN PROGRESSIONE RIFERIMENTI EMMERRE
PRICE LIST IN ORDER OF EMMERRE REFERENCE

	Rif.Originale Original Ref.	Adattabile a: Adaptable to:	Tipo Cat. Cat. Type	Pagina Page	Qtà/Conf. Q.ty/Pck.	OE	Cat. D	Listino Price L. €
963612	3090964	VOLVO	Freno	354	1			36,00
963613	1698967	VOLVO	Freno	354	1			2,15
963614	2992530	IVECO	Freno	310	1			550,00
963615	2991755	IVECO	Freno	331	1		D	510,00
963616	-	IVECO	Freno	293	1			240,00
963617	-	IVECO	Freno	294	1			280,00
963618	42535859	IVECO	Freno	292	1			23,50
963620	8121441	IVECO	Freno	333	1			4,20
963621	500315608	IVECO	Sterzo	121	1			120,00
963622	93161268	IVECO	Freno	296-311	1			80,00
963900	500381595	IVECO	Freno	300	1	OE	D	650,00
963901	500381596	IVECO	Freno	300	1	OE	D	650,00
963902	41025287	IVECO	Freno	328	1	OE	D	600,00
963903	41025288	IVECO	Freno	328	1	OE	D	600,00
963907	98464849	IVECO	Freno	300	1	OE	D	800,00
963908	98464850	IVECO	Freno	300	1	OE	D	800,00
964002	4277619	IVECO	Freno	411	1			57,00
964003	-	IVECO	Freno	411	1			65,00
964004	-	IVECO	Freno	410	1			80,00
964005	4797844	IVECO	Freno	411	1			60,00
964006	4765078	IVECO	Freno	412	1			54,00
964007	4804131	IVECO	Freno	412	1			58,00
964008	4762814	IVECO	Freno	412	1			60,00
964009	4797843	IVECO	Freno	411	1			62,50
964011	4844302	IVECO	Freno	411	1			255,00
964013	9989017	IVECO	Freno	410	1			53,00
964016	4804132	IVECO	Freno	412	1			56,00
964017	4804129	IVECO	Freno	412	1			52,00
964019	9946799	FIAT	Freno	405	1			98,00
964022	9945895	FIAT	Freno	405	1			45,00
964023	9946056	FIAT	Freno	405	1			98,00
964026	6464705	FORD	Freno	406	1			33,00
964031	-	IVECO	Freno	410	1			60,00
964032	-	IVECO	Freno	410	1			60,00
964033	2991745	IVECO	Freno	410	1			80,00
964034	500357840	IVECO	Freno	417	1			70,00
964035	4817854	IVECO	Freno	413	1			64,00
964045	-	IVECO	Freno	288	1			447,50
964046	-	IVECO	Freno	288	1			422,00
964201	8121575	IVECO	Freno	407	1			12,00
964202	8121576	IVECO	Freno	407	1			12,00
964203	93160540	IVECO	Freno	407	1			16,00
964204	98452387	IVECO	Freno	407	1			18,00
964205	4122369	IVECO	Freno	408	1			15,00
964209	4276036	IVECO	Freno	408	1			15,00
964210	4220639	IVECO	Freno	408	1			12,50
964211	93155720	IVECO	Freno	407	1			31,00
964212	4220641	IVECO	Freno	408	1			20,00
964213	93155721	IVECO	Freno	409	1			37,00
964214	4712856	IVECO	Freno	408	1			11,00
964215	9987624	IVECO	Freno	297	2			17,00
964216	93155722	IVECO	Freno	409	1			100,00
964217	4220643	IVECO	Freno	408	1			12,90
964218	42488219	IVECO	Freno	298	2			4,30
964219	-	IVECO	Freno	297	2			60,00
964220	4744164	IVECO	Freno	409	1			18,50

LISTINO PREZZI IN PROGRESSIONE RIFERIMENTI EMMERRE
PRICE LIST IN ORDER OF EMMERRE REFERENCE

	Rif.Originale Original Ref.	Adattabile a: Adaptable to:	Tipo Cat. Cat. Type	Pagina Page	Qtà/Conf. Q.ty/Pck.	OE	Cat. D	Listino Price L. €
964221	42488213	IVECO	Freno	298	2			19,50
964222	-06902174-0	NISSAN	Freno	414	1			26,00
964223	-06902317-0	NISSAN	Freno	414	1			26,00
964229	4067826	IVECO	Freno	409	1			46,00
964232	77.01.034.172	RENAULT	Freno	415	1			28,00
964233	77.01.030.155	RENAULT	Freno	415	1			29,00
964234	4212449	IVECO	Freno	409	1			48,00
964235	4294681	IVECO	Freno	409	1			47,00
964401	4792417	IVECO	Freno	413	1			23,00
964402	4792418	IVECO	Freno	413	1			26,00
964404	2991743	IVECO	Freno	410	1			80,00
965030	4819657	IVECO	Freno	294	1			550,00
965031	4819658	IVECO	Freno	294	1			550,00
965055	-	IVECO	Freno	223	1			15,00
965056	99464101	IVECO	Freno	219	1			175,00
965057	99464100	IVECO	Freno	219	1			175,00
970003	-	VARI	Varie	272	1			850,00
970004	-	VARI	Varie	221	1			135,00
970005	-	VARI	Varie	272	1			1.350,00
970006	20568711	VOLVO	Freno	172-173	1			165,00
970007	MDP5073	ROR	Freno	204	1			148,00
970008	-	VARI	Varie	271	1			850,00
970009	-	VARI	Varie	271	1			1.350,00
970100	5001860144	RENAULT	Freno	347	1			40,00
970101	2992568	IVECO	Freno	290	1			47,00
970102	42535858	IVECO	Freno	290	1			63,00
970103	504060927	IVECO	Freno	289	1			88,00
970104	504060926	IVECO	Freno	289	1			88,00
970120	2995817	IVECO	Freno	290	1			47,00
970131	504093276	IVECO	Freno	289	1			140,00
970132	504093277	IVECO	Freno	289	1			140,00
970801	-	IVECO	Varie	213	2			7,00
970802	-	IVECO	Varie	213	2			7,00
970803	-	IVECO	Varie	213	2			7,00
970804	-	IVECO	Varie	213	2			7,90
970805	-	IVECO	Varie	213	2			7,90
970806	-	IVECO	Varie	213	2			8,50
970807	-	IVECO	Varie	213	2			8,80
970808	-	IVECO	Varie	213	2			7,00
970809	-	IVECO	Varie	213	2			7,00
970810	-	IVECO	Varie	213	2			7,00
970811	-	IVECO	Varie	213	2			7,00
970812	-	IVECO	Varie	213	2			8,80
970915	99484322	VARI	Varie	203	2			4,70
970916	4755126	VARI	Varie	203	2			5,50
970920	4686377	VARI	Varie	206	1			30,00
970921	500316868	IVECO	Varie	210	1	OE	D	82,00
970922	4797320	IVECO	Varie	210	1			28,00
970923	98439683	IVECO	Varie	210	1			60,00
970924	42545573	IVECO	Varie	210	1	OE	D	68,00
970925	42545831	IVECO	Varie	211	1	OE	D	108,00
970926	8124210	IVECO	Varie	210	1			17,00
970928	504030790	IVECO	Varie	211	1		D	115,00
970929	500316676	IVECO	Varie	211	1			148,00
970931	504082414	IVECO	Varie	211	1			285,00
970932	2447010033	IVECO	Varie	212	1			19,00

Copyright della EMMERRE S.r.l. - Settimo Torinese - Tutti i diritti sono riservati e depositati a norma di legge ed a norma delle convenzioni internazionali. - E' vietata la duplicazione o la riproduzione anche parziale senza la previa autorizzazione della EMMERRE S.r.l.

LISTINO PREZZI IN PROGRESSIONE RIFERIMENTI EMMERRE
PRICE LIST IN ORDER OF EMMERRE REFERENCE

	Rif.Originale Original Ref.	Adattabile a: Adaptable to:	Tipo Cat. Cat. Type	Pagina Page	Qtà/Conf. Q.ty/Pck.	OE	Cat. D	Listino Price L. €
970940	500316868/A	IVECO	Varie	210	1			75,00
971054	79098373	IVECO	Varie	73	1			160,00
971101	4589336	IVECO	Varie	195	2			29,00
971102	4597836	IVECO	Varie	195	2			25,00
971103	4722029	IVECO	Varie	195	2			25,00
971104	4766191	IVECO	Varie	195	2			32,00
971106	4785531	IVECO	Varie	195	2			30,00
971107	-	IVECO	Varie	195	2			42,00
971109	4788907	IVECO	Varie	195	2			60,00
971111	99447552	IVECO	Varie	200	2			53,00
971301	41800543	VARI	Varie	201	1			24,00
971303	4633471	VARI	Varie	201	1			23,00
971304	8150400/R	VARI	Varie	202	1			29,00
971305	4644217	VARI	Varie	201	1			23,00
971307	8150400/G	VARI	Varie	202	1			29,00
971308	647998/R	VARI	Varie	202	1			29,00
971309	647998/G	VARI	Varie	202	1			29,00
971310	504065617	VARI	Varie	201	1			55,00
971311	-	VARI	Varie	201	1			158,00
971312	-	VARI	Varie	203	1			55,00
971313	500302665	VARI	Varie	203	1			120,00
971314	-	VARI	Varie	203	1			130,00
971315	-	VARI	Varie	204	2			13,00
971316	-	VARI	Varie	204	2			8,50
971317	-	VARI	Varie	204	2			13,00
971318	-	VARI	Varie	204	2			8,50
971319	-	VARI	Varie	203	10			1,45
971320	-	VARI	Varie	205	2			29,00
971321	-	VARI	Varie	205	2			17,00
971323	-	VARI	Varie	205	2			29,00
971324	-	VARI	Varie	205	2			17,00
971325	-	VARI	Varie	206	2			12,00
971326	-	VARI	Varie	206	2			29,00
972002	4688352	IVECO	Varie	101-195	2			4,00
972013	4656174	IVECO	Varie	101-196	2			10,00
972015	4729612	IVECO	Varie	196	2			14,00
972016	8817406	IVECO	Varie	101-196	2			11,00
972078	42106884	IVECO	Freno	400	2			25,00
972079	98409528	IVECO	Freno	401	2			16,00
972082	4722497	IVECO	Freno	400	2			18,00
972085	4722637	IVECO	Freno	400	2			23,00
972093	4742729	IVECO	Freno	400	2			25,00
972104	93822393	IVECO	Freno	399	2			9,00
972105	8796958	IVECO	Freno	399	2			16,00
972106	8796885	IVECO	Freno	399	2			16,00
972107	93822492	IVECO	Freno	399	2			11,00
972112	2486068	IVECO	Varie	198	1			18,00
972113	42051434	IVECO	Varie	198	1			44,00
972255	81432206129	MAN	Sterzo	47	1		D	150,00
972256	81432206052	MAN	Sterzo	48	1			245,00
972257	81432206236	MAN	Sterzo	49	1			245,00
972500	0267743	DAF	Sterzo	9	1			250,00
972501	513757	DAF	Sterzo	9	1			60,00
972502	42041107	IVECO	Sterzo	36	1			250,00
972503	93192618	IVECO	Sterzo	36	1			54,00
972504	041110000	MERCEDES	Sterzo	70	1		D	400,00

LISTINO PREZZI IN PROGRESSIONE RIFERIMENTI 
PRICE LIST IN ORDER OF  **REFERENCE**

	Rif.Originale Original Ref.	Adattabile a: Adaptable to:	Tipo Cat. Cat. Type	Pagina Page	Qtà/Conf. Q.ty/Pck.	OE	Cat. D	Listino Price L. €
972505	4716799	IVECO	Sterzo	32	1			495,00
972506	4716271	IVECO	Sterzo	33	1			487,00
972507	98472871	IVECO	Sterzo	37	1			250,00
972508	81432706078	MAN	Sterzo	45	1			590,00
972509	81432206140	MAN	Sterzo	46	1			305,00
972510	81467106852	MAN	Sterzo	46	1			190,00
972511	1080690	VOLVO	Sterzo	100	1			680,00
972512	41028598	IVECO	Sterzo	34	1			472,00
972512	41034479	IVECO	Sterzo	34	1			472,00
972512	41042050	IVECO	Sterzo	34	1			472,00
972513	98472468	IVECO	Sterzo	31	1			490,00
972513	504064007	IVECO	Sterzo	31	1			490,00
972514	9483500405	MERCEDES	Sterzo	69	1			560,00
972515	99458576	IVECO	Sterzo	32	1			200,00
972516	9843502305	MERCEDES	Sterzo	70	1			625,00
972517	81466106348	MAN	Sterzo	42	1			180,00
972518	0003500405	MERCEDES	Sterzo	68	1			68,00
972519	0003502305	MERCEDES	Sterzo	69	1			68,00
972520	0003502205	MERCEDES	Sterzo	69	1			60,00
972521	273706	VOLVO	Sterzo	100	1			56,00
972521	696320	DAF	Sterzo	8	1			56,00
972521	81953016132	MAN	Sterzo	45	1			56,00
972524	0003502005	MERCEDES	Sterzo	70	1			60,00
972525	6583500005	MERCEDES	Sterzo	68	1			700,00
972526	81432709056	MAN	Sterzo	45	1			640,00
972527	9453300007	MERCEDES	Sterzo	71	1			250,00
972531	4714134	IVECO	Sterzo	32	1			200,00
972532	42125057	IVECO	Sterzo	34	1			230,00
972533	41035951	IVECO	Sterzo	31	1			210,00
972535	6583500206	MERCEDES	Sterzo	71	1			224,00
972539	81432306037	MAN	Sterzo	47	1			240,00
972540	81432306043	MAN	Sterzo	47	1			65,00
972541	41034330	IVECO	Sterzo	35	1			230,00
972542	41011006	IVECO	Sterzo	37	1			280,00
972543	3953201432	MERCEDES	Sterzo	72	1			250,00
972545	3433201832	MERCEDES	Sterzo	74	1			220,00
972547	93192361	IVECO	Sterzo	31-36	1			48,00
972547	81432306061	MAN	Sterzo	48	1			48,00
972547	0003300207	MERCEDES	Sterzo	75	1			48,00
972547	67354	DAF	Sterzo	9	1			48,00
972548	9483501305	MERCEDES	Sterzo	75	1			230,00
972549	273375	VOLVO	Sterzo	100	1			64,00
972549	81953016133	MAN	Sterzo	46	1			64,00
972550	274068	VOLVO	Sterzo	101	1			55,00
972550	691703	DAF	Sterzo	9	1			55,00
972550	0003500613	MERCEDES	Sterzo	74	1			55,00
972551	41042093	IVECO	Sterzo	35	1			575,00
972552	98454109	IVECO	Sterzo	35	1			670,00
972553	93162239	IVECO	Sterzo	35	1			55,00
972556	81432206285	MAN	Sterzo	46	1			120,00
972560	3435860032	MERCEDES	Sterzo	73	1			60,00
972567	93161960	IVECO	Sterzo	34	1			46,00
972568	93161958	IVECO	Sterzo	31-34	1			55,00
972569	3175769	VOLVO	Sterzo	101-102	1			60,00
972570	1598588	VOLVO	Sterzo	101	1			55,00
972571	1368270	DAF	Sterzo	8	1			600,00

LISTINO PREZZI IN PROGRESSIONE RIFERIMENTI EMMERRE
PRICE LIST IN ORDER OF EMMERRE REFERENCE

	Rif.Originale Original Ref.	Adattabile a: Adaptable to:	Tipo Cat. Cat. Type	Pagina Page	Qtà/Conf. Q.ty/Pck.	OE	Cat. D	Listino Price L. €
972572	1628107	VOLVO	Sterzo	102	1			60,00
972573	693778	DAF	Sterzo	8	1			60,00
972573	0005861433	MERCEDES	Sterzo	68-72	1			60,00
972574	20556586	VOLVO	Sterzo	101	1			880,00
972575	20556490	VOLVO	Sterzo	102	1			800,00
972576	689749	DAF	Sterzo	9	1			50,00
972576	42488722	IVECO	Sterzo	33	1			50,00
972576	81432206055	MAN	Sterzo	48	1			50,00
972577	3953200132	MERCEDES	Sterzo	72	1			200,00
972578	3953201532	MERCEDES	Sterzo	72	1			225,00
972579	6593503406	MERCEDES	Sterzo	72	1			248,00
972580	42493431	IVECO	Sterzo	33-37	1			55,00
972580	81432706040	MAN	Sterzo	48	1			55,00
972580	0003500413	MERCEDES	Sterzo	73	1			55,00
972581	3433201732	MERCEDES	Sterzo	73	1			205,00
972582	6553500306	MERCEDES	Sterzo	73	1		D	200,00
972583	6523500306	MERCEDES	Sterzo	74	1		D	250,00
972584	3523500306	MERCEDES	Sterzo	75	1			210,00
972590	1607079	VOLVO	Sterzo	102	1			250,00
972591	274019	VOLVO	Sterzo	102	1			60,00
973010	42070618	IVECO	Varie	27	1			32,00
973030	93161637	IVECO	Sterzo	35	1			57,00
973046	4738069	IVECO	Sterzo	37	1			230,00
973055	93161371	IVECO	Sterzo	34	1			59,00
973056	271188	VOLVO	Sterzo	100	1			50,00
973056	691704	DAF	Sterzo	8	1			50,00
973056	2968454	IVECO	Sterzo	32-33	1			50,00
973057	1271124	DAF	Sterzo	8	1			46,00
973057	2980884	IVECO	Sterzo	32-33	1			46,00
973057	81432206108	MAN	Sterzo	47	1			46,00
973060	93163617	IVECO	Sterzo	31-37	1			35,00
973068	9423172012	MERCEDES	Varie	36	1			65,00
973131	93815026	IVECO	Sterzo	125	1			170,00
973140	504207328	IVECO	Sterzo	125	1			89,00
973141	504207329	IVECO	Sterzo	125	1			89,00
973142	504207327	IVECO	Sterzo	124	1			85,00
973143	504213051	IVECO	Sterzo	124	1			85,00
973144	504207331	IVECO	Sterzo	123	1			90,00
973145	93810223	IVECO	Sterzo	123	1			160,00
973146	93822444	IVECO	Sterzo	123	1			44,00
973147	93822441	IVECO	Sterzo	123	1			90,00
973148	500357351	IVECO	Varie	28	1			200,00
973158	93815025	IVECO	Sterzo	125	1			220,00
973190	1755638	SCANIA	Varie	18	1		D	350,00
973210	1742449	SCANIA	Varie	18	1		D	350,00
973214	41019115	IVECO	Sterzo	108	2			10,80
973215	41019116	IVECO	Sterzo	108	2			10,80
973220	1908861	IVECO	Varie	22	1		D	325,00
973221	20889134	VOLVO	Varie	33	1			228,00
973226	96015719	IVECO	Varie	224	1			8,50
973231	2997004	IVECO	Sterzo	108	2			8,50
973232	2997003	IVECO	Sterzo	108	2			8,50
973234	4639773	IVECO	Sterzo	109	1			37,00
973235	500379801	IVECO	Sterzo	119	1			150,00
973236	500379802	IVECO	Sterzo	119	1			150,00
973237	500334716	IVECO	Sterzo	119	1			230,00

LISTINO PREZZI IN PROGRESSIONE RIFERIMENTI **EMMERRE**
PRICE LIST IN ORDER OF **EMMERRE** **REFERENCE**

EMMERRE	Rif.Originale Original Ref.	Adattabile a: Adaptable to:	Tipo Cat. Cat. Type	Pagina Page	Qtà/Conf. Q.ty/Pck.	OE	Cat. D	Listino Price L. €
973238	500334717	IVECO	Sterzo	119	1			230,00
973239	93807566	IVECO	Sterzo	124	1			110,00
973240	8574229	IVECO	Sterzo	125	1			140,00
973242	-	IVECO	Sterzo	120	1			60,00
973243	-	IVECO	Sterzo	120	1			60,00
973244	4741171	IVECO	Sterzo	123	1			100,00
973248	41000480	IVECO	Sterzo	125	1		D	62,00
973249	93810157	IVECO	Sterzo	124	1			145,00
973250	504039506	IVECO	Sterzo	121	2			6,50
973251	-	IVECO	Sterzo	121	1			22,50
973252	-	IVECO	Sterzo	121	1			22,50
975000	2994022	IVECO	Varie	22	1	OE	D	275,00
975001	1908460	IVECO	Varie	22	1	OE		525,00
975002	500316981	IVECO	Varie	22	1	OE		350,00
975003	99458304	IVECO	Varie	22	1	OE	D	250,00
975004	98455864	IVECO	Varie	22	1	OE	D	330,00
975006	42108342	IVECO	Varie	23	1	OE	D	410,00
975007	42108356	IVECO	Varie	23	1	OE	D	410,00
975009	98427951	IVECO	Varie	23	1	OE	D	325,00
975010	504062817	IVECO	Varie	23	1	OE	D	320,00
975011	5010320096	RENAULT	Varie	31	1			140,00
975012	5010130797	RENAULT	Varie	31	1			60,00
975013	42073349	IVECO	Varie	22	1	OE		250,00
975014	500307338	IVECO	Varie	28	1			240,00
975015	41028764	IVECO	Varie	28	1			224,00
975016	1349840	SCANIA	Varie	32	1			158,00
975018	1424231	SCANIA	Varie	32	1			110,00
975019	1348121	SCANIA	Varie	32	1			116,00
975020	98416703	IVECO	Varie	25	1			125,00
975021	8162377	IVECO	Varie	23	1			35,00
975022	504065532	IVECO	Varie	23	1	OE	D	820,00
975023	1476415	SCANIA	Varie	32	1			106,00
975025	41022082	IVECO	Varie	26	1			165,00
975026	41022085	IVECO	Varie	26	1			165,00
975027	500398040	IVECO	Varie	26	1			120,00
975028	-	IVECO	Varie	4	1			790,00
975029	-	IVECO	Varie	5	1			790,00
975030	-	IVECO	Varie	9	1			794,00
975031	-	IVECO	Varie	11	1			880,00
975032	81.41722.6048	MAN	Varie	29	1			218,00
975033	9428905919	MERCEDES	Varie	30	1			218,00
975034	-	IVECO	Varie	6	1			680,00
975035	-	IVECO	Varie	7	1			900,00
975036	-	IVECO	Varie	3	1			690,00
975037	-	IVECO	Varie	12	1	OE		3.600,00
975039	-	IVECO	Varie	10	1			700,00
975041	-	IVECO	Varie	8	1			700,00
975042	-	IVECO	Varie	13	1			337,00
975043	-	IVECO	Varie	14	1			425,00
975044	-	IVECO	Varie	15	1			98,00
975045	4755152	IVECO	Varie	197	2			18,00
975046	9428900219	MERCEDES	Varie	30	1			224,00
975047	4729192	IVECO	Varie	196	2			18,00
975048	4665740	IVECO	Varie	197	2			25,00
975050	41019150	IVECO	Varie	26	1	OE		170,00
975053	9428902919	MERCEDES	Varie	30	1			224,00

Copyright della EMMERRE S.r.l. - Settimo Torinese - Tutti i diritti sono riservati e depositati a norma di legge ed a norma delle convenzioni internazionali. - E' vietata la duplicazione o la riproduzione anche parziale senza la previa autorizzazione della EMMERRE S.r.l.

LISTINO PREZZI IN PROGRESSIONE RIFERIMENTI EMMERRE
PRICE LIST IN ORDER OF EMMERRE REFERENCE

	Rif. Originale Original Ref.	Adattabile a: Adaptable to:	Tipo Cat. Cat. Type	Pagina Page	Qtà/Conf. Q.ty/Pck.	OE	Cat. D	Listino Price L. €
975054	42070266	IVECO	Varie	24	1		D	72,00
975055	1075076	VOLVO	Varie	33	1			118,00
975057	42106069	IVECO	Varie	25	1			80,00
975058	42106070	IVECO	Varie	25	1			80,00
975059	98411635	IVECO	Varie	25	1			140,00
975060	98411636	IVECO	Varie	25	1			140,00
975065	3172964	VOLVO	Varie	33	1			180,00
975066	42108427	IVECO	Varie	196	2			24,50
975072	41012352	IVECO	Varie	24	1			150,00
975073	41012353	IVECO	Varie	24	1			135,00
975075	99464832	IVECO	Varie	196	2			30,00
975076	42089641	IVECO	Varie	197	2			40,00
975080	42536624	IVECO	Freno	220	1		D	110,00
975081	42536625	IVECO	Freno	220	1		D	100,00
975082	42536626	IVECO	Freno	220	1		D	110,00
975083	42536627	IVECO	Freno	220	1		D	110,00
975084	99465472	IVECO	Freno	221	1			385,00
975085	99465473	IVECO	Freno	221	1			385,00
975086	42534119	IVECO	Freno	222	1		D	250,00
975087	42534120	IVECO	Freno	222	1		D	250,00
975088	42534121	IVECO	Freno	222	1			475,00
975089	42534122	IVECO	Freno	222	1			475,00
975090	42554990	IVECO	Freno	221	1	OE	D	320,00
975091	42554991	IVECO	Freno	221	1	OE	D	320,00
980010	42105790	IVECO	Varie	25	1			48,00
980011	41019147	IVECO	Varie	27	1			60,00
980012	99447540	IVECO	Varie	27	1			47,00
980013	42126981	IVECO	Varie	27	1			53,00
980014	41001890	IVECO	Varie	27	1			65,00
980015	99447541	IVECO	Varie	27	1			45,00
980016	99447542	IVECO	Varie	27	1			50,00
980017	99447543	IVECO	Varie	27	1			50,00
980019	98418616	IVECO	Varie	24	1		D	87,00
980025	-	IVECO	Varie	21	1			350,00
980026	-	IVECO	Varie	21	1			350,00
980112	61590479	IVECO	Varie	38	1			70,00
980113	61590492	IVECO	Varie	38	1			25,00
990002	-	VARI	Varie	222	1			29,00
990012	-	VARI	Varie	222	1			35,50
990230	-	VARI	Varie	223	10			5,75
990231	-	VARI	Varie	223	10			5,75
990232	-	VARI	Varie	223	10			5,75
990233	-	VARI	Varie	223	10			5,75
990234	-	VARI	Varie	223	10			5,75
990235	-	VARI	Varie	223	10			5,75
990236	-	VARI	Varie	223	10			5,75
990237	-	VARI	Varie	223	10			5,75
990240	-	VARI	Varie	222	2			5,75
990241	-	VARI	Varie	222	2			5,75
990300	T90204	VARI	Varie	218	1			22,50
990301	T90304	VARI	Varie	218	1			25,50
990302	T90504	VARI	Varie	218	1			34,00
990303	T90804	VARI	Varie	218	1			48,00
990304	T91004	VARI	Varie	219	1			52,00
990305	T91204	VARI	Varie	219	1			58,00
990306	T91504	VARI	Varie	219	1			65,00

LISTINO PREZZI IN PROGRESSIONE RIFERIMENTI EMMERRE
PRICE LIST IN ORDER OF EMMERRE REFERENCE

	Rif.Originale Original Ref.	Adattabile a: Adaptable to:	Tipo Cat. Cat. Type	Pagina Page	Qtà/Conf. Q.ty/Pck.	OE	Cat. D	Listino Price L. €
990307	T92004	VARI	Varie	219	1			76,00
990308	T93204	VARI	Varie	219	1			220,00
990309	L57S12041	VARI	Varie	219	1			36,00
990310	L57S12291	VARI	Varie	219	1			36,00
990311	LO312651-035	VARI	Varie	219	1			32,00
990500	1117025	IVECO	Varie	215	1		D	179,00
990501	1118066	IVECO	Varie	215	1			150,00
990502	500321203	IVECO	Varie	215	1			285,00
990503	4812066	IVECO	Varie	217	1			267,00
990504	4784774	IVECO	Varie	217	1			267,00
990505	99456701	IVECO	Varie	215	1			95,00
990506	4836359	IVECO	Varie	214	1			75,00
990507	4837683	IVECO	Varie	214	1			75,00
990509	1118800	MERCEDES	Varie	217	1			190,00
990510	504108890	IVECO	Varie	216	1			310,00
990511	500321204	IVECO	Varie	216	1		D	205,00
990512	42552536	IVECO	Varie	217	1		D	62,00
990513	42552535	IVECO	Varie	216	1		D	35,00
990514	42552534	IVECO	Varie	216	1		D	60,00

Copyright della EMMERRE S.r.l. - Settimo Torinese - Tutti i diritti sono riservati e depositati a norma di legge ed a norma delle convenzioni internazionali. - E' vietata la duplicazione o la riproduzione anche parziale senza la previa autorizzazione della EMMERRE S.r.l.