

COVIND

unlimited quality

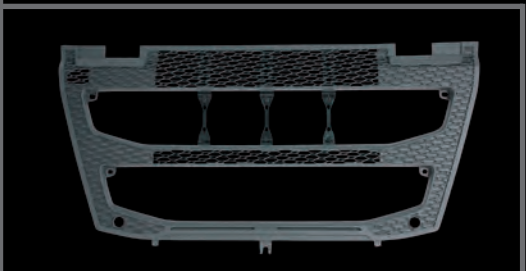

COVIND COV
IND COVIND
COVIND COV
IND COVIND
COVIND COV
IND COVIND
COVIND COV



SUITABLE TO
VOLVO
2017



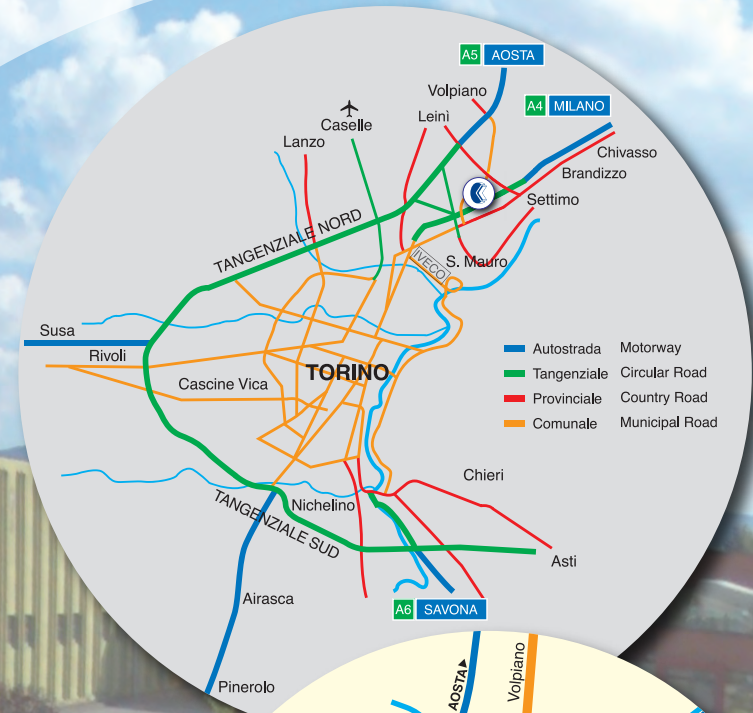



S U I T A B L E T O

VOLVO

MAGGIO
MAY
MAI

2017



BUREAU
VERITAS

SGS





كافت التفاصيل المذكوره هنا, وبالرغم من قابليتها للتبديل مع التفاصيل الاصلية بشكل متطابق تماما, إلا انها ليست الأصلية, نفس التفاصيل يتم الاستعانه بها واستخدامها فقط للعربات السائره و فقط بعد الحصول على التصريح بالموافقه من مالك العربيه التي يتم إصلاحها.
الأرقام الارشاديه الأصلية يتم وضعها بغرض الاستعلام, نرجو أن يتم دائما ذكر أرقامنا الخاصة الارشاديه في التعاقدات وطلبات الشراء.
هذا الكاتالوج يلغي كافة الكاتالوجات السابقه ويحل محلها.



Всички особености изредени по-долу, независимо от това, че са взаимозаменяеми с оригиналите, **не са оригинали**. Те биват използвани само за превозните средства в движение и само след упълномощаване от страна на собственика на превозното средство в ремонт.



Selles nimekirjas olevad varuosad ei ole originaalid vaatamata sellele, **et on originaalidega võrdväärselt kasutatavad**. Neid osasid kasutada ainult töös olevatel sõidukitel ja üksnes remonditava sõiduki omaniku loal. Originaali viitenumbrid on ära toodud ainult infoks. Palume müügi- ja tellimislehtedel ära märkida meie viitenumbrid.
Käesoleva kataloogi nimekiri tühistab ja asendab varasemad.



Tässä luetteloidut varaosat eivät ole alkuperäisosa, vaikka **ne ovatkin laadultaan alkuperäisosa vastaavia**. Osat on tarkoitettu käytettäväksi liikenteessä olevissa autoissa ja niitä käytetään vain korjattavan ajoneuvon omistajan luvalla. Alkuperäiset tuotekoodit mainitaan vain tiedon vuoksi. Pyydämme teitä käyttämään neuvotteluissa ja tilauslomakkeissa meidän tuotekoodejamme. Uusi tuoteluettelo peruuttaa ja korvaa aikaisemmat luettelot.



Toutes les pièces détaillées ci-dessus, tout en étant parfaitement interchangeable avec les pièces d'origine, **ne sont pas originales**. Les mêmes pièces sont utilisées exclusivement sur les véhicules en circulation et seulement sous autorisation du propriétaire du véhicule en réparation. Les codes de référence originales sont indiqués à titre purement documentaire. Dans les négociations et les commandes veuillez bien citer nos codes de référence. Le présent catalogue annule et remplace tous les précédents.



Alle hier aufgeführten Bestandteile sind exakt austauschbar mit den Originalteilen, **aber es sind keine Originale**. Diese Teile werden nur angewendet und eingesetzt für die Fahrzeuge die im Umlauf sind und nur nach Einverständnis mit dem Eigentümer, dessen Fahrzeug in der Reparatur ist. Die Original-Referenznummern wurden rein informativ nochmals wiedergegeben. Bei Anfragen und bei Bestellungen bitten wir Sie immer die Referenznummern anzugeben. Der beigelegte Katalog ersetzt und annulliert die vorhergehenden Kataloge.



Κάθε ανταλλακτικό που απαριθμείται εδώ, ακόμα κι αν όντας τέλεια ανταλλάξιμο με το γνήσιο, **δεν είναι γνήσιο**. Αυτά τα μέρη χρησιμοποιούνται μόνο στα οχήματα που είναι σε κυκλοφορία και αποκλειστικά μετά από την έγκριση του ιδιοκτήτη του οχήματος για επισκευή. Οι γνήσιοι κωδικοί που αναφέρονται υπάρχουν για πληροφοριακούς λόγους μόνο. Παρακαλούμε όπως χρησιμοποιείτε για οποιαδήποτε συναλλαγή/ παραγγελία σας τους δικούς μας αναφερόμενους κωδικούς. Ο παρών κατάλογος ακυρώνει και αντικαθιστά προηγούμενους.



Spare parts listed here, even though perfectly interchangeable with the original ones, **are not original**. These parts are used only on vehicles in circulation and exclusively under authorization of the owner of the vehicle in repair. The original reference codes are indicated for information only. You are kindly requested to indicate our reference codes in negotiations and order sheets. The present catalogue list cancels and replaces previous ones.



قطعات قید شده در اینجا، با اینکه کاملاً قابل تعویض با قطعات اصلی می باشند، قطعات اصلی نیستند. این قطعات تنها برای خودروهایی که در جریان می باشند (خارج از محل تولید می باشند) مورد استفاده قرار می گیرند و منحصرأ تحت اختیار و نضر مالک خودروی در حال تعمیر می باشند. با احترامات ما از شما شماره کد ارجاع اصلی تنها برای اطلاعات می باشند. تقاضا داریم که شماره کد ارجاع را در زمان مذاکره و در ورقه تقاضا مشخص کنید. لیست



Tutti i particolari qui elencati, pur essendo perfettamente intercambiabili con gli originali, **non sono originali**. Gli stessi vengono impiegati ed utilizzati solo per i veicoli in circolazione e solo dopo autorizzazione da parte del proprietario del veicolo in riparazione. I numeri di riferimento originali sono riportati a puro titolo informativo. Nelle trattative e nelle ordinazioni si prega di voler sempre citare i nostri numeri di riferimento. Il presente catalogo annulla e sostituisce tutti i precedenti.



Kaut arī uzskaitītās rezerves daļas var pilnīgi aizstāt oriģinālās, **tās nav oriģinālas**. Šīs rezerves daļas tiek izmantotas vienīgi apgrozībā esošiem transporta līdzekļiem un tikai ar remontējamā transporta līdzekļa īpašnieka atļauju. Oriģinālais atsauces numurs tiek uzrādīts vienīgi informācijai. Lūdzam norādīt jūsu atsauces numurus sarunu laikā un uz pasūtījuma lapas. Šis kataloga saraksts anulē un aizstāj visus iepriekšējos.



Čia išvardytos atsarginės dalys nėra originalios, tačiau jomis galima pakeisti originaliąsias. Šios dalys naudojamos tik apyvartoje esančiuose automobiliuose ir tik gavus remontuojamo automobilio savininko sutikimą.

Originalių dalių kodai nurodomi tik informacijos sumetimais. Maloniai prašome nusiskundimuose ir užsakymų lapuose nurodyti dalių kodus.

Šiame kataloge pateikiamas sąrašas anuliuoja ir pakeičia ankstesnius.



Reservedelene som er oppført her, er ikke **originale reservedeler**, selv om de fullt ut kan benyttes ved utskiftning av de opprinnelige delene. De skal kun benyttes på kjøretøy som er i bruk og med eierens samtykke. De opprinnelige referansekodene angis kun til etterretning. Vennligst angi våre referansekoder under forhandling og ved bestilling. Denne katalogen annullerer og erstatter alle tidligere kataloger.



Hoewel elk reserveonderdeel dat hier vermeld wordt perfect kan worden gebruikt in de plaats van de originele stukken, **gaat het hier dus niet om originele onderdelen**. Deze onderdelen worden enkel gebruikt voor voertuigen in circulatie en enkel met de toestemming van de eigenaar van het voertuig dat in reparatie is. De originele referentiecodes worden enkel ter informatie weergegeven. U wordt vriendelijk verzocht om onze referentiecodes te gebruiken in gesprekken en op de bestelformulieren. De huidige catalogoog annuleert en vervangt de vorige versies.



Wszystkie detale tu podane ,choć będąc doskonałe wymienne z oryginałami, **nie są oryginalne**.

Te same zostają zastosowane i użyte tylko dla pojazdów w obiegu i tylko po autoryzacji ze strony właściciela pojazdu będącego w naprawie.

Oryginalne numery referencyjne są umieszczone w celu czysto informacyjnym.

W czasie rozmów handlowych i zamówień, prosi się zechcieć zawsze cytować nasze numery referencyjne.

Niniejszy katalog anuluje i zastępuje wszystkie poprzednie.



Todas as peças aqui listadas, ainda que sejam perfeitamente intercambiáveis com as originais, **não são originais**. Estas peças só são empregues e utilizadas nos veículos em circulação e só após autorização prévia por parte do proprietário do veículo a reparar. Os números de referência originais têm um carácter puramente informativo. Nos contactos e encomendas, indique sempre os números de referência, por favor.



Veškeré zde uvedené součástky **nejsou originální díly**, i když jsou za ně stoprocentně zaměnitelné. Tyto součástky je možné použít pouze pro vozidla v provozu a pouze se souhlasem majitele vozidla, které má být opraveno. Referenční čísla originálních dílů jsou uvedena pouze informativně. Při jednáních a na objednávkách je nutné vždy uvést naše referenční čísla.

Tento katalog anuluje a nahrazuje veškeré předchozí katalogy.



Toate produsele enumerate in continuare, chiar daca sunt perfect interschimbabile cu cele originale, **nu sunt originale**. Ele sunt utilizate, numai pentru autovehiculele in circulatie si exclusiv cu acordul proprietarului autovehiculului de reparat. Codurile originale sunt indicate numai in scop informativ. Cu ocazia tratativelor verbale, cat si a emiterii ordinelor scrise, clientii sunt rugati sa utilizeze codurile noastre (COVIND) ca referinta. Prezentul catalog anuleaza si le inlocuieste pe cele precedente.



Все перечисленные запчасти не являются оригинальными, **хотя могут отлично их заменить**. Эти запчасти используются при ремонте автомобилей только с согласия владельца.

Ссылки на порядковый номер оригинальных запчастей указаны исключительно в ориентировочных целях.

При покупках и заказах рекомендуем указывать НАШИ номера запчастей.

Настоящий каталог анулирует и заменяет все предыдущие.

Оригинальные ориентировочные номера са изнесени само за ваша информация. При преговори и при поръчки молим винаги да цитирате нашите ориентировочни номера.

Настоящият каталог анулира и замества всички съществуващи до момента.



Ovdje popisani prièuvni dijelovi, èak i kada savršeno zamjenjuju izvorne, **nisu izvorni**. Ti dijelovi mogu se uporabiti jedino na vozilima u cirkulaciji i na temelju izrièitoga odobrenja vlasnika vozila na popravku.

Brojevi dijela izvornih dijelova navedeni su samo kao primjer. Najljepše vas molimo da u vašim zahtjevima i narudžbama navedete brojeve dijela.

Sadašnji katalog ukida valjanost svih prethodnih kataloga.



Èeprav jih je možno perfektno izmenjati z originalnimi deli, tukaj navedeni nadomestni deli niso originalni. Te dele se uporabljajo samo v vozilih v prometu in izkljuèno samo pod pogojem, da lastnika vozila v popravilu izda zato dovoljenje. Navedene originalne referenène kode so le informativne. Prosimo vas, da navedite naše referenène kode pri pogajanju in na naroèilih. S sedanjim seznamom prenehajo veljati prejšnji sezname in jih nadomesti.



Todos los elementos detallados a continuación, aunque totalmente intercambiables con los originales, **no son originales**. Estos mismos se emplean y utilizan unicamente para vehículos en circulación y previa autorización del propietario del vehículo en reparación. Los numeros de referencia originales se citan a título informativo. En las negociaciones y en los pedidos se ruega citar siempre nuestros numeros de referencia. El presente catálogo anula y substituye todos los anteriores.



Reservdelarna i denna lista är inte originaldelar trots att de **är fullkomligt utbytbara med de ursprungliga**. Dessa delar används endast på fordon i cirkulation och enbart efter godkännande av ägaren till det fordon som lämnats på reparation. De originala referenskoderna anges endast för information. Var god ange våra referenskoder i negocieringar och beställningsblanketter. Den nuvarande kataloglistan annullerar och ersätter de föregående.



Devamında detaylandırılan tüm elementler, orijinaleri ile tamamen değiştirilebilir olmasına rağmen, **orijinal değildirler**. Bunlar, yalnızca dolaşımda bulunan araçlarda ve tamirde bulunan aracın sahibinden ön onay alınması kaydıyla uygulanabilir ve kullanılabilir.

Orijinallerin referans numaraları bilgi başlığında yer almaktadır.

Görüşmelerde ve siparişlerde referans numaralarımızın her zaman belirtilmesi rica olunur.

Bu katalog tüm önceki versiyonları geçersiz kılar ve bunların yerine geçer.



Перелічені тут запасні частини не є оригінальними, але цілком взаємозамінні з оригінальними. Ці запасні частини застосовуються тільки на транспортних засобах, що знаходяться в експлуатації і винятково з дозволу власника, що здав транспортний засіб у ремонт.

Коди оригінальних запасних частин наводяться тільки для довідки. Прохання вказувати довідкові коди запасних частин при веденні переговорів і на бланках замовлення.

Даний каталог скасовує дію раніше виданих каталогів і замінює ці каталоги.



Az itt felsorolt tartalék alkatrészek, még akkor is, ha megfelelően felcserélhetők az eredetiekkel, nem az eredetiek. Ezeket az alkatrészeket csak forgalomban lévő járművek javításánál használják és kizárólag a jármű tulajdonosának engedélyével.

Az eredeti referencia kódokat csak információs célból jelzik. Kérjük legyen szíves jelezze a referencia kódjainkat a tárgyalásokon és a megrendelési dokumentumban.

A jelenlegi katalógus lista vissza van vonva és újra az előző lista van érvényben.

Si consiglia di consultare sempre il catalogo on-line per gli ultimi aggiornamenti.

Please visit the catalogue on-line for the latest updates.

il est conseillé de toujours consulter le catalogue en ligne pour les dernières mises à jour.

Wir empfehlen Ihnen immer unsere on line Kataloge nachzuschlagen, um die letzten Aktualisierungen zu kennen

Les recomendamos consulten siempre el catálogo en línea para las últimas actualizaciones.

<http://catalogo.covind.it>



Recomenda-se a consulta do catálogo eletrónico para informação das novas atualizações.

Zaleca się odwiedzać zawsze katalog on-line zawierający najnowsze aktualizacje

E consiliabila intotdeauna, consultarea catalogului on-line pentru cunoasterea ultimilor actualizari.

Пожалуйста, обратите внимание на последние обновления каталогов on-line

للأطلاع على آخر التحسينات,
الرجاء الرجور دائما الى كاتالوجاتنا على الخط.

www.covind.it



Indice :: Index :: Verzeichnis

LEGENDA

Specchi retrovisori :: Legenda rear mirrors :: Legenda Komplettspiegel INTRO 2-3-4

Tabelle comparative :: cross references :: Korrespondenztabelle

OEMCOVIND INTRO 7

COVINDOEM INTRO 17

MEDI MEDIUM VERTEILERVERKEHER

0FL FL 20061

0FE FE 200619

2FM FM7-FM10-FM12 SECONDA SERIE | SECOND SERIES | ZWEITE SERIE ...39

0FM FM7-FM10-FM12 PRIMA SERIE | FIRST SERIES | ERSTE SERIE65

PESANTI TRUCKS NUTZFAHRZEUGE

4FH FH Euro 689















3FH FH 13 TERZA SERIE 2008 | THIRD SERIES 2008 | DRITTE SERIE 2008 ..123

2FH FH12-FH16 SECONDA SERIE | SECOND SERIES | ZWEITE SERIE173

0FH FH12-FH16 PRIMA SERIE | FIRST SERIES | ERSTE SERIE203

V12 F12235

Legenda specchi retrovisori :: Legenda rear mirrors :: Legenda Komplettspiegel

	Guida destra/sinistra Right and left-hand drive Rechts-und Linkslenkung		Lato sinistro Left side Links einsetzbar		Colore Silver Color Silver Farbe Silber
	Guida destra Right-hand drive Rechtslenkung		Braccio Polipropilene e Fibra di vetro PP+GF mirror arm Spiegelarm aus Polypropylen und Glasfaser		Colore Nero e Grigio Color Black/Grey Farbe Schwarz/Grau
	Guida sinistra Left-hand drive Linkslenkung		Braccio integrato Integrated arm Integrierten Arm		Raggio 1200 di convessità specchio principale Mirror glass bend radius: 1200 Wölbungsradius des Spiegelglases 1200
	Braccio corto - destro Short arm - right Kurzer Spiegelarm, rechts		Braccio in acciaio (∅ 28 mm / ∅ 40 mm) Steel arm (∅ 28 mm / ∅ 40mm) Spiegelarm aus Stahl (∅ 28 mm / ∅ 40 mm)		Raggio 300 di convessità specchio ausiliario Mirror glass bend radius: 300 Wölbungsradius des Weitwinkelspiegelglases 300
	Braccio corto - sinistro Short arm - left Kurzer Spiegelarm, links		Braccio in alluminio (∅ 28 mm / ∅ 40 mm) Aluminium arm (∅ 28 mm / ∅ 40 mm) Spiegelarm aus Aluminium (∅ 28 mm / ∅ 40 mm)		Curvo Convex Gewölbtes Glas
	Braccio medio - destro Middle arm - right Mittlerer Spiegelarm, rechts		Materiale: ABS Material: ABS Kunststoff ABS		Classe II: specchio principale Class II: main mirror Klasse II: Hauptspiegel
	Braccio medio - sinistro Middle arm - left Mittlerer Spiegelarm, links		Braccio completo di copribraccio inferiore Arm with lower cover kompletter Spiegelarm mit unteren Haltebock		Classe IV: specchio ausiliario Class IV: auxiliary mirror Klasse IV: Weitwinkelspiegel
	Braccio lungo - destro Long arm - right Langer Spiegelarm, rechts		Braccio completo di copribraccio superiore e inferiore Arm with upper and lower cover kompletter Spiegelarm mit oberen und unteren Haltebock		Classe III: specchio ausiliario Class III: auxiliary mirror Klasse III: Weitwinkelspiegel
	Braccio lungo-sinistro Long arm - left Langer Spiegelarm, links		Braccio completo di supporto superiore Arm with upper bracket kompletter Spiegelarm mit oberen Haltebock		Superiore Top Höher
	Lato destro/sinistro Right/left side Links/rechts einsetzbar		Colore Nero Color Black Farbe Schwarz		Centrale Central Zentral
	Lato destro Right side Rechts einsetzbar		Colore Grigio Color Grey Farbe Grau		Inferiore Bottom Unter



Doppio specchio
Double glass
Zweispiegel



Regolazione elettrica
Remote control
Elektrisch verstellbar



Regolazione manuale
Manual control
Manuell verstellbar



Specchio riscaldato 24V (sbrinamento)
Heated 24 V
Spiegel beheizt 24 V (Entfrostung)



Specchio riscaldato (sbrinamento)
Heated
Spiegel beheizt (Entfrostung)



Braccio con cavo per movimento elettrico
Arm with electric wire
Spiegelarm mit Steuerkabel



Braccio con cavo per riscaldamento 24 V
Arm with heat wire 24 V
Spiegelarm mit Heizkabel



Sistema di bloccaggio
Blocking System
Haltebock



Vetro specchio con supporto
Mirror glass unit
Glas mit Spiegelhalter



Ribaltamento elettrico
Electrically foldable
Elektrisch einklappbar



Lampeggiatore luce bianca (W)
White light blinker (W)
Blinker weisslicht (W)



Lampeggiatore luce arancione (W)
Orange light blinker (W)
Blinker orangeflicht (W)



Sonda
Sensor
Sensor



Antenna
Antenna
Antenne



Supporto con attacco circolare
Circular attack support
Unterstützung mit Rundangriff



Fornito smontato
Unassembled
Zerlegte Lieferung



Imballo
Packing
Verpackung



Selezionatore specchio destro/sinistro
Mirrors' selector right/left
Spiegelverstellung rechts/links



Azionamento alzacristalli
Windows' drive power
Antriebsseite Fensterheber



Retroilluminato
Courtesy lighted
Rueckbeleuchtet



* L'OEM fornisce R400-R1800, COVIND R300-R1200 come da normativa vigente. L'indicazione “*” nel codice OEM ha pertanto il solo scopo di aiutare il cliente nell'identificazione del prodotto Covind equivalente.

* OE supplies R1800-R400 while COVIND R1200-R300 according to the valid Regulation.
The symbol “*” near the OEM code is used only for comparison purposes helping the customer to properly identify the equivalent item.

* OEM beliefer R1800-R400 während COVIND liefern in R1200-R300 die Europa normative folgend.
Die Angabe “*” im Original-Referenz dient dazu, dem Kunden zu helfen, den Covind passenden Produkt zu ermitteln.

Normativa . Regulation . Vorschrift

Secondo le direttive:

CE 2003/97 valida dal 01/2007

CE 2007/38 valida da 04/2009

With reference to:

2003/97/EC Regulation valid from January 2007

2007/38/EC Regulation valid from April 2009

Gemäß EG-Verordnung:

2003/97/EC Gültig ab Januar 2007

2007/38/EC Gültig ab April 2009

A Sistema specchio completo (II+IV+Braccio)
Complete Mirror (Class II+IV+arm)
Komplettspiegel (Klasse II+IV+Arm)

B Unità specchio (II/IV)
Mirror unit (Class II/Class IV)
Spiegeleinheit (Klasse II/IV)

C Componenti di ricambio
Spare parts
Ersatzteile

Codice Covind
Covind code
Covind Nr.

Codici Originali
O.E.M. Ref.
OE Nummer

Posizione Specchio
Mirror position
Einsetzung des Spiegels

- Particolare presente in assortimento Covind;
Item in Covind Range
Teil in unserer Produktpalette
- Particolare non presente in assortimento Covind
Item not in Covind Range
Teil nicht in unserer Produktpalette

Numero di Omologazione
CE number
Homologations-Nr.

MAN		XXL/508		XXL/508		XXL/508	
A	XXL/508	81637316618 (81637316614)					328x935 mm
	II (E4)024100 176x379 mm	81637336049					(E4)024100 176x379 mm
	IV (E4)024101 167x177 mm	81637336057					(E4)024101 177x167 mm
	applicabilità: applicable to: Verwendbar für	81637320060 (81637320055) (81637320064)					215x398 mm
	MAN TGA LX 12/2006 → MAN TGM 12/2006 → 11/2014 MAN TGL 12/2006 → 11/2014	81637320062 (81637320056) (81637320066)					215x398 mm
B	XXL/522 II	81637306481		216x167 mm			
	XXL/524 IV	81637306513		229x187 mm			
	138 . adattabile a :: suitable to :: assend an MAN						

Dimensioni particolare (larghezza x altezza)
Item dimensions (Width x Height)
Abmessungen des Teiles (Länge * Höhe)



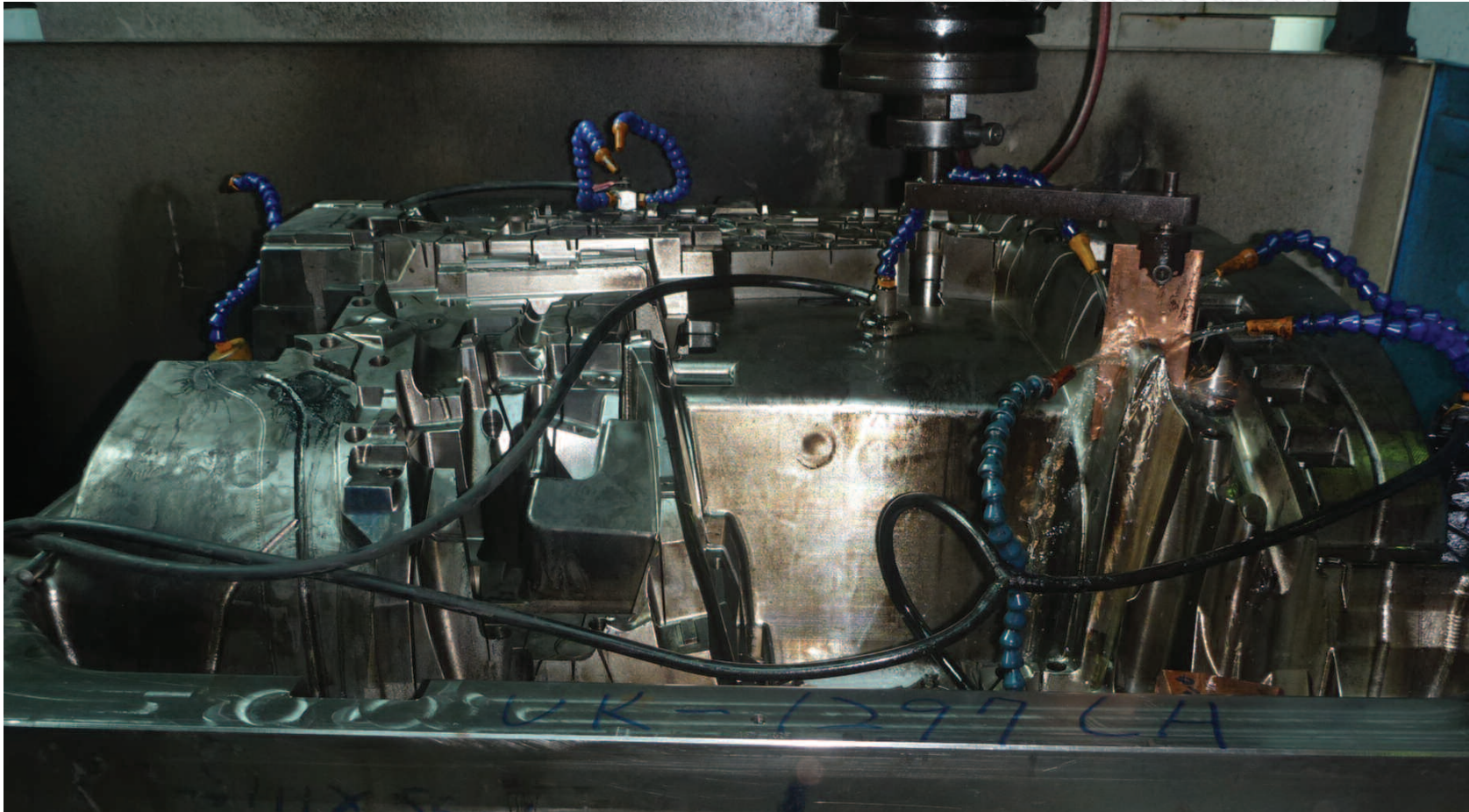

- IT Lavorazione stampo a iniezione per ossatura porta faro sinistro
EN LH headlamp housing injection moulding machining
DE Lavorazione stampo a iniezione per ossatura porta faro sinistro

Cod. Originale O.E.M. Ref. OE Nummer	Cod. Covind Covind Ref. Covind Teilnummer	Pag.Cat. Page Cat. Seite
20937431	0FE/400	3, 21
677950	V12/173	241
680662	V12/172	241
680663	V12/171	241
687895	V12/196	241
1062010	0FH/169	55,73,136,186, 218
1062011	0FH/168	55, 73, 136, 186, 218
1062133	0FM/241	78
1062134	0FM/240	78
1062163	0FM/135	69
1062190	0FH/650	67, 205
1062547	0FH/135	209
1062548	0FH/134	209
1062565	0FH/195	54, 72, 137, 187, 219
1062566	0FH/194	54, 72, 137, 187, 219
1062636	2FH/ 9	134, 184, 216
1062637	2FH/ 10	134, 184, 216
1063291	0FH/165	55, 73, 136, 186, 218
1063292	0FH/164	55, 73, 136, 186, 218
1063327	0FH/193	135, 185, 217
1063328	0FH/192	135, 185, 217
1063509	0FH/150	69, 209
1063726	0FM/210	56, 78
1063836	0FH/165	55, 73, 136, 186, 218
1063837	0FH/164	55, 73, 136, 186, 218
1077451	0FH/520	61, 85, 169, 198, 229
1079965	2FH/515	58, 59, 82, 83, 164, 165, 194, 195, 226, 227
1079981	2FH/510	60, 84, 168, 196, 228
1080926	V12/ 90	236
1082466	V12/174	241
1082467	V12/175	241
1086533	0FH/ 5	219
1086534	0FH/ 4	219

Cod. Originale O.E.M. Ref. OE Nummer	Cod. Covind Covind Ref. Covind Teilnummer	Pag.Cat. Page Cat. Seite
1089967	V12/230	240
1254749	V12/196	241
1508953	V12/113	241
1508954	V12/115	241
1509937	V12/270	239
1521324	V12/156	238
1570895	V12/180	241
1570896	V12/179	241
1570897	V12/163	241
1570898	V12/162	241
1573732	V12/600	242
1589309	V12/243	243
1590947	V12/429	238
1590948	V12/428	238
1591146	V12/800	236
1591558	V12/260	239
1592458	V12/375	238
1593174	V12/257	239
1599297	0FH/510	80, 224
1605245	V12/196	241
1606375	0FH/166	186, 218
1607178	V12/271	239
1607898	V12/168	236
1610787	V12/427	238
1610788	V12/426	238
1610809	V12/203	242
1612331	V12/169	236
1614048	0FH/700	-
1619106	0FH/ 50	207
1619148	0FH/161	207
1619149	0FH/160	207
1619254	0FH/800	208
1621182	V12/112	237
1621183	V12/111	237

Cod. Originale O.E.M. Ref. OE Nummer	Cod. Covind Covind Ref. Covind Teilnummer	Pag.Cat. Page Cat. Seite
1621184	V12/135	237
1621185	V12/134	237
1621325	V12/157	238
1621376	V12/155	236
1621903	V12/ 99	237
1621904	V12/ 98	237
1623147	2FH/ 7	134, 184, 216
1623148	2FH/ 6	134, 184, 216
1623459	0FH/320	222
1623942	V12/600	242
1626679	0FH/ 93	67, 205
1626680	0FH/ 92	67, 205
1660358	V12/340	239
1661382	V12/343	239
1661854	V12/345	239
1664215	V12/340	239
1665132	V12/347	239
1676400	2FH/620	-
3090484	0FH/196	54, 72, 137, 187, 219
3090971	0FH/134	209
3090972	0FH/135	209
3091750	0FH/513	77, 215
3091751	0FH/512	75, 213
3092854	0FH/506	75, 77, 213, 215
3127594	2FH/619	27, 64, 202, 234
3171391	2FH/515	58, 59, 82, 83, 164, 165, 194, 195, 226, 227
3175029	0FH/190	54, 72, 134, 184, 216
3175032	0FH/700	-
3175032	V12/700	237
3175158	0FM/201	56, 78
3175159	0FM/200	56, 78
3175246	0FH/201	220
3175247	0FH/200	220

Cod. Originale O.E.M. Ref. OE Nummer	Cod. Covind Covind Ref. Covind Teilnummer	Pag.Cat. Page Cat. Seite
3175366	2FH/110	45, 129, 178
3175366	2FH/111	45, 129, 178
3175367	2FH/110	45, 129, 178
3175376	2FM/145	45
3175406	2FH/241	56, 142, 192
3175407	2FH/240	56, 142, 192
3175417	2FH/ 89	43, 126, 175
3175418	2FH/ 97	43, 126, 175
3175419	2FH/ 96	43, 126, 175
3175545	2FH/155	49, 182
3175546	2FH/154	49, 182
3175547	2FH/157	49, 182
3175548	2FH/156	49, 182
3175863	0FH/155	69, 209
3175918	0FH/195	54, 72, 137, 187, 219
3175919	0FH/194	54, 72, 137, 187, 219
3175927	2FH/201	142, 192
3175928	2FH/200	142, 192
3175929	2FH/207	142, 192
3175930	2FH/206	142, 192
3175933	2FH/205	142, 192
3175934	2FH/204	142, 192
3176536	0FH/165	55, 73, 136, 186, 218
3176537	0FH/164	55, 73, 136, 186, 218
3176541	0FH/165	55, 73, 136, 186, 218
3176542	0FH/164	55, 73, 136, 186, 218
3176545	0FH/165	55, 73, 136, 186, 218
3176546	0FH/164	55, 73, 136, 186, 218
3176549	0FH/169	55, 73, 136, 186, 218
3176550	0FH/168	55, 73, 136, 186, 218
3197850	0FH/522	61, 85, 167, 197, 230
3197851	0FH/521	61, 85, 169, 198, 229
3953182	0FH/166	186, 218
3980869	0FH/135	209

Cod. Originale O.E.M. Ref. OE Nummer	Cod. Covind Covind Ref. Covind Teilnummer	Pag.Cat. Page Cat. Seite
3980870	0FH/134	209
3981043	0FH/199	192, 221
3981256	0FH/ 96	67, 205
3981593	0FH/710	70, 210
3981666	0FH/610	71, 211
3981668	0FH/604	71, 211
3981762	0FH/201	220
3981764	0FH/200	220
3981923	0FH/165	55, 73, 136, 186, 218
3981924	0FH/164	55, 73, 136, 186, 218
3987252	2FH/517	58, 60, 82, 84, 164, 168, 194, 196, 226, 228
3987253	2FH/514	60, 84, 168, 196, 228
8122893	0FH/205	221
8122894	0FH/204	221
8140016	0FM/170	7, 55, 73
8140923	0FH/400	206
8141003	0FH/241	221
8141004	0FH/240	221
8141236	0FH/205	221
8141237	0FH/204	221
8141289	0FH/ 95	69, 209
8141290	0FH/ 94	69, 209
8141312	0FH/243	222
8141313	0FH/242	222
8144107	0FH/201	220
8144108	0FH/200	220
8144454	0FH/ 90	67, 205
8144455	0FH/145	208
8144482	0FH/150	69, 209
8144524	0FH/146	208
8144525	0FH/147	208
8144526	0FH/149	208
8144527	0FH/148	208

Cod. Originale O.E.M. Ref. OE Nummer	Cod. Covind Covind Ref. Covind Teilnummer	Pag.Cat. Page Cat. Seite
8150689	V12/ 90	236
8152722	0FH/ 96	67, 205
8154385	0FH/520	61, 85, 169, 198, 229
8155808	0FH/515	80, 81, 224, 225
8156540	0FH/321	222
8156551	0FH/518	80, 81, 224, 225
8156552	0FH/518	80, 81, 224, 225
8156554	0FH/519	80, 81, 224, 225
8156556	0FH/510	80, 224
8158216	V12/ 90	236
8189092	0FH/161	207
8189093	0FH/160	207
8189130	0FH/105	207
8189195	0FH/201	220
8189196	0FH/200	220
8189295	0FH/105	207
8189300	0FH/201	220
8189301	0FH/200	220
8189318	0FH/400	206
8189329	0FH/ 90	67, 205
8189337	0FH/ 96	67, 205
8189467	0FH/155	69, 209
8190106	0FH/515	80, 81, 224, 225
8191103	0FH/242	222
8191142	0FH/610	71, 211
8191220	0FH/110	207
8191313	0FH/215	223
8191314	0FH/212	220, 223
8191315	0FH/210	143, 193, 220, 223
8191316	0FH/105	207
8191406	0FM/145	68
8191409	0FM/161	68
8191412	0FM/160	68
8191421	0FM/110	68

Cod. Originale O.E.M. Ref. OE Nummer	Cod. Covind Covind Ref. Covind Teilnummer	Pag.Cat. Page Cat. Seite
8191439	0FM/ 50	68
8191570	0FM/134	69
8191593	0FM/241	78
8191594	0FM/240	78
8191778	0FM/207	78
8191779	0FM/206	78
8191780	0FM/199	79
8191781	0FM/198	79
8191826	0FM/217	-
8191827	0FM/216	-
9520400	0FH/670	64, 202, 234, 242
20360266	2FH/145	177
20360507	0FH/145	208
20360542	2FH/ 3	137, 187, 219
20360543	2FH/ 2	137, 187, 219
20360788	2FH/209	56, 143, 193
20360789	2FH/208	56, 143, 193
20360811	2FH/508	51, 53, 189, 191
20372037	2FH/ 7	134, 184, 216
20372038	2FH/ 6	134, 184, 216
20372039	2FH/ 10	134, 184, 216
20372064	2FH/317	193
20372065	2FH/316	193
20372123	2FM/149	-
20372226	0FH/ 93	67, 205
20372227	0FH/ 92	67, 205
20379171	2FM/161	-
20379172	2FM/160	-
20379175	2FH/161	128, 177
20379176	2FH/160	128, 177
20379348	2FH/ 50	129, 178
20379349	2FM/ 50	45
20379357	2FH/163	128, 177
20379358	2FH/162	128, 177

Cod. Originale O.E.M. Ref. OE Nummer	Cod. Covind Covind Ref. Covind Teilnummer	Pag.Cat. Page Cat. Seite
20379437	0FH/215	223
20379438	0FH/212	220, 223
20379439	0FH/210	143, 193, 220, 223
20379593	0FH/191	185, 217
20382691	2FH/800	-
20382890	0FH/526	167, 197, 230
20383038	0FH/527	167, 197, 230
20383543	2FH/111	45, 129, 178
20391450	2FM/148	-
20391451	2FM/146	-
20391452	2FM/147	-
20392544	2FH/505	58, 59, 61, 82, 83, 85, 164, 165, 167, 194, 195, 197, 199, 226, 227, 231
20392599	2FH/518	58, 59, 82, 83, 164, 165, 194, 195, 199, 226, 227, 231
20398135	2FH/ 7	134, 184, 216
20398136	2FH/ 6	134, 184, 216
20398385	0FH/135	209
20398386	0FH/134	209
20398387	0FM/135	69
20398388	0FM/134	69
20398389	0FM/135	69
20398390	0FM/134	69
20398466	0FH/195	54, 72, 137, 187, 219
20398467	0FH/194	54, 72, 137, 187, 219
20398707	2FH/ 85	41, 125, 174
20398708	2FH/ 84	41, 125, 174
20398709	2FH/ 80	41, 125, 174
20398907	0FH/ 5	219
20398908	0FH/ 4	219
20409818	2FH/152	48, 183
20409874	2FH/605	-

Cod. Originale O.E.M. Ref. OE Nummer	Cod. Covind Covind Ref. Covind Teilnummer	Pag.Cat. Page Cat. Seite
20409874	2FH/607	47, 181
20409875	2FH/604	-
20409875	2FH/606	47, 181
20425418	2FH/137	47, 181
20425419	2FH/136	47, 181
20425469	0FM/201	56, 78
20425625	2FH/ 90	42, 126, 175
20425626	2FH/ 93	42, 126, 175
20425627	2FH/ 92	42, 126, 175
20429679	2FH/ 80	41, 125, 174
20429680	2FH/ 85	41, 125, 174
20429681	2FH/ 84	41, 125, 174
20452847	2FH/133	46, 180
20452848	2FH/132	46, 180
20452886	2FH/135	46, 180
20452887	2FH/134	46, 180
20453627	2FH/ 99	47, 181
20453628	2FH/ 98	47, 181
20453676	2FH/237	41, 125, 174
20453677	2FH/236	41, 125, 174
20453690	3FH/ 85	49, 130, 182
20453716	2FH/150	46, 180
20453900	2FH/325	193
20453930	2FH/ 95	47, 181
20453931	2FH/ 94	47, 181
20455995	2FH/504	51, 53, 189, 191
20456550	2FH/100	125, 174
20456709	2FH/400	179
20456804	2FH/ 86	44, 127, 176
20456805	2FH/ 88	44, 127, 176
20456806	2FH/ 87	44, 127, 176
20456963	2FH/153	48, 183
20466894	0FH/522	61, 85, 167, 197, 230
20466895	0FH/521	61, 85, 169, 198, 229

Cod. Originale O.E.M. Ref. OE Nummer	Cod. Covind Covind Ref. Covind Teilnummer	Pag.Cat. Page Cat. Seite
20467037	2FH/ 5	137, 187
20467038	2FH/ 4	137, 187
20467053	2FH/115	178
20467142	2FH/143	177
20467143	2FH/142	177
20467412	2FH/480	179
20467414	2FH/480	179
20467422	2FH/480	179
20467424	2FH/480	179
20467442	2FH/100	125, 174
20498620	2FH/513	60, 84, 168, 196, 228
20501225	0FE/400	3, 21
20507020	2FH/ 95	47, 181
20507021	2FH/ 94	47, 181
20507252	2FH/619	27, 64, 202, 234
20516776	2FH/150	46, 180
20523232	2FM/144	-
20529478	0FM/201	56, 78
20529483	0FM/200	56, 78
20529638	2FH/241	56, 142, 192
20529640	2FH/240	56, 142, 192
20529668	2FH/163	128, 177
20529672	2FH/162	128, 177
20529682	2FH/205	142, 192
20529684	2FH/204	142, 192
20529704	2FH/158	-
20529705	2FH/155	49, 182
20529706	2FH/154	49, 182
20529707	2FH/157	49, 182
20529708	2FH/156	49, 182
20529738	2FH/111	45, 129, 178
20529740	2FH/ 89	43, 126, 175
20529741	2FH/ 97	43, 126, 175
20529742	2FH/ 96	43, 126, 175

Cod. Originale O.E.M. Ref. OE Nummer	Cod. Covind Covind Ref. Covind Teilnummer	Pag.Cat. Page Cat. Seite
20529765	0FH/199	192, 221
20530082	0FM/207	78
20530083	0FM/206	78
20530146	2FH/110	45, 129, 178
20533138	2FH/159	-
20534600	2FH/ 99	47, 181
20534601	2FH/ 98	47, 181
20537185	0FM/201	56, 78
20541447	3FH/619	-
20545094	2FH/149	183
20545095	2FH/148	183
20567685	2FH/504	51, 53, 189, 191
20570721	2FH/191	135, 185, 217
20570722	2FH/190	135, 185, 217
20583434	2FH/513	60, 84, 168, 196, 228
20583434	2FH/517	58, 60, 82, 84, 164, 168, 194, 196, 226, 228
20583440	2FH/514	60, 84, 168, 196, 228
20589788	2FH/503	51, 53, 139, 141, 189, 191
20589798	3FH/509	139, 141
20711859	2FH/ 80	41, 125, 174
20711860	2FH/ 85	41, 125, 174
20711861	2FH/ 84	41, 125, 174
20722652	2FH/515	58, 59, 82, 83, 164, 165, 194, 195, 226, 227
20722654	2FH/520	58, 59, 82, 83, 164, 165, 194, 195, 226, 227
20743944	0FL/400	2, 20
20746401	2FH/502	51, 53, 189, 191
20746402	3FH/511	139, 141
20789440	2FH/610	57
20819179	0FL/480	2, 20
20826211	2FH/607	47, 181
20826213	2FH/606	47, 181

Cod. Originale O.E.M. Ref. OE Nummer	Cod. Covind Covind Ref. Covind Teilnummer	Pag.Cat. Page Cat. Seite
20826227	2FH/137	47, 181
20826231	2FH/136	47, 181
20827042	2FH/ 99	47, 181
20827044	2FH/ 98	47, 181
20841436	3FH/508	139, 141
20854564	0FH/506	75, 77, 213, 215
20861583	2FH/601	-
20861584	2FH/600	-
20888780	2FM/144	-
20896946	0FH/670	64, 202, 234, 242
20917957	2FH/ 99	47, 181
20917958	2FH/ 98	47, 181
20936759	2FH/515	58, 59, 82, 83, 164, 165, 194, 195, 226, 227
20936769	2FH/520	58, 59, 82, 83, 164, 165, 194, 195, 226, 227
20937442	0FL/400	2, 20
21070768	3FH/509	139, 141
21078543	3FH/137	133
21078545	3FH/136	133
21094383	3FH/530	112, 113, 114, 115, 156, 157, 158, 159
21094386	3FH/540	102, 103, 104, 105, 106, 107, 144, 145, 146, 147, 148, 149
21094387	3FH/530	112, 113, 114, 115, 156, 157, 158, 159
21094388	3FH/520	108, 109, 110, 111, 150, 151, 152, 153, 154, 155
21094389	3FH/535	116, 117, 118, 119, 160, 161, 162, 163
21094390	3FH/540	102, 103, 104, 105, 106, 107, 144, 145, 146, 147, 148, 149

Cod. Originale O.E.M. Ref. OE Nummer	Cod. Covind Covind Ref. Covind Teilnummer	Pag.Cat. Page Cat. Seite
21094391	3FH/515	102, 103, 104, 105, 108, 109, 112, 113, 116, 117, 144, 145, 146, 147, 150, 151, 152, 153, 156, 157, 160, 161, 166
21094392	3FH/522	106, 107, 110, 111, 114, 115, 118, 119, 148, 149, 154, 155, 158, 159, 162, 163, 166
21094393	3FH/523	106, 107, 110, 111, 114, 115, 118, 119, 148, 149, 154, 155, 158, 159, 162, 163, 166
21094394	3FH/525	104, 105, 106, 107, 108, 109, 110, 111, 112, 113, 114, 115, 116, 117, 118, 119, 146, 147, 148, 149, 152, 153, 154, 155, 156, 157, 158, 159, 160, 161, 162, 163, 166
21094400	3FH/525	104, 105, 106, 107, 108, 109, 110, 111, 112, 113, 114, 115, 116, 117, 118, 119, 146, 147, 148, 149, 152, 153, 154, 155, 156, 157, 158, 159, 160, 161, 162, 163, 166
21094410	3FH/528	166
21094411	3FH/527	166
21094413	3FH/532	166
21094447	3FH/524	102, 144, 150
21094454	3FH/526	166
21094456	3FH/526	166
21094457	3FH/510	102, 104, 106, 108, 110,

Cod. Originale O.E.M. Ref. OE Nummer	Cod. Covind Covind Ref. Covind Teilnummer	Pag.Cat. Page Cat. Seite
		112, 114, 116, 118, 144, 146, 148, 150, 152, 154, 156, 158, 160, 162
21169974	3FH/511	139, 141
21190825	3FH/140	128
21203311	0FH/507	75, 77, 213, 215
21261274	2FH/181	135, 185, 217
21261275	2FH/180	135, 185, 217
21299955	2FH/ 5	137, 187
21300059	2FH/ 4	137, 187
21302461	2FH/207	142, 192
21302470	2FH/206	142, 192
21305345	3FH/522	106, 107, 110, 111, 114, 115, 118, 119, 148, 149, 154, 155, 158, 159, 162, 163, 166
21305346	3FH/523	106, 107, 110, 111, 114, 115, 118, 119, 148, 149, 154, 155, 158, 159, 162, 163, 166
21316575	4FH/ 93	92
21316576	4FH/ 90	92
21316577	4FH/ 92	92
21320300	2FH/504	51, 53, 189, 191
21320365	3FH/509	139, 141
21320404	2FH/503	51, 53, 139, 141, 189, 191
21344647	4FH/243	99
21344649	4FH/242	99
21358670	2FH/150	46, 180
21359080	2FH/ 90	42, 126, 175
21359082	2FH/ 93	42, 126, 175
21359090	2FH/ 92	42, 126, 175
21359257	2FH/ 95	47, 181
21359260	2FH/ 94	47, 181

Cod. Originale O.E.M. Ref. OE Nummer	Cod. Covind Covind Ref. Covind Teilnummer	Pag.Cat. Page Cat. Seite
21392183	4FH/243	99
21392187	4FH/242	99
21413732	4FH/255	101
21413763	4FH/250	100
21413786	4FH/ 88	92
21413787	4FH/ 87	92
21413789	4FH/ 89	92
21425186	3FH/ 85	49, 130, 182
21430596	2FH/150	46, 180
21430598	2FH/137	47, 181
21430599	2FH/ 86	44, 127, 176
21430600	2FH/ 88	44, 127, 176
21430672	2FH/ 87	44, 127, 176
21445302	3FH/150	130
21445754	3FH/151	130
21448885	3FH/609	133
21451000	3FH/ 95	132
21451002	3FH/ 94	132
21469918	2FH/135	46, 180
21469924	2FH/134	46, 180
21469979	2FH/136	47, 181
21478481	3FH/155	-
21478751	3FH/608	133
21478755	3FH/134	132
21478759	3FH/135	132
21484901	2FH/100	125, 174
21495266	4FH/ 97	93
21495267	4FH/ 95	93
21495268	4FH/ 96	93
21505893	2FH/181	135, 185, 217
21505894	2FH/180	135, 185, 217
21642377	4FH/ 5	100
21642399	4FH/ 4	100
21828914	2FH/ 80	41, 125, 174

Cod. Originale O.E.M. Ref. OE Nummer	Cod. Covind Covind Ref. Covind Teilnummer	Pag.Cat. Page Cat. Seite
21829051	2FH/ 85	41, 125, 174
21829052	2FH/ 84	41, 125, 174
21838943	4FH/ 80	91
21838944	4FH/ 85	91
21838945	4FH/ 84	91
21874450	4FH/135	96
21874457	4FH/134	96
21940892	4FH/251	100
22087684	3FH/515	102, 103, 104, 105, 108, 109, 112, 113, 116, 117, 144, 145, 146, 147, 150, 151, 152, 153, 156, 157, 160, 161, 166
22087701	3FH/522	106, 107, 110, 111, 114, 115, 118, 119, 148, 149, 154, 155, 158, 159, 162, 163, 166
22087703	3FH/523	106, 107, 110, 111, 114, 115, 118, 119, 148, 149, 154, 155, 158, 159, 162, 163, 166
22105756	0FH/650	67, 205
22192010	3FH/527	166
22192015	3FH/532	166
22247766	4FH/ 80	91
22249883	4FH/ 90	92
22286149	3FH/505	140
22286155	3FH/504	138
82052484	3FH/ 95	132
82056727	3FH/140	128
82056840	3FH/150	130
82056991	3FH/ 94	132
82060441	3FH/149	131
82060445	3FH/148	131

Cod. Originale O.E.M. Ref. OE Nummer	Cod. Covind Covind Ref. Covind Teilnummer	Pag.Cat. Page Cat. Seite
82062209	3FH/157	130
82063513	3FH/154	131
82063911	3FH/156	130
82065120	3FH/155	-
82065607	3FH/150	130
82065609	3FH/155	-
82066238	3FH/ 97	133
82066335	3FH/ 96	133
82072463	3FH/152	131
82076158	3FH/135	132
82076266	3FH/134	132
82090257	3FH/151	130
82090731	4FH/ 89	92
82090733	4FH/ 87	92
82090735	4FH/ 88	92
82101910	4FH/105	93
82101912	4FH/102	93
82101914	4FH/104	93
82107271	4FH/ 5	100
82114502	3FH/608	133
82114504	3FH/609	133
82136982	4FH/245	99
82141521	4FH/244	99
82141971	4FH/241	99
82142373	4FH/240	99
82151157	4FH/138	96
82151205	4FH/136	96
82166469	4FH/400	98
82171603	4FH/209	99
82177794	4FH/154	95
82178247	4FH/ 4	100
82180491	4FH/151	95
82181355	4FH/255	101
82208510	4FH/155	95

Cod. Originale O.E.M. Ref. OE Nummer	Cod. Covind Covind Ref. Covind Teilnummer	Pag.Cat. Page Cat. Seite
82208510	4FH/156	94
82208512	4FH/152	90, 95
82209788	3FH/ 99	132
82209849	3FH/ 98	132
82215391	3FH/143	128
82215401	3FH/142	128
82219161	4FH/145	97
82220161	4FH/152	90, 95
82220206	4FH/155	95
82255346	4FH/156	94
82258426	4FH/153	94
82285617	4FH/131	96
82328081	4FH/202	100
82328082	4FH/203	100
82360122	4FH/140	97
82367098	3FH/ 99	132
82367957	3FH/ 98	132
82462702	4FH/129	96
82462703	4FH/128	96
82491903	4FH/150	94
82637695	3FH/323	143
82819477	4FH/204	99
82819482	4FH/205	99
82858486	4FH/122	97
82858516	4FH/121	97
82859306	4FH/208	99
82868625	4FH/324	101
82884080	4FH/137	96
82884084	4FH/139	96
82928883	4FH/ 99	91
82943981	4FH/ 98	91
84007259	3FH/323	143
84014254	4FH/410	98
84033228	4FH/145	97

Cod. Originale O.E.M. Ref. OE Nummer	Cod. Covind Covind Ref. Covind Teilnummer	Pag.Cat. Page Cat. Seite
84034942	4FH/128	96
84034945	4FH/129	96
84046776	4FH/132	96
84058023	4FH/131	96
84096588	4FH/203	100
84096589	4FH/202	100
84106936	4FH/324	101
84139886	4FH/129	96
84139933	4FH/128	96
84160721	4FH/324	101
84160723	4FH/324	101
84195623	4FH/ 87	92
84233571	4FH/250	100
-	0FH/144	208
-	0FH/197	54, 72, 137, 187, 219
-	0FH/198	54, 72, 137, 187, 219
-	0FH/508	74, 212
-	0FH/509	76, 214
-	0FH/920	220
-	0FH/921	220
-	0FM/174	55, 73, 136, 186, 218
-	0FM/175	55, 73, 136, 186, 218
-	2FH/110	45, 129, 178
-	2FH/111	45, 129, 178
-	2FH/500	50, 188
-	2FH/501	52, 190
-	3FH/502	50, 188
-	3FH/503	52, 190
-	3FH/506	138
-	3FH/507	140
1083666-6	V12/155	236
1088870-9	V12/ 89	237
1088871-7	V12/ 88	237
1089122-4	V12/ 99	237

Cod. Originale O.E.M. Ref. OE Nummer	Cod. Covind Covind Ref. Covind Teilnummer	Pag.Cat. Page Cat. Seite
1089123-2	V12/ 98	237
1509510-2	V12/214	242
1509511-0	V12/212	242
1509799-1	V12/250	239
1509801-5	V12/251	239
1509805-6	V12/252	239
1509846-0	V12/242	240
1509922-9	V12/211	240
1509924-5	V12/210	240
1509945-0	V12/230	240
1517957-5	V12/108	236
1570986-8	V12/316	243
1578428-3	V12/231	240
158612-6	V12/244	243
1586120-6	V12/244	243
1586124-4	V12/243	243
1588723-5	V12/105	238
1588740-9	V12/216	242
1588741-7	V12/215	242
1594077-8	V12/248	239
1607094-8	V12/370	238
1610782-3	V12/159	238
1610783-1	V12/158	238
1610808-6	V12/204	242
1611178-3	V12/100	237
1612621-1	V12/ 75	240
1612622-9	V12/ 74	240
1614428-9	V12/103	238
1614429-7	V12/102	238
1614456-0	V12/ 85	240
1614457-8	V12/ 84	240
1614458-6	V12/ 87	240
1614459-4	V12/ 86	240
1614460-2	V12/ 83	240

Cod. Originale O.E.M. Ref. OE Nummer	Cod. Covind Covind Ref. Covind Teilnummer	Pag.Cat. Page Cat. Seite
1614461-0	V12/ 82	240
1614490-9	V12/246	243
1614491-7	V12/247	243
1614589-8	V12/317	243
1621181-5	V12/160	236
1623888-3	V12/200	242
1696262-3	V12/104	238
1697967-6	V12/ 7	240
1697968-4	V12/ 6	240
1697976-7	V12/110	238
1698144-1	V12/157	238
1698145-8	V12/156	238
1698146-6	V12/135	237
1698147-4	V12/134	237
1698650-7	V12/ 3	240
1698651-5	V12/ 2	240
(82056986 + 169898-02)	3FH/ 98	132
(82053690 + 169898-01)	3FH/ 99	132
DAF		
85112767	LF0/ 2	6, 25
20707874	LF0/503	14, 34
20707881	LF0/501	10, 30
20708303	LF0/502	12, 32
20743983	LF0/500	8, 28
20832787	LF0/ 2	6, 25
20832788	LF0/ 3	6, 25
20862779	LF0/506	9, 11, 13, 15, 29, 31, 33, 35
20862800	LF0/507	9, 11, 13, 15, 29, 31, 33, 35
20862810	LF0/505	11, 15, 31, 35
20862815	LF0/504	9, 13, 29, 33
20903723	LF0/509	15, 35

Cod. Originale O.E.M. Ref. OE Nummer	Cod. Covind Covind Ref. Covind Teilnummer	Pag.Cat. Page Cat. Seite
20903732	LF0/508	13, 33
21326527	LF0/500	8, 28
21475603	LF0/502	12, 32
85112766	LF0/ 3	6, 25
-	LF0/510	8, 12, 28, 32
-	LF0/512	8, 12, 28, 32
-	LF0/513	10, 14, 30, 34
	LF0/511	10, 14, 30, 34
RENAULT		
385/ 6	20555723	6, 25
385/ 7	20555722	6, 25
385/164	82497194	7, 26
385/164	20557554	7, 26
385/165	82497193	7, 26
385/165	20557552	7, 26
385/174	82497194	7, 26
385/174	20557554	7, 26
385/175	82497193	7, 26
385/175	20557552	7, 26
385/194	24426875	6, 25
385/195	24426873	6, 25
385/210	5010225181	23
385/212	20538011	4, 24
385/213	20538012	4, 24
385/215	5010225398	4, 23
385/215	5010544527	4, 23
385/216	20538248	24
385/217	20538247	24
MDL/240	20538003	4
MDL/241	20538006	4
PRM/ 98	82317469	22
PRM/ 98	20819613	22
PRM/ 99	82317468	22
PRM/ 99	20819616	22

Cod. Originale O.E.M. Ref. OE Nummer	Cod. Covind Covind Ref. Covind Teilnummer	Pag.Cat. Page Cat. Seite
PRM/103	25369343	22
PRM/104	25369342	22
PRM/105	25369341	22
PRM/120	82912803	22
PRM/120	20839504	22
PRM/235	21087113	23, 24
PRM/242	20593735	23
PRM/243	20593721	23
PRM/244	5010578387	24
PRM/244	5010578882	24
PRM/245	5010578381	24
PRM/245	5010578392	24
PRM/496	21011688	199, 231
PRM/496	20843281	199, 231
PRM/497	1079959	199, 231
PRM/504	20862795	8, 11, 13, 15, 29, 31, 33, 35
PRM/508	20903727	9, 29
PRM/509	20903722	11, 31
PRM/510	20721840	60, 84, 168, 196, 228
PRM/512	20708230	9, 13, 29, 33
PRM/513	20708110	11, 15, 31, 35
PRM/515	20498623	60, 84, 168, 196, 228
PRM/522	-	9, 13, 29, 33
PRM/523	-	11, 15, 31, 35
PRM/619	21924924	122, 172
PRM/619	20842821	122, 172
PRM/620	21924923	122, 172
PRM/620	21412897	122, 172
PRM/620	20842848	122, 172
ACCESSORI		
-	930/001	16, 17, 36, 37, 62, 63, 86, 87, 120, 121, 170, 171, 200, 201, 232, 233, 244, 245

Cod. Originale O.E.M. Ref. OE Nummer	Cod. Covind Covind Ref. Covind Teilnummer	Pag.Cat. Page Cat. Seite
-	930/002	16, 17, 36, 37, 62, 63, 86, 87, 120, 121, 170, 171, 200, 201, 232, 233, 244, 245
-	930/033	16, 17, 36, 37, 62, 63, 86, 87, 120, 121, 170, 171, 200, 201, 232, 233, 244, 245
-	930/100	16, 17, 36, 37, 62, 63, 86, 87, 120, 121, 170, 171, 200, 201, 232, 233, 244, 245
-	930/101	16, 17, 36, 37, 62, 63, 86, 87, 120, 121, 170, 171, 200, 201, 232, 233, 244, 245
-	930/200	16, 17, 36, 37, 62, 63, 86, 87, 120, 121, 170, 171, 200, 201, 232, 233, 244, 245
-	940/110	71, 211
-	940/112	237
-	940/113	237
-	940/116	70, 210
-	PDS/360	5, 27, 57, 79, 101, 143, 200, 222, 242

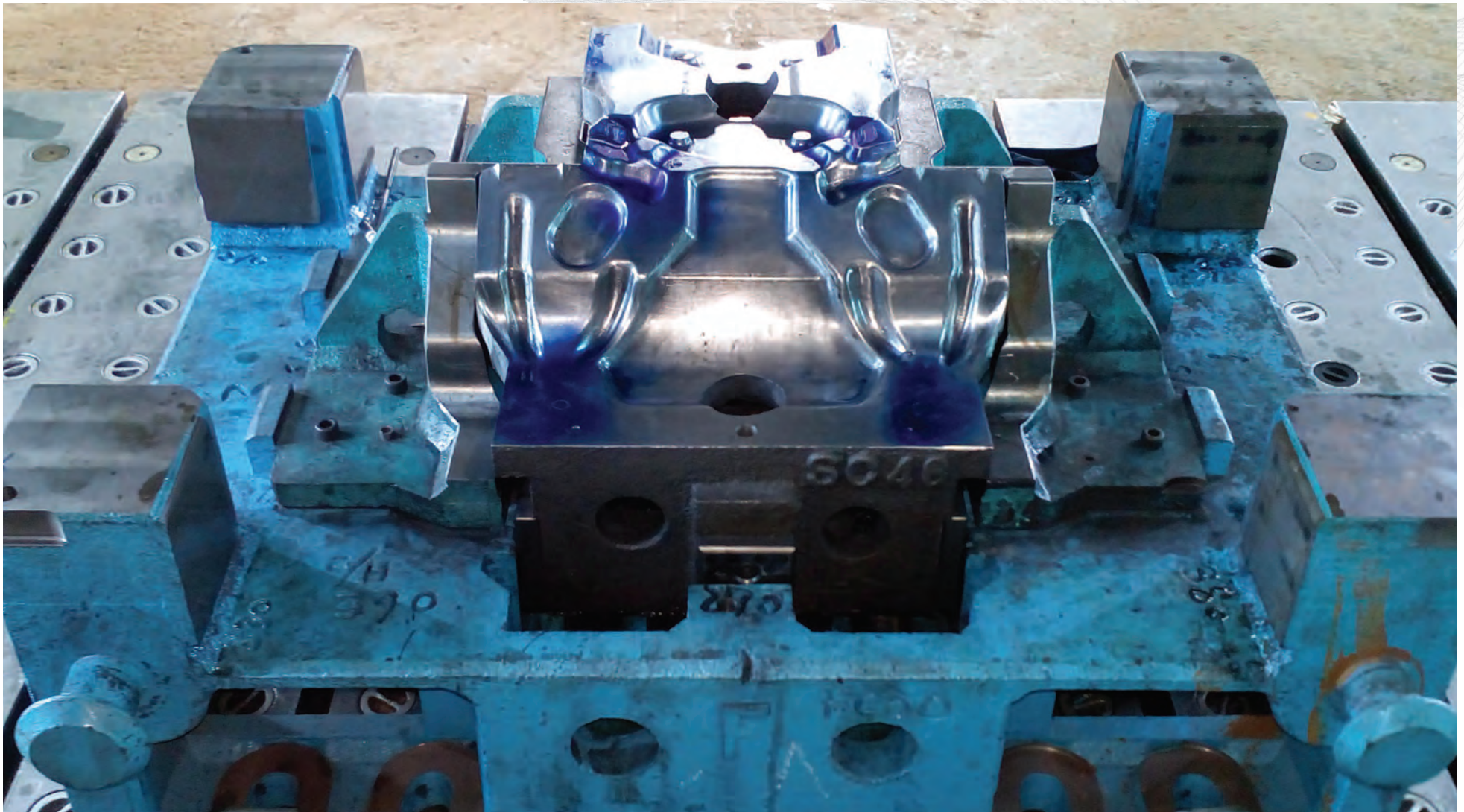

IT Stampo a iniezione per ossatura porta faro
EN Headlamp housing injection moulding
DE Spritzgusswerkzeug für rechten Scheinwerfer traeger



IT Finitura stampo a iniezione per ossatura supporto sinistro
EN Lh support frame injection moulding finishing
DE Spritzgießwerkzeug für Linken Halter Rahmen

Cod. Covind Covind Ref. Covind Teilnummer	Cod. Originale O.E.M. Ref. OE Nummer	Pag.Cat. Page Cat. Seite
0FE/400	20937431	3, 21
0FE/400	20501225	3, 21
0FH/ 4	1086534	219
0FH/ 4	20398908	219
0FH/ 5	1086533	219
0FH/ 5	20398907	219
0FH/ 50	1619106	207
0FH/ 90	8144454	67, 205
0FH/ 90	8189329	67, 205
0FH/ 92	1626680	67, 205
0FH/ 92	20372227	67, 205
0FH/ 93	1626679	67, 205
0FH/ 93	20372226	67, 205
0FH/ 94	8141290	69, 209
0FH/ 95	8141289	69, 209
0FH/ 96	3981256	67, 205
0FH/ 96	8152722	67, 205
0FH/ 96	8189337	67, 205
0FH/105	8189130	207
0FH/105	8189295	207
0FH/105	8191316	207
0FH/110	8191220	207
0FH/134	1062548	209
0FH/134	3090971	209
0FH/134	3980870	209
0FH/134	20398386	209
0FH/135	1062547	209
0FH/135	3090972	209
0FH/135	3980869	209
0FH/135	20398385	209
0FH/144	-	208
0FH/145	8144455	208
0FH/145	20360507	208
0FH/146	8144524	208

Cod. Covind Covind Ref. Covind Teilnummer	Cod. Originale O.E.M. Ref. OE Nummer	Pag.Cat. Page Cat. Seite
0FH/147	8144525	208
0FH/148	8144527	208
0FH/149	8144526	208
0FH/150	1063509	69, 209
0FH/150	8144482	69, 209
0FH/155	3175863	69, 209
0FH/155	8189467	69, 209
0FH/160	1619149	207
0FH/160	8189093	207
0FH/161	1619148	207
0FH/161	8189092	207
0FH/164	1063292	55, 73, 136, 186, 218
0FH/164	1063837	55, 73, 136, 186, 218
0FH/164	3176537	55, 73, 136, 186, 218
0FH/164	3176542	55, 73, 136, 186, 218
0FH/164	3176546	55, 73, 136, 186, 218
0FH/164	3981924	55, 73, 136, 186, 218
0FH/165	1063291	55, 73, 136, 186, 218
0FH/165	1063836	55, 73, 136, 186, 218
0FH/165	3176536	55, 73, 136, 186, 218
0FH/165	3176541	55, 73, 136, 186, 218
0FH/165	3176545	55, 73, 136, 186, 218
0FH/165	3981923	55, 73, 136, 186, 218
0FH/166	1606375	186, 218
0FH/166	3953182	186, 218
0FH/168	1062011	55, 73, 136, 186, 218
0FH/168	3176550	55, 73, 136, 186, 218
0FH/169	1062010	55, 73, 136, 186, 218
0FH/169	3176549	55, 73, 136, 186, 218
0FH/190	3175029	54, 72, 134, 184, 216
0FH/191	20379593	185, 217
0FH/192	1063328	135, 185, 217
0FH/193	1063327	135, 185, 217
0FH/194	1062566	54, 72, 137, 187, 219

Cod. Covind Covind Ref. Covind Teilnummer	Cod. Originale O.E.M. Ref. OE Nummer	Pag.Cat. Page Cat. Seite
0FH/194	3175919	54, 72, 137, 187, 219
0FH/194	20398467	54, 72, 137, 187, 219
0FH/195	1062565	54, 72, 137, 187, 219
0FH/195	3175918	54, 72, 137, 187, 219
0FH/195	20398466	54, 72, 137, 187, 219
0FH/196	3090484	54, 72, 137, 187, 219
0FH/197	-	54, 72, 137, 187, 219
0FH/198	-	54, 72, 137, 187, 219
0FH/199	3981043	192, 221
0FH/199	20529765	192, 221
0FH/200	3175247	220
0FH/200	3981764	220
0FH/200	8144108	220
0FH/200	8189196	220
0FH/200	8189301	220
0FH/201	3175246	220
0FH/201	3981762	220
0FH/201	8144107	220
0FH/201	8189195	220
0FH/201	8189300	220
0FH/204	8122894	221
0FH/204	8141237	221
0FH/205	8122893	221
0FH/205	8141236	221
0FH/210	8191315	143, 193, 220, 223
0FH/210	20379439	143, 193, 220, 223
0FH/212	8191314	220, 223
0FH/212	20379438	220, 223
0FH/215	8191313	223
0FH/215	20379437	223
0FH/240	8141004	221
0FH/241	8141003	221
0FH/242	8141313	222
0FH/242	8191103	222

Cod. Covind Covind Ref. Covind Teilnummer	Cod. Originale O.E.M. Ref. OE Nummer	Pag.Cat. Page Cat. Seite
OFH/243	8141312	222
OFH/320	1623459	222
OFH/321	8156540	222
OFH/400	8140923	206
OFH/400	8189318	206
OFH/506	3092854	75, 77, 213, 215
OFH/506	20854564	75, 77, 213, 215
OFH/507	21203311	75, 77, 213, 215
OFH/508	-	74, 212
OFH/509	-	76, 214
OFH/510	1599297	80, 224
OFH/510	8156556	80, 224
OFH/512	3091751	75, 213
OFH/513	3091750	77, 215
OFH/515	8155808	80, 81, 224, 225
OFH/515	8190106	80, 81, 224, 225
OFH/518	8156551	80, 81, 224, 225
OFH/518	8156552	80, 81, 224, 225
OFH/519	8156554	80, 81, 224, 225
OFH/520	1077451	61, 85, 169, 198, 229
OFH/520	8154385	61, 85, 169, 198, 229
OFH/521	3197851	61, 85, 169, 198, 229
OFH/521	20466895	61, 85, 169, 198, 229
OFH/522	3197850	61, 85, 167, 197, 230
OFH/522	20466894	61, 85, 167, 197, 230
OFH/526	20382890	167, 197, 230
OFH/527	20383038	167, 197, 230
OFH/604	3981668	71, 211
OFH/610	3981666	71, 211
OFH/610	8191142	71, 211
OFH/650	1062190	67, 205
OFH/650	22105756	67, 205
OFH/670	9520400	64, 202, 234, 242
OFH/670	20896946	64, 202, 234, 242

Cod. Covind Covind Ref. Covind Teilnummer	Cod. Originale O.E.M. Ref. OE Nummer	Pag.Cat. Page Cat. Seite
OFH/700	1614048	-
OFH/700	3175032	-
OFH/710	3981593	70, 210
OFH/800	1619254	208
OFH/920	-	220
OFH/921	-	220
OFL/400	20743944	2, 20
OFL/400	20937442	2, 20
OFL/480	20819179	2, 20
OFM/ 50	8191439	68
OFM/110	8191421	68
OFM/134	8191570	69
OFM/134	20398388	69
OFM/134	20398390	69
OFM/135	1062163	69
OFM/135	20398387	69
OFM/135	20398389	69
OFM/145	8191406	68
OFM/160	8191412	68
OFM/161	8191409	68
OFM/170	8140016	7, 55, 73
OFM/174	-	55, 73, 136, 186, 218
OFM/175	-	55, 73, 136, 186, 218
OFM/198	8191781	79
OFM/199	8191780	79
OFM/200	3175159	56, 78
OFM/200	20529483	56, 78
OFM/201	3175158	56, 78
OFM/201	20425469	56, 78
OFM/201	20529478	56, 78
OFM/201	20537185	56, 78
OFM/206	8191779	78
OFM/206	20530083	78
OFM/207	8191778	78

Cod. Covind Covind Ref. Covind Teilnummer	Cod. Originale O.E.M. Ref. OE Nummer	Pag.Cat. Page Cat. Seite
OFM/207	20530082	78
OFM/210	1063726	56, 78
OFM/216	8191827	-
OFM/217	8191826	-
OFM/240	1062134	78
OFM/240	8191594	78
OFM/241	1062133	78
OFM/241	8191593	78
2FH/ 2	20360543	137, 187, 219
2FH/ 3	20360542	137, 187, 219
2FH/ 4	20467038	137, 187
2FH/ 4	21300059	137, 187
2FH/ 5	20467037	137, 187
2FH/ 5	21299955	137, 187
2FH/ 6	1623148	134, 184, 216
2FH/ 6	20372038	134, 184, 216
2FH/ 6	20398136	134, 184, 216
2FH/ 7	1623147	134, 184, 216
2FH/ 7	20372037	134, 184, 216
2FH/ 7	20398135	134, 184, 216
2FH/ 9	1062636	134, 184, 216
2FH/ 10	1062637	134, 184, 216
2FH/ 10	20372039	134, 184, 216
2FH/ 50	20379348	129, 178
2FH/ 80	20398709	41, 125, 174
2FH/ 80	20429679	41, 125, 174
2FH/ 80	20711859	41, 125, 174
2FH/ 80	21828914	41, 125, 174
2FH/ 84	20398708	41, 125, 174
2FH/ 84	20429681	41, 125, 174
2FH/ 84	20711861	41, 125, 174
2FH/ 84	21829052	41, 125, 174
2FH/ 85	20398707	41, 125, 174
2FH/ 85	20429680	41, 125, 174

Cod. Covind Covind Ref. Covind Teilnummer	Cod. Originale O.E.M. Ref. OE Nummer	Pag.Cat. Page Cat. Seite
2FH/ 85	20711860	41, 125, 174
2FH/ 85	21829051	41, 125, 174
2FH/ 86	20456804	44, 127, 176
2FH/ 86	21430599	44, 127, 176
2FH/ 87	20456806	44, 127, 176
2FH/ 87	21430672	44, 127, 176
2FH/ 88	20456805	44, 127, 176
2FH/ 88	21430600	44, 127, 176
2FH/ 89	3175417	43, 126, 175
2FH/ 89	20529740	43, 126, 175
2FH/ 90	20425625	42, 126, 175
2FH/ 90	21359080	42, 126, 175
2FH/ 92	20425627	42, 126, 175
2FH/ 92	21359090	42, 126, 175
2FH/ 93	20425626	42, 126, 175
2FH/ 93	21359082	42, 126, 175
2FH/ 94	20453931	47, 181
2FH/ 94	20507021	47, 181
2FH/ 94	21359260	47, 181
2FH/ 95	20453930	47, 181
2FH/ 95	20507020	47, 181
2FH/ 95	21359257	47, 181
2FH/ 96	3175419	43, 126, 175
2FH/ 96	20529742	43, 126, 175
2FH/ 97	3175418	43, 126, 175
2FH/ 97	20529741	43, 126, 175
2FH/ 98	20453628	47, 181
2FH/ 98	20534601	47, 181
2FH/ 98	20827044	47, 181
2FH/ 98	20917958	47, 181
2FH/ 99	20453627	47, 181
2FH/ 99	20534600	47, 181
2FH/ 99	20827042	47, 181
2FH/ 99	20917957	47, 181

Cod. Covind Covind Ref. Covind Teilnummer	Cod. Originale O.E.M. Ref. OE Nummer	Pag.Cat. Page Cat. Seite
2FH/100	20456550	125, 174
2FH/100	20467442	125, 174
2FH/100	21484901	125, 174
2FH/110	3175366	45, 129, 178
2FH/110	3175367	45, 129, 178
2FH/110	20530146	45, 129, 178
2FH/110	-	45, 129, 178
2FH/111	3175366	45, 129, 178
2FH/111	20383543	45, 129, 178
2FH/111	20529738	45, 129, 178
2FH/111	-	45, 129, 178
2FH/115	20467053	178
2FH/132	20452848	46, 180
2FH/133	20452847	46, 180
2FH/134	20452887	46, 180
2FH/134	21469924	46, 180
2FH/135	20452886	46, 180
2FH/135	21469918	46, 180
2FH/136	20425419	47, 181
2FH/136	20826231	47, 181
2FH/136	21469979	47, 181
2FH/137	20425418	47, 181
2FH/137	20826227	47, 181
2FH/137	21430598	47, 181
2FH/142	20467143	177
2FH/143	20467142	177
2FH/145	20360266	177
2FH/148	20545095	183
2FH/149	20545094	183
2FH/150	20453716	46, 180
2FH/150	20516776	46, 180
2FH/150	21358670	46, 180
2FH/150	21430596	46, 180
2FH/152	20409818	48, 183

Cod. Covind Covind Ref. Covind Teilnummer	Cod. Originale O.E.M. Ref. OE Nummer	Pag.Cat. Page Cat. Seite
2FH/153	20456963	48, 183
2FH/154	3175546	49, 182
2FH/154	20529706	49, 182
2FH/155	3175545	49, 182
2FH/155	20529705	49, 182
2FH/156	3175548	49, 182
2FH/156	20529708	49, 182
2FH/157	3175547	49, 182
2FH/157	20529707	49, 182
2FH/158	20529704	-
2FH/159	20533138	-
2FH/160	20379176	128, 177
2FH/161	20379175	128, 177
2FH/162	20379358	128, 177
2FH/162	20529672	128, 177
2FH/163	20379357	128, 177
2FH/163	20529668	128, 177
2FH/180	21261275	135, 185, 217
2FH/180	21505894	135, 185, 217
2FH/181	21261274	135, 185, 217
2FH/181	21505893	135, 185, 217
2FH/190	20570722	135, 185, 217
2FH/191	20570721	135, 185, 217
2FH/200	3175928	142, 192
2FH/201	3175927	142, 192
2FH/204	3175934	142, 192
2FH/204	20529684	142, 192
2FH/205	3175933	142, 192
2FH/205	20529682	142, 192
2FH/206	3175930	142, 192
2FH/206	21302470	142, 192
2FH/207	3175929	142, 192
2FH/207	21302461	142, 192
2FH/208	20360789	56, 143, 193

Cod. Covind Covind Ref. Covind Teilnummer	Cod. Originale O.E.M. Ref. OE Nummer	Pag.Cat. Page Cat. Seite
2FH/209	20360788	56, 143, 193
2FH/236	20453677	41, 125, 174
2FH/237	20453676	41, 125, 174
2FH/240	3175407	56, 142, 192
2FH/240	20529640	56, 142, 192
2FH/241	3175406	56, 142, 192
2FH/241	20529638	56, 142, 192
2FH/316	20372065	193
2FH/317	20372064	193
2FH/325	20453900	193
2FH/400	20456709	179
2FH/480	20467412	179
2FH/480	20467414	179
2FH/480	20467422	179
2FH/480	20467424	179
2FH/500	-	50, 188
2FH/501	-	52, 190
2FH/502	20746401	51, 53, 189, 191
2FH/503	20589788	51, 53, 139, 141, 189, 191
2FH/503	21320404	51, 53, 139, 141, 189, 191
2FH/504	20455995	51, 53, 189, 191
2FH/504	20567685	51, 53, 189, 191
2FH/504	21320300	51, 53, 189, 191
2FH/505	20392544	58, 59, 61, 82, 83, 85, 164, 165, 167, 194, 195, 197, 199, 226, 227, 231
2FH/508	20360811	51, 53, 189, 191
2FH/510	1079981	60, 84, 168, 196, 228
2FH/513	20498620	60, 84, 168, 196, 228
2FH/513	20583434	60, 84, 168, 196, 228
2FH/514	3987253	60, 84, 168, 196, 228
2FH/514	20583440	60, 84, 168, 196, 228
2FH/515	1079965	58, 59, 82, 83, 164, 165, 194, 195, 226, 227

Cod. Covind Covind Ref. Covind Teilnummer	Cod. Originale O.E.M. Ref. OE Nummer	Pag.Cat. Page Cat. Seite
2FH/515	3171391	58, 59, 82, 83, 164, 165, 194, 195, 226, 227
2FH/515	20722652	58, 59, 82, 83, 164, 165, 194, 195, 226, 227
2FH/515	20936759	58, 59, 82, 83, 164, 165, 194, 195, 226, 227
2FH/517	3987252	58, 60, 82, 84, 164, 168, 194, 196, 226, 228
2FH/517	20583434	58, 60, 82, 84, 164, 168, 194, 196, 226, 228
2FH/518	20392599	58, 59, 82, 83, 164, 165, 194, 195, 199, 226, 227, 231
2FH/520	20722654	58, 59, 82, 83, 164, 165, 194, 195, 226, 227
2FH/520	20936769	58, 59, 82, 83, 164, 165, 194, 195, 226, 227
2FH/600	20861584	-
2FH/601	20861583	-
2FH/604	20409875	-
2FH/605	20409874	-
2FH/606	20409875	47, 181
2FH/606	20826213	47, 181
2FH/607	20409874	47, 181
2FH/607	20826211	47, 181
2FH/610	20789440	57
2FH/619	3127594	27, 64, 202, 234
2FH/619	20507252	27, 64, 202, 234
2FH/620	1676400	-
2FH/800	20382691	-
2FM/ 50	20379349	45
2FM/144	20523232	-
2FM/144	20888780	-
2FM/145	3175376	45

Cod. Covind Covind Ref. Covind Teilnummer	Cod. Originale O.E.M. Ref. OE Nummer	Pag.Cat. Page Cat. Seite
2FM/146	20391451	-
2FM/147	20391452	-
2FM/148	20391450	-
2FM/149	20372123	-
2FM/160	20379172	-
2FM/161	20379171	-
3FH/ 85	20453690	49, 130, 182
3FH/ 85	21425186	49, 130, 182
3FH/ 94	21451002	132
3FH/ 94	82056991	132
3FH/ 95	21451000	132
3FH/ 95	82052484	132
3FH/ 96	82066335	133
3FH/ 97	82066238	133
3FH/ 98	82209849	132
3FH/ 98	82367957	132
3FH/ 98	(82056986 +	169898-02)
3FH/ 99	82209788	132
3FH/ 99	82367098	132
3FH/ 99	82053690 +	169898-01)
3FH/134	21478755	132
3FH/134	82076266	132
3FH/135	21478759	132
3FH/135	82076158	132
3FH/136	21078545	133
3FH/137	21078543	133
3FH/140	21190825	128
3FH/140	82056727	128
3FH/142	82215401	128
3FH/143	82215391	128
3FH/148	82060445	131
3FH/149	82060441	131

Cod. Covind Covind Ref. Covind Teilnummer	Cod. Originale O.E.M. Ref. OE Nummer	Pag.Cat. Page Cat. Seite
3FH/150	21445302	130
3FH/150	82056840	130
3FH/150	82065607	130
3FH/151	21445754	130
3FH/151	82090257	130
3FH/152	82072463	131
3FH/154	82063513	131
3FH/155	21478481	-
3FH/155	82065120	-
3FH/155	82065609	-
3FH/156	82063911	130
3FH/157	82062209	130
3FH/323	82637695	143
3FH/323	84007259	143
3FH/502	-	50, 188
3FH/503	-	52, 190
3FH/504	22286155	138
3FH/505	22286149	140
3FH/506	-	138
3FH/507	-	140
3FH/508	20841436	139, 141
3FH/509	20589798	139, 141
3FH/509	21070768	139, 141
3FH/509	21320365	139, 141
3FH/510	21094457	102, 104, 106, 108, 110, 112, 114, 116, 118, 144, 146, 148, 150, 152, 154, 156, 158, 160, 162
3FH/511	20746402	139, 141
3FH/511	21169974	139, 141
3FH/515	21094391	102, 103, 104, 105, 108, 109, 112, 113, 116, 117, 144, 145, 146, 147, 150, 151, 152, 153, 156, 157,

Cod. Covind Covind Ref. Covind Teilnummer	Cod. Originale O.E.M. Ref. OE Nummer	Pag.Cat. Page Cat. Seite
		160, 161, 166
3FH/515	22087684	102, 103, 104, 105, 108, 109, 112, 113, 116, 117, 144, 145, 146, 147, 150, 151, 152, 153, 156, 157, 160, 161, 166
3FH/520	21094388	108, 109, 110, 111, 150, 151, 152, 153, 154, 155
3FH/522	21094392	106, 107, 110, 111, 114, 115, 118, 119, 148, 149, 154, 155, 158, 159, 162, 163, 166
3FH/522	21305345	106, 107, 110, 111, 114, 115, 118, 119, 148, 149, 154, 155, 158, 159, 162, 163, 166
3FH/522	22087701	106, 107, 110, 111, 114, 115, 118, 119, 148, 149, 154, 155, 158, 159, 162, 163, 166
3FH/523	21094393	106, 107, 110, 111, 114, 115, 118, 119, 148, 149, 154, 155, 158, 159, 162, 163, 166
3FH/523	21305346	106, 107, 110, 111, 114, 115, 118, 119, 148, 149, 154, 155, 158, 159, 162, 163, 166
3FH/523	22087703	106, 107, 110, 111, 114, 115, 118, 119, 148, 149, 154, 155, 158, 159, 162, 163, 166
3FH/524	21094447	102, 144, 150
3FH/525	21094394	104, 105, 106, 107, 108,

Cod. Covind Covind Ref. Covind Teilnummer	Cod. Originale O.E.M. Ref. OE Nummer	Pag.Cat. Page Cat. Seite
		109, 110, 111, 112, 113, 114, 115, 116, 117, 118, 119, 146, 147, 148, 149, 152, 153, 154, 155, 156, 157, 158, 159, 160, 161, 162, 163, 166
3FH/525	21094400	104, 105, 106, 107, 108, 109, 110, 111, 112, 113, 114, 115, 116, 117, 118, 119, 146, 147, 148, 149, 152, 153, 154, 155, 156, 157, 158, 159, 160, 161, 162, 163, 166
3FH/526	21094454	166
3FH/526	21094456	166
3FH/527	21094411	166
3FH/527	22192010	166
3FH/528	21094410	166
3FH/530	21094383	112, 113, 114, 115, 156, 157, 158, 159
3FH/530	21094387	112, 113, 114, 115, 156, 157, 158, 159
3FH/532	21094413	166
3FH/532	22192015	166
3FH/535	21094389	116, 117, 118, 119, 160, 161, 162, 163
3FH/540	21094386	102, 103, 104, 105, 106, 107, 144, 145, 146, 147, 148, 149
3FH/540	21094390	102, 103, 104, 105, 106, 107, 144, 145, 146, 147, 148, 149
3FH/608	21478751	133
3FH/608	82114502	133

Cod. Covind Covind Ref. Covind Teilnummer	Cod. Originale O.E.M. Ref. OE Nummer	Pag.Cat. Page Cat. Seite
3FH/609	21448885	133
3FH/609	82114504	133
3FH/619	20541447	-
4FH/ 4	21642399	100
4FH/ 4	82178247	100
4FH/ 5	21642377	100
4FH/ 5	82107271	100
4FH/ 80	21838943	91
4FH/ 80	22247766	91
4FH/ 84	21838945	91
4FH/ 85	21838944	91
4FH/ 87	21413787	92
4FH/ 87	82090733	92
4FH/ 87	84195623	92
4FH/ 88	21413786	92
4FH/ 88	82090735	92
4FH/ 89	21413789	92
4FH/ 89	82090731	92
4FH/ 90	21316576	92
4FH/ 90	22249883	92
4FH/ 92	21316577	92
4FH/ 93	21316575	92
4FH/ 95	21495267	93
4FH/ 96	21495268	93
4FH/ 97	21495266	93
4FH/ 98	82943981	91
4FH/ 99	82928883	91
4FH/102	82101912	93
4FH/104	82101914	93
4FH/105	82101910	93
4FH/121	82858516	97
4FH/122	82858486	97
4FH/128	82462703	96
4FH/128	84034942	96

Cod. Covind Covind Ref. Covind Teilnummer	Cod. Originale O.E.M. Ref. OE Nummer	Pag.Cat. Page Cat. Seite
4FH/128	84139933	96
4FH/129	82462702	96
4FH/129	84034945	96
4FH/129	84139886	96
4FH/131	82285617	96
4FH/131	84058023	96
4FH/132	84046776	96
4FH/134	21874457	96
4FH/135	21874450	96
4FH/136	82151205	96
4FH/137	82884080	96
4FH/138	82151157	96
4FH/139	82884084	96
4FH/140	82360122	97
4FH/145	82219161	97
4FH/145	84033228	97
4FH/150	82491903	94
4FH/151	82180491	95
4FH/152	82208512	90, 95
4FH/152	82220161	90, 95
4FH/153	82258426	94
4FH/154	82177794	95
4FH/155	82208510	95
4FH/155	82220206	95
4FH/156	82208510	94
4FH/156	82255346	94
4FH/202	82328081	100
4FH/202	84096589	100
4FH/203	82328082	100
4FH/203	84096588	100
4FH/204	82819477	99
4FH/205	82819482	99
4FH/208	82859306	99
4FH/209	82171603	99

Cod. Covind Covind Ref. Covind Teilnummer	Cod. Originale O.E.M. Ref. OE Nummer	Pag.Cat. Page Cat. Seite
4FH/240	82142373	99
4FH/241	82141971	99
4FH/242	21344649	99
4FH/242	21392187	99
4FH/243	21344647	99
4FH/243	21392183	99
4FH/244	82141521	99
4FH/245	82136982	99
4FH/250	21413763	100
4FH/250	84233571	100
4FH/251	21940892	100
4FH/255	21413732	101
4FH/255	82181355	101
4FH/324	82868625	101
4FH/324	84106936	101
4FH/324	84160721	101
4FH/324	84160723	101
4FH/400	82166469	98
4FH/410	84014254	98
V12/ 2	1698651-5	240
V12/ 3	1698650-7	240
V12/ 6	1697968-4	240
V12/ 7	1697967-6	240
V12/ 74	1612622-9	240
V12/ 75	1612621-1	240
V12/ 82	1614461-0	240
V12/ 83	1614460-2	240
V12/ 84	1614457-8	240
V12/ 85	1614456-0	240
V12/ 86	1614459-4	240
V12/ 87	1614458-6	240
V12/ 88	1088871-7	237
V12/ 89	1088870-9	237
V12/ 90	1080926	236

Cod. Covind Covind Ref. Covind Teilnummer	Cod. Originale O.E.M. Ref. OE Nummer	Pag.Cat. Page Cat. Seite
V12/ 90	8150689	236
V12/ 90	8158216	236
V12/ 98	1621904	237
V12/ 98	1089123-2	237
V12/ 99	1621903	237
V12/ 99	1089122-4	237
V12/100	1611178-3	237
V12/102	1614429-7	238
V12/103	1614428-9	238
V12/104	1696262-3	238
V12/105	1588723-5	238
V12/108	1517957-5	236
V12/110	1697976-7	238
V12/111	1621183	237
V12/112	1621182	237
V12/113	1508953	241
V12/115	1508954	241
V12/134	1621185	237
V12/134	1698147-4	237
V12/135	1621184	237
V12/135	1698146-6	237
V12/155	1621376	236
V12/155	1083666-6	236
V12/156	1521324	238
V12/156	1698145-8	238
V12/157	1621325	238
V12/157	1698144-1	238
V12/158	1610783-1	238
V12/159	1610782-3	238
V12/160	1621181-5	236
V12/162	1570898	241
V12/163	1570897	241
V12/168	1607898	236
V12/169	1612331	236

Cod. Covind Covind Ref. Covind Teilnummer	Cod. Originale O.E.M. Ref. OE Nummer	Pag.Cat. Page Cat. Seite
V12/171	680663	241
V12/172	680662	241
V12/173	677950	241
V12/174	1082466	241
V12/175	1082467	241
V12/179	1570896	241
V12/180	1570895	241
V12/196	687895	241
V12/196	1254749	241
V12/196	1605245	241
V12/200	1623888-3	242
V12/203	1610809	242
V12/204	1610808-6	242
V12/210	1509924-5	240
V12/211	1509922-9	240
V12/212	1509511-0	242
V12/214	1509510-2	242
V12/215	1588741-7	242
V12/216	1588740-9	242
V12/230	1089967	240
V12/230	1509945-0	240
V12/231	1578428-3	240
V12/242	1509846-0	240
V12/243	1589309	243
V12/243	1586124-4	243
V12/244	158612-6	243
V12/244	1586120-6	243
V12/246	1614490-9	243
V12/247	1614491-7	243
V12/248	1594077-8	239
V12/250	1509799-1	239
V12/251	1509801-5	239
V12/252	1509805-6	239
V12/257	1593174	239

Cod. Covind Covind Ref. Covind Teilnummer	Cod. Originale O.E.M. Ref. OE Nummer	Pag.Cat. Page Cat. Seite
V12/260	1591558	239
V12/270	1509937	239
V12/271	1607178	239
V12/316	1570986-8	243
V12/317	1614589-8	243
V12/340	1660358	239
V12/340	1664215	239
V12/343	1661382	239
V12/345	1661854	239
V12/347	1665132	239
V12/370	1607094-8	238
V12/375	1592458	238
V12/426	1610788	238
V12/427	1610787	238
V12/428	1590948	238
V12/429	1590947	238
V12/600	1573732	242
V12/600	1623942	242
V12/700	3175032	237
V12/800	1591146	236
DAF		
LF0/ 2	85112767	6, 25
LF0/ 2	20832787	6, 25
LF0/ 3	85112766	6, 25
LF0/ 3	20832788	6, 25
LF0/500	21326527	8, 28
LF0/500	20743983	8, 28
LF0/501	20707881	10, 30
LF0/502	21475603	12, 32
LF0/502	20708303	12, 32
LF0/503	20707874	14, 34
LF0/504	20862815	9, 13, 29, 33
LF0/505	20862810	11, 15, 31, 35
LF0/506	20862779	9, 11, 13, 15, 29, 31, 33, 35

Cod. Covind Covind Ref. Covind Teilnummer	Cod. Originale O.E.M. Ref. OE Nummer	Pag.Cat. Page Cat. Seite
LF0/507	20862800	9, 11, 13, 15, 29, 31, 33, 35
LF0/508	20903732	13, 33
LF0/509	20903723	15, 35
LF0/510	-	8, 12, 28, 32
LF0/511	-	10, 14, 30, 34
LF0/512	-	8, 12, 28, 32
LF0/513	-	10, 14, 30, 34
RENAULT		
385/ 6	20555723	6, 25
385/ 7	20555722	6, 25
385/164	82497194	7, 26
385/164	20557554	7, 26
385/165	82497193	7, 26
385/165	20557552	7, 26
385/174	82497194	7, 26
385/174	20557554	7, 26
385/175	82497193	7, 26
385/175	20557552	7, 26
385/194	24426875	6, 25
385/195	24426873	6, 25
385/210	5010225181	23
385/212	20538011	4, 24
385/213	20538012	4, 24
385/215	5010225398	4, 23
385/215	5010544527	4, 23
385/216	20538248	24
385/217	20538247	24
MDL/240	20538003	4
MDL/241	20538006	4
PRM/ 98	82317469	22
PRM/ 98	20819613	22
PRM/ 99	82317468	22
PRM/ 99	20819616	22
PRM/103	25369343	22

Cod. Covind Covind Ref. Covind Teilnummer	Cod. Originale O.E.M. Ref. OE Nummer	Pag.Cat. Page Cat. Seite
PRM/104	25369342	22
PRM/105	25369341	22
PRM/120	82912803	22
PRM/120	20839504	22
PRM/235	21087113	23, 24
PRM/242	20593735	23
PRM/243	20593721	23
PRM/244	5010578387	24
PRM/244	5010578882	24
PRM/245	5010578381	24
PRM/245	5010578392	24
PRM/496	21011688	199, 231
PRM/496	20843281	199, 231
PRM/497	1079959	199, 231
PRM/504	20862795	8, 11, 13, 15, 29, 31, 33, 35
PRM/508	20903727	9, 29
PRM/509	20903722	11, 31
PRM/510	20721840	60, 84, 168, 196, 228
PRM/512	20708230	9, 13, 29, 33
PRM/513	20708110	11, 15, 31, 35
PRM/515	20498623	60, 84, 168, 196, 228
PRM/522	-	9, 13, 29, 33
PRM/523	-	11, 15, 31, 35
PRM/619	21924924	122, 172
PRM/619	20842821	122, 172
PRM/620	21924923	122, 172
PRM/620	21412897	122, 172
PRM/620	20842848	122, 172
ACCESSORI		
930/001	-	16, 17, 36, 37, 62, 63, 86, 87, 120, 121, 170, 171, 200, 201, 232, 233, 244, 245
930/002	-	16, 17, 36, 37, 62, 63, 86,

Cod. Covind Covind Ref. Covind Teilnummer	Cod. Originale O.E.M. Ref. OE Nummer	Pag.Cat. Page Cat. Seite
		87, 120, 121, 170, 171, 200, 201, 232, 233, 244, 245
930/033	-	16, 17, 36, 37, 62, 63, 86, 87, 120, 121, 170, 171, 200, 201, 232, 233, 244, 245
930/100	-	16, 17, 36, 37, 62, 63, 86, 87, 120, 121, 170, 171, 200, 201, 232, 233, 244, 245
930/101	-	16, 17, 36, 37, 62, 63, 86, 87, 120, 121, 170, 171, 200, 201, 232, 233, 244, 245
930/200	-	16, 17, 36, 37, 62, 63, 86, 87, 120, 121, 170, 171, 200, 201, 232, 233, 244, 245
940/110	-	71, 211
940/112	-	237
940/113	-	237
940/116	-	70, 210
PDS/360	-	5, 27, 57, 79, 101, 143, 200, 222, 242



applicabile a | suitable to | verwendbar für

1

OFL
FL 2006

applicabile a | suitable to | verwendbar für:

FL 2006



OFL/400

O.E. 20937442 | 20743944

Adattabile a:
Suitable to:
passend für:

FE-FL-VM

Materiale | Material:
PMMA - ACRYLGLAS



L	H	P	kg.
cm.	cm.	cm.	
212	56	25	5,315



OFL/480

O.E. 20819179

KIT completo
di staffe
e minuterie.
Assembly KIT.
Befestigungssatz



L'immagine del prodotto è da considerarsi puramente indicativa | The product image is just for information | Die Produktbilder sind nur zur Information.

Adattabile a:
Suitable to:
passend für:

FE-FL-VM

Materiale | Material:
PMMA - ACRYLGLAS



KIT completo di staffe e minuterie
IN ALLESTIMENTO
KIT complete of brackets and findings
NOT AVAILABLE YET
Befestigungssatz
IN ARBEIT



L	H	P	kg.
cm.	cm.	cm.	
192	40	25	5,120

applicabile a l suitable to l verwendbar für:

FL 2006

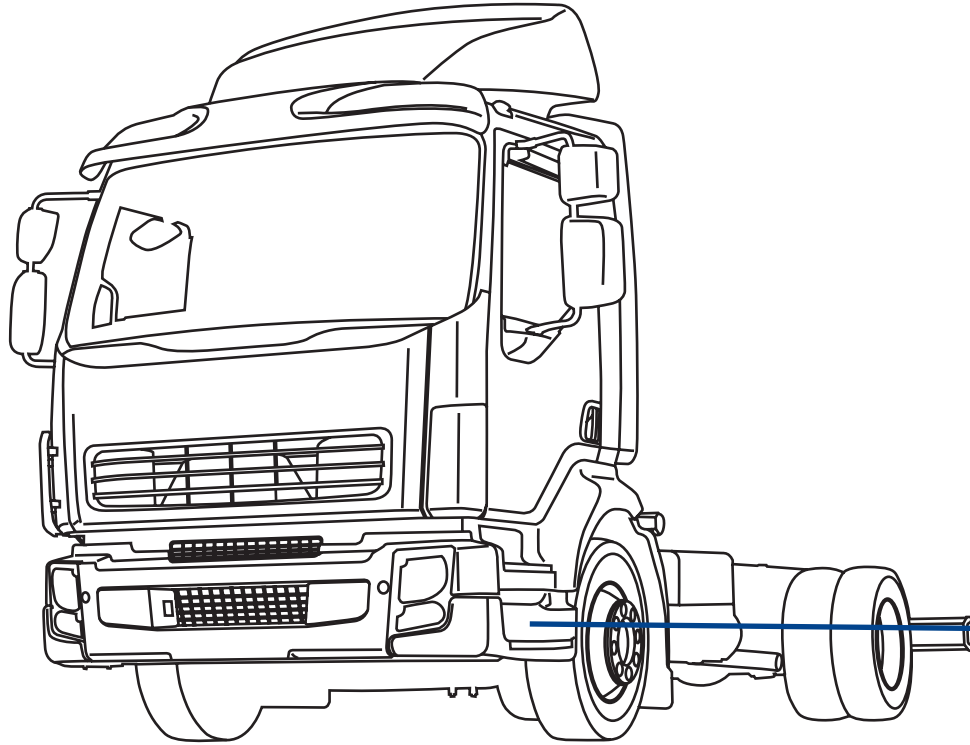

MDL/240 d-rh-rechts
MDL/241 s-lh-links

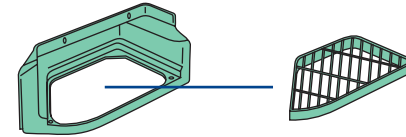

385/215
d|s-rh|lh-rechts|links
alluminio
aluminium
Aluminium

385/212 d-rh-rechts
385/213 s-lh-links
polipropilene
polypropylene
Polypropylen



MDL/240
O.E.M. 20538003
MDL/241
O.E.M. 20538006



385/212
O.E.M. 20538011
385/213
O.E.M. 20538012



385/215
O.E.M. 5010225398

FL 2006

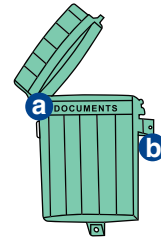
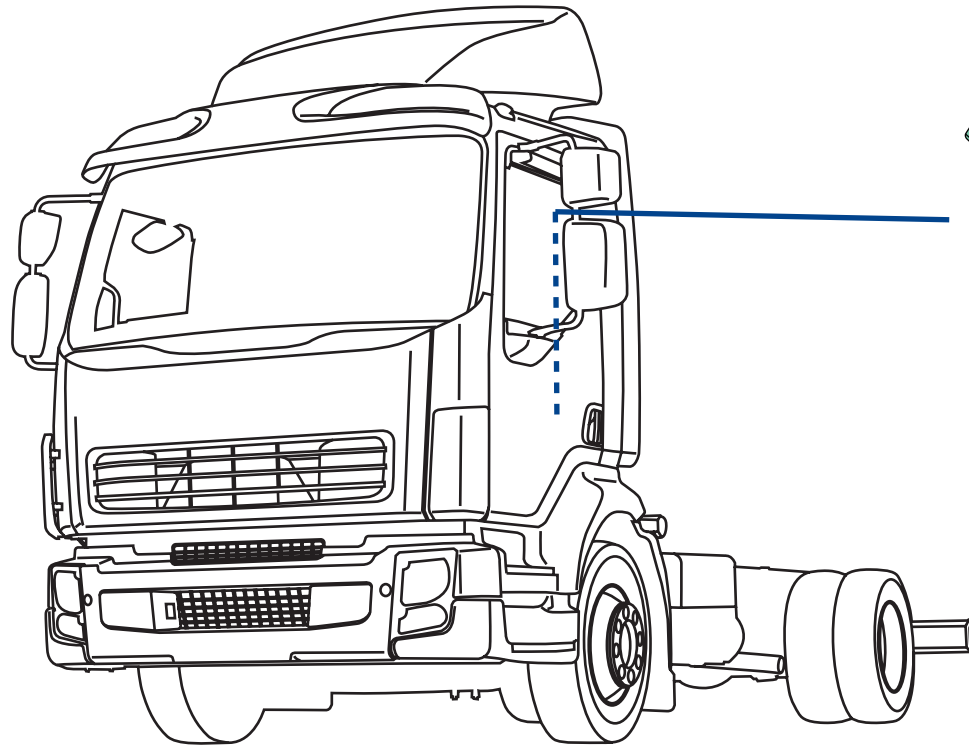

PDS/360

PDS/360

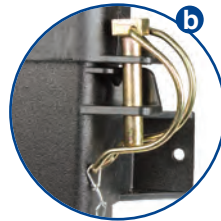
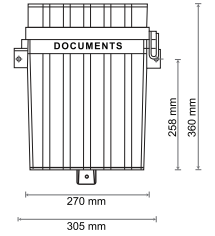

PDS/360
O.E.M. -

FL 2006

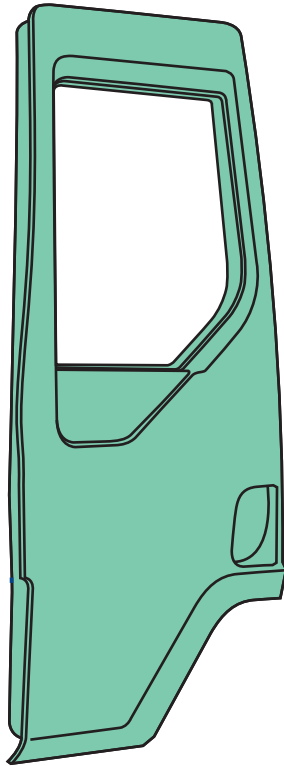

LF0/ 2 d-rh-rechts
LF0/ 3 s-lh-links
senza cerniere
without hinges
ohne Türscharniere

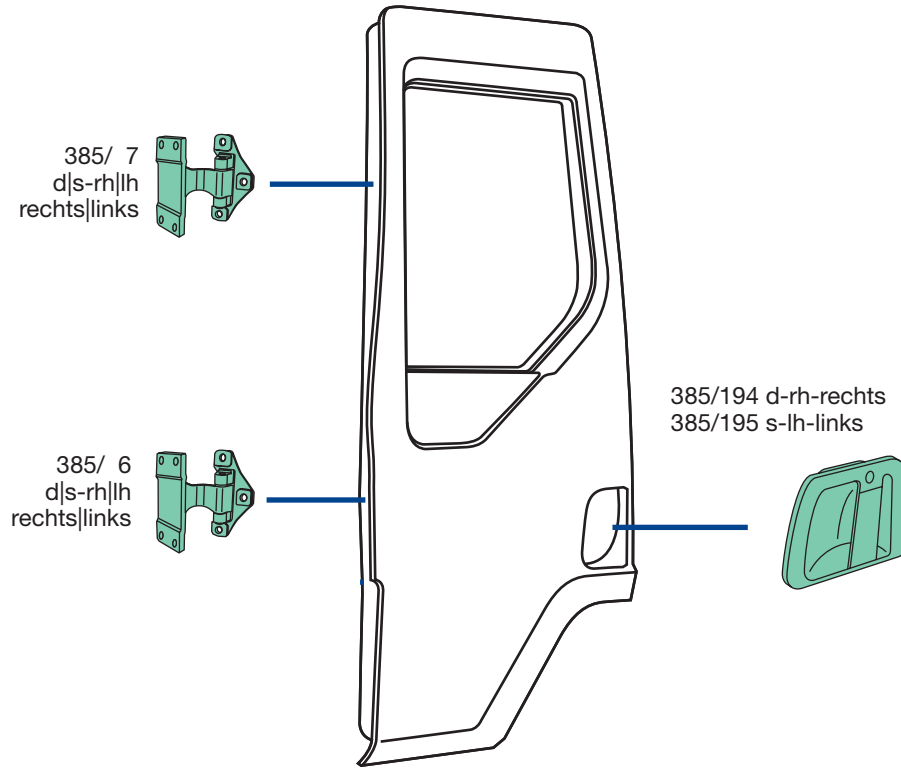

LF0/ 2
O.E.M. 85112767
LF0/ 3
O.E.M. 85112766



385/ 6
O.E.M. 20555723



385/ 7
O.E.M. 20555722



385/194
O.E.M. 24426875
385/195
O.E.M. 24426873

385/164 d-rh-rechts
385/165 s-lh-links
elettrico, senza motorino
electric, without motor
elektrisch, ohne Motor

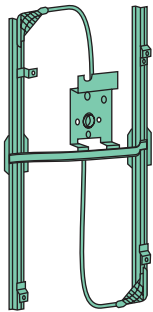

385/174 d-rh-rechts
385/175 s-lh-links
elettrico, con motorino
electric, with motor
elektrisch, mit Motor

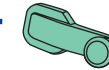
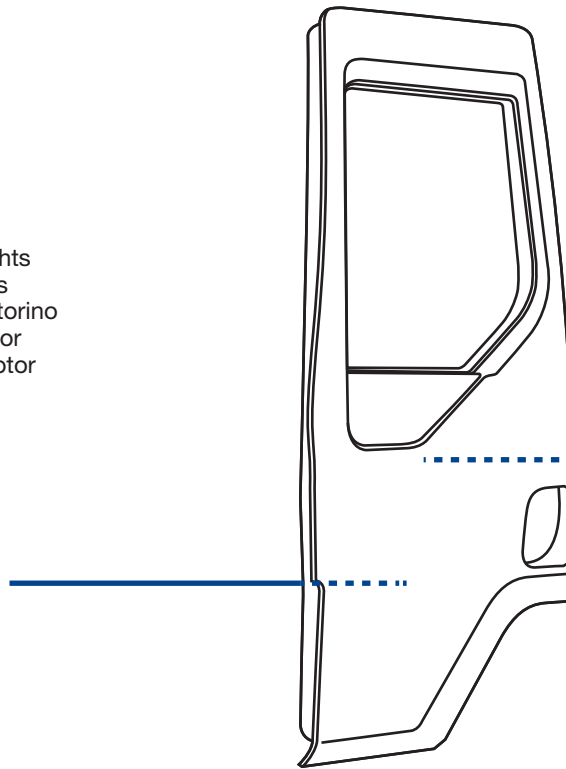
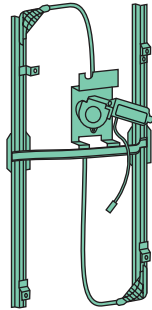

0FM/170
d|s-rh||h-rechts|links

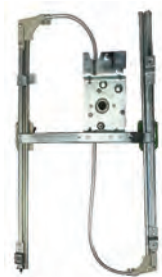

385/164
O.E.M. 82497194
385/165
O.E.M. 82497193



385/174
O.E.M. 82497194
385/175
O.E.M. 82497193

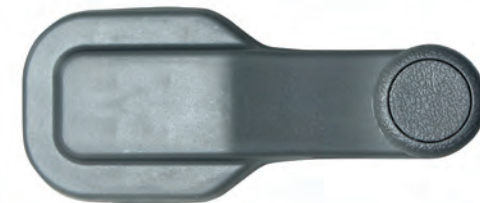

0FM/170
O.E.M. 8140016

applicabile a I suitable to I verwendbar für:

FL 2006



LF0/500

21326527
20743983



II

E4 024104
202x337 mm



IV

E4 024105
200x197 mm

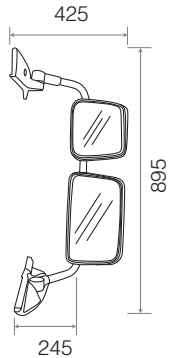

applicabilità:
applicable to:
Verwendbar für

VOLVO FE 2006 →
VOLVO FL 2006 →

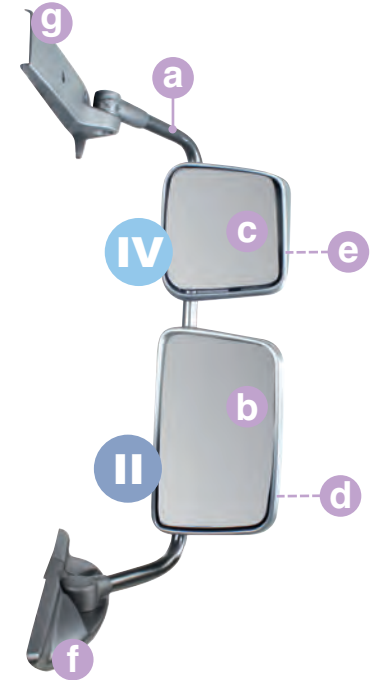

LF0/512

II



244x370 mm

LF0/510

IV



235x243 mm

a	PRM/508	20903727			+ g 323x895 mm
b	PRM/504	20862795			E4 024104 202x337 mm
c	LF0/504	20862815			E4 024105 200x197 mm
d	LF0/506	20862779			241x369 mm
e	LF0/507	20862800			235x241 mm
f	PRM/512	20708230			
g	PRM/522	-			

applicabile a I suitable to I verwendbar für:

FL 2006



LF0/501

20707881



II

E4 024104

202x337 mm



IV

E4 024105

200x197 mm

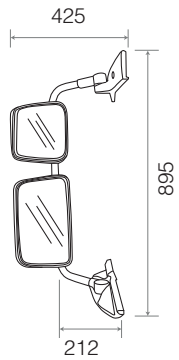

applicabilità:
applicable to:
Verwendbar für

VOLVO FE 2006 →
VOLVO FL 2006 →

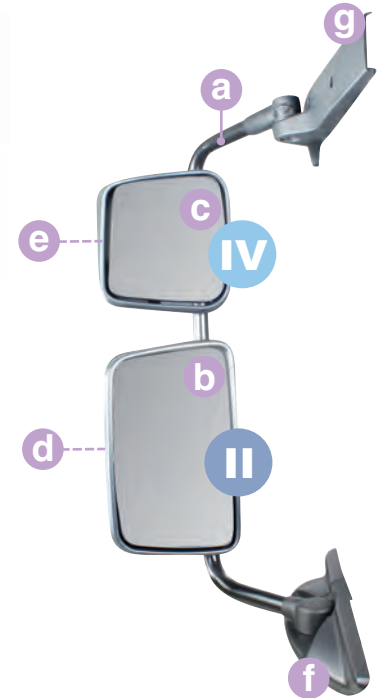

COVIND

LF0/513

II

















241x370 mm

LF0/511

IV



234x245 mm

<p>a</p>	<p>PRM/509</p>	<p>20903722</p>			<p>+ g</p> <p>300x895 mm</p>
<p>b</p> <p>II</p>	<p>PRM/504</p>	<p>20862795</p>			<p>E4 024104</p> <p>202x337 mm</p>
<p>c</p> <p>IV</p>	<p>LF0/505</p>	<p>20862810</p>			<p>E4 024105</p> <p>200x197 mm</p>
<p>d</p> <p>II</p>	<p>LF0/506</p>	<p>20862779</p>			<p>241x369 mm</p>
<p>e</p> <p>IV</p>	<p>LF0/507</p>	<p>20862800</p>			<p>235x241 mm</p>
<p>f</p>	<p>PRM/513</p>	<p>20708110</p>			
<p>g</p>	<p>PRM/523</p>	<p>-</p>			

applicabile a I suitable to I verwendbar für:

FL 2006



LF0/502

21475603
20708303



II

E4 024104

202x337 mm



IV

E4 024105

200x197 mm

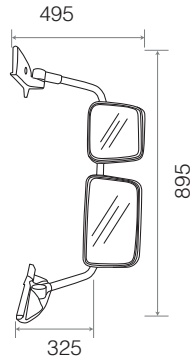

applicabilità:
applicable to:
Verwendbar für

VOLVO FE 2006 →
VOLVO FL 2006 →

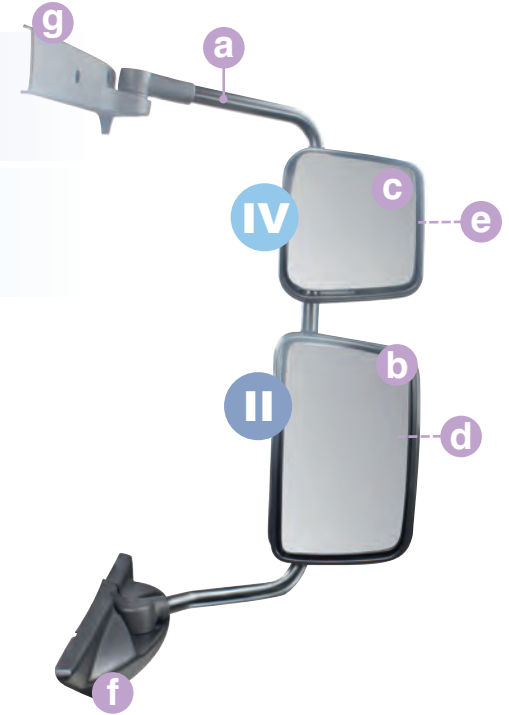

LF0/512

II



244x370 mm

LF0/510

IV



235x243 mm

a	LF0/508	20903732			+ g 387x895 mm
b	PRM/504	20862795			E4 024104 202x337 mm
c	LF0/504	20862815			E4 024105 200x197 mm
d	LF0/506	20862779			241x369 mm
e	LF0/507	20862800			235x241 mm
f	PRM/512	20708230			
g	PRM/522	-			

applicabile a I suitable to I verwendbar für:

FL 2006



LF0/503

20707874



II

E4 024104

202x337 mm



IV

E4 024105

200x197 mm

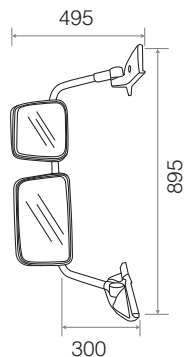
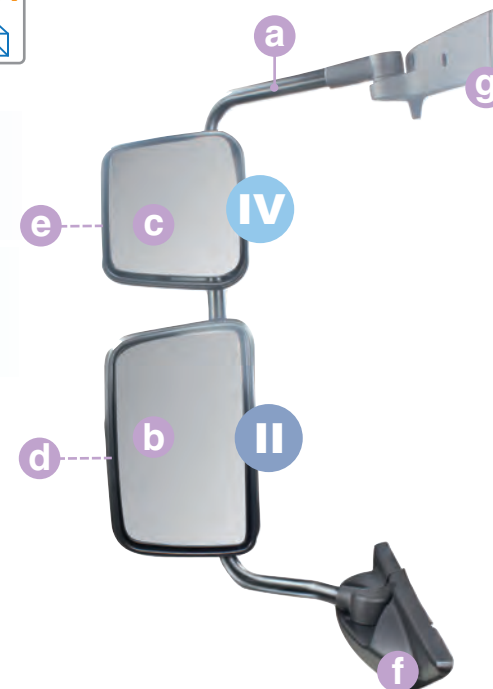

applicabilità:
applicable to:
Verwendbar für

VOLVO FE 2006 →
VOLVO FL 2006 →

COVIND

LF0/513

II



241x370 mm

LF0/511

IV



234x245 mm

a	LF0/509	20903723			+ g	387x895 mm
b	PRM/504	20862795			E4 024104	202x337 mm
c	LF0/505	20862810			E4 024105	200x197 mm
d	LF0/506	20862779				241x369 mm
e	LF0/507	20862800				235x241 mm
f	PRM/513	20708110				
g	PRM/523	-				

FL 2006

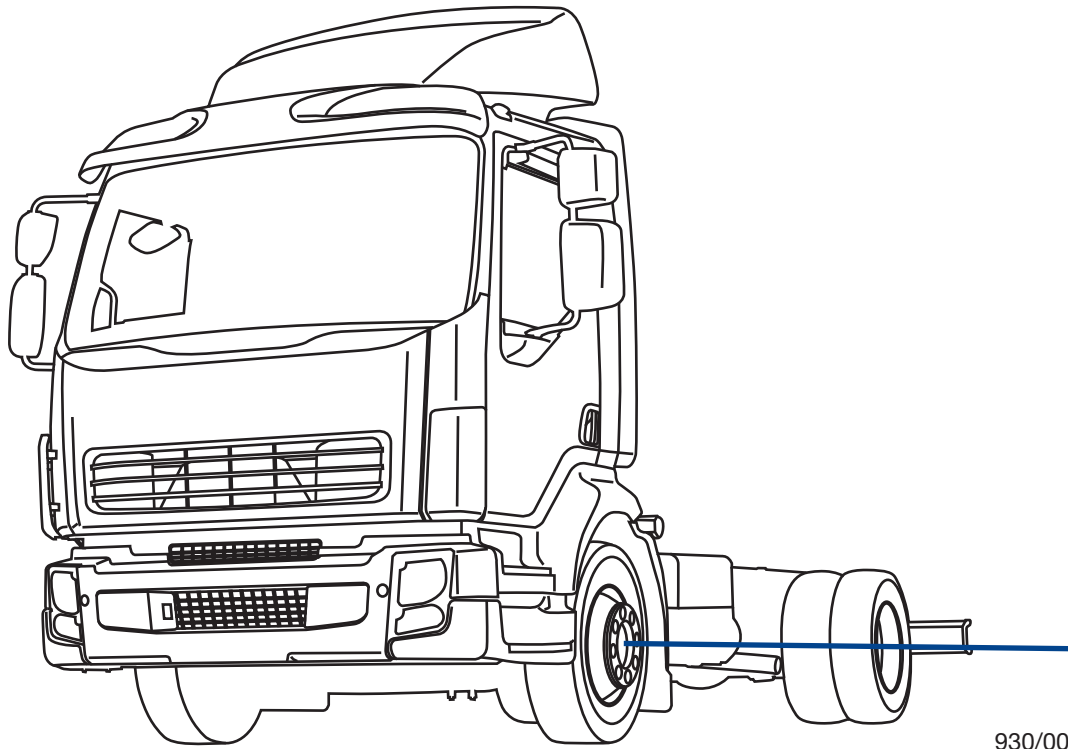

930/033

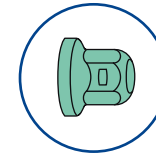

930/001 d-rh-rechts
930/002 s-lh-links



930/200
d|s-rh|lh
rechts|links

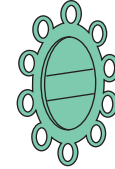

930/100 d-rh-rechts
930/101 s-lh-links



930/033
O.E.M. -



930/001
O.E.M. -
930/002
O.E.M. -



930/100
O.E.M. -
930/101
O.E.M. -



930/200
O.E.M. -

930/033-Tappo copri Bullone-Bolt cover-Radmutterkappen

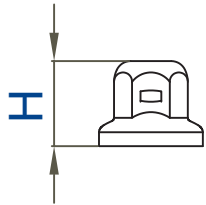

H	45 mm
Per bulloni \varnothing - bolt \varnothing	33 mm
Schlüsselweite \varnothing	
Colore	cromato-chrome-verchromt
Colours-Farbe	
Materiale-Material	acciaio inox-stainless steel Edelstahl
Kg	0,025

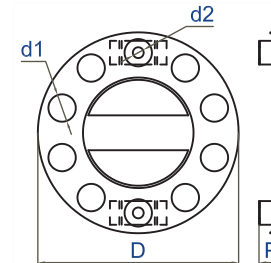

930/001 d-rh-rechts | 930/002 s-lh-links

D \varnothing 425 mm	P 50 mm
d1 nr. 10	d1 \varnothing 58 mm
d2 nr. 2	d2 \varnothing 23 mm
Ventilata	si-yes-Ja
Ventilated-Belüftet	
Colore	cromato e nero-chrome and black
Colours-Farbe	verchromt und schwarz
Materiale-Material	acciaio inox e plastica stainless steel and plastic Edelstahl und Kunststoff
Kg	1,230

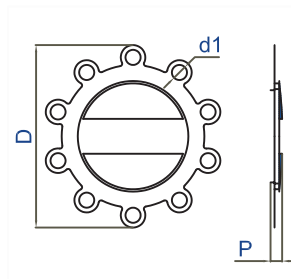

930/100 d-rh-rechts | 930/101 s-lh-links

D \varnothing 387 mm	P 30 mm
d1 nr. 10	d1 \varnothing 32 mm
Ventilata	si-yes-Ja
Ventilated-Belüftet	
Colore	cromato e nero-chrome and black
Colours-Farbe	verchromt und schwarz
Materiale-Material	acciaio inox e plastica stainless steel and plastic Edelstahl und Kunststoff
Kg	0,655

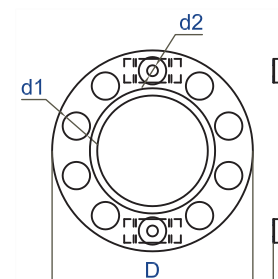

930/200 d|s-rh|lh-rechts+links

D \varnothing 425 mm	P 40 mm
d1 nr. 10	d1 \varnothing 58 mm
d2 nr. 2	d2 \varnothing 23 mm
Ventilata	no-nein
Ventilated-Belüftet	
Colore	cromato-chrome-verchromt
Colours-Farbe	
Materiale-Material	acciaio inox-stainless steel Edelstahl
Kg	1,155



IT Robot di foratura e taglio laser
EN Drilling robot and laser cutting
DE Läserbohrung und Schneideroboter



applicabile a | suitable to | verwendbar für

19

OFE
FE 2006

applicabile a | suitable to | verwendbar für:

FE 2006



OFL/400

O.E. 20937442 | 20743944

Adattabile a:
Suitable to:
passend für:

FE-FL-VM

Materiale | Material:
PMMA - ACRYLGLAS



COVIND

L	H	P	kg.
cm.	cm.	cm.	
212	56	25	5,315



OFL/480

O.E. 20819179

KIT completo
di staffe
e minuterie.
Assembly KIT.
Befestigungssatz



L'immagine del prodotto è da considerarsi puramente indicativa | The product image is just for information | Die Produktbilder sind nur zur Information.



applicabile a | suitable to | verwendbar für:

FE 2006

OFE/400

O.E. 20937431 | 20501225

Adattabile a:
Suitable to:
passend für:

FE-FL-VM

Materiale | Material:
PMMA - ACRYLGLAS



KIT completo di staffe e minuterie
IN ALLESTIMENTO
KIT complete of brackets and findings
NOT AVAILABLE YET
Befestigungssatz
IN ARBEIT



L	H	P	kg.
cm.	cm.	cm.	
192	40	25	5,120

applicabile a I suitable to I verwendbar für:

FE 2006

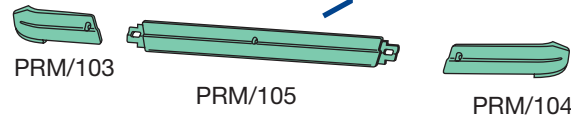
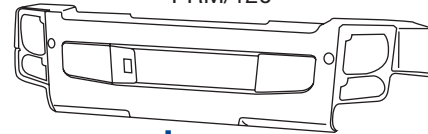
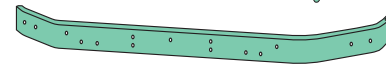
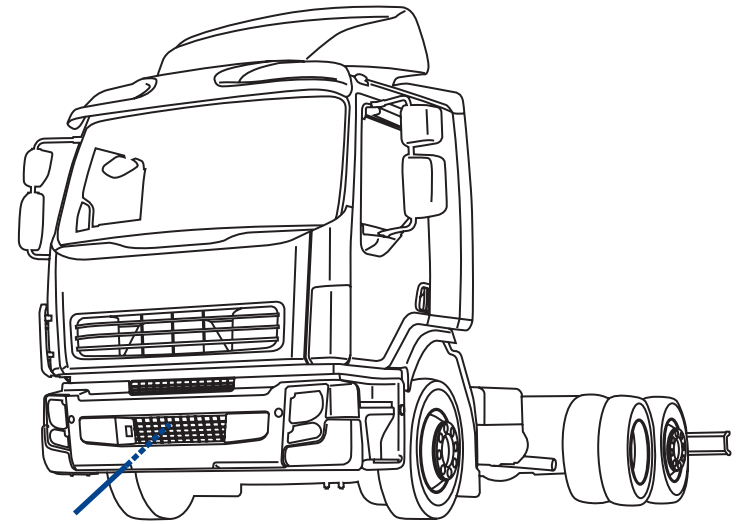

PRM/98
O.E.M. 82317469
PRM/99
O.E.M. 82317468



PRM/103
O.E.M. 25369343
PRM/104
O.E.M. 25369342



PRM/105
O.E.M. 25369341



PRM/120
O.E.M. 82912803

- (°) verniciato grigio
- (°) grey painted
- (°) grau strukturlackiert

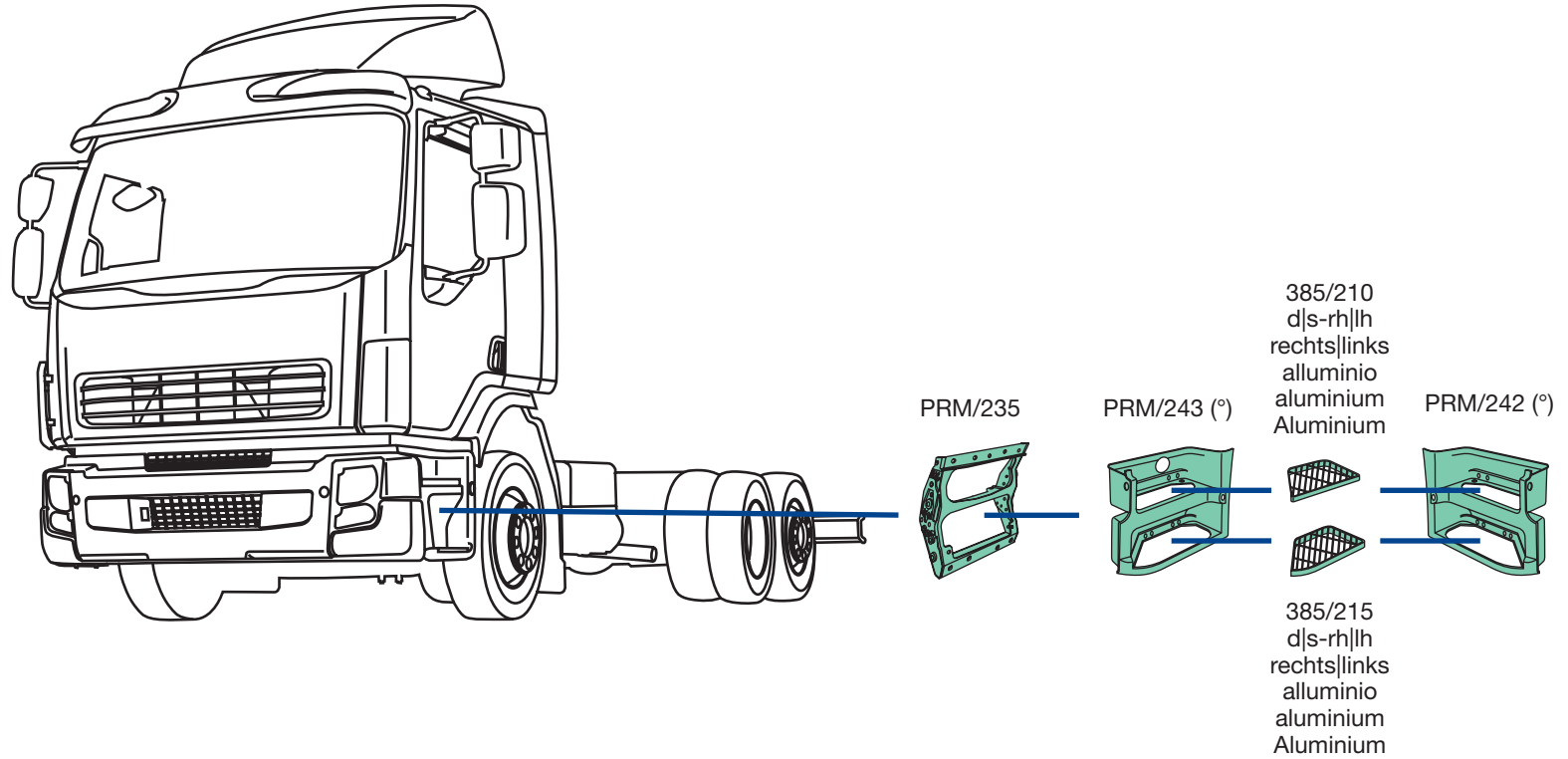

385/210
O.E.M. 5010225181



385/215
O.E.M. 5010225398



PRM/235
O.E.M. 21087113



PRM/242
O.E.M. 20593735



PRM/243
O.E.M. 20593721

FE 2006

(*) vernice di fondo | unprocessed | grundiert

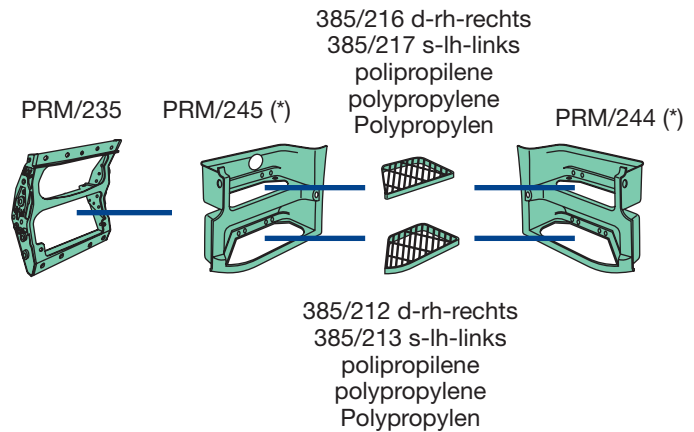
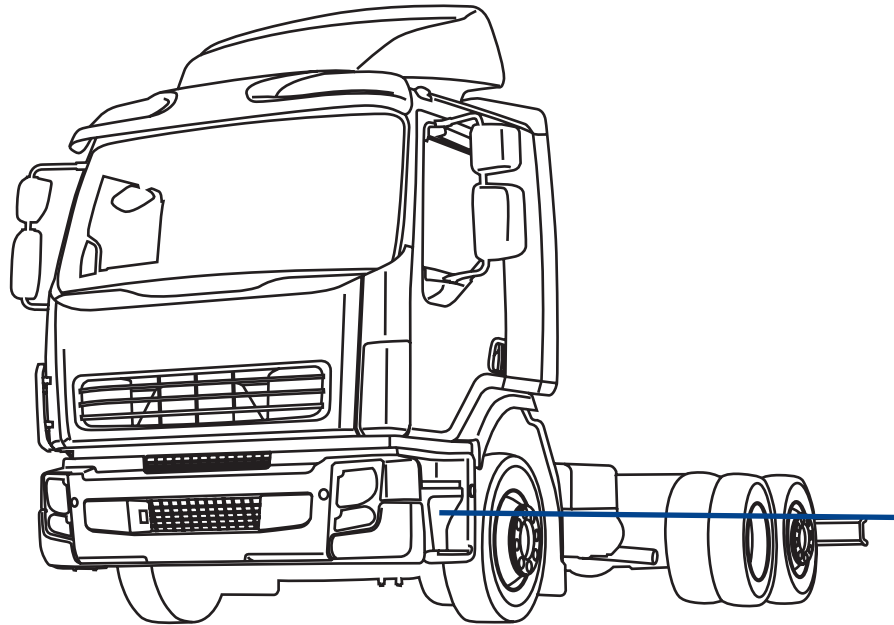

385/212
O.E.M. 20538011
385/213
O.E.M. 20538012



385/216
O.E.M. 20538248
385/217
O.E.M. 20538247



PRM/235
O.E.M. 21087113



PRM/244
O.E.M. 5010578387



PRM/245
O.E.M. 5010578381

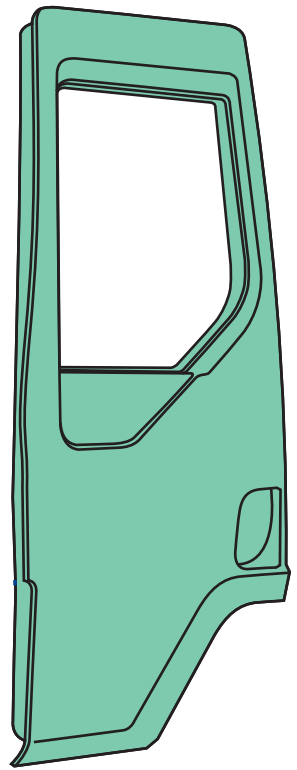

LF0/ 2 d-rh-rechts
LF0/ 3 s-lh-links
senza cerniere
without hinges
ohne Türscharniere

385/ 7
d|s-rh||h
rechts|links

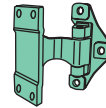

385/ 6
d|s-rh||h
rechts|links

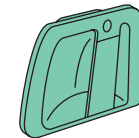
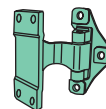

385/194 d-rh-rechts
385/195 s-lh-links



LF0/ 2
O.E.M. 85112767
LF0/ 3
O.E.M. 85112766



385/ 6
O.E.M. 20555723



385/ 7
O.E.M. 20555722



385/194
O.E.M. 24426875
385/195
O.E.M. 24426873

FE 2006

385/164 d-rh-rechts
385/165 s-lh-links
elettrico, senza motorino
electric, without motor
elektrisch, ohne Motor

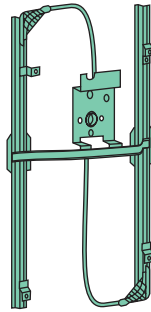

385/174 d-rh-rechts
385/175 s-lh-links
elettrico, con motorino
electric, with motor
elektrisch, mit Motor

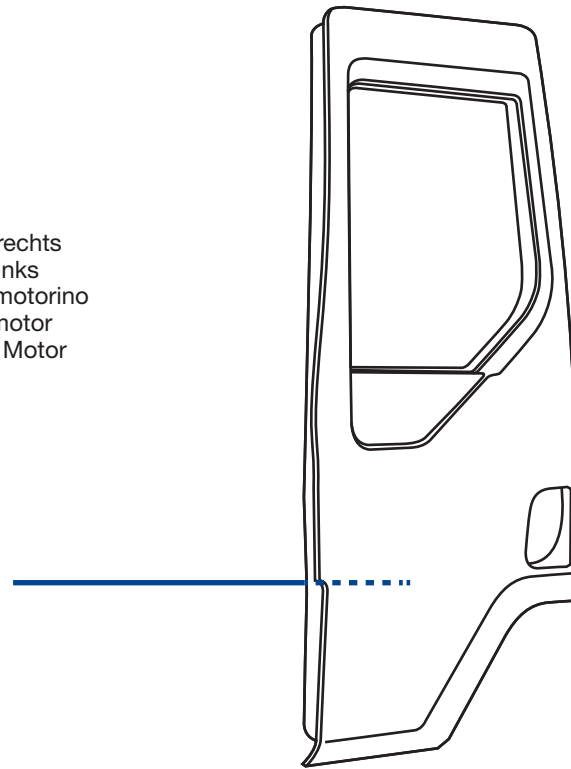
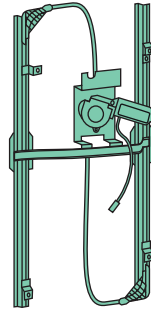

385/164
O.E.M. 82497194
385/165
O.E.M. 82497193



385/174
O.E.M. 82497194
385/175
O.E.M. 82497193

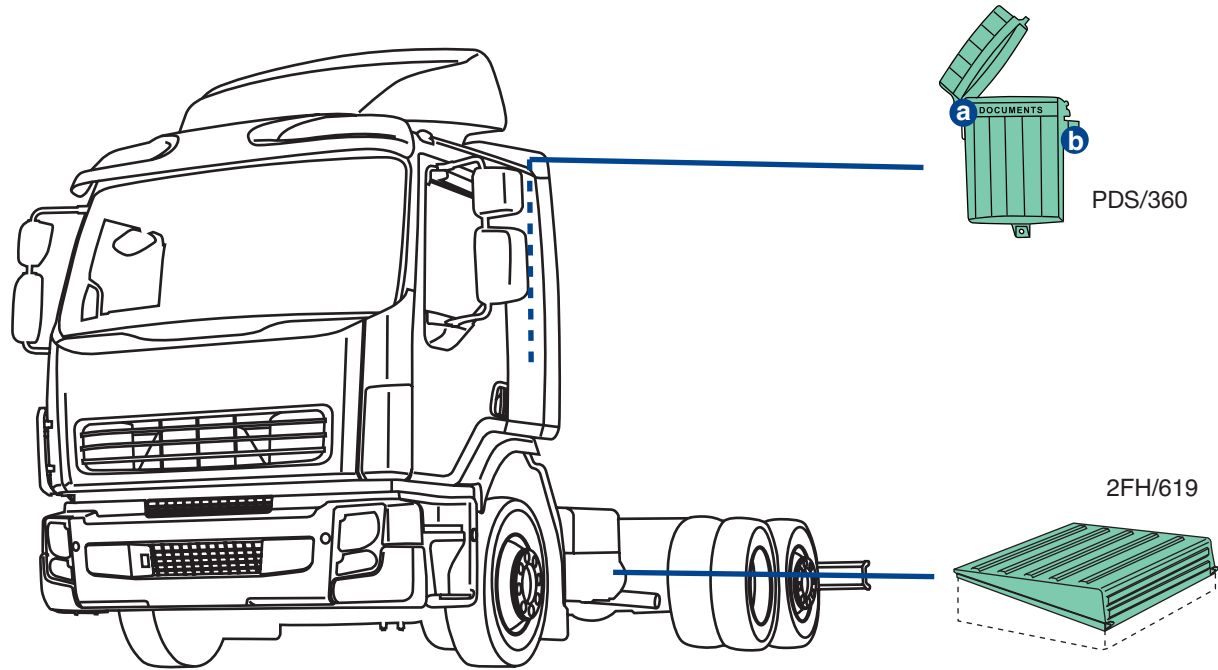

PDS/360

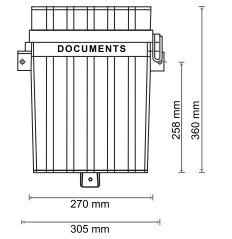

2FH/619



2FH/619
O.E.M. 20507252



PDS/360
O.E.M. -

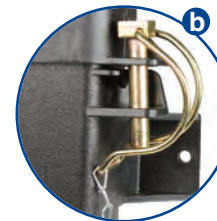

applicabile a I suitable to I verwendbar für:

FE 2006



LF0/500

21326527
20743983



II

E4 024104
202x337 mm



IV

E4 024105
200x197 mm

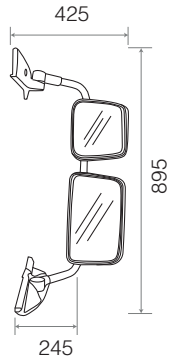

applicabilità:
applicable to:
Verwendbar für

VOLVO FE 2006 →
VOLVO FL 2006 →

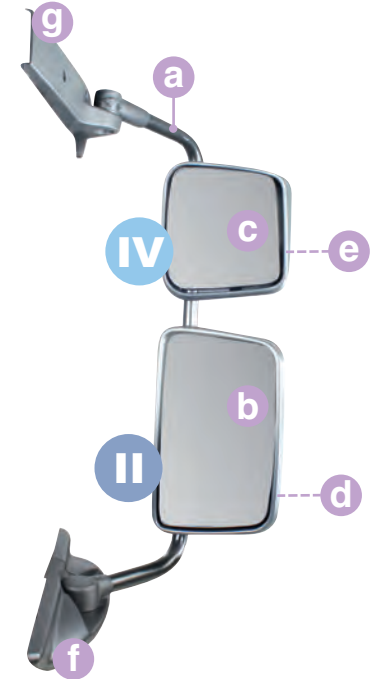

LF0/512

II



244x370 mm

LF0/510

IV



235x243 mm

a	PRM/508	20903727			+ g	323x895 mm
b	PRM/504	20862795			E4 024104	202x337 mm
II						
c	LF0/504	20862815			E4 024105	200x197 mm
IV						
d	LF0/506	20862779				241x369 mm
II						
e	LF0/507	20862800				235x241 mm
IV						
f	PRM/512	20708230				
g	PRM/522	-				

applicabile a I suitable to I verwendbar für:

FE 2006



LF0/501

20707881



II

E4 024104

202x337 mm



IV

E4 024105

200x197 mm

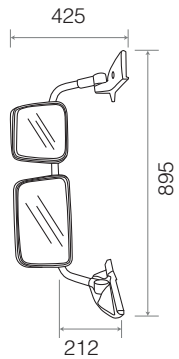

applicabilità:
applicable to:
Verwendbar für

VOLVO FE 2006 →
VOLVO FL 2006 →

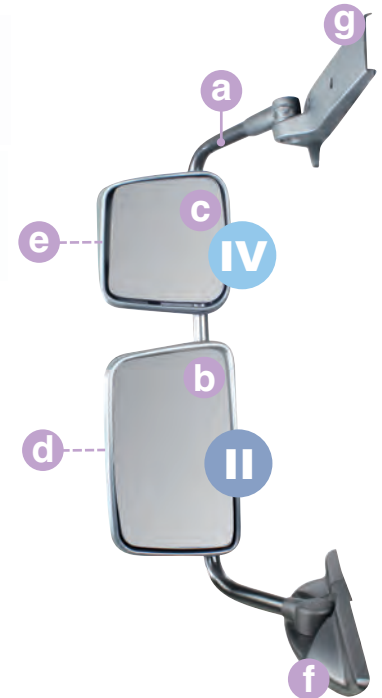

LF0/513

II

















241x370 mm

LF0/511

IV



234x245 mm

<p>a</p>	<p>PRM/509</p>	<p>20903722</p>			<p>+ g</p> <p>300x895 mm</p>
<p>b</p> <p>II</p>	<p>PRM/504</p>	<p>20862795</p>			<p>E4 024104</p> <p>202x337 mm</p>
<p>c</p> <p>IV</p>	<p>LF0/505</p>	<p>20862810</p>			<p>E4 024105</p> <p>200x197 mm</p>
<p>d</p> <p>II</p>	<p>LF0/506</p>	<p>20862779</p>			<p>241x369 mm</p>
<p>e</p> <p>IV</p>	<p>LF0/507</p>	<p>20862800</p>			<p>235x241 mm</p>
<p>f</p>	<p>PRM/513</p>	<p>20708110</p>			
<p>g</p>	<p>PRM/523</p>	<p>-</p>			

FE 2006



LF0/502

21475603
20708303



II

E4 024104
202x337 mm



IV

E4 024105
200x197 mm



applicabilità:
applicable to:
Verwendbar für

VOLVO FE 2006 →
VOLVO FL 2006 →

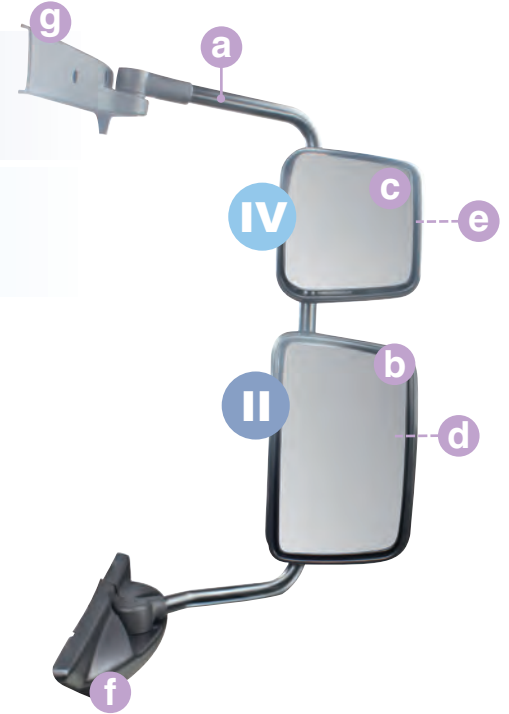
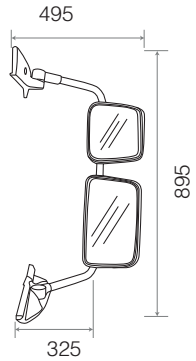

LF0/512

II



244x370 mm

LF0/510

IV



235x243 mm

a	LF0/508	20903732			+ g 387x895 mm
b	PRM/504	20862795			E4 024104 202x337 mm
c	LF0/504	20862815			E4 024105 200x197 mm
d	LF0/506	20862779			241x369 mm
e	LF0/507	20862800			235x241 mm
f	PRM/512	20708230			
g	PRM/522	-			

applicabile a I suitable to I verwendbar für:

FE 2006



LF0/503

20707874



II

E4 024104
202x337 mm



IV

E4 024105
200x197 mm

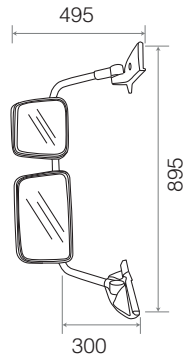
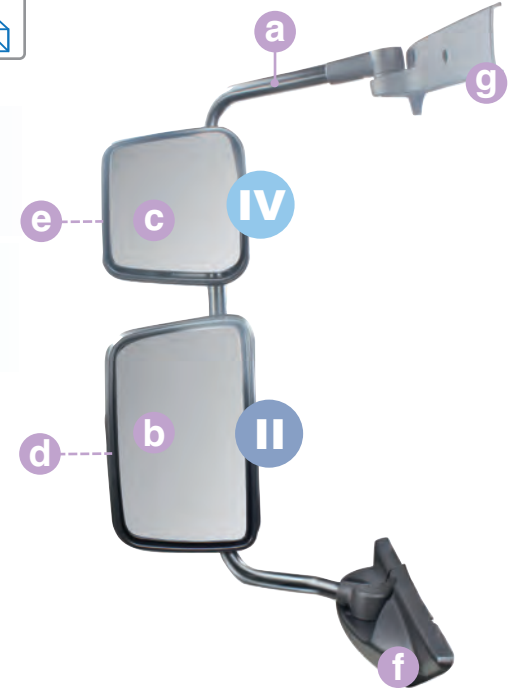

applicabilità:
applicable to:
Verwendbar für

VOLVO FE 2006 →
VOLVO FL 2006 →

COVIND

LF0/513

II

















241x370 mm

LF0/511

IV



234x245 mm

<p>a LF0/509</p>	<p>20903723</p>			<p>+ g 387x895 mm</p>
<p>b PRM/504</p> <p>II</p>	<p>20862795</p>			<p>E4 024104 202x337 mm</p>
<p>c LF0/505</p> <p>IV</p>	<p>20862810</p>			<p>E4 024105 200x197 mm</p>
<p>d LF0/506</p> <p>II</p>	<p>20862779</p>			<p>241x369 mm</p>
<p>e LF0/507</p> <p>IV</p>	<p>20862800</p>			<p>235x241 mm</p>
<p>f PRM/513</p>	<p>20708110</p>			
<p>g PRM/523</p>	<p>-</p>			

FE 2006

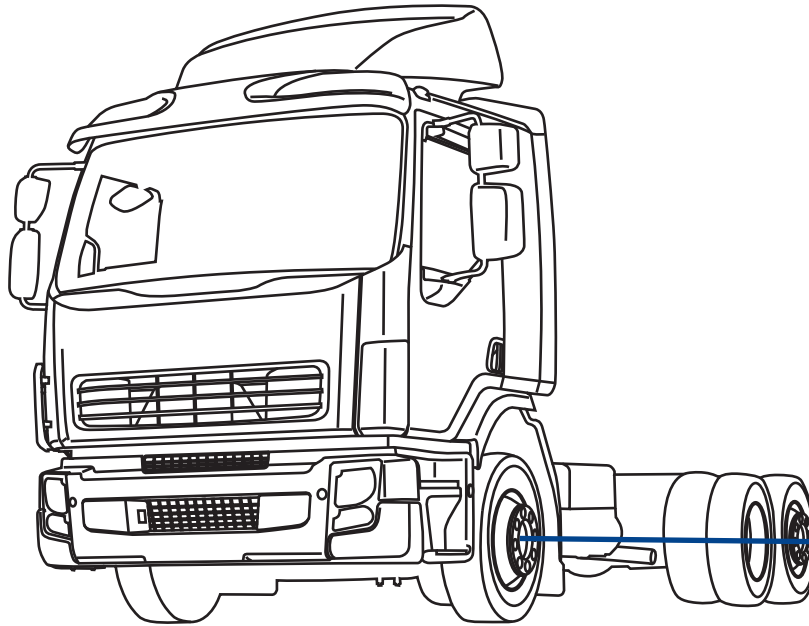

930/033

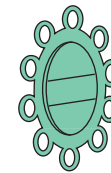
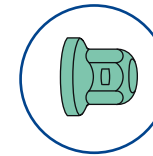

930/001 d-rh-rechts
930/002 s-lh-links

930/200
d|s-rh|lh
rechts|links

930/100 d-rh-rechts
930/101 s-lh-links



930/033
O.E.M. -



930/001
O.E.M. -
930/002
O.E.M. -



930/100
O.E.M. -
930/101
O.E.M. -



930/200
O.E.M. -

930/033-Tappo copri Bullone-Bolt cover-Radmutterkappen

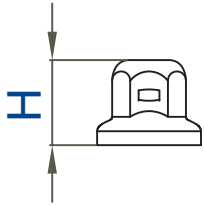

H	45 mm
Per bulloni \varnothing - bolt \varnothing	33 mm
Schlüsselweite \varnothing	
Colore	cromato-chrome-verchromt
Colours-Farbe	
Materiale-Material	acciaio inox-stainless steel Edelstahl
Kg	0,025

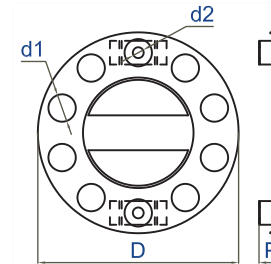

930/001 d-rh-rechts | 930/002 s-lh-links

D \varnothing 425 mm	P 50 mm
d1 nr. 10	d1 \varnothing 58 mm
d2 nr. 2	d2 \varnothing 23 mm
Ventilata	si-yes-Ja
Ventilated-Belüftet	
Colore	cromato e nero-chrome and black verchromt und schwarz
Colours-Farbe	
Materiale-Material	acciaio inox e plastica stainless steel and plastic Edelstahl und Kunststoff
Kg	1,230

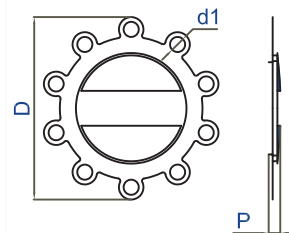

930/100 d-rh-rechts | 930/101 s-lh-links

D \varnothing 387 mm	P 30 mm
d1 nr. 10	d1 \varnothing 32 mm
Ventilata	si-yes-Ja
Ventilated-Belüftet	
Colore	cromato e nero-chrome and black verchromt und schwarz
Colours-Farbe	
Materiale-Material	acciaio inox e plastica stainless steel and plastic Edelstahl und Kunststoff
Kg	0,655

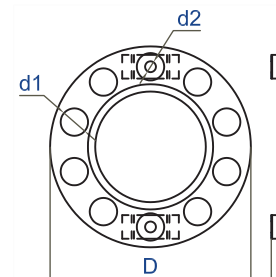

930/200 d|s-rh|lh-rechts+links

D \varnothing 425 mm	P 40 mm
d1 nr. 10	d1 \varnothing 58 mm
d2 nr. 2	d2 \varnothing 23 mm
Ventilata	no-nein
Ventilated-Belüftet	
Colore	cromato-chrome-verchromt
Colours-Farbe	
Materiale-Material	acciaio inox-stainless steel Edelstahl
Kg	1,155



- ▲
- IT Stampo in acciaio per produzione della griglia per un veicolo di nuova generazione
EN Steel mould for new vehicle grille production
DE Gehärtete Stahlform für die Produktion des Gitters für ein neues Fahrzeug



applicabile a | suitable to | verwendbar für

39

2FM

FM7-FM10-FM12

SECONDA SERIE | SECOND SERIES | ZWEITE SERIE

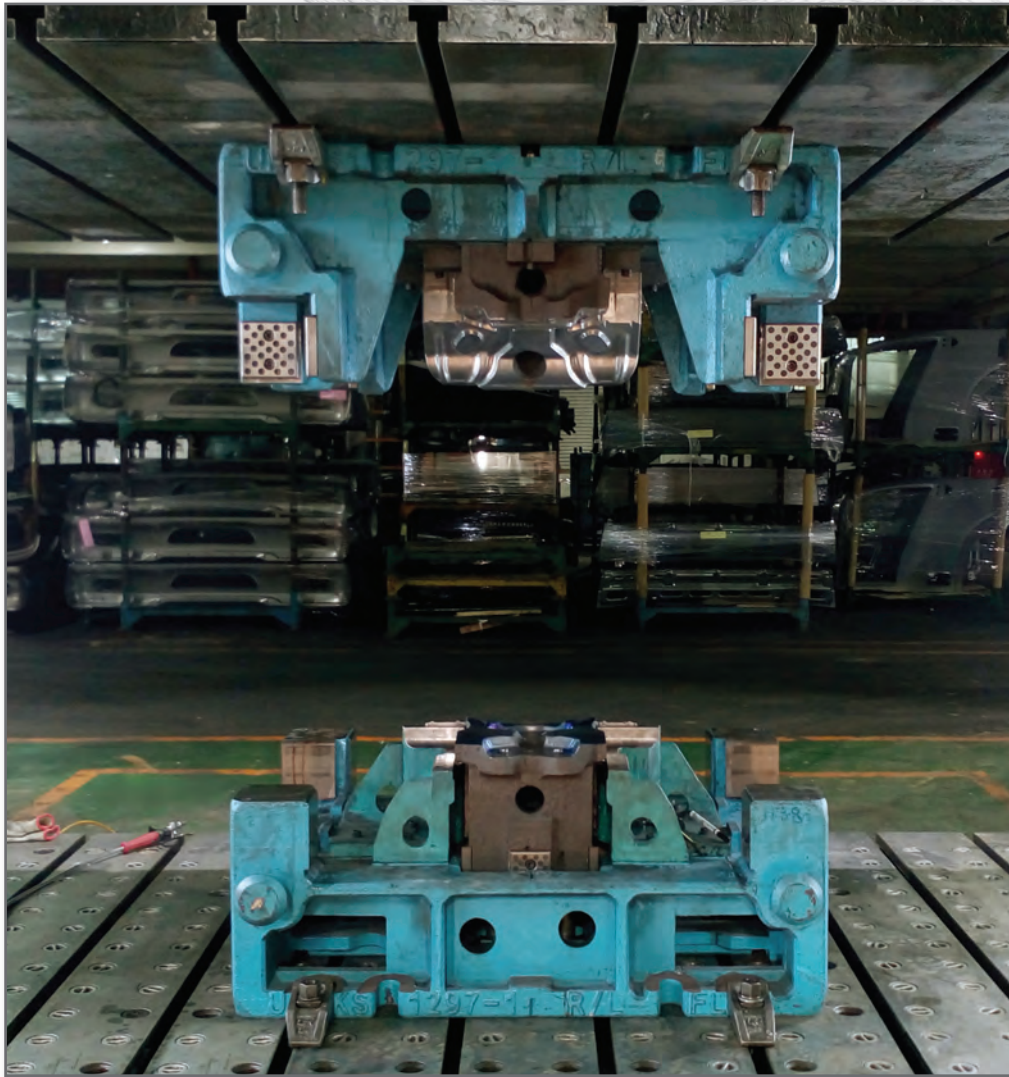

IT Prova di accoppiamento sotto pressa. Stampo ad iniezione ossatura portafaro.

EN Headlamp housing injection moulding press matching test

DE Unterdruck Anpassung der Spritzgießform fuer den scheinwerfer traeger

FM7-FM10-FM12 SECONDA SERIE | SECOND SERIES | ZWEITE SERIE

(*) Cava-Cantiere
Yard & Quarry
Baustellenfahrzeug

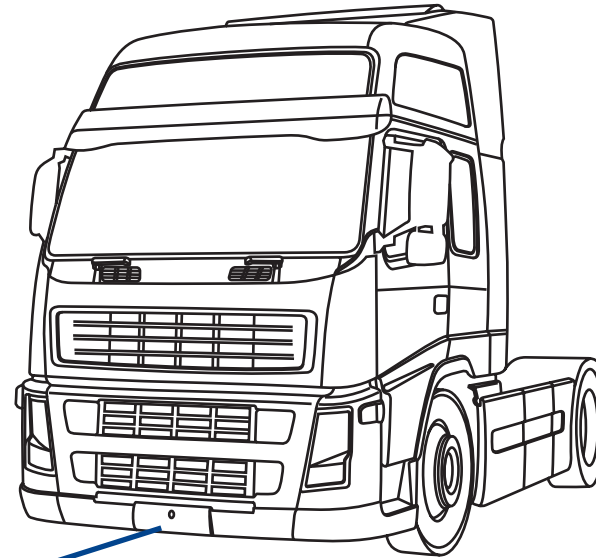

2FH/ 84 (*)
ferro-iron-Stahl



2FH/ 80 (*)
ferro-iron-Stahl



2FH/ 85 (*)
ferro-iron-Stahl



2FH/236 d-rh-rechts
2FH/237 s-lh-links



2FH/ 80
O.E.M. 21828914



2FH/ 84
O.E.M. 21829052
2FH/ 85
O.E.M. 21829051



2FH/236
O.E.M. 20453677
2FH/237
O.E.M. 20453676

applicabile a I suitable to I verwendbar für:

FM7-FM10-FM12 SECONDA SERIE | SECOND SERIES | ZWEITE SERIE

(*) grezzo
unprocessed
roh

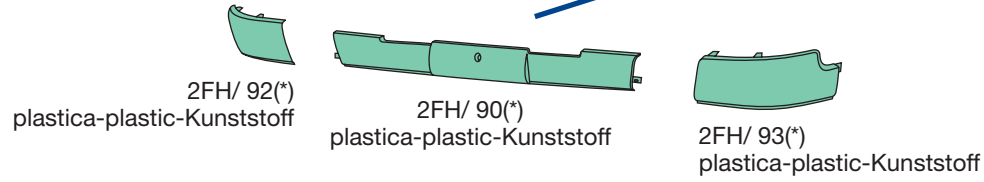
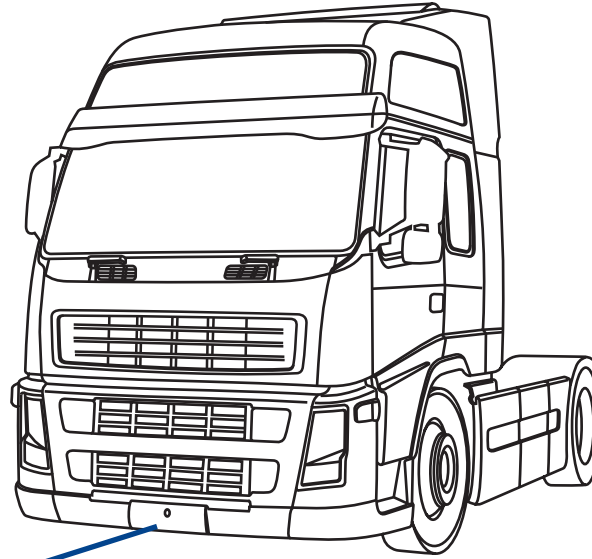

2FH/ 90
O.E.M. 21359080



2FH/ 92
O.E.M. 21359090
2FH/ 93
O.E.M. 21359082

FM7-FM10-FM12 SECONDA SERIE | SECOND SERIES | ZWEITE SERIE

(*) verniciato grigio scuro
dark grey painted
dunkel grau strukturlackiert

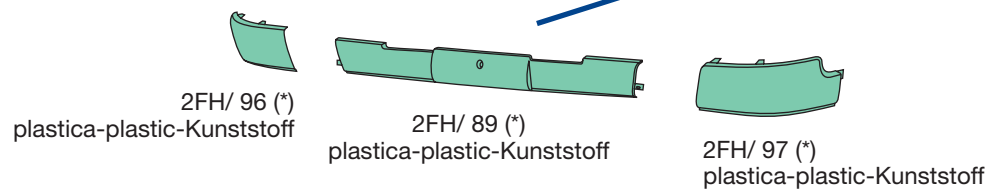
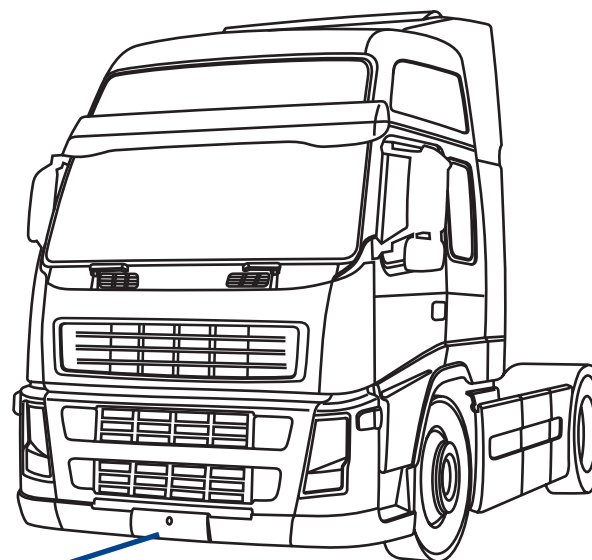

2FH/ 89
O.E.M. 20529740



2FH/ 96
O.E.M. 20529742
2FH/ 97
O.E.M. 20529741

applicabile a I suitable to I verwendbar für:

FM7-FM10-FM12 SECONDA SERIE | SECOND SERIES | ZWEITE SERIE

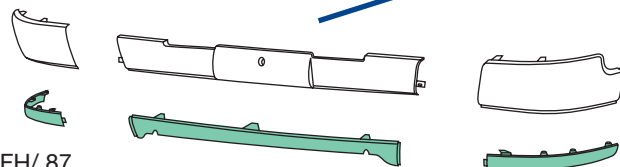
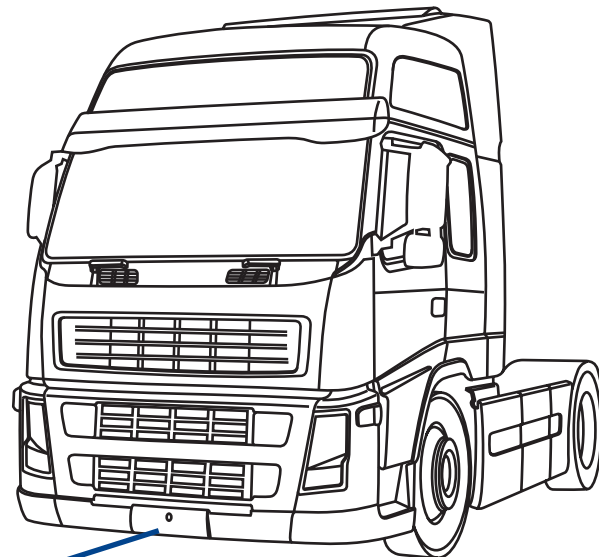

2FH/ 87
plastica-plastic-Kunststoff

2FH/ 86
plastica-plastic-Kunststoff

2FH/ 88
plastica-plastic-Kunststoff



2FH/ 86
O.E.M. 21430599



2FH/ 87
O.E.M. 21430672
2FH/ 88
O.E.M. 21430600

FM7-FM10-FM12 SECONDA SERIE | SECOND SERIES | ZWEITE SERIE

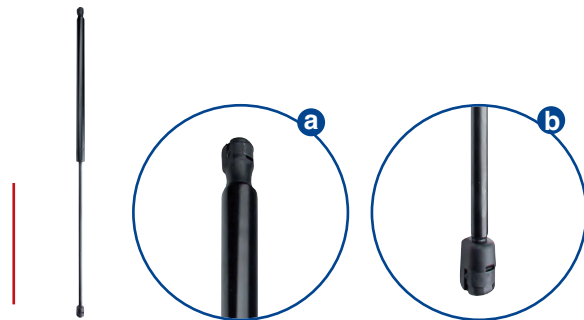
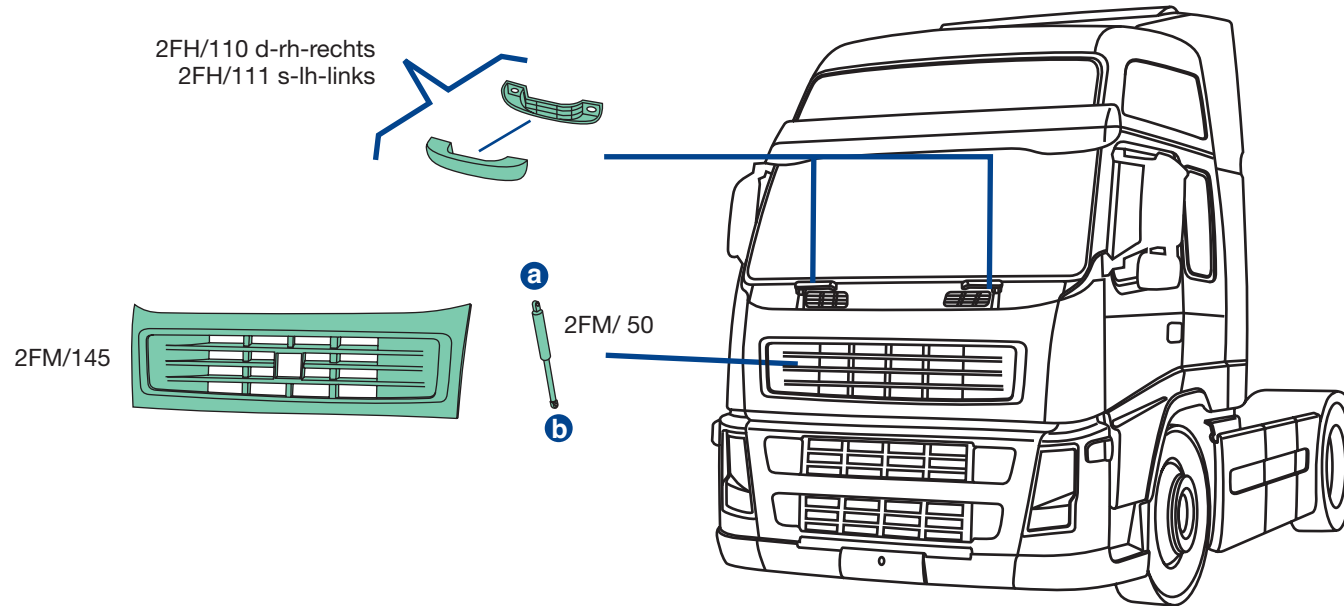

2FM/50
O.E.M. 20379349



2FM/145
O.E.M. 3175376



2FH/110
O.E.M. 3175367+3175366
2FH/111
O.E.M. 20383543+3175366

applicabile a I suitable to I verwendbar für:

FM7-FM10-FM12 SECONDA SERIE | SECOND SERIES | ZWEITE SERIE

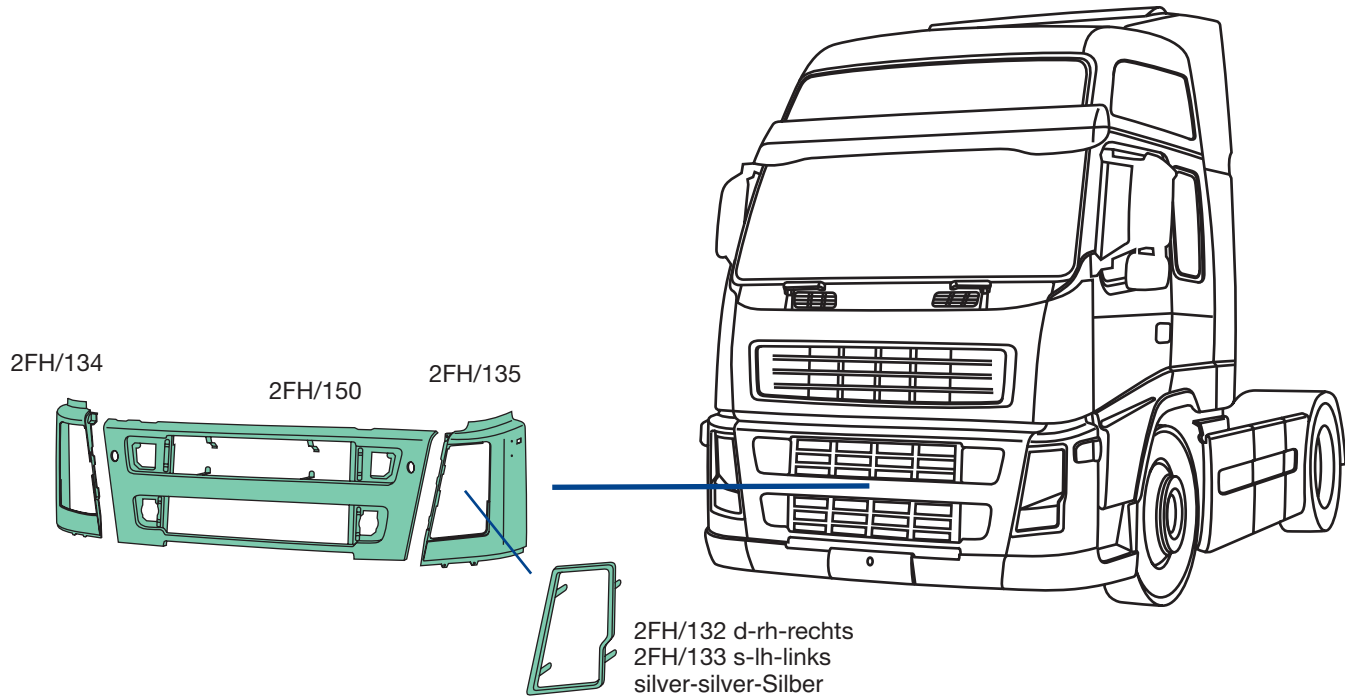

2FH/132
O.E.M. 20452848
2FH/133
O.E.M. 20452847



2FH/134
O.E.M. 21469924
2FH/135
O.E.M. 21469918

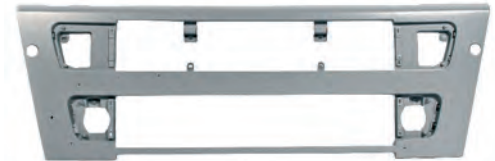

2FH/150
O.E.M. 21430596

FM7-FM10-FM12 SECONDA SERIE | SECOND SERIES | ZWEITE SERIE

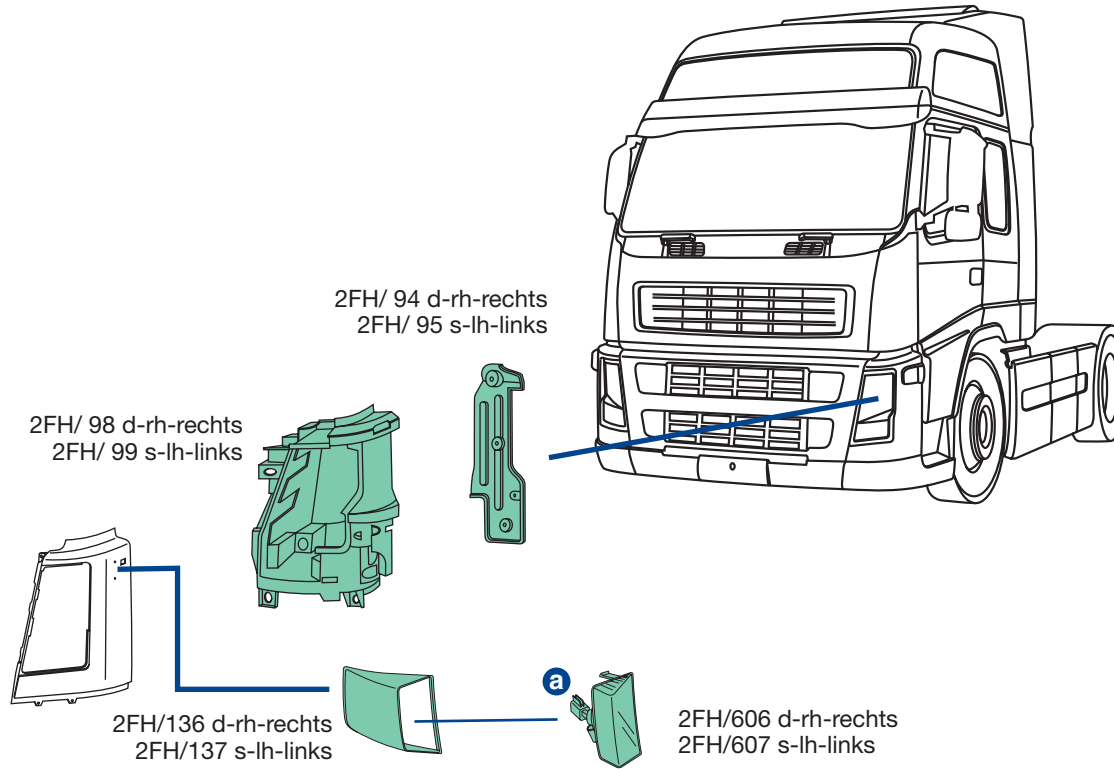

2FH/ 94
O.E.M. 21359260
2FH/ 95
O.E.M. 21359257



2FH/ 98
O.E.M. 20917958
2FH/ 99
O.E.M. 20917957



2FH/136
O.E.M. 21469979
2FH/137
O.E.M. 21430598



2FH/606
O.E.M. 20826213
2FH/607
O.E.M. 20826211



applicabile a | suitable to | verwendbar für:

FM7-FM10-FM12 SECONDA SERIE | SECOND SERIES | ZWEITE SERIE

(*) >2007 singole-singles-Einzelteil
2007> 2FH/152 + 2FH/153 (in coppia-a pair of-Paar)

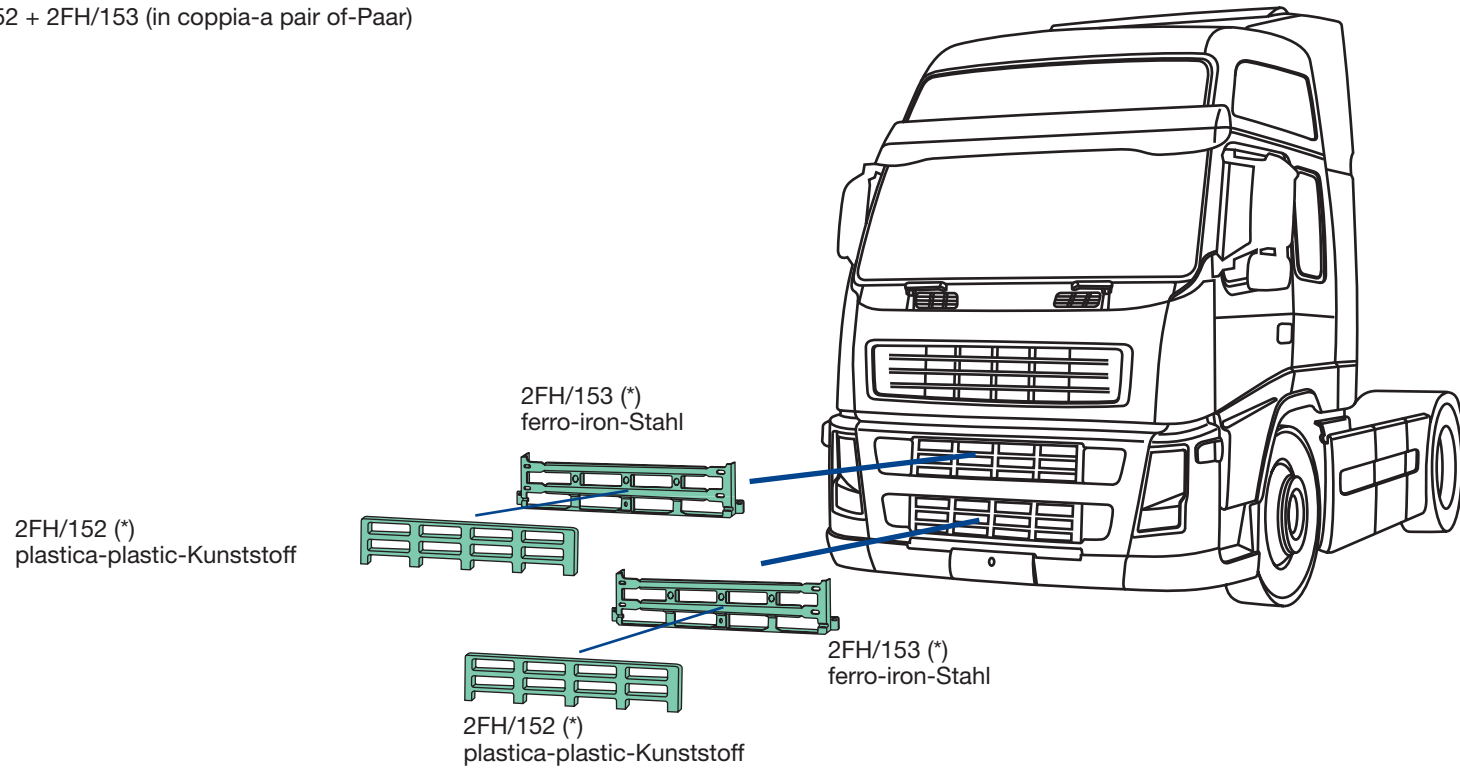

2FH/152
O.E.M. 20409818



2FH/153
O.E.M. 20456963

FM7-FM10-FM12 SECONDA SERIE | SECOND SERIES | ZWEITE SERIE

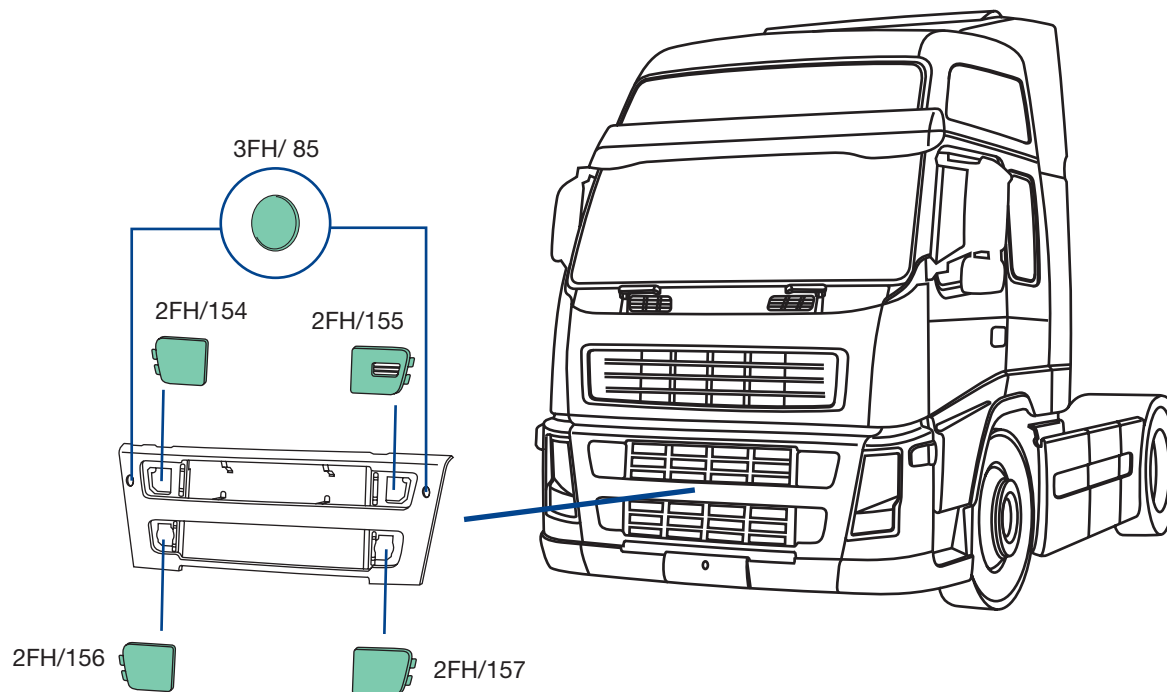

2FH/154
O.E.M. 20529706



2FH/155
O.E.M. 20529705



2FH/156
O.E.M. 20529708
2FH/157
O.E.M. 20529707



3FH/85
O.E.M. 21425186

applicabile a I suitable to I verwendbar für:

FM7-FM10-FM12 SECONDA SERIE | SECOND SERIES | ZWEITE SERIE



3FH/502

-



II

E4 024111

200x435 mm



IV

E4 024112

176x188 mm

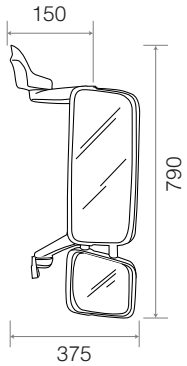

applicabilità:
applicable to:
Verwendbar für

VOLVO FH II 2002→
VOLVO FM II 2002→

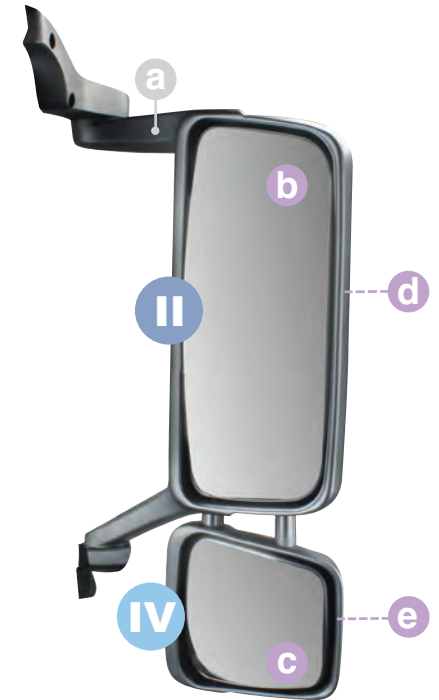

COVIND

II

2FH/500

-



IV

249x231 mm

a	-	-								
b	2FH/503 II	21320404 (20589788)							E4 024111	200x435 mm
c	2FH/504 IV	21320300 (20567685) (20455985)							E4 024112	176x188 mm
d	2FH/502 II	20746401								187x435 mm
e	2FH/508 IV	20360811								250x200 mm

applicabile a I suitable to I verwendbar für:

FM7-FM10-FM12 SECONDA SERIE | SECOND SERIES | ZWEITE SERIE



3FH/503



II

E4 024111
200x435 mm



IV

E4 024112
176x188 mm



applicabilità:
applicable to:
Verwendbar für

VOLVO FH II 2002 →
VOLVO FM II 2002 →

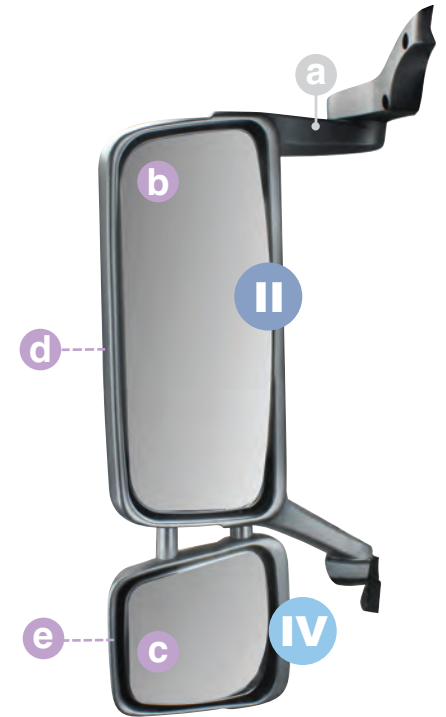
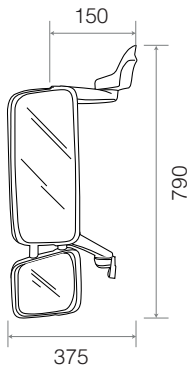

COVIND

II























2FH/501

IV



250x235 mm

FM7-FM10-FM12 SECONDA SERIE | SECOND SERIES | ZWEITE SERIE

<p>a</p> <p>-</p>	<p>-</p>							
<p>b</p> <p>2FH/503</p> <p>II</p>	<p>21320404 (20589788)</p>							<p>E4 024111</p> <p>200x435 mm</p>
<p>c</p> <p>2FH/504</p> <p>IV</p>	<p>21320300 (20567685) (20455985)</p>							<p>E4 024112</p> <p>176x188 mm</p>
<p>d</p> <p>2FH/502</p> <p>II</p>	<p>20746401</p>						<p>187x435 mm</p>	
<p>e</p> <p>2FH/508</p> <p>IV</p>	<p>20360811</p>						<p>250x200 mm</p>	

applicabile a l suitable to l verwendbar für:

FM7-FM10-FM12 SECONDA SERIE | SECOND SERIES | ZWEITE SERIE

OFH/190

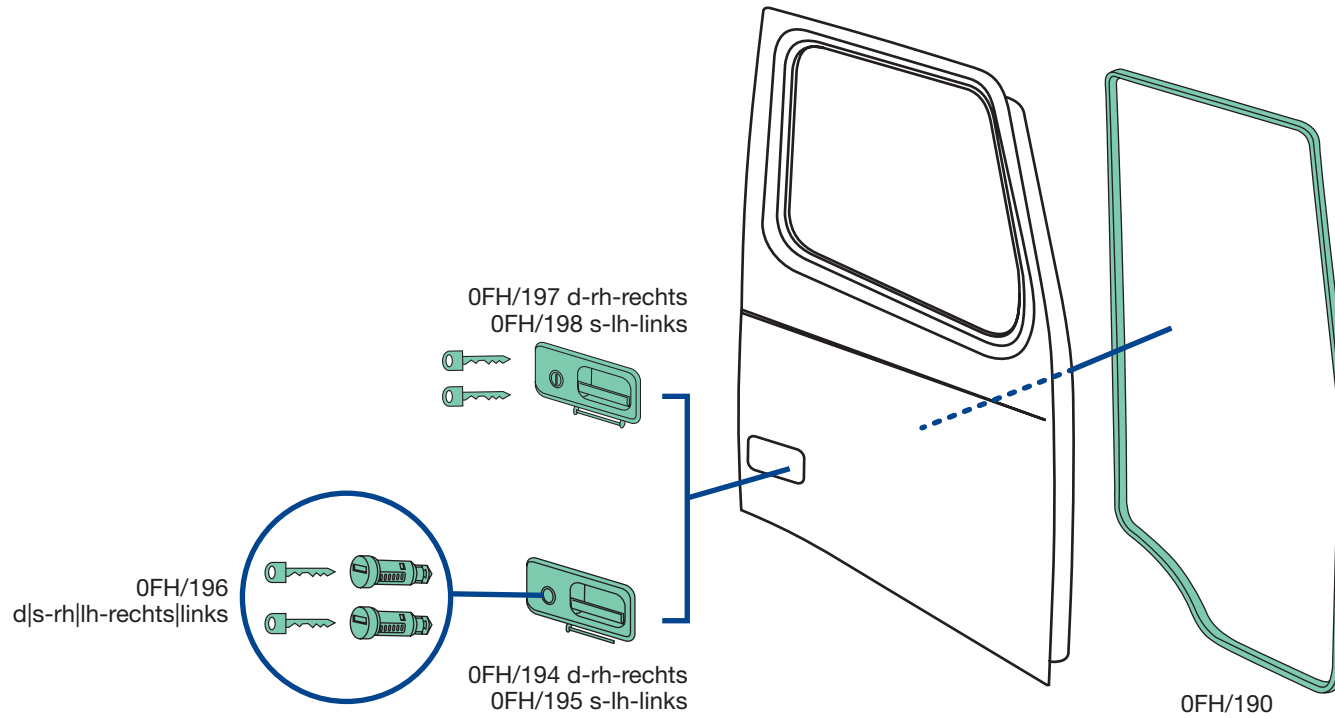
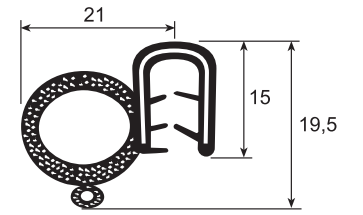

OFH/190
O.E.M. 3175029



OFH/194
O.E.M. 20398467
OFH/195
O.E.M. 20398466



OFH/196
O.E.M. 3090484



OFH/197
O.E.M. -
OFH/198
O.E.M. -

FM7-FM10-FM12 SECONDA SERIE | SECOND SERIES | ZWEITE SERIE

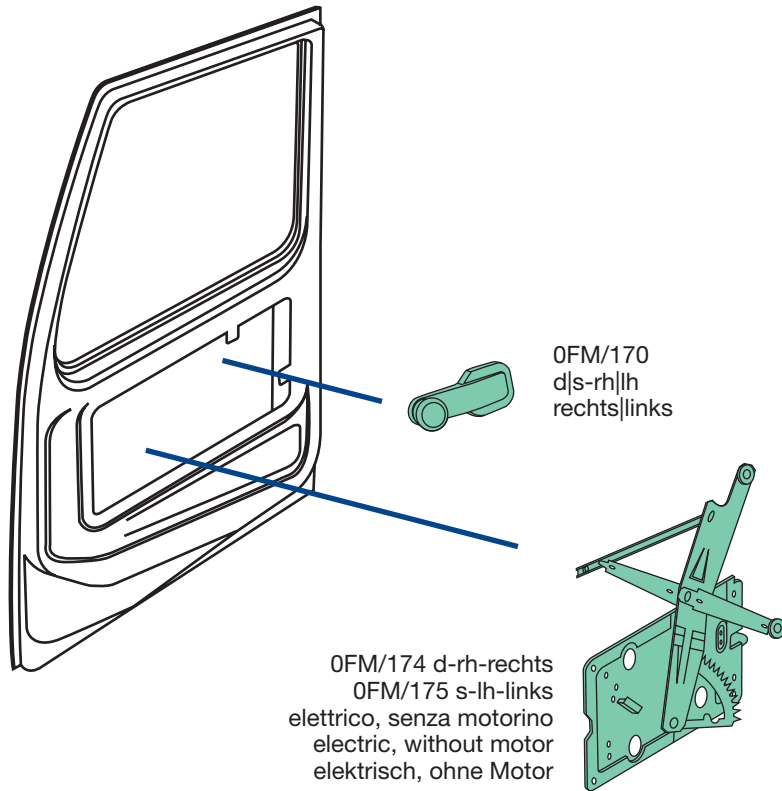

OFH/164 d-rh-rechts
OFH/165 s-lh-links
elettrico, con motorino
electric, with motor
elektrisch, mit Motor

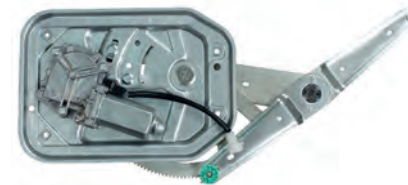
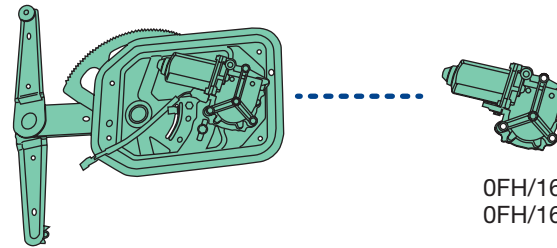

OFM/170
O.E.M. 8140016

OFM/174
O.E.M. -
OFM/175
O.E.M. -

OFH/164
O.E.M. 3176542
OFH/165
O.E.M. 3176541

IN ALLESTIMENTO::NOT AVAILABLE YET::IN ARBEIT

OFH/168
O.E.M. 3176550
OFH/169
O.E.M. 3176549

IN ALLESTIMENTO::NOT AVAILABLE YET::IN ARBEIT

applicabile a I suitable to I verwendbar für:

FM7-FM10-FM12 SECONDA SERIE | SECOND SERIES | ZWEITE SERIE

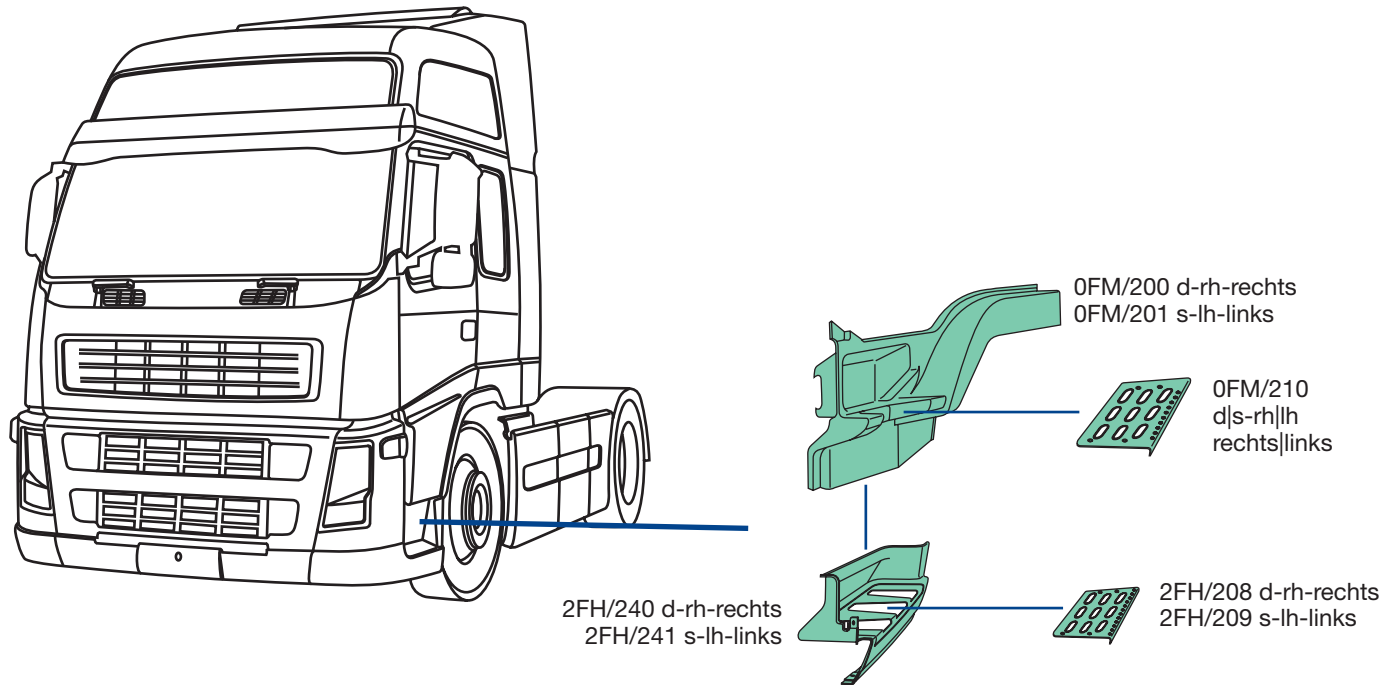

0FM/200
O.E.M. 20529483
0FM/201
O.E.M. 20537185



0FM/210
O.E.M. 1063726



2FH/208
O.E.M. 20360789
2FH/209
O.E.M. 20360788



2FH/240
O.E.M. 20529640
2FH/241
O.E.M. 20529638

FM7-FM10-FM12 SECONDA SERIE | SECOND SERIES | ZWEITE SERIE

- (*) segnalatore laterale (4 led)
- sidemarker (4 led)
- Seitenmarkierungsleuchte (4 led)

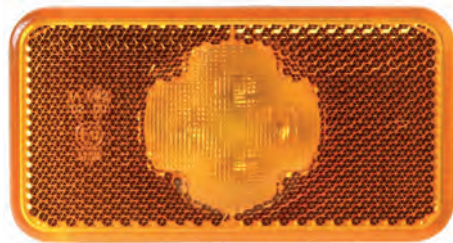
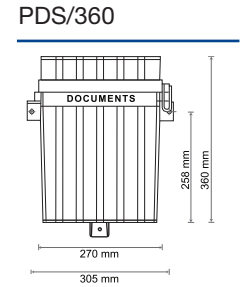
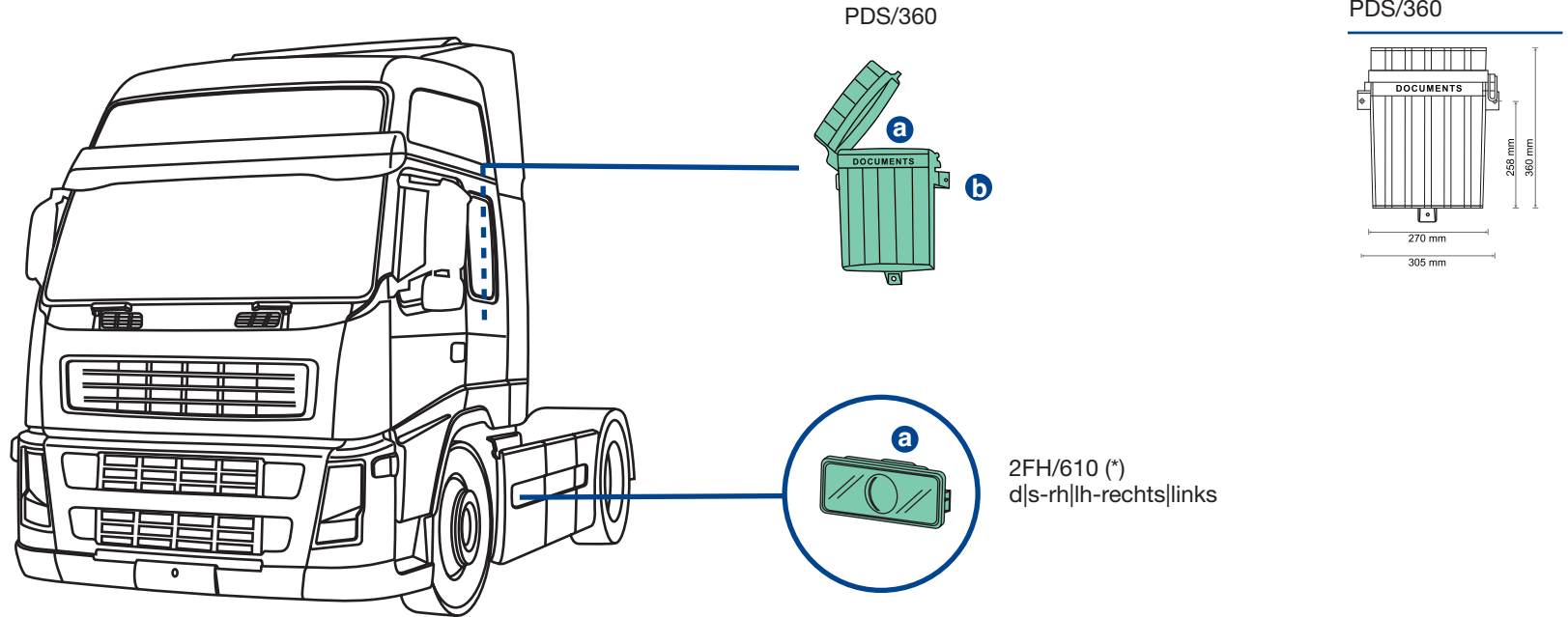

2FH/610
O.E.M. 20789440

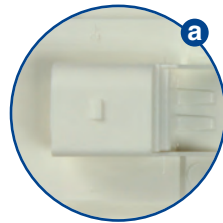

PDS/360
O.E.M. -

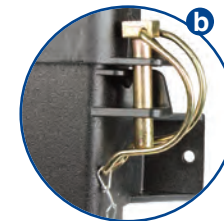

FM7-FM10-FM12 SECONDA SERIE | SECOND SERIES | ZWEITE SERIE

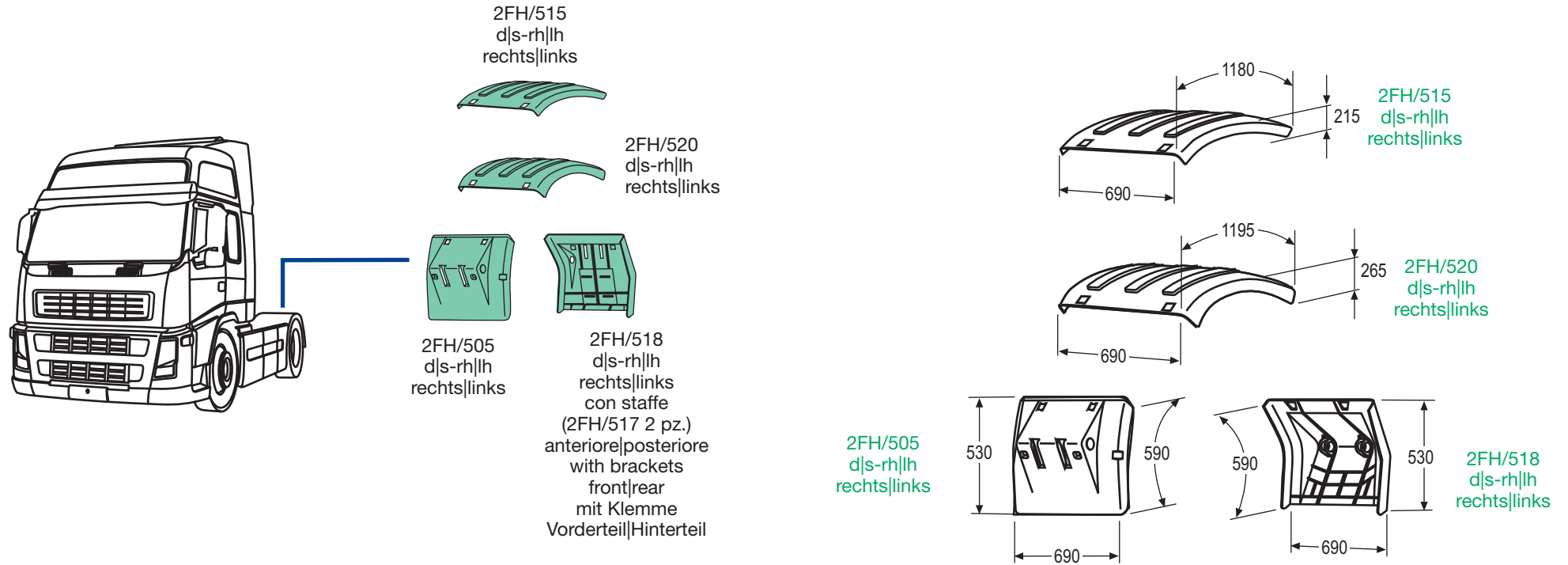

- 2FH/515
- O.E.M. 20936759
- d|s-rh|lh-rechts|links
- grigio, semipiatta, senza cinghietti
- grey, semi-flat, without stretchers
- grau, halbflach, ohne Spanngummi



- 2FH/518
- O.E.M. 20392599
- d|s-rh|lh-rechts|links
- grigio, senza anti-spray, con staffe
- grey, without anti-spray, with brackets
- grau, ohne Spritzschutz, mit Klemme

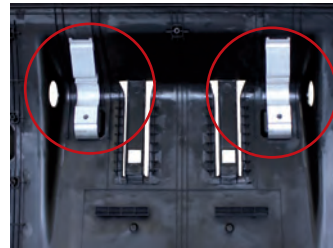

- 2FH/520
- O.E.M. 20936769
- d|s-rh|lh-rechts|links
- grigio, circolare, senza cinghietti
- grey, circular, without stretchers
- grau, kreisförmig, ohne Spanngummi



2FH/518

- 2FH/505
- O.E.M. 20392544
- d|s-rh|lh-rechts|links
- grigio, senza staffe
- grey, without brackets
- grau, ohne Klemme

2FH/505

applicabile a I suitable to I verwendbar für:

FM7-FM10-FM12 SECONDA SERIE | SECOND SERIES | ZWEITE SERIE

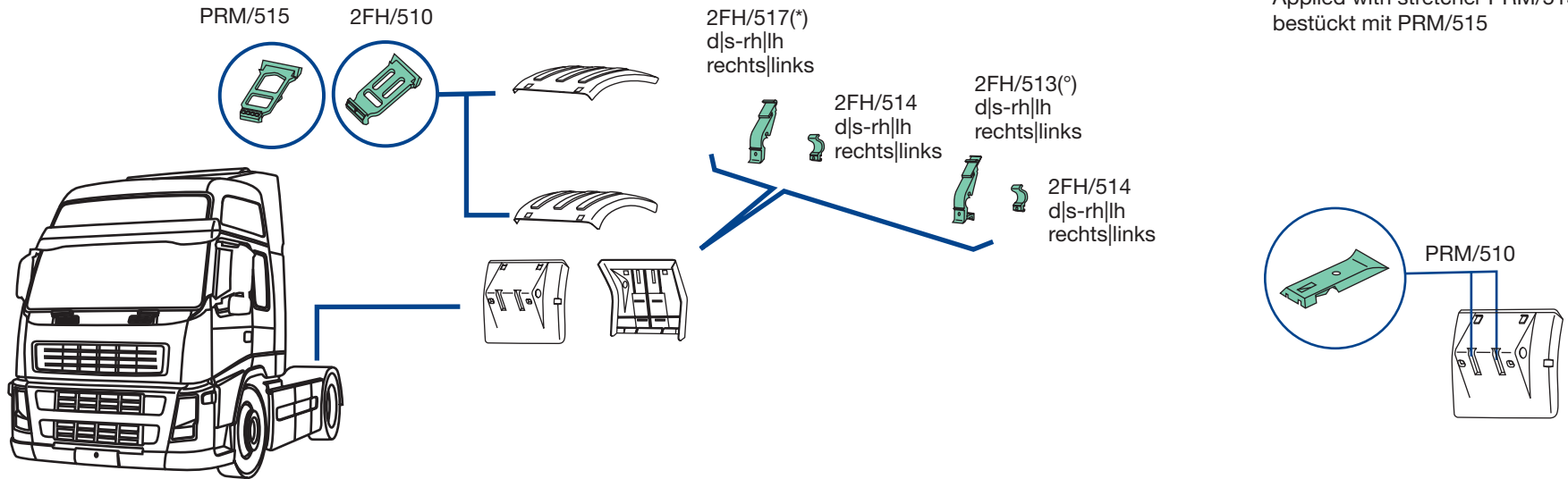

(*) Applicabile con il cinghietto 2FH/510
Applied with stretcher 2FH/510
bestückt mit 2FH/510

(°) Applicabile con il cinghietto PRM/515
Applied with stretcher PRM/515
bestückt mit PRM/515



PRM/510
O.E.M. 20721840



PRM/515
O.E.M. 20498623



2FH/510
O.E.M. 1079981



2FH/513
O.E.M. 20583434



2FH/514
O.E.M. 20583440



2FH/517
O.E.M. 3987252

FM7-FM10-FM12 SECONDA SERIE | SECOND SERIES | ZWEITE SERIE

(*) adattabile a 2FH/505
suitable to 2FH/505
passend für 2FH/505

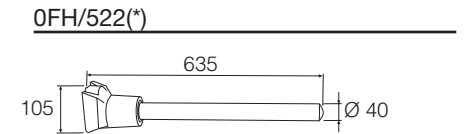
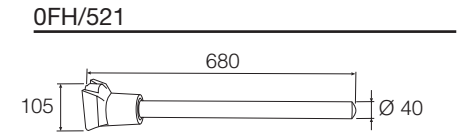
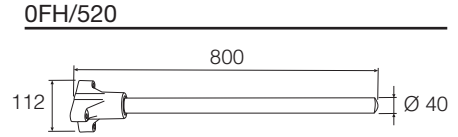
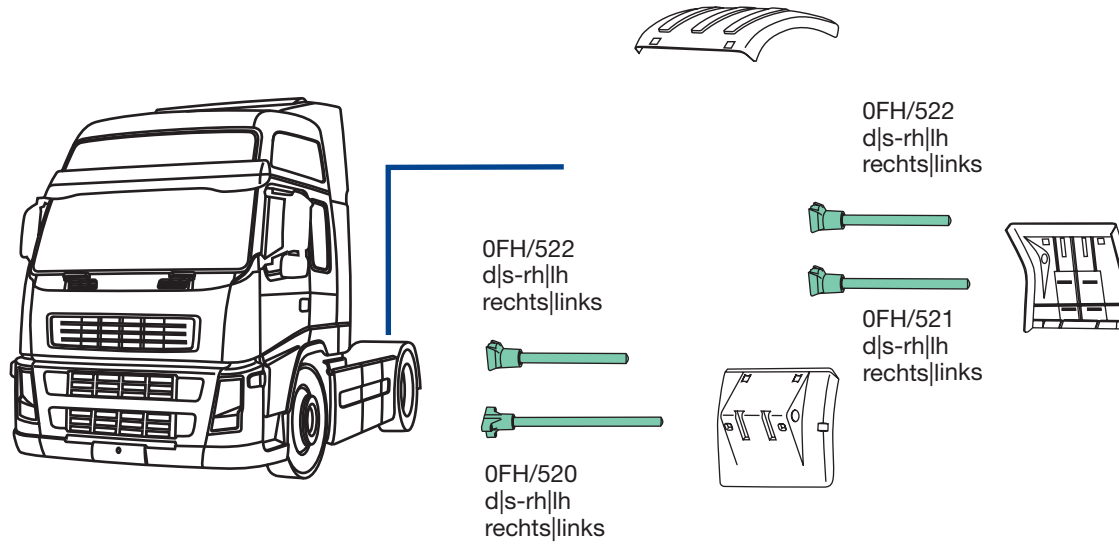

OFH/520
O.E.M. 8154385



OFH/521
O.E.M. 20466895



OFH/522
O.E.M. 3197850

applicabile a I suitable to I verwendbar für:

FM7-FM10-FM12 SECONDA SERIE | SECOND SERIES | ZWEITE SERIE

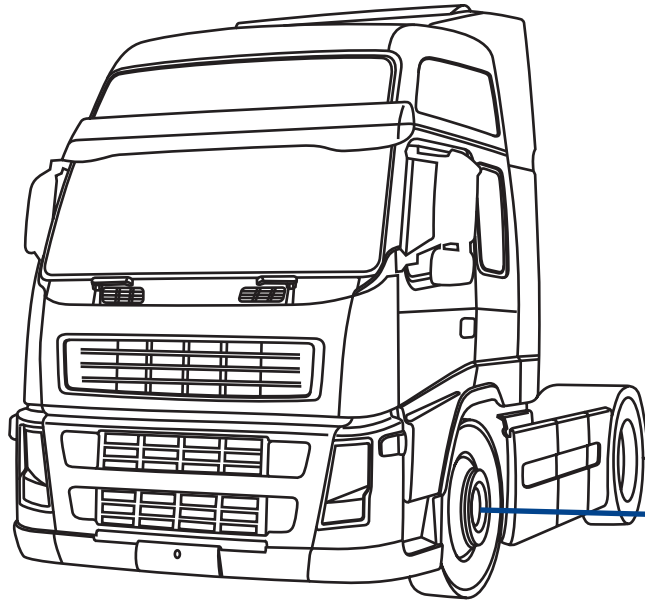

930/033

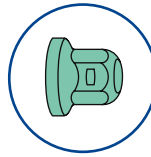

930/100
d-rh-rechts
930/101
s-lh-links

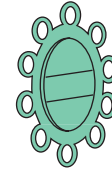

930/001
d-rh-rechts
930/002
s-lh-links



930/200
d|s-rh|lh
rechts|links



930/033
O.E.M. -



930/001
O.E.M. -
930/002
O.E.M. -



930/100
O.E.M. -
930/101
O.E.M. -



930/200
O.E.M. -

FM7-FM10-FM12 SECONDA SERIE | SECOND SERIES | ZWEITE SERIE

930/033-Tappo copri Bullone-Bolt cover-Radmutterkappen

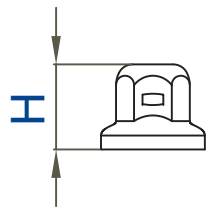

H	45 mm
Per bulloni \varnothing - bolt \varnothing	33 mm
Schlüsselweite \varnothing	
Colore	cromato-chrome-verchromt
Colours-Farbe	
Materiale-Material	acciaio inox-stainless steel Edelstahl
Kg	0,025

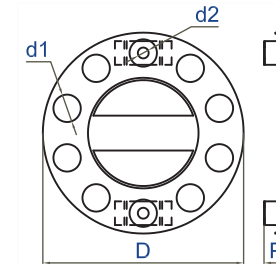

930/001 d-rh-rechts | 930/002 s-lh-links

D \varnothing 425 mm	P 50 mm
d1 nr. 10	d1 \varnothing 58 mm
d2 nr. 2	d2 \varnothing 23 mm
Ventilata	si-yes-Ja
Ventilated-Belüftet	
Colore	cromato e nero-chrome and black
Colours-Farbe	verchromt und schwarz
Materiale-Material	acciaio inox e plastica stainless steel and plastic Edelstahl und Kunststoff
Kg	1,230

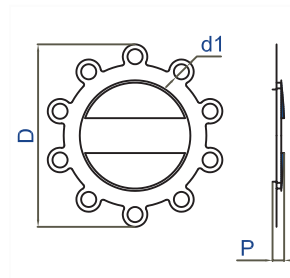

930/100 d-rh-rechts | 930/101 s-lh-links

D \varnothing 387 mm	P 30 mm
d1 nr. 10	d1 \varnothing 32 mm
Ventilata	si-yes-Ja
Ventilated-Belüftet	
Colore	cromato e nero-chrome and black
Colours-Farbe	verchromt und schwarz
Materiale-Material	acciaio inox e plastica stainless steel and plastic Edelstahl und Kunststoff
Kg	0,655

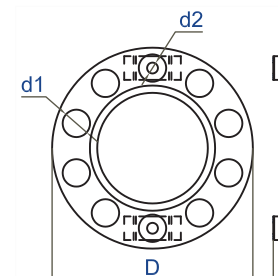

930/200 d|s-rh|lh-rechts+links

D \varnothing 425 mm	P 40 mm
d1 nr. 10	d1 \varnothing 58 mm
d2 nr. 2	d2 \varnothing 23 mm
Ventilata	no-nein
Ventilated-Belüftet	
Colore	cromato-chrome-verchromt
Colours-Farbe	
Materiale-Material	acciaio inox-stainless steel Edelstahl
Kg	1,155

applicabile a I suitable to I verwendbar für:

FM7-FM10-FM12 SECONDA SERIE | SECOND SERIES | ZWEITE SERIE

OFH/670

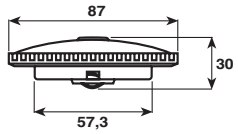

OFH/670

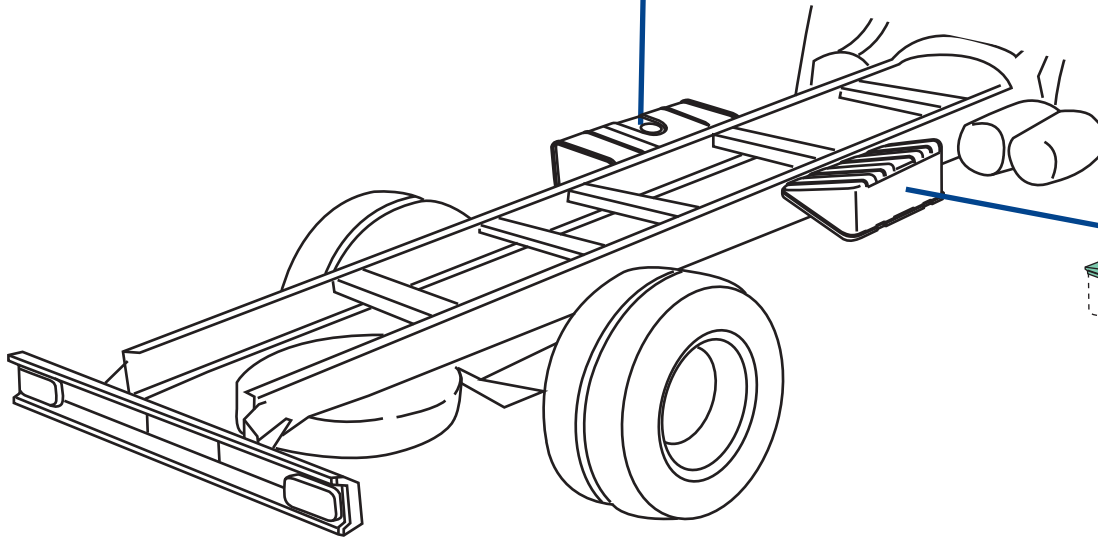
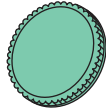

2FH/619

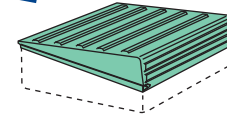

OFH/670
O.E.M. 20896946



2FH/619
O.E.M. 20507252



applicabile a | suitable to | verwendbar für

65

O FM

FM7-FM10-FM12

PRIMA SERIE | FIRST SERIES | ERSTE SERIE

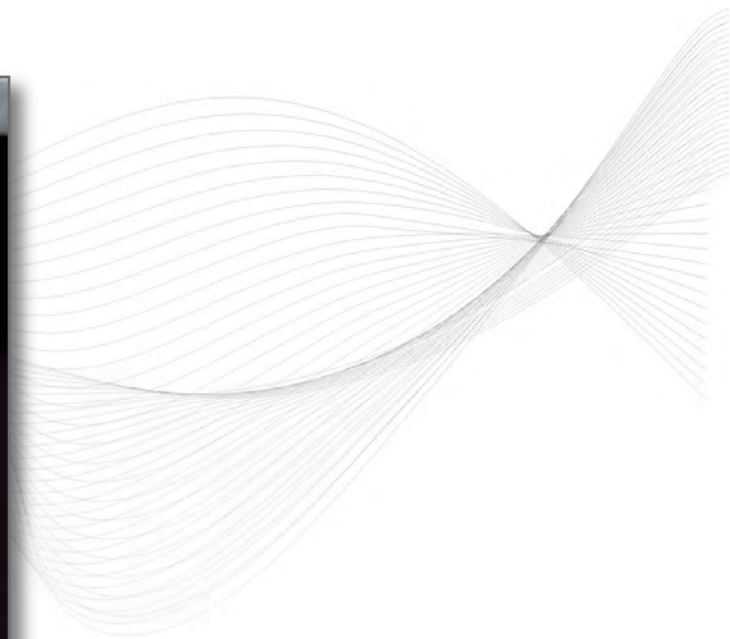

IT Stampo in acciaio temprato per la produzione della porta anteriore cabina
EN Hardened steel mould for door cab production
DE Gehärtete Stahlform für Tür Produktion

FM7-FM10-FM12 PRIMA SERIE | FIRST SERIES | ERSTE SERIE

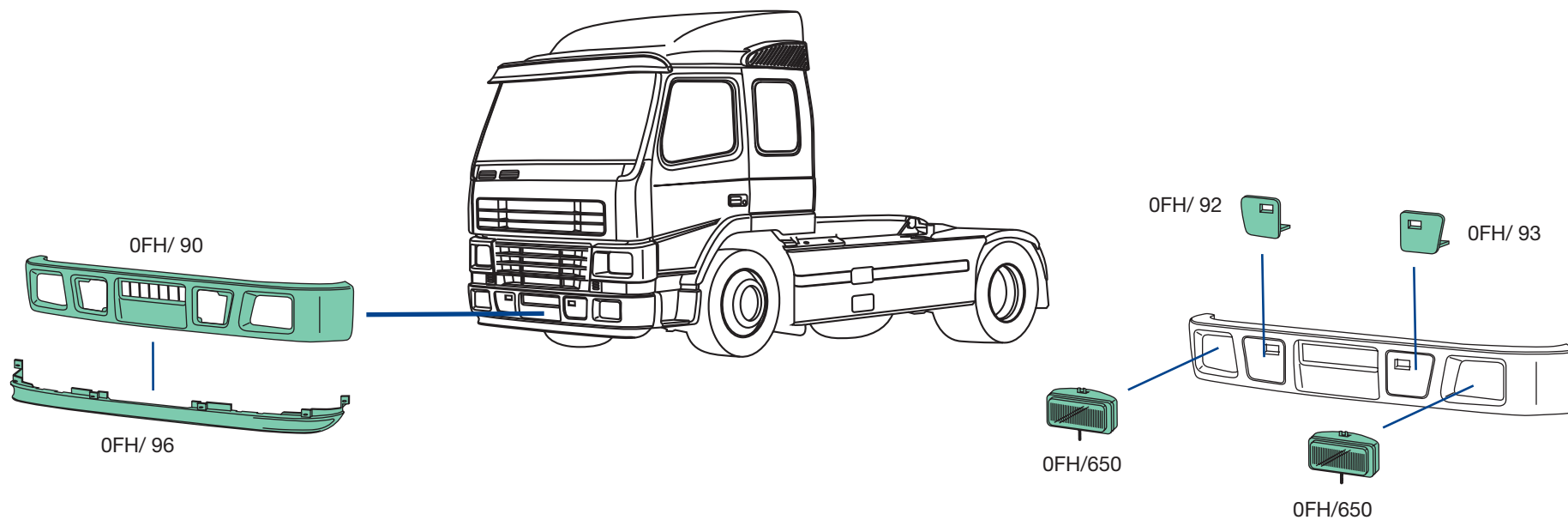

OFH/ 90
O.E.M. 8189329



OFH/ 92
O.E.M. 20372227
OFH/ 93
O.E.M. 20372226



OFH/ 96
O.E.M. 8152722



OFH/650
O.E.M. 1062190

applicabile a l suitable to l verwendbar für:

FM7-FM10-FM12 PRIMA SERIE | FIRST SERIES | ERSTE SERIE

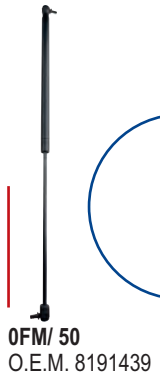
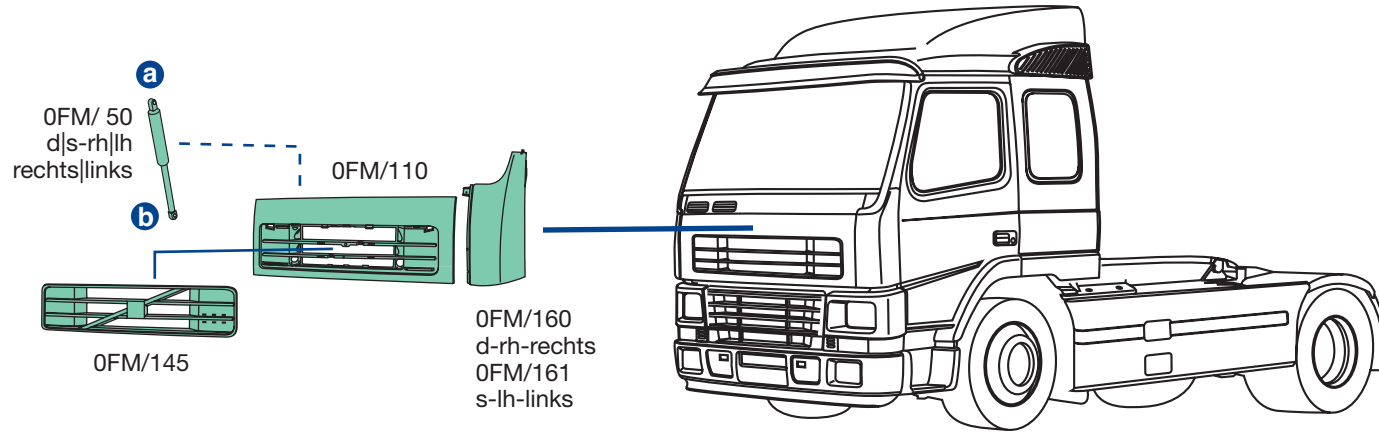

FM7-FM10-FM12 PRIMA SERIE | FIRST SERIES | ERSTE SERIE

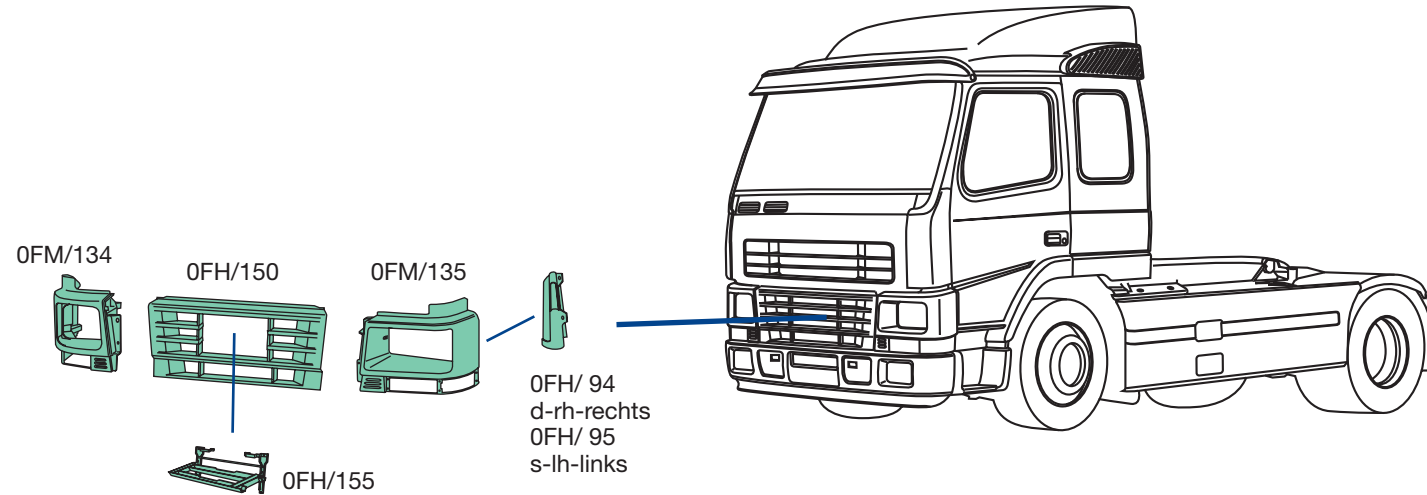

OFM/134
O.E.M. 20398388
OFM/135
O.E.M. 20398387



OFH/94
O.E.M. 8141290
OFH/95
O.E.M. 8141289



OFH/150
O.E.M. 1063509



OFH/155
O.E.M. 3175863

applicabile a I suitable to I verwendbar für:

FM7-FM10-FM12 PRIMA SERIE | FIRST SERIES | ERSTE SERIE

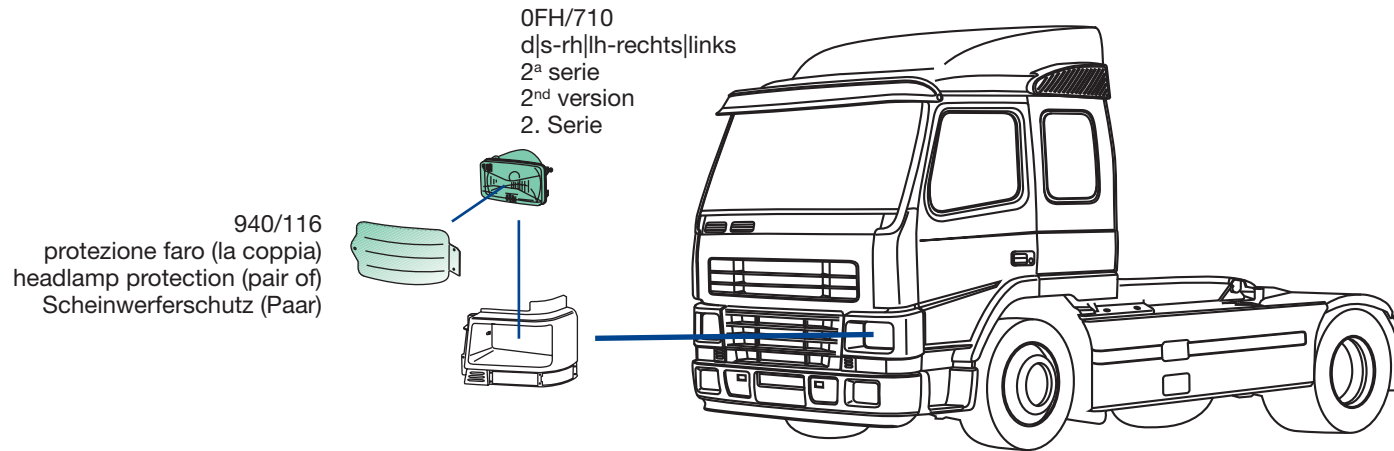

0FH/710
O.E.M. 3981593



940/116
O.E.M. -

FM7-FM10-FM12 PRIMA SERIE | FIRST SERIES | ERSTE SERIE

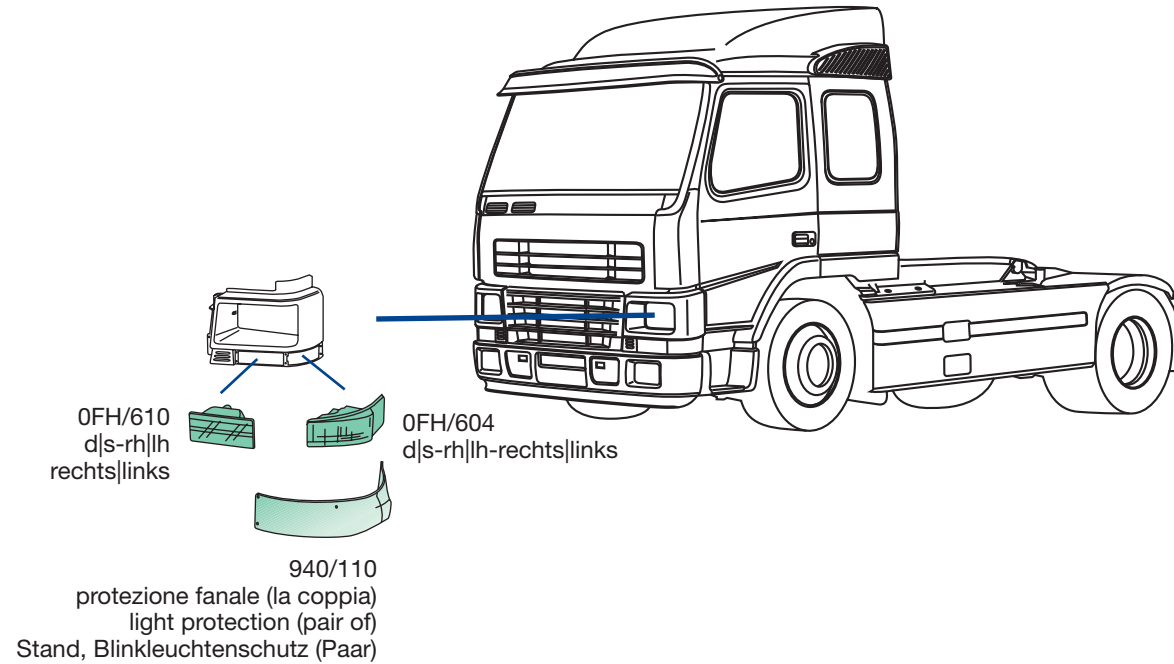

0FH/604
O.E.M. 3981668



0FH/610
O.E.M. 3981666



940/110
O.E.M. -

applicabile a l suitable to l verwendbar für:

FM7-FM10-FM12 PRIMA SERIE | FIRST SERIES | ERSTE SERIE

OFH/190

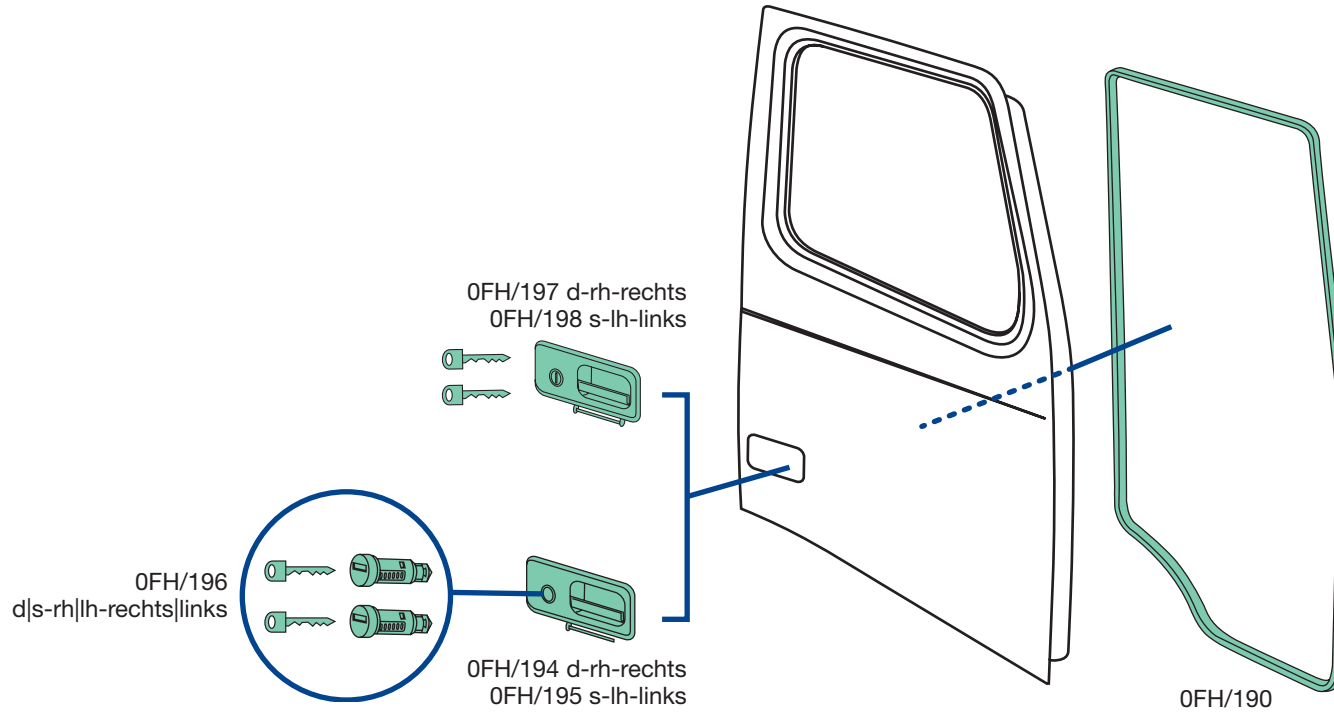
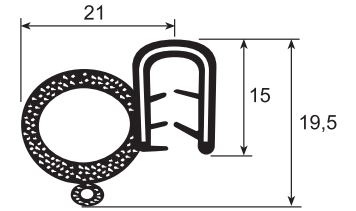

OFH/190
O.E.M. 3175029



OFH/194
O.E.M. 20398467
OFH/195
O.E.M. 20398466



OFH/196
O.E.M. 3090484



OFH/197
O.E.M. -
OFH/198
O.E.M. -

FM7-FM10-FM12 PRIMA SERIE | FIRST SERIES | ERSTE SERIE

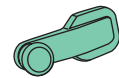
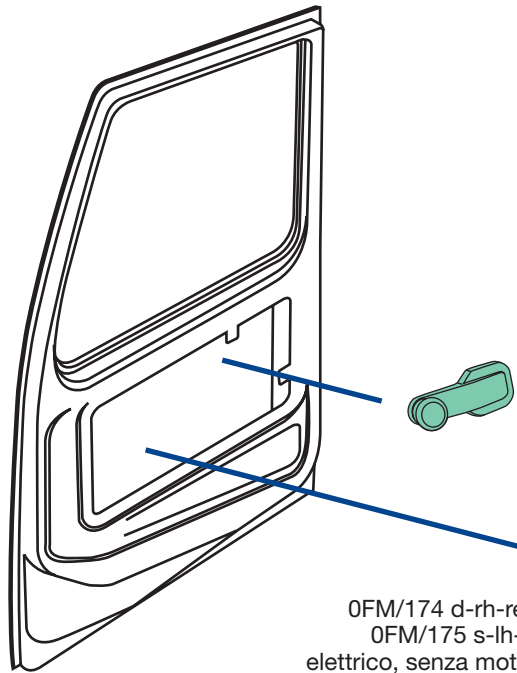

OFM/170
d|s-rh|lh
rechts|links

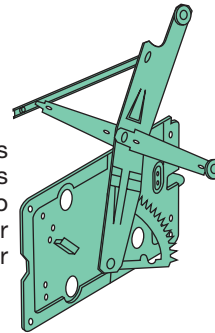

OFM/174 d-rh-rechts
OFM/175 s-lh-links
elettrico, senza motorino
electric, without motor
elektrisch, ohne Motor

OFH/164 d-rh-rechts
OFH/165 s-lh-links
elettrico, con motorino
electric, with motor
elektrisch, mit Motor

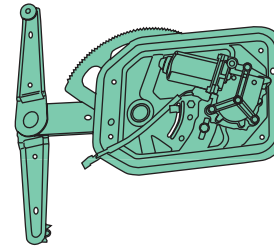

OFH/168 d-rh-rechts
OFH/169 s-lh-links

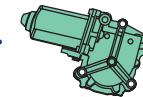

OFM/170
O.E.M. 8140016



OFM/174
O.E.M. -
OFM/175
O.E.M. -

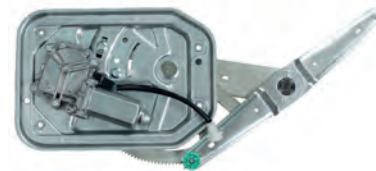

IN ALLESTIMENTO::NOT AVAILABLE YET::IN ARBEIT

OFH/164
O.E.M. 3176542
OFH/165
O.E.M. 3176541



IN ALLESTIMENTO::NOT AVAILABLE YET::IN ARBEIT

OFH/168
O.E.M. 3176550
OFH/169
O.E.M. 3176549

applicabile a I suitable to I verwendbar für:

FM7-FM10-FM12 PRIMA SERIE | FIRST SERIES | ERSTE SERIE



0FH/508



II

E4 024109

198x433 mm



IV

E4 024110

181x175 mm

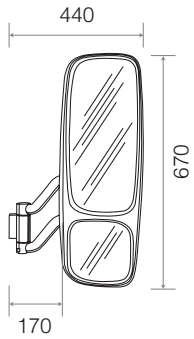

applicabilità:
applicable to:
Verwendbar für







VOLVO FH 1993→2002
VOLVO FM 1998→2002



II

IV

FM7-FM10-FM12 PRIMA SERIE | FIRST SERIES | ERSTE SERIE

a	0FH/512	3091751			240x250 mm
b	0FH/506	20854564 (3092854)			E4 024109 198x433 mm
c	0FH/507	21203311			E4 024110 181x175 mm

II

IV

applicabile a I suitable to I verwendbar für:

FM7-FM10-FM12 PRIMA SERIE | FIRST SERIES | ERSTE SERIE



0FH/509



II

E4 024109

198x433 mm



IV

E4 024110

181x175 mm

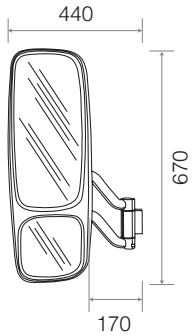

applicabilità:
applicable to:
Verwendbar für



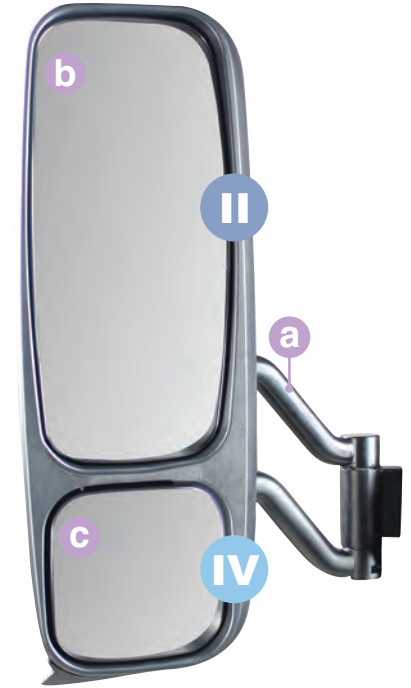



VOLVO FH 1993→2002
VOLVO FM 1998→2002



II

IV

FM7-FM10-FM12 PRIMA SERIE | FIRST SERIES | ERSTE SERIE

<p>a OFH/513</p>	<p>3091750</p>			<p>240x250 mm</p>
<p>b OFH/506 II</p>	<p>20854564 (3092854)</p>			<p>E4 024109 198x433 mm</p>
<p>c OFH/507 IV</p>	<p>21203311</p>			<p>E4 024110 181x175 mm</p>

applicabile a l suitable to l verwendbar für:

FM7-FM10-FM12 PRIMA SERIE | FIRST SERIES | ERSTE SERIE

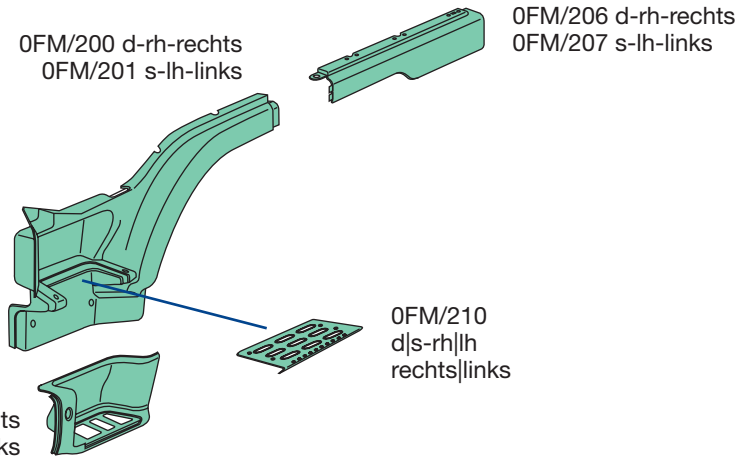
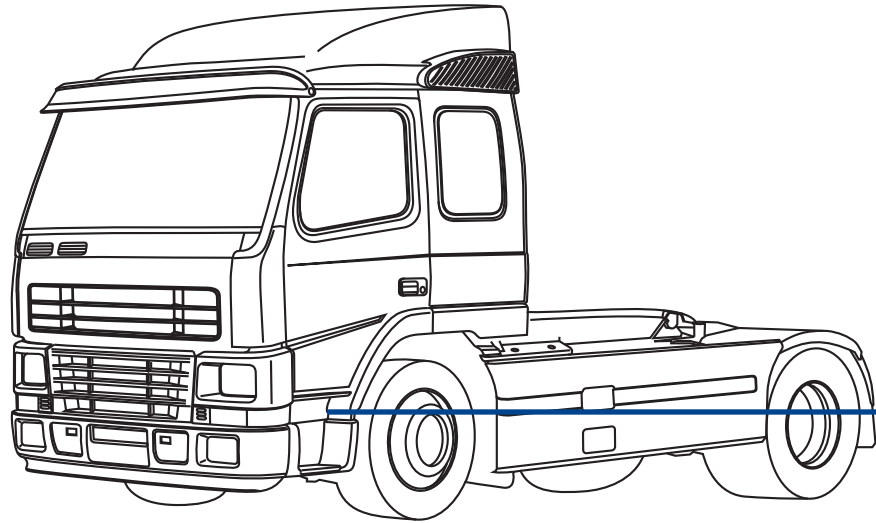

0FM/200
O.E.M. 20529483
0FM/201
O.E.M. 20537185



0FM/206
O.E.M. 20530083
0FM/207
O.E.M. 20530082



0FM/210
O.E.M. 1063726



0FM/240
O.E.M. 1062134
0FM/241
O.E.M. 8191593

FM7-FM10-FM12 PRIMA SERIE | FIRST SERIES | ERSTE SERIE

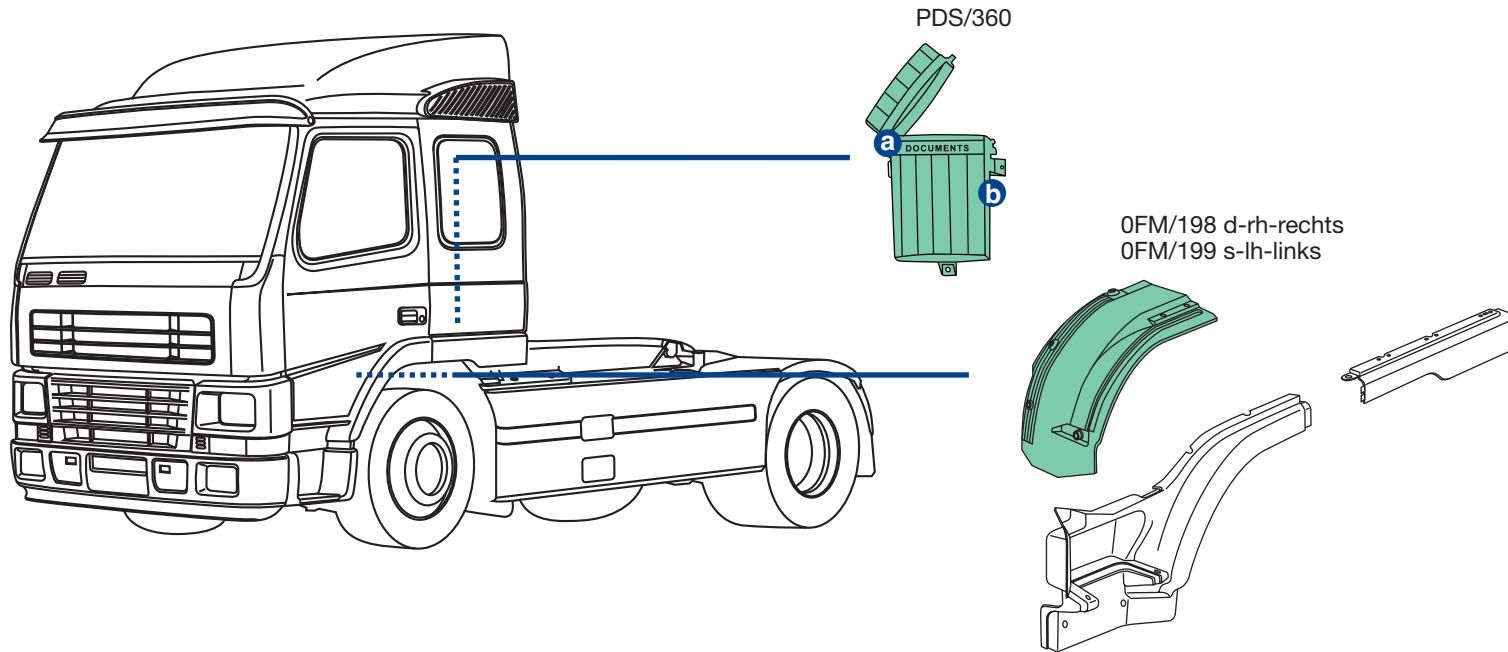

PDS/360
O.E.M. -

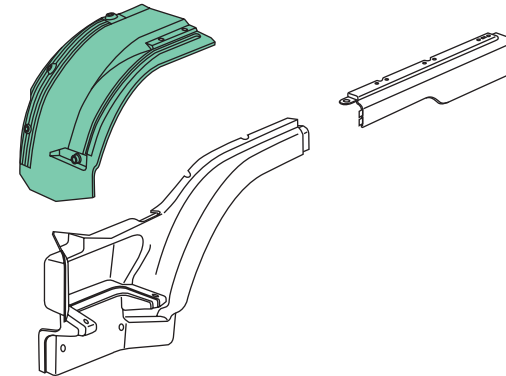
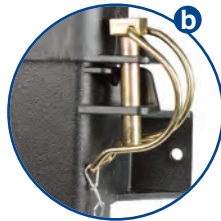

OFM/198
O.E.M. 8191781
OFM/199
O.E.M. 8191780



applicabile a I suitable to I verwendbar für:

FM7-FM10-FM12 PRIMA SERIE | FIRST SERIES | ERSTE SERIE

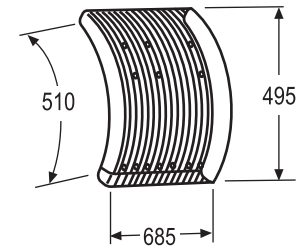
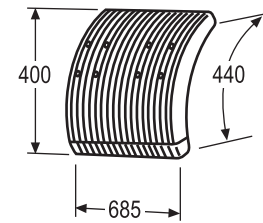
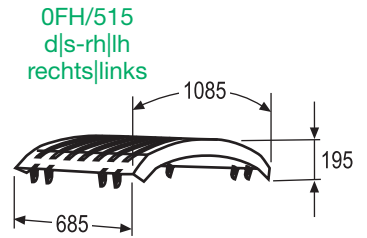
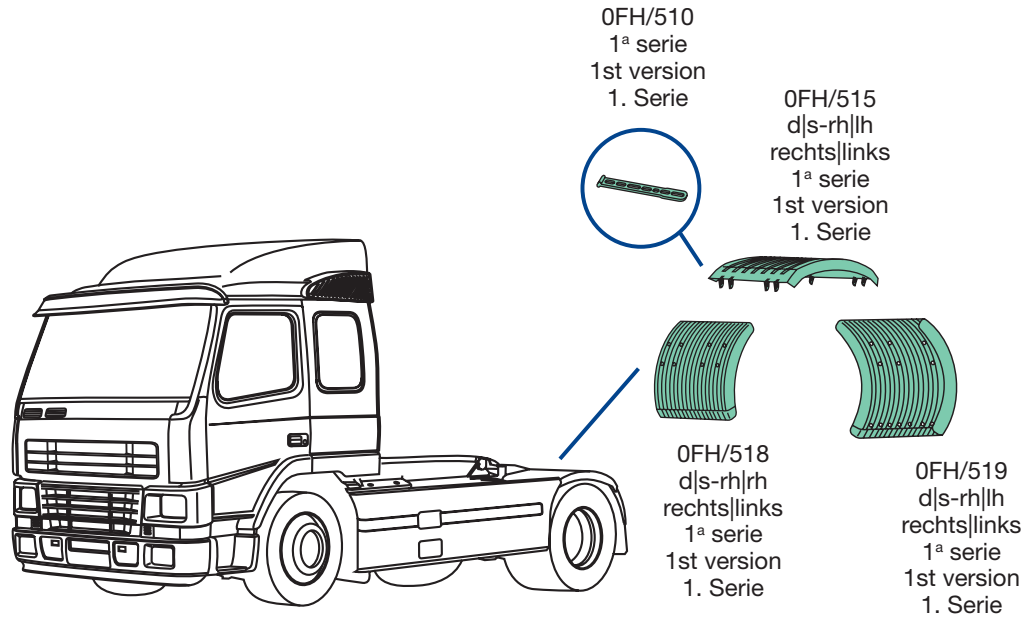

0FH/510
O.E.M. 8156556

- OFH/515
- O.E.M. 8190106
- d|s-rh|lh-rechts|links
- nero, semipiatta, con 8 cinghietti
- black, semi-flat, with 8 stretchers
- schwarz, halbflach, mit 8 Spanngummi



OFH/518
 O.E.M. 8156551
 d|s-rh|lh-rechts|links
 nero-black-schwarz

OFH/519
 O.E.M. 8156554
 d|s-rh|lh-rechts|links
 nero, senza anti-spray
 black, without anti-spray
 schwarz, ohne Spritzschutz



vista esterna - external view
 Außenansicht

FM7-FM10-FM12 PRIMA SERIE | FIRST SERIES | ERSTE SERIE

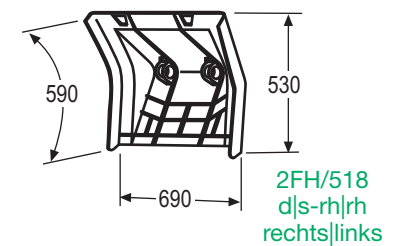
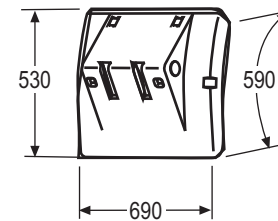
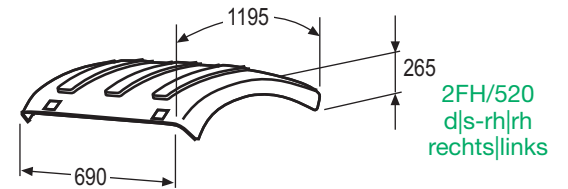
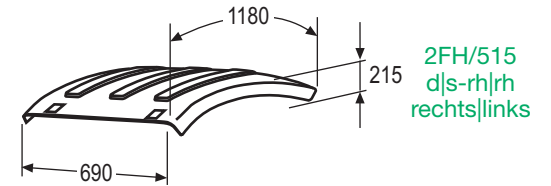
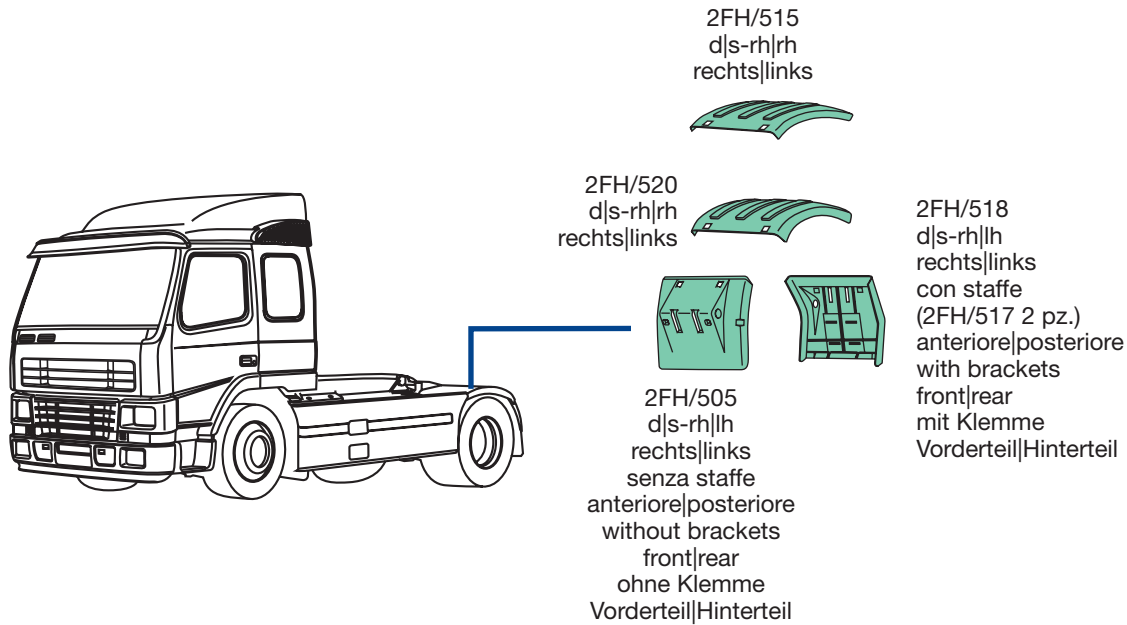

- 2FH/515
- O.E.M. 20936759
- d|s-rh|lh-rechts|links
- grigio, semipiatta, senza cinghietti
- grey, semi-flat, without stretchers
- grau, halbflach, ohne Spanngummi

- 2FH/518
- O.E.M. 20392599
- d|s-rh|lh-rechts|links
- grigio, senza anti-spray, con staffe
- grey, without anti-spray, with brackets
- grau, ohne Spritzschutz, mit Klemme

- 2FH/520
- O.E.M. 20936769
- d|s-rh|lh-rechts|links
- grigio, circolare, senza cinghietti
- grey, circular, without stretchers
- grau, kreisförmig, ohne Spanngummi



- 2FH/505
- O.E.M. 20392544
- d|s-rh|lh-rechts|links
- grigio, senza staffe
- grey, without brackets
- grau, ohne Klemme

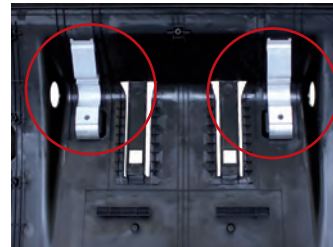

2FH/505

2FH/518

applicabile a I suitable to I verwendbar für:

FM7-FM10-FM12 PRIMA SERIE | FIRST SERIES | ERSTE SERIE

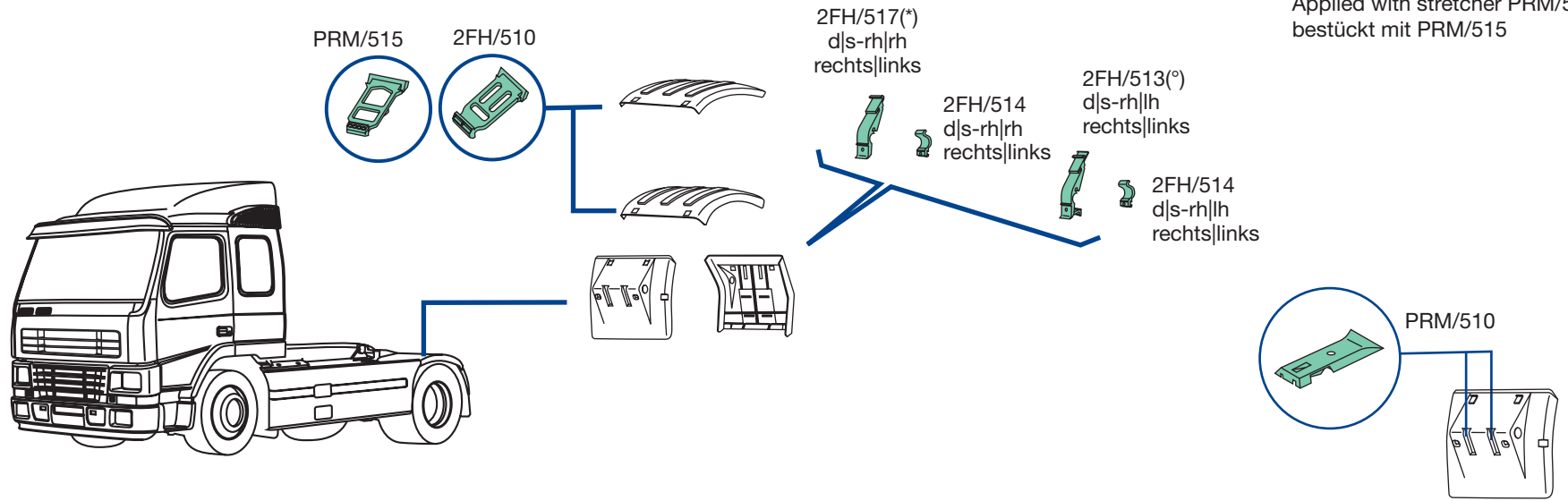

(*) Applicabile con il cinghietto 2FH/510
Applied with stretcher 2FH/510
bestückt mit 2FH/510

(°) Applicabile con il cinghietto PRM/515
Applied with stretcher PRM/515
bestückt mit PRM/515



PRM/510
O.E.M. 20721840



PRM/515
O.E.M. 20498623



2FH/510
O.E.M. 1079981



2FH/513
O.E.M. 20583434



2FH/514
O.E.M. 20583440



2FH/517
O.E.M. 3987252

FM7-FM10-FM12 PRIMA SERIE | FIRST SERIES | ERSTE SERIE

(*) adattabile a 2FH/505
suitable to 2FH/505
passend für 2FH/505

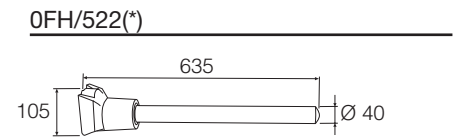
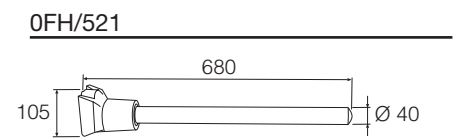
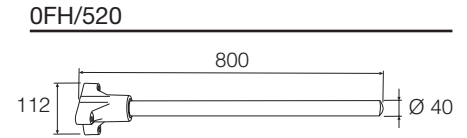
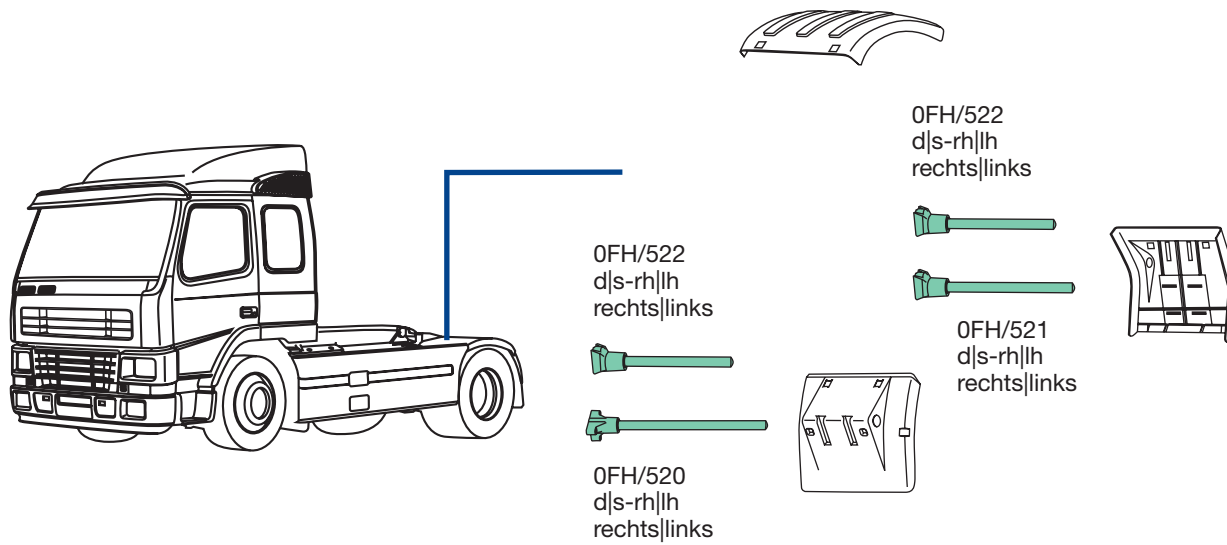

OFH/520
O.E.M. 8154385

OFH/521
O.E.M. 20466895

OFH/522
O.E.M. 3197850

applicabile a l suitable to l verwendbar für:

FM7-FM10-FM12 PRIMA SERIE | FIRST SERIES | ERSTE SERIE

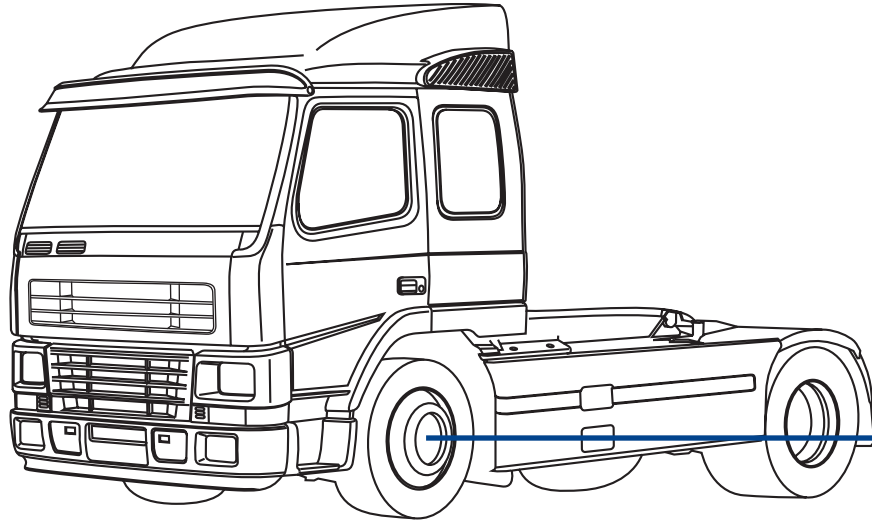

930/033

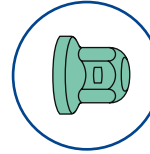

930/100
d-rh-rechts
930/101
s-lh-links

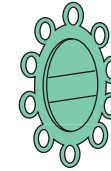

930/001
d-rh-rechts
930/002
s-lh-links



930/200
d|s-rh|lh
rechts|links



930/033
O.E.M. -



930/001
O.E.M. -
930/002
O.E.M. -



930/100
O.E.M. -
930/101
O.E.M. -



930/200
O.E.M. -

FM7-FM10-FM12 PRIMA SERIE | FIRST SERIES | ERSTE SERIE

930/033-Tappo copri Bullone-Bolt cover-Radmutterkappen

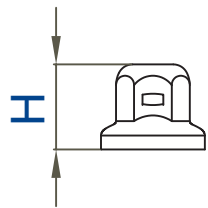

H	45 mm
Per bulloni \varnothing - bolt \varnothing	33 mm
Schlüsselweite \varnothing	
Colore	cromato-chrome-verchromt
Colours-Farbe	
Materiale-Material	acciaio inox-stainless steel Edelstahl
Kg	0,025

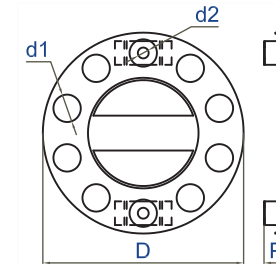

930/001 d-rh-rechts | 930/002 s-lh-links

D \varnothing 425 mm	P 50 mm
d1 nr. 10	d1 \varnothing 58 mm
d2 nr. 2	d2 \varnothing 23 mm
Ventilata	si-yes-Ja
Ventilated-Belüftet	
Colore	cromato e nero-chrome and black
Colours-Farbe	verchromt und schwarz
Materiale-Material	acciaio inox e plastica stainless steel and plastic Edelstahl und Kunststoff
Kg	1,230

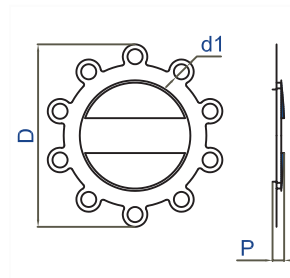

930/100 d-rh-rechts | 930/101 s-lh-links

D \varnothing 387 mm	P 30 mm
d1 nr. 10	d1 \varnothing 32 mm
Ventilata	si-yes-Ja
Ventilated-Belüftet	
Colore	cromato e nero-chrome and black
Colours-Farbe	verchromt und schwarz
Materiale-Material	acciaio inox e plastica stainless steel and plastic Edelstahl und Kunststoff
Kg	0,655

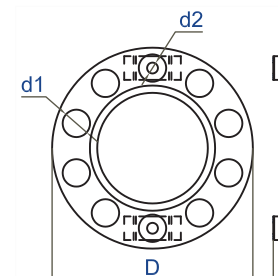

930/200 d|s-rh|lh-rechts+links

D \varnothing 425 mm	P 40 mm
d1 nr. 10	d1 \varnothing 58 mm
d2 nr. 2	d2 \varnothing 23 mm
Ventilata	no-nein
Ventilated-Belüftet	
Colore	cromato-chrome-verchromt
Colours-Farbe	
Materiale-Material	acciaio inox-stainless steel Edelstahl
Kg	1,155



- IT Maschera di controllo per le porte Scania SCR/ 2 e SCR/ 3
EN Checking Jig for Scania Doors SCR/ 2 and SCR/ 3
DE Überprüfung der Scania (SCR/2 und SCR/3) Türen auf Paßgenauigkeit.



applicabile a | suitable to | verwendbar für

89

4FH
FH Euro 6



- IT Stampo in acciaio per la produzione di griglietta superiore (4FH/152)
EN Stainless steel Mould for the production of upper small grille (4FH/152)
DE Gehärtete Stahlform für die Produktion des oberen Schutzgitters (4FH/152)

FH Euro 6

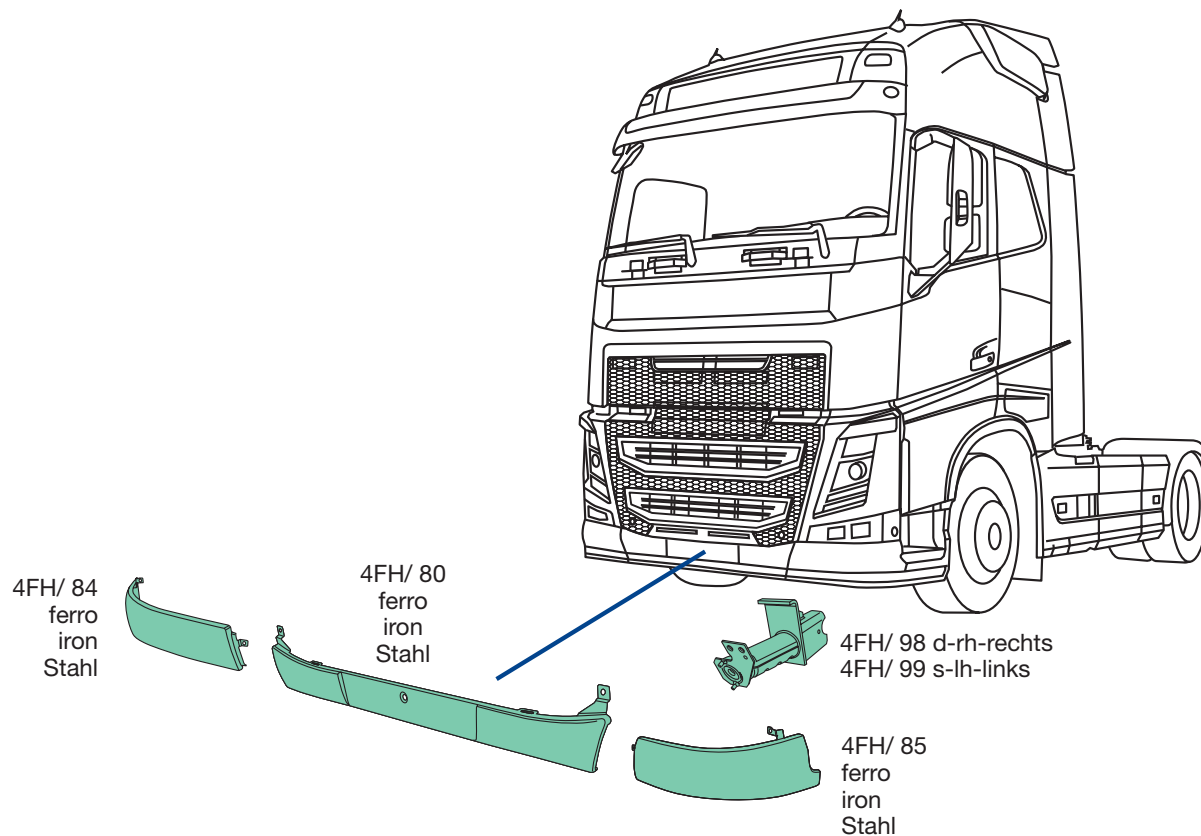

4FH/ 80
O.E.M. 22247766



4FH/ 84
O.E.M. 21838945
4FH/ 85
O.E.M. 21838944

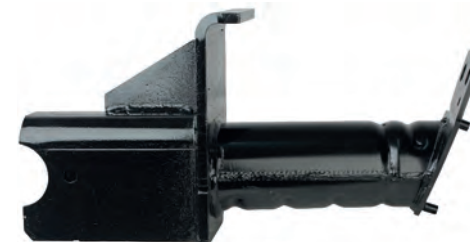

4FH/ 98
O.E.M. 82943981
4FH/ 99
O.E.M. 82928883

applicabile a I suitable to I verwendbar für:

FH Euro 6

(*) plastica, liscio, nero
plastic, smooth, black
Kunststoff, glatt, schwarz

(°) plastica, gofrato, grigio
plastic, textured, grey
Kunststoff, Geprägte, grau

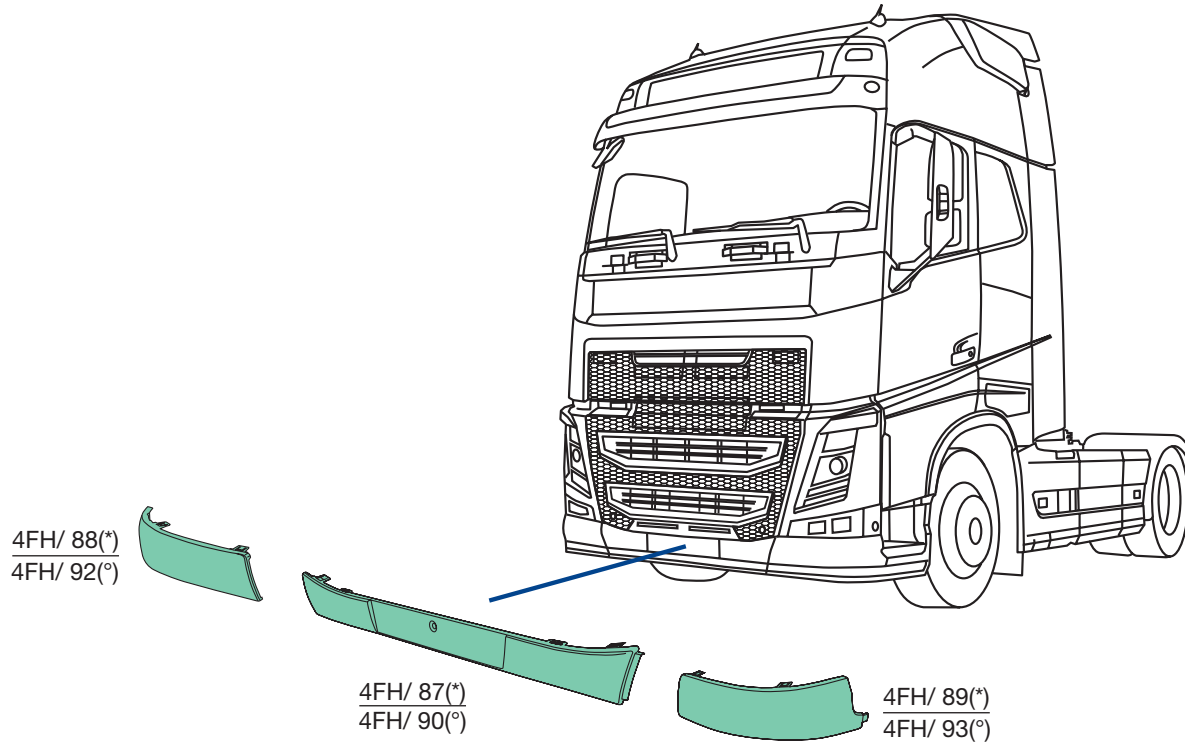

4FH/ 87
O.E.M. 84195623



4FH/ 88
O.E.M. 21413786
4FH/ 89
O.E.M. 21413789



4FH/ 90
O.E.M. 22249883



4FH/ 92
O.E.M. 21316577
4FH/ 93
O.E.M. 21316575

(*) plastica, liscio, nero
plastic, smooth, black
Kunststoff, glatt, schwarz

(°) plastica, gofrato, grigio
plastic, textured, grey
Kunststoff, Geprägte, grau

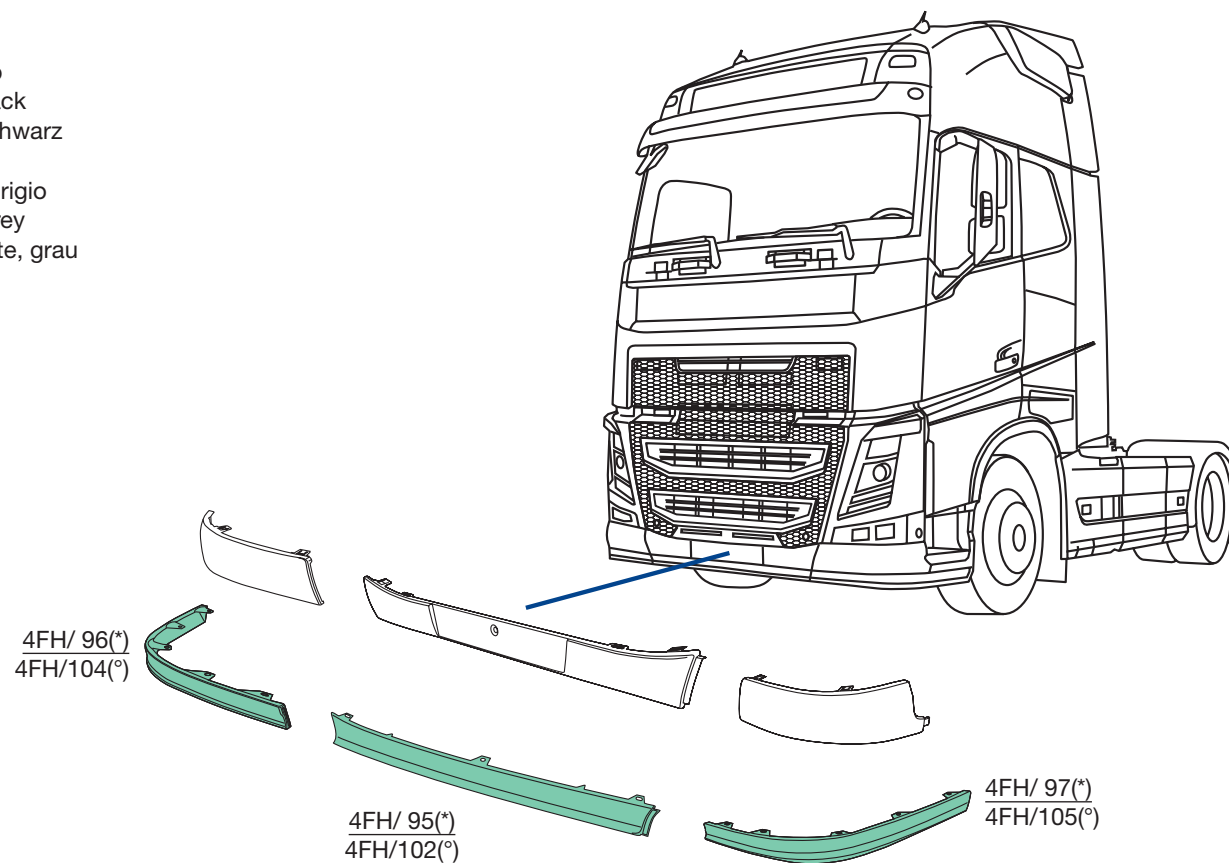

4FH/95
O.E.M. 21495267



4FH/96
O.E.M. 21495268
4FH/97
O.E.M. 21495266



4FH/102
O.E.M. 82101912



4FH/104
O.E.M. 82101914
4FH/105
O.E.M. 82101910

applicabile a | suitable to | verwendbar für:

FH Euro 6

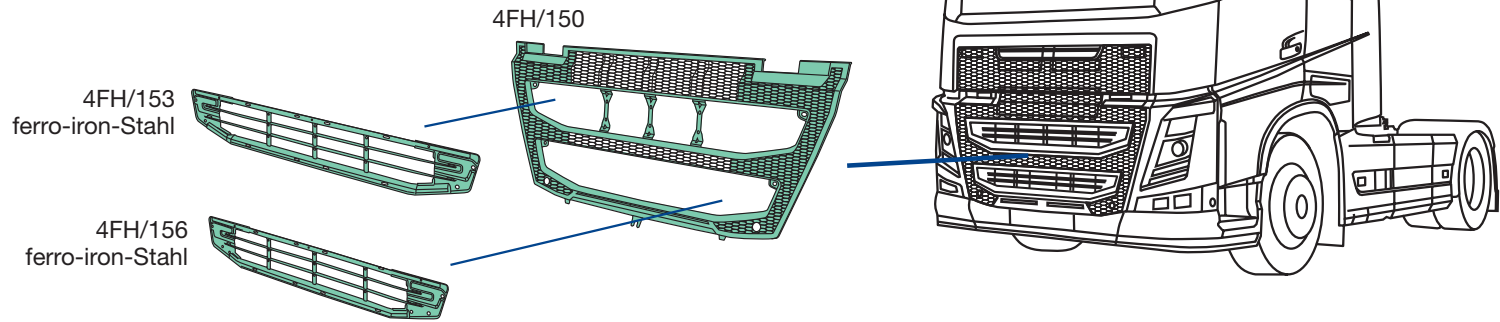

4FH/150
O.E.M. 82491903



4FH/153
O.E.M. 82258426



4FH/156
O.E.M. 82255346

FH Euro 6

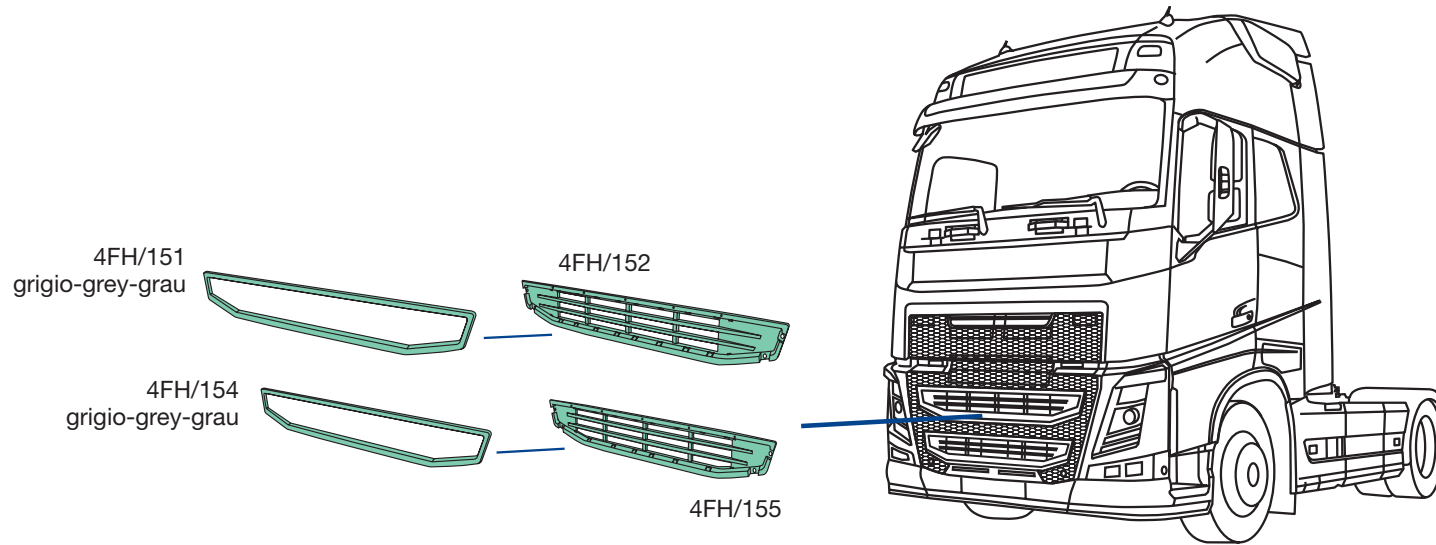

4FH/151
O.E.M. 82180491



4FH/152
O.E.M. 82220161

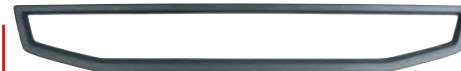

4FH/154
O.E.M. 82177794



4FH/155
O.E.M. 82220206

FH Euro 6

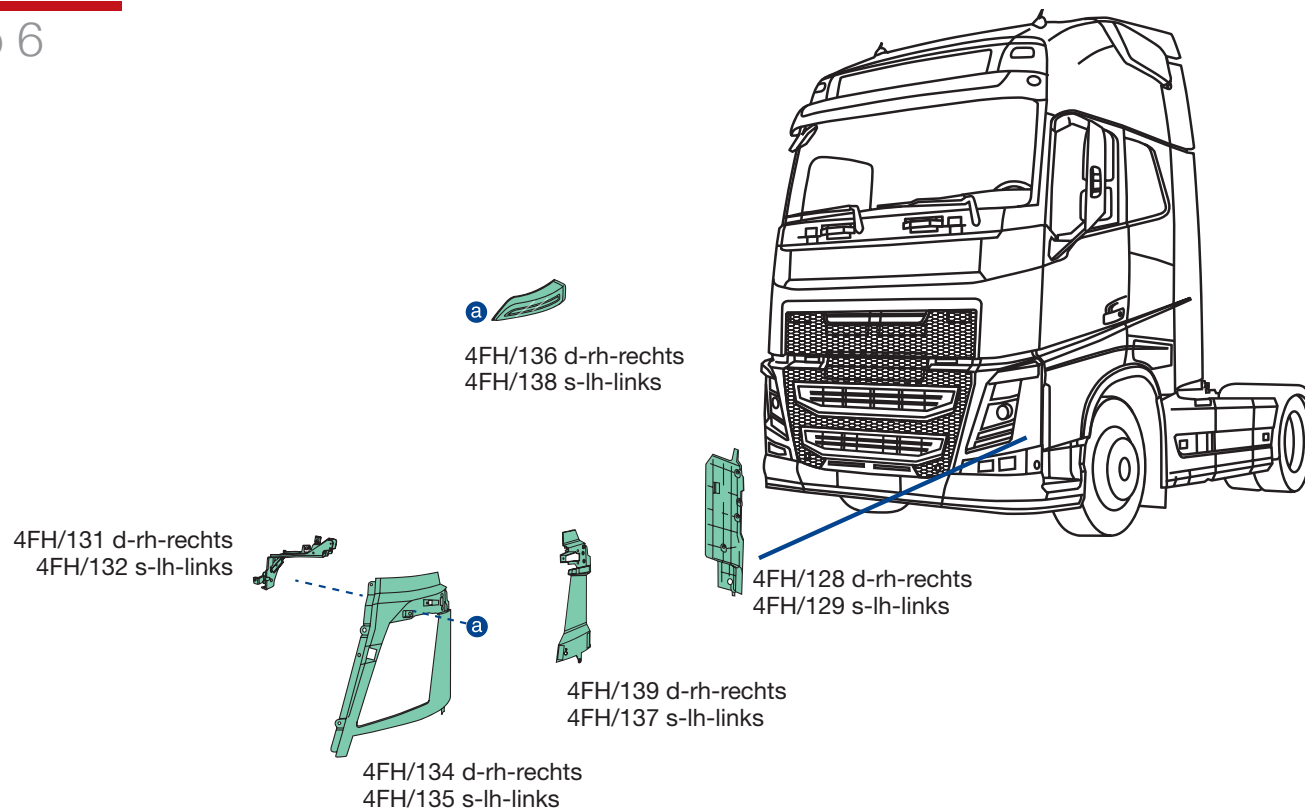

4FH/128
O.E.M. 84139933
4FH/129
O.E.M. 84139886



4FH/131
O.E.M. 84058023
4FH/132
O.E.M. 84046776



4FH/134
O.E.M. 21874457
4FH/135
O.E.M. 21874450



4FH/136
O.E.M. 82151205
4FH/138
O.E.M. 82151157



4FH/139
O.E.M. 82884084
4FH/137
O.E.M. 82884080

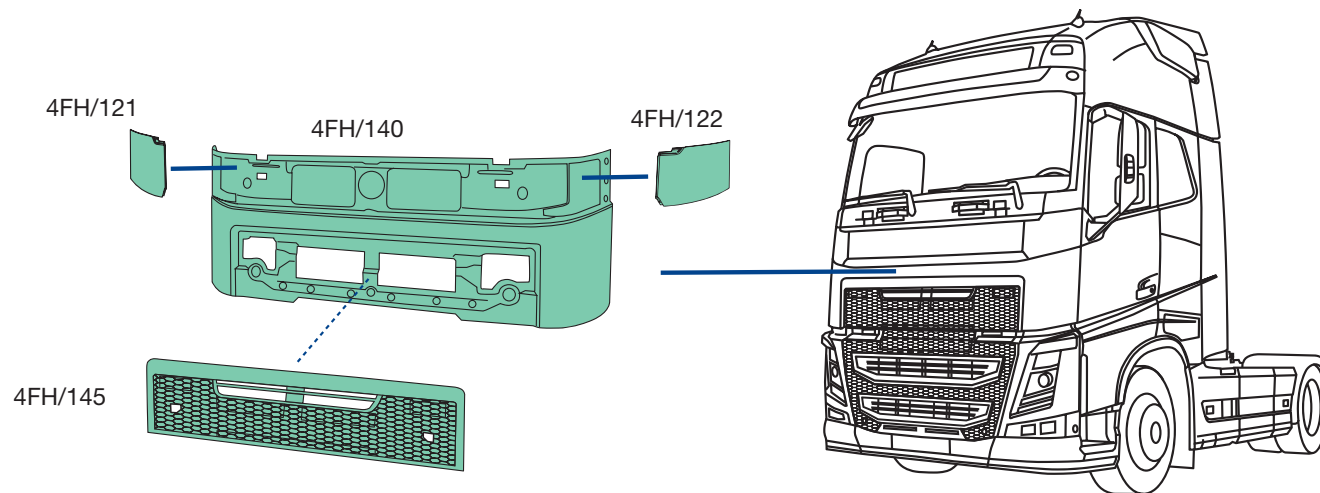

4FH/121
O.E.M. 82858516
4FH/122
O.E.M. 82858486



4FH/140
O.E.M. 82360122

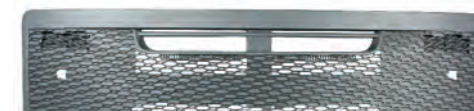

4FH/145
O.E.M. 84033228

applicabile a I suitable to I verwendbar für:

FH Euro 6

4FH/410

O.E. 84014254

Materiale | Material:
PMMA - ACRYLGLAS

4FH/400

O.E. 82166469

Materiale | Material:
ABS



KIT completo di staffe e minuterie
IN ALLESTIMENTO
KIT complete of brackets and findings
NOT AVAILABLE YET
Befestigungssatz
IN ARBEIT

L	H	P	kg.
cm.	cm.	cm.	
227,5	23,8	23,2	3,690



(*) liscio-smooth-glatt
 (°) goffrato-textured-Geprägte

applicabile a | suitable to | verwendbar für:

FH Euro 6

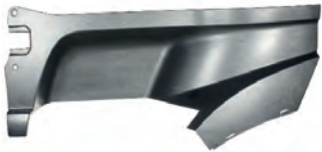
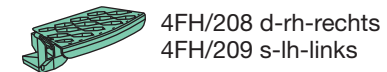
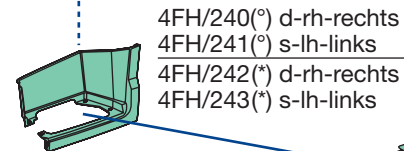
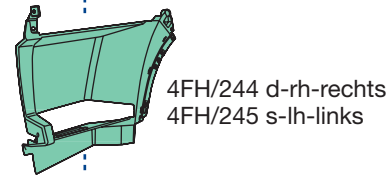
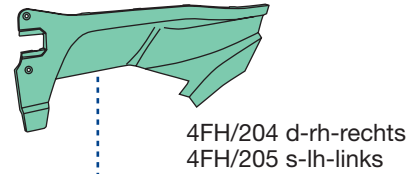
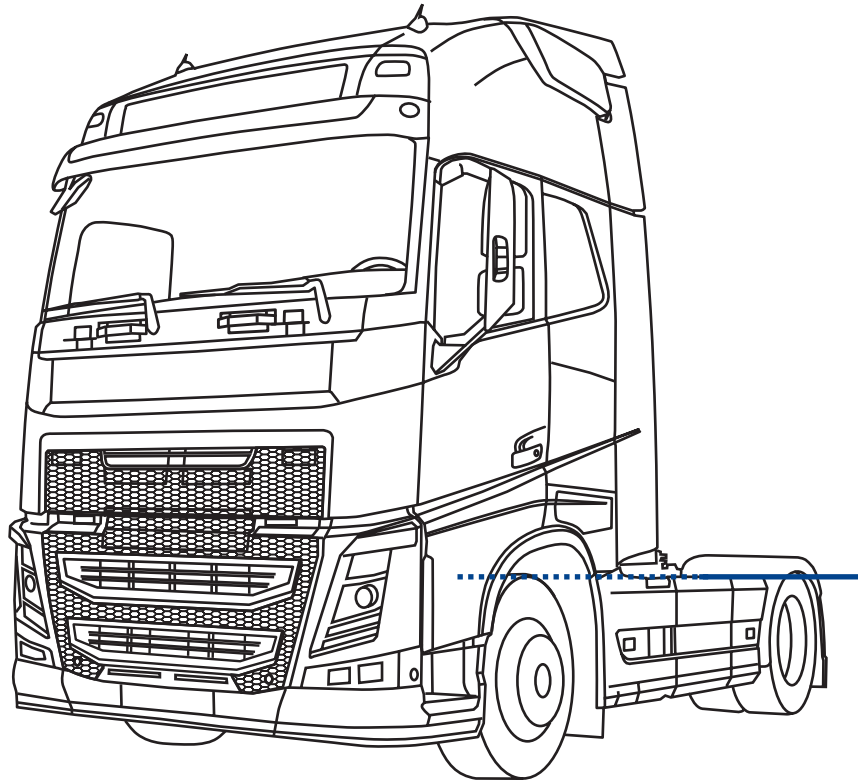

4FH/204
O.E.M. 82819477
4FH/205
O.E.M. 82819482



4FH/208
O.E.M. 82859306
4FH/209
O.E.M. 82171603



4FH/240
O.E.M. 82142373
4FH/241
O.E.M. 82141971



4FH/242
O.E.M. 21392187
4FH/243
O.E.M. 21392183



4FH/244
O.E.M. 82141521
4FH/245
O.E.M. 82136982

applicabile a I suitable to I verwendbar für:

FH Euro 6

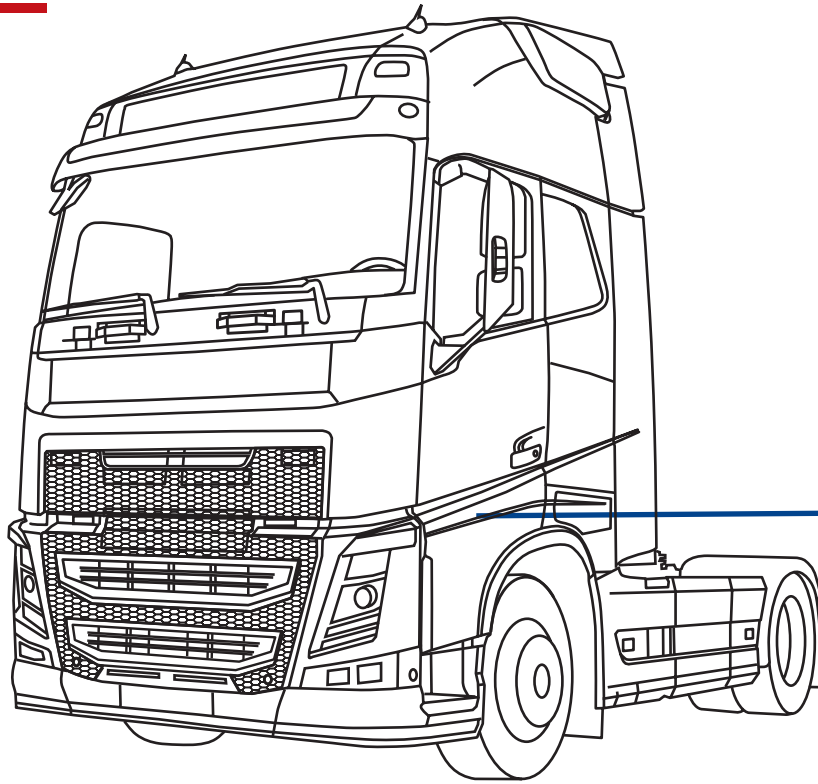

4FH/ 4 d-rh-rechts
4FH/ 5 s-lh-links
alluminio, nero
aluminum, black
aluminium, schwarz

4FH/250 d-rh-rechts
4FH/251 s-lh-links

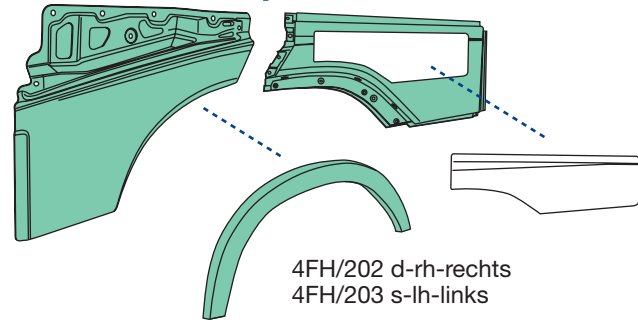

4FH/202 d-rh-rechts
4FH/203 s-lh-links



4FH/ 4
O.E.M. 21642399
4FH/ 5
O.E.M. 21642377



4FH/202
O.E.M. 84096589
4FH/203
O.E.M. 84096588



4FH/250
O.E.M. 84233571



4FH/251
O.E.M. 21940892

FH Euro 6

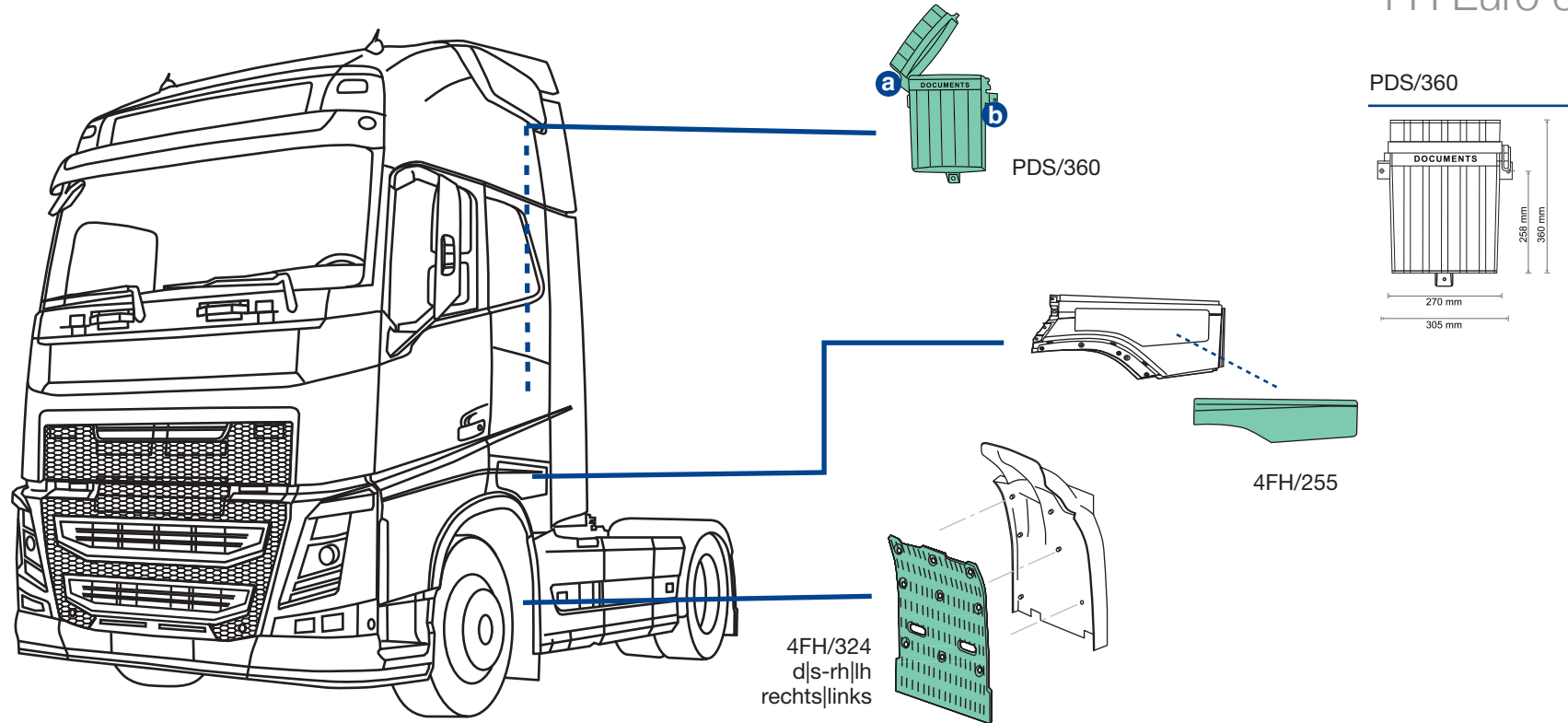

4FH/255
O.E.M. 21413732

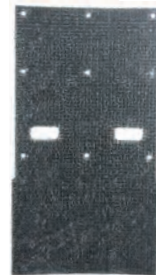

4FH/324
O.E.M. 84106936



PDS/360
O.E.M. -

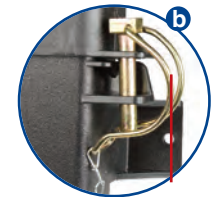

FH Euro 6

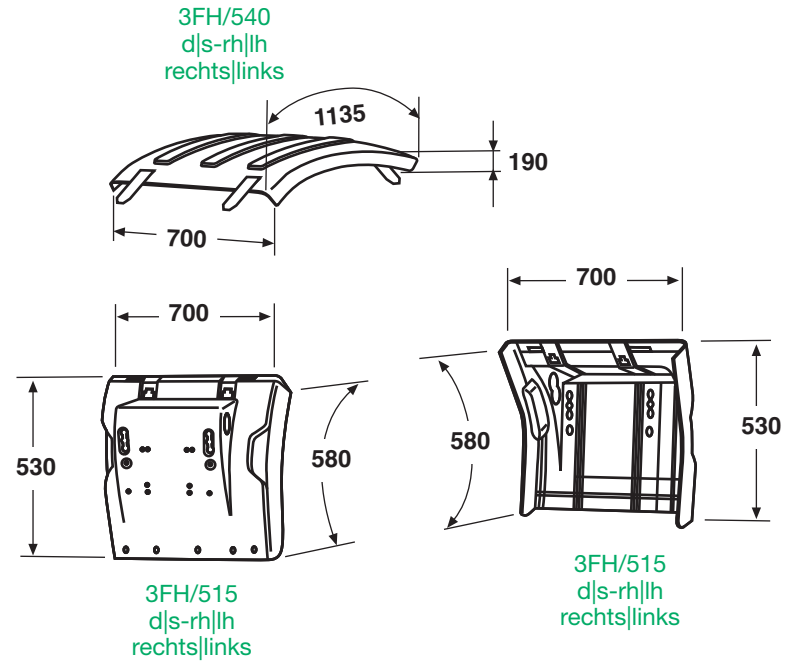
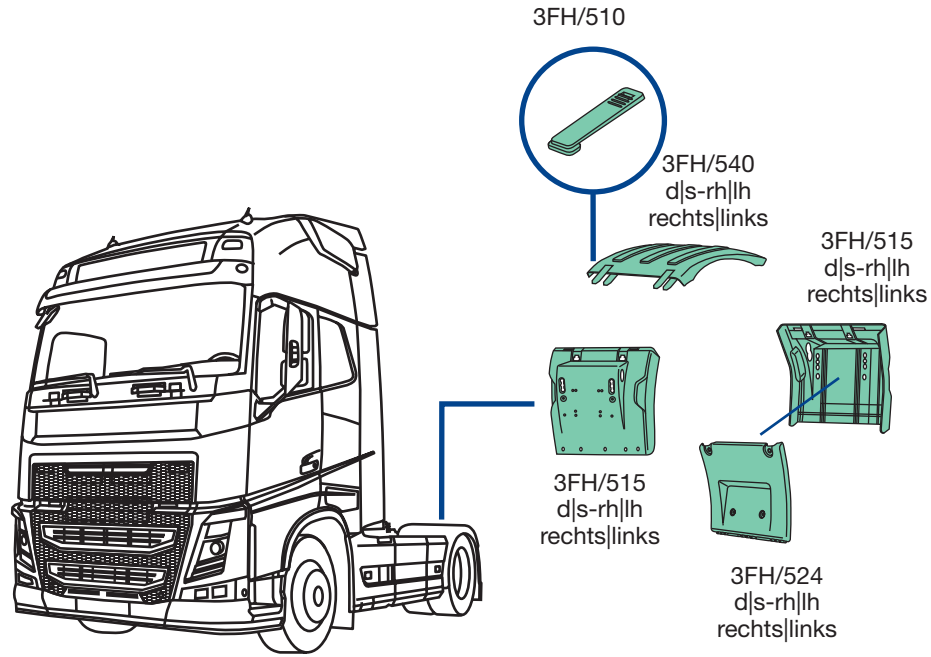

3FH/510
O.E.M. 21094457



3FH/524
O.E.M. 21094447

- 3FH/540
- O.E.M. 21094390
- d|s-rh|lh-rechts|links
- grigio, semipiatta, con 4 cinghietti
- grey, semi-flat, with 4 stretchers
- grau, halbflach, mit 4 Spanngummi



3FH/515

3FH/515
 O.E.M. 21094391
 d|s-rh|lh-rechts|links
 grigio-grey-grau



applicabile a I suitable to I verwendbar für:

FH Euro 6

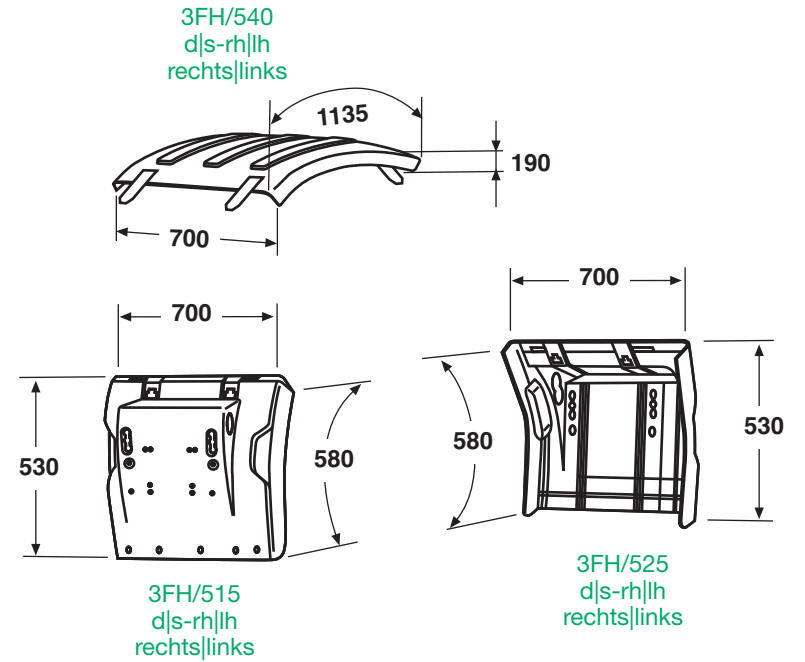
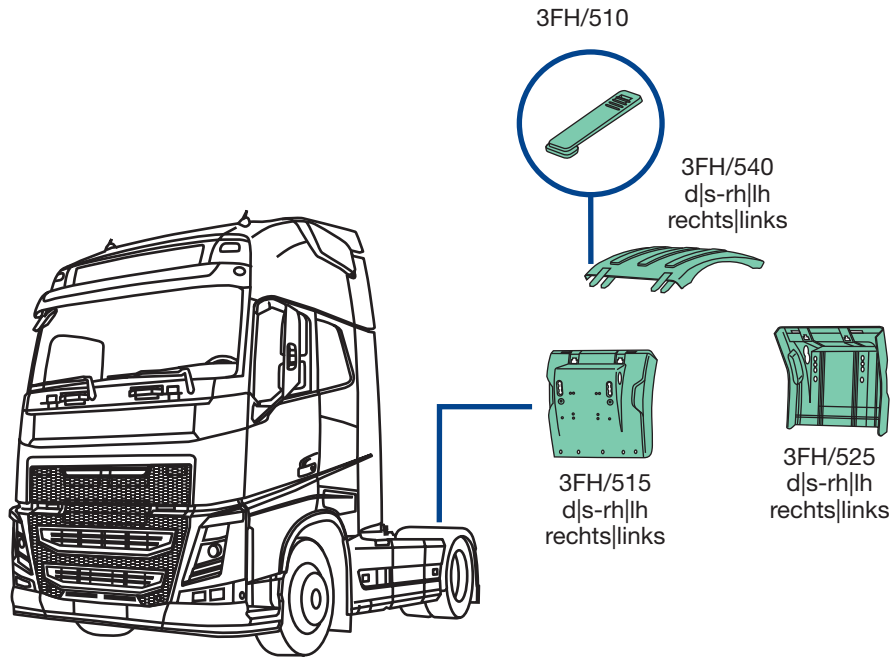

3FH/510
O.E.M. 21094457

- 3FH/540
- O.E.M. 21094390
- d|s-rh|lh-rechts|links
- grigio, semipiatta, con 4 cinghietti
- grey, semi-flat, with 4 stretchers
- grau, halbfach, mit 4 Spanngummi



- 3FH/515
- O.E.M. 21094391
- d|s-rh|lh-rechts|links
- grigio-grey-grau

- 3FH/525
- O.E.M. 21094394
- d|s-rh|lh-rechts|links
- grigio, senza anti-spray
- grey, without anti-spray
- grau, ohne Spritzschutz



vista esterna - external view
Außenansicht

applicabile a I suitable to I verwendbar für:

FH Euro 6

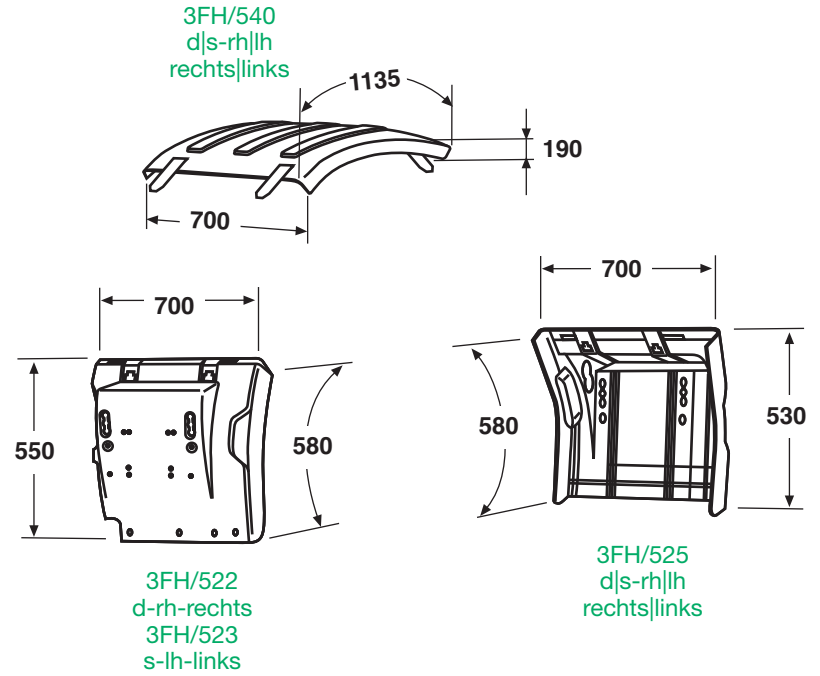
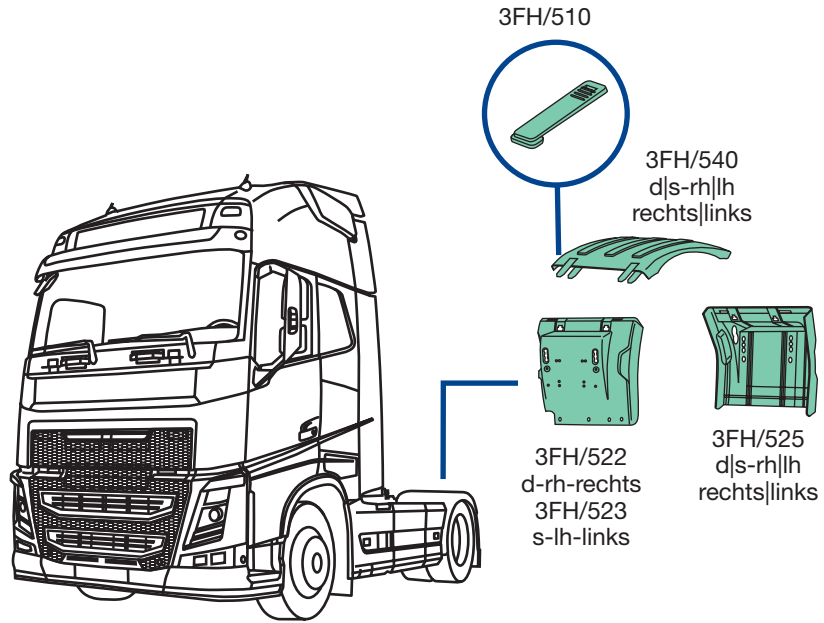

3FH/510
O.E.M. 21094457

- 3FH/540
- O.E.M. 21094390
- d|s-rh|lh-rechts|links
- grigio, semipiatta, con 4 cinghetti
- grey, semi-flat, with 4 stretchers
- grau, halbfach, mit 4 Spanngummi

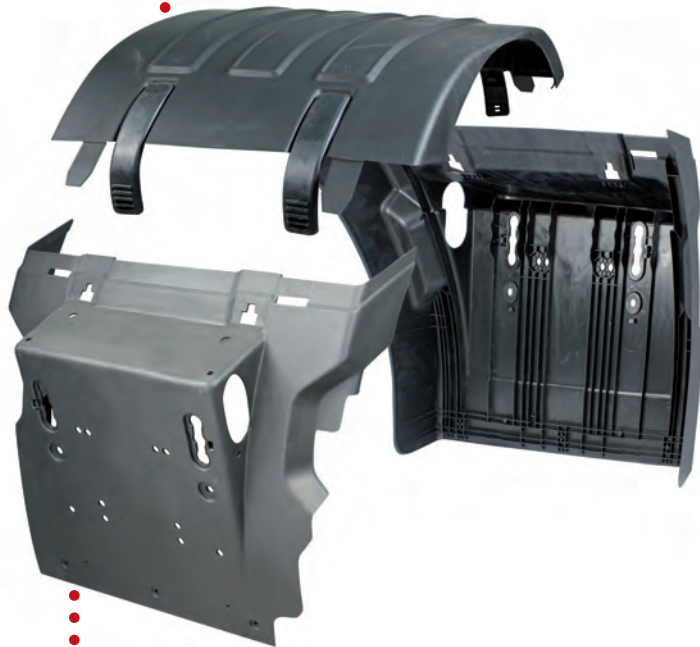

- 3FH/522
- O.E.M. 21094392
- d-rh-rechts
- grigio-grey-grau

- 3FH/525
- O.E.M. 21094394
- d|s-rh|lh-rechts|links
- grigio, senza anti-spray
- grey, without anti-spray
- grau, ohne Spritzschutz



vista esterna - external view
Außenansicht

3FH/540



3FH/525

- 3FH/523
- O.E.M. 21094393
- s-lh-links
- grigio-grey-grau

FH Euro 6

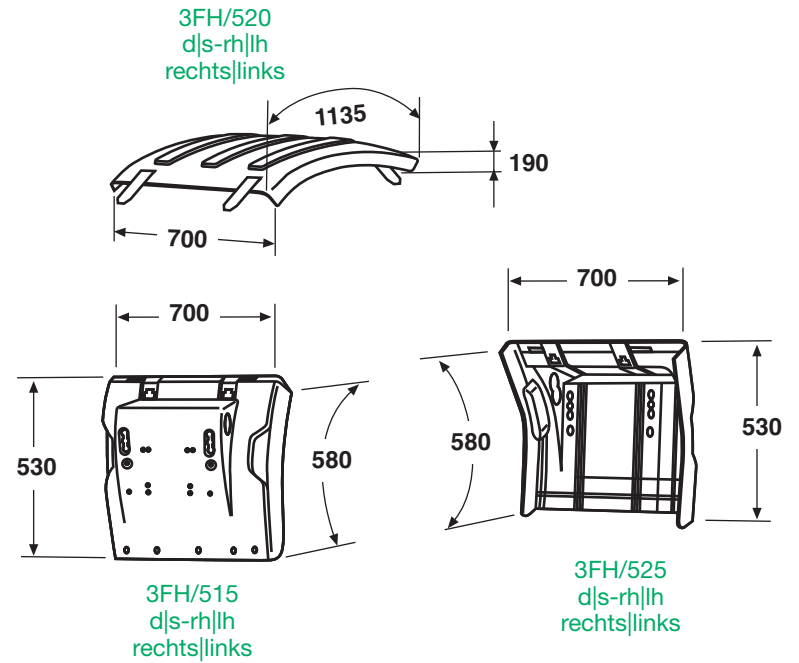
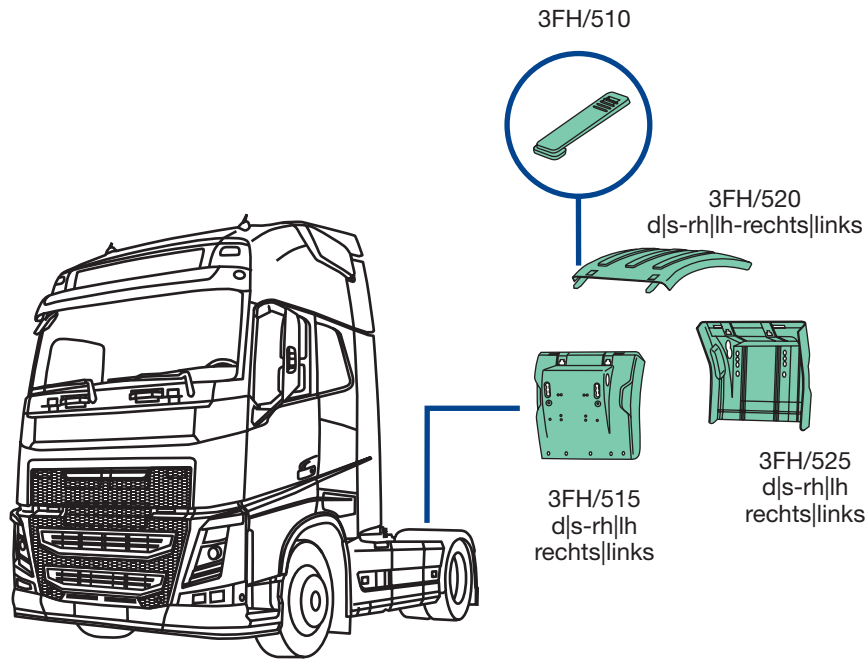

3FH/510
O.E.M. 21094457

- 3FH/520
- O.E.M. 21094388
- d|s-rh|lh-rechts|links
- grigio, semipiatta, con 4 cinghietti
- grey, semi-flat, with 4 stretchers
- grau, halbflach, mit 4 Spanngummi



3FH/515
O.E.M. 21094391
d|s-rh|lh-rechts|links
grigio-grey-grau

3FH/525
O.E.M. 21094394
d|s-rh|lh-rechts|links
grigio, senza anti-spray
grey, without anti-spray
grau, ohne Spritzschutz



vista esterna - external view
Außenansicht

FH Euro 6

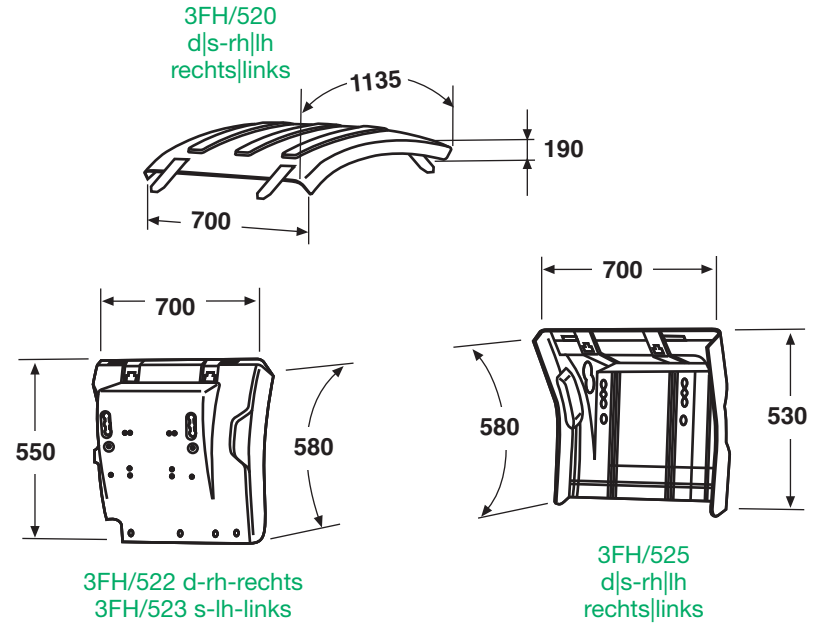
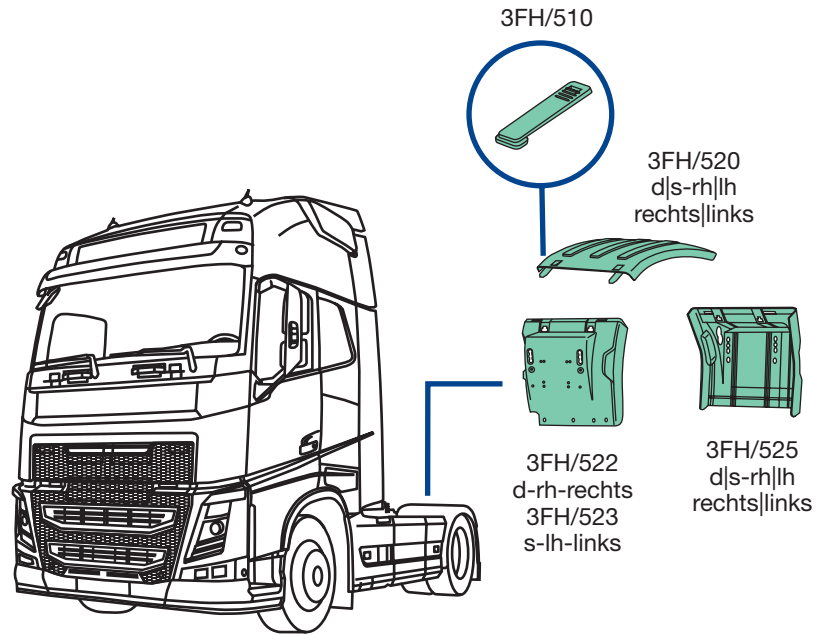

3FH/510
O.E.M. 21094457

- 3FH/520
- O.E.M. 21094388
- d|s-rh|lh-rechts|links
- grigio, semipiatta, con 4 cinghietti
- grey, semi-flat, with 4 stretchers
- grau, halbflach, mit 4 Spanngummi



- 3FH/522
- O.E.M. 21094392
- d-rh-rechts
- grigio-grey-grau

- 3FH/525
- O.E.M. 21094394
- d|s-rh|lh-rechts|links
- grigio, senza anti-spray
- grey, without anti-spray
- grau, ohne Spritzschutz



vista esterna - external view
Außenansicht

3FH/520



3FH/525

- 3FH/523
- O.E.M. 21094393
- s-lh-links
- grigio-grey-grau

applicabile a I suitable to I verwendbar für:

FH Euro 6

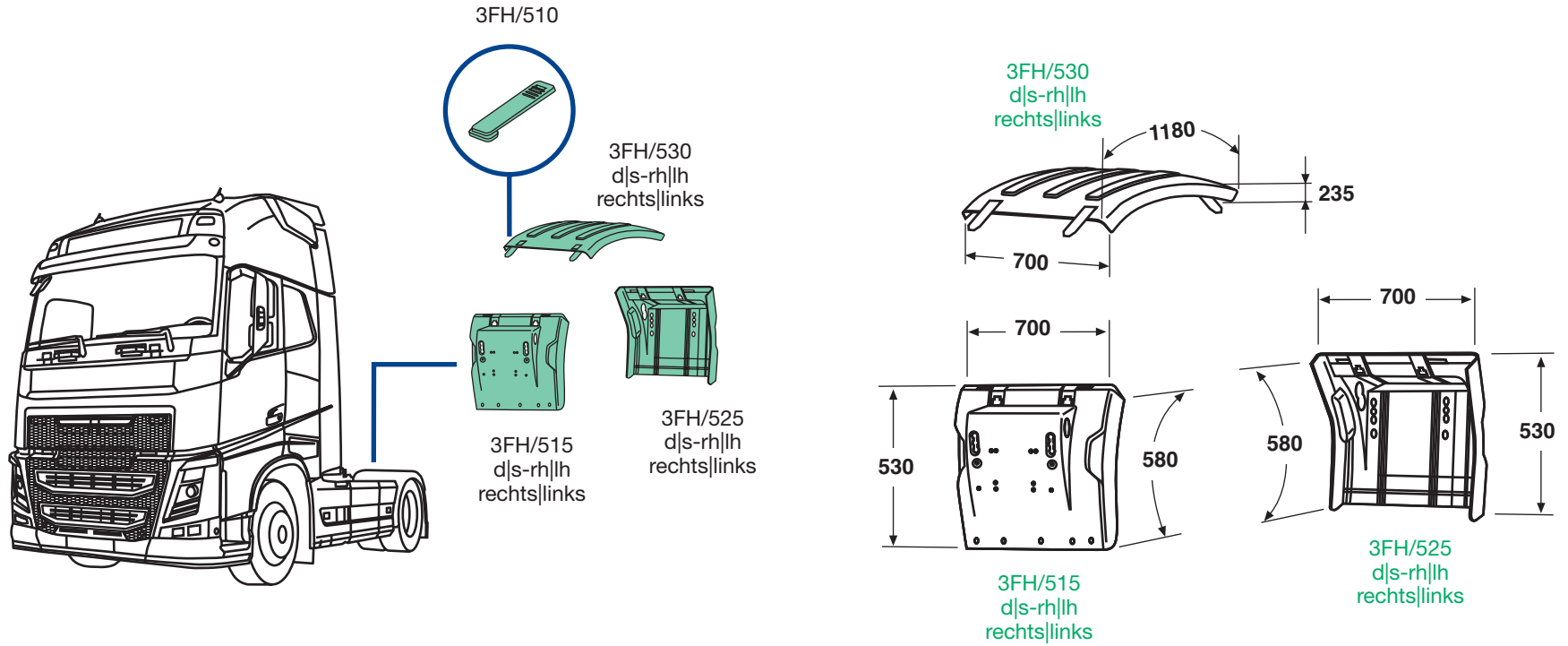

3FH/510
O.E.M. 21094457

- 3FH/530
- O.E.M. 21094383
- d|s-rh|lh-rechts|links
- grigio, circolare, senza cinghietti
- grey, circular, without stretchers
- grau, kreisförmig, ohne Spanngummi



3FH/515
O.E.M. 21094391
d|s-rh|lh-rechts|links
grigio-grey-grau

3FH/525
O.E.M. 21094394
d|s-rh|lh-rechts|links
grigio, senza anti-spray
grey, without anti-spray
grau, ohne Spritzschutz



vista esterna - external view
Außenansicht

FH Euro 6

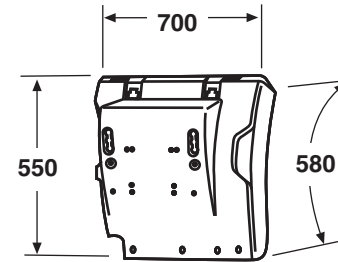
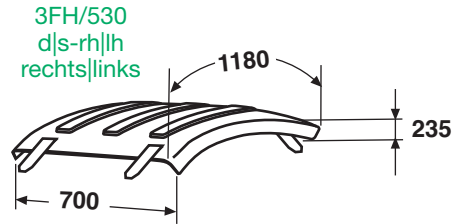
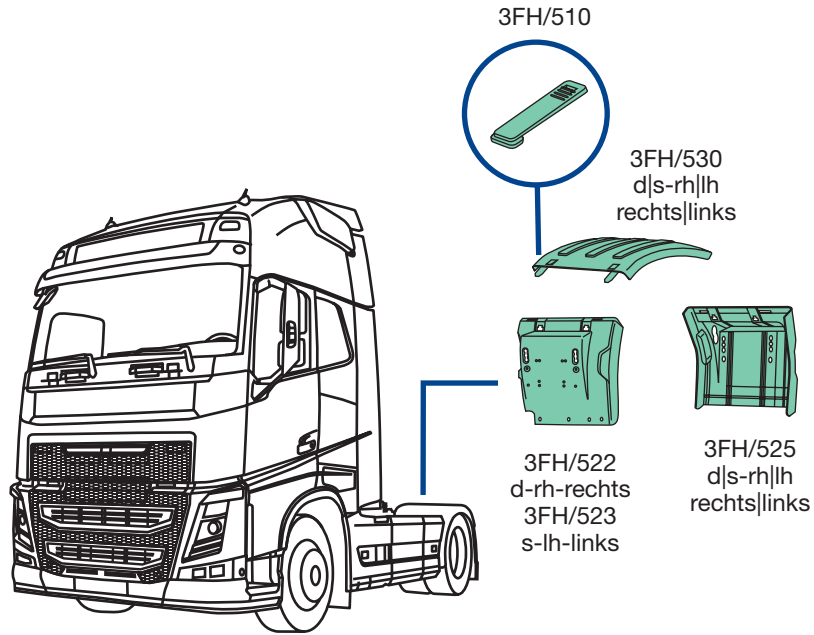

3FH/522 d-rh-rechts
3FH/523 s-lh-links

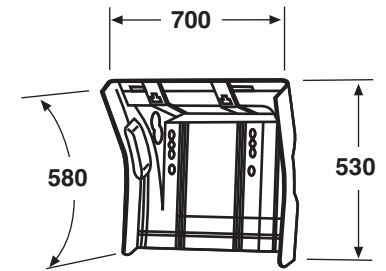

3FH/525
d|s-rh|lh
rechts|links



3FH/510
O.E.M. 21094457

- 3FH/530
- O.E.M. 21094387
- d|s-rh|lh-rechts|links
- grigio, circolare, senza cinghietti
- grey, circular, without stretchers
- grau, kreisförmig, ohne Spanngummi



- 3FH/522
- O.E.M. 21094392
- d-rh-rechts
- grigio-grey-grau

- 3FH/525
- O.E.M. 21094394
- d|s-rh|lh-rechts|links
- grigio, senza anti-spray
- grey, without anti-spray
- grau, ohne Spritzschutz



vista esterna - external view
Außenansicht

3FH/530



- 3FH/523
- O.E.M. 21094393
- s-lh-links
- grigio-grey-grau

3FH/525

applicabile a I suitable to I verwendbar für:

FH Euro 6

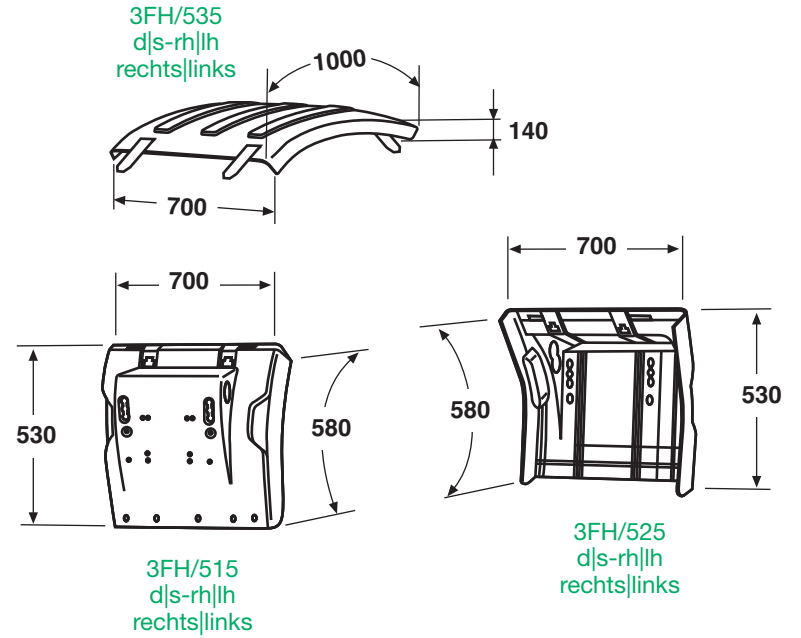
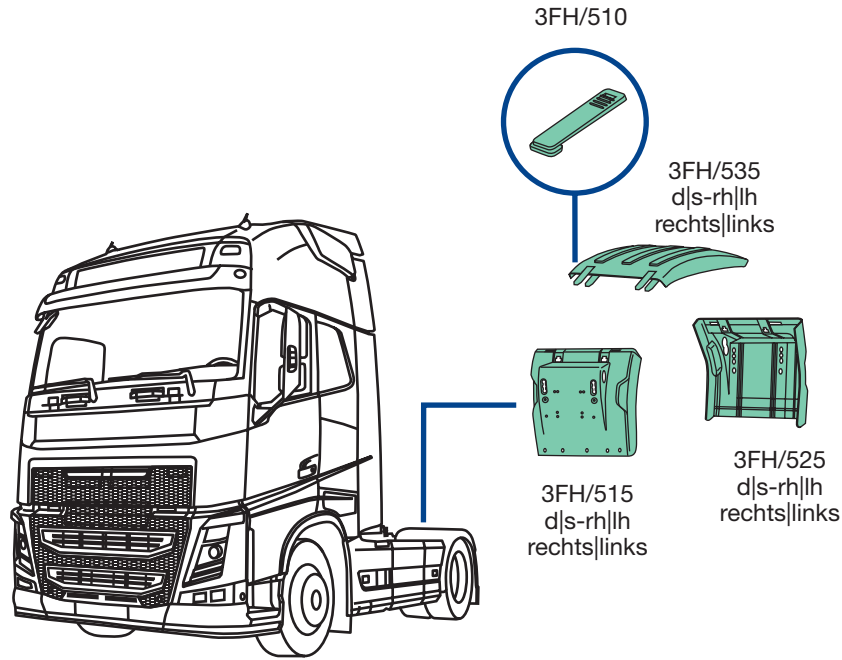

3FH/510
O.E.M. 21094457

- 3FH/535
- O.E.M. 21094389
- d|s-rh|lh-rechts|links
- grigio, piatta, con 4 cinghietti
- grey, flat, with 4 stretchers
- grau, flach, mit 4 Spanngummi

3FH/515
 O.E.M. 21094391
 d|s-rh|lh-rechts|links
 grigio-grey-grau



3FH/525
 O.E.M. 21094394
 d|s-rh|lh-rechts|links
 grigio, senza anti-spray
 grey, without anti-spray
 grau, ohne Spritzschutz



vista esterna - external view
 Außenansicht

FH Euro 6

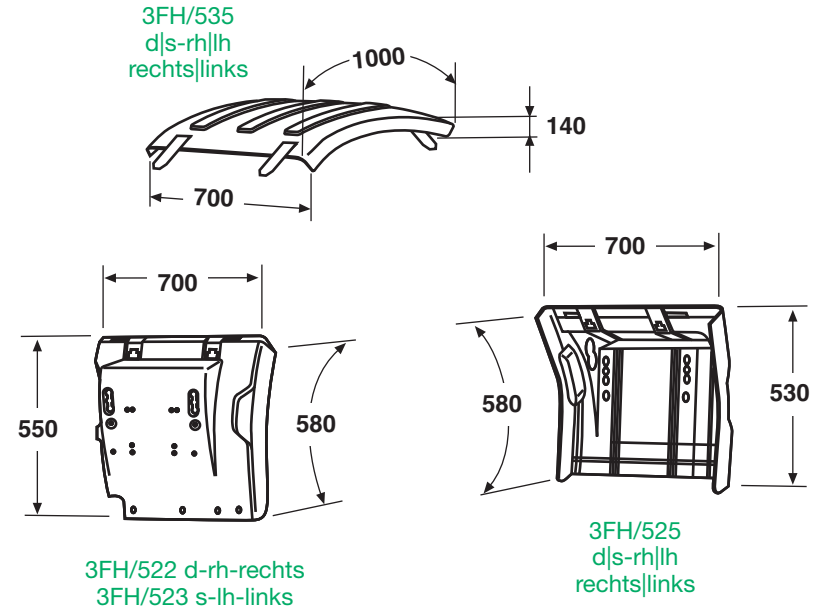
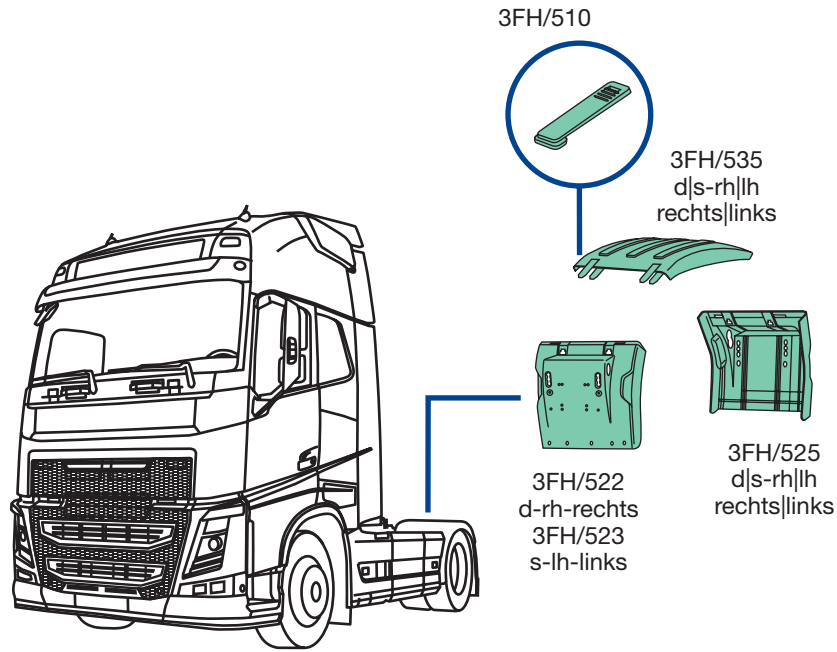

3FH/510
O.E.M. 21094457

- 3FH/535
- O.E.M. 21094389
- d|s-rh|lh-rechts|links
- grigio, piatta, con 4 cinghietti
- grey, flat, with 4 stretchers
- grau, flach, mit 4 Spanngummi

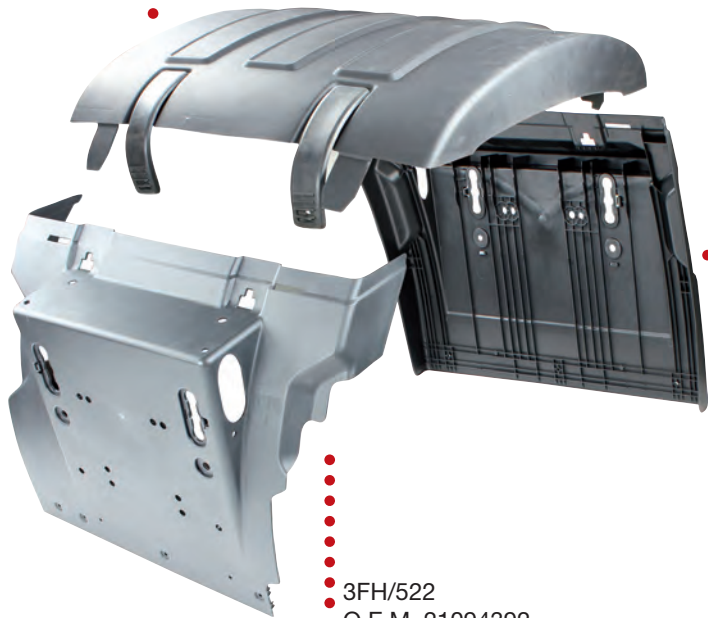

- 3FH/522
- O.E.M. 21094392
- d-rh-rechts
- grigio-grey-grau

- 3FH/525
- O.E.M. 21094394
- d|s-rh|lh-rechts|links
- grigio, senza anti-spray
- grey, without anti-spray
- grau, ohne Spritzschutz



vista esterna - external view
Außenansicht

3FH/535



3FH/525

- 3FH/523
- O.E.M. 21094393
- s-lh-links
- grigio-grey-grau

applicabile a I suitable to I verwendbar für:

FH Euro 6

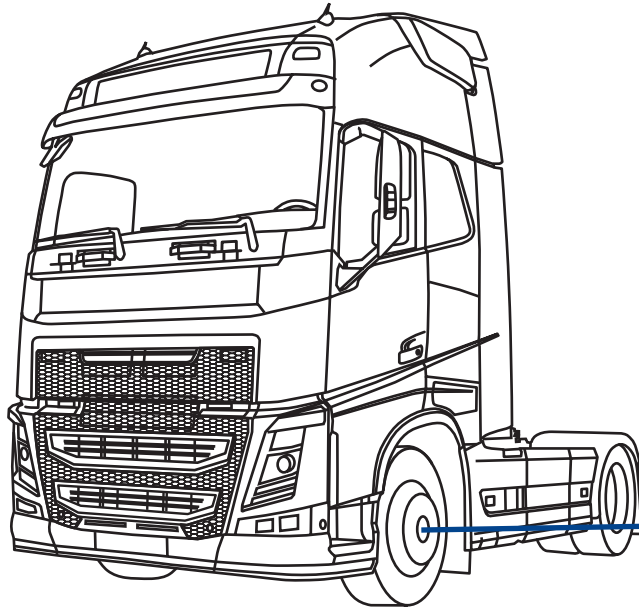

930/033

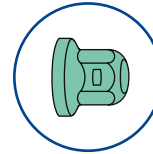

930/100
d-rh-rechts
930/101
s-lh-links

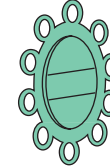

930/001
d-rh-rechts
930/002
s-lh-links

930/200
d|s-rh|lh
rechts|links



930/033
O.E.M. -



930/001
O.E.M. -
930/002
O.E.M. -



930/100
O.E.M. -
930/101
O.E.M. -



930/200
O.E.M. -

930/033-Tappo copri Bullone-Bolt cover-Radmutterkappen

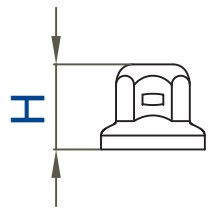

H	45 mm
Per bulloni \varnothing - bolt \varnothing	33 mm
Schlüsselweite \varnothing	
Colore	cromato-chrome-verchromt
Colours-Farbe	
Materiale-Material	acciaio inox-stainless steel Edelstahl
Kg	0,025

930/001 d-rh-rechts | 930/002 s-lh-links

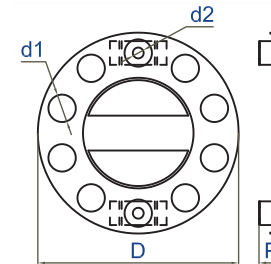

D \varnothing 425 mm	P 50 mm
d1 nr. 10	d1 \varnothing 58 mm
d2 nr. 2	d2 \varnothing 23 mm
Ventilata	si-yes-Ja
Ventilated-Belüftet	
Colore	cromato e nero-chrome and black
Colours-Farbe	verchromt und schwarz
Materiale-Material	acciaio inox e plastica stainless steel and plastic Edelstahl und Kunststoff
Kg	1,230

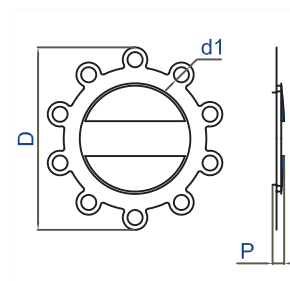

930/100 d-rh-rechts | 930/101 s-lh-links

D \varnothing 387 mm	P 30 mm
d1 nr. 10	d1 \varnothing 32 mm
Ventilata	si-yes-Ja
Ventilated-Belüftet	
Colore	cromato e nero-chrome and black
Colours-Farbe	verchromt und schwarz
Materiale-Material	acciaio inox e plastica stainless steel and plastic Edelstahl und Kunststoff
Kg	0,655

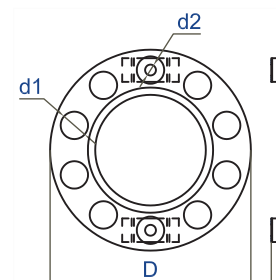

930/200 d|s-rh|lh-rechts+links

D \varnothing 425 mm	P 40 mm
d1 nr. 10	d1 \varnothing 58 mm
d2 nr. 2	d2 \varnothing 23 mm
Ventilata	no-nein
Ventilated-Belüftet	
Colore	cromato-chrome-verchromt
Colours-Farbe	
Materiale-Material	acciaio inox-stainless steel Edelstahl
Kg	1,155

applicabile a | suitable to | verwendbar für:

FH Euro 6

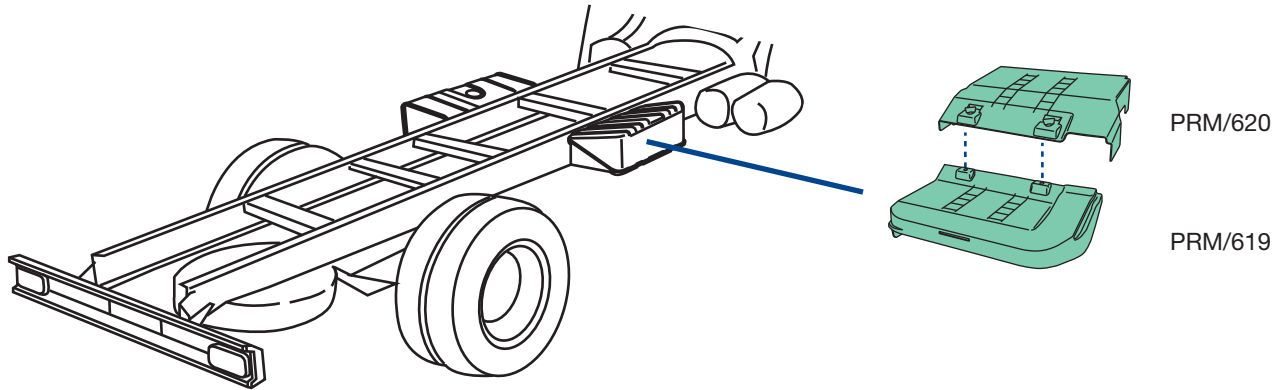

PRM/619
O.E.M. 21924924



PRM/620
O.E.M. 21924923



applicabile a | suitable to | verwendbar für

123

3FH
FH13

TERZA SERIE (2008) | THIRD SERIES (2008) | DRITTE SERIE (2008)



IT Officina di riparazione
EN Workshop
DE Werkstatt

FH13 TERZA SERIE (2008) | THIRD SERIES (2008) | DRITTE SERIE (2008)

(*) Cava-Cantiere
Yard & Quarry
Baustellenfahrzeug

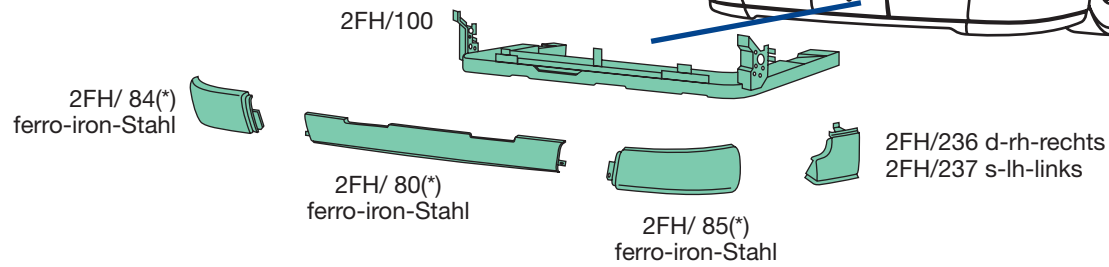

2FH/ 80
O.E.M. 21828914



2FH/ 84
O.E.M. 21829052
2FH/ 85
O.E.M. 21829051



2FH/100
O.E.M. 21484901

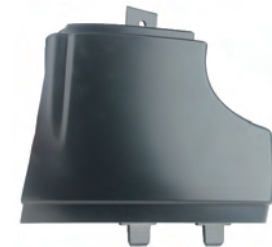

2FH/236
O.E.M. 20453677
2FH/237
O.E.M. 20453676

applicabile a | suitable to | verwendbar für:

FH13 TERZA SERIE (2008) | THIRD SERIES (2008) | DRITTE SERIE (2008)

(*) grezzo-unprocessed-roh

(°) verniciato grigio scuro
dark grey painted
dunkel grau strukturlackiert

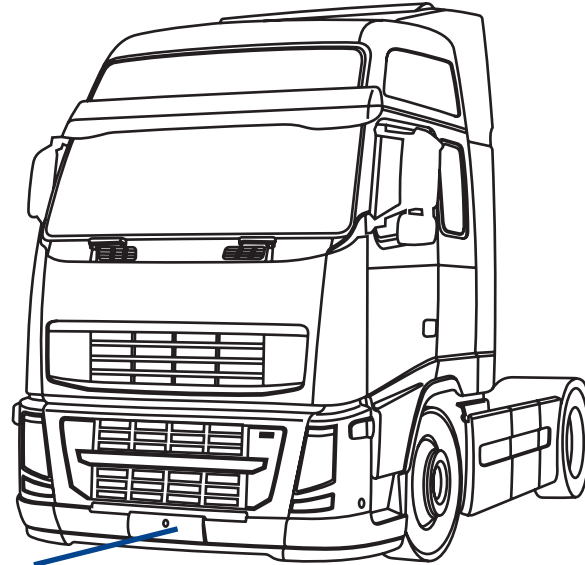

2FH/ 92(*)
plastica-plastic-Kunststoff
2FH/ 96(°)
plastica-plastic-Kunststoff

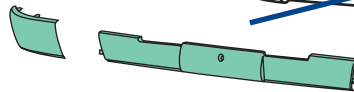

2FH/ 90(*)
plastica-plastic-Kunststoff
2FH/ 89(°)
plastica-plastic-Kunststoff

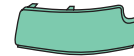

2FH/ 93(*)
plastica-plastic-Kunststoff
2FH/ 97(°)
plastica-plastic-Kunststoff



2FH/ 89
O.E.M. 20529740



2FH/ 90
O.E.M. 21359080



2FH/ 92
O.E.M. 21359090
2FH/ 93
O.E.M. 21359082



2FH/ 96
O.E.M. 20529742
2FH/ 97
O.E.M. 20529741

FH13 TERZA SERIE (2008) | THIRD SERIES (2008) | DRITTE SERIE (2008)

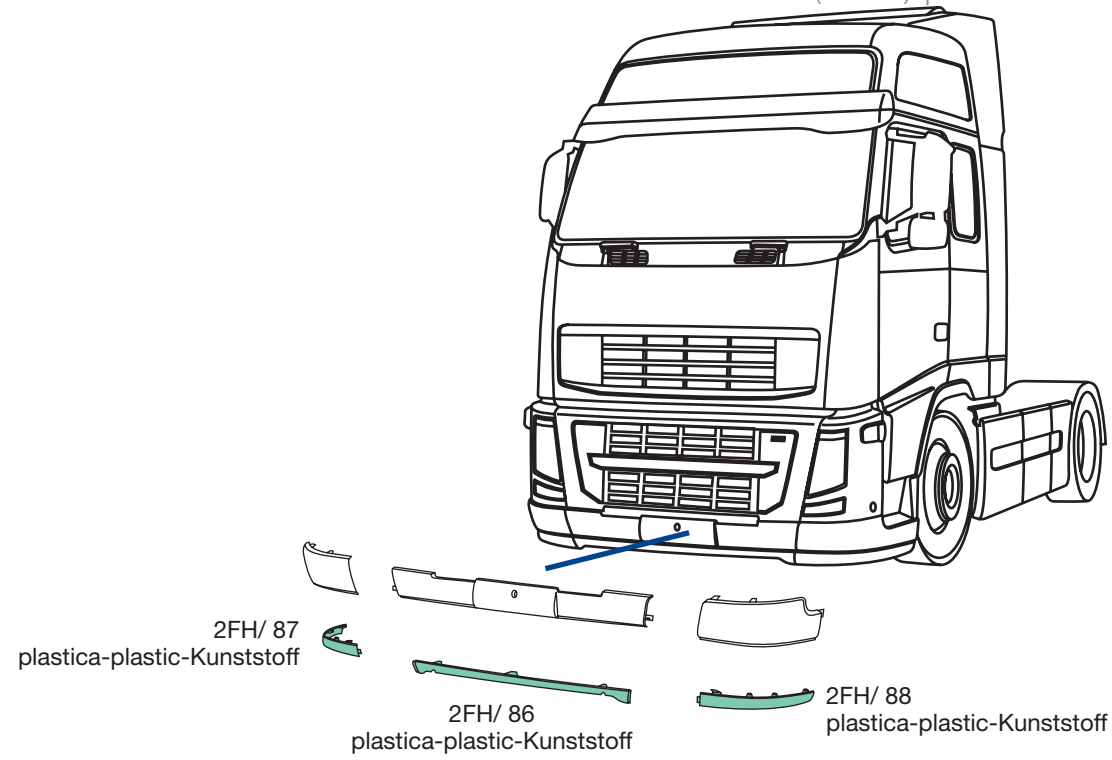

2FH/ 86
O.E.M. 21430599



2FH/ 87
O.E.M. 21430672
2FH/ 88
O.E.M. 21430600

applicabile a I suitable to I verwendbar für:

FH13 TERZA SERIE (2008) | THIRD SERIES (2008) | DRITTE SERIE (2008)

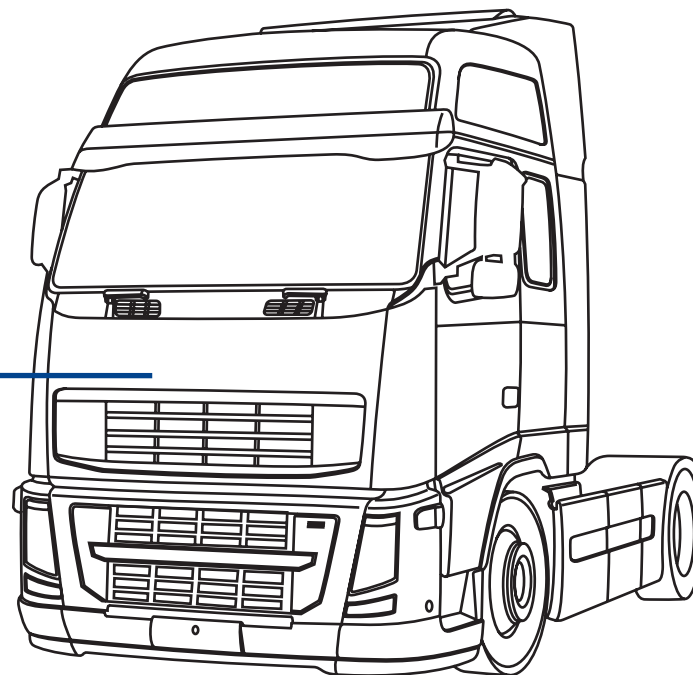
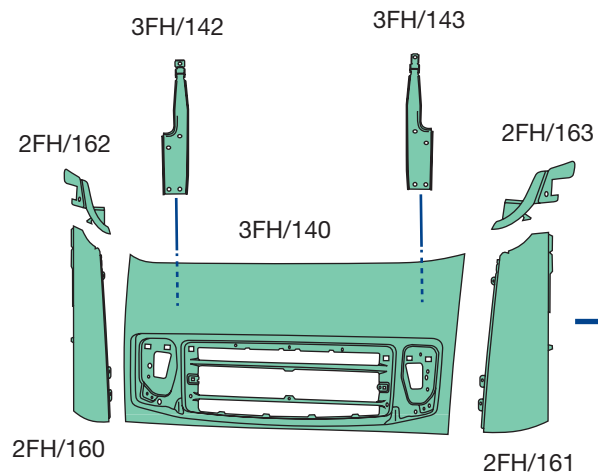

3FH/140
O.E.M. 21190825



3FH/142
O.E.M. 82215401
3FH/143
O.E.M. 82215391



2FH/160
O.E.M. 20379176
2FH/161
O.E.M. 20379175



2FH/162
O.E.M. 20529672
2FH/163
O.E.M. 20529668

FH13 TERZA SERIE (2008) | THIRD SERIES (2008) | DRITTE SERIE (2008)

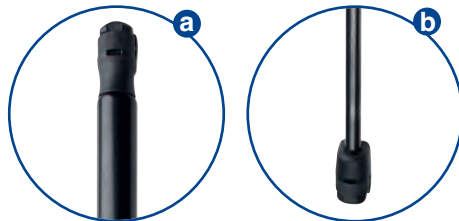
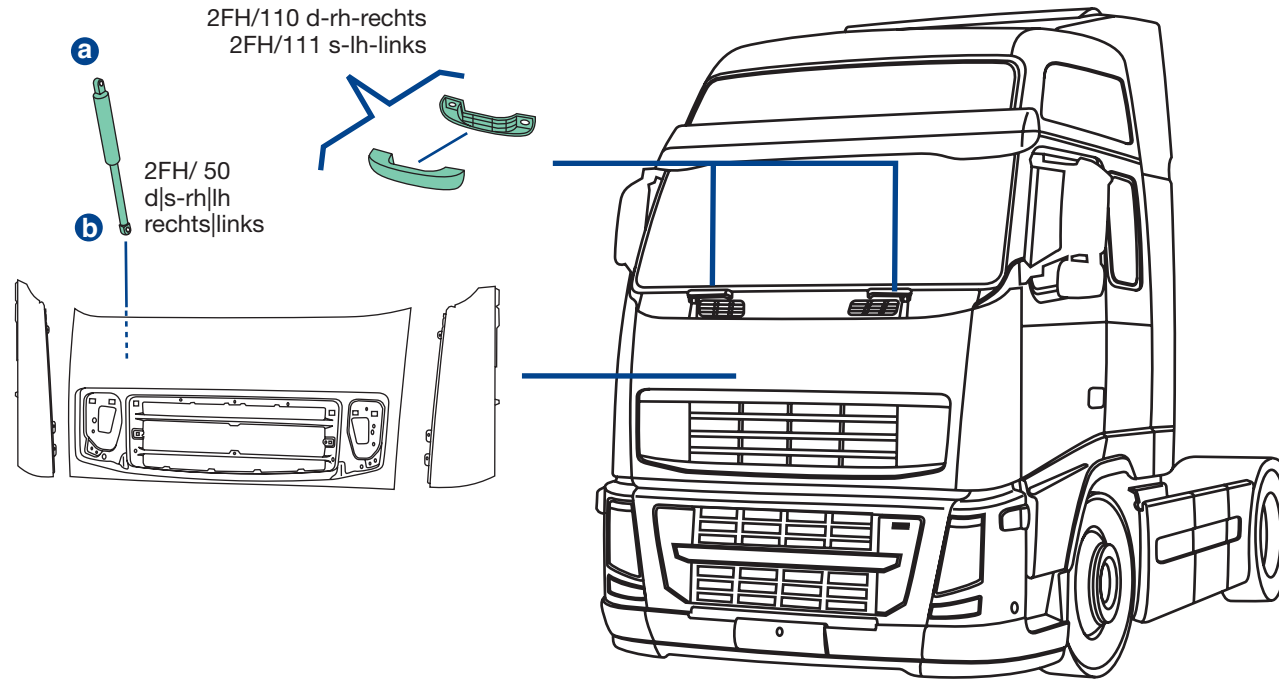

2FH/ 50
O.E.M. 20379348



2FH/110
O.E.M. 3175367+3175366
2FH/111
O.E.M. 20383543+3175366

applicabile a I suitable to I verwendbar für:

FH13 TERZA SERIE (2008) | THIRD SERIES (2008) | DRITTE SERIE (2008)

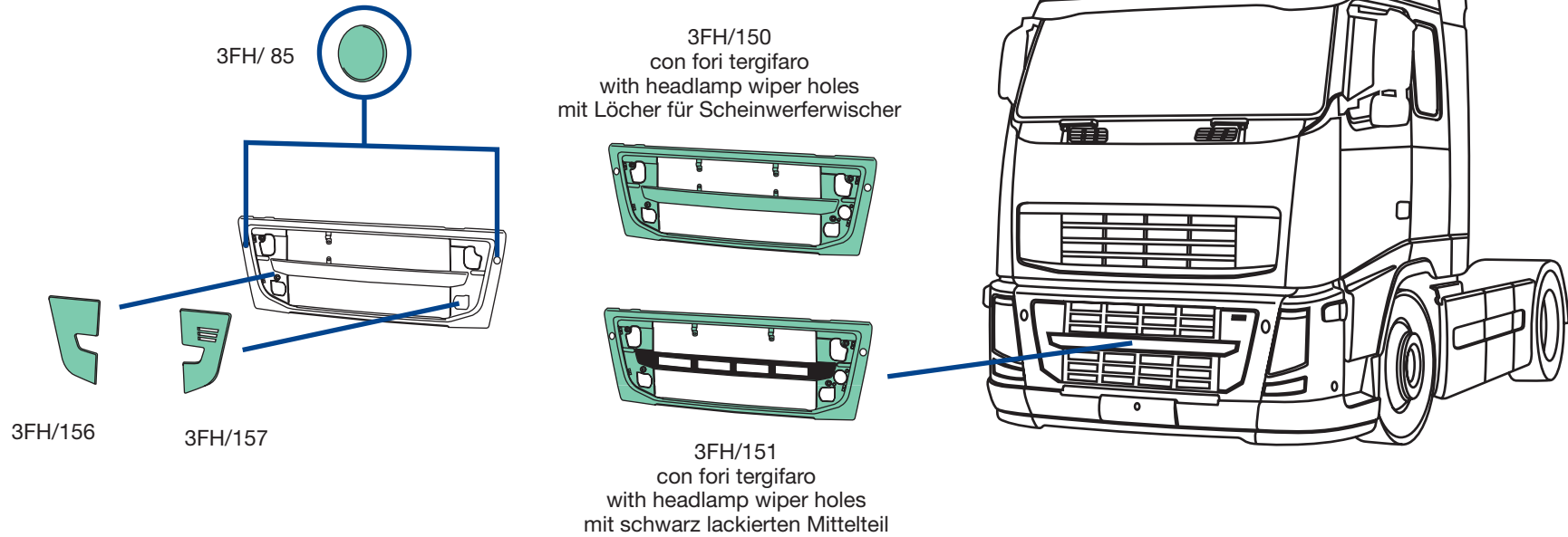

3FH/ 85
O.E.M. 21425186



3FH/150
O.E.M. 21445302



3FH/151
O.E.M. 21445754



3FH/156
O.E.M. 82063911



3FH/157
O.E.M. 82062209

FH13 TERZA SERIE (2008) | THIRD SERIES (2008) | DRITTE SERIE (2008)

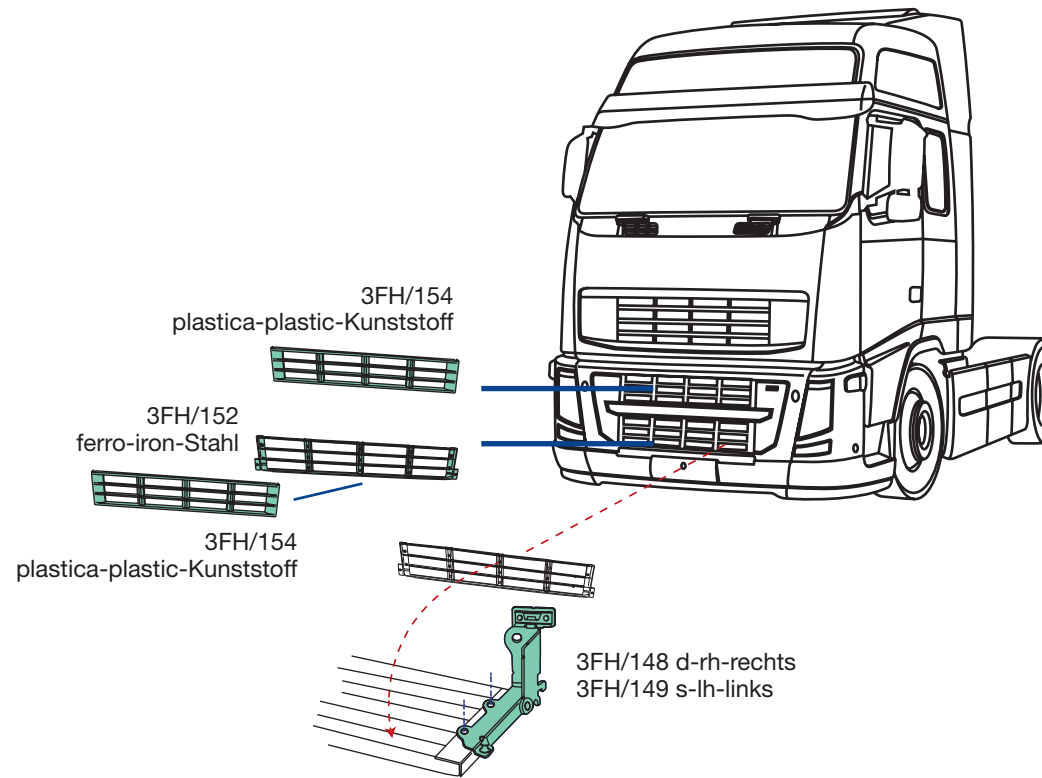

3FH/148
O.E.M. 82060445
3FH/149
O.E.M. 82060441



3FH/152
O.E.M. 82072463



3FH/154
O.E.M. 82063513

applicabile a l suitable to l verwendbar für:

FH13 TERZA SERIE (2008) | THIRD SERIES (2008) | DRITTE SERIE (2008)

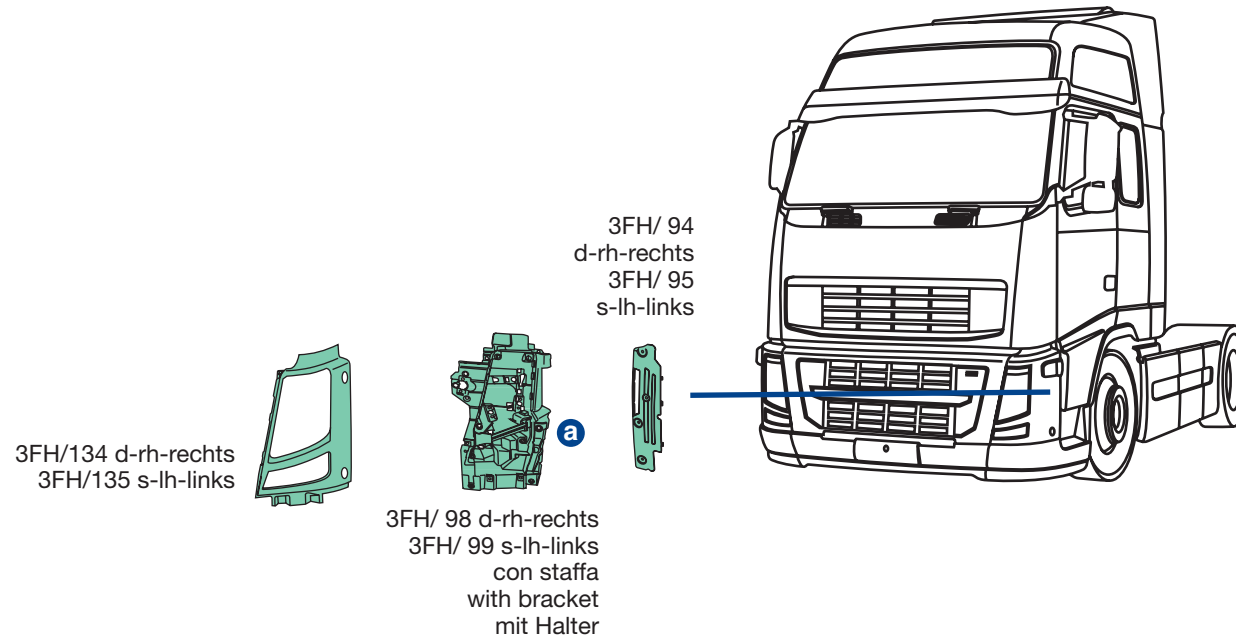

3FH/ 94
O.E.M. 21451002
3FH/ 95
O.E.M. 21451000



3FH/ 98
O.E.M. 82209849
3FH/ 99
O.E.M. 82367098

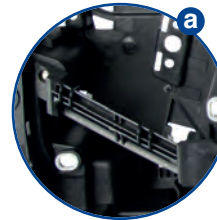

3FH/134
O.E.M. 21478755
3FH/135
O.E.M. 21478759



FH13 TERZA SERIE (2008) | THIRD SERIES (2008) | DRITTE SERIE (2008)

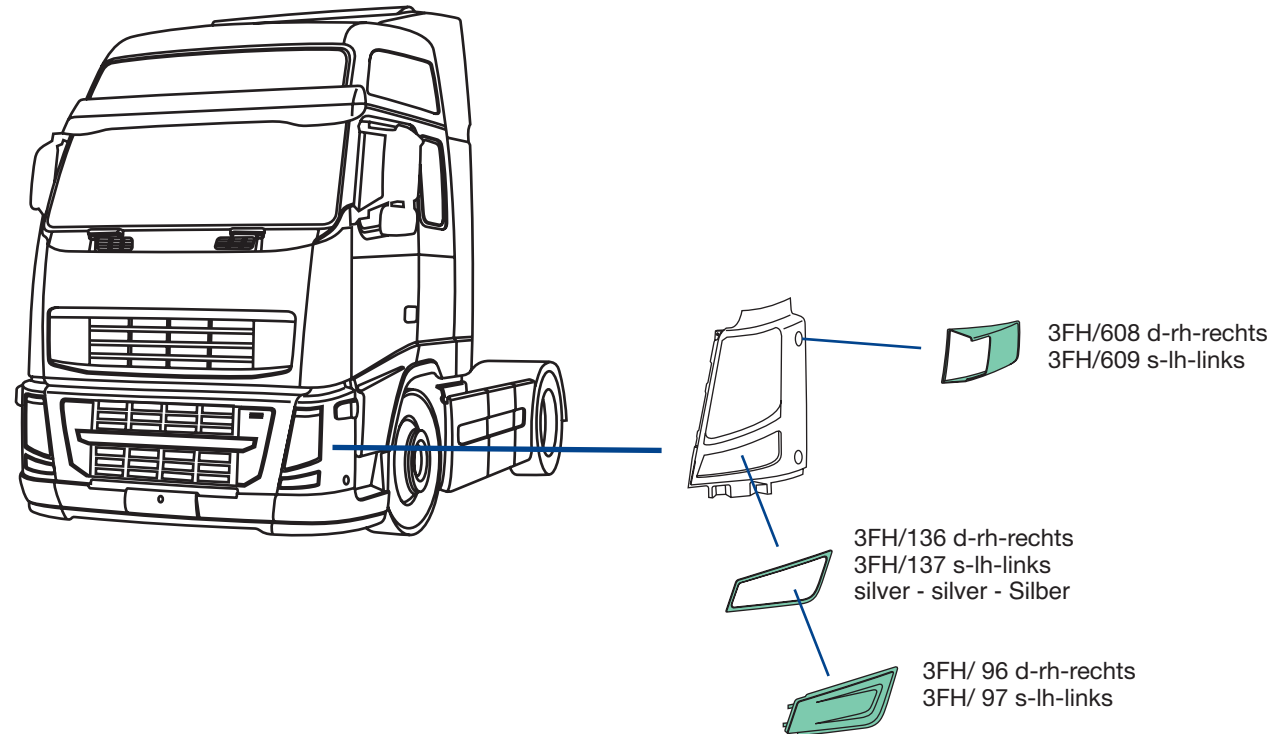

3FH/ 96
O.E.M. 82066335
3FH/ 97
O.E.M. 82066238



3FH/136
O.E.M. 21078545
3FH/137
O.E.M. 21078543



3FH/608
O.E.M. 21478751
3FH/609
O.E.M. 21448885

applicabile a l suitable to l verwendbar für:

FH13 TERZA SERIE (2008) | THIRD SERIES (2008) | DRITTE SERIE (2008)

0FH/190

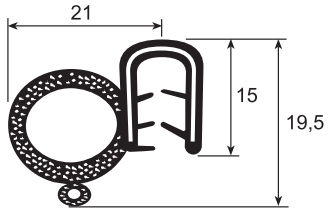

2FH/ 6 d-rh-rechts
2FH/ 7 s-lh-links

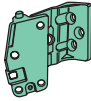

2FH/ 9
d|s-rh|lh
rechts|links

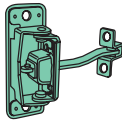

2FH/ 10
d|s-rh|lh
rechts|links

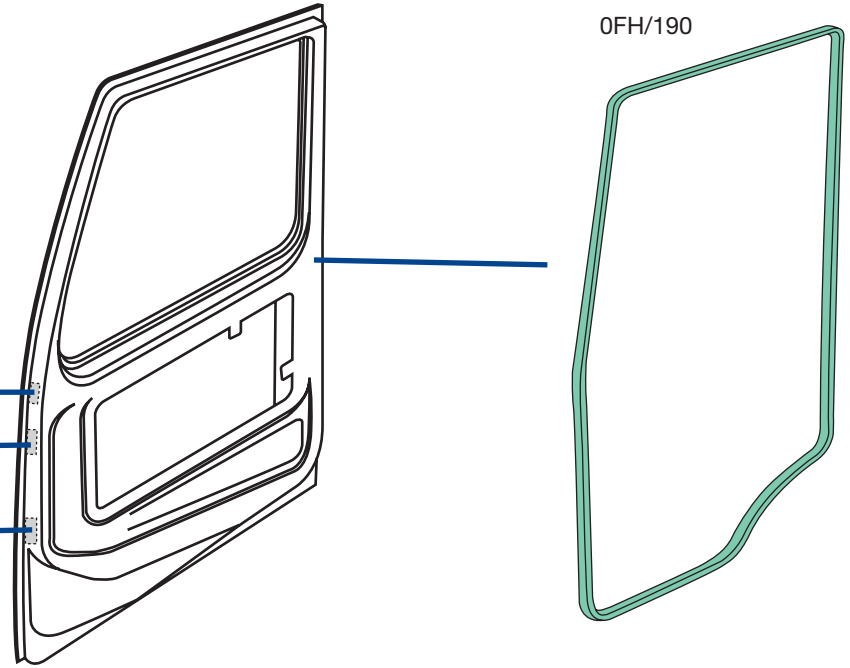
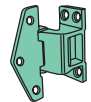

2FH/ 6
O.E.M. 20398136
2FH/ 7
O.E.M. 20398135

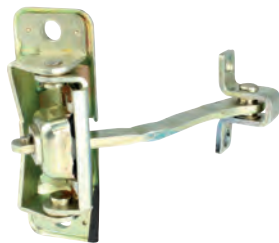

2FH/ 9
O.E.M. 1062636



2FH/ 10
O.E.M. 20372039



0FH/190
O.E.M. 3175029

FH13 TERZA SERIE (2008) | THIRD SERIES (2008) | DRITTE SERIE (2008)

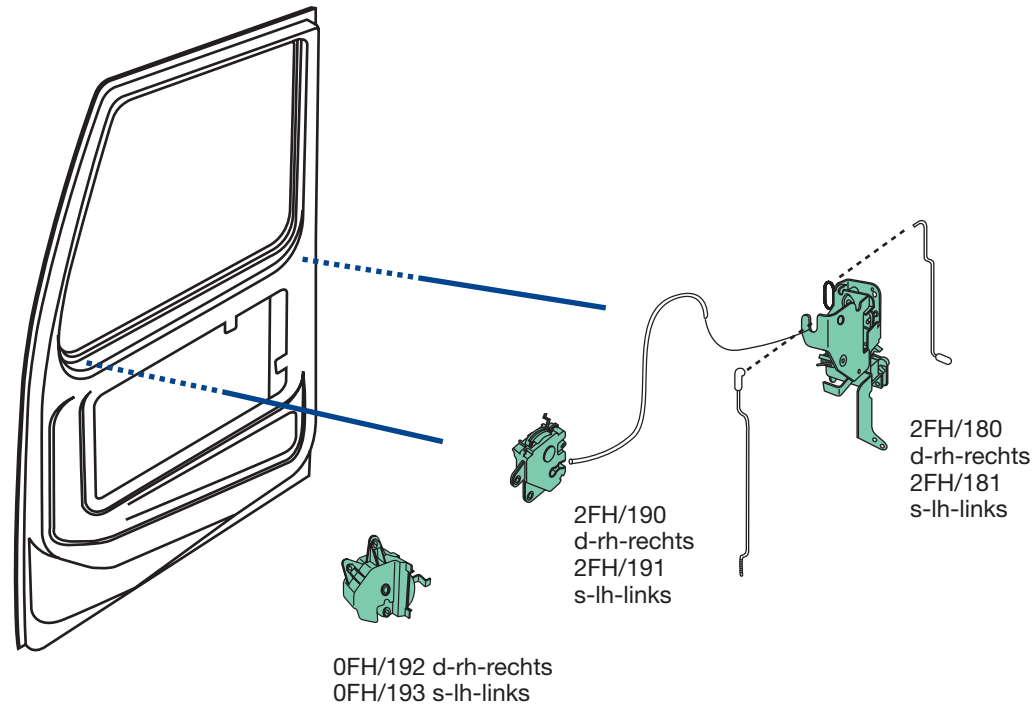

0FH/192
O.E.M. 1063328
0FH/193
O.E.M. 1063327



2FH/180
O.E.M. 21505894
2FH/181
O.E.M. 21505893



2FH/190
O.E.M. 20570722
2FH/191
O.E.M. 20570721

FH13 TERZA SERIE (2008) | THIRD SERIES (2008) | DRITTE SERIE (2008)

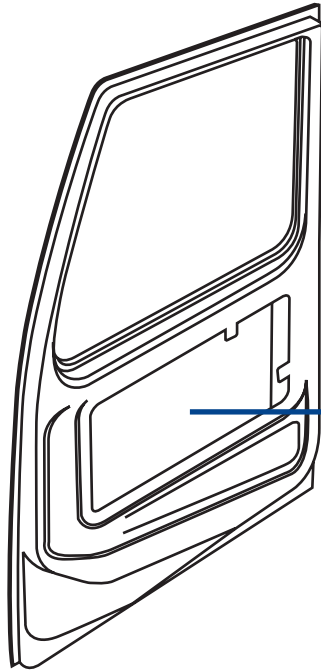

0FM/170
d|s-rh|lh
rechts|links

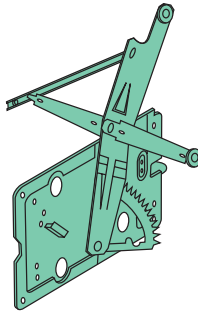

0FM/174 d-rh-rechts
0FM/175 s-lh-links
elettrico, senza motorino
electric, without motor
elektrisch, ohne Motor

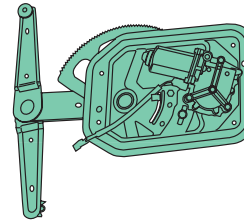

0FH/164 d-rh-rechts
0FH/165 s-lh-links
elettrico, con motorino
electric, with motor
elektrisch, mit Motor

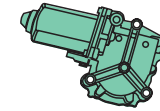

0FH/168 d-rh-rechts
0FH/169 s-lh-links

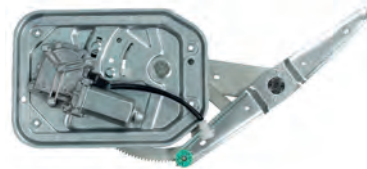

IN ALLESTIMENTO::NOT AVAILABLE YET::IN ARBEIT



IN ALLESTIMENTO::NOT AVAILABLE YET::IN ARBEIT

0FM/174
O.E.M. -
0FM/175
O.E.M. -

0FH/164
O.E.M. 3176542
0FH/165
O.E.M. 3176541

0FH/168
O.E.M. 3176550
0FH/169
O.E.M. 3176549

FH13 TERZA SERIE (2008) | THIRD SERIES (2008) | DRITTE SERIE (2008)

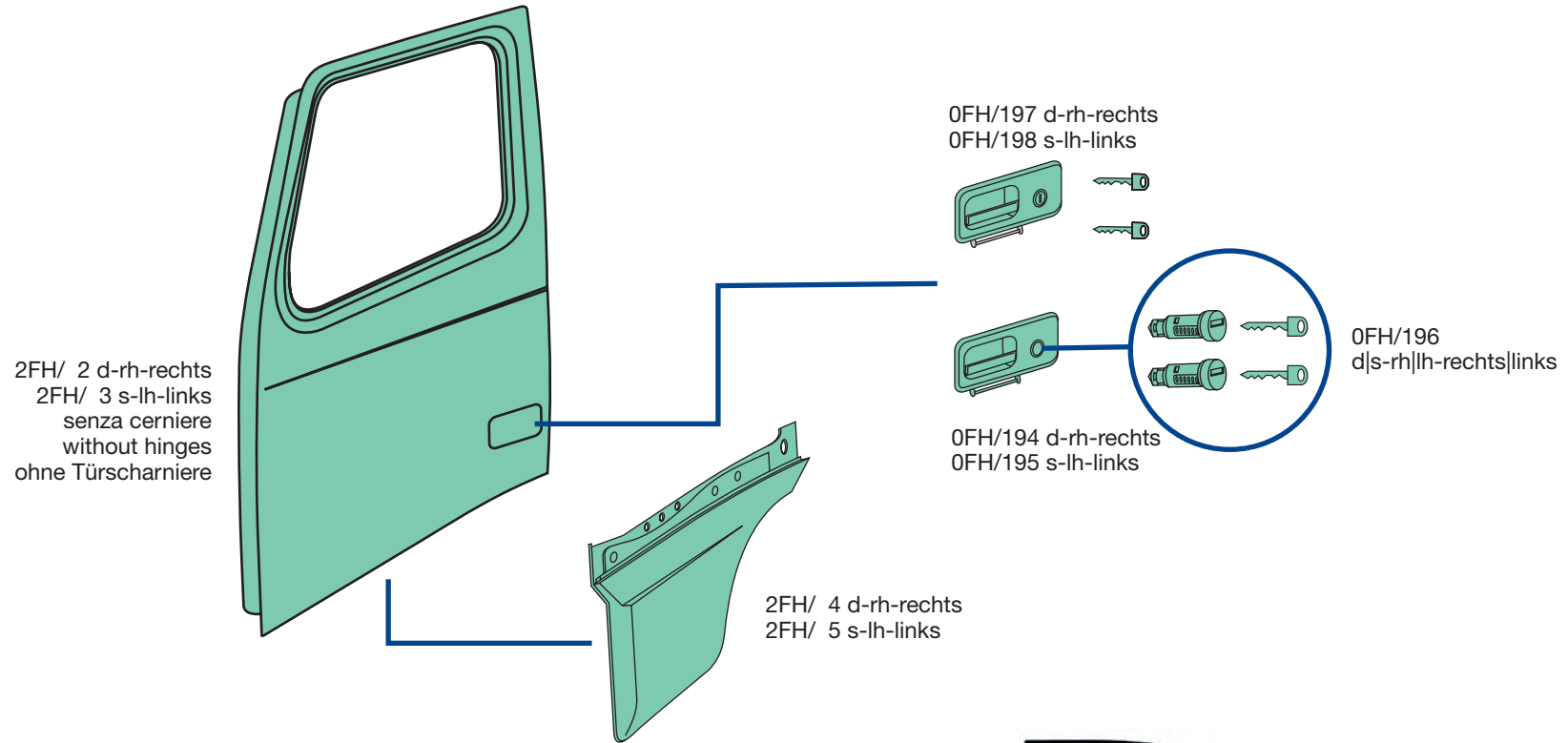

0FH/194
O.E.M. 20398467
0FH/195
O.E.M. 20398466



0FH/196
O.E.M. 3090484



0FH/197
O.E.M. -
0FH/198
O.E.M. -



2FH/ 2
O.E.M. 20360543
2FH/ 3
O.E.M. 20360542



2FH/ 4
O.E.M. 20467038
2FH/ 5
O.E.M. 20467037

applicabile a I suitable to I verwendbar für:



FH13 TERZA SERIE (2008) | THIRD SERIES (2008) | DRITTE SERIE (2008)

3FH/504

22286155



II

E4 024111

200x435 mm



IV

E4 0244639

200x185 mm

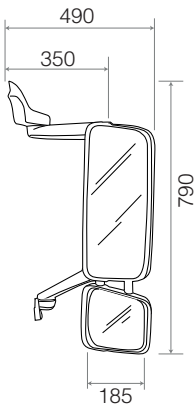

applicabilità:
applicable to:
Verwendbar für

VOLVO FH III
VOLVO FM III



COVIND

II









3FH/506

IV



240x235 mm

FH13 TERZA SERIE (2008) | THIRD SERIES (2008) | DRITTE SERIE (2008)

<p>a -</p>	<p>-</p>	
<p>b 2FH/503 II</p>	<p>21320404 (20589788)</p>	  <p>E4 024111 200x435 mm</p>
<p>c 3FH/509 IV</p>	<p>21320365 (21070768) (20589798)</p>	  <p>E4 0244639 200x185 mm</p>
<p>d 3FH/511 II</p>	<p>21169974 (20746402)</p>	  <p>187x435 mm</p>
<p>e 3FH/508 IV</p>	<p>20841436</p>	  <p>240x210 mm</p>

applicabile a I suitable to I verwendbar für:

FH13 TERZA SERIE (2008) | THIRD SERIES (2008) | DRITTE SERIE (2008)



3FH/505

22286149



II (E4) 024111
200x435 mm



IV (E4) 0244639
176x188 mm

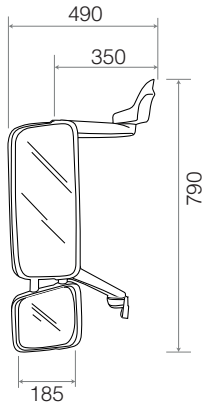

applicabilità:
applicable to:
Verwendbar für

VOLVO FH III
VOLVO FM III



COVIND

II
3FH/507

IV



240x235 mm

FH13 TERZA SERIE (2008) | THIRD SERIES (2008) | DRITTE SERIE (2008)

a	-	-								
b	2FH/503 II	21320404 (20589788)							E4 024111	200x435 mm
c	3FH/509 IV	21320365 (21070768) (20589798)							E4 0244639	185x200 mm
d	3FH/511 II	21169974 (20746402)								187x435 mm
e	3FH/508 IV	20841436								240x210 mm

applicabile a l suitable to l verwendbar für:

FH13 TERZA SERIE (2008) | THIRD SERIES (2008) | DRITTE SERIE (2008)

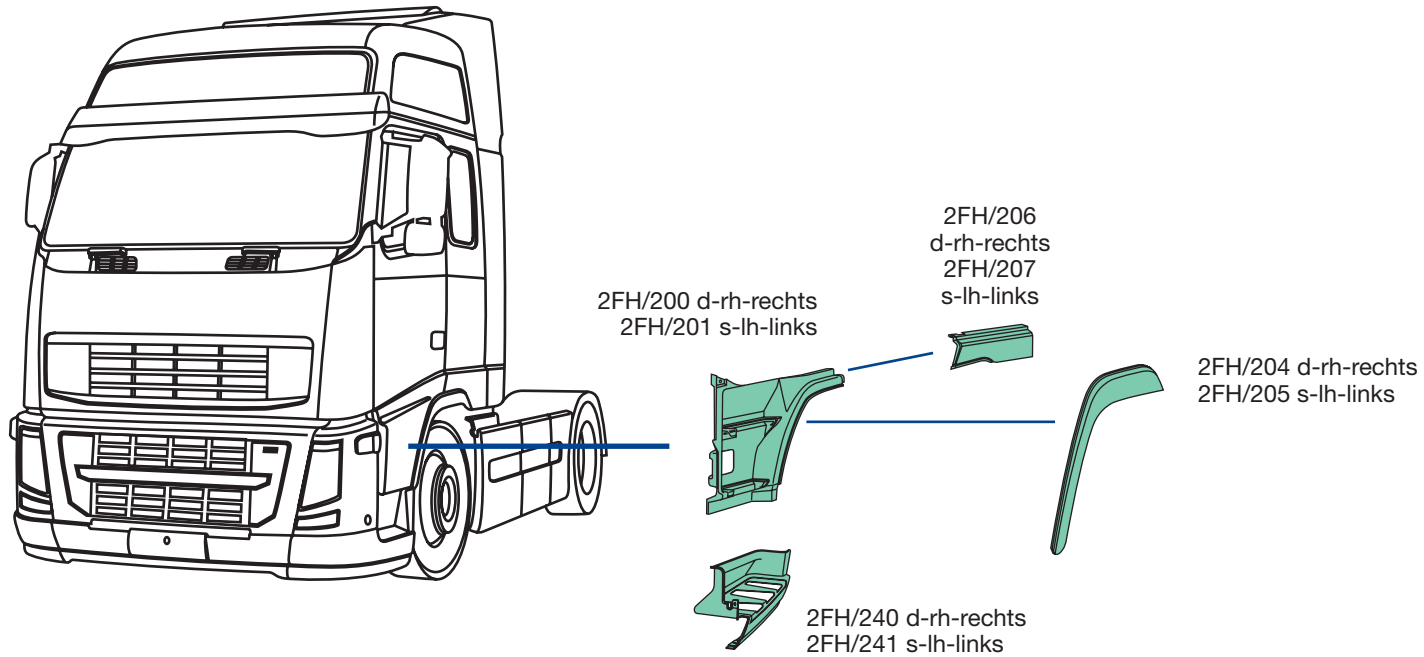

2FH/200
O.E.M. 3175928
2FH/201
O.E.M. 3175927



2FH/204
O.E.M. 20529684
2FH/205
O.E.M. 20529682



2FH/206
O.E.M. 3175930
2FH/207
O.E.M. 3175929



2FH/240
O.E.M. 20529640
2FH/241
O.E.M. 20529638

FH13 TERZA SERIE (2008) | THIRD SERIES (2008) | DRITTE SERIE (2008)

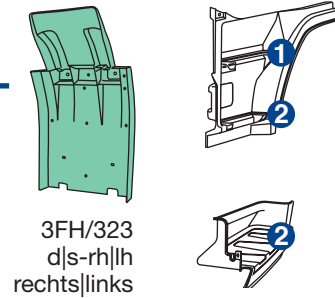
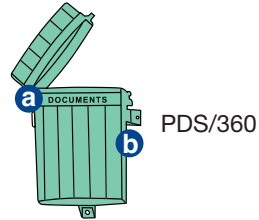
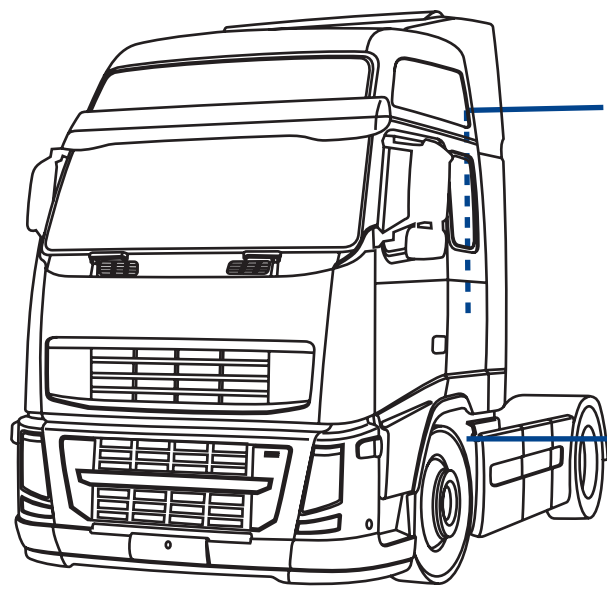

PDS/360

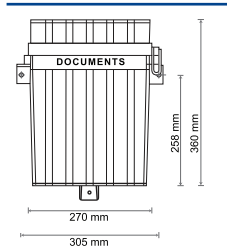

1 0FH/210
d|s-rh|lh-rechts|links

2 2FH/208 d-rh-rechts
2FH/209 s-lh-links



0FH/210
O.E.M. 20379439



2FH/208
O.E.M. 20360789
2FH/209
O.E.M. 20360788



3FH/323
O.E.M. 82637695



PDS/360
O.E.M. -

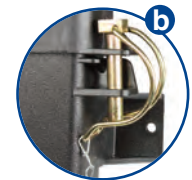

applicabile a | suitable to | verwendbar für:

FH13 TERZA SERIE (2008) | THIRD SERIES (2008) | DRITTE SERIE (2008)

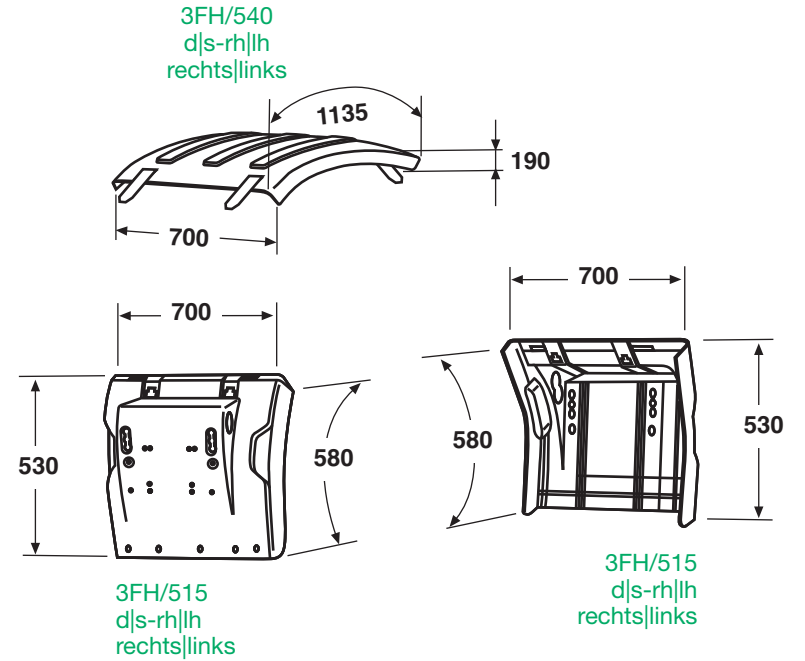
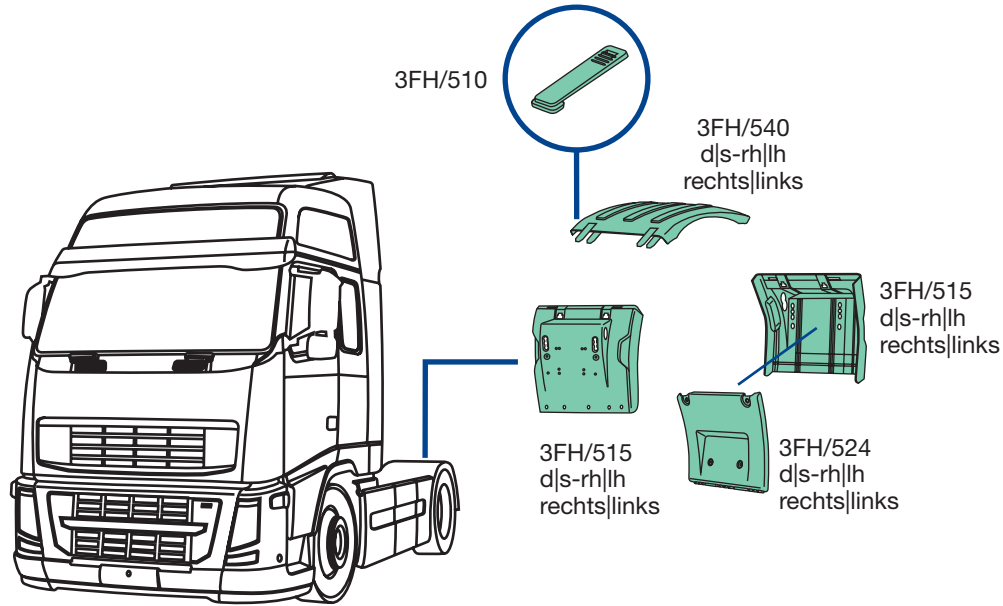

3FH/510
O.E.M. 21094457



3FH/524
O.E.M. 21094447

FH13 TERZA SERIE (2008) | THIRD SERIES (2008) | DRITTE SERIE (2008)

- 3FH/540
- O.E.M. 21094390
- d|s-rh|lh-rechts|links
- grigio, semipiatta, con 4 cinghietti
- grey, semi-flat, with 4 stretchers
- grau, halbflach, mit 4 Spanngummi
-
-



3FH/515

3FH/515
 O.E.M. 21094391
 d|s-rh|lh-rechts|links
 grigio-grey-grau



FH13 TERZA SERIE (2008) | THIRD SERIES (2008) | DRITTE SERIE (2008)

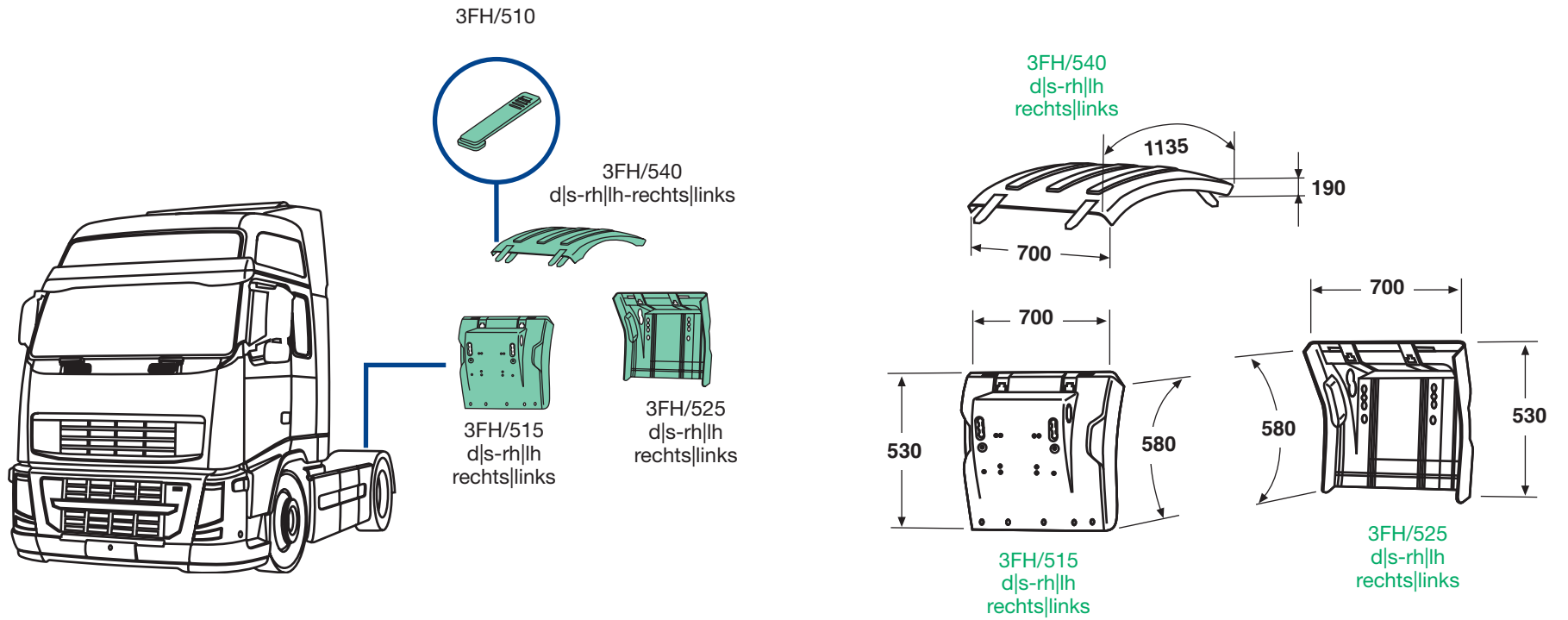

3FH/510
O.E.M. 21094457

- 3FH/540
- O.E.M. 21094390
- d|s-rh|lh-rechts|links
- grigio, semipiatta, con 4 cinghietti
- grey, semi-flat, with 4 stretchers
- grau, halbflach, mit 4 Spanngummi



- 3FH/515
- O.E.M. 21094391
- d|s-rh|lh-rechts|links
- grigio-grey-grau

- 3FH/525
- O.E.M. 21094394
- d|s-rh|lh-rechts|links
- grigio, senza anti-spray
- grey, without anti-spray
- grau, ohne Spritzschutz



vista esterna - external view
Außenansicht

FH13 TERZA SERIE (2008) | THIRD SERIES (2008) | DRITTE SERIE (2008)

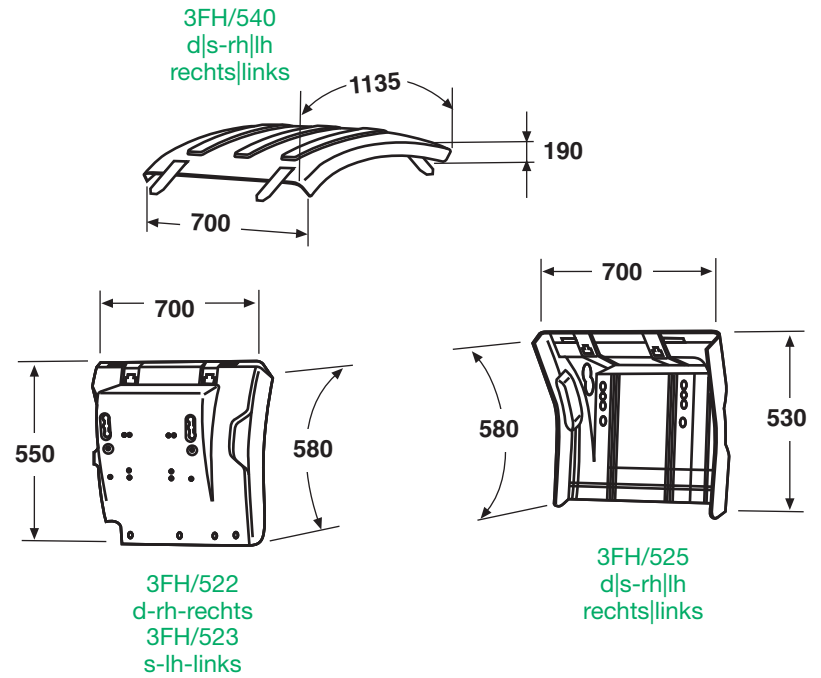
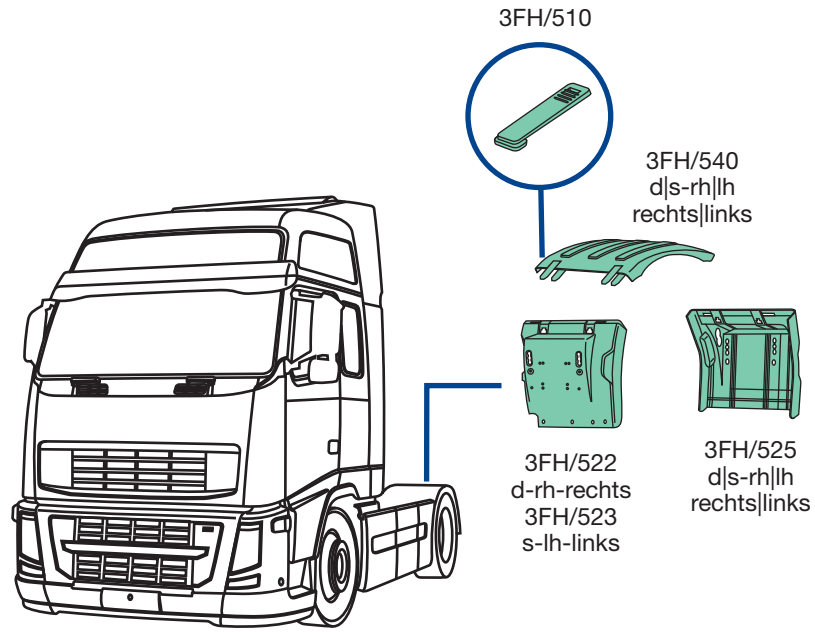

3FH/510
O.E.M. 21094457

FH13 TERZA SERIE (2008) | THIRD SERIES (2008) | DRITTE SERIE (2008)

- 3FH/540
- O.E.M. 21094390
- d|s-rh||h-rechts|links
- grigio, semipiatta, con 4 cinghietti
- grey, semi-flat, with 4 stretchers
- grau, halbfach, mit 4 Spanngummi

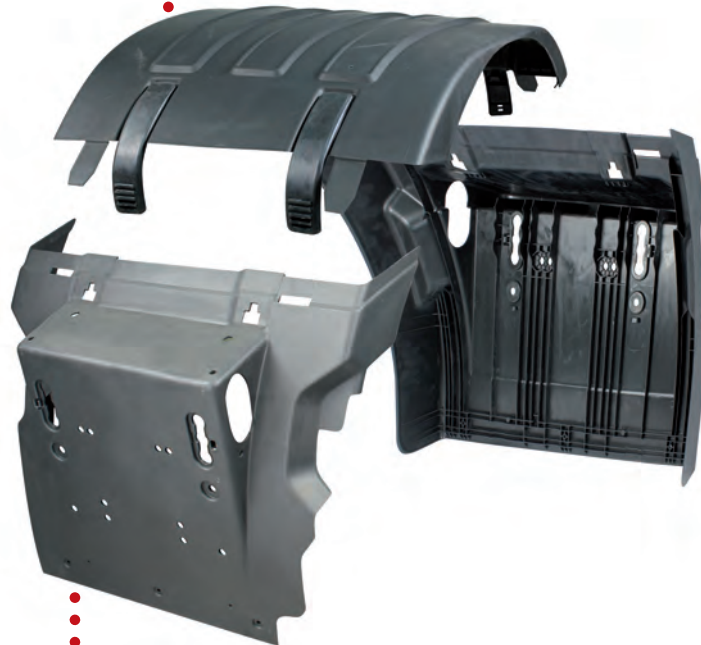

- 3FH/522
- O.E.M. 21094392
- d-rh-rechts
- grigio-grey-grau

- 3FH/525
- O.E.M. 21094394
- d|s-rh||h-rechts|links
- grigio, senza anti-spray
- grey, without anti-spray
- grau, ohne Spritzschutz



vista esterna - external view
Außenansicht

3FH/540



3FH/525

- 3FH/523
- O.E.M. 21094393
- s-lh-links
- grigio-grey-grau

applicabile a l suitable to l verwendbar für:

FH13 TERZA SERIE (2008) | THIRD SERIES (2008) | DRITTE SERIE (2008)

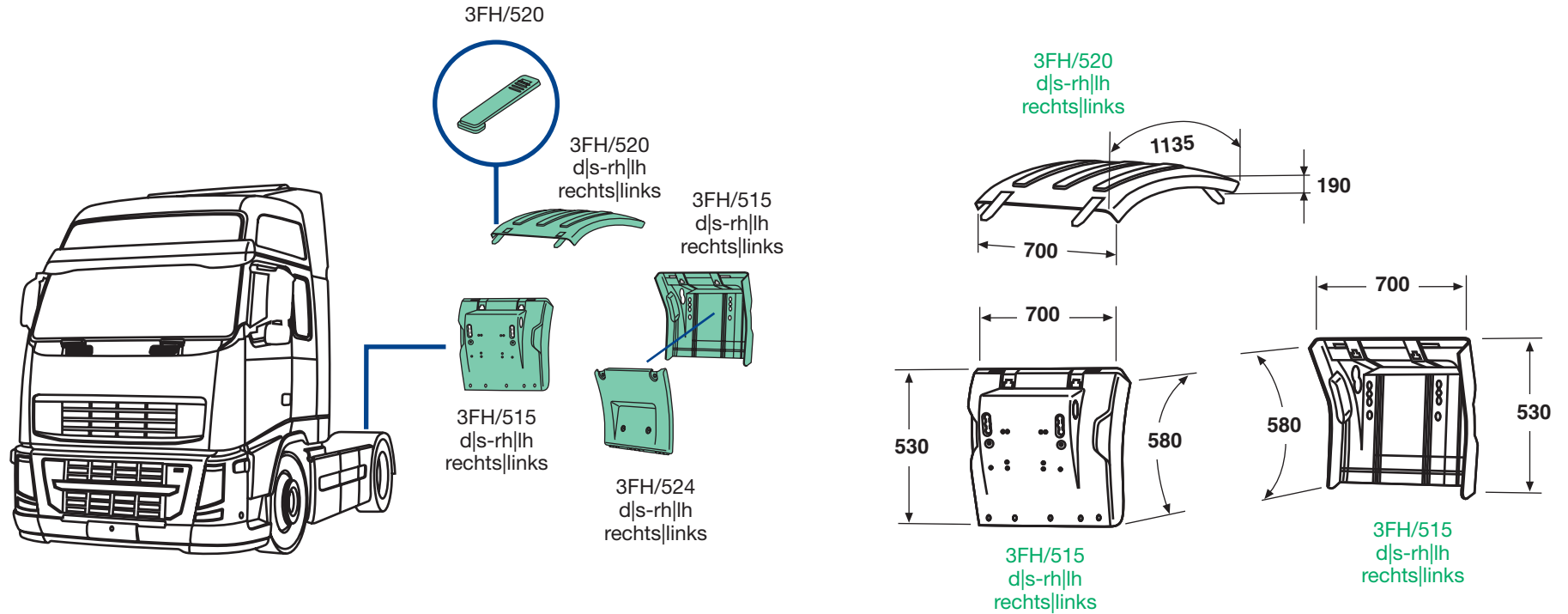

3FH/510
O.E.M. 21094457



3FH/524
O.E.M. 21094447

FH13 TERZA SERIE (2008) | THIRD SERIES (2008) | DRITTE SERIE (2008)

- 3FH/520
- O.E.M. 21094388
- d|s-rh|lh-rechts|links
- grigio, semipiatta, con 4 cinghietti
- grey, semi-flat, with 4 stretchers
- grau, halbfach, mit 4 Spanngummi
-
-



3FH/515

3FH/515
 O.E.M. 21094391
 d|s-rh|lh-rechts|links
 grigio-grey-grau



FH13 TERZA SERIE (2008) | THIRD SERIES (2008) | DRITTE SERIE (2008)

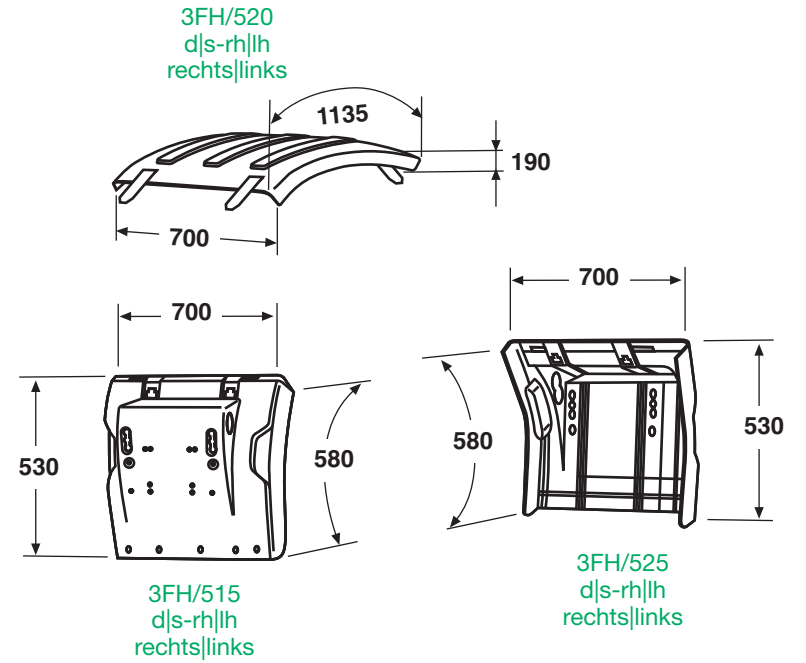
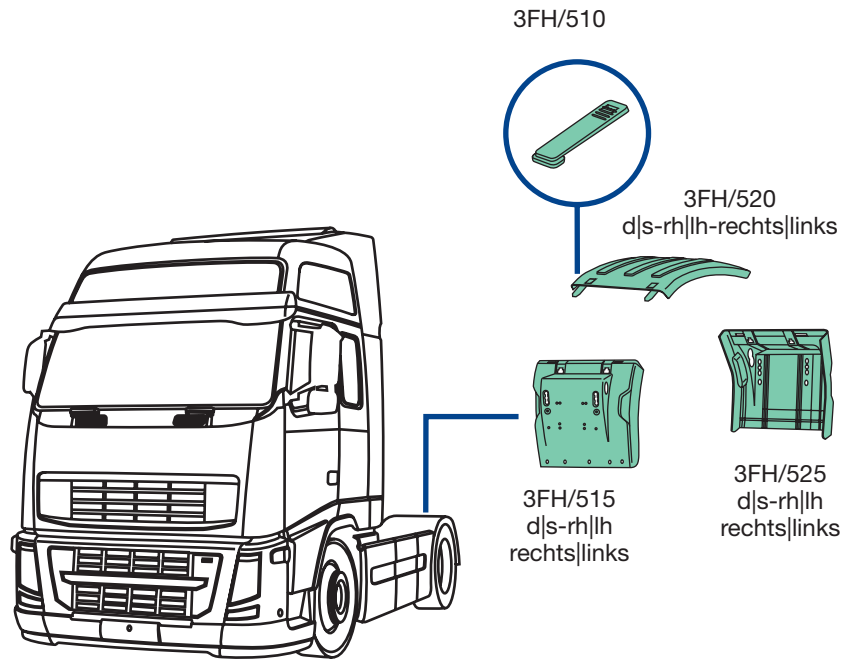

3FH/510
O.E.M. 21094457

FH13 TERZA SERIE (2008) | THIRD SERIES (2008) | DRITTE SERIE (2008)

- 3FH/520
- O.E.M. 21094388
- d|s-rh|lh-rechts|links
- grigio, semipiatta, con 4 cinghietti
- grey, semi-flat, with 4 stretchers
- grau, halbflach, mit 4 Spanngummi



- 3FH/515
- O.E.M. 21094391
- d|s-rh|lh-rechts|links
- grigio-grey-grau

- 3FH/525
- O.E.M. 21094394
- d|s-rh|lh-rechts|links
- grigio, senza anti-spray
- grey, without anti-spray
- grau, ohne Spritzschutz



vista esterna - external view
Außenansicht

applicabile a I suitable to I verwendbar für:

FH13 TERZA SERIE (2008) | THIRD SERIES (2008) | DRITTE SERIE (2008)

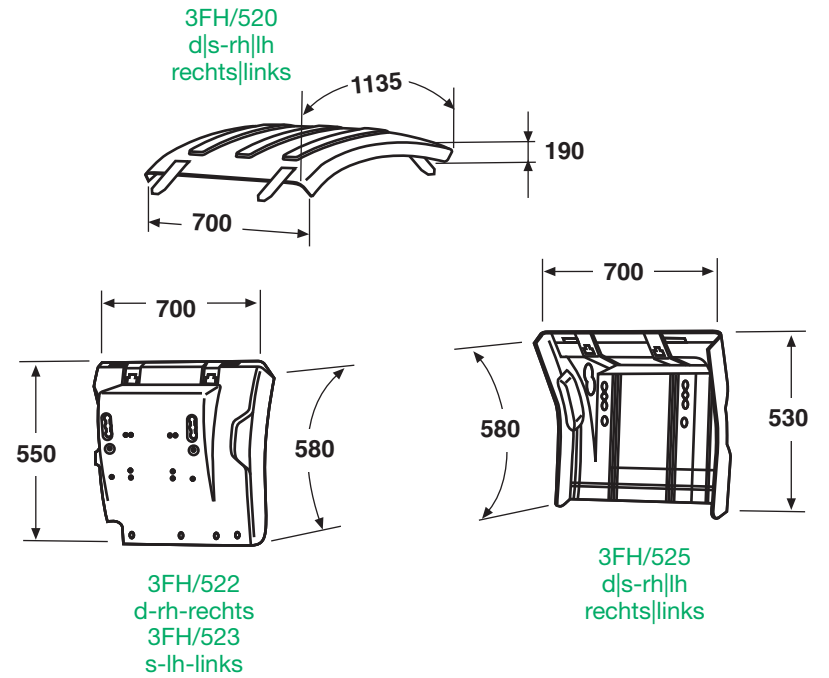
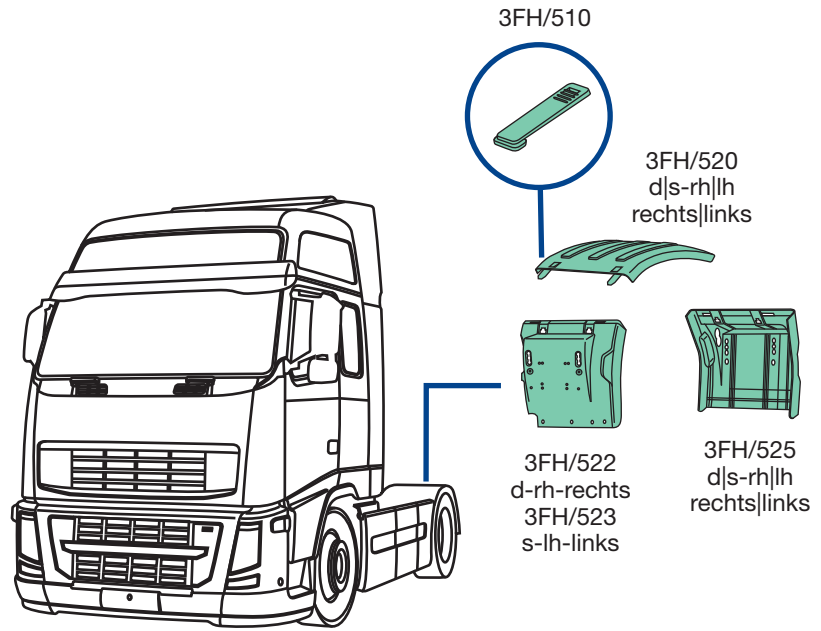

3FH/510
O.E.M. 21094457

FH13 TERZA SERIE (2008) | THIRD SERIES (2008) | DRITTE SERIE (2008)

- 3FH/520
- O.E.M. 21094388
- d|s-rh|lh-rechts|links
- grigio, semipiatta, con 4 cinghietti
- grey, semi-flat, with 4 stretchers
- grau, halbflach, mit 4 Spanngummi



- 3FH/522
- O.E.M. 21094392
- d-rh-rechts
- grigio-grey-grau

- 3FH/525
- O.E.M. 21094394
- d|s-rh|lh-rechts|links
- grigio, senza anti-spray
- grey, without anti-spray
- grau, ohne Spritzschutz



vista esterna - external view
Außenansicht

3FH/520



3FH/525

- 3FH/523
- O.E.M. 21094393
- s-lh-links
- grigio-grey-grau

applicabile a I suitable to I verwendbar für:

FH13 TERZA SERIE (2008) | THIRD SERIES (2008) | DRITTE SERIE (2008)

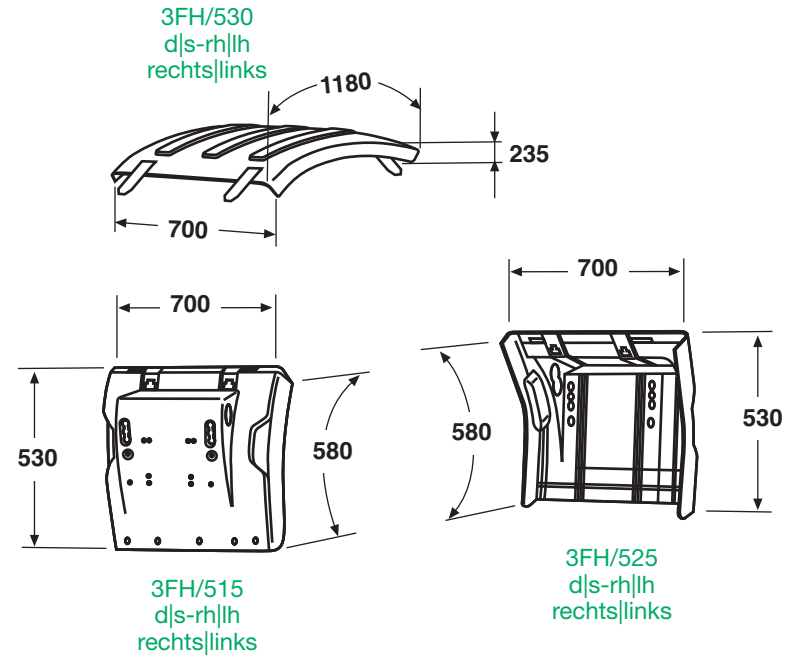
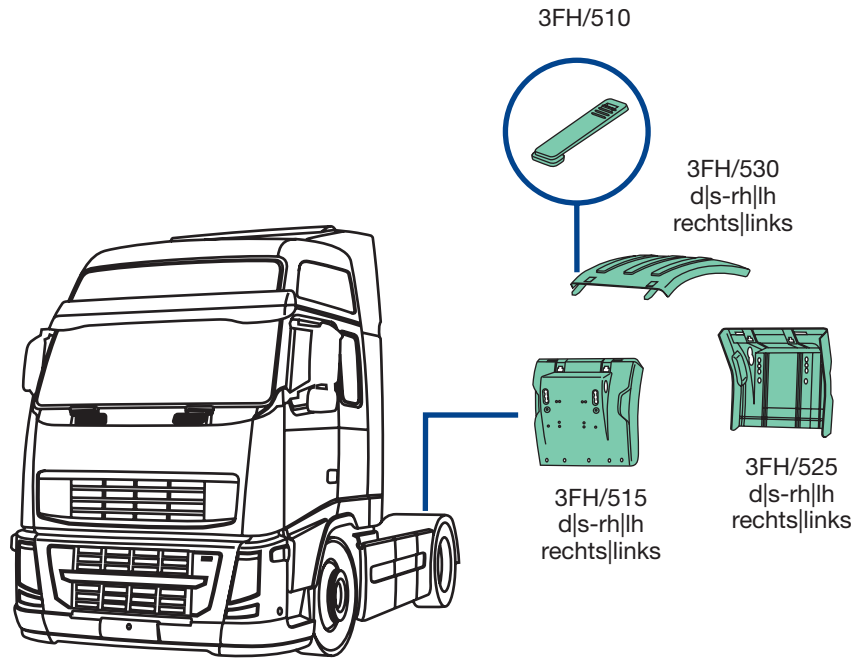

3FH/510
O.E.M. 21094457

FH13 TERZA SERIE (2008) | THIRD SERIES (2008) | DRITTE SERIE (2008)

- 3FH/530
- O.E.M. 21094387
- d|s-rh||h-rechts|links
- grigio, circolare, senza cinghietti
- grey, circular, without stretchers
- grau, kreisförmig, ohne Spanngummi



3FH/515
O.E.M. 21094391
d|s-rh||h-rechts|links
grigio-grey-grau

3FH/525
O.E.M. 21094394
d|s-rh||h-rechts|links
grigio, senza anti-spray
grey, without anti-spray
grau, ohne Spritzschutz



vista esterna - external view
Außenansicht

FH13 TERZA SERIE (2008) | THIRD SERIES (2008) | DRITTE SERIE (2008)

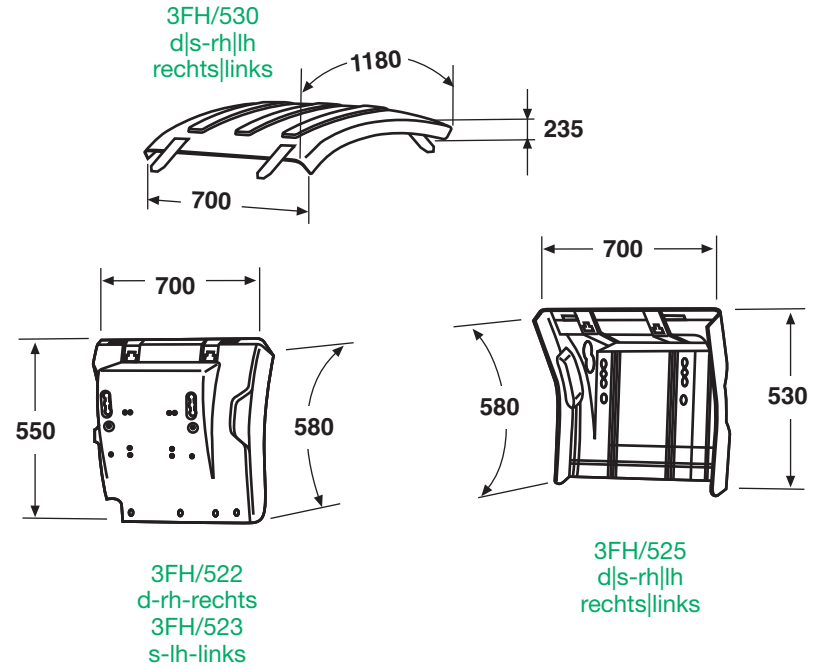
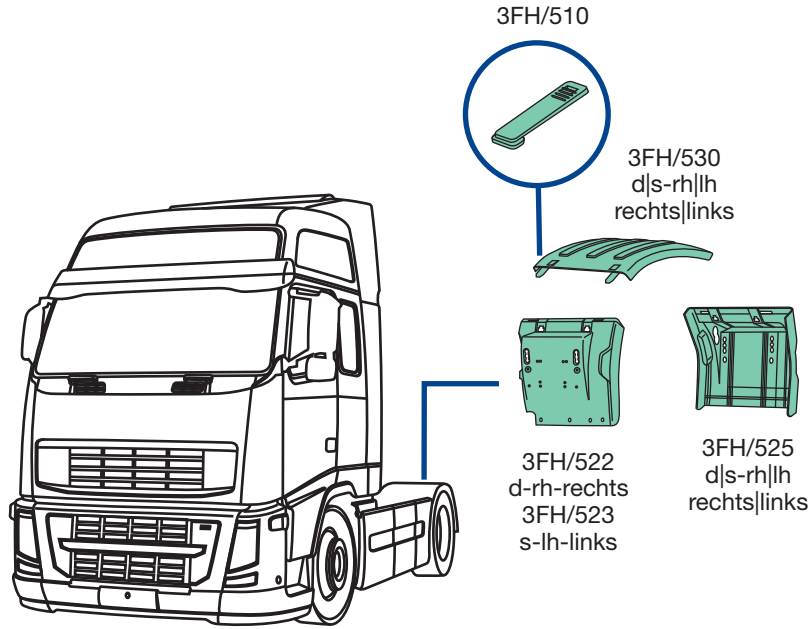

3FH/510
O.E.M. 21094457

FH13 TERZA SERIE (2008) | THIRD SERIES (2008) | DRITTE SERIE (2008)

- 3FH/530
- O.E.M. 21094387
- d|s-rh|lh-rechts|links
- grigio, circolare, senza cinghietti
- grey, circular, without stretchers
- grau, kreisförmig, ohne Spanngummi



- 3FH/522
- O.E.M. 21094392
- d-rh-rechts
- grigio-grey-grau

- 3FH/525
- O.E.M. 21094394
- d|s-rh|lh-rechts|links
- grigio, senza anti-spray
- grey, without anti-spray
- grau, ohne Spritzschutz



vista esterna - external view
Außenansicht

3FH/530



3FH/525

- 3FH/523
- O.E.M. 21094393
- s-lh-links
- grigio-grey-grau

applicabile a I suitable to I verwendbar für:

FH13 TERZA SERIE (2008) | THIRD SERIES (2008) | DRITTE SERIE (2008)

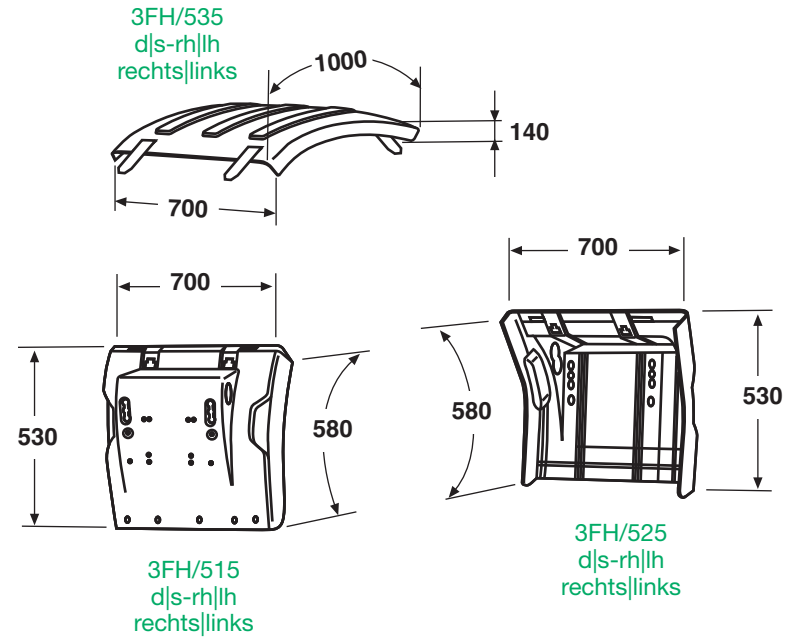
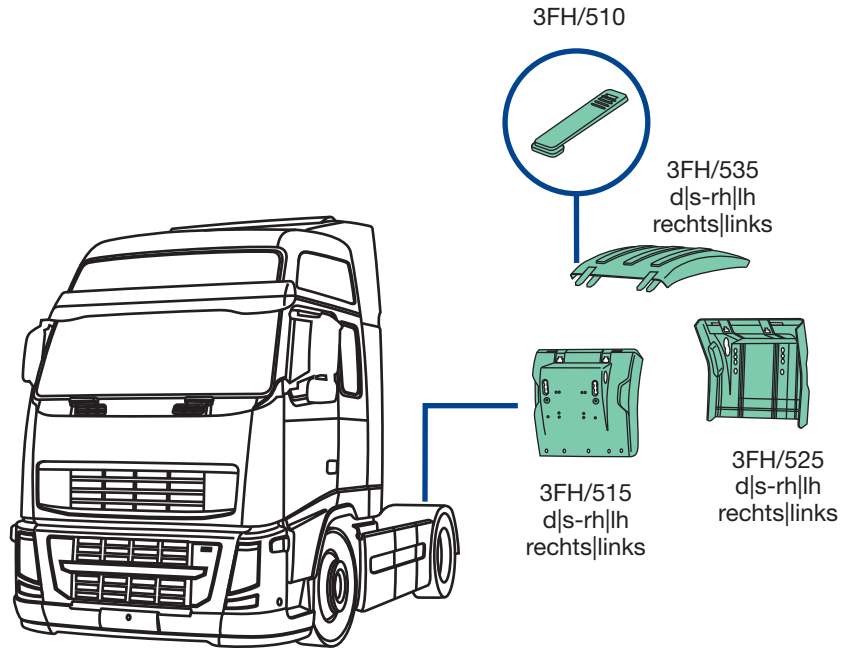

3FH/510
O.E.M. 21094457

FH13 TERZA SERIE (2008) | THIRD SERIES (2008) | DRITTE SERIE (2008)

- 3FH/535
- O.E.M. 21094389
- d|s-rh|lh-rechts|links
- grigio, piatta, con 4 cinghietti
- grey, flat, with 4 stretchers
- grau, flach, mit 4 Spanngummi

3FH/515
 O.E.M. 21094391
 d|s-rh|lh-rechts|links
 grigio-grey-grau



3FH/525
 O.E.M. 21094394
 d|s-rh|lh-rechts|links
 grigio, senza anti-spray
 grey, without anti-spray
 grau, ohne Spritzschutz



vista esterna - external view
 Außenansicht

applicabile a l suitable to l verwendbar für:

FH13 TERZA SERIE (2008) | THIRD SERIES (2008) | DRITTE SERIE (2008)

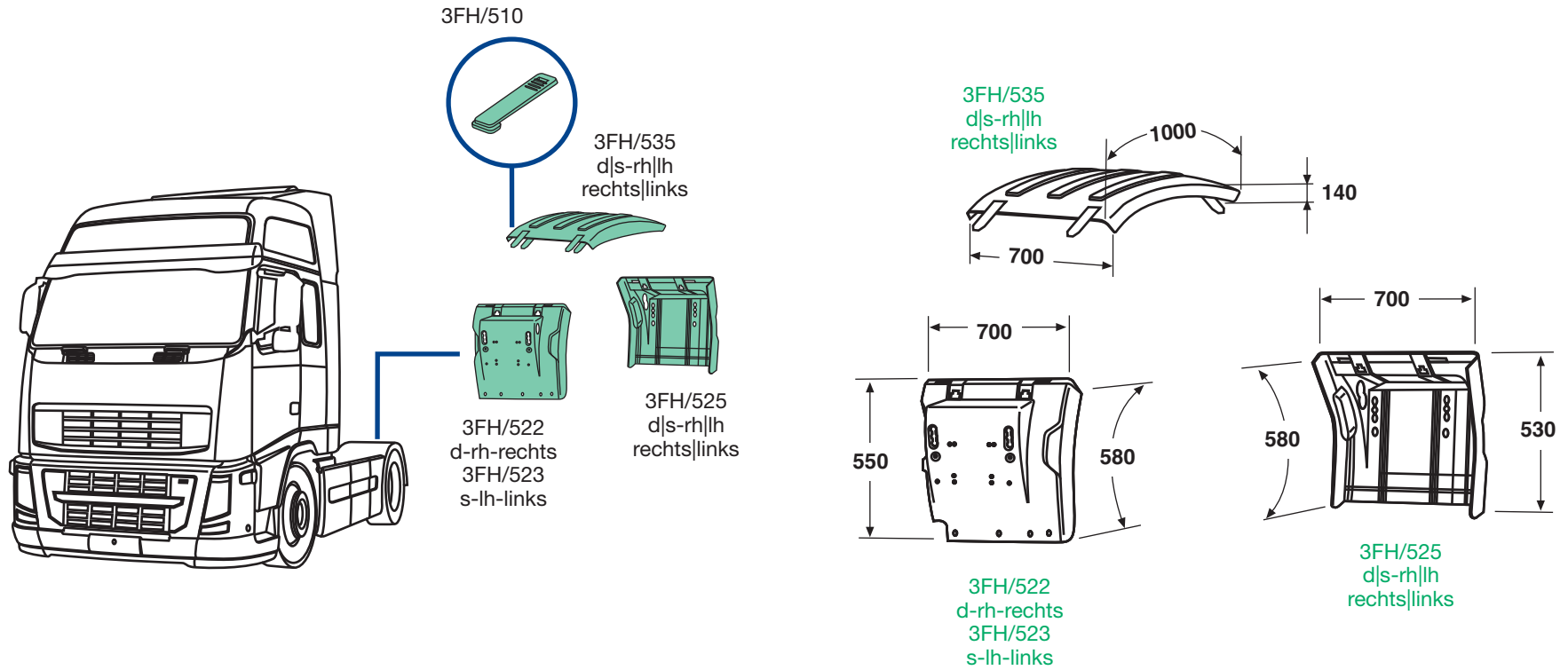

3FH/510
O.E.M. 21094457

FH13 TERZA SERIE (2008) | THIRD SERIES (2008) | DRITTE SERIE (2008)

- 3FH/535
- O.E.M. 21094389
- d|s-rh|lh-rechts|links
- grigio, piatta, con 4 cinghietti
- grey, flat, with 4 stretchers
- grau, flach, mit 4 Spanngummi

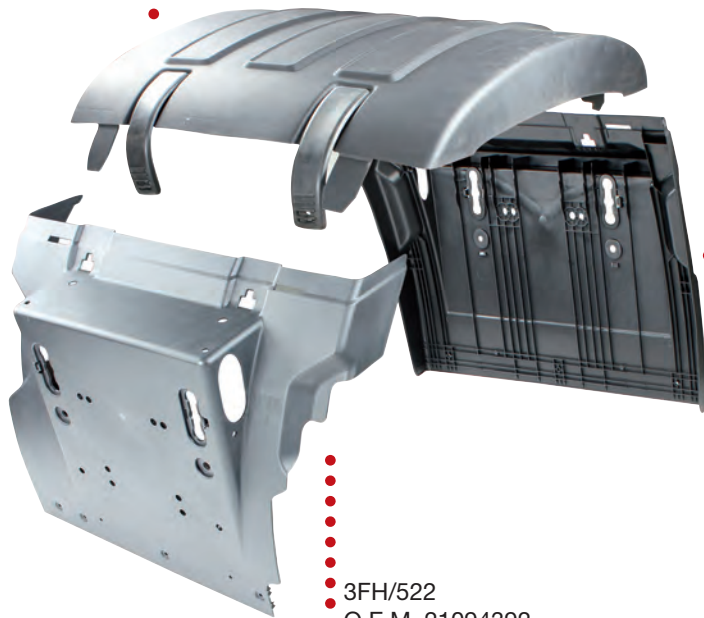

- 3FH/522
- O.E.M. 21094392
- d-rh-rechts
- grigio-grey-grau

- 3FH/525
- O.E.M. 21094394
- d|s-rh|lh-rechts|links
- grigio, senza anti-spray
- grey, without anti-spray
- grau, ohne Spritzschutz



vista esterna - external view
Außenansicht



- 3FH/523
- O.E.M. 21094393
- s-lh-links
- grigio-grey-grau

FH13 TERZA SERIE (2008) | THIRD SERIES (2008) | DRITTE SERIE (2008)



- 2FH/515
d|s-rh|lh
rechts|links
- 2FH/520
d|s-rh|lh
rechts|links
- 2FH/518
d|s-rh|lh
rechts|links
con staffe
(2FH/517 2 pz.)
anteriore|posteriore
with brackets
front|rear
mit Klemme
Vorderteil|Hinterteil
- 2FH/505
d|s-rh|lh
rechts|links
senza staffe
anteriore|posteriore
without brackets
front|rear
ohne Klemme
Vorderteil|Hinterteil

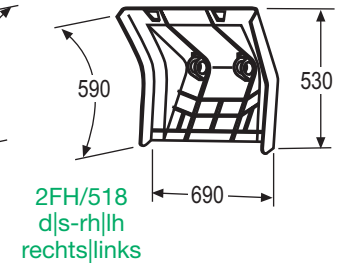
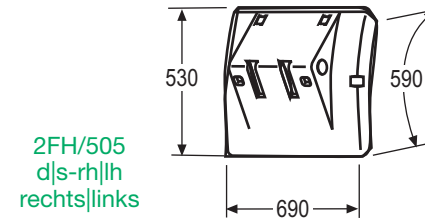
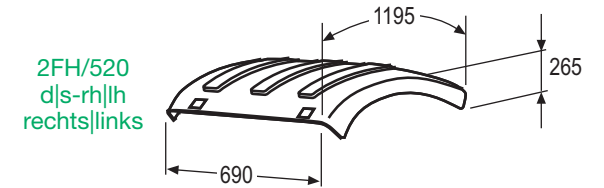
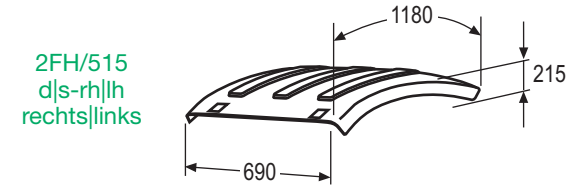

FH13 TERZA SERIE (2008) | THIRD SERIES (2008) | DRITTE SERIE (2008)

- 2FH/515
- O.E.M. 20936759
- d|s-rh|lh-rechts|links
- grigio, semipiatta, senza cinghietti
- grey, semi-flat, without stretchers
- grau, halbflach, ohne Spanngummi

- 2FH/518
- O.E.M. 20392599
- d|s-rh|lh-rechts|links
- grigio, senza anti-spray, con staffe
- grey, without anti-spray, with brackets
- grau, ohne Spritzschutz, mit Klemme

- 2FH/520
- O.E.M. 20936769
- d|s-rh|lh-rechts|links
- grigio, circolare, senza cinghietti
- grey, circular, without stretchers
- grau, kreisförmig, ohne Spanngummi



- 2FH/505
- O.E.M. 20392544
- d|s-rh|lh-rechts|links
- grigio, senza staffe
- grey, without brackets
- grau, ohne Klemme

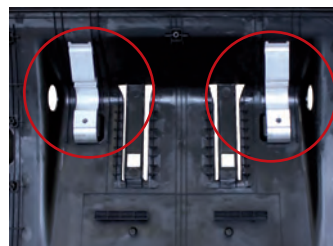

2FH/518



2FH/505

applicabile a | suitable to | verwendbar für:

FH13 TERZA SERIE (2008) | THIRD SERIES (2008) | DRITTE SERIE (2008)

adattabile a: - suitable to: - passend für:

(*) 3FH/515

(°) 3FH/522-3FH/523

() 3FH/315-3FH/525**

3FH/527(*)

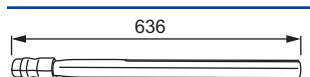

3FH/528(°)

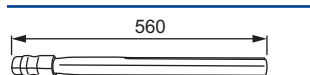

3FH/532(**)

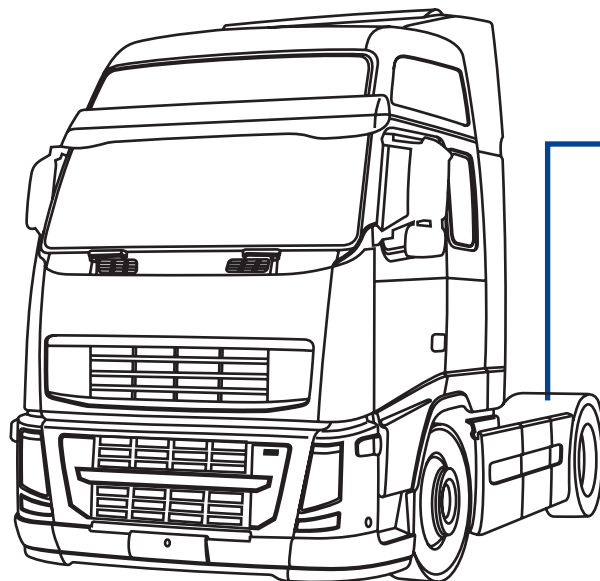
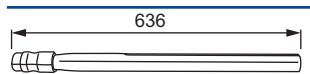

3FH/527(*)
d|s-rh|lh-rechts|links
3FH/528(°)
d|s-rh|lh-rechts|links
3FH/532(**)
d|s-rh|lh-rechts|links

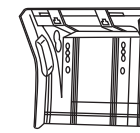
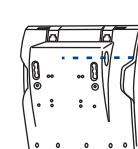

3FH/526
d|s-rh|lh
rechts|links



3FH/526
O.E.M. 21094456 + 21094454



3FH/527
O.E.M. 22192010
3FH/528
O.E.M. 21094410



3FH/532
O.E.M. 22192015

FH13 TERZA SERIE (2008) | THIRD SERIES (2008) | DRITTE SERIE (2008)

adattabile a: - suitable to: - passend für:
(*) 2FH/505



OFH/526
d|s-rh|lh
rechts|links



OFH/527
d|s-rh|lh
rechts|links



OFH/522(*)
d|s-rh|lh
rechts|links

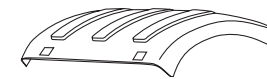

OFH/522(*)
d|s-rh|lh-rechts|links

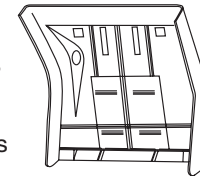

OFH/522(*)

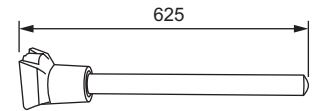

OFH/522
O.E.M. 20466894



OFH/526
O.E.M. 20382890



OFH/527
O.E.M. 20383038

FH13 TERZA SERIE (2008) | THIRD SERIES (2008) | DRITTE SERIE (2008)

adattabile a - suitable to - passend für:

(*) 2FH/510

(°) PRM/515

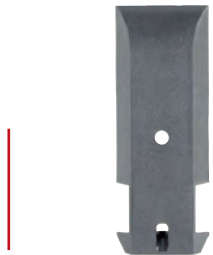
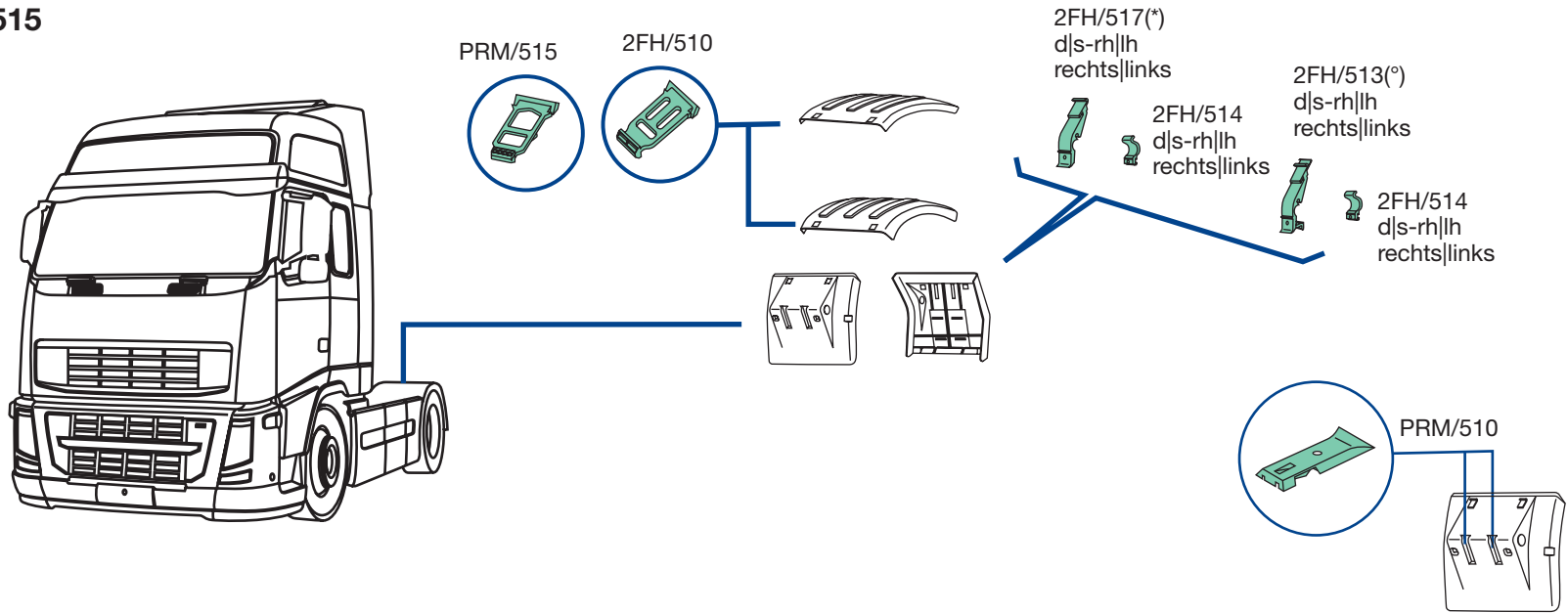

PRM/510
O.E.M. 20721840



PRM/515
O.E.M. 20498623



2FH/510
O.E.M. 1079981



2FH/513
O.E.M. 20583434



2FH/514
O.E.M. 20583440



2FH/517
O.E.M. 3987252

FH13 TERZA SERIE (2008) | THIRD SERIES (2008) | DRITTE SERIE (2008)

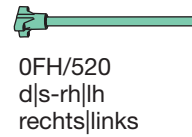

0FH/520
d|s-rh|lh
rechts|links



0FH/521
d|s-rh|lh
rechts|links

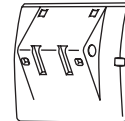
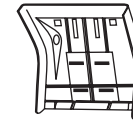

0FH/520

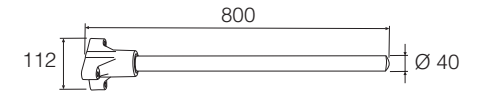

0FH/521

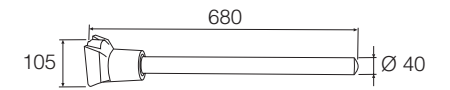

0FH/520
O.E.M. 8154385



0FH/521
O.E.M. 20466895

applicabile a l suitable to l verwendbar für:

FH13 TERZA SERIE (2008) | THIRD SERIES (2008) | DRITTE SERIE (2008)

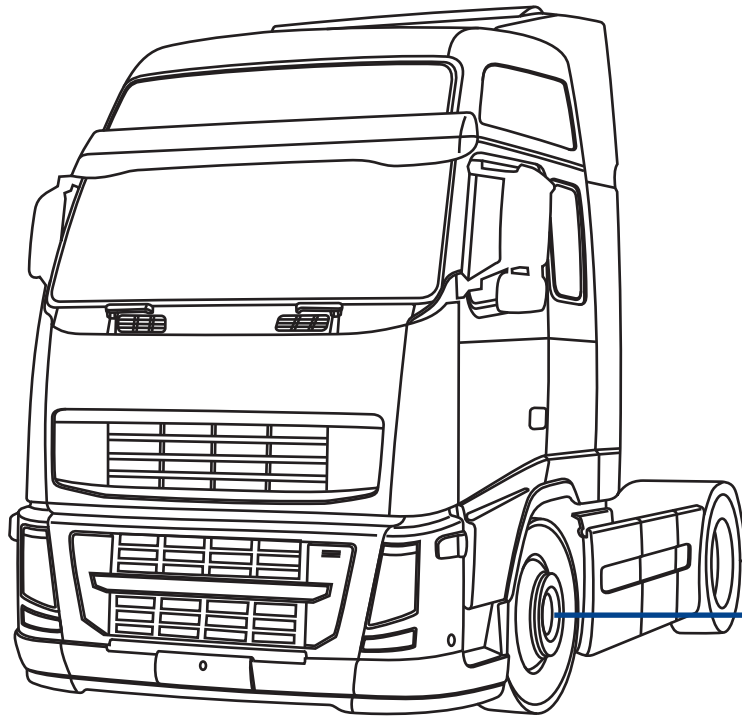

930/033

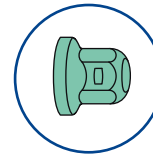

930/200
d|s-rh|lh
rechts|links

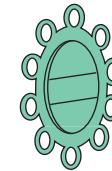

930/100
d-rhrechts
930/101
s-lh-links

930/001
d-rh-rechts
930/002
s-lh-links



930/033
O.E.M. -

930/001
O.E.M. -
930/002
O.E.M. -

930/100
O.E.M. -
930/101
O.E.M. -

930/200
O.E.M. -

FH13 TERZA SERIE (2008) | THIRD SERIES (2008) | DRITTE SERIE (2008)

930/033-Tappo copri Bullone-Bolt cover-Radmutterkappen

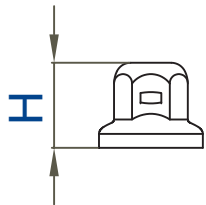

H	45 mm
Per bulloni \varnothing - bolt \varnothing	33 mm
Schlüsselweite \varnothing	
Colore	cromato-chrome-verchromt
Colours-Farbe	
Materiale-Material	acciaio inox-stainless steel
	Edelstahl
Kg	0,025

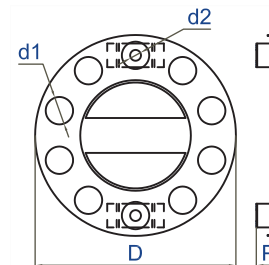

930/001 d-rh-rechts | 930/002 s-lh-links

D \varnothing 425 mm	P 50 mm
d1 nr. 10	d1 \varnothing 58 mm
d2 nr. 2	d2 \varnothing 23 mm
Ventilata	si-yes-Ja
Ventilated-Belüftet	
Colore	cromato e nero-chrome and black
Colours-Farbe	verchromt und schwarz
Materiale-Material	acciaio inox e plastica
	stainless steel and plastic
	Edelstahl und Kunststoff
Kg	1,230

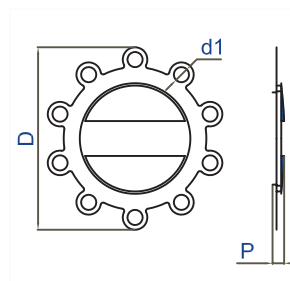

930/100 d-rh-rechts | 930/101 s-lh-links

D \varnothing 387 mm	P 30 mm
d1 nr. 10	d1 \varnothing 32 mm
Ventilata	si-yes-Ja
Ventilated-Belüftet	
Colore	cromato e nero-chrome and black
Colours-Farbe	verchromt und schwarz
Materiale-Material	acciaio inox e plastica
	stainless steel and plastic
	Edelstahl und Kunststoff
Kg	0,655

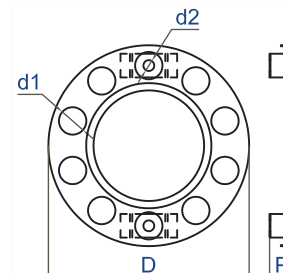

930/200 d|s-rh|lh-rechts+links

D \varnothing 425 mm	P 40 mm
d1 nr. 10	d1 \varnothing 58 mm
d2 nr. 2	d2 \varnothing 23 mm
Ventilata	no-nein
Ventilated-Belüftet	
Colore	cromato-chrome-verchromt
Colours-Farbe	
Materiale-Material	acciaio inox-stainless steel
	Edelstahl
Kg	1,155

applicabile a | suitable to | verwendbar für:

FH13 TERZA SERIE (2008) | THIRD SERIES (2008) | DRITTE SERIE (2008)

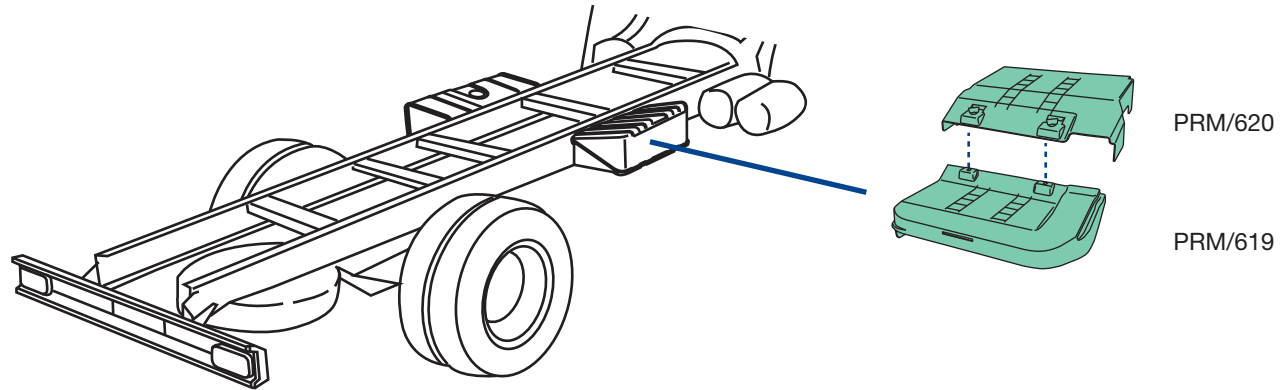

PRM/619
O.E.M. 21924924



PRM/620
O.E.M. 21924923



applicabile a | suitable to | verwendbar für

173

2FH
FH12-FH16

SECONDA SERIE | SECOND SERIES | ZWEITE SERIE

applicabile a | suitable to | verwendbar für:

FH12-FH16 SECONDA SERIE | SECOND SERIES | ZWEITE SERIE

(*) Cava-Cantiere
Yard & Quarry
Baustellenfahrzeug

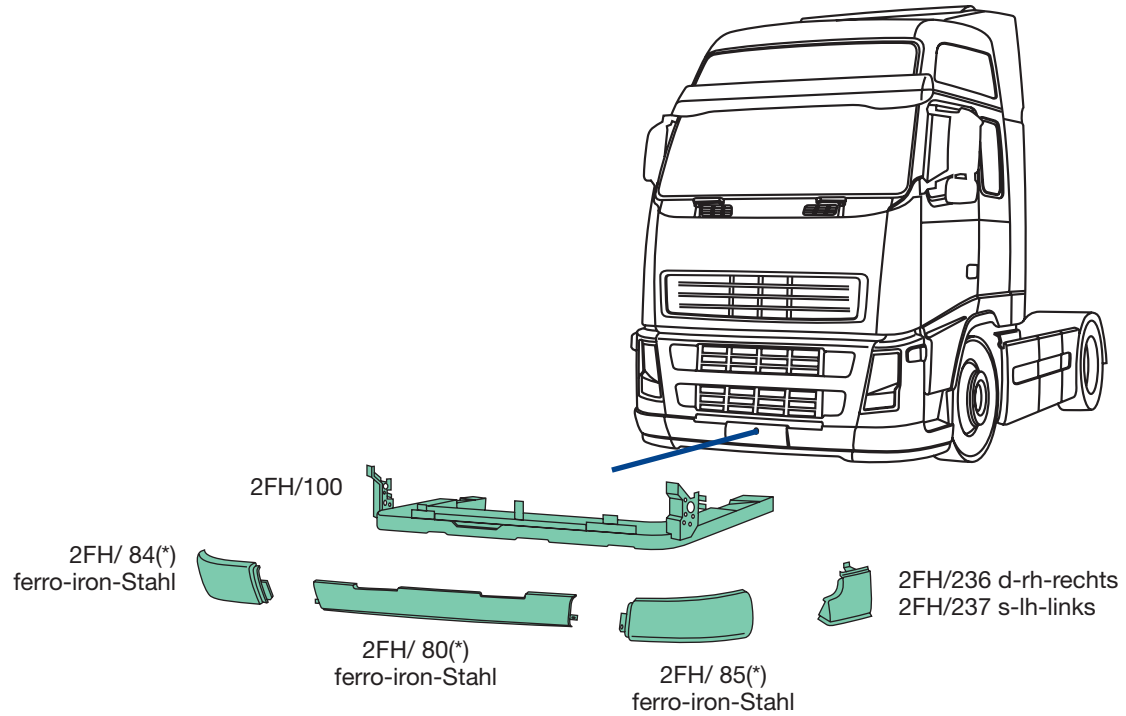

2FH/ 80
O.E.M. 21828914



2FH/ 84
O.E.M. 21829052
2FH/ 85
O.E.M. 21829051



2FH/100
O.E.M. 21484901



2FH/236
O.E.M. 20453677
2FH/237
O.E.M. 20453676

FH12-FH16 SECONDA SERIE | SECOND SERIES | ZWEITE SERIE

(*) grezzo
unprocessed
roh

(°) verniciato grigio scuro
dark grey painted
dunkel grau strukturlackiert



2FH/ 92(*)
plastica-plastic-Kunststoff
2FH/ 96(°)
plastica-plastic-Kunststoff

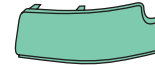
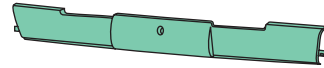

2FH/ 90(*)
plastica-plastic-Kunststoff
2FH/ 89(°)
plastica-plastic-Kunststoff

2FH/ 93(*)
plastica-plastic-Kunststoff
2FH/ 97(°)
plastica-plastic-Kunststoff



2FH/ 89
O.E.M. 20529740



2FH/ 90
O.E.M. 21359080



2FH/ 92
O.E.M. 21359090
2FH/ 93
O.E.M. 21359082



2FH/ 96
O.E.M. 20529742
2FH/ 97
O.E.M. 20529741

applicabile a I suitable to I verwendbar für:

FH12-FH16 | SECONDA SERIE | SECOND SERIES | ZWEITE SERIE

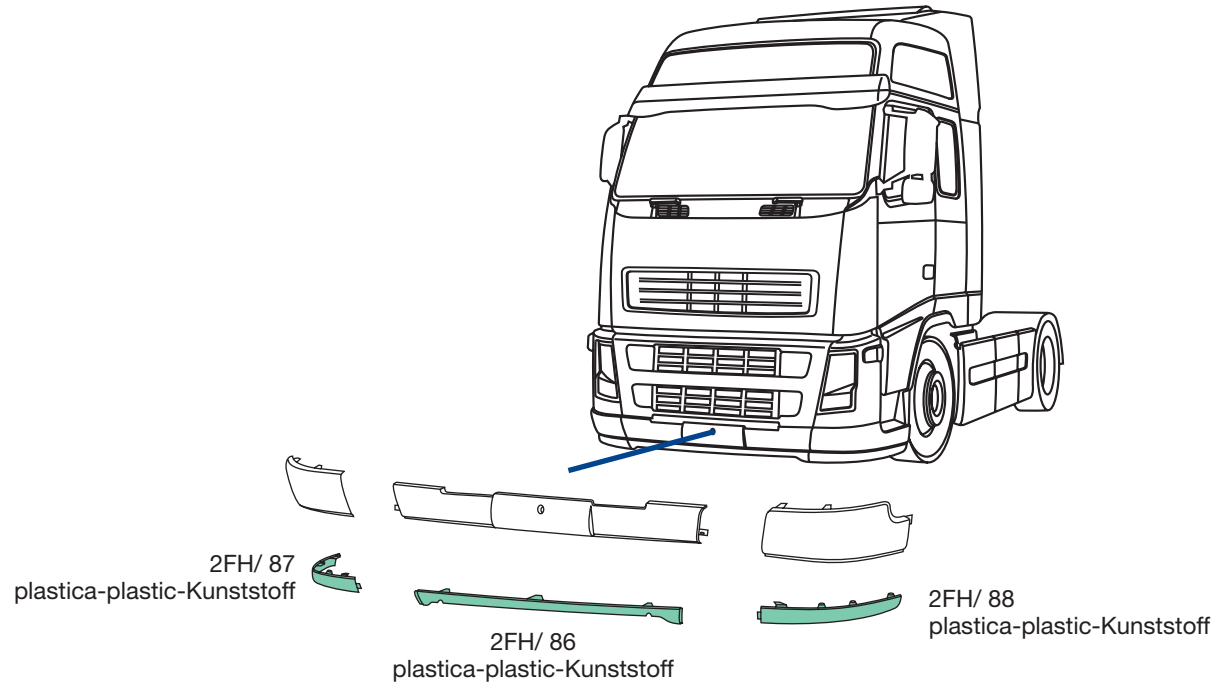

2FH/ 86
O.E.M. 21430599



2FH/ 87
O.E.M. 21430672
2FH/ 88
O.E.M. 21430600

FH12-FH16 SECONDA SERIE | SECOND SERIES | ZWEITE SERIE

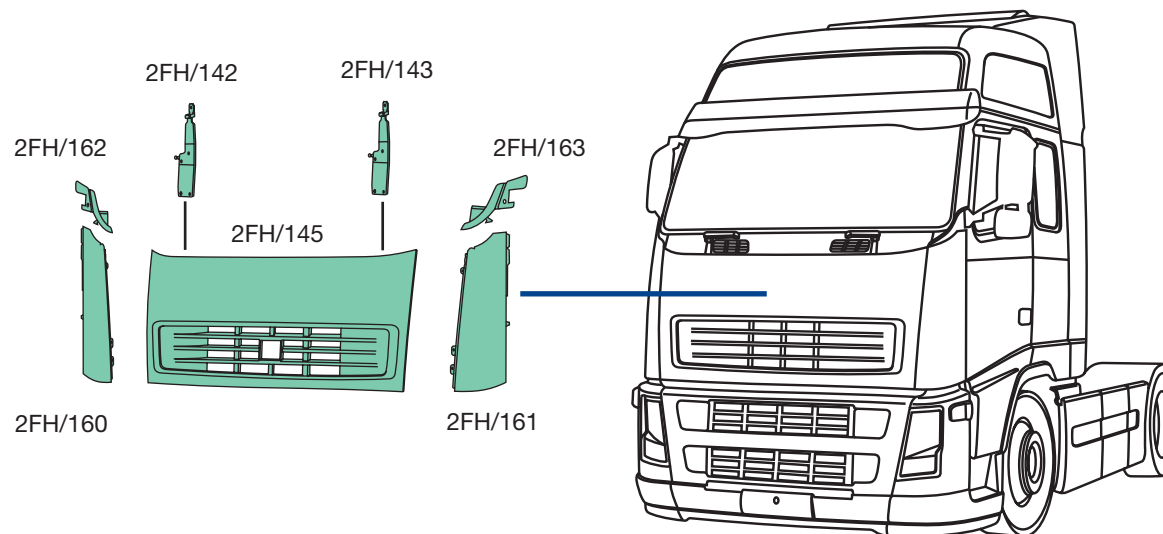

2FH/145
O.E.M. 20360266



2FH/142
O.E.M. 20467143
2FH/143
O.E.M. 20467142



2FH/160
O.E.M. 20379176
2FH/161
O.E.M. 20379175



2FH/162
O.E.M. 20529672
2FH/163
O.E.M. 20529668

applicabile a l suitable to l verwendbar für:

FH12-FH16 | SECONDA SERIE | SECOND SERIES | ZWEITE SERIE

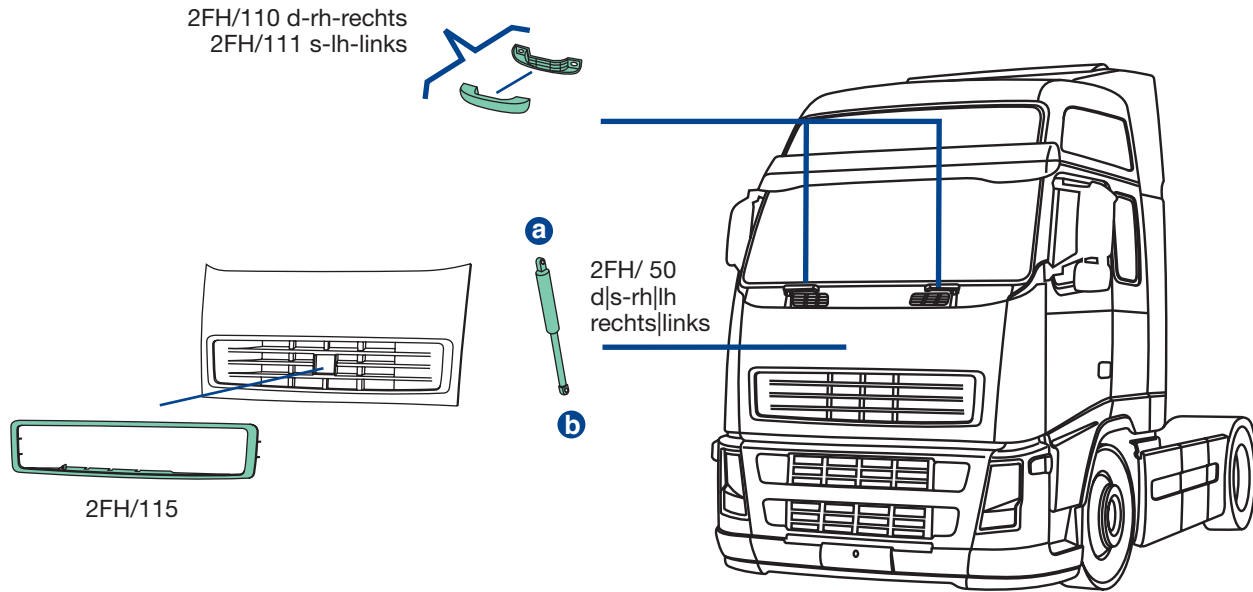

COVIND



2FH/ 50
O.E.M. 20379348



2FH/110
O.E.M. 3175367+3175366
2FH/111
O.E.M. 20383543+3175366



2FH/115
O.E.M. 20467053



2FH/400

O.E. 20456709

Adattabile a:
Suitable to:
passend für:

**FH12-16 - FM7-12
2002 →2008**

Materiale | Material:
PMMA - ACRYLGLAS

2FH/480

O.E. 20467422 +
20467412 +
20467414 +
20467424

KIT completo
di staffe
e minuterie.
Assembly KIT.
Befestigungssatz



L'immagine del prodotto è da considerarsi puramente indicativa | The product image is just for information | Die Produktbilder sind nur zur Information.



L	H	P	kg.
cm.	cm.	cm.	
231	26	18,5	1,920

applicabile a I suitable to I verwendbar für:

FH12-FH16 SECONDA SERIE | SECOND SERIES | ZWEITE SERIE

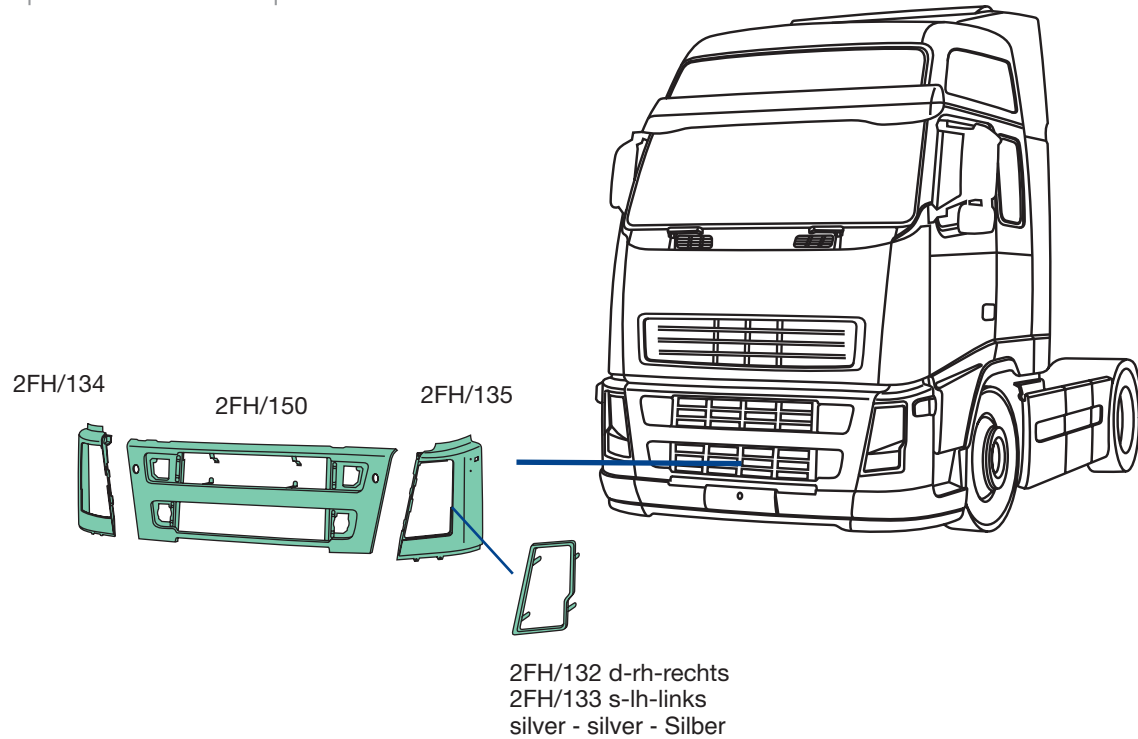

2FH/132
O.E.M. 20452848
2FH/133
O.E.M. 20452847



2FH/134
O.E.M. 21469924
2FH/135
O.E.M. 21469918

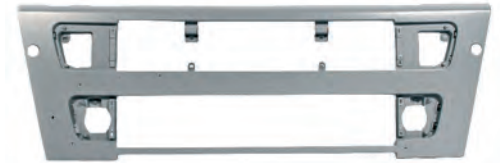

2FH/150
O.E.M. 21430596

FH12-FH16 SECONDA SERIE | SECOND SERIES | ZWEITE SERIE

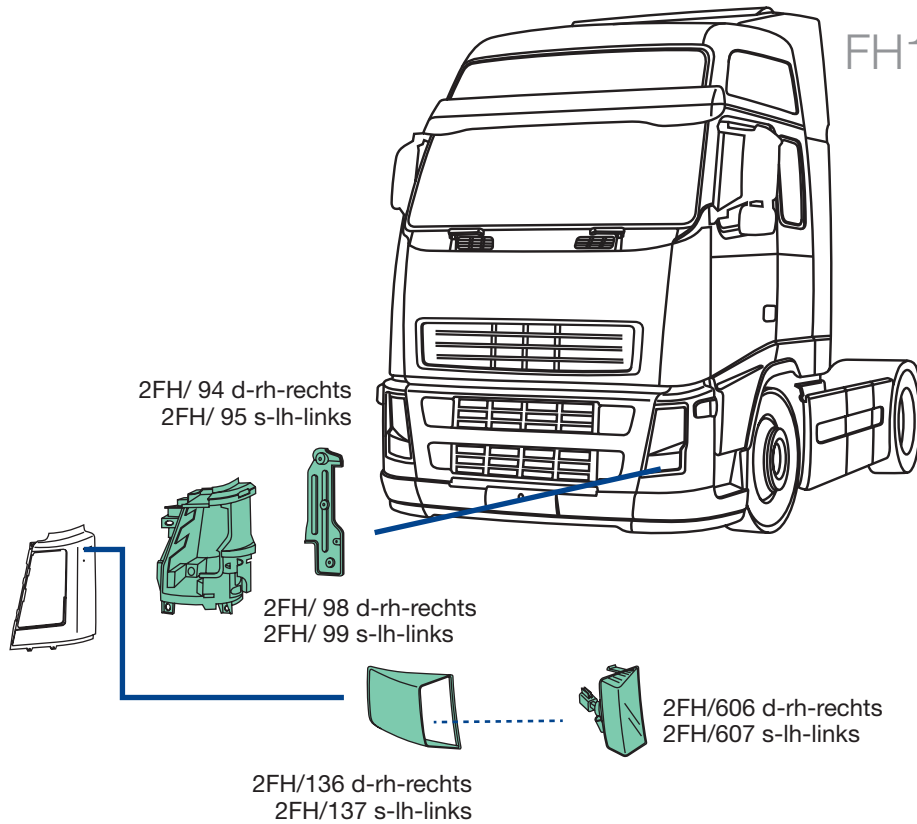

2FH/ 94
O.E.M. 21359260
2FH/ 95
O.E.M. 21359257



2FH/ 98
O.E.M. 20917958
2FH/ 99
O.E.M. 20917957



2FH/136
O.E.M. 21469979
2FH/137
O.E.M. 21430598



2FH/606
O.E.M. 20826213
2FH/607
O.E.M. 20826211



applicabile a I suitable to I verwendbar für:

FH12-FH16 | SECONDA SERIE | SECOND SERIES | ZWEITE SERIE

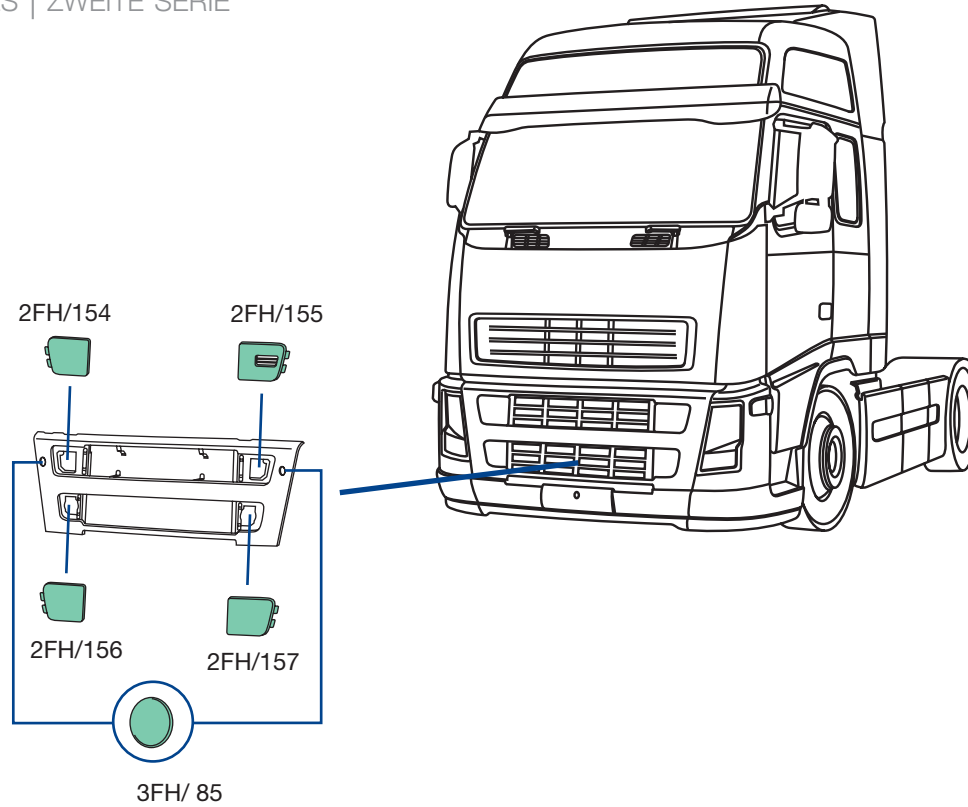

2FH/154
O.E.M. 20529706



2FH/155
O.E.M. 20529705



2FH/156
O.E.M. 20529708
2FH/157
O.E.M. 20529707



3FH/85
O.E.M. 21425186

(*) >2007 singole-singles-Einzelteil
2007> 2FH/152 + 2FH/153 (in coppia-a pair of-Paar)

FH12-FH16 SECONDA SERIE | SECOND SERIES | ZWEITE SERIE

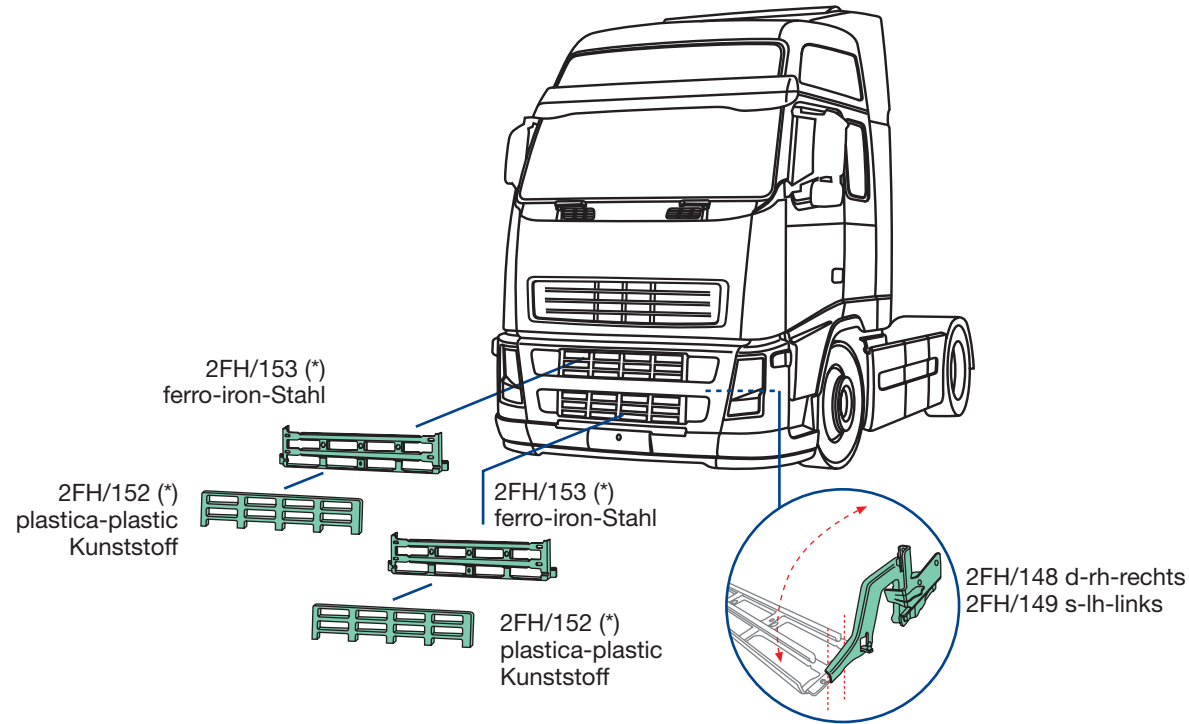

2FH/148
O.E.M. 20545095
2FH/149
O.E.M. 20545094



2FH/152
O.E.M. 20409818



2FH/153
O.E.M. 20456963

applicabile a l suitable to l verwendbar für:

FH12-FH16 SECONDA SERIE | SECOND SERIES | ZWEITE SERIE

2FH/ 6 d-rh-rechts
2FH/ 7 s-lh-links

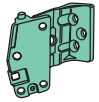

2FH/ 9
d|s-rh|lh
rechts|links

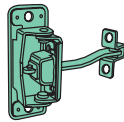

2FH/ 10
d|s-rh|lh
rechts|links

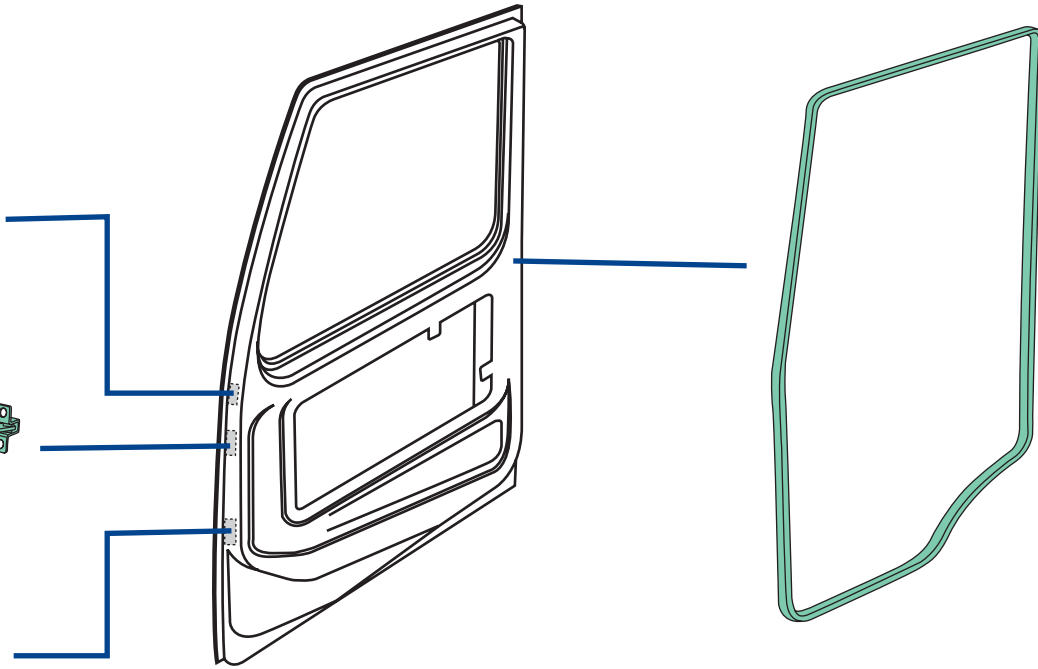
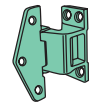

OFH/190

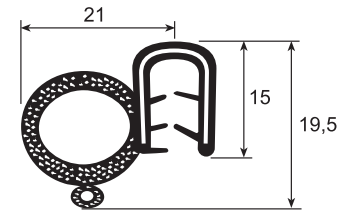

OFH/190



2FH/ 6
O.E.M. 20398136
2FH/ 7
O.E.M. 20398135

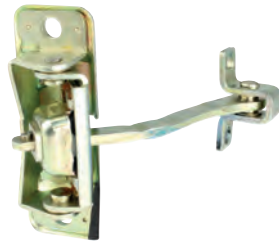

2FH/ 9
O.E.M. 1062636



2FH/ 10
O.E.M. 20372039



OFH/190
O.E.M. 3175029

FH12-FH16 SECONDA SERIE | SECOND SERIES | ZWEITE SERIE

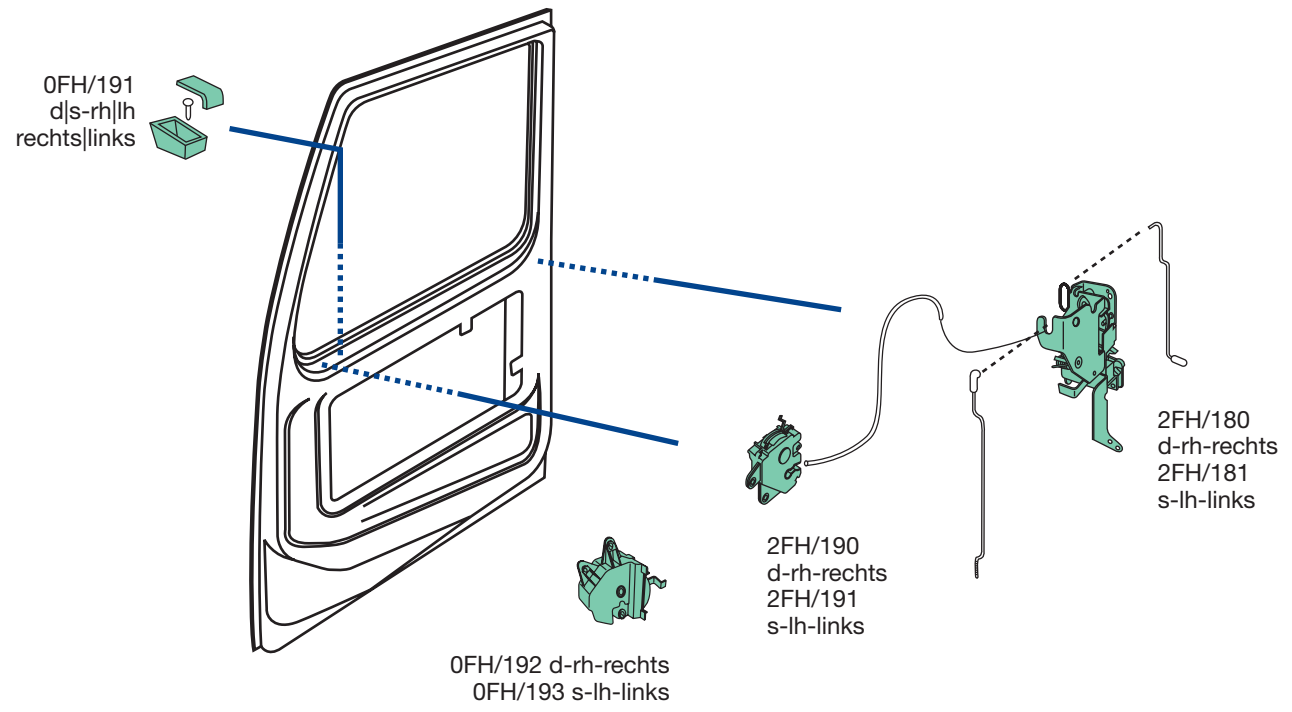

0FH/191
O.E.M. 20379593



0FH/192
O.E.M. 1063328
0FH/193
O.E.M. 1063327



2FH/180
O.E.M. 21505894
2FH/181
O.E.M. 21505893



2FH/190
O.E.M. 20570722
2FH/191
O.E.M. 20570721

FH12-FH16 SECONDA SERIE | SECOND SERIES | ZWEITE SERIE

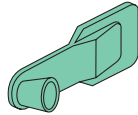
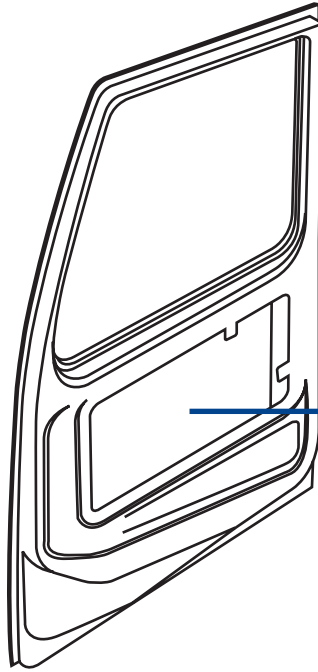

0FH/166
d|s-rh|lh-rechts|links

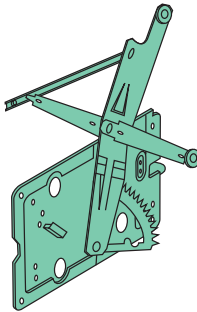

0FM/174 d-rh-rechts
0FM/175 s-lh-links
elettrico, senza motorino
electric, without motor
elektrisch, ohne Motor

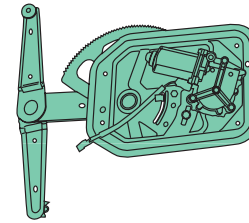

0FH/164 d-rh-rechts
0FH/165 s-lh-links
elettrico, con motorino
electric, with motor
elektrisch, mit Motor

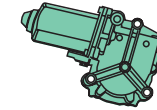

0FH/168 d-rh-rechts
0FH/169 s-lh-links



0FM/174
O.E.M. -
0FM/175
O.E.M. -



IN ALLESTIMENTO::NOT AVAILABLE YET::IN ARBEIT

0FH/164
O.E.M. 3176542
0FH/165
O.E.M. 3176541



0FH/166
O.E.M. 1606375



IN ALLESTIMENTO::NOT AVAILABLE YET::IN ARBEIT

0FH/168
O.E.M. 3176550
0FH/169
O.E.M. 3176549

FH12-FH16 SECONDA SERIE | SECOND SERIES | ZWEITE SERIE

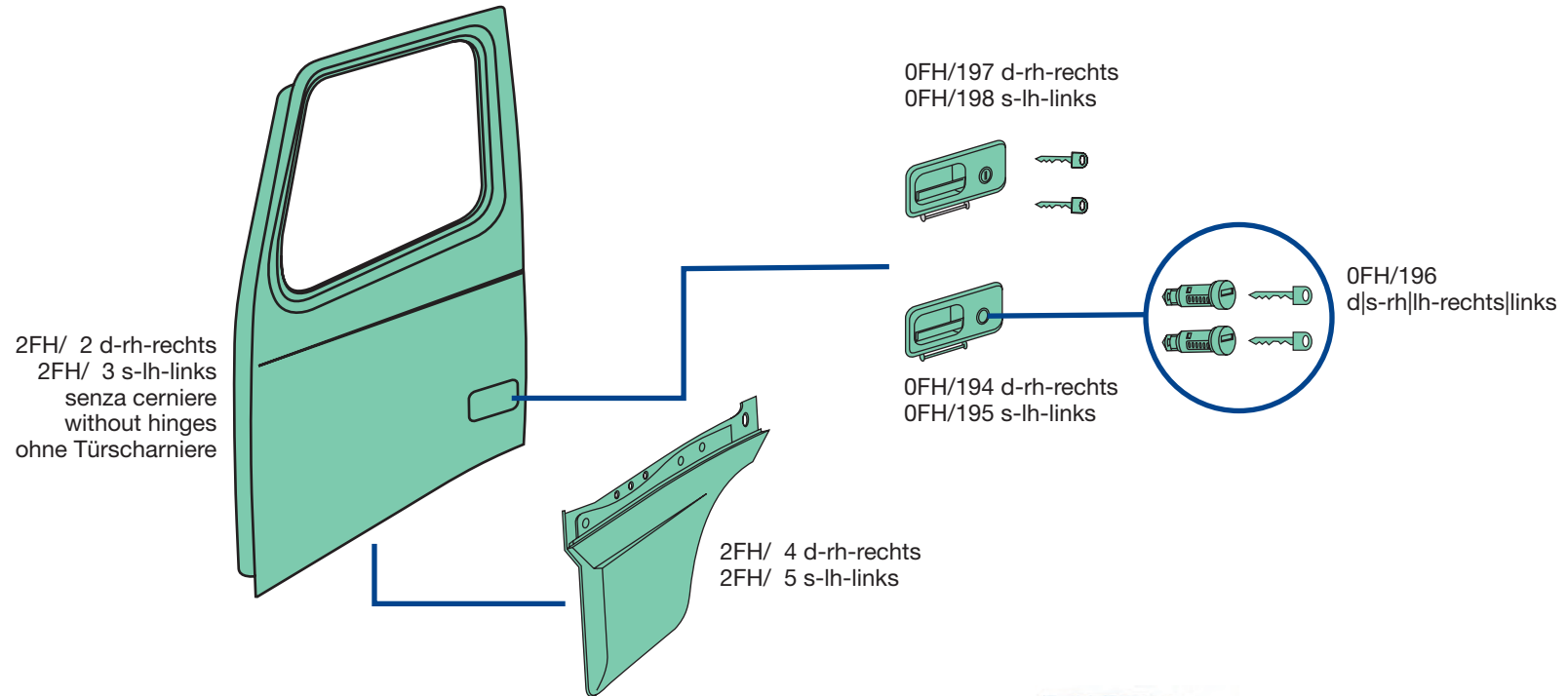

0FH/194
O.E.M. 20398467
0FH/195
O.E.M. 20398466



0FH/196
O.E.M. 3090484



0FH/197
O.E.M. -
0FH/198
O.E.M. -



2FH/ 2
O.E.M. 20360543
2FH/ 3
O.E.M. 20360542



2FH/ 4
O.E.M. 21300059
2FH/ 5
O.E.M. 21299955

applicabile a I suitable to I verwendbar für:

FH12-FH16 SECONDA SERIE | SECOND SERIES | ZWEITE SERIE



3FH/502



II (E4) 024111
200x435 mm



IV (E4) 024112
176x188 mm

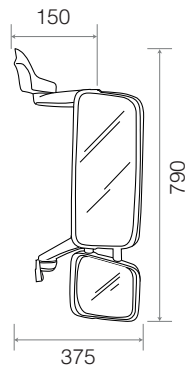

applicabilità:
applicable to:
Verwendbar für

VOLVO FH II 2002 →
VOLVO FM II 2002 →

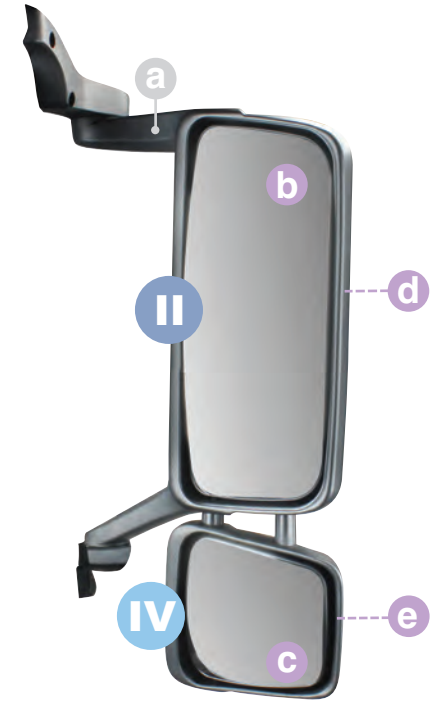























COVIND

II
2FH/500



249x231 mm

IV

<p>a -</p>	<p>-</p>	
<p>b 2FH/503 II</p>	<p>21320404 (20589788)</p>	      <p style="text-align: right;">E4 024111 200x435 mm</p>
<p>c 2FH/504 IV</p>	<p>21320300 (20567685) (20455995)</p>	      <p style="text-align: right;">E4 024112 176x188 mm</p>
<p>d 2FH/502 II</p>	<p>20746401</p>	     <p style="text-align: right;">187x435 mm</p>
<p>e 2FH/508 IV</p>	<p>20360811</p>	     <p style="text-align: right;">250x200 mm</p>

applicabile a I suitable to I verwendbar für:

FH12-FH16 SECONDA SERIE | SECOND SERIES | ZWEITE SERIE



3FH/503

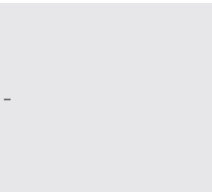

II (E4) 024111
200x435 mm



IV (E4) 024112
176x188 mm



applicabilità:
applicable to:
Verwendbar für

VOLVO FH II 2002 →
VOLVO FM II 2002 →

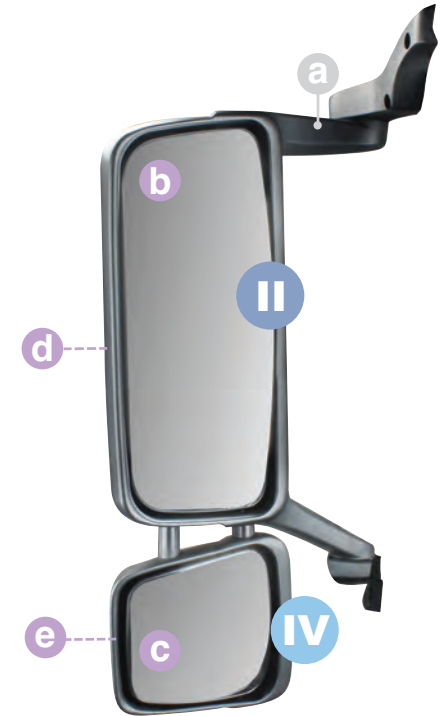
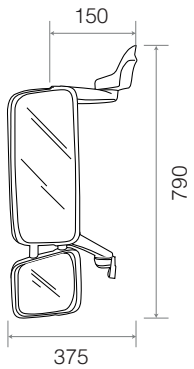

COVIND

II
2FH/501
IV

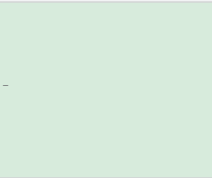

250x235 mm

-	-				
b 2FH/503 II	21320404 (20589788)			E4 024111 200x435 mm	
c 2FH/504 IV	21320300 (20567685) (20455995)			E4 024112 176x188 mm	
d 2FH/502 II	20746401			187x435 mm	
e 2FH/508 IV	20360811			250x200 mm	

applicabile a I suitable to I verwendbar für:

FH12-FH16 | SECONDA SERIE | SECOND SERIES | ZWEITE SERIE

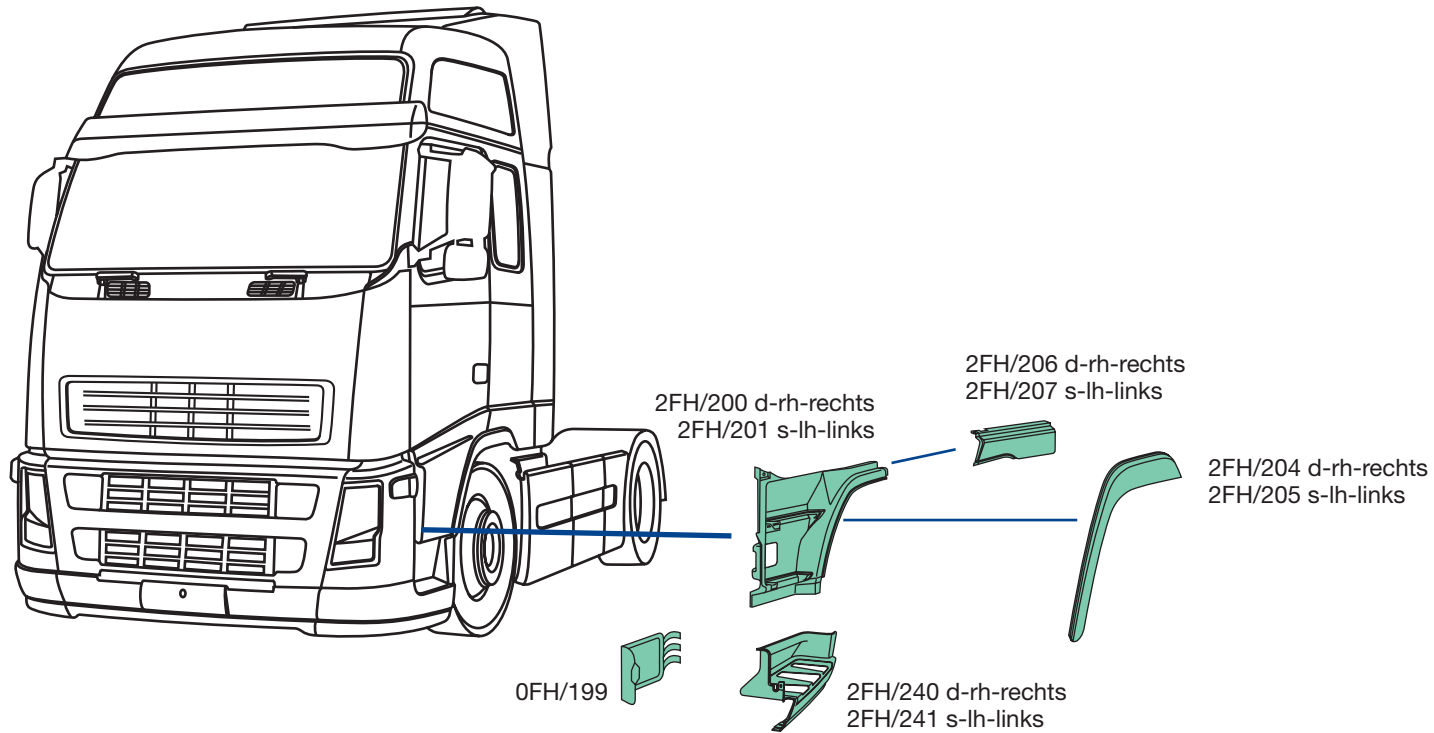

0FH/199
O.E.M. 20529765



2FH/200
O.E.M. 3175928
2FH/201
O.E.M. 3175927



2FH/204
O.E.M. 20529684
2FH/205
O.E.M. 20529682



2FH/206
O.E.M. 21302470
2FH/207
O.E.M. 21302461



2FH/240
O.E.M. 20529640
2FH/241
O.E.M. 20529638

FH12-FH16 SECONDA SERIE | SECOND SERIES | ZWEITE SERIE

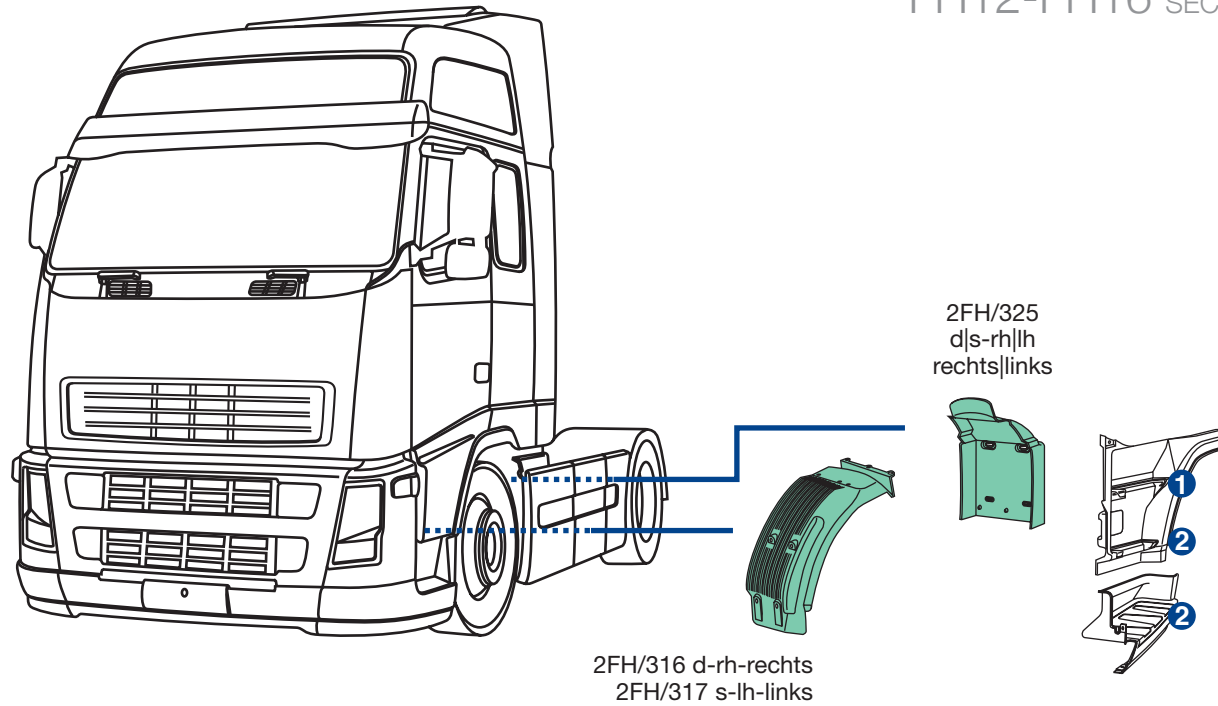

0FH/210
O.E.M. 20379439



2FH/208
O.E.M. 20360789
2FH/209
O.E.M. 20360788



2FH/316
O.E.M. 20372065
2FH/317
O.E.M. 20372064



2FH/325
O.E.M. 20453900

FH12-FH16 SECONDA SERIE | SECOND SERIES | ZWEITE SERIE

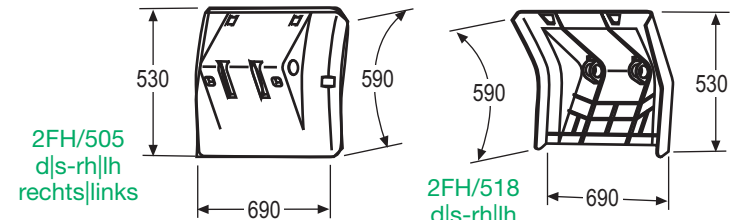
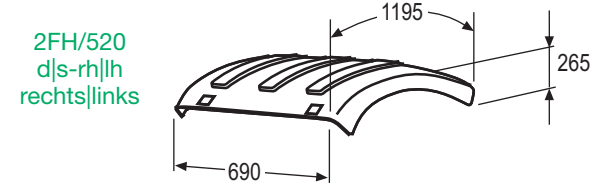
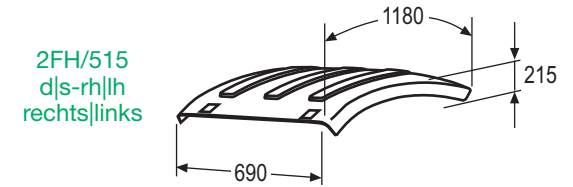
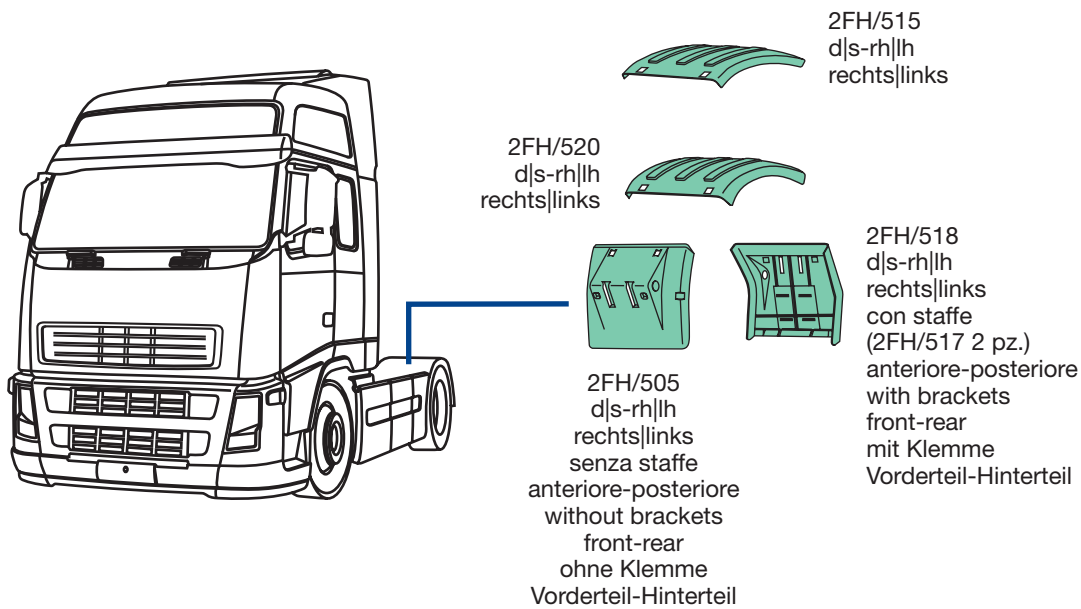

- 2FH/515
- O.E.M. 20936759
- d|s-rh|h-rechts|links
- grigio, semipiatta, senza cinghietti
- grey, semi-flat, without stretchers
- grau, halbfach, ohne Spanngummi



- 2FH/518
- O.E.M. 20392599
- d|s-rh|h-rechts|links
- grigio, senza anti-spray, con staffe
- grey, without anti-spray, with brackets
- grau, ohne Spritzschutz, mit Klemme

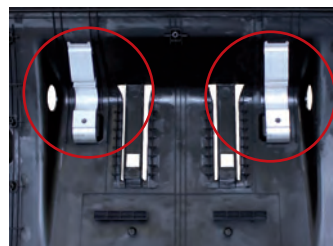

- 2FH/520
- O.E.M. 20936769
- d|s-rh|h-rechts|links
- grigio, circolare, senza cinghietti
- grey, circular, without stretchers
- grau, kreisförmig, ohne Spanngummi



2FH/518

- 2FH/505
- O.E.M. 20392544
- d|s-rh|h-rechts|links
- grigio, senza staffe
- grey, without brackets
- grau, ohne Klemme



2FH/505

applicabile a I suitable to I verwendbar für:

FH12-FH16 SECONDA SERIE | SECOND SERIES | ZWEITE SERIE

(*) Applicabile con il cinghietto 2FH/510
Applied with stretcher 2FH/510
bestückt mit 2FH/510

(°) Applicabile con il cinghietto PRM/515
Applied with stretcher PRM/515
bestückt mit PRM/515

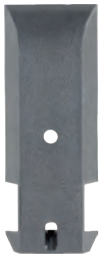
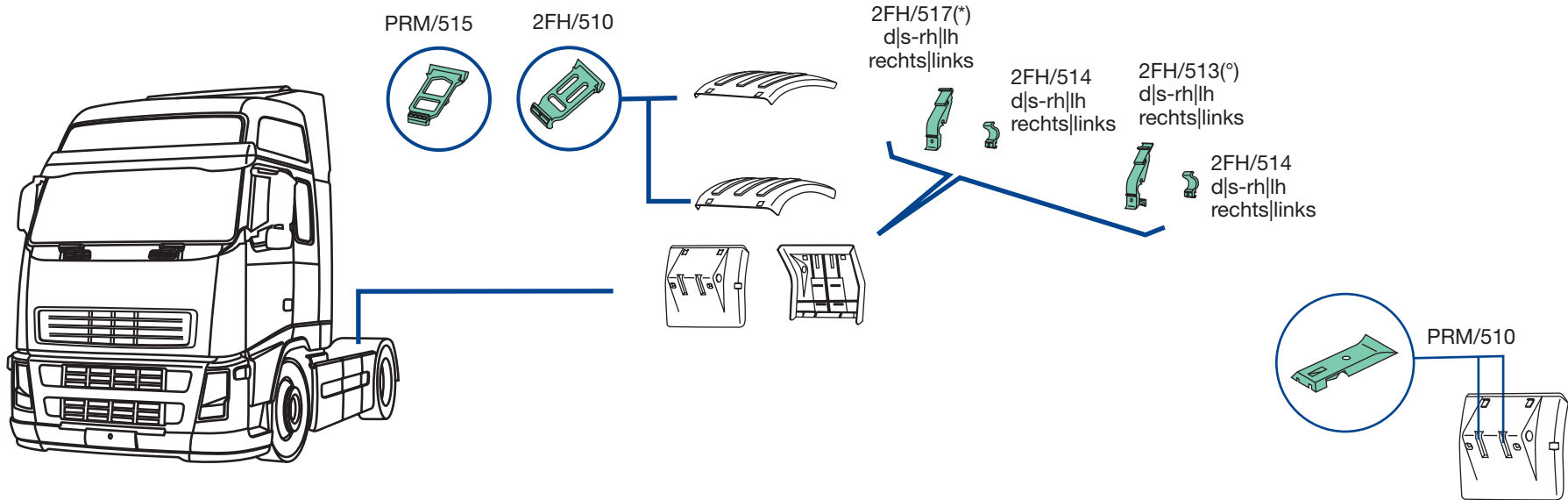

PRM/510
O.E.M. 20721840



PRM/515
O.E.M. 20498623



2FH/510
O.E.M. 1079981



2FH/513
O.E.M. 20583434



2FH/514
O.E.M. 20583440



2FH/517
O.E.M. 3987252

(*) adattabile a 2FH/505
suitable to 2FH/505
passend für 2FH/505

FH12-FH16 SECONDA SERIE | SECOND SERIES | ZWEITE SERIE

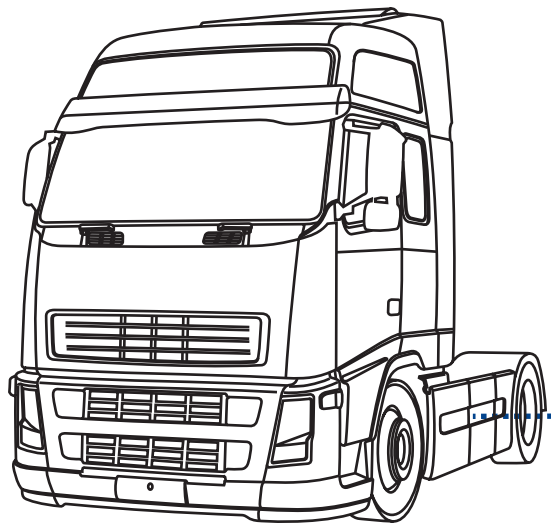

OFH/522 (*)

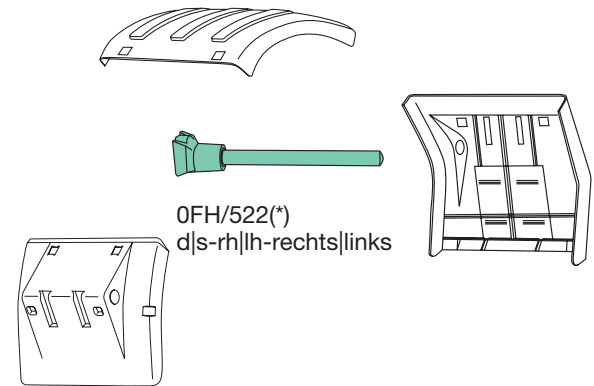
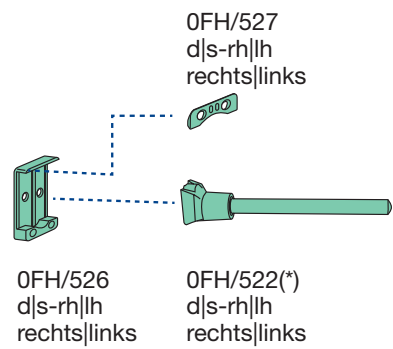
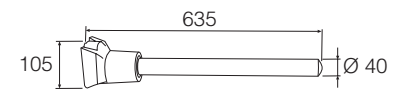

OFH/522
O.E.M. 20466894



OFH/526
O.E.M. 20382890



OFH/527
O.E.M. 20383038

applicabile a I suitable to I verwendbar für:

FH12-FH16 SECONDA SERIE | SECOND SERIES | ZWEITE SERIE



0FH/520
d|s-rh|lh
rechts|links

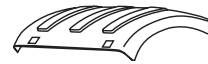

0FH/521
d|s-rh|lh
rechts|links

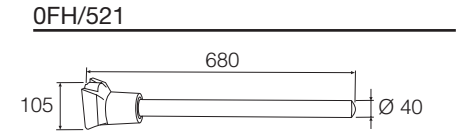
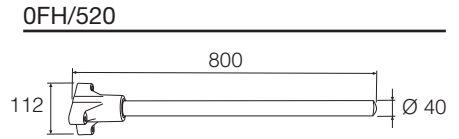
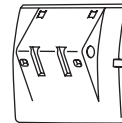
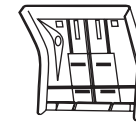

0FH/520
O.E.M. 8154385



0FH/521
O.E.M. 20466895

FH12-FH16 SECONDA SERIE | SECOND SERIES | ZWEITE SERIE

(*) adattabile a 2FH/505-PRM/516-PRM/517-PRM/518-PRM/519-2FH/505
suitable to 2FH/505-PRM/516-PRM/517-PRM/518-PRM/519-2FH/505
passend für 2FH/505-PRM/516-PRM/517-PRM/518-PRM/519-2FH/505

(°) adattabile a PRM/514-2FH/505-2FH/518
suitable to PRM/514-2FH/505-2FH/518
passend für PRM/514-2FH/505-2FH/518

PRM/496 (*)
605

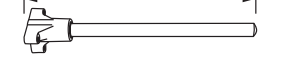

PRM/497 (°)
680

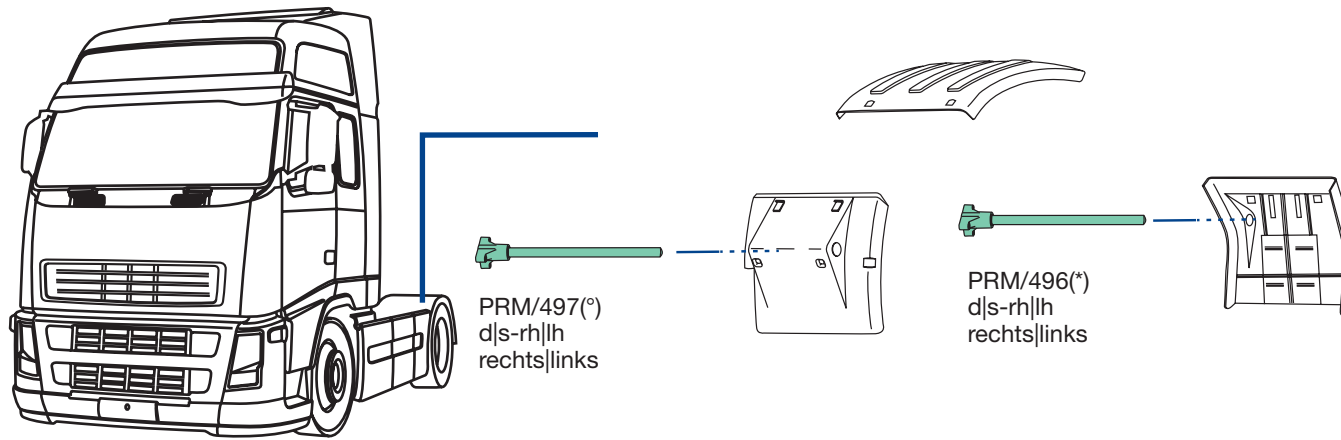
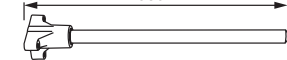

PRM/496
O.E.M. 21011688



PRM/497
O.E.M. 1079959

applicabile a l suitable to l verwendbar für:

FH12-FH16 SECONDA SERIE | SECOND SERIES | ZWEITE SERIE

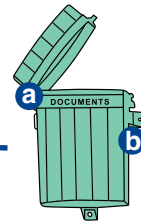
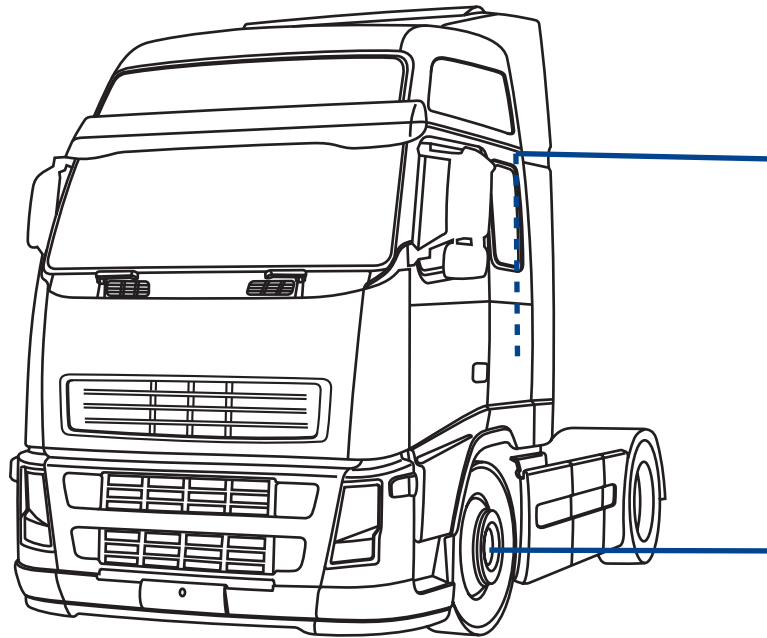

PDS/360

930/033

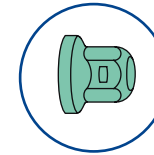

930/001
d-rh-rechts
930/002
s-lh-links

930/200
d|s-rh|lh
rechts|links

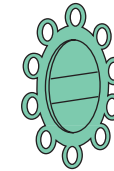

930/100
d-rhrechts
930/101
s-lh-links

PDS/360

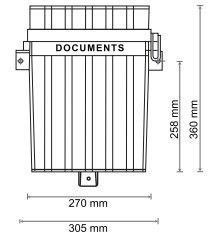

930/033
O.E.M. -



930/001
O.E.M. -
930/002
O.E.M. -



930/100
O.E.M. -
930/101
O.E.M. -



930/200
O.E.M. -



PDS/360
O.E.M. -

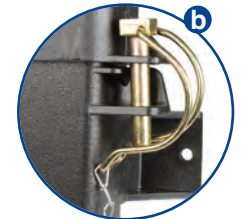

FH12-FH16 SECONDA SERIE | SECOND SERIES | ZWEITE SERIE

930/033-Tappo copri Bullone-Bolt cover-Radmutterkappen

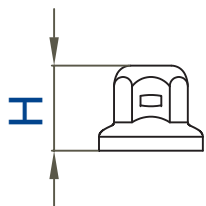

H	45 mm
Per bulloni \varnothing - bolt \varnothing	33 mm
Schlüsselweite \varnothing	
Colore	cromato-chrome-verchromt
Colours-Farbe	
Materiale-Material	acciaio inox-stainless steel
	Edelstahl
Kg	0,025

930/001 d-rh-rechts | 930/002 s-lh-links

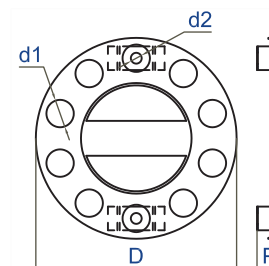

D \varnothing 425 mm	P 50 mm
d1 nr. 10	d1 \varnothing 58 mm
d2 nr. 2	d2 \varnothing 23 mm
Ventilata	si-yes-Ja
Ventilated-Belüftet	
Colore	cromato e nero-chrome and black
Colours-Farbe	verchromt und schwarz
Materiale-Material	acciaio inox e plastica
	stainless steel and plastic
	Edelstahl und Kunststoff
Kg	1,230

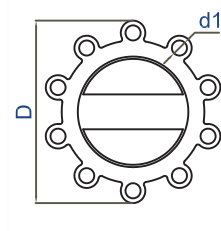

930/100 d-rh-rechts | 930/101 s-lh-links

D \varnothing 387 mm	P 30 mm
d1 nr. 10	d1 \varnothing 32 mm
Ventilata	si-yes-Ja
Ventilated-Belüftet	
Colore	cromato e nero-chrome and black
Colours-Farbe	verchromt und schwarz
Materiale-Material	acciaio inox e plastica
	stainless steel and plastic
	Edelstahl und Kunststoff
Kg	0,655

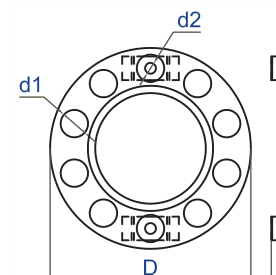

930/200 d|s-rh|lh-rechts+links

D \varnothing 425 mm	P 40 mm
d1 nr. 10	d1 \varnothing 58 mm
d2 nr. 2	d2 \varnothing 23 mm
Ventilata	no-nein
Ventilated-Belüftet	
Colore	cromato-chrome-verchromt
Colours-Farbe	
Materiale-Material	acciaio inox-stainless steel
	Edelstahl
Kg	1,155

applicabile a | suitable to | verwendbar für:

FH12-FH16 SECONDA SERIE | SECOND SERIES | ZWEITE SERIE

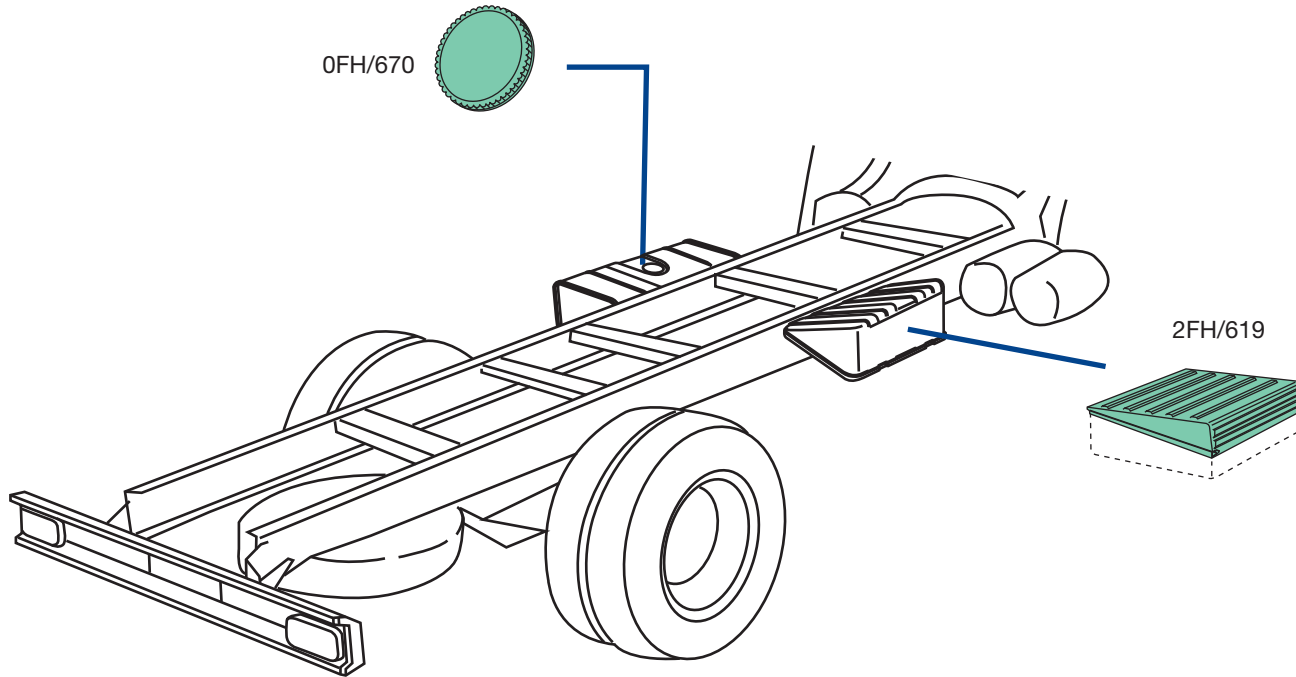

0FH/670

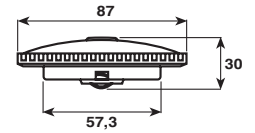

2FH/619

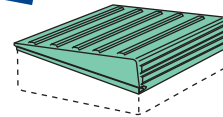

0FH/670
O.E.M. 9520400



2FH/619
O.E.M. 20507252



applicabile a | suitable to | verwendbar für 203

OFH FH12-FH16

PRIMA SERIE | FIRST SERIES | ERSTE SERIE

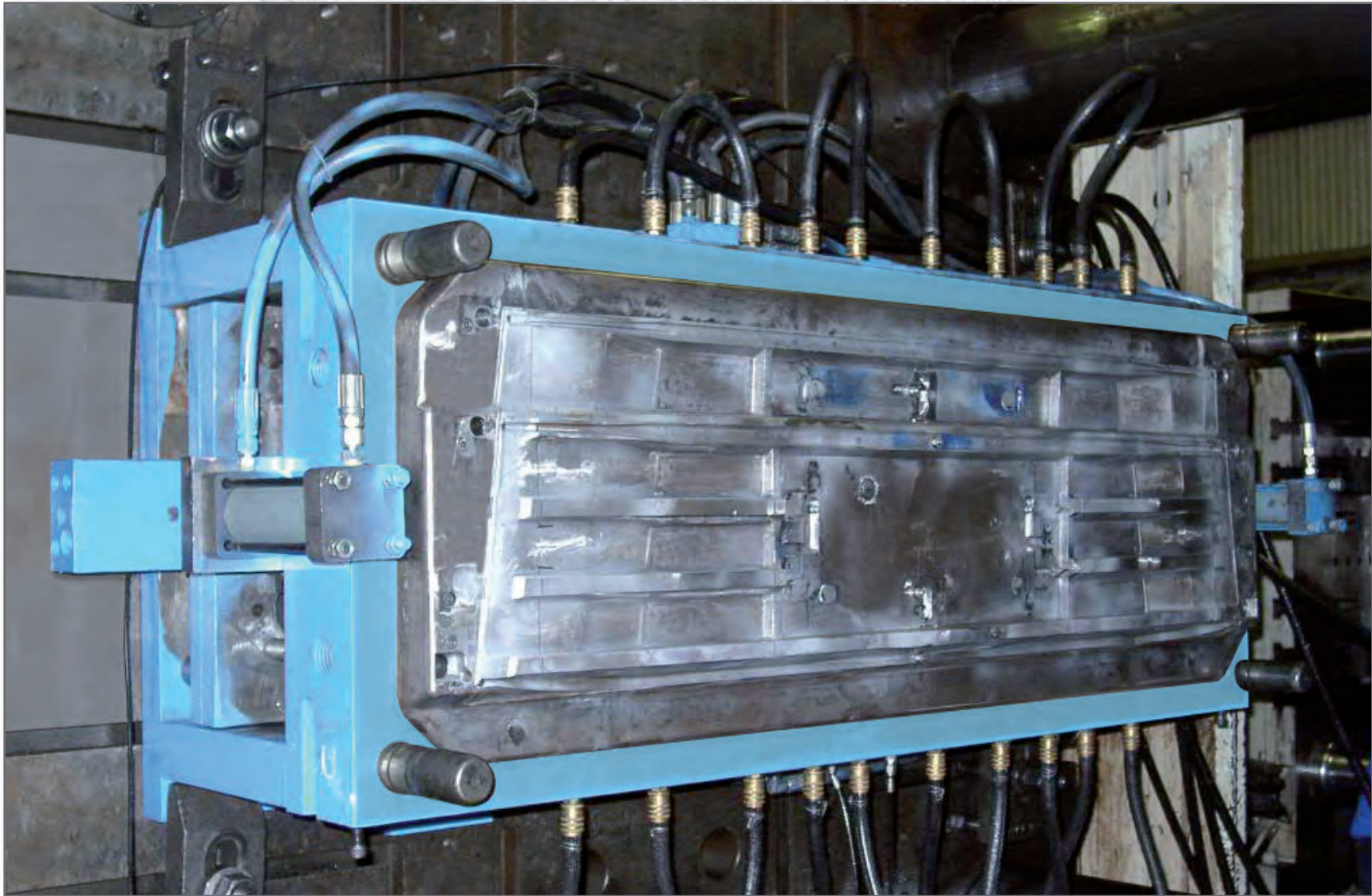

IT Stampo a iniezione per la produzione della griglia inferiore per il Volvo
EN Injection mould for the production of the lower grille for the Volvo
DE Spritzgußform für die Volvo FH Grill Produktion

FH12-FH16 PRIMA SERIE | FIRST SERIES | ERSTE SERIE



OFH/ 90
O.E.M. 8189329



OFH/ 92
O.E.M. 20372227
OFH/ 93
O.E.M. 20372226



OFH/ 96
O.E.M. 8152722



OFH/650
O.E.M. 1062190

applicabile a | suitable to | verwendbar für:

FH12-FH16 PRIMA SERIE | FIRST SERIES | ERSTE SERIE



OFH/400

O.E. 8189318 | 8140923

Adattabile a:
Suitable to:
passend für:

FH12 - FH16 - FM12

Materiale | Material:
PMMA - ACRYLGLAS



KIT completo di staffe e minuterie
IN ALLESTIMENTO
KIT complete of brackets and findings
NOT AVAILABLE YET
Befestigungssatz
IN ARBEIT

L	H	P	kg.
cm.	cm.	cm.	
224	28,5	20	2,630



FH12-FH16 PRIMA SERIE | FIRST SERIES | ERSTE SERIE

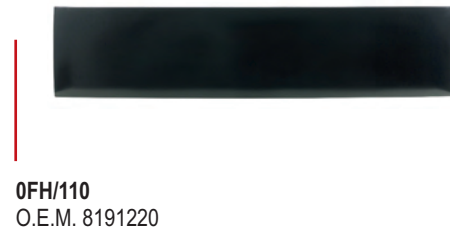
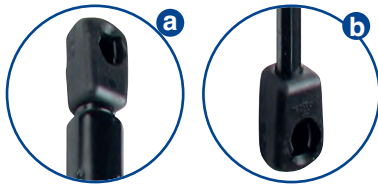
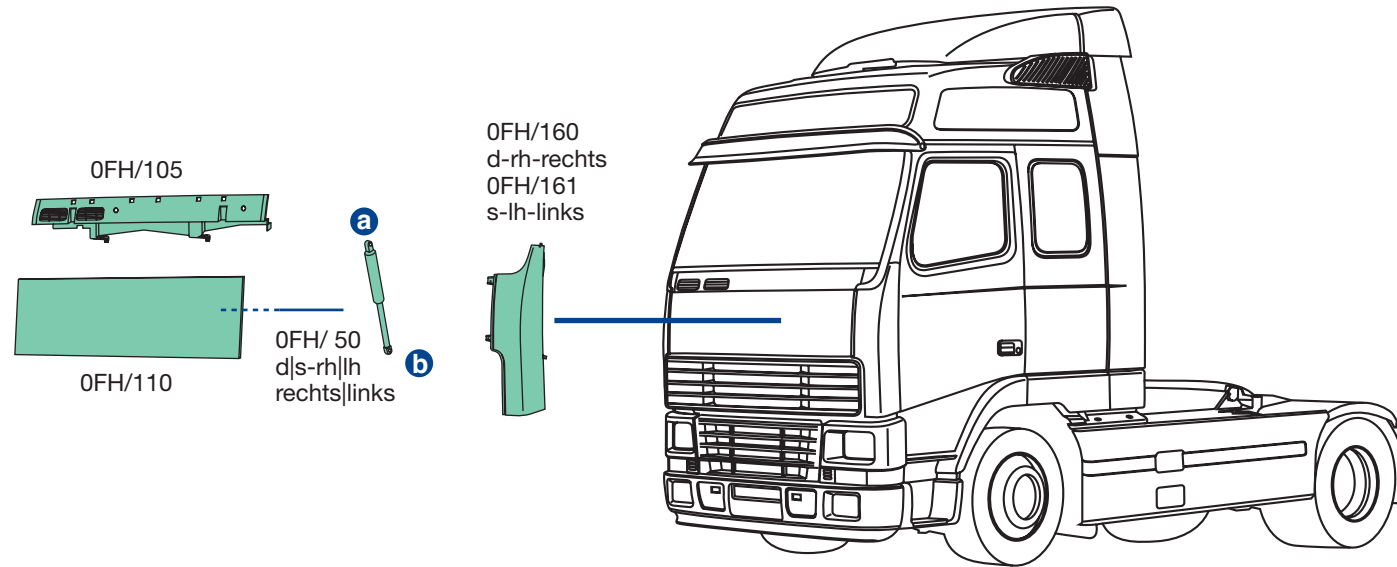

applicabile a I suitable to I verwendbar für:

FH12-FH16 PRIMA SERIE | FIRST SERIES | ERSTE SERIE

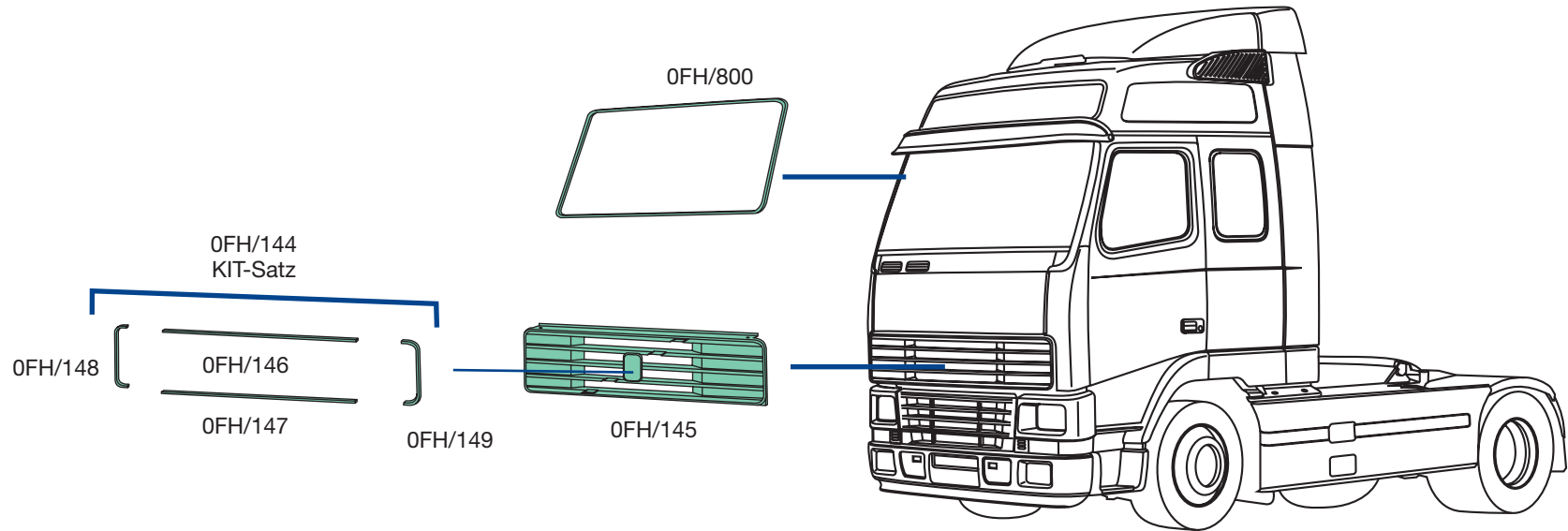

OFH/145
O.E.M. 20360507



OFH/146
O.E.M. 8144524
OFH/147
O.E.M. 8144525



OFH/148
O.E.M. 8144525
OFH/149
O.E.M. 8144526



OFH/800
O.E.M. 1619254

FH12-FH16 PRIMA SERIE | FIRST SERIES | ERSTE SERIE

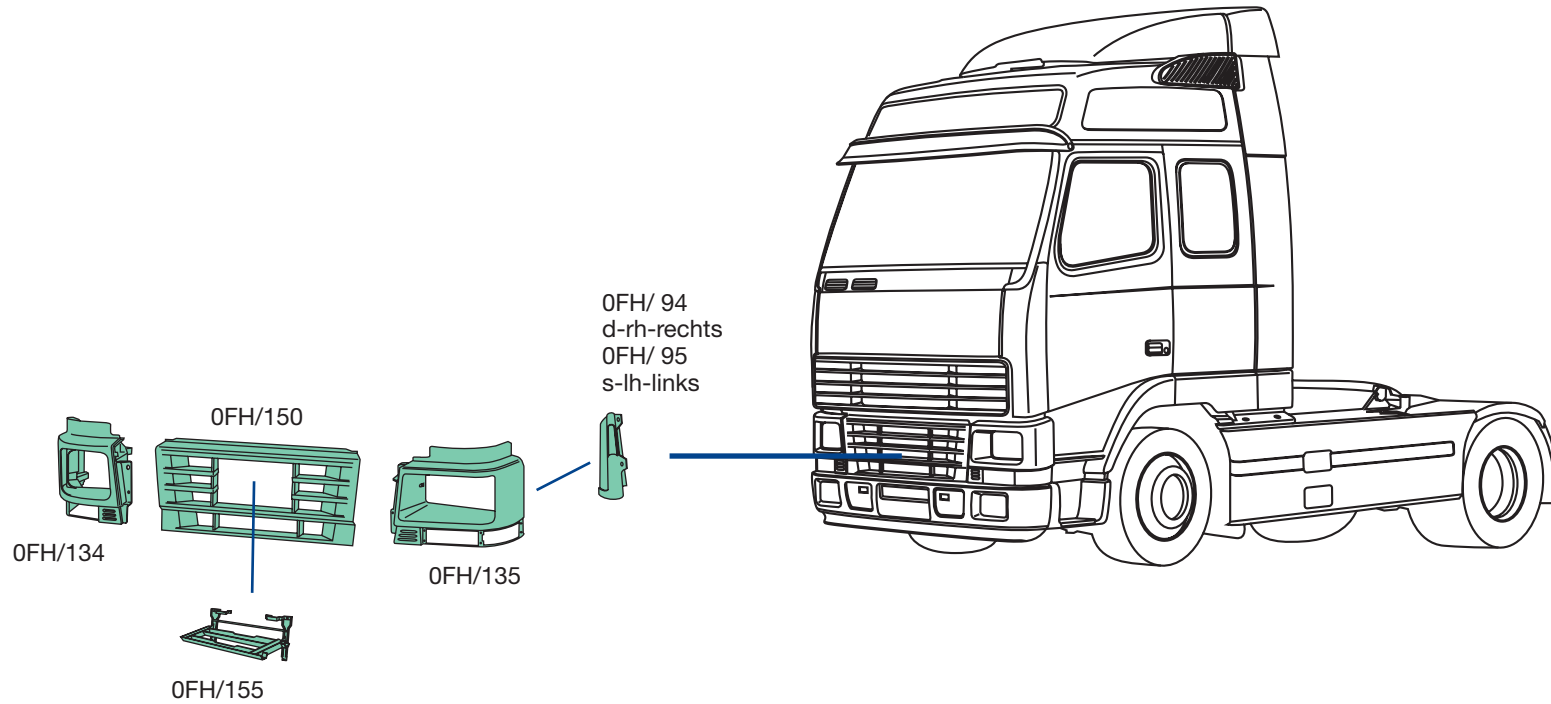

OFH/134
O.E.M. 20398386
OFH/135
O.E.M. 20398389



OFH/ 94
O.E.M. 8141290
OFH/ 95
O.E.M. 8141289



OFH/150
O.E.M. 1063509



OFH/155
O.E.M. 3175863

applicabile a I suitable to I verwendbar für:

FH12-FH16 PRIMA SERIE | FIRST SERIES | ERSTE SERIE

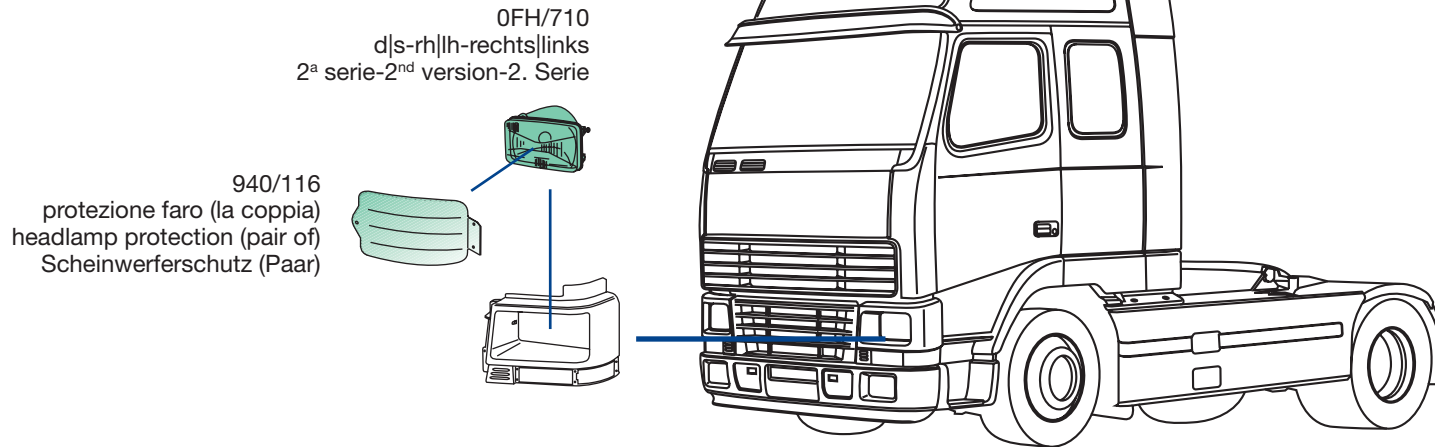

0FH/710
O.E.M. 3981593



940/116
O.E.M. -

FH12-FH16 PRIMA SERIE | FIRST SERIES | ERSTE SERIE

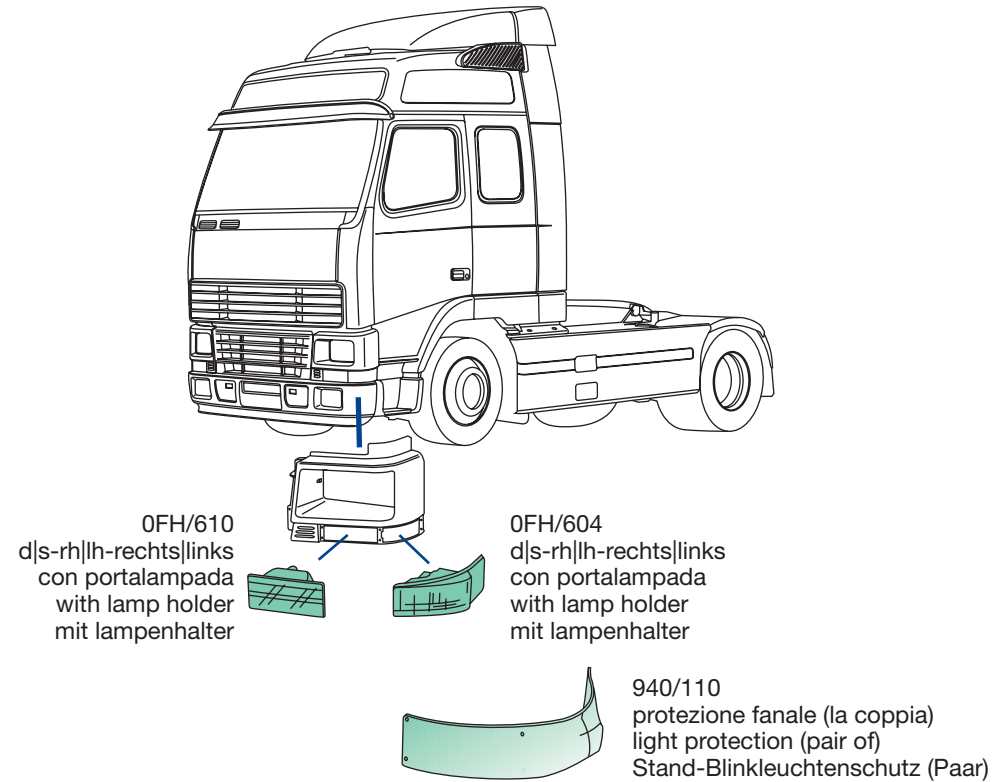

OFH/604
O.E.M. 3981668



OFH/610
O.E.M. 3981666



940/110
O.E.M. -

applicabile a I suitable to I verwendbar für:

FH12-FH16 PRIMA SERIE | FIRST SERIES | ERSTE SERIE



0FH/508



II

E4 024109

198x433 mm



IV

E4 024110

181x175 mm

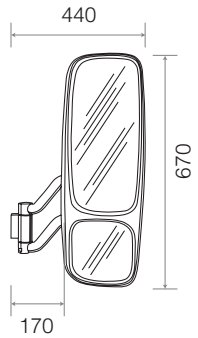

applicabilità:
applicable to:
Verwendbar für

VOLVO FH 1993→2002
VOLVO FM 1998→2002



II

IV

a	OFH/512	3091751			240x250 mm
b	OFH/506	20854564 (3092854)			E4 024109
	II				198x433 mm
c	OFH/507	21203311			E4 024110
	IV				181x175 mm

applicabile a I suitable to I verwendbar für:

FH12-FH16 PRIMA SERIE | FIRST SERIES | ERSTE SERIE



0FH/509

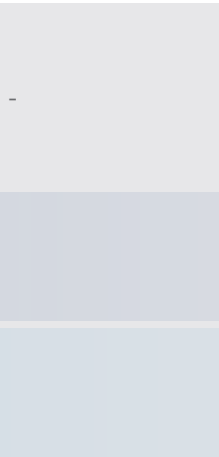

II (E4) 024109
198x433 mm



IV (E4) 024110
181x175 mm

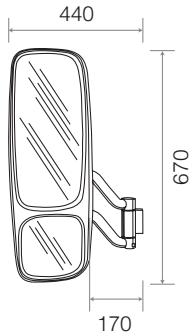

applicabilità:
applicable to:
Verwendbar für







VOLVO FH 1993→2002
VOLVO FM 1998→2002



COVIND

II

IV

<p>a 0FH/513</p>	<p>3091750</p>			<p>240x250 mm</p>
<p>b 0FH/506 II</p>	<p>20854564 (3092854)</p>			<p>E4 024109 198x433 mm</p>
<p>c 0FH/507 IV</p>	<p>21203311</p>			<p>E4 024110 181x175 mm</p>

applicabile a l suitable to l verwendbar für:

FH12-FH16 PRIMA SERIE | FIRST SERIES | ERSTE SERIE

2FH/ 6 d-rh-rechts
2FH/ 7 s-lh-links

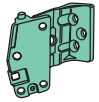

2FH/ 9
d|s-rh|lh
rechts|links

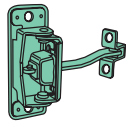

2FH/ 10
d|s-rh|lh
rechts|links

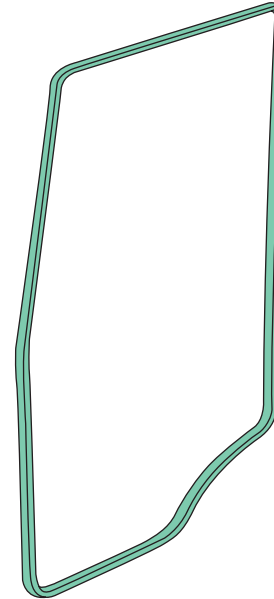
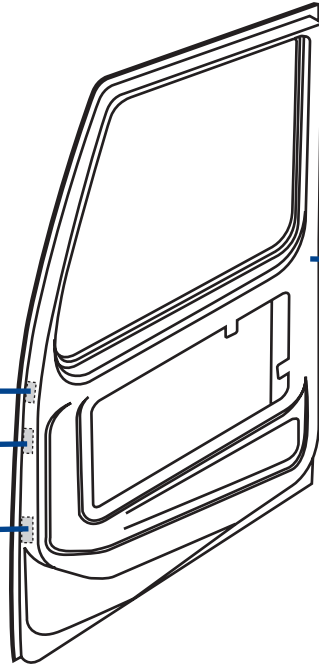
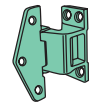

0FH/190

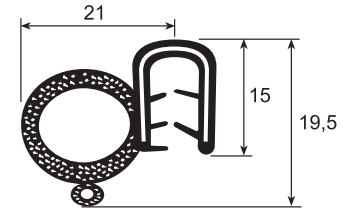

0FH/190



2FH/ 6
O.E.M. 20398136
2FH/ 7
O.E.M. 20398135

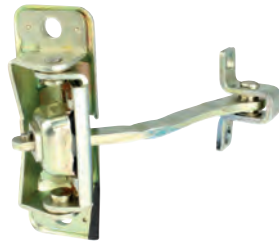

2FH/ 9
O.E.M. 1062636



2FH/ 10
O.E.M. 20372039



0FH/190
O.E.M. 3175029

FH12-FH16 PRIMA SERIE | FIRST SERIES | ERSTE SERIE

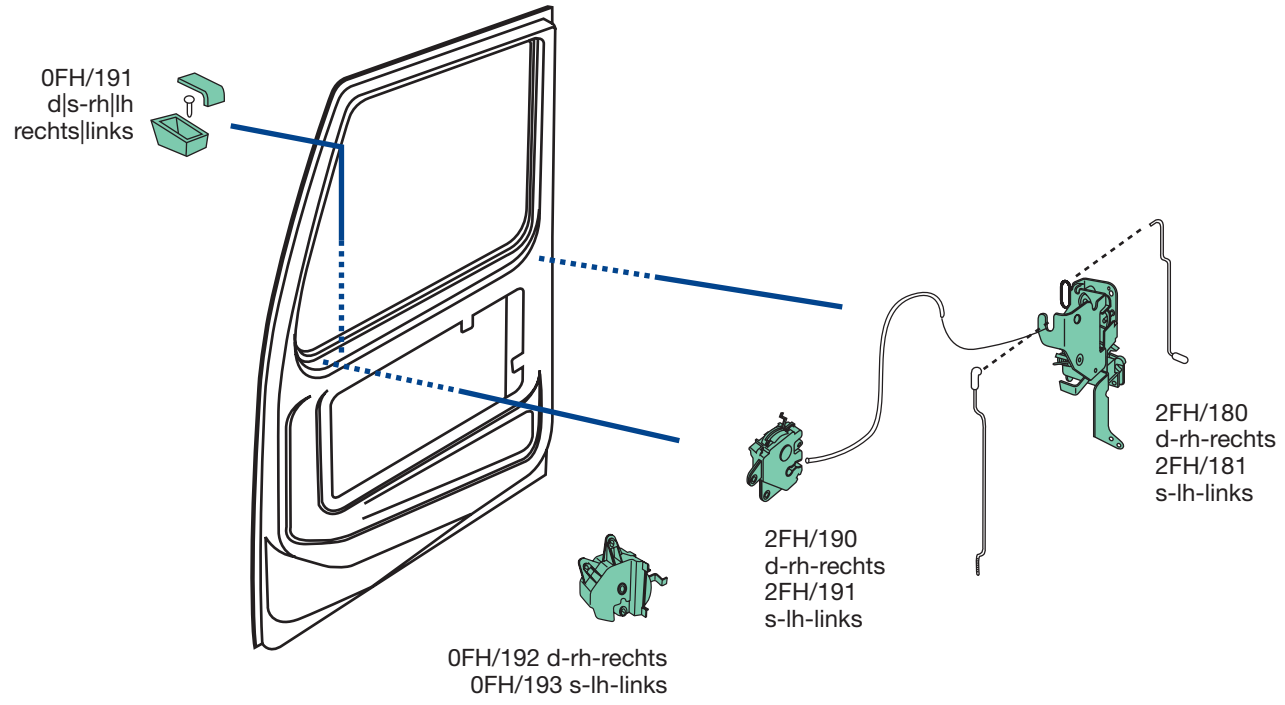

0FH/191
O.E.M. 20379593



0FH/192
O.E.M. 1063328
0FH/193
O.E.M. 1063327



2FH/180
O.E.M. 21505894
2FH/181
O.E.M. 21505893



2FH/190
O.E.M. 20570722
2FH/191
O.E.M. 20570721

applicabile a l suitable to l verwendbar für:

FH12-FH16 PRIMA SERIE | FIRST SERIES | ERSTE SERIE

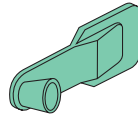
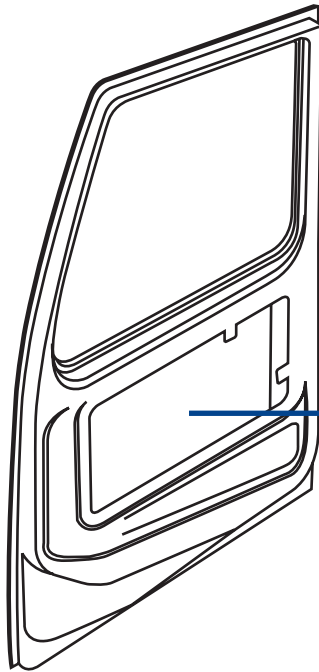

OFH/166
d|s-rh|lh-rechts|links

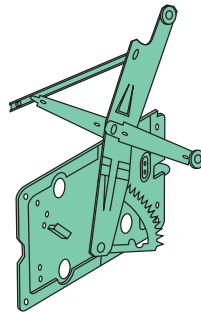

OFM/174 d-rh-rechts
OFM/175 s-lh-links
elettrico, senza motorino
electric, without motor
elektrisch, ohne Motor

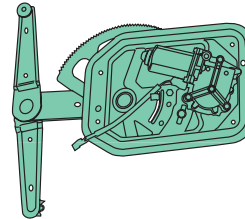

OFH/164 d-rh-rechts
OFH/165 s-lh-links
elettrico, con motorino
electric, with motor
elektrisch, mit Motor

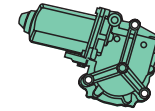

OFH/168 d-rh-rechts
OFH/169 s-lh-links



OFM/174
O.E.M. -
OFM/175
O.E.M. -



IN ALLESTIMENTO::NOT AVAILABLE YET::IN ARBEIT

OFH/164
O.E.M. 3176542
OFH/165
O.E.M. 3176541



OFH/166
O.E.M. 1606375



IN ALLESTIMENTO::NOT AVAILABLE YET::IN ARBEIT

OFH/168
O.E.M. 3176550
OFH/169
O.E.M. 3176549

FH12-FH16 PRIMA SERIE | FIRST SERIES | ERSTE SERIE

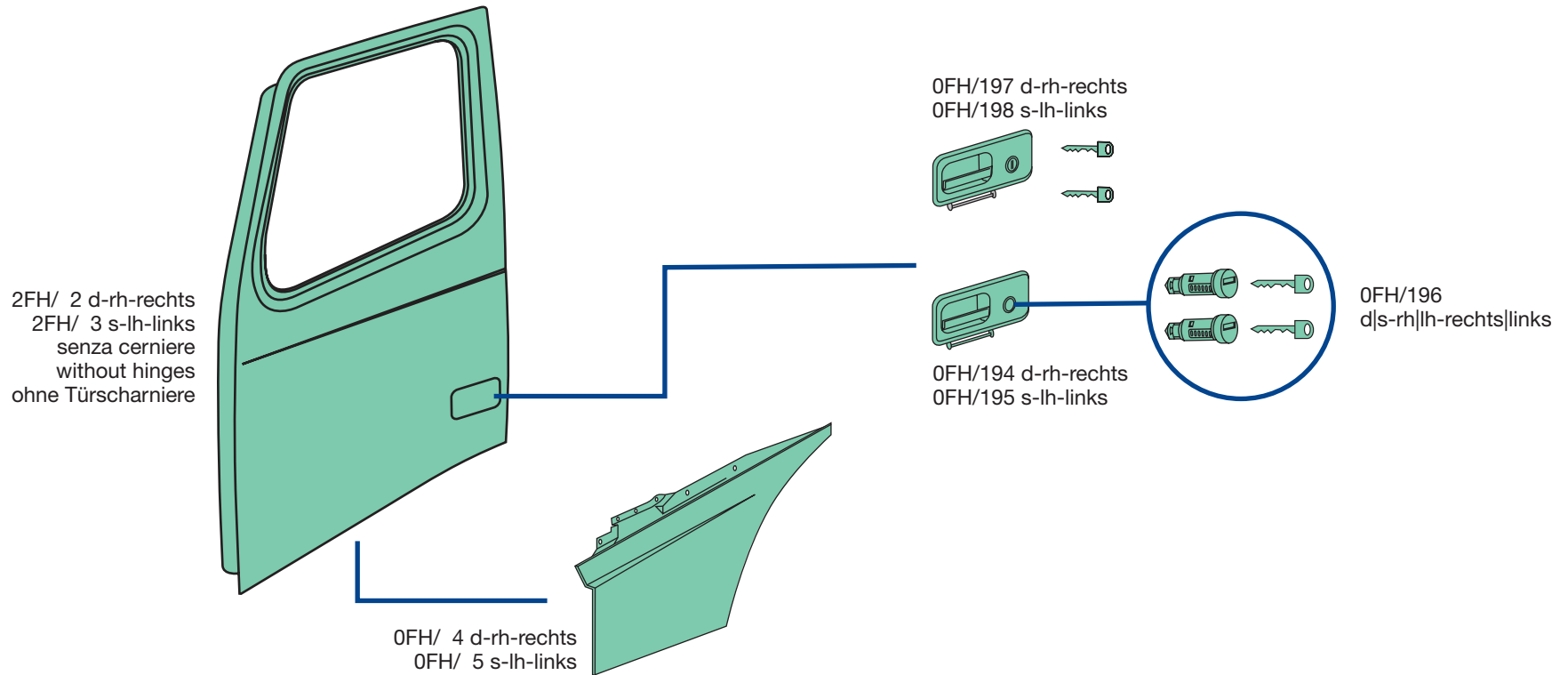

OFH/ 4
O.E.M. 20398908
OFH/ 5
O.E.M. 20398907

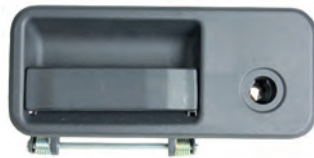

OFH/194
O.E.M. 20398467
OFH/195
O.E.M. 20398466



OFH/196
O.E.M. 3090484



OFH/197
O.E.M. -
OFH/198
O.E.M. -



2FH/ 2
O.E.M. 20360543
2FH/ 3
O.E.M. 20360542

applicabile a | suitable to | verwendbar für:

FH12-FH16 PRIMA SERIE | FIRST SERIES | ERSTE SERIE



0FH/920 d-rh-rechts
0FH/921 s-lh-links
con piastre pedana
with step plate
mit Tritt oben + mitte
0FH/212 + 0FH/210

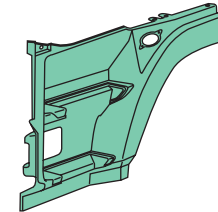
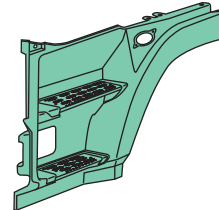

0FH/200 d-rh-rechts
0FH/201 s-lh-links



0FH/200
O.E.M. 8144108



0FH/201
O.E.M. 8144107



0FH/920
O.E.M. -



0FH/921
O.E.M. -

FH12-FH16 PRIMA SERIE | FIRST SERIES | ERSTE SERIE

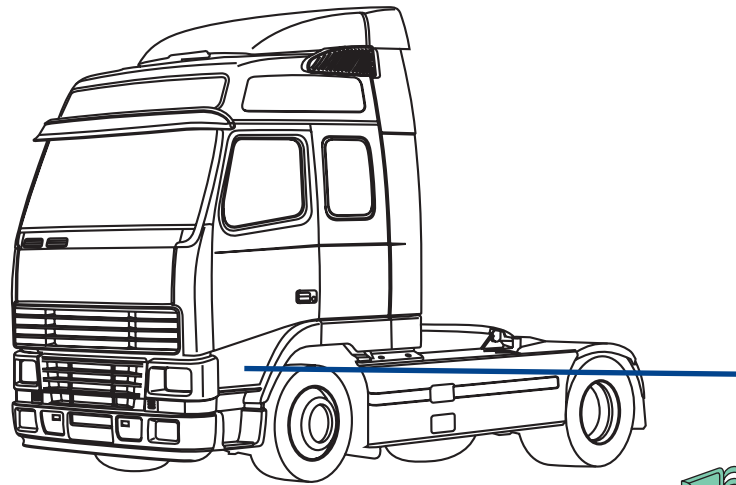

0FH/199

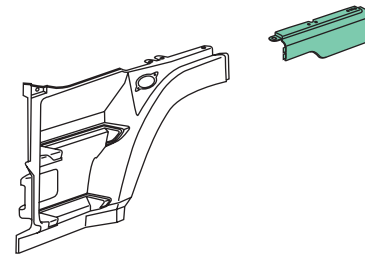

0FH/204 d-rh-rechts
0FH/205 s-lh-links



0FH/240 d-rh-rechts
0FH/241 s-lh-links
guida sinistra
lh drive
Linksenker



0FH/199
O.E.M. 20529765



0FH/204
O.E.M. 8141237
0FH/205
O.E.M. 8141236



0FH/240
O.E.M. 8141004



0FH/241
O.E.M. 8141003

applicabile a l suitable to l verwendbar für:

FH12-FH16 PRIMA SERIE | FIRST SERIES | ERSTE SERIE

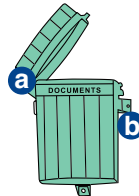
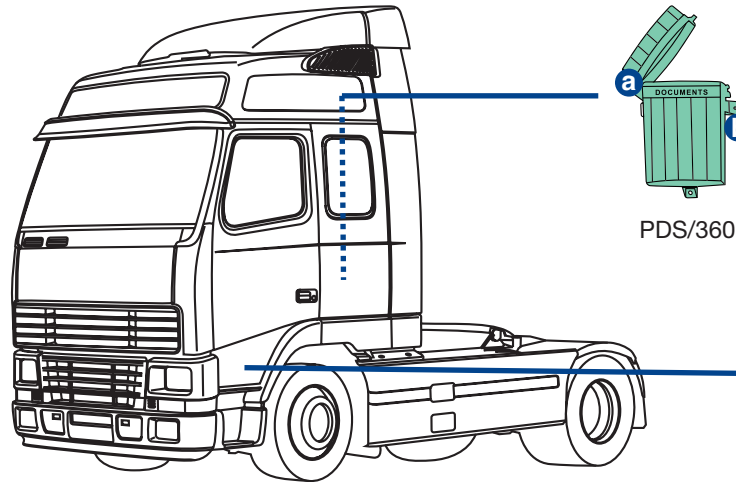

PDS/360

PDS/360

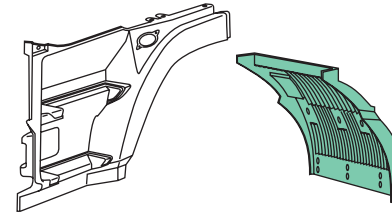
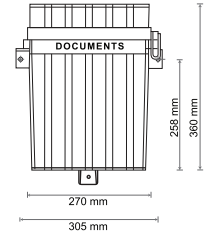

OFH/320 d-rh-rechts
OFH/321 s-lh-links

OFH/242 d-rh-rechts
OFH/243 s-lh-links
guida destra
rh drive
Rechtslenker



OFH/242
O.E.M. 8141313



OFH/243
O.E.M. 8141312



OFH/320
O.E.M. 1623459
OFH/321
O.E.M. 8156540





PDS/360
O.E.M. -

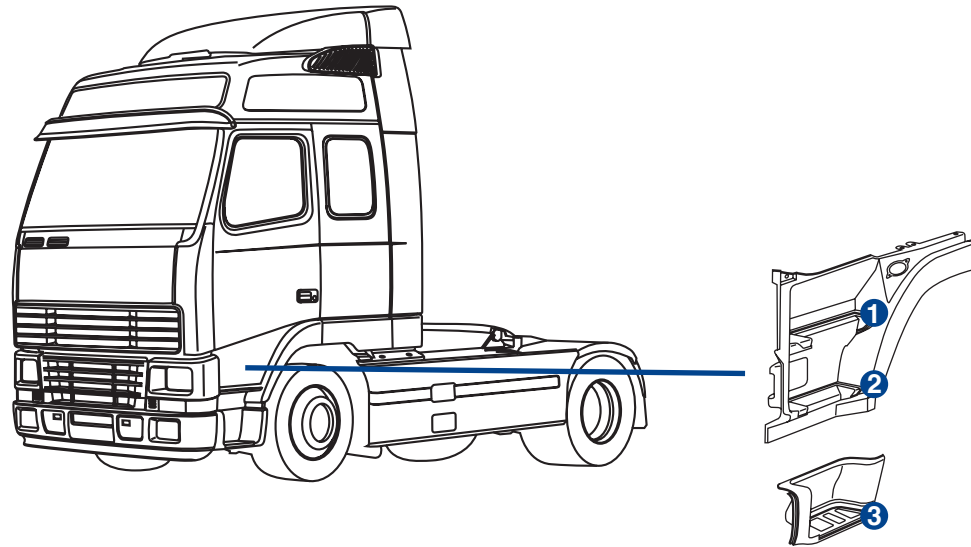

FH12-FH16 PRIMA SERIE | FIRST SERIES | ERSTE SERIE



- 1**  0FH/210
d|s-rh|lh-rechts|links
- 2**  0FH/212
d|s-rh|lh-rechts|links
- 3**  0FH/215
d|s-rh|lh-rechts|links

1



0FH/210
O.E.M. 20379439

2

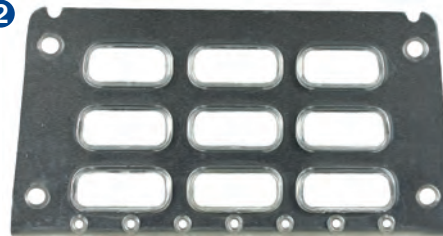

0FH/212
O.E.M. 20379438

3



0FH/215
O.E.M. 20379437

applicabile a I suitable to I verwendbar für:

FH12-FH16 PRIMA SERIE | FIRST SERIES | ERSTE SERIE

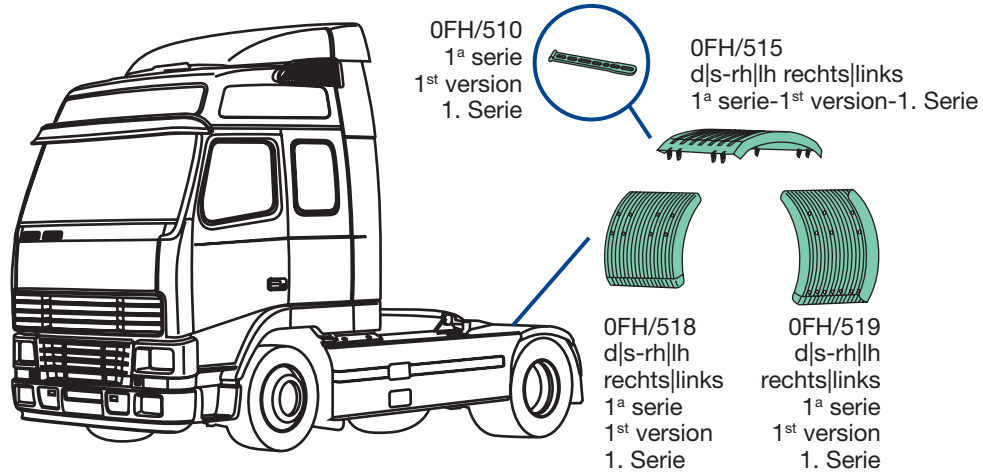

OFH/515
d|s-rh|lh
rechts|links

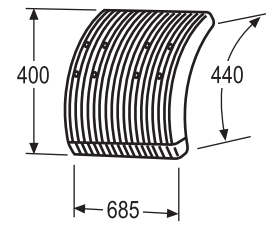
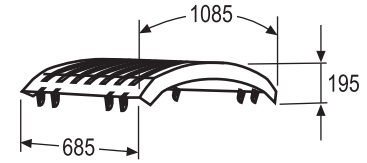

OFH/518
d|s-rh|lh
rechts|links

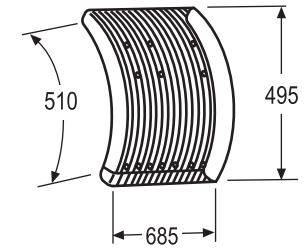

OFH/519
d|s-rh|lh
rechts|links



OFH/510
O.E.M. 8156556

- 0FH/515
- O.E.M. 8190106
- d|s-rh|lh-rechts|links
- nero, semipiatta con 8 cinghietti
- black, semi-flat with 8 stretchers
- schwarz, halbflach mit 8 Spanngummi



- 0FH/519
- O.E.M. 8156554
- d|s-rh|lh-rechts|links
- nero, senza anti-spray
- black, without anti-spray
- schwarz, ohne Spritzschutz



vista esterna - external view
Außenansicht

- 0FH/518
- O.E.M. 8156551
- d|s-rh|lh-rechts|links
- nero-black-schwarz



applicabile a I suitable to I verwendbar für:

FH12-FH16 PRIMA SERIE | FIRST SERIES | ERSTE SERIE

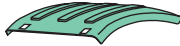

2FH/515
d|s-rh|lh
rechts|links



2FH/520
d|s-rh|lh
rechts|links

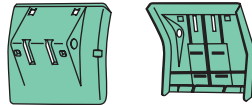

2FH/505
d|s-rh|lh
rechts|links
senza staffe
anteriore|posteriore
without brackets
front|rear
ohne Klemme
Vorderteil|Hinterteil

2FH/518
d|s-rh|lh
rechts|links
con staffe
(2FH/517 2 pz.)
anteriore|posteriore
with brackets
front|rear
mit Klemme
Vorderteil|Hinterteil

2FH/515
d|s-rh|lh
rechts|links

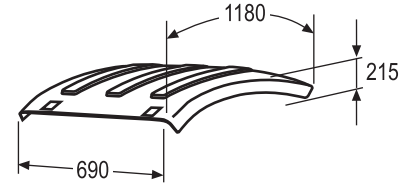

2FH/520
d|s-rh|lh
rechts|links

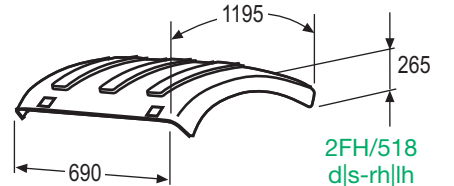

2FH/518
d|s-rh|lh
rechts|links

2FH/505
d|s-rh|lh
rechts|links

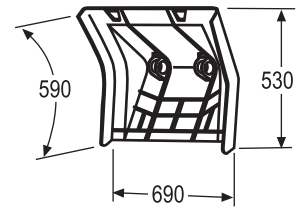
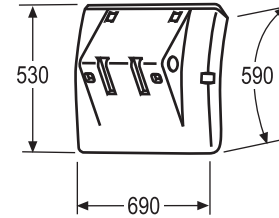

- 2FH/515
- O.E.M. 20936759
- d|s-rh||h-rechts|links
- grigio, semipiatta, senza cinghietti
- grey, semi-flat, without stretchers
- grau, halbfach, ohne Spanngummi



- 2FH/518
- O.E.M. 20392599
- d|s-rh||h-rechts|links
- grigio, senza anti-spray, con staffe
- grey, without anti-spray, with brackets
- grau, ohne Spritzschutz, mit Klemme

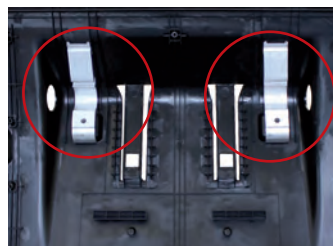

- 2FH/520
- O.E.M. 20936769
- d|s-rh||h-rechts|links
- grigio, circolare, senza cinghietti
- grey, circular, without stretchers
- grau, kreisförmig, ohne Spanngummi



2FH/518

- 2FH/505
- O.E.M. 20392544
- d|s-rh||h-rechts|links
- grigio, senza staffe
- grey, without brackets
- grau, ohne Klemme



2FH/505

applicabile a I suitable to I verwendbar für:

FH12-FH16 PRIMA SERIE | FIRST SERIES | ERSTE SERIE

(*) Applicabile con il cinghietto 2FH/510
Applied with stretcher 2FH/510
bestückt mit 2FH/510

(°) Applicabile con il cinghietto PRM/515
Applied with stretcher PRM/515
bestückt mit PRM/515

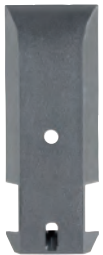
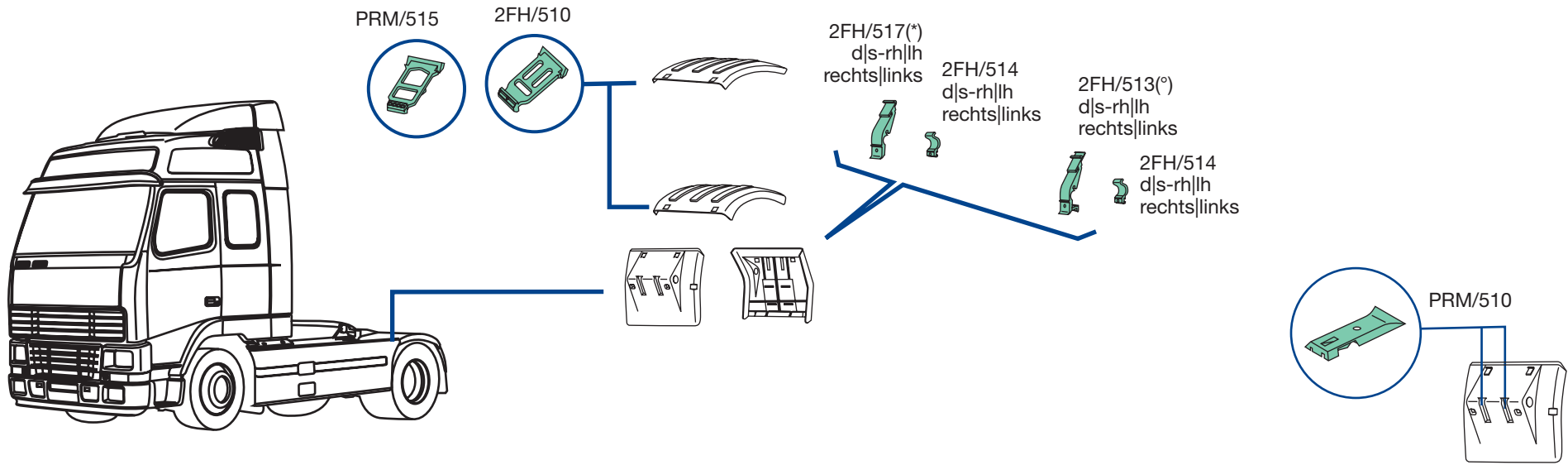

PRM/510
O.E.M. 20721840



PRM/515
O.E.M. 20498623



2FH/510
O.E.M. 1079981



2FH/513
O.E.M. 20583434



2FH/514
O.E.M. 20583440



2FH/517
O.E.M. 3987252

FH12-FH16 PRIMA SERIE | FIRST SERIES | ERSTE SERIE



OFH/520
d|s-rh|h
rechts|links

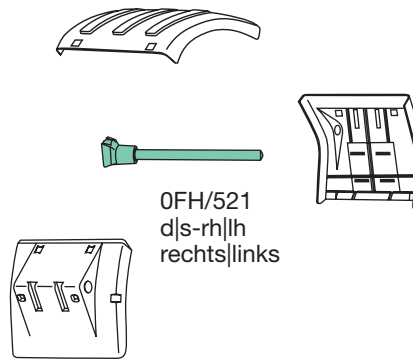

OFH/521
d|s-rh|h
rechts|links

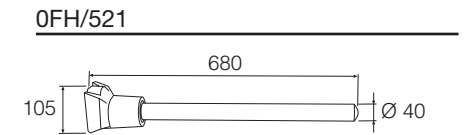
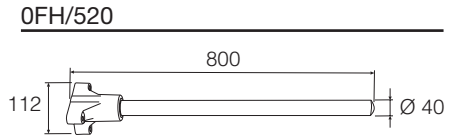

OFH/520
O.E.M. 8154385



OFH/521
O.E.M. 20466895

applicabile a I suitable to I verwendbar für:

FH12-FH16 PRIMA SERIE | FIRST SERIES | ERSTE SERIE

OFH/522 (*)

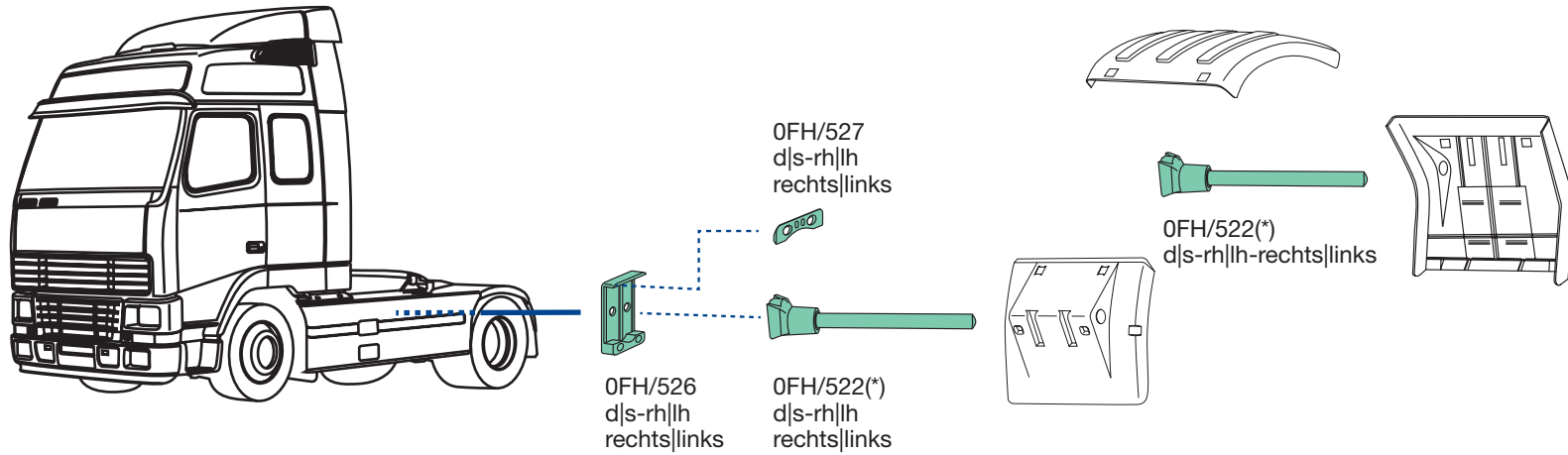
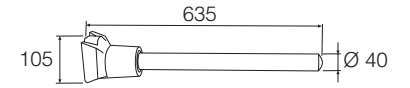

OFH/522
O.E.M. 20466894



OFH/526
O.E.M. 20382890



OFH/527
O.E.M. 20383038

FH12-FH16 PRIMA SERIE | FIRST SERIES | ERSTE SERIE

(*) adattabile a 2FH/505-PRM/516-PRM/517-PRM/518-PRM/519-2FH/505
suitable to 2FH/505-PRM/516-PRM/517-PRM/518-PRM/519-2FH/505
passend für 2FH/505-PRM/516-PRM/517-PRM/518-PRM/519-2FH/505

(°) adattabile a PRM/514-2FH/505-2FH/518
suitable to PRM/514-2FH/505-2FH/518
passend für PRM/514-2FH/505-2FH/518

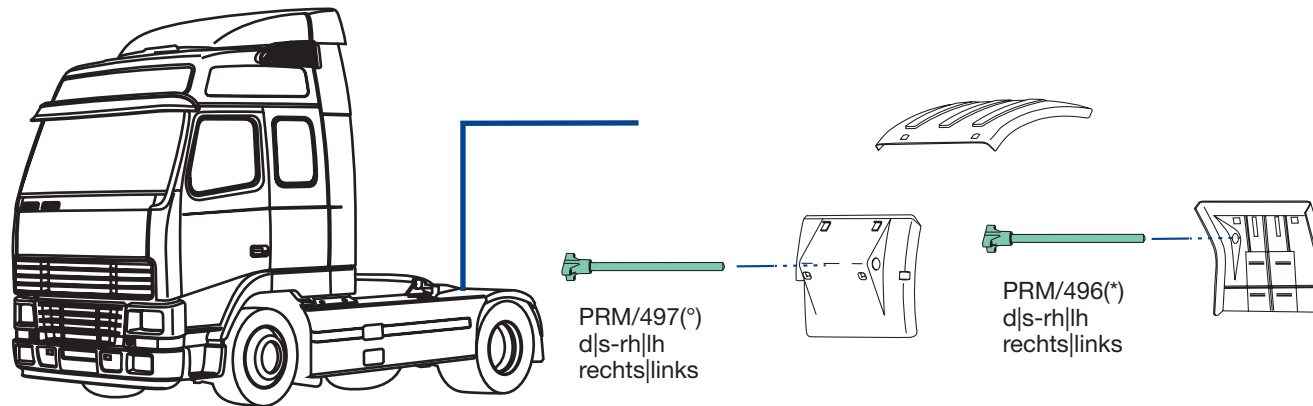
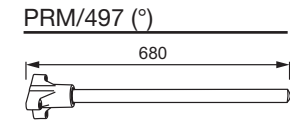
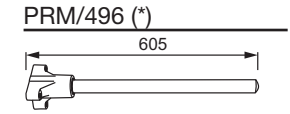

PRM/496
O.E.M. 21011688



PRM/497
O.E.M. 1079959



applicabile a l suitable to l verwendbar für:

FH12-FH16 PRIMA SERIE | FIRST SERIES | ERSTE SERIE

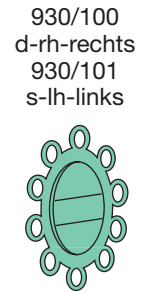
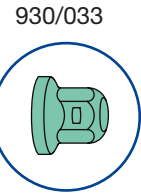
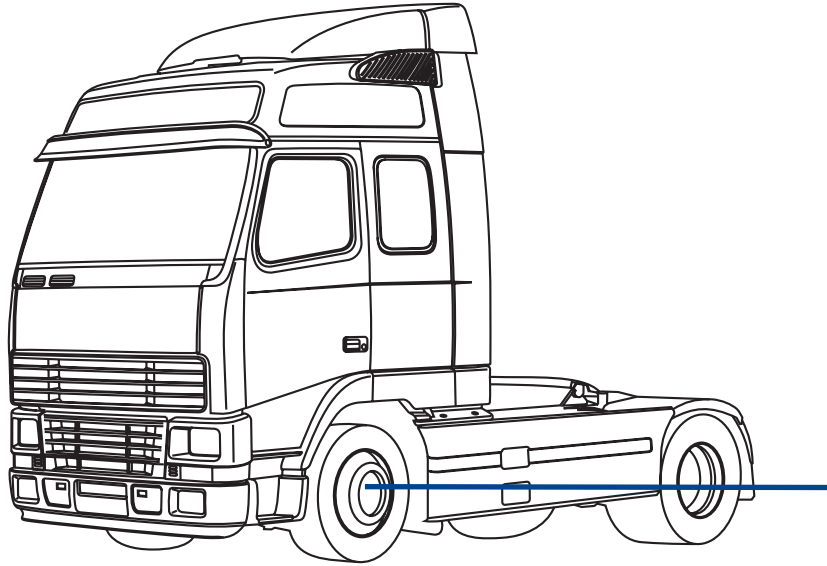

930/033
O.E.M. -



930/001
O.E.M. -
930/002
O.E.M. -



930/100
O.E.M. -
930/101
O.E.M. -



930/200
O.E.M. -

FH12-FH16 PRIMA SERIE | FIRST SERIES | ERSTE SERIE

930/033-Tappo copri Bullone-Bolt cover-Radmutterkappen

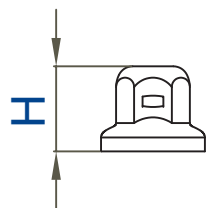

H	45 mm
Per bulloni \varnothing - bolt \varnothing	33 mm
Schlüsselweite \varnothing	
Colore	cromato-chrome-verchromt
Colours-Farbe	
Materiale-Material	acciaio inox-stainless steel Edelstahl
Kg	0,025

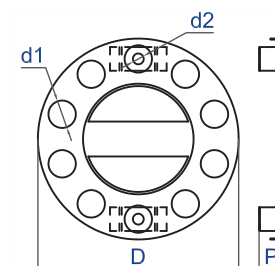

930/001 d-rh-rechts | 930/002 s-lh-links

D \varnothing 425 mm	P 50 mm
d1 nr. 10	d1 \varnothing 58 mm
d2 nr. 2	d2 \varnothing 23 mm
Ventilata	si-yes-Ja
Ventilated-Belüftet	
Colore	cromato e nero-chrome and black
Colours-Farbe	verchromt und schwarz
Materiale-Material	acciaio inox e plastica stainless steel and plastic Edelstahl und Kunststoff
Kg	1,230

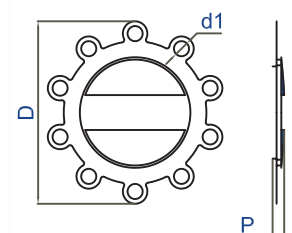

930/100 d-rh-rechts | 930/101 s-lh-links

D \varnothing 387 mm	P 30 mm
d1 nr. 10	d1 \varnothing 32 mm
Ventilata	si-yes-Ja
Ventilated-Belüftet	
Colore	cromato e nero-chrome and black
Colours-Farbe	verchromt und schwarz
Materiale-Material	acciaio inox e plastica stainless steel and plastic Edelstahl und Kunststoff
Kg	0,655

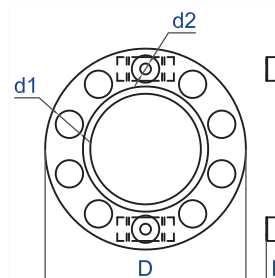

930/200 d|s-rh|lh-rechts+links

D \varnothing 425 mm	P 40 mm
d1 nr. 10	d1 \varnothing 58 mm
d2 nr. 2	d2 \varnothing 23 mm
Ventilata	no-nein
Ventilated-Belüftet	
Colore	cromato-chrome-verchromt
Colours-Farbe	
Materiale-Material	acciaio inox-stainless steel Edelstahl
Kg	1,155

applicabile a | suitable to | verwendbar für:

FH12-FH16 PRIMA SERIE | FIRST SERIES | ERSTE SERIE

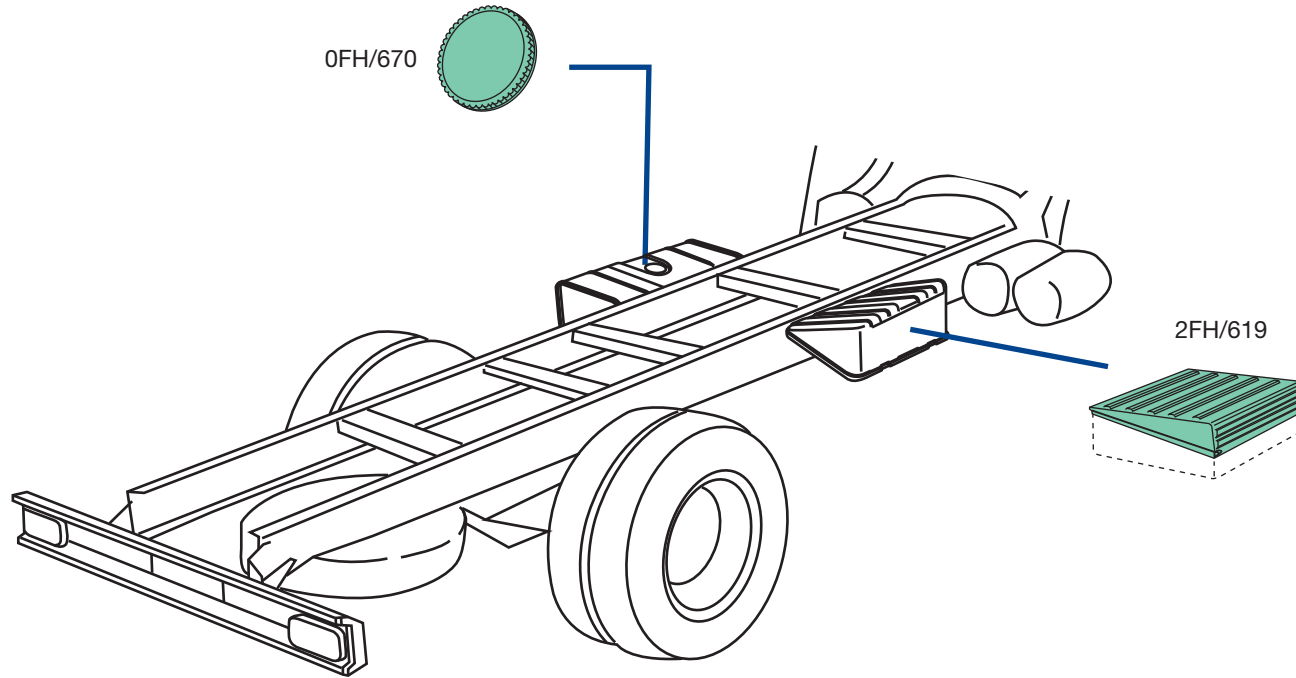

0FH/670

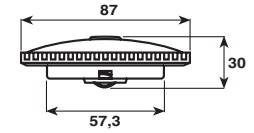

2FH/619

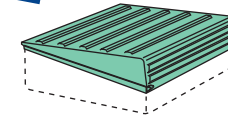

0FH/670
O.E.M. 9520400



2FH/619
O.E.M. 20507252



applicabile a | suitable to | verwendbar für 235

V12
F12

applicabile a I suitable to I verwendbar für:

F12

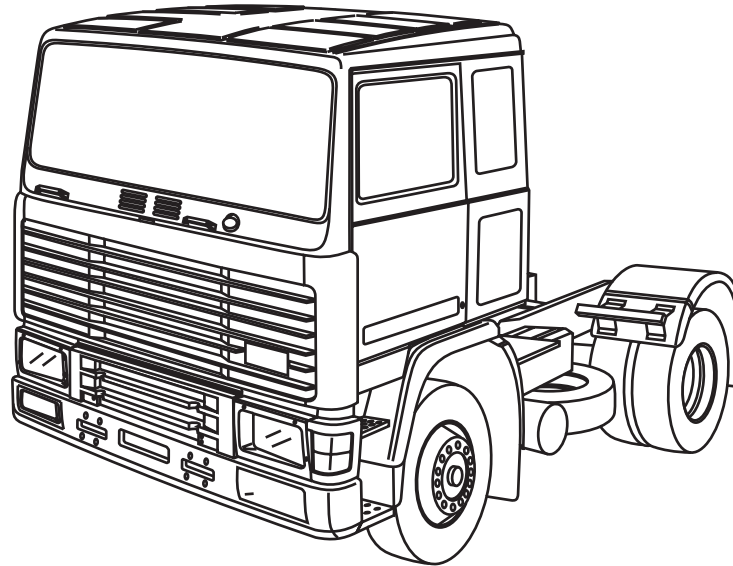
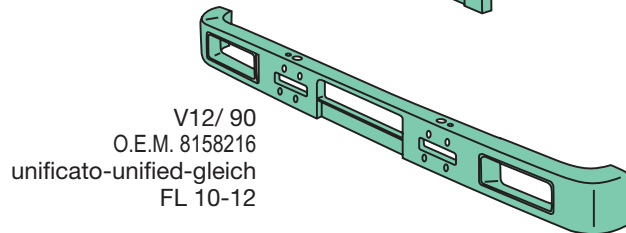
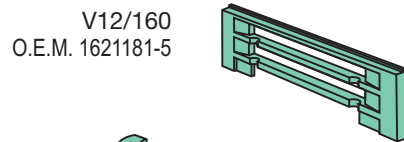
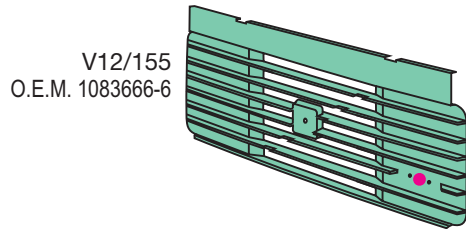
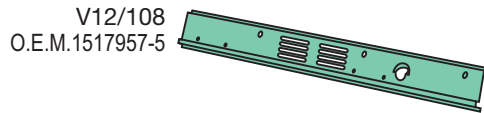
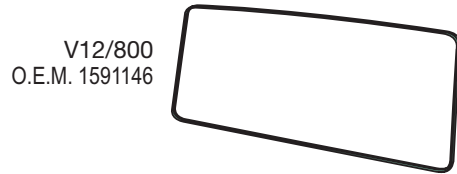

F12 V12/169
O.E.M. 1612331

INTERCOOLER V12/168
O.E.M. 1607898



940/112
protezione faro
(la coppia)
headlamp protection
(pair of)
Scheinwerferschutz (Paar)
O.E.M. -



V12/700
d|s-rh|lh-rechts|links
O.E.M. 3175032



V12/ 88
d-rh-rechts
O.E.M. 1088871-7
V12/ 89
s-lh-links
O.E.M. 1088870-9



V12/ 98
d-rh-rechts
O.E.M. 1089123-2
V12/ 99
s-lh-links
O.E.M. 1089122-4

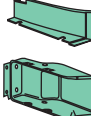

V12/111 d-rh-rechts
O.E.M. 1621183
V12/112 s-lh-links
O.E.M. 1621182
V12/100
d|s-rh|lh-rechts|links
O.E.M. 1611178-3



940/113
O.E.M. -
protezione fanale (la coppia)
light protection (pair of)
Lichterschutz (Paar)



V12/134 d-rh-rechts
O.E.M. 1698147-4
V12/135 s-lh-links
O.E.M. 1698146-6

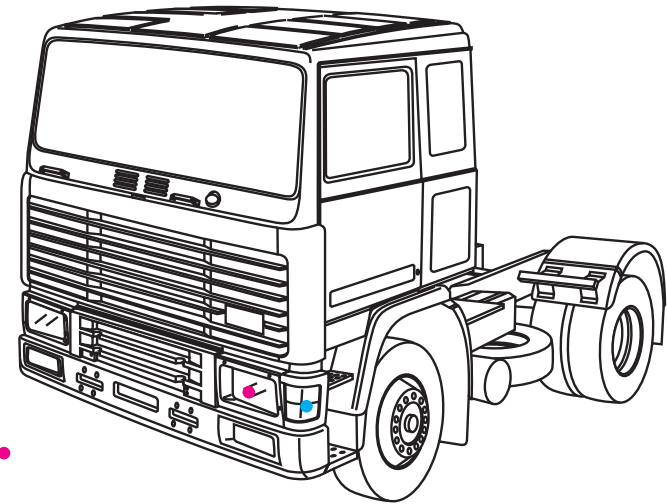

F12

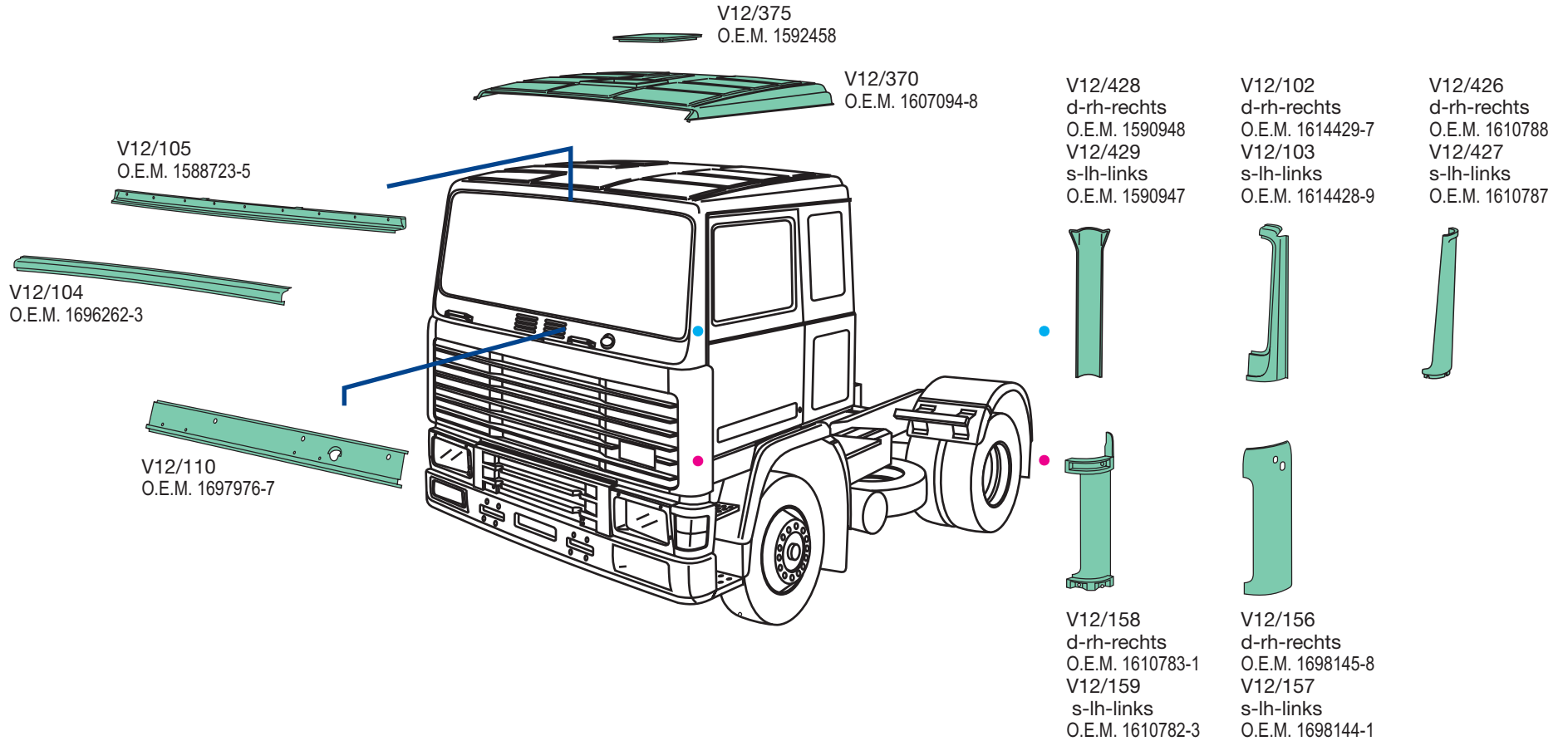

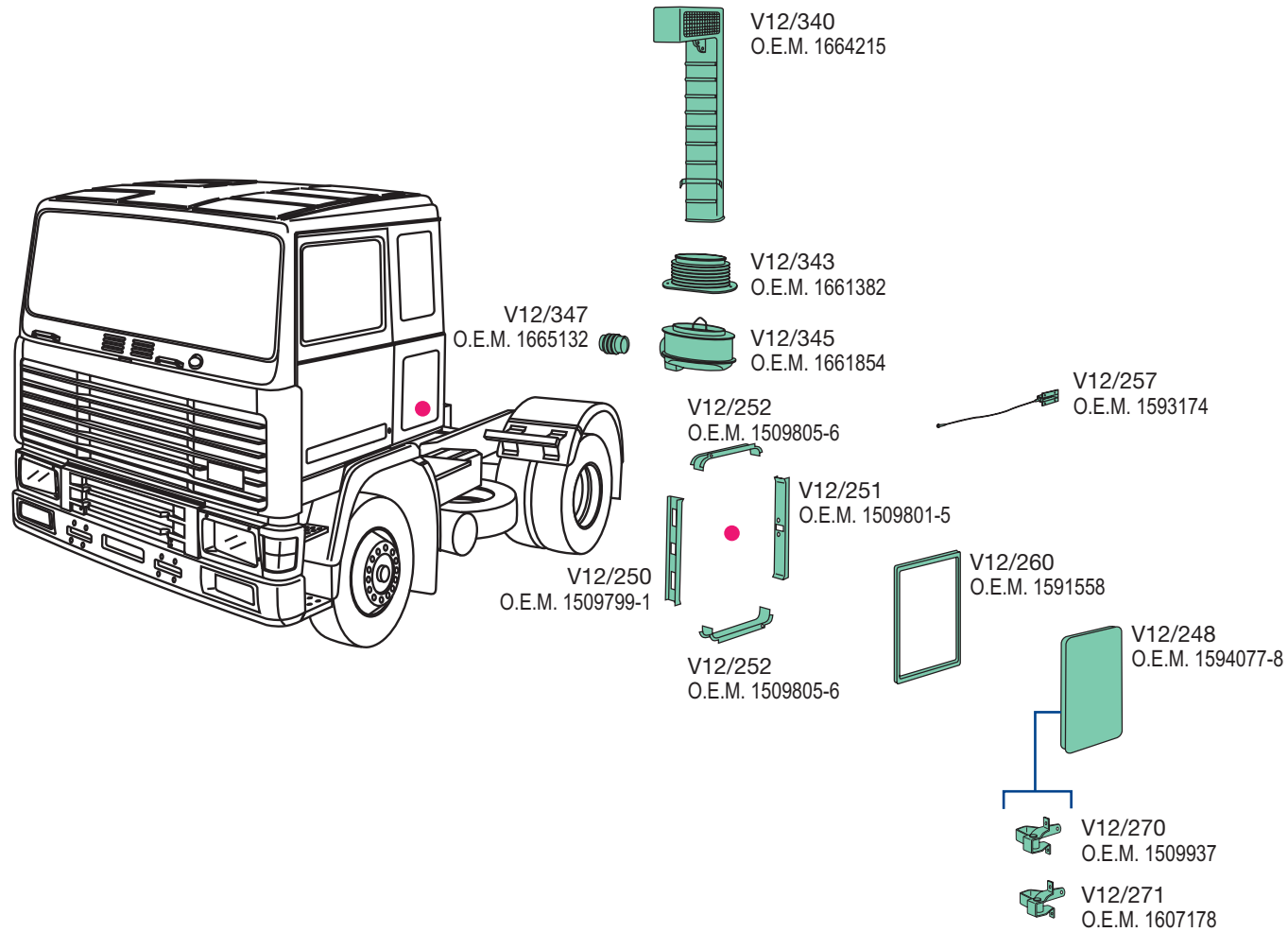

F12

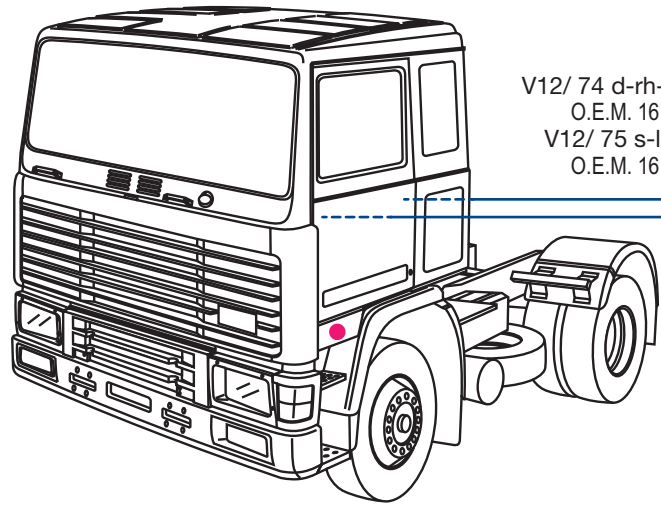

V12/ 74 d-rh-rechts
O.E.M. 1612622-9
V12/ 75 s-lh-links
O.E.M. 1612621-1

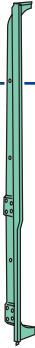

V12/210 d-rh-rechts
O.E.M. 1509924-5
V12/211 s-lh-links
O.E.M. 1509922-9



V12/ 2 d-rh-rechts
O.E.M. 1698651-5
V12/ 3 s-lh-links
O.E.M. 1698650-7
con cerniere
with hinges
mit Türscharniere

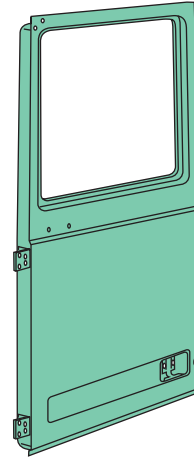

V12/ 6 d-rh-rechts
O.E.M. 1697968-4
V12/ 7 s-lh-links
O.E.M. 1697967-6
pannello porta esterno
door panel
äußeres Türblech

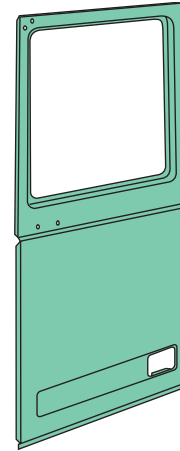

V12/ 86 d-rh-rechts
O.E.M. 1614459-4
V12/ 87 s-lh-links
O.E.M. 1614458-6



V12/ 82 d-rh-rechts
O.E.M. 1614461-0
V12/ 83 s-lh-links
O.E.M. 1614460-2

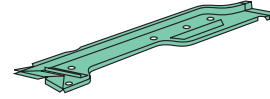

V12/ 84 d-rh-rechts
O.E.M. 1614457-8
V12/ 85 s-lh-links
O.E.M. 1614456-0

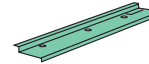

V12/ 4 d-rh-rechts
O.E.M. 1571118.
V12/ 5 s-lh-links
O.E.M. 1571117



V12/230 d-rh-rechts
O.E.M. 1509945-0
V12/231 s-lh-links
O.E.M. 1578428-3

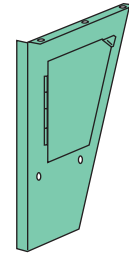

V12/242
d|s-rh|lh-rechts|links
O.E.M. 1509846-0

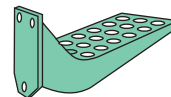

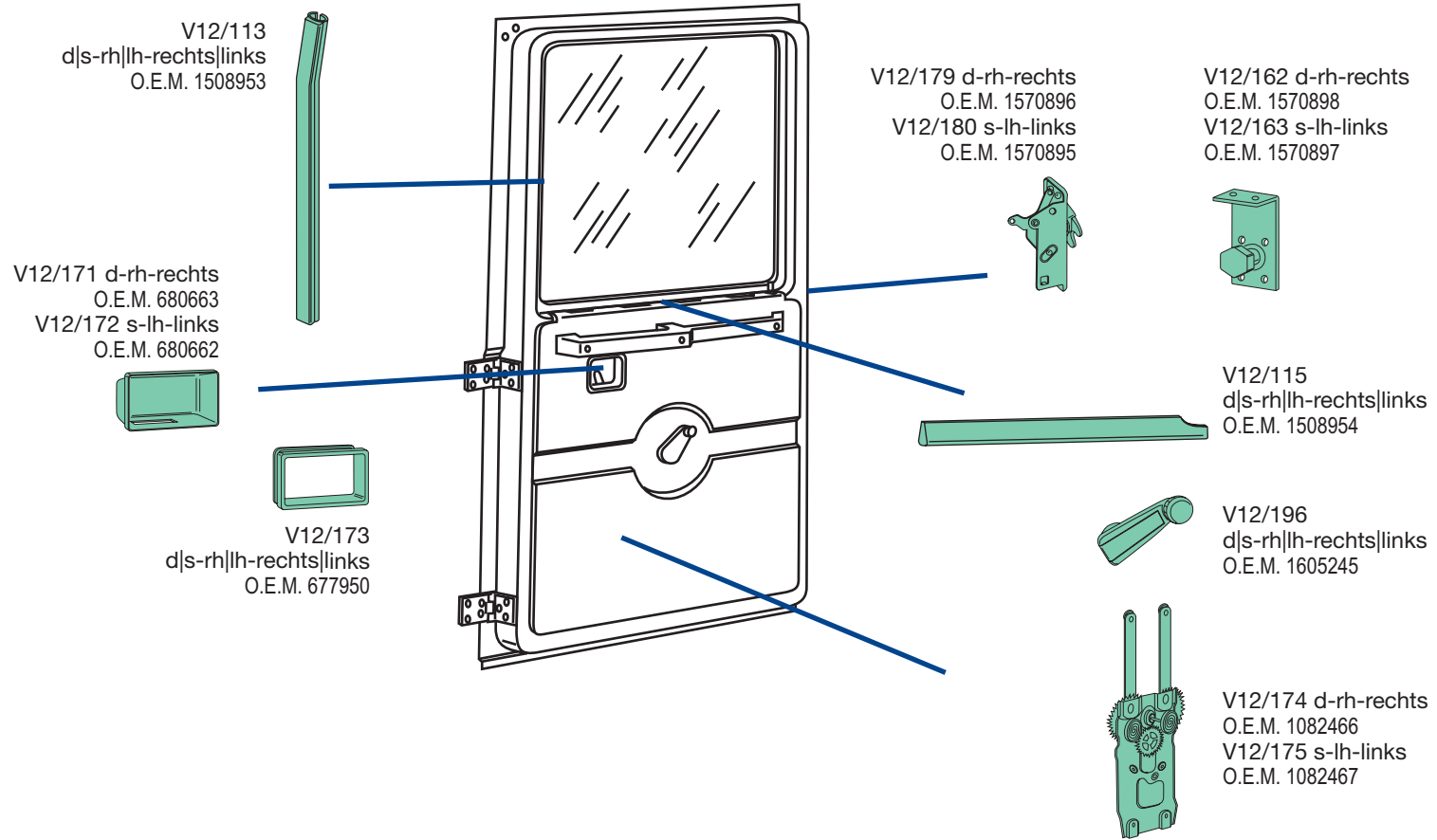

F12

PDS/360

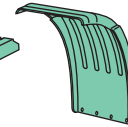
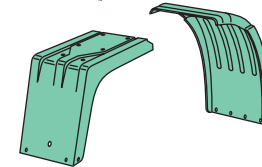
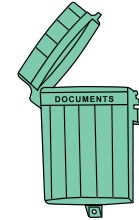
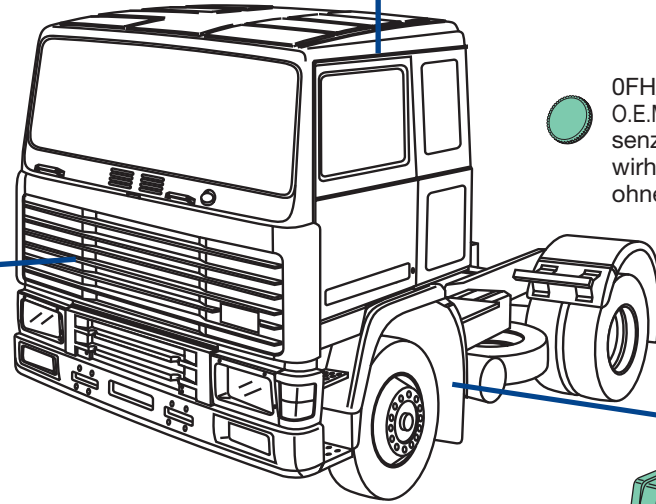
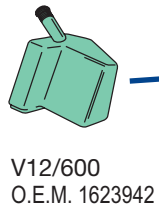
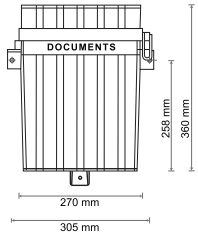

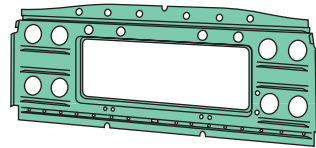

V12/316
O.E.M. 1570986-8

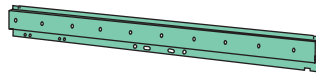

V12/317
O.E.M. 1614589-8

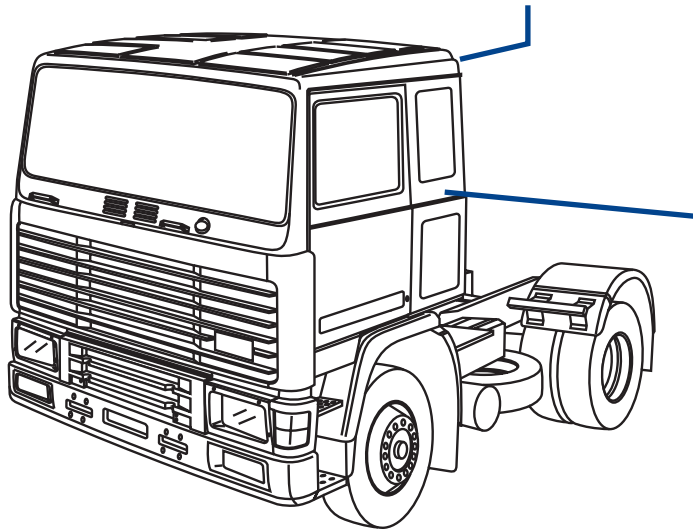

V12/246
d-rh-rechts
O.E.M. 1614490-9
cabina lunga
sleeper cab
langes Fhs.



V12/247
s-lh-links
O.E.M. 1614491-7
cabina lunga
sleeper cab
langes Fhs.



V12/243
d-rh-rechts
O.E.M. 1586124-4

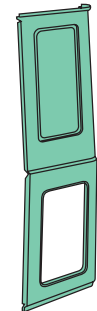

V12/244
s-lh-links
O.E.M. 1586120-6

F12

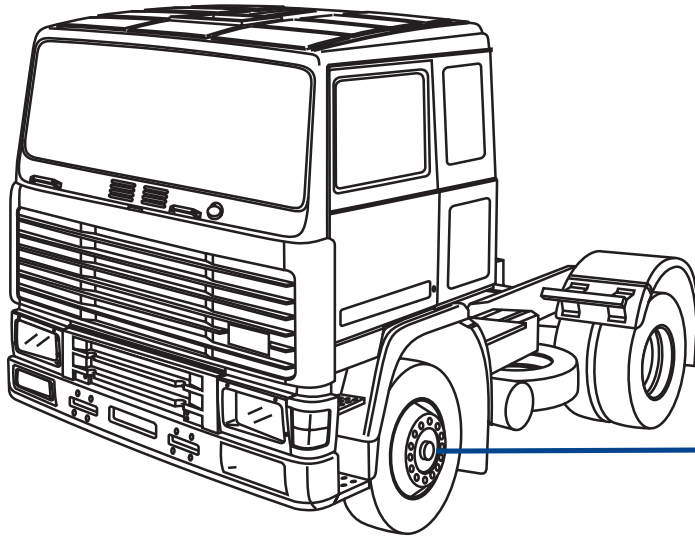

930/033

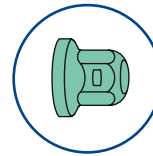

930/100
d-rh-rechts
930/101
s-lh-links

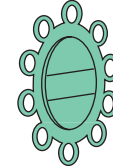

930/001
d-rh-rechts
930/002
s-lh-links



930/200
d|s-rh|lh
rechts|links

930/033-Tappo copri Bullone-Bolt cover-Radmutterkappen

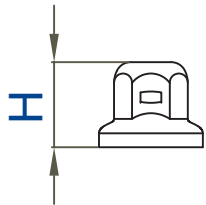

H	45 mm
Per bulloni \varnothing - bolt \varnothing	33 mm
Schlüsselweite \varnothing	
Colore	cromato-chrome-verchromt
Colours-Farbe	
Materiale-Material	acciaio inox-stainless steel Edelstahl
Kg	0,025

930/001 d-rh-rechts | 930/002 s-lh-links

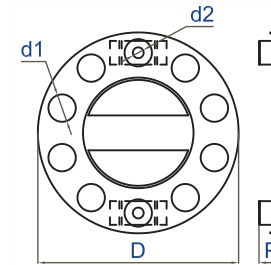

D \varnothing 425 mm	P 50 mm
d1 nr. 10	d1 \varnothing 58 mm
d2 nr. 2	d2 \varnothing 23 mm
Ventilata	si-yes-Ja
Ventilated-Belüftet	
Colore	cromato e nero-chrome and black
Colours-Farbe	verchromt und schwarz
Materiale-Material	acciaio inox e plastica stainless steel and plastic Edelstahl und Kunststoff
Kg	1,230

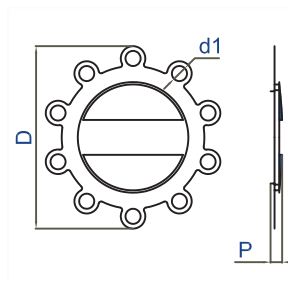

930/100 d-rh-rechts | 930/101 s-lh-links

D \varnothing 387 mm	P 30 mm
d1 nr. 10	d1 \varnothing 32 mm
Ventilata	si-yes-Ja
Ventilated-Belüftet	
Colore	cromato e nero-chrome and black
Colours-Farbe	verchromt und schwarz
Materiale-Material	acciaio inox e plastica stainless steel and plastic Edelstahl und Kunststoff
Kg	0,655

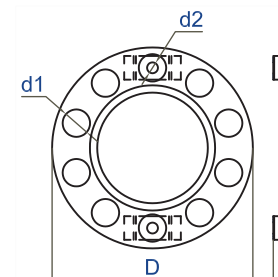

930/200 d|s-rh|lh-rechts+links

D \varnothing 425 mm	P 40 mm
d1 nr. 10	d1 \varnothing 58 mm
d2 nr. 2	d2 \varnothing 23 mm
Ventilata	no-nein
Ventilated-Belüftet	
Colore	cromato-chrome-verchromt
Colours-Farbe	
Materiale-Material	acciaio inox-stainless steel Edelstahl
Kg	1,155



IT Stampo in acciaio temprato per la produzione di parafanghi posteriori

EN Hardened steel mold for rear mudguard production

DE Gehärtete Stahlform für Kotfluegel Produktion



IT Stampo a iniezione per ossatura portafaro sinistro
EN LH headlamp housing injection moulding
DE Spritzgusswerkzeug für linken Scheinwerfer traeger

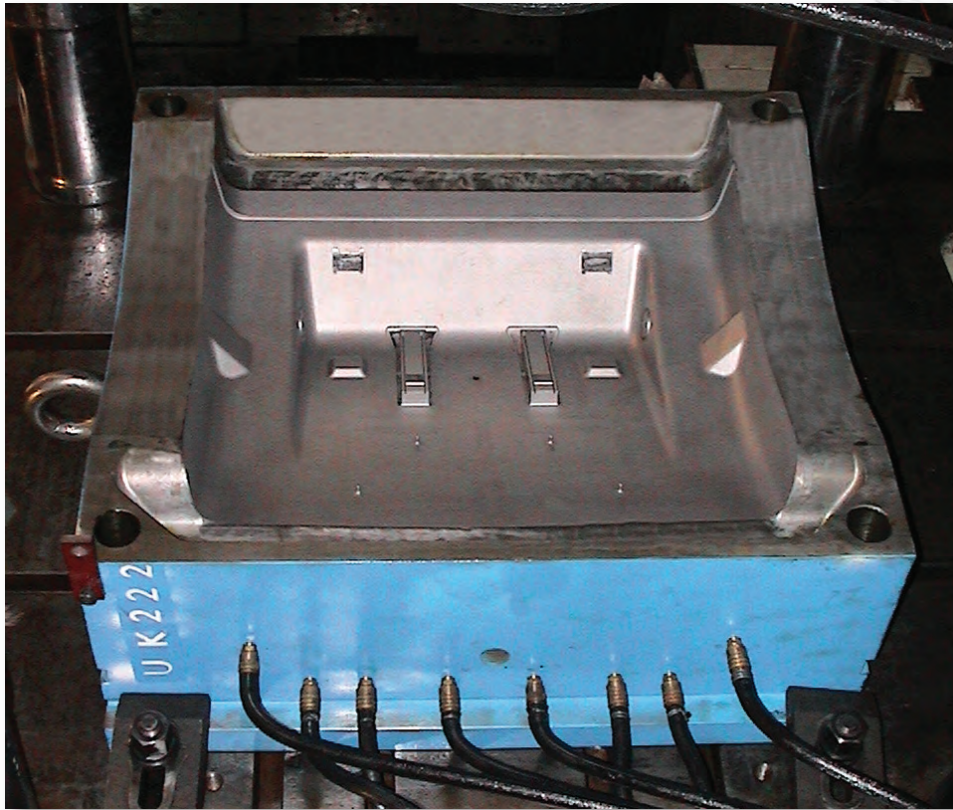

IT Stampo a iniezione per la produzione del parafrangente posteriore Volvo
EN Injection mould for the production of the rear mudguard Volvo
DE Spritzgußform für die Produktion von Hinterachskotflügel für Volvo

COVIND SPA

SERVIZIO VENDITE ITALIA DOMESTIC SALES DPT.

☎. +39 011 8965702

☎. +39 011 8965714

☎. +39 011 8965719

☎. +39 011 8965756

E.MAIL vendite@covind.it

SERVIZIO VENDITE ESTERO INTERNATIONAL SALES DPT.

☎. +39 011 8965722

☎. +39 011 8965735

☎. +39 011 8965759

☎. +39 011 8005149

E.MAIL export@covind.it

COVIND S.P.A.

Strada della Cebrosa, 68-70-72
10036 Settimo Torinese (TO) - ITALY

☎. +39 011 8965711

☎. +39 011 8977830

marketing@covind.it

www.covind.it



COVIND COV
IND COVIND
COVIND COV
IND COVIND
COVIND COV
IND COVIND
COVIND COV

