

COVIND

unlimited quality



COVIND COV
 IND COVIND
 COVIND COV
 IND COVIND
 COVIND COV
 IND COVIND
 COVIND COV



SUITABLE TO
DAF
 2017

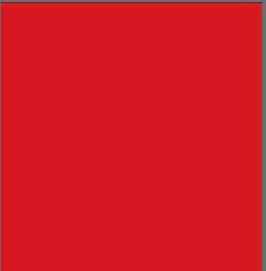

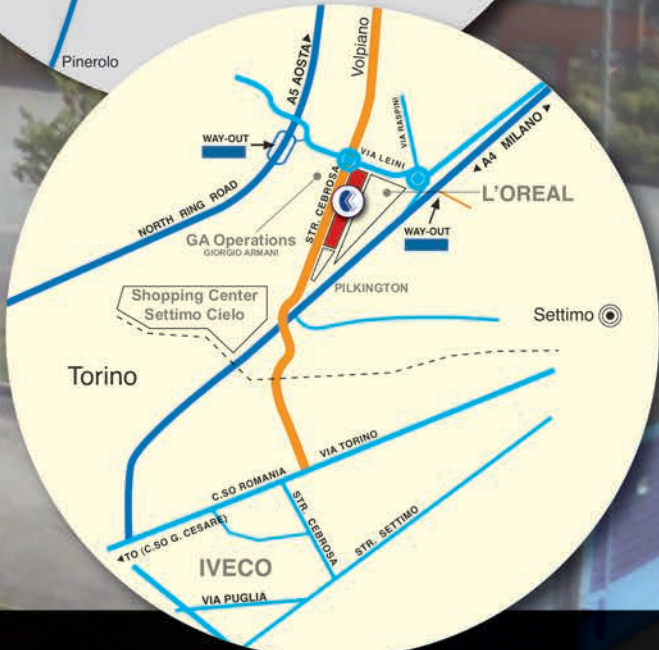
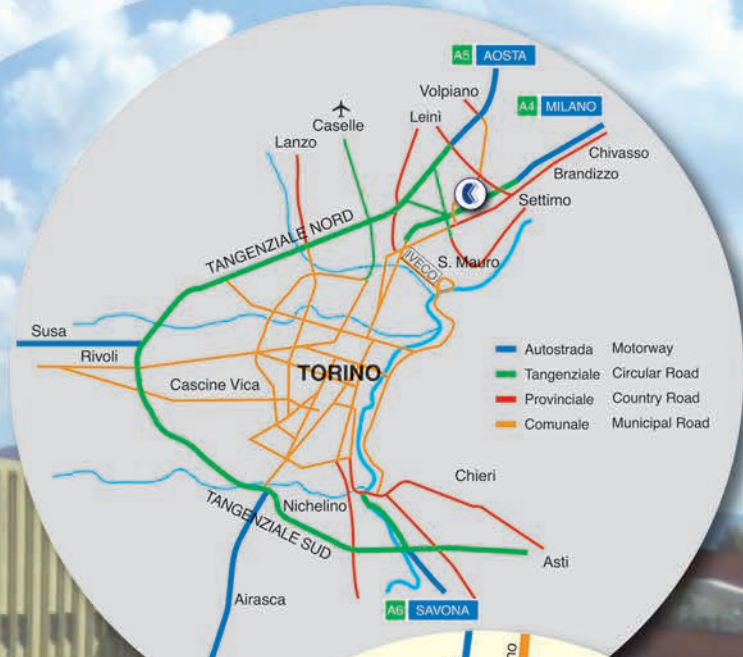

COVIND S.p.A.

COVIND S.P.A. Strada della Cebrosa, 68/70/72 - Settimo T.se (TO) | ITALY



SUITABLE TO

DAF

MAGGIO
MAY
MAI

2017



BUREAU
VERITAS

SGS





كافت التفاصيل المذكوره هنا، وبالرغم من قابليتها للتبديل مع التفاصيل الاصلية بشكل متطابق تماما، إلا انها ليست الأصلية، نفس التفاصيل يتم الاستعانه بها واستخدامها فقط للعربات السائره و فقط بعد الحصول على التصريح بالموافقه من مالك العربيه التي يتم إصلاحها.
الأرقام الإرشاديه الأصلية يتم وضعها بغرض الاستعلام، نرجو أن يتم دائما ذكر أرقامنا الخاصة الإرشاديه في التعاقدات وطلبات الشراء.
هذا الكاتالوج يلغي كافة الكاتالوجات السابقه ويحل محلها.



Всички особености изредени по-долу, независимо от това, че са взаимозаменяеми с оригиналите, **не са оригинали**. Те биват използвани само за превозните средства в движение и само след упълномощаване от страна на собственика на превозното средство в ремонт.



Selv om de sagtens kan bruges i stedet for de originale er de reservedele der indgår i **denne liste ikke originale**. Disse reservedele bruges kun til aktive køretøjer og udelukkende med ejerens tilladelse, mens reparationen udføres. De originale referencekoder fremstår kun som en oplysning. De bedes angive vores referencekoder i f.m. forhandlinger og bestillingssedler. Det nye katalog annullerer og erstatter alle tidligere udgaver.



Selles nimekirjas olevad varuosad ei ole originaalid vaatamata sellele, **et on originaalidega võrdväärset kasutatavad**. Neid osasid kasutada ainult töös olevatel sõidukitel ja üksnes remonditava sõiduki omaniku loal. Originaali viitenumbrid on ära toodud ainult infoks. Palume müügi- ja tellimislehtedel ära märkida meie viitenumbrid. Käesoleva kataloogi nimekiri tühistab ja asendab varasemad.



Tässä luetteloidut varaosat eivät ole alkuperäisosa, vaikka **ne ovatkin laadultaan alkuperäisosa vastaavia**. Osat on tarkoitettu käytettäväksi liikenteessä olevissa autoissa ja niitä käytetään vain korjattavan ajoneuvon omistajan luvalla. Alkuperäiset tuotekoodit mainitaan vain tiedon vuoksi. Pyydämme teitä käyttämään neuvotteluissa ja tilauslomakkeissa meidän tuotekoodejamme. Uusi tuoteluettelo peruuttaa ja korvaa aikaisemmat luettelot.



Toutes les pièces détaillées ci-dessus, tout en étant parfaitement interchangeable avec les pièces d'origine, **ne sont pas originales**. Les mêmes pièces sont utilisées exclusivement sur les véhicules en circulation et seulement sous autorisation du propriétaire du véhicule en réparation. Les codes de référence originales sont indiqués à titre purement documentaire. Dans les négociations et les commandes veuillez bien citer nos codes de référence. Le présent catalogue annule et remplace tous les précédents.



Alle hier aufgeführten Bestandteile sind exakt austauschbar mit den Originalteilen, **aber es sind keine Originale**. Diese Teile werden nur angewendet und eingesetzt für die Fahrzeuge die im Umlauf sind und nur nach Einverständnis mit dem Eigentümer, dessen Fahrzeug in der Reparatur ist. Die Original-Referenznummern wurden rein informativ nochmals wiedergegeben. Bei Anfragen und bei Bestellungen bitten wir Sie immer die Referenznummern anzugeben. Der beigelegte Katalog ersetzt und annulliert die vorhergehenden Kataloge.



Κάθε ανταλλακτικό που απαριθμείται εδώ, ακόμα κι αν όντας τέλεια ανταλλάξιμο με το γνήσιο, **δεν είναι γνήσιο**. Αυτά τα μέρη χρησιμοποιούνται μόνο στα οχήματα που είναι σε κυκλοφορία και αποκλειστικά μετά από την έγκριση του ιδιοκτήτη του οχήματος για επισκευή. Οι γνήσιοι κωδικοί που αναφέρονται υπάρχουν για πληροφοριακούς λόγους μόνο. Παρακαλούμε όπως χρησιμοποιείτε για οποιαδήποτε συναλλαγή/ παραγγελία σας τους δικούς μας αναφερόμενους κωδικούς. Ο παρών κατάλογος ακυρώνει και αντικαθιστά προηγούμενους.



Spare parts listed here, even though perfectly interchangeable with the original ones, **are not original**. These parts are used only on vehicles in circulation and exclusively under authorization of the owner of the vehicle in repair. The original reference codes are indicated for information only. You are kindly requested to indicate our reference codes in negotiations and order sheets. The present catalogue list cancels and replaces previous ones.



قطعات قید شده در اینجا، با اینکه کاملاً قابل تعویض با قطعات اصلی می باشند، قطعات اصلی نیستند. این قطعات تنها برای خودروهایی که در جریان می باشند (خارج از محل تولید می باشند) مورد استفاده قرار می گیرند و منحصراً تحت اختیار و نظر مالک خودروی در حال تعمیر می باشند. با احترامات ما از شما شماره کد ارجاع اصلی تنها برای اطلاعات می باشند. تقاضا داریم که شماره کد ارجاع را در زمان مذاکره و در ورقه تقاضا مشخص کنید. لیست



Tutti i particolari qui elencati, pur essendo perfettamente intercambiabili con gli originali, **non sono originali**. Gli stessi vengono impiegati ed utilizzati solo per i veicoli in circolazione e solo dopo autorizzazione da parte del proprietario del veicolo in riparazione. I numeri di riferimento originali sono riportati a puro titolo informativo. Nelle trattative e nelle ordinazioni si prega di voler sempre citare i nostri numeri di riferimento. Il presente catalogo annulla e sostituisce tutti i precedenti.



Kaut arī uzskaitītās rezerves daļas var pilnīgi aizstāt oriģinālās, **tās nav oriģinālas**. Šīs rezerves daļas tiek izmantotas vienīgi apgrozībā esošiem transporta līdzekļiem un tikai ar remontējamā transporta līdzekļa īpašnieka atļauju. Oriģinālais atsauces numurs tiek uzrādīts vienīgi informācijai. Lūdzam norādīt jūsu atsauces numurus sarunu laikā un uz pasūtījuma lapas. Šis kataloga saraksts anulē un aizstāj visus iepriekšējos.



Čia išvardytos atsarginės dalys nėra originalios, tačiau jomis galima pakeisti originaliąsias. Šios dalys naudojamos tik apyvartoje esančiuose automobiliuose ir tik gavus remontuojamo automobilio savininko sutikimą.

Originalių dalių kodai nurodomi tik informacijos sumetimais. Maloniai prašome nusiskundimuose ir užsakymų lapuose nurodyti dalių kodus.

Šiame kataloge pateikiamas sąrašas anuliuoja ir pakeičia ankstesniusius.



Reservedelene som er oppført her, er ikke **originale reservedeler**, selv om de fullt ut kan benyttes ved utskiftning av de opprinnelige delene. De skal kun benyttes på kjøretøy som er i bruk og med eierens samtykke. De opprinnelige referansekodene angis kun til etterretning. Vennligst angi våre referansekoder under forhandling og ved bestilling. Denne katalogen annullerer og erstatter alle tidligere kataloger.



Hoewel elk reserveonderdeel dat hier vermeld wordt perfect kan worden gebruikt in de plaats van de originele stukken, **gaat het hier dus niet om originele onderdelen**. Deze onderdelen worden enkel gebruikt voor voertuigen in circulatie en enkel met de toestemming van de eigenaar van het voertuig dat in reparatie is. De originele referentiecodes worden enkel ter informatie weergegeven. U wordt vriendelijk verzocht om onze referentiecodes te gebruiken in gesprekken en op de bestelformulieren. De huidige catalogoog annuleert en vervangt de vorige versies.



Wszystkie detale tu podane ,choć będąc doskonałe wymienne z oryginałami, **nie są oryginalne**.

Te same zostają zastosowane i użyte tylko dla pojazdów w obiegu i tylko po autoryzacji ze strony właściciela pojazdu będącego w naprawie.

Originalne numery referencyjne są umieszczone w celu czysto informacyjnym.

W czasie rozmów handlowych i zamówień, prosi się zechcieć zawsze cytować nasze numery referencyjne.

Niniejszy katalog anuluje i zastępuje wszystkie poprzednie.



Todas as peças aqui listadas, ainda que sejam perfeitamente intercambiáveis com as originais, **não são originais**. Estas peças só são empregues e utilizadas nos veículos em circulação e só após autorização prévia por parte do proprietário do veículo a reparar. Os números de referência originais têm um carácter puramente informativo. Nos contactos e encomendas, indique sempre os números de referência, por favor.



Veškeré zde uvedené součástky **nejsou originální díly**, i když jsou za ně stoprocentně zaměnitelné. Tyto součástky je možné použít pouze pro vozidla v provozu a pouze se souhlasem majitele vozidla, které má být opraveno. Referenční čísla originálních dílů jsou uvedena pouze informativně. Při jednáních a na objednávkách je nutné vždy uvést naše referenční čísla.

Tento katalog anuluje a nahrazuje veškeré předchozí katalogy.



Toate produsele enumerate in continuare, chiar daca sunt perfect interschimbabile cu cele originale, **nu sunt originale**. Ele sunt utilizate, numai pentru autovehiculele in circulatie si exclusiv cu acordul proprietarului autovehiculului de reparat. Codurile originale sunt indicate numai in scop informativ. Cu ocazia tratativelor verbale, cat si a emiterii ordinelor scrise, clientii sunt rugati sa utilizeze codurile noastre (COVIND) ca referinta. Prezentul catalog anuleaza si le inlocuieste pe cele precedente.



Все перечисленные запчасти не являются оригинальными, **хотя могут отлично их заменить**. Эти запчасти используются при ремонте автомобилей только с согласия владельца.

Ссылки на порядковый номер оригинальных запчастей указаны исключительно в ориентировочных целях.

При покупках и заказах рекомендуем указывать НАШИ номера запчастей.

Настоящий каталог аннулирует и заменяет все предыдущие.

Оригинальные ориентировочные номера са изнесени само за ваша информация. При преговори и при поръчки молим винаги да цитирате нашите ориентировочни номера.

Настоящият каталог анулира и замества всички съществуващи до момента.



Ovdje popisani prièuvni dijelovi, èak i kada savršeno zamjenjuju izvorne, **nisu izvorni**. Ti dijelovi mogu se uporabiti jedino na vozilima u cirkulaciji i na temelju izrièitoga odobrenja vlasnika vozila na popravku. Brojevi dijela izvornih dijelova navedeni su samo kao primjer. Najljepše vas molimo da u vašim zahtjevima i narudžbama navedete brojeve dijela.

Sadašnji katalog ukida valjanost svih prethodnih kataloga.



Èeprav jih je možno perfektno izmenjati z originalnimi deli, tukaj navedeni nadomestni deli niso originalni. Te dele se uporabljajo samo v vozilih v prometu in izkljuèno samo pod pogojem, da lastnika vozila v popravilu izda zato dovoljenje. Navedene originalne referenène kode so le informativne. Prosimo vas, da navedite naše referenène kode pri pogajanju in na naroèilih. S sedanjim seznamom prenehajo veljati prejšnji sezname in jih nadomesti.



Todos los elementos detallados a continuación, aunque totalmente intercambiables con los originales, **no son originales**. Estos mismos se emplean y utilizan unicamente para vehículos en circulación y previa autorización del propietario del vehículo en reparación. Los numeros de referencia originales se citan a título informativo. En las negociaciones y en los pedidos se ruega citar siempre nuestros numeros de referencia. El presente catálogo anula y substituye todos los anteriores.



Reservdelarna i denna lista är inte originaldelar trots att de **är fullkomligt utbytbara med de ursprungliga**. Dessa delar används endast på fordon i cirkulation och enbart efter godkännande av ägaren till det fordon som lämnats på reparation. De originala referenskoderna anges endast för information. Var god ange våra referenscodes i negocieringar och beställningsblanketter. Den nuvarande katalogistan annullerar och ersätter de föregående.



Devamında detaylandırılan tüm elementler, orijinalleri ile tamamen değiştirilebilir olmasına rağmen, **orijinal değildirler**. Bunlar, yalnızca dolaşımda bulunan araçlarda ve tamirde bulunan aracın sahibinden ön onay alınması kaydıyla uygulanabilir ve kullanılabilir.

Orijinallerin referans numaraları bilgi başlığında yer almaktadır.

Görüşmelerde ve siparişlerde referans numaralarımızın her zaman belirtilmesi rica olunur.

Bu katalog tüm önceki versiyonları geçersiz kılar ve bunların yerine geçer.



Перелічені тут запасні частини не є оригінальними, але цілком взаємозамінні з оригінальними. Ці запасні частини застосовуються тільки на транспортних засобах, що знаходяться в експлуатації і винятково з дозволу власника, що здав транспортний засіб у ремонт.

Коди оригінальних запасних частин наводяться тільки для довідки. Прохання вказувати довідкові коди запасних частин при веденні переговорів і на бланках замовлення.

Даний каталог скасовує дію раніше виданих каталогів і замінює ці каталоги.



Az itt felsorolt tartalék alkatrészek, még akkor is, ha megfelelően felcserélhetők az eredetiekkel, nem az eredetiek. Ezeket az alkatrészeket csak forgalomban lévő járművek javításánál használják és kizárólag a jármű tulajdonosának engedélyével.

Az eredeti referencia kódokat csak információs célból jelzik. Kérjük legyen szíves jelezze a referencia kódjainkat a tárgyalásokon és a megrendelési dokumentumban.

A jelenlegi katalógus lista vissza van vonva és újra az előző lista van érvényben.

Si consiglia di consultare sempre il catalogo on-line per gli ultimi aggiornamenti.

Please visit the catalogue on line for the latest updates.

il est conseillé de toujours consulter le catalogue en ligne pour les dernières mises à jour.

Wir empfehlen Ihnen immer unsere on-line Kataloge nachzuschlagen, um die letzten Aktualisierungen zu kennen

Les recomendamos consulten siempre el catálogo en línea para las últimas actualizaciones.

<http://catalogo.covind.it>



Recomenda-se a consulta do catálogo eletrónico para informação das novas atualizações.

Zaleca się odwiedzać zawsze katalog on-line zawierający najnowsze aktualizacje

E consiliabila intotdeauna, consultarea catalogului on-line pentru cunoasterea ultimilor actualizari.

Пожалуйста, обратите внимание на последние обновления каталогов on-line

للاطلاع على آخر التحيينات,
الرجاء الرجور دائما الى كاتالوجاتنا على الخط.

www.covind.it



Indice Index Verzeichnis

LEGENDA SPECCHI MIRROR KEY SPIEGEL-LEGENDE Intro 2

NORMATIVA REGULATION VORSCHRIFT Intro 3

TABELLE COMPARATIVE CROSS REFERENCES KORRESPONDENZTABELLE

OEMCOVIND Intro 5

COVINDOEM Intro 12

LEGERI COMMERCIAL TRANSPORTER

[LF6] LF45 Euro 6 1

[LF6] LF55 Euro 6 7

[LF0] LF45 13

[LF0] LF55 31

MEDI MEDIUM VERTEILERVERKEHER

[CF6] CF Euro 6 51

[CF0] CF85 69

PESANTI TRUCKS NUTZFAHRZEUGE

[XF6] XF106 Euro 6 101

[XF5] XF105 119

[XF2] XF95 seconda serie - second series - 2. Serie 155

[XF0] 95XF prima serie - first series - 1. Serie 191

Legenda

	Guida destra/sinistra Right and left-hand drive Rechts-und Linkslenkung		Lato sinistro Left side Links einsetzbar		Colore Silver Color Silver Farbe Silber
	Guida destra Right-hand drive Rechtslenkung		Braccio Polipropilene e Fibra di vetro PP+GF mirror arm Spiegelarm aus Polypropylen und Glasfaser		Colore Nero e Grigio Color Black/Grey Farbe Schwarz/Grau
	Guida sinistra Left-hand drive Linkslenkung		Braccio integrato Integrated arm Integrierten Arm		Raggio 1200 di convessità specchio principale Mirror glass bend radius: 1200 Wölbungsradius des Spiegelglases 1200
	Braccio corto - destro Short arm - right Kurzer Spiegelarm, rechts		Braccio in acciaio (ø 28 mm / ø 40 mm) Steel arm (ø 28 mm / ø 40mm) Spiegelarm aus Stahl (ø 28 mm / ø 40 mm)		Raggio 300 di convessità specchio ausiliario Mirror glass bend radius: 300 Wölbungsradius des Weitwinkelspiegelglases 300
	Braccio corto - sinistro Short arm - left Kurzer Spiegelarm, links		Braccio in alluminio (ø 28 mm / ø 40 mm) Aluminium arm (ø 28 mm / ø 40 mm) Spiegelarm aus Aluminium (ø 28 mm / ø 40 mm)		Curvo Convex Gewölbtes Glas
	Braccio medio - destro Middle arm - right Mittlerer Spiegelarm, rechts		Materiale: ABS Material: ABS Kunststoff ABS		Classe II: specchio principale Class II: main mirror Klasse II: Hauptspiegel
	Braccio medio - sinistro Middle arm - left Mittlerer Spiegelarm, links		Braccio completo di copribraccio inferiore Arm with lower cover kompletter Spiegelarm mit unteren Haltebock		Classe IV: specchio ausiliario Class IV: auxiliary mirror Klasse IV: Weitwinkelspiegel
	Braccio lungo - destro Long arm - right Langer Spiegelarm, rechts		Braccio completo di copribraccio superiore e inferiore Arm with upper and lower cover kompletter Spiegelarm mit oberen und unteren Haltebock		Classe III: specchio ausiliario Class III: auxiliary mirror Klasse III: Weitwinkelspiegel
	Braccio lungo-sinistro Long arm - left Langer Spiegelarm, links		Braccio completo di supporto superiore Arm with upper bracket kompletter Spiegelarm mit oberen Haltebock		Superiore Top Höher
	Lato destro/sinistro Right/left side Links/rechts einsetzbar		Colore Nero Color Black Farbe Schwarz		Centrale Central Zentral
	Lato destro Right side Rechts einsetzbar		Colore Grigio Color Grey Farbe Grau		Inferiore Bottom Unter



Doppio specchio
Double glass
Zweispiegel



Regolazione elettrica
Remote control
Elektrisch verstellbar



Regolazione manuale
Manual control
Manuell verstellbar



Specchio riscaldato 24V (sbrinamento)
Heated 24 V
Spiegel beheizt 24 V (Entfrostdung)



Specchio riscaldato (sbrinamento)
Heated
Spiegel beheizt (Entfrostdung)



Braccio con cavo per movimento elettrico
Arm with electric wire
Spiegelarm mit Steuerkabel



Braccio con cavo per riscaldamento 24 V
Arm with heat wire 24 V
Spiegelarm mit Heizkabel



Sistema di bloccaggio
Blocking System
Haltebock



Vetro specchio con supporto
Mirror glass unit
Glas mit Spiegelhalter



Ribaltamento elettrico
Electrically foldable
Elektrisch einklappbar



Lampeggiatore luce bianca (W)
White light blinker (W)
Blinker weisslicht (W)



Lampeggiatore luce arancione (W)
Orange light blinker (W)
Blinker orangeflicht (W)



Sonda
Sensor
Sensor



Antenna
Antenna
Antenne



Supporto con attacco circolare
Circular attack support
Unterstützung mit Rundangriff



Fornito smontato
Unassembled
Zerlegte Lieferung



Imballo
Packing
Verpackung



Selezionatore specchio destro/sinistro
Mirrors' selector right/left
Spiegelverstellung rechts/links



Azionamento alzacristalli
Windows' drive power
Antriebsseite Fensterheber



Retroilluminato
Courtesy lighted
Rueckbeleuchtet



* L'OEM fornisce R400-R1800, COVIND R300-R1200 come da normativa vigente. L'indicazione "*" nel codice OEM ha pertanto il solo scopo di aiutare il cliente nell'identificazione del prodotto Covind equivalente.

* OE supplies R1800-R400 while COVIND R1200-R300 according to the valid Regulation.

The symbol "*" near the OEM code is used only for comparison purposes helping the customer to properly identify the equivalent item.

* OEM beliefer R1800-R400 während COVIND liefern in R1200-R300 die Europa normative folgend.

Die Angabe "*" im Original-Referenz dient dazu, dem Kunden zu helfen, den Covind passenden Produkt zu ermitteln.

Normativa . Regulation . Vorschrift

Secondo le direttive:

CE 2003/97 valida dal 01/2007

CE 2007/38 valida da 04/2009

With reference to:

2003/97/EC Regulation valid from January 2007

2007/38/EC Regulation valid from April 2009

Gemäß EG-Verordnung:

2003/97/EC Gültig ab Januar 2007

2007/38/EC Gültig ab April 2009

A Sistema specchio completo (II+IV+Braccio)
Complete Mirror (Class II+IV+arm)
Komplettspiegel (Klasse II+IV+Arm)

B Unità specchio (II/IV)
Mirror unit (Class II/Class IV)
Spiegeleinheit (Klasse II/IV)

C Componenti di ricambio
Spare parts
Ersatzteile

Codice Covind
Covind code
Covind Nr.

Codici Originali
O.E.M. Ref.
OE Nummer

Posizione Specchio
Mirror position
Einsetzung des Spiegels

- Particolare presente in assortimento Covind;
Item in Covind Range
Teil in unserer Produktpalette
- Particolare non presente in assortimento Covind
Item not in Covind Range
Teil nicht in unserer Produktpalette

Numero di Omologazione
CE number
Homologations-Nr.

A		B		C		
XXL/508		XXL/522	81637306481			216x167 mm
II (E4)024100 176x379 mm		XXL/524	81637306513			229x187 mm
IV (E4)024101 167x177 mm						
applicability: MAN TGA LX 12/2006 → applicable to: MAN TGM 12/2006 → 11/2014 Verwendbar für: MAN TGL 12/2006 → 11/2014						
a				a		
b				b		328x935 mm
c				c		(E4)024100 176x379 mm
d				d		(E4)024101 177x167 mm
e				e		215x398 mm
f				f		215x398 mm

Dimensioni particolare (larghezza x altezza)
Item dimensions (Width x Height)
Abmessungen des Teiles (Länge * Höhe)

OEMCOVIND

Tabelle Comparative :: Cross References :: Korrespondenztabelle

Cod. Originale O.E.M. Ref. OE Nummer	Cod. Covind Covind Ref. Covind Teilnummer	Pag.Cat. Page Cat. Seite
0280062	XF0/161	196
0280063	XF0/160	196
0287973	XF0/619	99,153,189,219
0673143	XF0/212	133,175,199
0673144	XF0/210	133,175,199
0750899	CF0/210	79
0948779	XF0/ 92	121,156,192
0961229	XF0/215	133,175,199
0962101	CF0/215	79
0962643	XF0/215	133,175,199
0964275	CF6/ 92	52,102
1238280	XF0/ 50	196
1277475	XF0/198	136,178,209
1286384	XF0/400	125,161,201
1290191	XF0/ 90	156,192
1291164	XF0/203	132,176,197
1291165	XF0/202	132,176,197
1291172	XF0/201	174,198
1291173	XF0/200	174,198
1294948	XF0/ 95	194
1294949	XF0/ 94	194
1295613	XF0/101	195
1295614	XF0/100	195
1295619	XF0/ 5	135,177,208
1295620	XF0/ 4	135,177,208
1295732	XF0/241	174,198
1295735	XF0/240	174,198
1296236	CF0/209	80
1296237	CF0/208	80
1298527	CF0/205	80
1298528	CF0/204	80
1298529	CF0/207	80
1298530	CF0/206	80
1298974	CF0/400	58,82

Cod. Originale O.E.M. Ref. OE Nummer	Cod. Covind Covind Ref. Covind Teilnummer	Pag.Cat. Page Cat. Seite
1299417	XF0/163	196
1299418	XF0/162	196
1300041	XF0/ 80	157,193
1300557	XF0/405	126,162,202
1302983	XF0/161	196
1302984	XF0/160	196
1303943	XF2/239	198
1303944	XF2/238	198
1304060	XF0/ 3	135,177,208
1304061	XF0/ 2	135,177,208
1305479	XF0/197	136,178,209
1305480	XF0/196	136,178,209
1305481	XF0/195	136,178,209
1305482	XF0/194	136,178,209
1307510	CF0/207	80
1307511	CF0/206	80
1308492	XF0/ 2	135,177,208
1308555	XF0/415	138,180,211
1308559	XF0/410	138,180,211
1308794	XF0/101	195
1308795	XF0/100	195
1309112	XF0/153	159,195
1309113	XF0/152	158,159,194,195
1309400	XF0/145	196
1309407	XF0/176 KIT	137,179,210
1309408	XF0/175 KIT	137,179,210
1311766	XF0/480	126,162,202
1312789	XF0/150	158,194
1312864	CF0/400	58,82
1312868	CF0/400	58,82
1312872	CF0/480	58,82
1317126	XF0/ 96	157,193
1319676	XF0/ 87	157,193
1319677	XF0/ 86	157,193

Cod. Originale O.E.M. Ref. OE Nummer	Cod. Covind Covind Ref. Covind Teilnummer	Pag.Cat. Page Cat. Seite
1319678	XF0/ 85	157,193
1319679	XF0/ 84	157,193
1324632	CF0/209	80
1324633	CF0/208	80
1326479	CF0/420	94
1328724	CF0/195	76
1328725	CF0/194	76
1328860	XF0/711	-
1328861	XF0/710	-
1328934	XF0/515	90,91,140,141,182, 183,212,213
1328935	XF0/520	90,91,140,141,182, 183,212,213
1329523	XF0/ 87	157,193
1329524	XF0/ 86	157,193
1331209	CF0/425	94
1334108	XF0/103	70,156,192
1334109	XF0/102	70,156,192
1334620	XF0/415	138,180,211
1336467	XF0/158	123,159,195
1336468	XF0/157	123,159,195
1336529	XF0/198	136,178,209
1340450	XF0/510	90,140,182,212
1347131	XF2/239	198
1347132	XF2/238	198
1353802	XF0/ 80	157,193
1354696	XF0/176 KIT	137,179,210
1354697	XF0/175 KIT	137,179,210
1354702	XF0/165	137,179,210
1354703	XF0/164	137,179,210
1355333	CF0/ 3	76
1355334	CF0/ 2	76
1362870	CF0/165	75
1362871	CF0/164	75

OEMCOVIND

Tabella Comparative :: Cross References :: Korrespondenztabelle

Cod. Originale O.E.M. Ref. OE Nummer	Cod. Covind Covind Ref. Covind Teilnummer	Pag.Cat. Page Cat. Seite
1363370	CF0/155	73
1363373	CF0/ 95	72
1363374	CF0/ 94	72
1363375	CF0/ 90	70
1363817	CF0/200	78
1363820	CF0/317	-
1363821	CF0/316	-
1364798	CF0/241	78
1364799	CF0/240	78
1366253	CF0/239	79
1366254	CF0/238	79
1368836	CF0/239	79
1368837	CF0/238	79
1369437	XF0/321	77,134,176
1369438	XF0/320	77,134,176
1369464	CF0/326	-
1371224	XF0/500	66,92,114,148,184,214
1371225	XF0/521	67,93,115,149,185,215
1371226	XF0/521	67,93,115,149,185,215
1371875	CF0/410	84
1372532	CF0/161	75
1372533	CF0/160	75
1372534	CF0/145	74
1372536	CF0/146	74
1372537	CF0/147	-
1372540	CF0/ 50	74
1372801	CF0/101	73
1372802	CF0/100	73
1374568	CF0/175	76
1374569	CF0/174	76
1375876	CF0/150	-
1385178	CF0/101	73
1385179	CF0/100	73
1388016	CF0/321	77,134,176

Cod. Originale O.E.M. Ref. OE Nummer	Cod. Covind Covind Ref. Covind Teilnummer	Pag.Cat. Page Cat. Seite
1388017	CF0/320	77,134,176
1389296	XF0/321	77,134,176
1389297	XF0/320	77,134,176
1396936	XF2/105	123,159
1396937	XF2/104	123,159
1397137	XF0/503	166,206
1398284	XF2/ 99	122,158
1398285	XF2/ 98	122,158
1400004	XF5/145	160
1400011	XF2/161	124,16
1400012	XF2/160	124,16
1400013	XF2/165	124,16
1400014	XF2/164	124,16
1400501	LF0/ 90	15,34
1400502	LF0/ 88	15,16,34,35
1400503	LF0/ 89	15,16,34,35
1400504	LF0/101	15,34
1400505	LF0/100	15,34
1400506	LF0/105	-
1400636	LF0/324	18,37
1400637	LF0/325	18,37
1400699	LF0/146	-
1400710	LF0/161	19,37
1400711	LF0/160	19,37
1400726	LF0/147	-
1400728	LF0/ 3	20,39
1400740	LF0/ 3	20,39
1400741	LF0/ 2	20,39
1401809	LF0/320	18,37
1401810	LF0/321	18,37
1401827	LF0/ 99	32
1401828	LF0/ 98	14,32
1404997	LF0/324	18,37
1404998	LF0/325	18,37

Cod. Originale O.E.M. Ref. OE Nummer	Cod. Covind Covind Ref. Covind Teilnummer	Pag.Cat. Page Cat. Seite
1405002	LF0/320	18,37
1405003	LF0/321	18,37
1405005	LF0/ 91	-
1405007	LF0/ 97	33
1405008	LF0/ 90	15,34
1405010	LF0/ 88	15,16,34,35
1405011	LF0/ 89	15,16,34,35
1405013	LF0/ 99	32
1405015	LF0/ 98	14,32
1405027	LF0/ 96	14,33
1405030	LF0/ 93	14,32
1405031	LF0/ 92	14,32
1405032	LF0/ 94	14,32
1405227	LF0/238	38
1405228	LF0/239	38
1405230	LF0/151	-
1405230	LF0/161	19,37
1405231	LF0/160	19,37
1405241	LF0/215	11,38
1405243	LF0/241	38
1405244	LF0/240	38
1405245	LF0/245	38
1405246	LF0/244	38
1405247	LF0/201	18,37
1405250	LF0/200	18,37
1405262	LF0/241	38
1405263	LF0/240	38
1405264	LF0/245	38
1405265	LF0/244	38
1405672	LF0/ 97	33
1405766	LF0/ 96	14,33
1405767	LF0/ 94	14,32
1405880	LF0/ 93	14,32
1405881	LF0/ 92	14,32

OEMCOVIND

Tabelle Comparative :: Cross References :: Korrespondenztabelle

Cod. Originale O.E.M. Ref. OE Nummer	Cod. Covind Covind Ref. Covind Teilnummer	Pag.Cat. Page Cat. Seite
1405988	LF0/245	38
1405989	LF0/244	38
1405990	LF0/241	38
1405991	LF0/240	38
1407316	LF0/238	38
1407317	LF0/239	38
1407464	LF0/100	15,34
1407465	LF0/101	15,34
1408227	LF0/201	18,37
1408232	LF0/200	18,37
1425105*	XF0/525	164,166,204,206
1425108*	XF0/524	164,204
1425109*	XF0/504	165,167,205,207
1425111*	XF0/505	165,205
1425113	XF0/507	165,167,205,207
1425114	XF0/508	165,205
1425116	XF0/513	167,207
1425118	XF0/512	165,205
1426274	CF0/ 80	71
1426274	CF0/ 90	70
1427140	XF0/ 80	157,193
1434304	CF0/480	58,82
1434334	CF0/485	84
1434957	XF0/158	123,159,195
1436683	XF0/103	70,156,192
1437809	CF0/201	78
1437810	CF0/200	78
1438576	CF0/ 85	70
1438577	CF0/ 84	70
1439348	XF2/105	123,159
1439349	XF2/104	123,159
1440242	CF0/245	78
1440243	CF0/244	78
1440248	CF0/ 90	70

Cod. Originale O.E.M. Ref. OE Nummer	Cod. Covind Covind Ref. Covind Teilnummer	Pag.Cat. Page Cat. Seite
1445563	XF0/237	174
1445564	XF0/236	174
1447281	XF0/237	174
1447282	XF0/236	174
1449528	XF0/103	70,156,192
1449529	XF0/102	70,156,192
1450155	CF0/ 3	76
1450156	CF0/ 2	76
1450976	XF0/ 87	157,193
1450977	XF0/ 86	157,193
1451195	XF5/ 50	124,16
1603386	XF0/619	99,153,189,219
1605932	XF0/237	174
1605933	XF0/236	174
1610182	XF0/505	165,205
1610184*	XF0/525	164,166,204,206
1610187*	XF0/524	164,204
1610189	XF0/524	164,204
1610190*	XF0/504	165,167,205,207
1610191*	XF0/505	165,205
1610263	XF0/503	166,206
1610454	XF0/514	66,92,114,148,184,214
1617040	CF0/195	76
1617041	CF0/194	76
1629036	XF0/526	67,93,115,149,185,215
1629045	XF0/516	66,67,92,93,114,115, 148,149,184,185,214,215
1629046	XF0/519	66,67,92,93,114,115, 148,149,184,185,214,215
1634640	XF5/ 95	120
1635802	XF5/150	122
1638480	CF0/239	79
1638481	CF0/238	79
1640320	CF0/150	-

Cod. Originale O.E.M. Ref. OE Nummer	Cod. Covind Covind Ref. Covind Teilnummer	Pag.Cat. Page Cat. Seite
1641630	XF5/237	132
1641631	XF5/236	132
1642302	XF0/410	138,180,211
1642682	XF5/245	132
1642683	XF5/244	132
1644323	XF5/512	171
1644324	XF5/513	173
1644325	XF5/506	171,173
1644326	XF5/505	171,173
1649363	XF5/ 97	121
1649364	XF5/ 96	121
1649588	XF0/517	90,140,182,212
1650260	CF0/ 97	71
1650261	CF0/ 96	71
1651597	XF0/425	127,163,203
1651601	XF5/ 50	124,16
1651634	CF0/193	76
1651635	CF0/192	76
1656562	CF0/ 90	70
1656563	CF0/ 90	70
1656911	XF0/201	174,198
1656912	XF0/200	174,198
1656917	CF0/201	78
1656918	CF0/200	78
1656923	XF5/201	132
1656924	XF5/200	132
1656977	CF0/200	78
1657685	CF0/152	72
1659248	XF5/506	171,173
1659249	XF5/505	171,173
1659253	XF0/321	77,134,176
1659254	XF0/320	77,134,176
1659257	CF0/321	77,134,176
1659258	CF0/320	77,134,176

OEMCOVIND

Tabelle Comparative :: Cross References :: Korrespondenztafel

Cod. Originale O.E.M. Ref. OE Nummer	Cod. Covind Covind Ref. Covind Teilnummer	Pag.Cat. Page Cat. Seite
1661269	CF0/ 80	71
1662370	XF5/ 80	120
1662373	XF5/ 83	121
1662374	XF5/ 82	121
1667520	XF5/ 83	121
1667521	XF5/ 82	121
1670877*	XF0/524	164,204
1672838	XF0/157	123,159,195
1672923	XF0/158	123,159,195
1674548	XF5/ 80	120
1676218	XF0/ 3	135,177,208
1676219	XF0/ 2	135,177,208
1683721	XF5/ 97	121
1683722	XF5/ 96	121
1683723	CF0/ 97	71
1683724	CF0/ 96	71
1684871	XF5/ 93	121
1684872	XF5/ 92	121
1685330	XF5/502	171,173
1685331	XF5/503	171,173
1689347	XF5/507	86,88,128,130,170,172
1689348	XF5/509	86,88,128,130,170,172
1689404	XF0/157	123,159,195
1693664	XF5/ 83	121
1693665	XF5/ 82	121
1695109	XF5/ 93	121
1695110	XF5/ 92	121
1695228	CF0/241	78
1695229	CF0/240	78
1695234	XF5/245	132
1695235	XF5/244	132
1696660	CF0/ 85	70
1696662	CF0/ 85	70
1696663	CF0/ 84	70

Cod. Originale O.E.M. Ref. OE Nummer	Cod. Covind Covind Ref. Covind Teilnummer	Pag.Cat. Page Cat. Seite
1699468	CF0/ 85	70
1699472	CF0/ 85	70
1699473	CF0/ 84	70
1700265	LF0/503	28,48
1700269	LF0/502	26,46
1700303	LF0/501	24,44
1700306	LF0/500	22,42
1700312	LF0/ 2	20,39
1700387	LF0/110	16,35
1700613	LF0/145	17,36
1700614	LF0/145	17,36
1700801	LF0/ 95	16,35
1700802	LF0/110	16,35
1700862	LF0/ 3	20,39
1700877	LF0/ 92	14,32
1701030	LF0/ 99	32
1701039	LF0/325	18,37
1701040	LF0/324	18,37
1701094	LF0/ 2	20,39
1701374	LF0/ 97	33
1701375	LF0/ 95	16,35
1701826	LF0/145	17,36
1704604	LF0/500	22,42
1704605	LF0/502	26,46
1706904	LF6/ 90	2,8
1706919	LF6/161	4,1
1706920	LF6/160	4,1
1706953	LF6/120	5
1706955	LF6/115	5
1706977	LF6/110	2,8
1706978	LF6/ 95	2,8
1706979	LF6/ 87	3,9
1706980	LF6/ 86	3,9
1706984	LF6/ 89	3,9

Cod. Originale O.E.M. Ref. OE Nummer	Cod. Covind Covind Ref. Covind Teilnummer	Pag.Cat. Page Cat. Seite
1706985	LF6/ 88	3,9
1706986	LF6/ 93	3,9
1706987	LF6/ 92	3,9
1707002	LF6/ 98	5
1707003	LF6/ 99	5
1707123	LF6/150	4,1
1707841	LF6/200	6
1707842	LF6/201	6
1707973	LF6/240	11
1707974	LF6/241	11
1708932	LF6/241	11
1709693	LF6/161	4,1
1709694	LF6/160	4,1
1732653	XF0/619	99,153,189,219
1735004	XF0/158	123,159,195
1735519	LF0/513	24,28,44,48
1735520	LF0/512	22,26,42,46
1736865	LF0/504	-
1736879	LF0/505	-
1736883	LF0/507	-
1736884	LF0/506	-
1736953	LF0/508	-
1736954	LF0/509	-
1738626	XF2/ 99	122,158
1738627	XF2/ 98	122,158
1745335	XF0/619	99,153,189,219
1747244	CF0/145	74
1779721	XF0/167	137,179
1779722	XF0/166	137,179
1781227	LF0/511	24,28,44,48
1781228	LF0/510	22,26,42,46
1785061	CF0/405	59,83
1786644	CF0/145	74
1788487	CF0/502	-

OEMCOVIND

Tabelle Comparative :: Cross References :: Korrespondenztabelle

Cod. Originale O.E.M. Ref. OE Nummer	Cod. Covind Covind Ref. Covind Teilnummer	Pag.Cat. Page Cat. Seite
1788972	CF0/503	-
1788976	CF0/502	-
1796244	XF5/201	132
1796245	XF5/200	132
1798448	XF6/101	104
1798449	XF6/100	104
1798457	XF6/ 89	104
1798458	XF6/ 88	104
1798459	CF6/103	54
1798460	CF6/102	54
1798461	XF6/241	107
1798462	XF6/240	107
1798463	XF6/215	107
1798464	XF6/214	107
1798471	XF6/ 95	103
1798472	XF6/ 94	103
1808561	CF0/501	88
1809265	XF0/201	174,198
1809266	XF0/200	174,198
1812859	CF0/503	-
1812862	XF5/509	86,88,128,130,170,172
1813005	CF0/500	86
1817860	XF5/507	86,88,128,130,170,172
1818353	CF0/502	-
1825005	CF0/ 90	70
1825006	CF0/ 80	71
1825008	XF5/ 95	120
1825434	XF6/115	103
1826225	XF5/ 95	120
1826226	CF0/ 90	70
1826227	CF0/ 80	71
1826510	XF6/105	103
1828855	XF6/231	107
1828856	XF6/230	107

Cod. Originale O.E.M. Ref. OE Nummer	Cod. Covind Covind Ref. Covind Teilnummer	Pag.Cat. Page Cat. Seite
1835023	XF6/201	106
1835024	XF6/200	106
1835064	XF6/251	106
1835065	XF6/250	106
1835102	CF6/251	56
1835103	CF6/250	56
1835170	XF6/ 5	106
1835171	XF6/ 4	106
1835709	XF6/161	105
1835710	XF6/160	105
1835763	XF6/161	105
1836304	XF5/201	132
1836305	XF5/200	132
1836599	CF0/ 3	76
1836600	CF0/ 2	76
1837630	CF6/215	57
1837633	CF6/214	57
1837641	CF6/101	54
1837642	CF6/100	54
1837654	CF6/105	52
1837655	CF6/104	52
1844275	CF6/601	55
1844276	CF6/600	55
1848557	CF6/ 97	52
1848558	CF6/ 96	52
1852468	LF0/150	17,36
1852469	LF0/135	17,36
1852532	LF0/140	17,36
1852685	CF0/ 90	70
1861672	XF6/201	106
1861673	XF6/200	106
1861949	XF6/ 99	104
1861950	XF6/ 98	104
1861983	XF6/115	103

Cod. Originale O.E.M. Ref. OE Nummer	Cod. Covind Covind Ref. Covind Teilnummer	Pag.Cat. Page Cat. Seite
1862945	XF2/105	123,159
1862946	XF2/104	123,159
1869588	XF6/ 90	102
1870502	CF6/201	56
1870503	CF6/200	56
1875549	XF5/517	60,61,62,63,108,109, 110,111,142,143,144,145
1875550	XF5/516	60,61,62,63,108,109, 110,111,142,143,144,145
1875551	XF5/520	60,61,62,63,108,109, 110,111,142,143,144,145
1875552	XF5/525	64,65,112,113,146,147
1875553	XF5/519	60,61,108,109,142,143
1875554	XF5/518	60,61,108,109,142,143
1875567	XF5/510	60,62,108,110,142,144
1876631	CF6/ 90	52
1880378	XF6/ 95	103
1880379	XF6/ 94	103
1880397	XF6/ 97	103
1880398	XF6/ 96	103
1881344	CF6/241	57
1881345	CF6/240	57
1881346	CF6/231	57
1881347	CF6/230	57
1881350	CF6/ 99	54
1881351	CF6/ 98	54
1886591	XF6/150	105
1886592	CF6/150	53
1887134	CF6/ 95	54
1887135	CF6/ 94	54
1887709	XF6/145	105
1892197	XF5/523	62,63,110,111,144,145
1892198	XF5/522	62,63,110,111,144,145
1892245	XF5/529	64,65,112,113,146,147

OEMCOVIND

Tabelle Comparative :: Cross References :: Korrespondenztabelle

Cod. Originale O.E.M. Ref. OE Nummer	Cod. Covind Covind Ref. Covind Teilnummer	Pag.Cat. Page Cat. Seite
1892246	XF5/528	64,65,112,113,146,147
1892247	XF5/527	64,65,112,113,146,147
1892248	XF5/526	64,65,112,113,146,147
1893901	CF0/201	78
1893902	CF0/200	78
1895877	CF6/ 89	54
1895878	CF6/ 88	54
1911137	XF0/ 5	135,177,208
1911138	XF0/ 4	135,177,208
1911154	CF0/241	78
1911155	CF0/240	78
1918145	XF0/167	137,179
1918146	XF0/166	137,179
1922030	XF6/ 89	104
1922031	XF6/ 88	104
1922985	CF6/ 89	54
1922986	CF6/ 88	54
1927847	XF5/515	60,62,64,108,110, 112,142,144,146
1936285	XF6/145	105
1940526	CF0/ 3	76
1940527	CF0/ 2	76
1945871	XF6/215	107
1945872	XF6/214	107
1945873	CF6/215	57
1945874	CF6/214	57
1948151	CF6/103	54
1948152	CF6/102	54
1948243	XF6/241	107
1948244	XF6/240	107
1952141	CF0/501	88
1952146	CF0/500	86
1952791	CF6/241	57
1952792	CF6/240	57

Cod. Originale O.E.M. Ref. OE Nummer	Cod. Covind Covind Ref. Covind Teilnummer	Pag.Cat. Page Cat. Seite
1953385	XF6/ 90	102
1954514	XF5/150	122
1973359	XF5/ 97	121
1973360	XF5/ 96	121
1997257	CF0/321	77,134,176
1997258	CF0/320	77,134,176
1997261	XF0/321	77,134,176
1997262	XF0/320	77,134,176
2011376	XF6/ 89	104
2011377	XF6/ 88	104
2041670	XF6/ 4	106
2041699	XF6/ 5	106
2050044	XF0/518	66,67,92,93,114,115, 148,149,184,185,214,215
-	XF0/175	137,179,210
-	XF0/176	137,179,210
-	XF0/192	136,178,209
-	XF0/193	136,178,209
-	XF0/502	164,204
-	XF5/500	128,17
-	XF5/501	130,172
-	XF5/532	62,63,110,111,144,145
-	XF5/533	62,63,110,111,144,145
-	XF5/536	64,65,112,113,146,147
-	XF5/537	64,65,112,113,146,147
-	XF5/538	60,61,108,109,142,143
-	XF5/539	60,61,108,109,142,143
IVECO		
2993918	240/677	98,152,188,218
4821320	038/678	98,152,188,218
41003248	240/677	98,152,188,218
41026756	240/655	99,153,189,219
41042699	240/675	98,152,188,218
98497821	240/675	98,152,188,218

Cod. Originale O.E.M. Ref. OE Nummer	Cod. Covind Covind Ref. Covind Teilnummer	Pag.Cat. Page Cat. Seite
99430053	240/650	99,153,189,219
500043667	240/677	98,152,188,218
RENAULT		
1400730	385/ 7	20,39
1400731	385/ 6	20,39
1400753	385/165	21,4
1400753	385/175	21,4
1400754	385/164	21,4
1400754	385/174	21,4
1400769	385/195	20,39
1400778	385/194	20,39
1406622	385/194	20,39
1407256	385/195	20,39
1409576	PRM/513	-
1409581	PRM/512	-
1705698	385/165	21,4
1705698	385/175	21,4
1705699	385/164	21,4
1705699	385/174	21,4
1707356	385/165	21,4
1707357	385/164	21,4
1733892	PRM/509	-
1733893	PRM/508	-
1736923	PRM/512	-
1736924	PRM/513	-
1737933	PRM/504	-
-	PRM/522	-
-	PRM/523	-
ACCESSORI		
-	930/001	96,97,116,117,150, 151,186,187,216,217
-	930/002	96,97,116,117,150, 151,186,187,216,217
-	930/032	96,97,116,117,150,

Cod. Covind Covind Ref. Covind Teilnummer	Cod. Originale O.E.M. Ref. OE Nummer	Pag.Cat. Page Cat. Seite
CF0/ 2	1940527	76
CF0/ 2	1355334	76
CF0/ 2	1450156	76
CF0/ 2	1836600	76
CF0/ 3	1940526	76
CF0/ 3	1355333	76
CF0/ 3	1450155	76
CF0/ 3	1836599	76
CF0/ 50	1372540	74
CF0/ 80	1826227	71
CF0/ 80	1426274	71
CF0/ 80	1661269	71
CF0/ 80	1825006	71
CF0/ 84	1699473	70
CF0/ 84	1438577	70
CF0/ 84	1696663	70
CF0/ 85	1699468	70
CF0/ 85	1438576	70
CF0/ 85	1696660	70
CF0/ 85	1696662	70
CF0/ 85	1699472	70
CF0/ 90	1825005	70
CF0/ 90	1363375	70
CF0/ 90	1426274	70
CF0/ 90	1440248	70
CF0/ 90	1656562	70
CF0/ 90	1656563	70
CF0/ 90	1826226	70
CF0/ 90	1852685	70
CF0/ 94	1363374	72
CF0/ 95	1363373	72
CF0/ 96	1683724	71
CF0/ 96	1650261	71
CF0/ 97	1683723	71

Cod. Covind Covind Ref. Covind Teilnummer	Cod. Originale O.E.M. Ref. OE Nummer	Pag.Cat. Page Cat. Seite
CF0/ 97	1650260	71
CF0/100	1372802	73
CF0/100	1385179	73
CF0/101	1372801	73
CF0/101	1385178	73
CF0/145	1786644	74
CF0/145	1372534	74
CF0/145	1747244	74
CF0/146	1372536	74
CF0/147	1372537	-
CF0/150	1375876	-
CF0/150	1640320	-
CF0/152	1657685	72
CF0/155	1363370	73
CF0/160	1372533	75
CF0/161	1372532	75
CF0/164	1362871	75
CF0/165	1362870	75
CF0/174	1374569	76
CF0/175	1374568	76
CF0/192	1651635	76
CF0/193	1651634	76
CF0/194	1617041	76
CF0/194	1328725	76
CF0/195	1617040	76
CF0/195	1328724	76
CF0/200	1893902	78
CF0/200	1363817	78
CF0/200	1437810	78
CF0/200	1656918	78
CF0/200	1656977	78
CF0/201	1893901	78
CF0/201	1437809	78
CF0/201	1656917	78

Cod. Covind Covind Ref. Covind Teilnummer	Cod. Originale O.E.M. Ref. OE Nummer	Pag.Cat. Page Cat. Seite
CF0/204	1298528	80
CF0/205	1298527	80
CF0/206	1307511	80
CF0/206	1298530	80
CF0/207	1307510	80
CF0/207	1298529	80
CF0/208	1324633	80
CF0/208	1296237	80
CF0/209	1324632	80
CF0/209	1296236	80
CF0/210	0750899	79
CF0/215	0962101	79
CF0/238	1638481	79
CF0/238	1366254	79
CF0/238	1368837	79
CF0/239	1638480	79
CF0/239	1366253	79
CF0/239	1368836	79
CF0/240	1911155	78
CF0/240	1364799	78
CF0/240	1695229	78
CF0/241	1911154	78
CF0/241	1364798	78
CF0/241	1695228	78
CF0/244	1440243	78
CF0/245	1440242	78
CF0/316	1363821	-
CF0/317	1363820	-
CF0/320	1997258	77,134,176
CF0/320	1388017	77,134,176
CF0/320	1659258	77,134,176
CF0/321	1997257	77,134,176
CF0/321	1388016	77,134,176
CF0/321	1659257	77,134,176

Cod. Covind Covind Ref. Covind Teilnummer	Cod. Originale O.E.M. Ref. OE Nummer	Pag.Cat. Page Cat. Seite	Cod. Covind Covind Ref. Covind Teilnummer	Cod. Originale O.E.M. Ref. OE Nummer	Pag.Cat. Page Cat. Seite	Cod. Covind Covind Ref. Covind Teilnummer	Cod. Originale O.E.M. Ref. OE Nummer	Pag.Cat. Page Cat. Seite
CF0/326	1369464	-	CF6/102	1948152	54	LF0/ 90	1400501	15,34
CF0/400	1312864	58,82	CF6/102	1798460	54	LF0/ 91	1405005	-
CF0/400	1298974	58,82	CF6/103	1948151	54	LF0/ 92	1405881	14,32
CF0/400	1312868	58,82	CF6/103	1798459	54	LF0/ 92	1405031	14,32
CF0/405	1785061	59,83	CF6/104	1837655	52	LF0/ 92	1700877	14,32
CF0/410	1371875	84	CF6/105	1837654	52	LF0/ 93	1405880	14,32
CF0/420	1326479	94	CF6/150	1886592	53	LF0/ 93	1405030	14,32
CF0/425	1331209	94	CF6/200	1870503	56	LF0/ 94	1405767	14,32
CF0/480	1434304	58,82	CF6/201	1870502	56	LF0/ 94	1405032	14,32
CF0/480	1312872	58,82	CF6/214	1945874	57	LF0/ 95	1701375	16,35
CF0/485	1434334	84	CF6/214	1837633	57	LF0/ 95	1700801	16,35
CF0/500	1952146	86	CF6/215	1945873	57	LF0/ 96	1405766	14,33
CF0/500	1813005	86	CF6/215	1837630	57	LF0/ 96	1405027	14,33
CF0/501	1952141	88	CF6/230	1881347	57	LF0/ 97	1405672	33
CF0/501	1808561	88	CF6/231	1881346	57	LF0/ 97	1405007	33
CF0/502	1818353	-	CF6/240	1952792	57	LF0/ 97	1701374	33
CF0/502	1788487	-	CF6/240	1881345	57	LF0/ 98	1405015	14,32
CF0/502	1788976	-	CF6/241	1952791	57	LF0/ 98	1401828	14,32
CF0/503	1812859	-	CF6/241	1881344	57	LF0/ 99	1405013	32
CF0/503	1788972	-	CF6/250	1835103	56	LF0/ 99	1401827	32
CF6/ 88	1922986	54	CF6/251	1835102	56	LF0/ 99	1701030	32
CF6/ 88	1895878	54	CF6/600	1844276	55	LF0/100	1407464	15,34
CF6/ 89	1922985	54	CF6/601	1844275	55	LF0/100	1400505	15,34
CF6/ 89	1895877	54	LF0/ 2	1701094	20,39	LF0/101	1407465	15,34
CF6/ 90	1876631	52	LF0/ 2	1400741	20,39	LF0/101	1400504	15,34
CF6/ 92	964275	52,102	LF0/ 2	1700312	20,39	LF0/105	1400506	-
CF6/ 94	1887135	54	LF0/ 3	1700862	20,39	LF0/110	1700802	16,35
CF6/ 95	1887134	54	LF0/ 3	1400728	20,39	LF0/110	1700387	16,35
CF6/ 96	1848558	52	LF0/ 3	1400740	20,39	LF0/135	1852469	17,36
CF6/ 97	1848557	52	LF0/ 88	1405010	15,16,34,35	LF0/140	1852532	17,36
CF6/ 98	1881351	54	LF0/ 88	1400502	15,16,34,35	LF0/145	1700613	17,36
CF6/ 99	1881350	54	LF0/ 89	1405011	15,16,34,35	LF0/145	1700614	17,36
CF6/100	1837642	54	LF0/ 89	1400503	15,16,34,35	LF0/145	1701826	17,36
CF6/101	1837641	54	LF0/ 90	1405008	15,34	LF0/146	1400699	-

Cod. Covind Covind Ref. Covind Teilnummer	Cod. Originale O.E.M. Ref. OE Nummer	Pag.Cat. Page Cat. Seite	Cod. Covind Covind Ref. Covind Teilnummer	Cod. Originale O.E.M. Ref. OE Nummer	Pag.Cat. Page Cat. Seite	Cod. Covind Covind Ref. Covind Teilnummer	Cod. Originale O.E.M. Ref. OE Nummer	Pag.Cat. Page Cat. Seite
LF0/147	1400726	-	LF0/324	1701040	18,37	LF6/160	1709694	4,1
LF0/150	1852468	17,36	LF0/325	1404998	18,37	LF6/160	1706920	4,1
LF0/151	1405230	-	LF0/325	1400637	18,37	LF6/161	1709693	4,1
LF0/160	1400711	19,37	LF0/325	1701039	18,37	LF6/161	1706919	4,1
LF0/160	1405231	19,37	LF0/500	1704604	22,42	LF6/200	1707841	6
LF0/161	1400710	19,37	LF0/500	1700306	22,42	LF6/201	1707842	6
LF0/161	1405230	19,37	LF0/501	1700303	24,44	LF6/240	1707973	11
LF0/200	1405250	18,37	LF0/502	1704605	26,46	LF6/241	1708932	11
LF0/200	1408232	18,37	LF0/502	1700269	26,46	LF6/241	1707974	11
LF0/201	1405247	18,37	LF0/503	1700265	28,48	XF0/ 2	1676219	135,177,208
LF0/201	1408227	18,37	LF0/504	1736865	-	XF0/ 2	1304061	135,177,208
LF0/215	1405241	11,38	LF0/505	1736879	-	XF0/ 2	1308492	135,177,208
LF0/238	1407316	38	LF0/506	1736884	-	XF0/ 3	1676218	135,177,208
LF0/238	1405227	38	LF0/507	1736883	-	XF0/ 3	1304060	135,177,208
LF0/239	1407317	38	LF0/508	1736953	-	XF0/ 4	1295620	135,177,208
LF0/239	1405228	38	LF0/509	1736954	-	XF0/ 4	1911138	135,177,208
LF0/240	1405991	38	LF0/510	1781228	22,26,42,46	XF0/ 5	1295619	135,177,208
LF0/240	1405244	38	LF0/511	1781227	24,28,44,48	XF0/ 5	1911137	135,177,208
LF0/240	1405263	38	LF0/512	1735520	22,26,42,46	XF0/ 50	1238280	196
LF0/241	1405990	38	LF0/513	1735519	24,28,44,48	XF0/ 80	1427140	157,193
LF0/241	1405243	38	LF6/ 86	1706980	3,9	XF0/ 80	1300041	157,193
LF0/241	1405262	38	LF6/ 87	1706979	3,9	XF0/ 80	1353802	157,193
LF0/244	1405989	38	LF6/ 88	1706985	3,9	XF0/ 84	1319679	157,193
LF0/244	1405246	38	LF6/ 89	1706984	3,9	XF0/ 85	1319678	157,193
LF0/244	1405265	38	LF6/ 90	1706904	2,8	XF0/ 86	1450977	157,193
LF0/245	1405988	38	LF6/ 92	1706987	3,9	XF0/ 86	1319677	157,193
LF0/245	1405245	38	LF6/ 93	1706986	3,9	XF0/ 86	1329524	157,193
LF0/245	1405264	38	LF6/ 95	1706978	2,8	XF0/ 87	1450976	157,193
LF0/320	1405002	18,37	LF6/ 98	1707002	5	XF0/ 87	1319676	157,193
LF0/320	1401809	18,37	LF6/ 99	1707003	5	XF0/ 87	1329523	157,193
LF0/321	1405003	18,37	LF6/110	1706977	2,8	XF0/ 90	1290191	156,192
LF0/321	1401810	18,37	LF6/115	1706955	5	XF0/ 92	0948779	121,156,192
LF0/324	1404997	18,37	LF6/120	1706953	5	XF0/ 94	1294949	194
LF0/324	1400636	18,37	LF6/150	1707123	4,1	XF0/ 95	1294948	194

Cod. Covind Covind Ref. Covind Teilnummer	Cod. Originale O.E.M. Ref. OE Nummer	Pag.Cat. Page Cat. Seite
XF0/96	1317126	157,193
XF0/100	1308795	195
XF0/100	1295614	195
XF0/101	1308794	195
XF0/101	1295613	195
XF0/102	1449529	70,156,192
XF0/102	1334109	70,156,192
XF0/103	1449528	70,156,192
XF0/103	1334108	70,156,192
XF0/103	1436683	70,156,192
XF0/145	1309400	196
XF0/150	1312789	158,194
XF0/152	1309113	158,159,194,195
XF0/153	1309112	159,195
XF0/157	1689404	123,159,195
XF0/157	1336468	123,159,195
XF0/157	1672838	123,159,195
XF0/158	1735004	123,159,195
XF0/158	1336467	123,159,195
XF0/158	1434957	123,159,195
XF0/158	1672923	123,159,195
XF0/160	1302984	196
XF0/160	0280063	196
XF0/161	1302983	196
XF0/161	0280062	196
XF0/162	1299418	196
XF0/163	1299417	196
XF0/164	1354703	137,179,210
XF0/165	1354702	137,179,210
XF0/166	1918146	137,179
XF0/166	1779722	137,179
XF0/167	1918145	137,179
XF0/167	1779721	137,179
XF0/175	-	137,179,210

Cod. Covind Covind Ref. Covind Teilnummer	Cod. Originale O.E.M. Ref. OE Nummer	Pag.Cat. Page Cat. Seite
XF0/175 KIT	1309408	137,179,210
XF0/175 KIT	1354697	137,179,210
XF0/176	-	137,179,210
XF0/176 KIT	1309407	137,179,210
XF0/176 KIT	1354696	137,179,210
XF0/192	-	136,178,209
XF0/193	-	136,178,209
XF0/194	1305482	136,178,209
XF0/195	1305481	136,178,209
XF0/196	1305480	136,178,209
XF0/197	1305479	136,178,209
XF0/198	1336529	136,178,209
XF0/198	1277475	136,178,209
XF0/200	1809266	174,198
XF0/200	1291173	174,198
XF0/200	1656912	174,198
XF0/201	1809265	174,198
XF0/201	1291172	174,198
XF0/201	1656911	174,198
XF0/202	1291165	132,176,197
XF0/203	1291164	132,176,197
XF0/210	0673144	133,175,199
XF0/212	0673143	133,175,199
XF0/215	0962643	133,175,199
XF0/215	0961229	133,175,199
XF0/236	1605933	174
XF0/236	1445564	174
XF0/236	1447282	174
XF0/237	1605932	174
XF0/237	1445563	174
XF0/237	1447281	174
XF0/240	1295735	174,198
XF0/241	1295732	174,198
XF0/320	1997262	77,134,176

Cod. Covind Covind Ref. Covind Teilnummer	Cod. Originale O.E.M. Ref. OE Nummer	Pag.Cat. Page Cat. Seite
XF0/320	1369438	77,134,176
XF0/320	1389297	77,134,176
XF0/320	1659254	77,134,176
XF0/321	1997261	77,134,176
XF0/321	1369437	77,134,176
XF0/321	1389296	77,134,176
XF0/321	1659253	77,134,176
XF0/400	1286384	125,161,201
XF0/405	1300557	126,162,202
XF0/410	1642302	138,180,211
XF0/410	1308559	138,180,211
XF0/415	1334620	138,180,211
XF0/415	1308555	138,180,211
XF0/425	1651597	127,163,203
XF0/480	1311766	126,162,202
XF0/500	1371224	66,92,114,148,184,214
XF0/502	-	164,204
XF0/503	1610263	166,206
XF0/503	1397137	166,206
XF0/504	1610190*	165,167,205,207
XF0/504	1425109*	165,167,205,207
XF0/505	1610182	165,205
XF0/505	1425111*	165,205
XF0/505	1610191*	165,205
XF0/507	1425113	165,167,205,207
XF0/508	1425114	165,205
XF0/510	1340450	90,140,182,212
XF0/512	1425118	165,205
XF0/513	1425116	167,207
XF0/514	1610454	66,92,114,148,184,214
XF0/515	1328934	90,91,140,141,182,183,212,213
XF0/516	1629045	66,67,92,93,114,115,148,149,184,185,214,215

Cod. Covind Covind Ref. Covind Teilnummer	Cod. Originale O.E.M. Ref. OE Nummer	Pag.Cat. Page Cat. Seite
XF0/517	1649588	90,140,182,212
XF0/518	2050044	66,67,92,93,114,115, 148,149,184,185,214,215
XF0/519	1629046	66,67,92,93,114,115, 148,149,184,185,214,215
XF0/520	1328935	90,91,140,141, 182,183,212,213
XF0/521	1371226	67,93,115,149,185,215
XF0/521	1371225	67,93,115,149,185,215
XF0/524	1610189	164,204
XF0/524	1425108*	164,204
XF0/524	1610187*	164,204
XF0/524	1670877*	164,204
XF0/525	1610184*	164,166,204,206
XF0/525	1425105*	164,166,204,206
XF0/526	1629036	67,93,115,149,185,215
XF0/619	1745335	99,153,189,219
XF0/619	0287973	99,153,189,219
XF0/619	1603386	99,153,189,219
XF0/619	1732653	99,153,189,219
XF0/710	1328861	-
XF0/711	1328860	-
XF2/ 98	1398285	122,158
XF2/ 98	1738627	122,158
XF2/ 99	1398284	122,158
XF2/ 99	1738626	122,158
XF2/104	1862946	123,159
XF2/104	1396937	123,159
XF2/104	1439349	123,159
XF2/105	1862945	123,159
XF2/105	1396936	123,159
XF2/105	1439348	123,159
XF2/160	1400012	124,16
XF2/161	1400011	124,16

Cod. Covind Covind Ref. Covind Teilnummer	Cod. Originale O.E.M. Ref. OE Nummer	Pag.Cat. Page Cat. Seite
XF2/164	1400014	124,16
XF2/165	1400013	124,16
XF2/238	1347132	198
XF2/238	1303944	198
XF2/239	1347131	198
XF2/239	1303943	198
XF5/ 50	1651601	124,16
XF5/ 50	1451195	124,16
XF5/ 80	1674548	120
XF5/ 80	1662370	120
XF5/ 82	1693665	121
XF5/ 82	1662374	121
XF5/ 82	1667521	121
XF5/ 83	1693664	121
XF5/ 83	1662373	121
XF5/ 83	1667520	121
XF5/ 92	1695110	121
XF5/ 92	1684872	121
XF5/ 93	1695109	121
XF5/ 93	1684871	121
XF5/ 95	1825008	120
XF5/ 95	1634640	120
XF5/ 95	1826225	120
XF5/ 96	1973360	121
XF5/ 96	1649364	121
XF5/ 96	1683722	121
XF5/ 97	1973359	121
XF5/ 97	1649363	121
XF5/ 97	1683721	121
XF5/145	1400004	160
XF5/150	1954514	122
XF5/150	1635802	122
XF5/200	1836305	132
XF5/200	1656924	132

Cod. Covind Covind Ref. Covind Teilnummer	Cod. Originale O.E.M. Ref. OE Nummer	Pag.Cat. Page Cat. Seite
XF5/200	1796245	132
XF5/201	1836304	132
XF5/201	1656923	132
XF5/201	1796244	132
XF5/236	1641631	132
XF5/237	1641630	132
XF5/244	1642683	132
XF5/244	1695235	132
XF5/245	1642682	132
XF5/245	1695234	132
XF5/500	-	128,17
XF5/501	-	130,172
XF5/502	1685330	171,173
XF5/503	1685331	171,173
XF5/505	1644326	171,173
XF5/505	1659249	171,173
XF5/506	1644325	171,173
XF5/506	1659248	171,173
XF5/507	1817860	86,88,128,130,170,172
XF5/507	1689347	86,88,128,130,170,172
XF5/509	1812862	86,88,128,130,170,172
XF5/509	1689348	86,88,128,130,170,172
XF5/510	1875567	60,62,108,110,142,144
XF5/512	1644323	171
XF5/513	1644324	173
XF5/515	1927847	60,62,64,108,110, 112,142,144,146
XF5/516	1875550	60,61,62,63,108,109, 110,111,142,143,144,145
XF5/517	1875549	60,61,62,63,108,109, 110,111,142,143,144,145
XF5/518	1875554	60,61,108,109,142,143
XF5/519	1875553	60,61,108,109,142,143
XF5/520	1875551	60,61,62,63,108,109,

Cod. Covind Covind Ref. Covind Teilnummer	Cod. Originale O.E.M. Ref. OE Nummer	Pag.Cat. Page Cat. Seite
XF5/520	1875551	110,111,142,143,144,145
XF5/522	1892198	62,63,110,111,144,145
XF5/523	1892197	62,63,110,111,144,145
XF5/525	1875552	64,65,112,113,146,147
XF5/526	1892248	64,65,112,113,146,147
XF5/527	1892247	64,65,112,113,146,147
XF5/528	1892246	64,65,112,113,146,147
XF5/529	1892245	64,65,112,113,146,147
XF5/532	-	62,63,110,111,144,145
XF5/533	-	62,63,110,111,144,145
XF5/536	-	64,65,112,113,146,147
XF5/537	-	64,65,112,113,146,147
XF5/538	-	60,61,108,109,142,143
XF5/539	-	60,61,108,109,142,143
XF6/ 4	2041670	106
XF6/ 4	1835171	106
XF6/ 5	2041699	106
XF6/ 5	1835170	106
XF6/ 88	1922031	104
XF6/ 88	1798458	104
XF6/ 88	2011377	104
XF6/ 89	1922030	104
XF6/ 89	1798457	104
XF6/ 89	2011376	104
XF6/ 90	1953385	102
XF6/ 90	1869588	102
XF6/ 94	1880379	103
XF6/ 94	1798472	103
XF6/ 95	1880378	103
XF6/ 95	1798471	103
XF6/ 96	1880398	103
XF6/ 97	1880397	103
XF6/ 98	1861950	104
XF6/ 99	1861949	104

Cod. Covind Covind Ref. Covind Teilnummer	Cod. Originale O.E.M. Ref. OE Nummer	Pag.Cat. Page Cat. Seite
XF6/100	1798449	104
XF6/101	1798448	104
XF6/105	1826510	103
XF6/115	1861983	103
XF6/115	1825434	103
XF6/145	1936285	105
XF6/145	1887709	105
XF6/150	1886591	105
XF6/160	1835710	105
XF6/161	1835709	105
XF6/161	1835763	105
XF6/200	1861673	106
XF6/200	1835024	106
XF6/201	1861672	106
XF6/201	1835023	106
XF6/214	1945872	107
XF6/214	1798464	107
XF6/215	1945871	107
XF6/215	1798463	107
XF6/230	1828856	107
XF6/231	1828855	107
XF6/240	1948244	107
XF6/240	1798462	107
XF6/241	1948243	107
XF6/241	1798461	107
XF6/250	1835065	106
XF6/251	1835064	106
IVECO		
038/678	4821320	98,152,188,218
240/650	99430053	99,153,189,219
240/655	41026756	99,153,189,219
240/675	41042699	98,152,188,218
240/675	98497821	98,152,188,218
240/677	500043667	98,152,188,218

Cod. Covind Covind Ref. Covind Teilnummer	Cod. Originale O.E.M. Ref. OE Nummer	Pag.Cat. Page Cat. Seite
240/677	2993918	98,152,188,218
240/677	41003248	98,152,188,218
RENAULT		
385/ 6	1400731	20,39
385/ 7	1400730	20,39
385/164	1400754	21,4
385/164	1705699	21,4
385/164	1707357	21,4
385/165	1400753	21,4
385/165	1705698	21,4
385/165	1707356	21,4
385/174	1400754	21,4
385/174	1705699	21,4
385/175	1400753	21,4
385/175	1705698	21,4
385/194	1400778	20,39
385/194	1406622	20,39
385/195	1400769	20,39
385/195	1407256	20,39
PRM/504	1737933	-
PRM/508	1733893	-
PRM/509	1733892	-
PRM/512	1736923	-
PRM/512	1409581	-
PRM/513	1736924	-
PRM/513	1409576	-
PRM/522	-	-
PRM/523	-	-
ACCESSORI		
930/001	-	96,97,116,117,150, 151,186,187,216,217
930/002	-	96,97,116,117,150, 151,186,187,216,217
930/032	-	96,97,116,117,150,

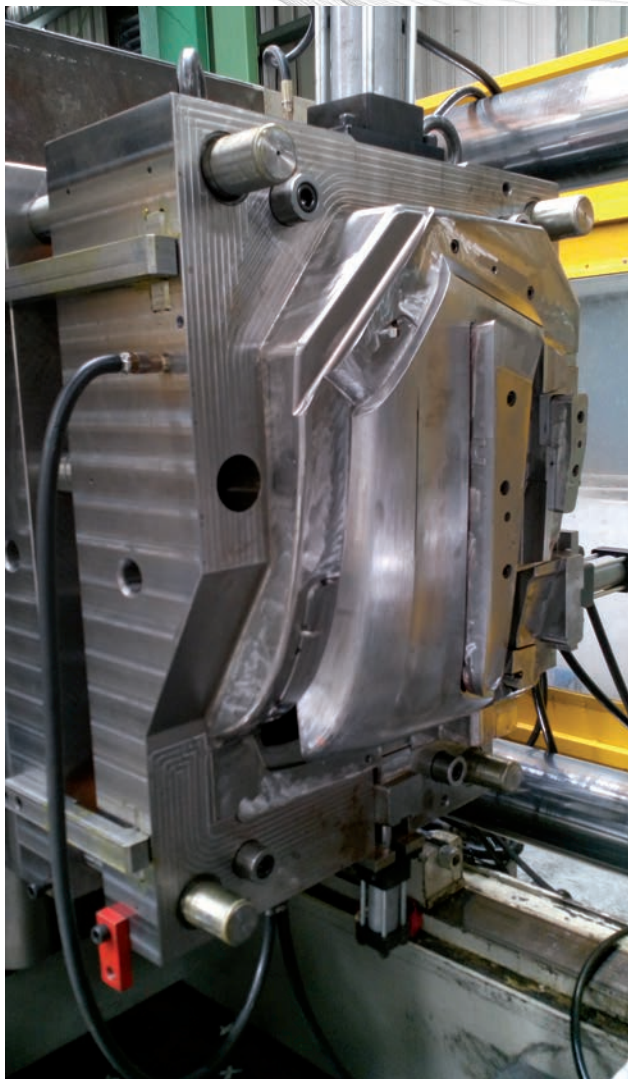

- IT Stampo in acciaio per la produzione angolare posteriore inferiore Mercedes-Benz.
EN Steel mould for the production of lower rear side bumper of Mercedes-Benz.
DE Stahlform zur Herstellung von Bus-Stoßbecken hinten für Mercedes-Benz.



- ▲
- IT Stampo (punzone) per la produzione della griglia superiore in lamiera per il veicolo Scania (Cod. Covind SCR/145)
- EN Mould (punch) for the production of the upper metal grill for the Scania vehicles (Cod. Covind SCR/145)
- DE Stahlform für die Produktion der Scania oberer Grill aus Blech (Covind Nr. SCR/145)



applicabile a | suitable to | verwendbar für

1

LF6
LF 45 Euro6

applicabile a I suitable to I verwendbar für:

LF45 Euro 6

(*) vernice di fondo - unprocessed - grundiert
(°) verniciato grigio - grey painted - grau strukturlackiert

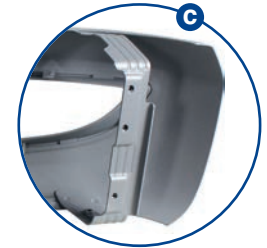
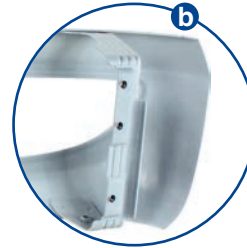
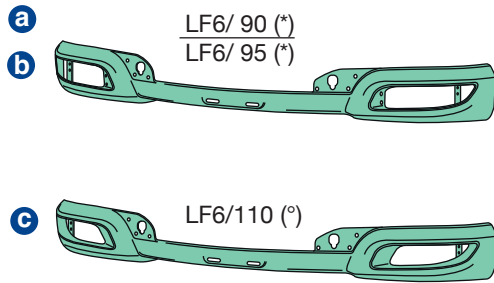

LF6/ 90
O.E.M. 1706904



LF6/ 95
O.E.M. 1706978



LF6/110
O.E.M. 1706977

(*) vernice di fondo - unprocessed - grundiert
(°) verniciato grigio - grey painted - grau strukturlackiert

applicabile a | suitable to | verwendbar für:

LF45 Euro 6

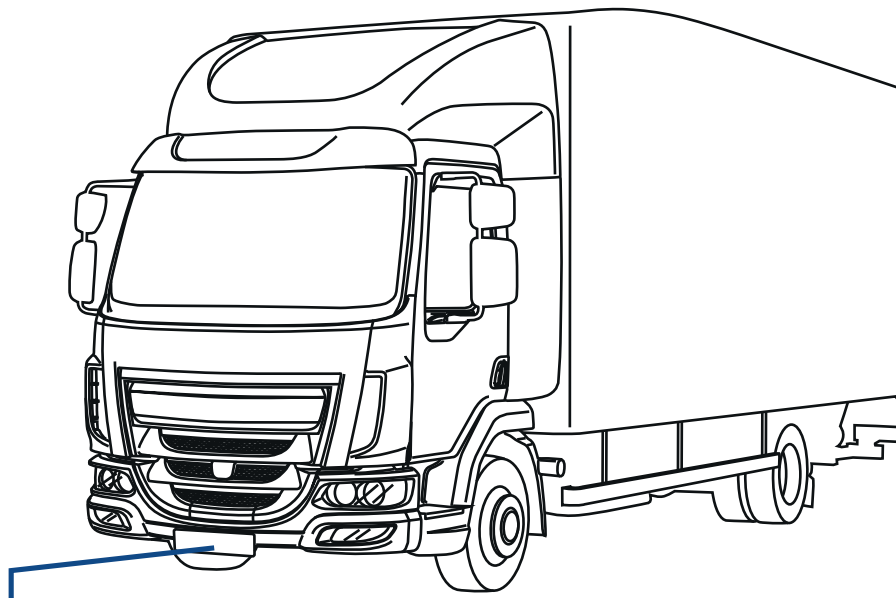

LF6/ 86 (°) d-rh-rechts
LF6/ 88 (*) d-rh-rechts

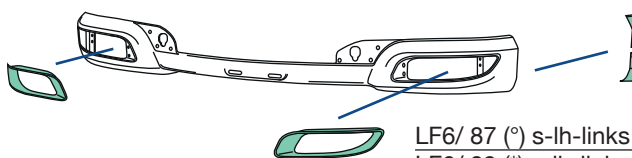

LF6/ 92 d-rh-rechts
LF6/ 93 s-lh-links

LF6/ 87 (°) s-lh-links
LF6/ 89 (*) s-lh-links



LF6/ 86
O.E.M. 1706980
LF6/ 87
O.E.M. 1706979



LF6/ 88
O.E.M. 1706985
LF6/ 89
O.E.M. 1706984



LF6/ 92
O.E.M. 1706987
LF6/ 93
O.E.M. 1706986

applicabile a I suitable to I verwendbar für:

LF45 Euro 6

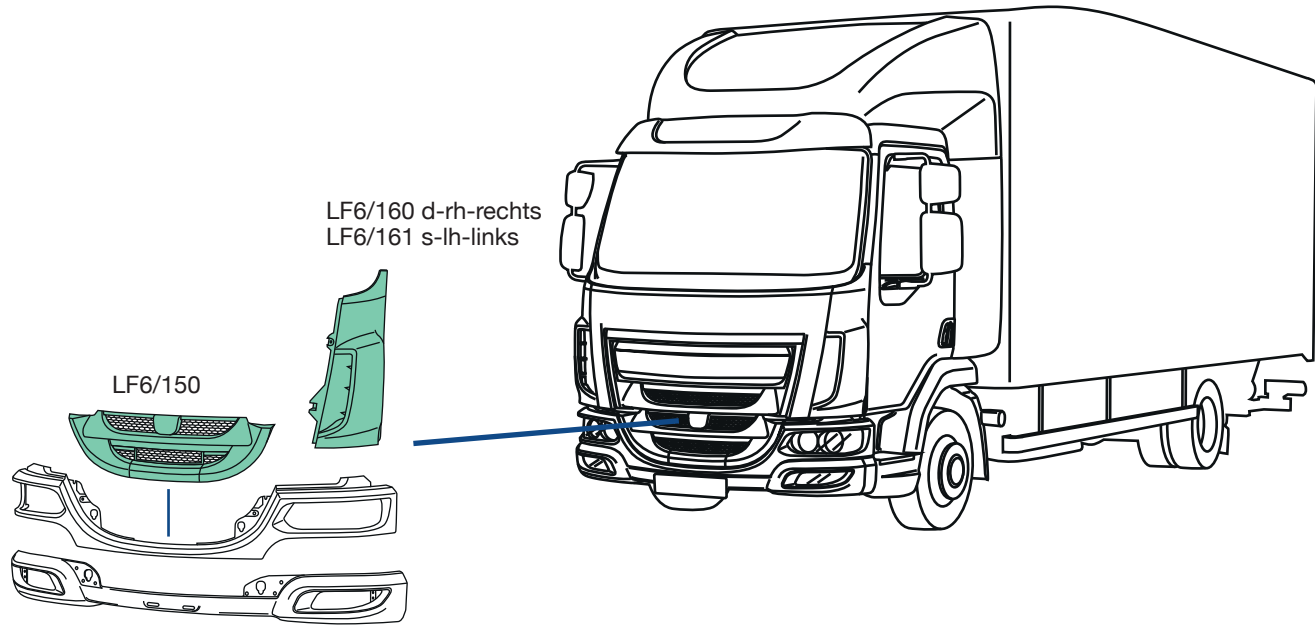

LF6/150
O.E.M. 1707123



LF6/160
O.E.M. 1709694
LF6/161
O.E.M. 1709693

LF45 Euro 6

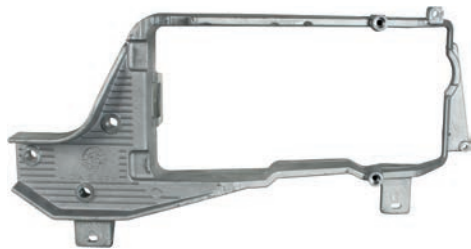
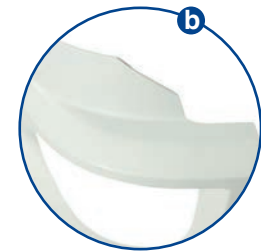
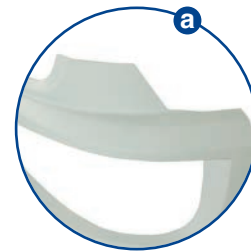
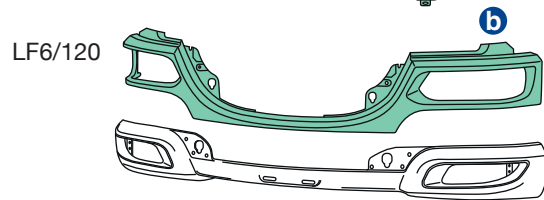
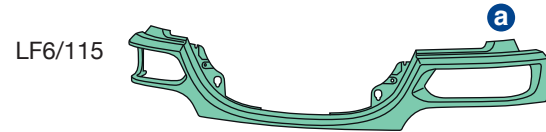

LF6/ 98
O.E.M. 1707002
LF6/ 99
O.E.M. 1707003



LF6/115
O.E.M. 1706955



LF6/120
O.E.M. 1706953

applicabile a | suitable to | verwendbar für:

LF45 Euro 6

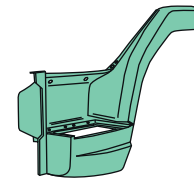
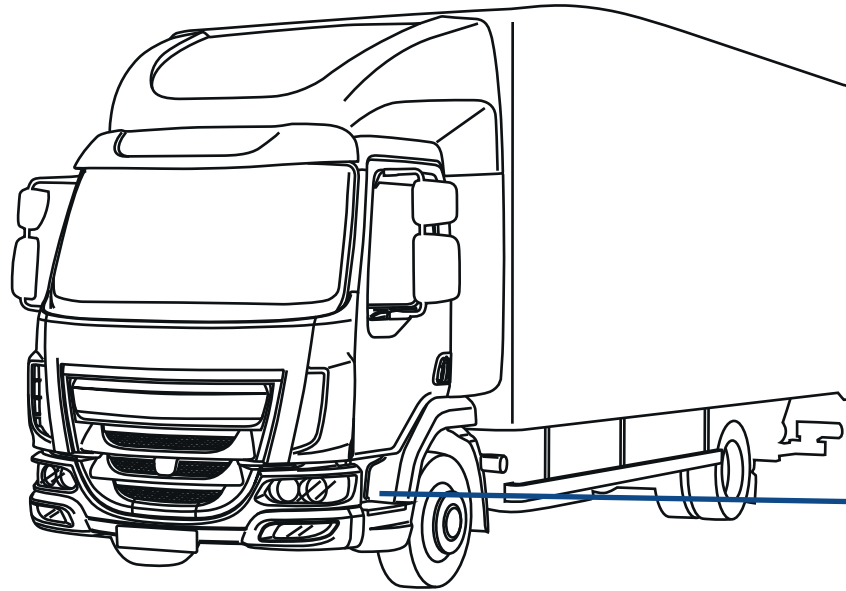

LF6/200 d-rh-rechts
LF6/201 s-lh-links



LF6/200
O.E.M. 1707841
LF6/201
O.E.M. 1707842



applicabile a | suitable to | verwendbar für

7

LF6
LF 55 Euro6

applicabile a I suitable to I verwendbar für:

LF55 Euro 6

(*) vernice di fondo - unprocessed - grundiert
(°) verniciato grigio - grey painted - grau strukturlackiert

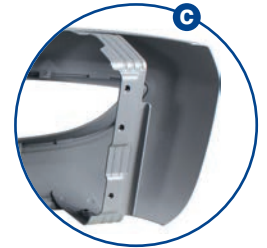
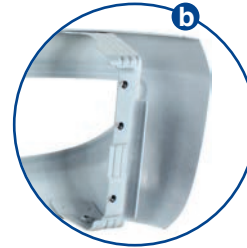
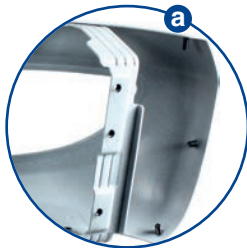
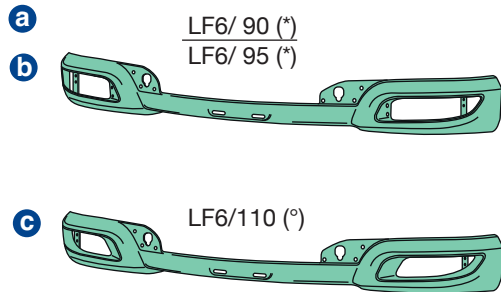

LF6/ 90
O.E.M. 1706904



LF6/ 95
O.E.M. 1706978



LF6/110
O.E.M. 1706977

(*) vernice di fondo - unprocessed - grundiert
(°) verniciato grigio - grey painted - grau strukturlackiert

applicabile a | suitable to | verwendbar für:

LF55 Euro 6

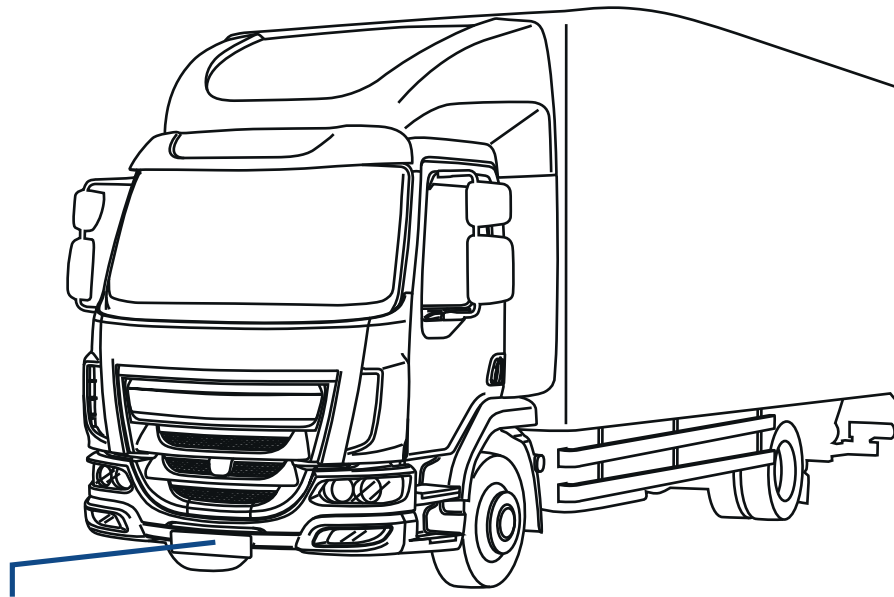

LF6/ 86 (°) d-rh-rechts
LF6/ 88 (*) d-rh-rechts

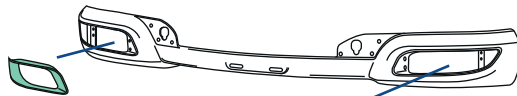

LF6/ 92 d-rh-rechts
LF6/ 93 s-lh-links

LF6/ 87 (°) s-lh-links
LF6/ 89 (*) s-lh-links



LF6/ 86
O.E.M. 1706980
LF6/ 87
O.E.M. 1706979



LF6/ 88
O.E.M. 1706985
LF6/ 89
O.E.M. 1706984



LF6/ 92
O.E.M. 1706987
LF6/ 93
O.E.M. 1706986

applicabile a | suitable to | verwendbar für:

LF55 Euro 6

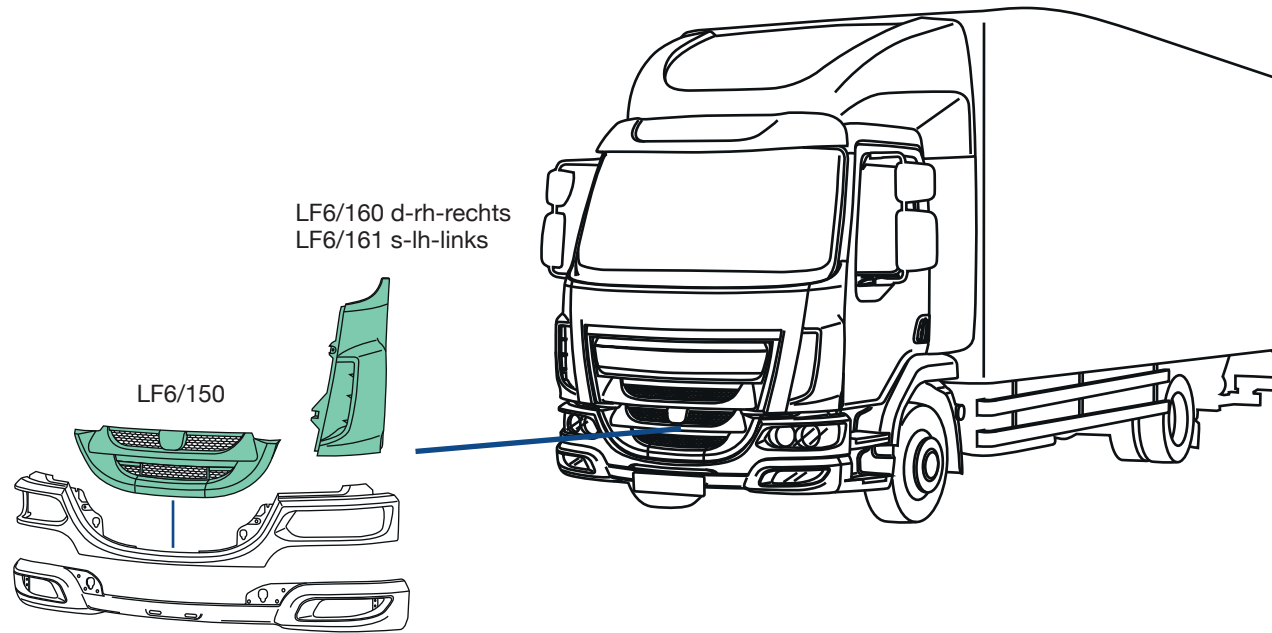

LF6/150
O.E.M. 1707123



LF6/160
O.E.M. 1709694
LF6/161
O.E.M. 1709693

LF55 Euro 6

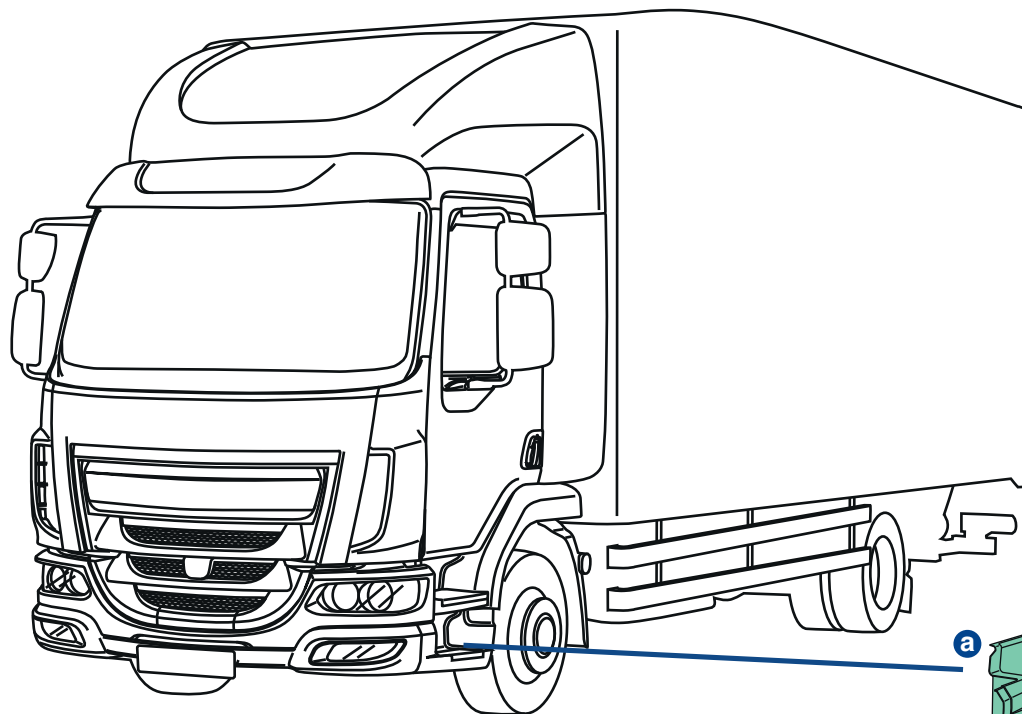

LF6/240 (*) d-rh-rechts
LF6/241 (*) s-lh-links
16-18 ton.
completo di
complete with
komplett mit
LF0/215

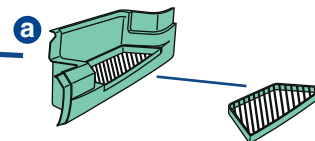

LF0/215
d[s-rh]|lh-rechts|links
in alluminio pressofuso
die-cast aluminium
Aluminium

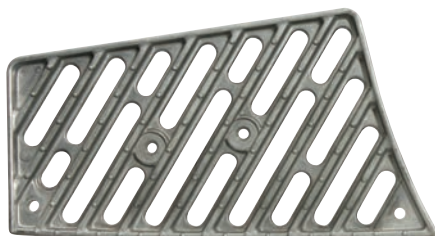

LF0/215
O.E.M. 1405241



LF6/240
O.E.M. 1707973
LF6/241
O.E.M. 1708932





IT Officina di riparazione
EN Workshop
DE Werkstatt



applicabile a | suitable to | verwendbar für

13

LF0
LF45

applicabile a | suitable to | verwendbar für:

LF45

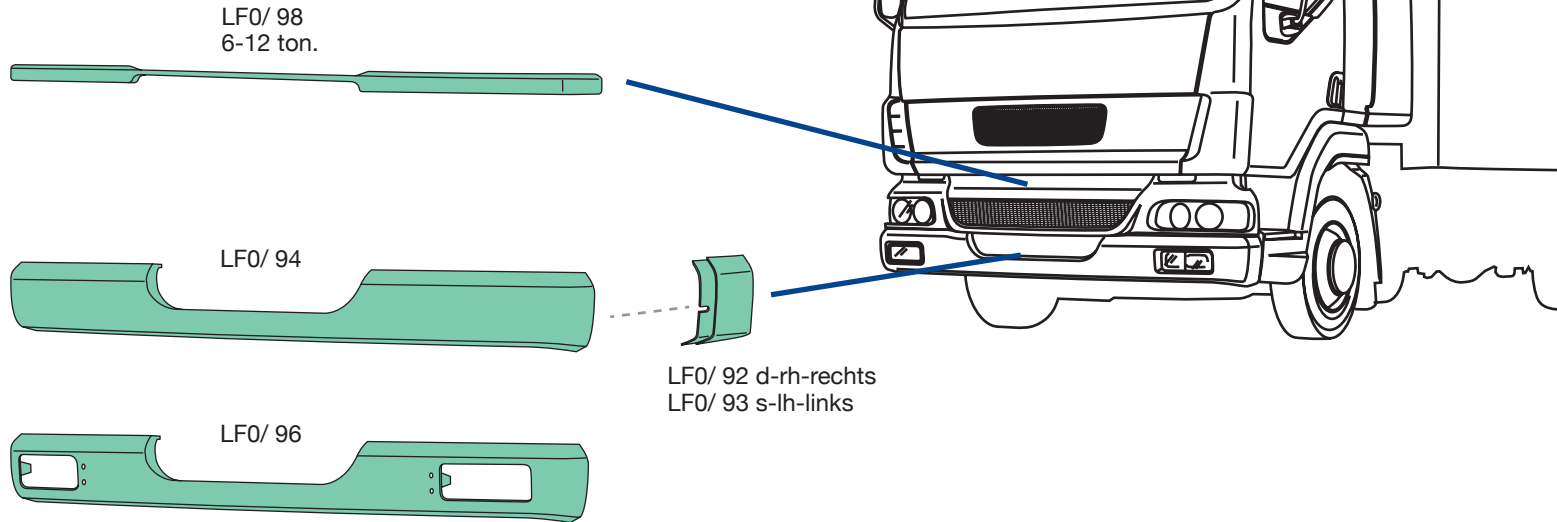

LF0/ 92
O.E.M. 1405881
LF0/ 93
O.E.M. 1405880



LF0/ 94
O.E.M. 1405767



LF0/ 96
O.E.M. 1405766



LF0/ 98
O.E.M. 1405015



LF0/100 d-rh-rechts
LF0/101 s-lh-links
in alluminio pressofuso
die-cast aluminium
Aluminium

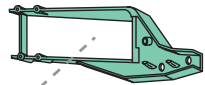

LF0/ 90
→2006



LF0/ 88 d-rh-rechts
LF0/ 89 s-lh-links

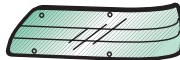

940/055
protezione faro (la coppia)
headlamp protection (pair of)
Scheinwerferschutz (Paar)



LF0/ 88
O.E.M. 1405010
LF0/ 89
O.E.M. 1405011



LF0/ 90
O.E.M. 1405008



LF0/100
O.E.M. 1407464
LF0/101
O.E.M. 1407465



940/055
O.E.M. -

LF45

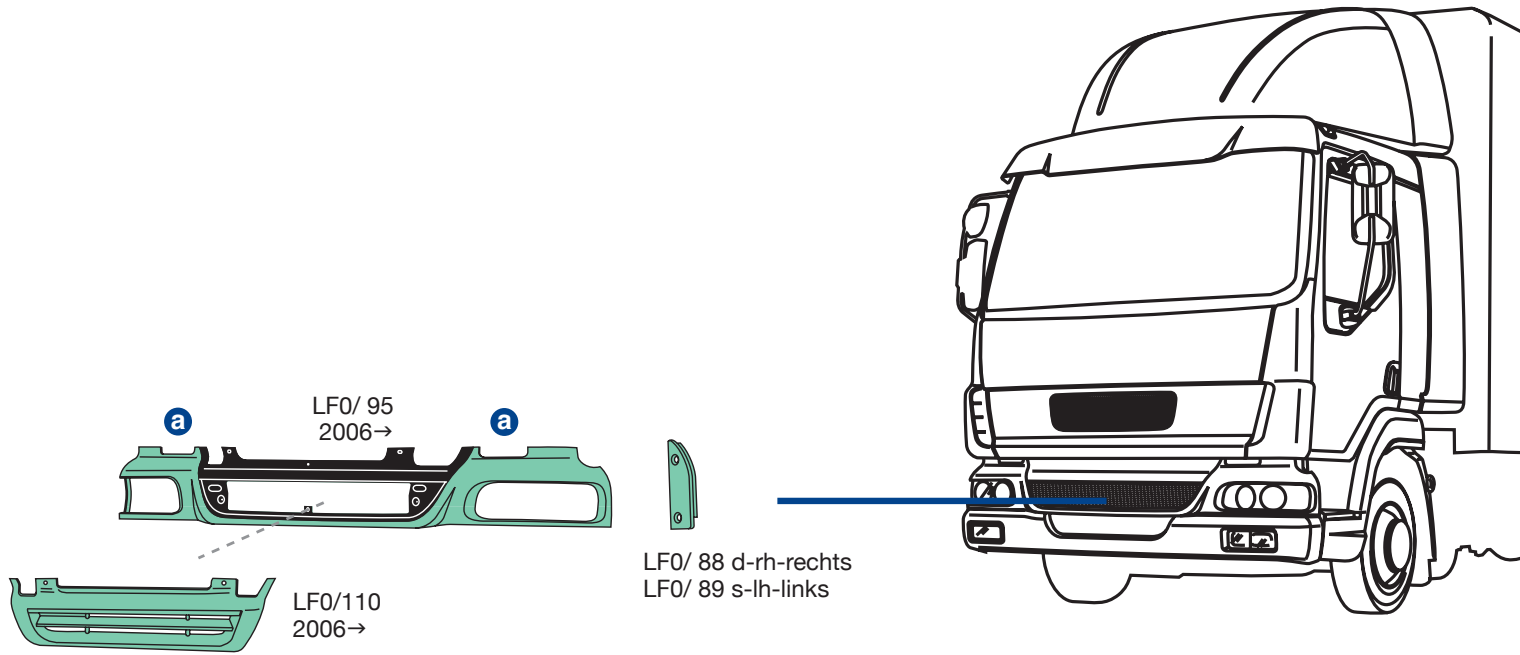

LF0/ 88
O.E.M. 1405010
LF0/ 89
O.E.M. 1405011



LF0/ 95
O.E.M. 1701375

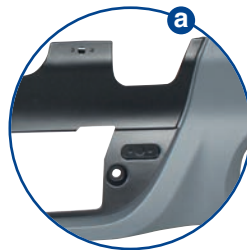

LF0/110
O.E.M. 1700802

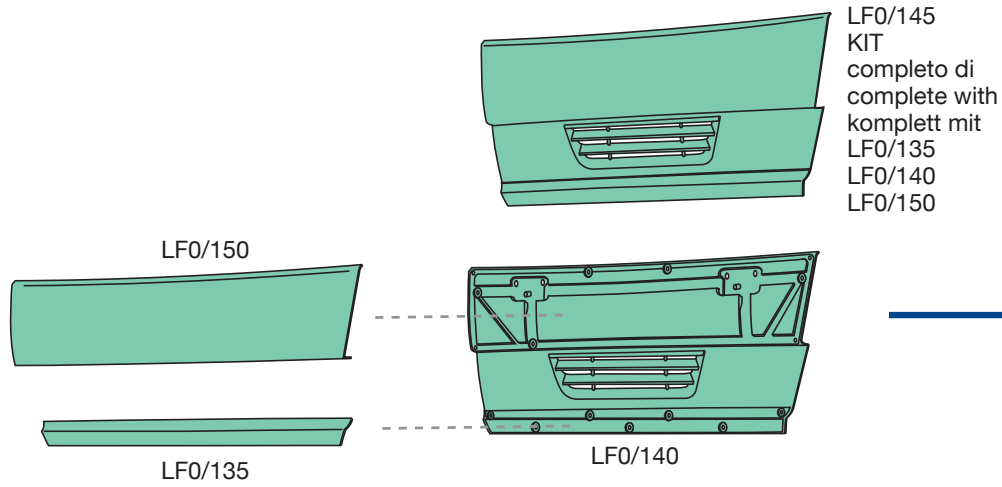

LF0/135
O.E.M. 1852469



LF0/140
O.E.M. 1852532



LF0/150
O.E.M. 1852468



LF0/145
O.E.M. 1700613

applicabile a | suitable to | verwendbar für:

LF45

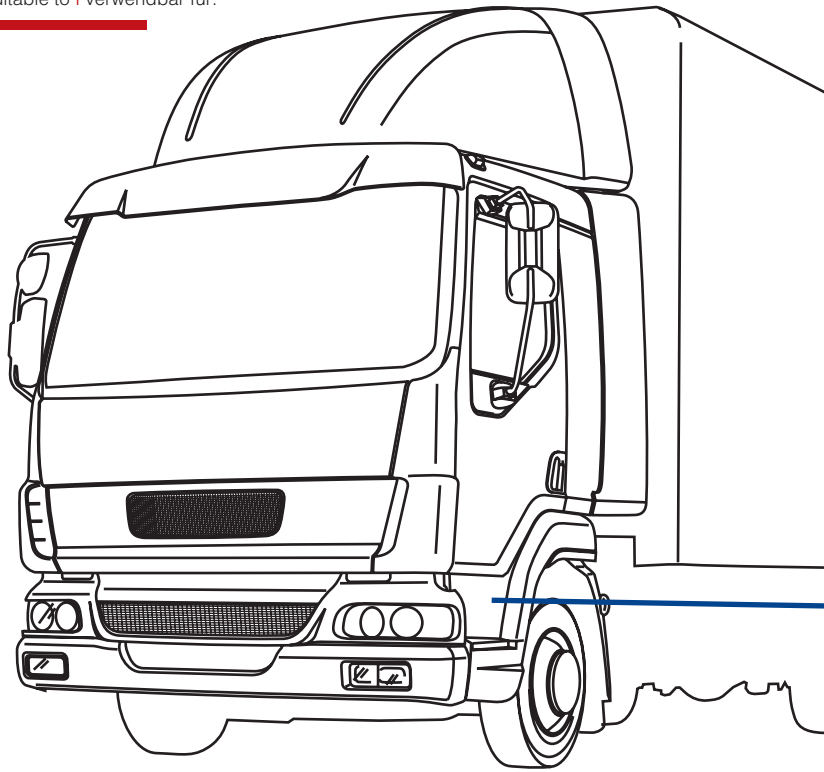

LF0/200 d-rh-rechts
LF0/201 s-lh-links

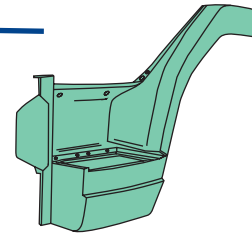

LF0/324 d-rh-rechts
LF0/325 s-lh-links
12-16 ton.

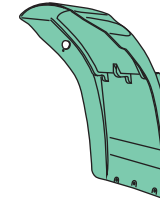

LF0/320 d-rh-rechts
LF0/321 s-lh-links
16-18 ton.



LF0/200
O.E.M. 1405250
LF0/201
O.E.M. 1405247



LF0/320
O.E.M. 1405002
LF0/321
O.E.M. 1405003



LF0/324
O.E.M. 1404997
LF0/325
O.E.M. 1404998

PDS/360

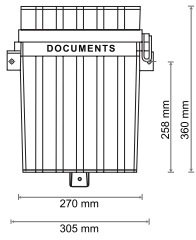

applicabile a | suitable to | verwendbar für:

LF45

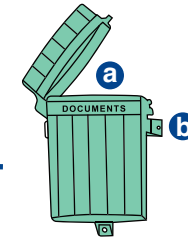
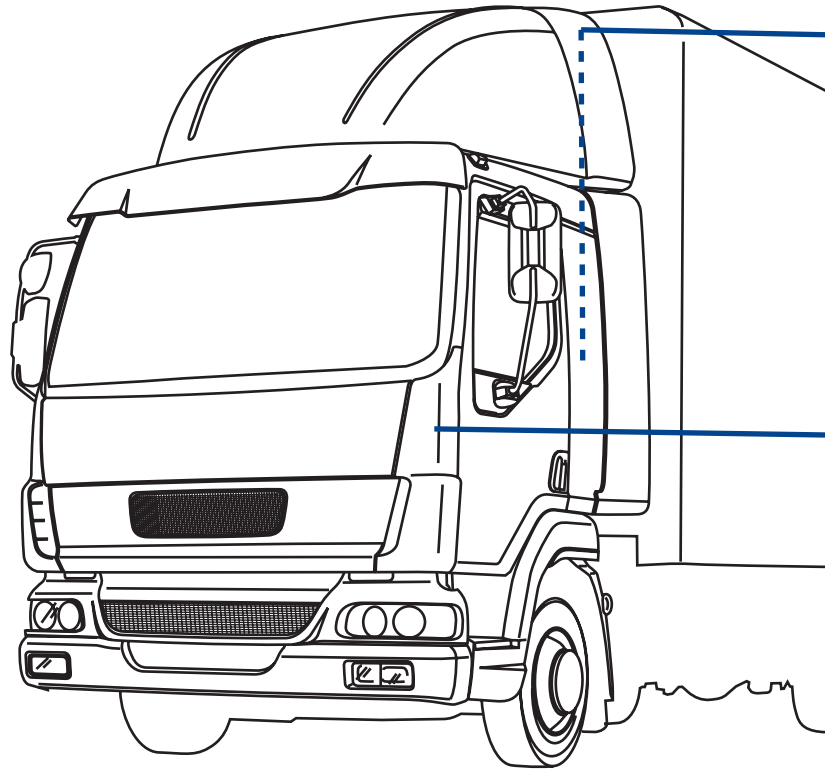

PDS/360



LF0/160 d-rh-rechts
LF0/161 s-lh-links



LF0/160
O.E.M. 1400711
LF0/161
O.E.M. 1400710



PDS/360
O.E.M. -

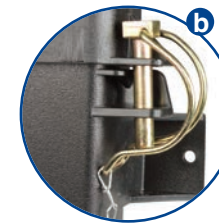

applicabile a l suitable to l verwendbar für:

LF45

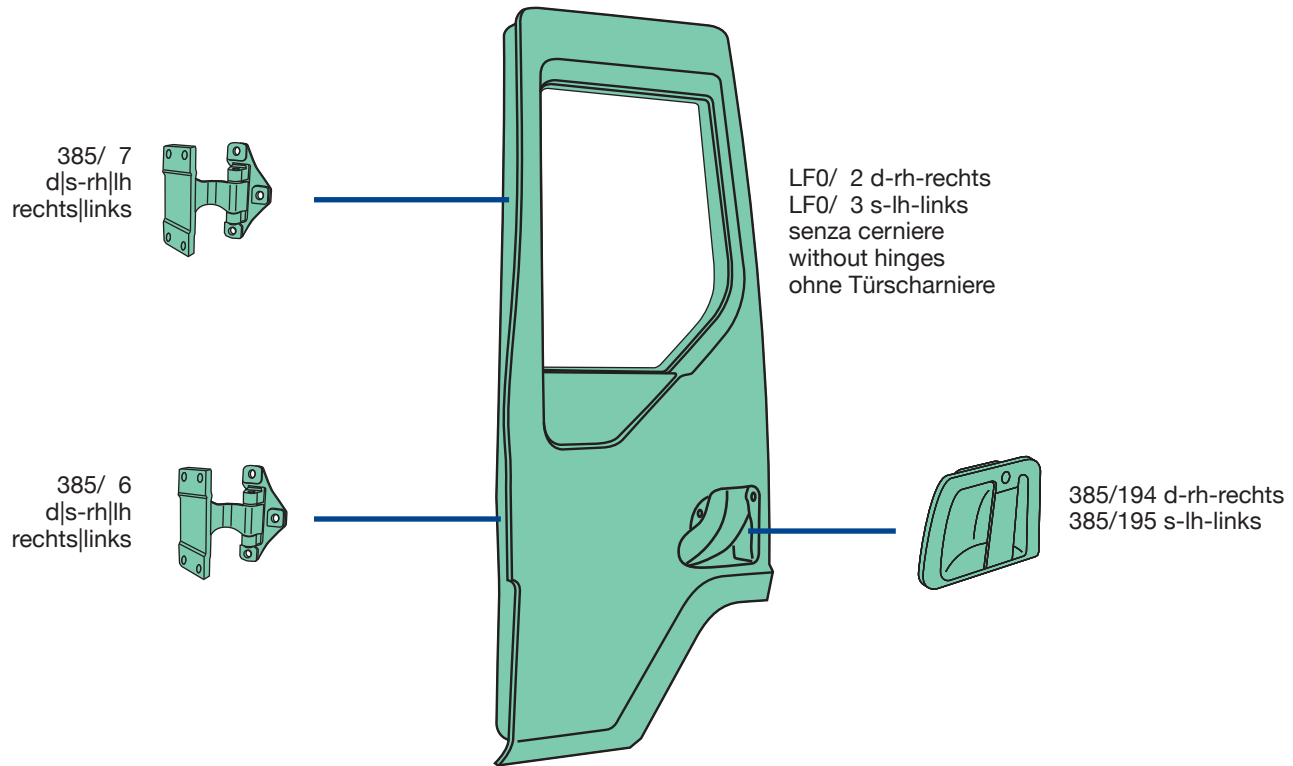

LF0/ 2
O.E.M. 1701094
LF0/ 3
O.E.M. 1700862



385/ 6
O.E.M. 1400731



385/ 7
O.E.M. 1400730



385/194
O.E.M. 1400778
385/195
O.E.M. 1400769

manuale
manual
manuell

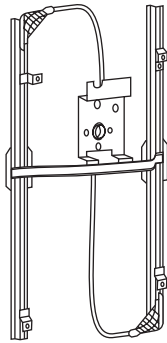

385/164 d-rh-rechts
385/165 s-lh-links
elettrico senza motorino
electric without motor
elektrisch ohne Motor

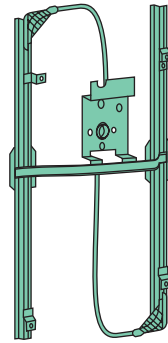

385/174 d-rh-rechts
385/175 s-lh-links
elettrico con motorino
electric with motor
elektrisch mit Motor

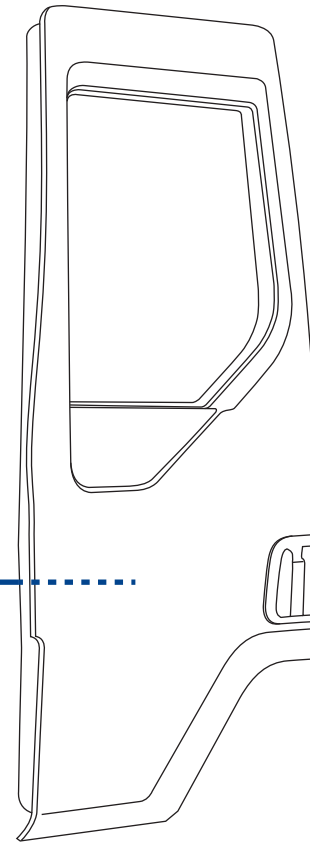
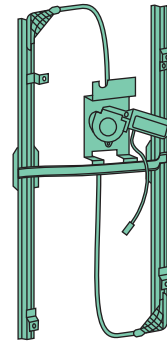

385/164
O.E.M. 1400754
385/165
O.E.M. 1400753



385/174
O.E.M. 1400754
385/175
O.E.M. 1400753

applicabile a I suitable to I verwendbar für:

LF45



LF0/500

1704604
(1700306)



II (E4) 024104
202x337 mm



IV (E4) 024105
200x197 mm

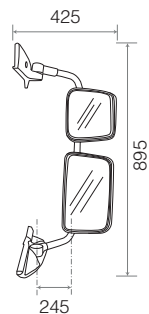

applicabilità:
applicable to:
Verwendbar für

DAF LF 45-55 05/2006 →

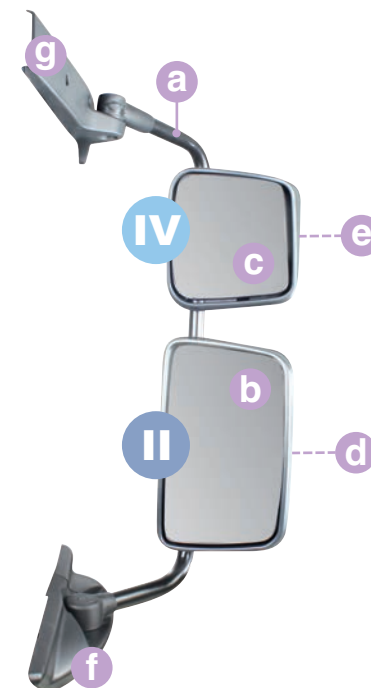

COVIND

LF0/512

1735520



244x370 mm

LF0/510

1781228



235x243 mm

a	PRM/508	1733893			<p>+ g 323x895 mm</p>
b	PRM/504	1737933			<p>E4 024104 202x337 mm</p>
II					
c	LF0/504	1736865			<p>E4 024105 200x197 mm</p>
IV					
d	LF0/506	1736884			241x369 mm
II					
e	LF0/507	1736883			235x241 mm
IV					
f	PRM/512	1736923 (1409581)			
g	PRM/522	-			

applicabile a I suitable to I verwendbar für:

LF45



LF0/501

1700303



II (E4) 024104
202x337 mm



IV (E4) 024105
200x197 mm

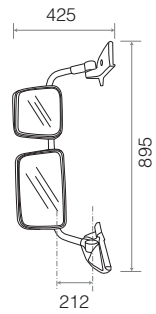

applicabilità:
applicable to:
Verwendbar für

DAF LF 45-55 05/2006→

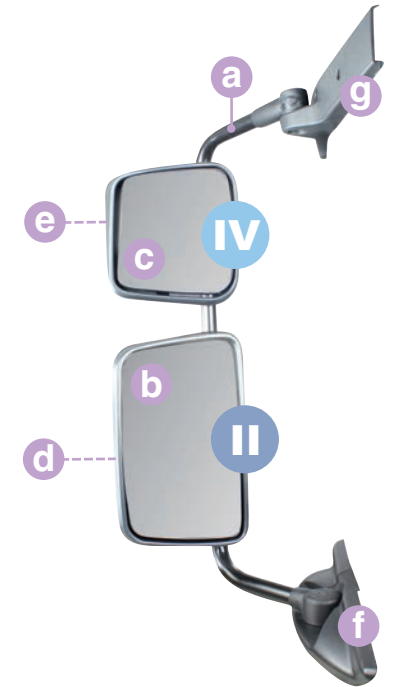

COVID

LF0/513

1735519



241x370 mm

II

LF0/511

1781227



234x245 mm

a	PRM/509	1733892			+ g 300x895 mm
b	PRM/504	1737933			E4 024104 202x337 mm
c	LFO/505	1736879			E4 024105 200x197 mm
d	LFO/506	1736884			241x369 mm
e	LFO/507	1736883			235x241 mm
f	PRM/513	1736924 (1409576)			
g	PRM/523	-			

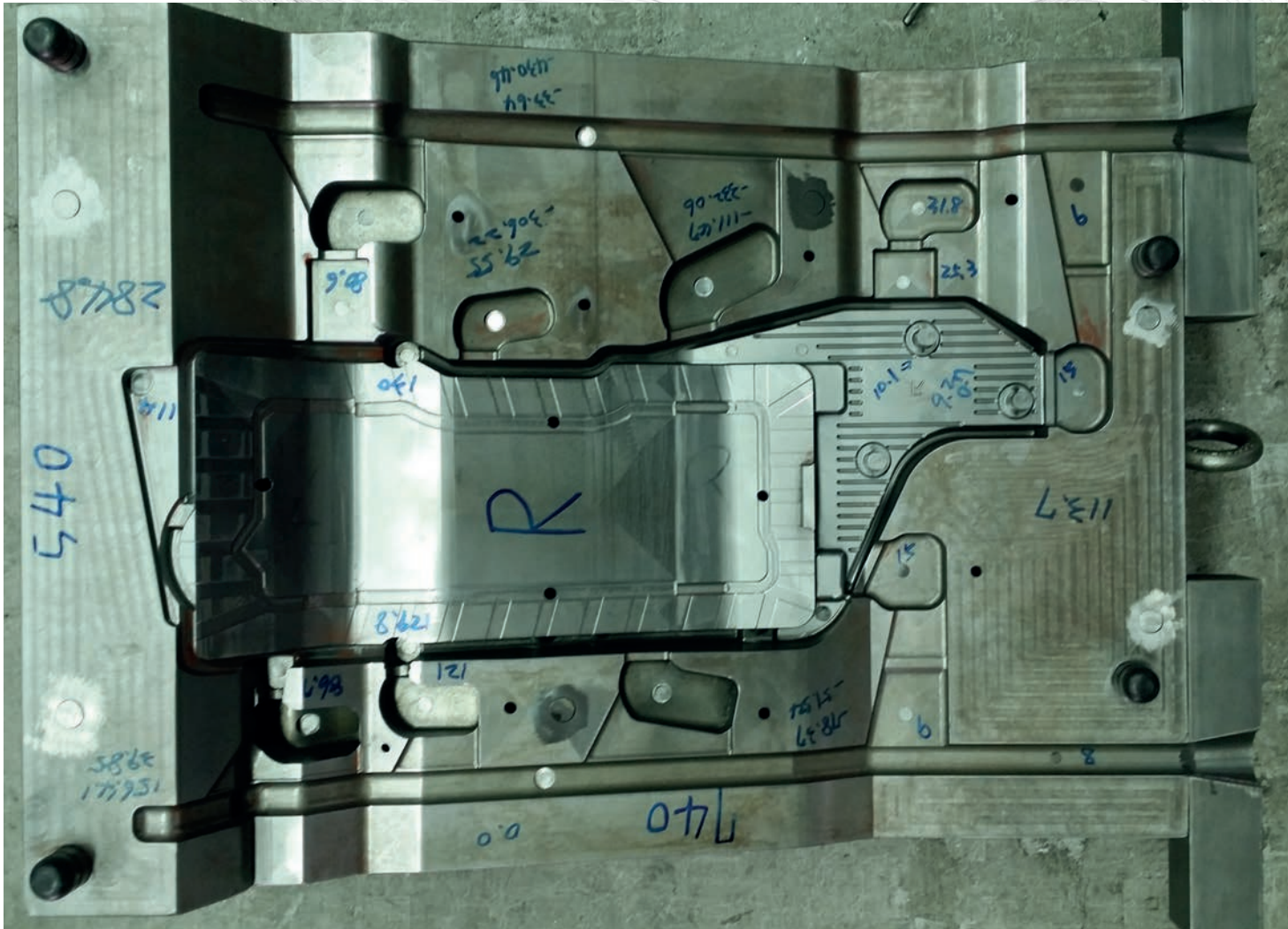

IT Stampo in acciaio per la produzione in alluminio pressofuso del supporto faro Daf LF euro 6

EN Steel injection moulding for the manufacturing of the beam rest in die-cast aluminum for the DAF LF Euro6

DE Spritzgusswerkzeug aus Stahl für die Herstellung des Scheinwerferhalters aus druckgegossenem Alu des DAF LF Euro6

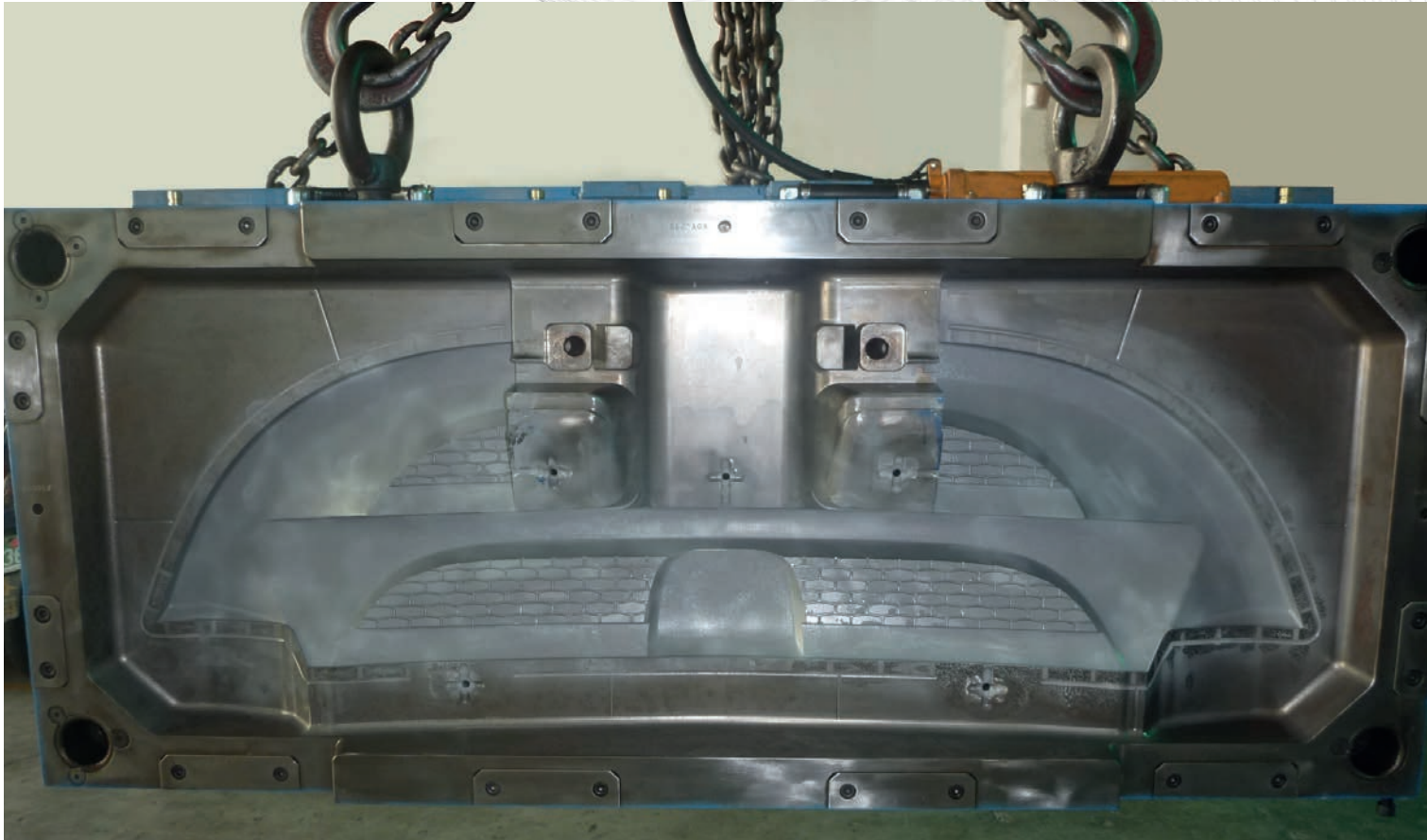

IT Stampo in acciaio a iniezione per la produzione di griglia radiatore Daf LF euro 6
EN Steel injection moulding for the manufacturing of the radiator grill of the DAF LF Euro6
DE Spritzgusswerkzeug aus Stahl für die Herstellung des Kühlergitters des DAF LF Euro6

applicabile a I suitable to I verwendbar für:

LF45



LF0/502

1704605
(1700269)



II (E4) 024104
202x337 mm



IV (E4) 024105
200x197 mm

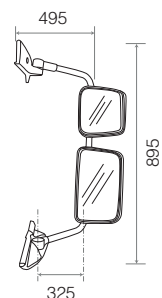

applicabilità:
applicable to:
Verwendbar für

DAF LF 45-55 05/2006→

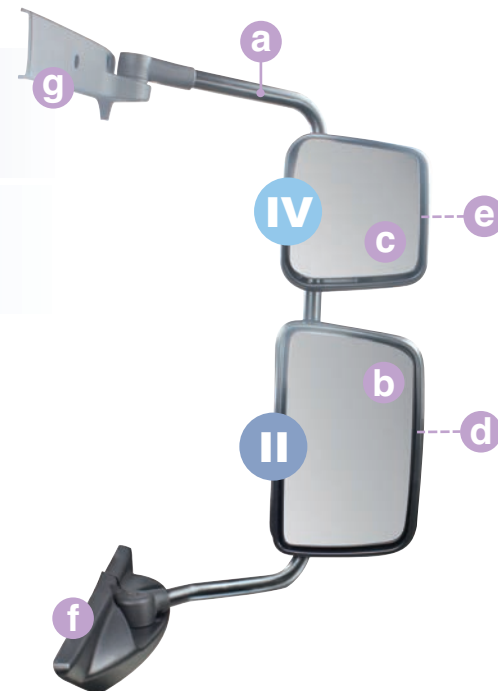

COVIND

LF0/512

1735520



244x370 mm

II

LF0/510

1781228



235x243 mm

IV

a	LF0/508	1736953			<p>+ g 387x895 mm</p>
b	PRM/504	1737933			<p>(E4) 024104 202x337 mm</p>
II					
c	LF0/504	1736865			<p>(E4) 024105 200x197 mm</p>
IV					
d	LF0/506	1736884			241x369 mm
II					
e	LF0/507	1736883			235x241 mm
IV					
f	PRM/512	1736923 (1409581)			
g	PRM/522	-			

applicabile a I suitable to I verwendbar für:

LF45



LF0/503

1700265



II

E4 024104

202x337 mm



IV

E4 024105

200x197 mm

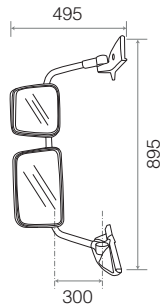

applicabilità:
applicable to:
Verwendbar für

DAF LF 45-55 05/2006→

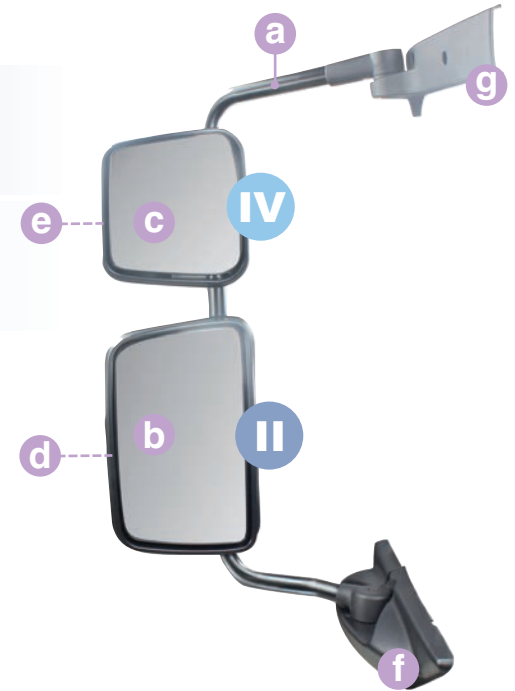

COVID

LF0/513

1735519



241x370 mm

II

LF0/511

1781227



234x245 mm

a	LF0/509	1736954			+ g 387x895 mm
b	PRM/504	1737933			(E4) 024104 202x337 mm
II					
c	LF0/505	1736879			(E4) 024105 200x197 mm
IV					
d	LF0/506	1736884			241x369 mm
II					
e	LF0/507	1736883			235x241 mm
IV					
f	PRM/513	1736924 (1409576)			
g	PRM/523	-			

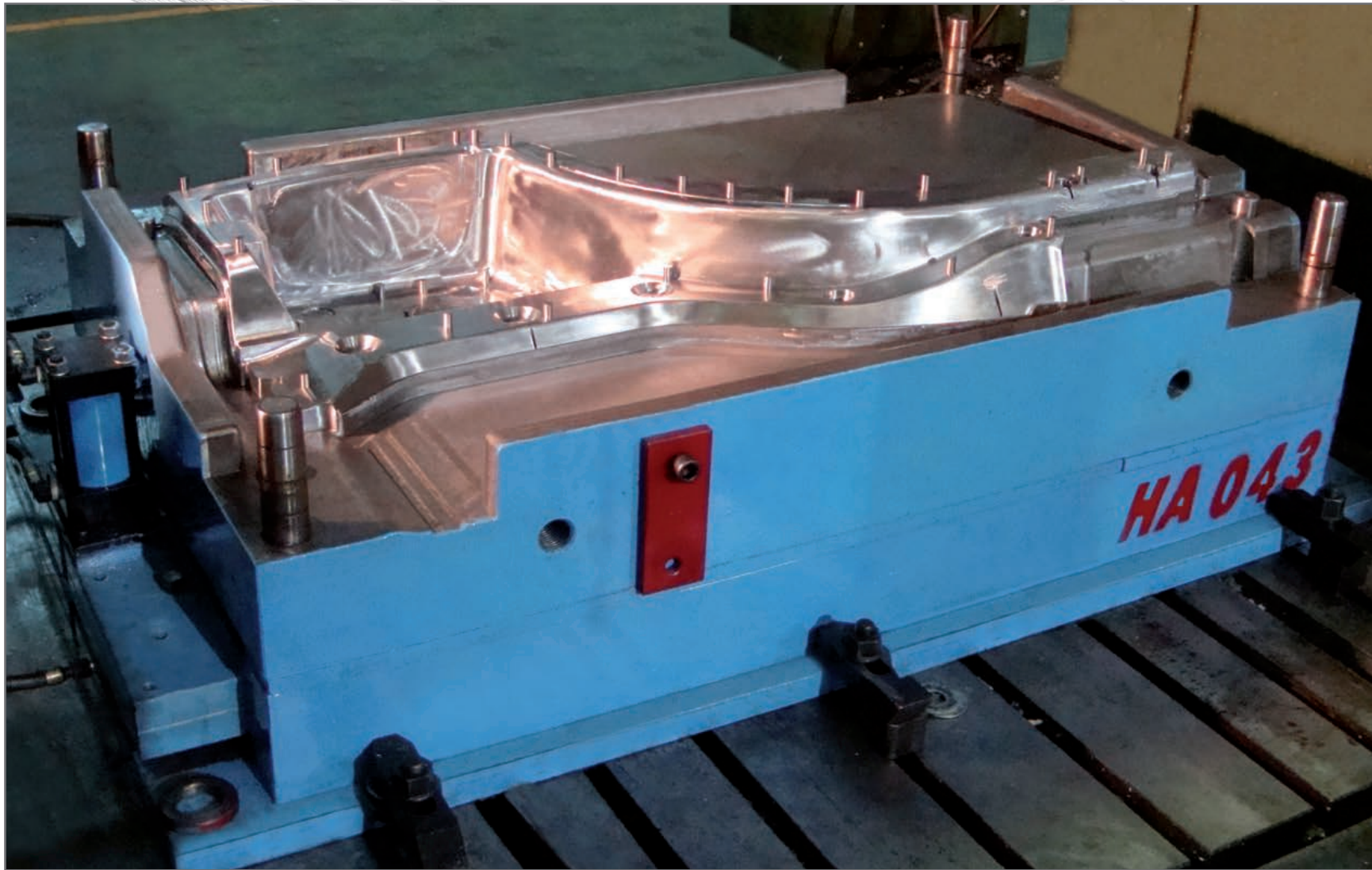

- ▲
- IT Stampo in acciaio temperato per la produzione di un parafrango anteriore in SMC del DAF LF
EN Harded steel mould for the SMC production of the front mudguard for the DAF LF vehicle
DE Gehärtete Stahlform für SMC Produktion für Einstieg mit Kotflügel DAF-LF



applicabile a | suitable to | verwendbar für | 31

LF0
LF55

applicabile a | suitable to | verwendbar für:

LF55

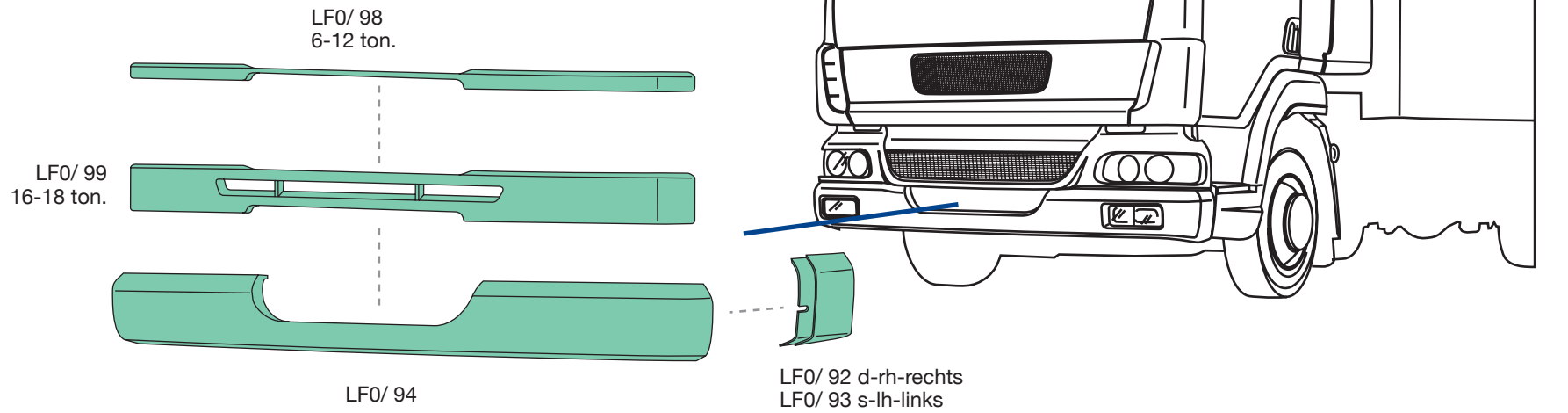

LF0/ 92
O.E.M. 1405881
LF0/ 93
O.E.M. 1405880



LF0/ 94
O.E.M. 1405767



LF0/ 98
O.E.M. 1405015



LF0/ 99
O.E.M. 1405013

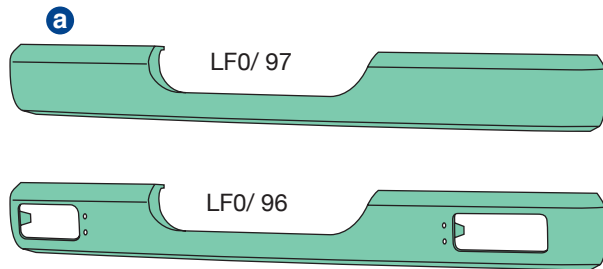
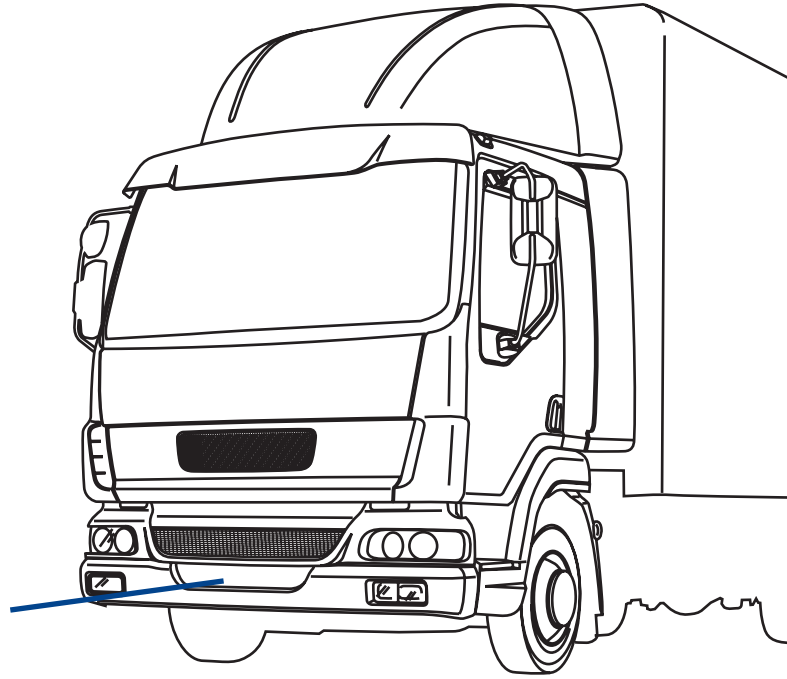

LF0/96
O.E.M. 1405766



LF0/97
O.E.M. 1405672

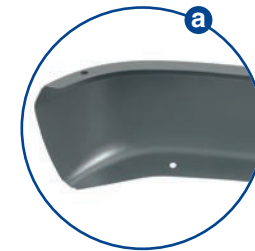

LF55

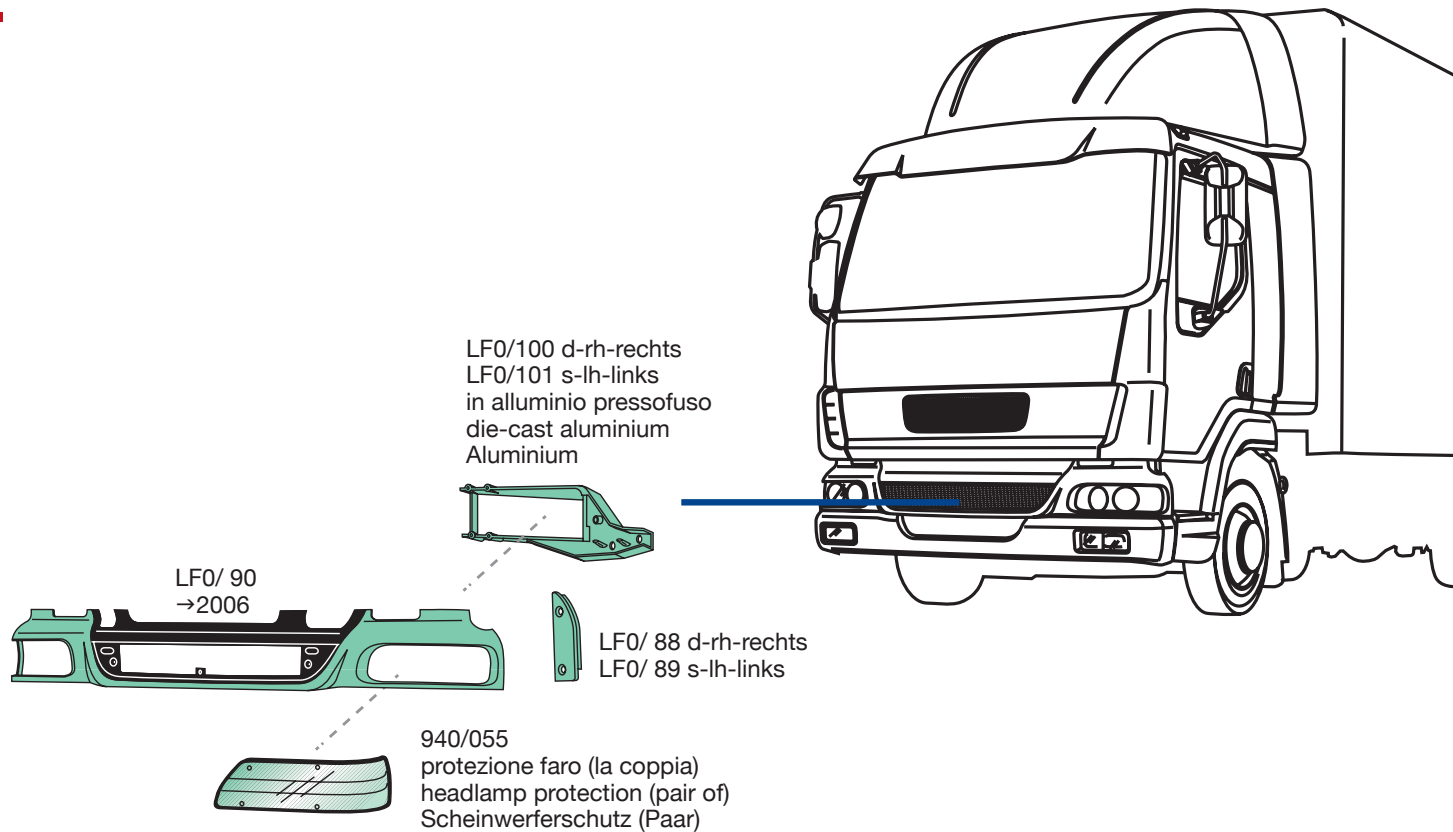

LF0/ 88
O.E.M. 1405010
LF0/ 89
O.E.M. 1405011



LF0/ 90
O.E.M. 1405008



LF0/100
O.E.M. 1407464
LF0/101
O.E.M. 1407465



940/055
O.E.M. -

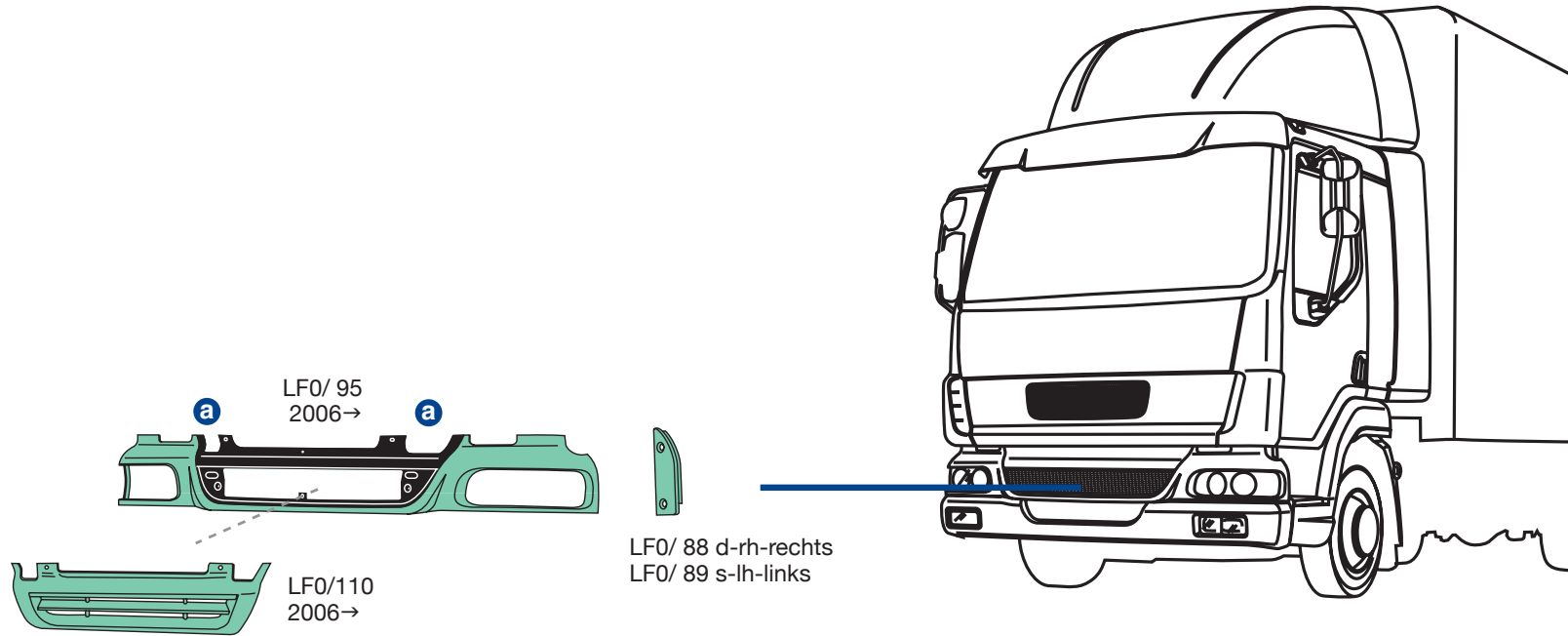

LF0/ 88
O.E.M. 1405010
LF0/ 89
O.E.M. 1405011



LF0/ 95
O.E.M. 1701375



LF0/110
O.E.M. 1700802

applicabile a I suitable to I verwendbar für:

LF55

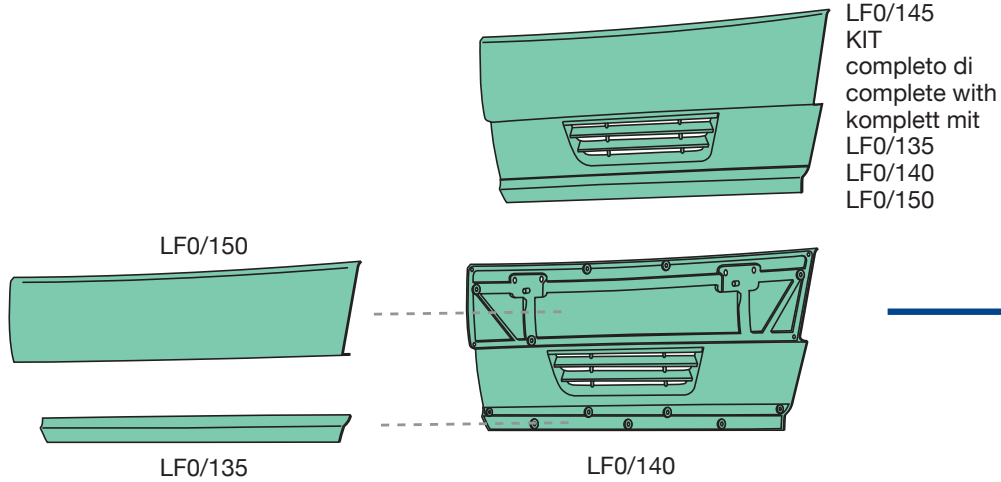

LF0/135
O.E.M. 1852469



LF0/140
O.E.M. 1852532



LF0/150
O.E.M. 1852468



LF0/145
O.E.M. 1700613

PDS/360

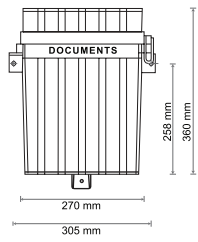

applicabile a | suitable to | verwendbar für:

LF55

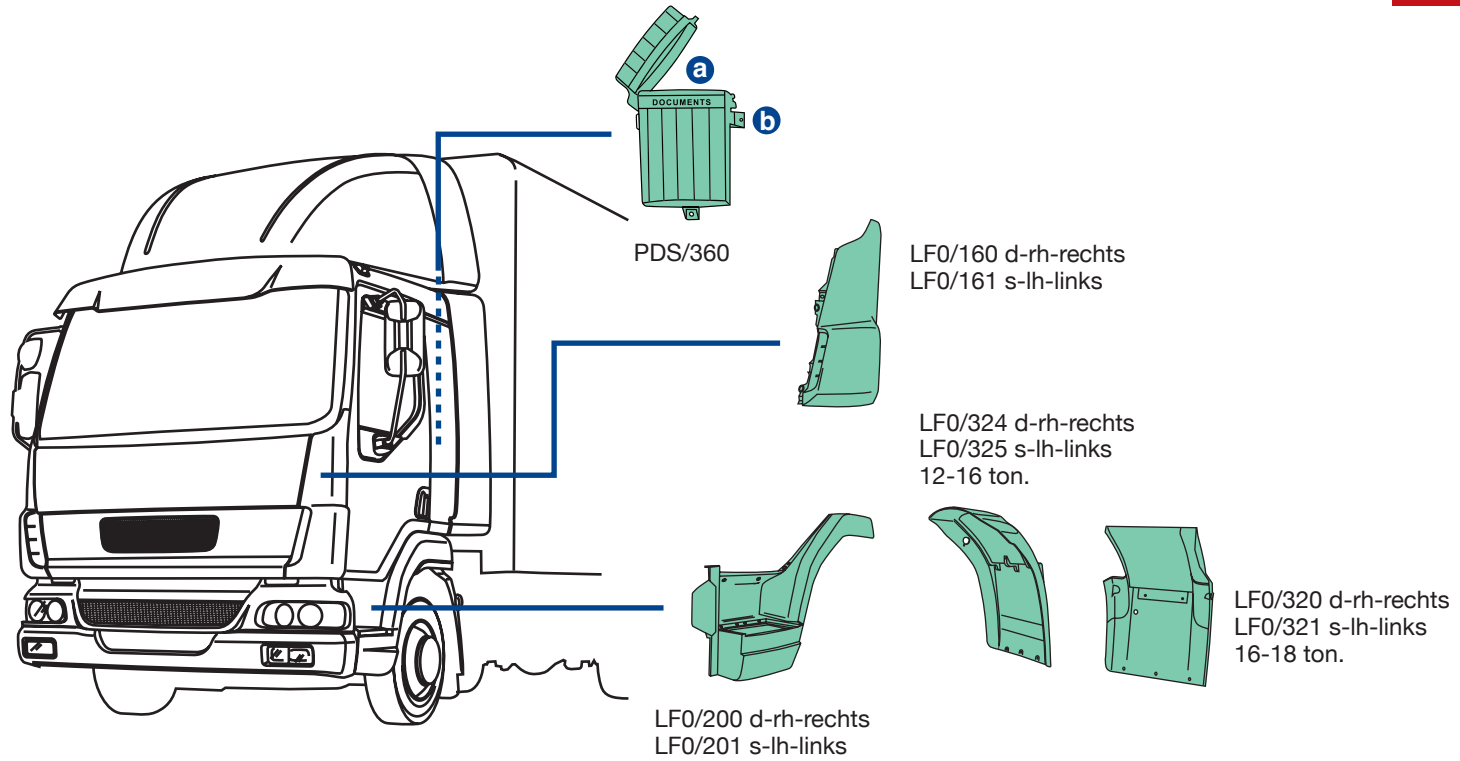

LF0/160
O.E.M. 1400711
LF0/161
O.E.M. 1400710



LF0/200
O.E.M. 1405250
LF0/201
O.E.M. 1405247



LF0/320
O.E.M. 1405002
LF0/321
O.E.M. 1405003



LF0/324
O.E.M. 1404997
LF0/325
O.E.M. 1404998



PDS/360
O.E.M. -

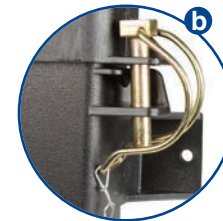

LF55



LF0/215
d|s-rh|lh-rechts|links
in alluminio pressofuso
die-cast aluminium
Aluminium

LF0/215
d|s-rh|lh-rechts|links
in alluminio pressofuso
die-cast aluminium
Aluminium

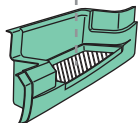

12-15 ton.
LF0/240 d-rh-rechts
LF0/241 s-lh-links
completo di
complete with
komplett mit
LF0/215

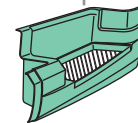

16-18 ton.
LF0/244 d-rh-rechts
LF0/245 s-lh-links
completo di
complete with
komplett mit
LF0/215

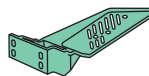

LF0/238 d-rh-rechts
LF0/239 s-lh-links
in alluminio pressofuso
die-cast aluminium
Aluminium

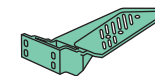

LF0/238 d-rh-rechts
LF0/239 s-lh-links
in alluminio pressofuso
die-cast aluminium
Aluminium

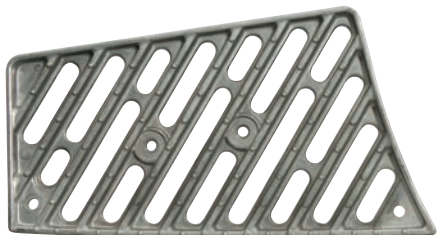

LF0/215
O.E.M. 1405241



LF0/238
O.E.M. 1407316
LF0/239
O.E.M. 1407317



LF0/240
O.E.M. 1405991
LF0/241
O.E.M. 1405990



LF0/244
O.E.M. 1405989
LF0/245
O.E.M. 1405988

385/ 7
d|s-rh|lh
rechts|links

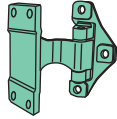

385/ 6
d|s-rh|lh
rechts|links

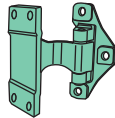

LF0/ 2 d-rh-rechts
LF0/ 3 s-lh-links
senza cerniere
without hinges
ohne Türscharniere

385/194 d-rh-rechts
385/195 s-lh-links



LF0/ 2
O.E.M. 1701094
LF0/ 3
O.E.M. 1700862



385/ 6
O.E.M. 1400731



385/ 7
O.E.M. 1400730



385/194
O.E.M. 1400778
385/195
O.E.M. 1400769

LF55

manuale
manual
manuell

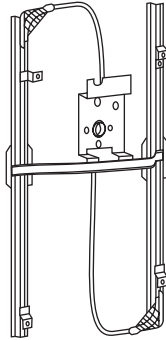

385/164 d-rh-rechts
385/165 s-lh-links
elettrico senza motorino
electric without motor
elektrisch ohne Motor

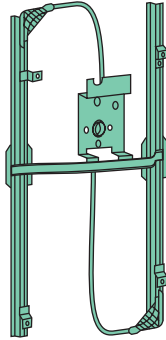

385/174 d-rh-rechts
385/175 s-lh-links
elettrico con motorino
electric with motor
elektrisch mit Motor

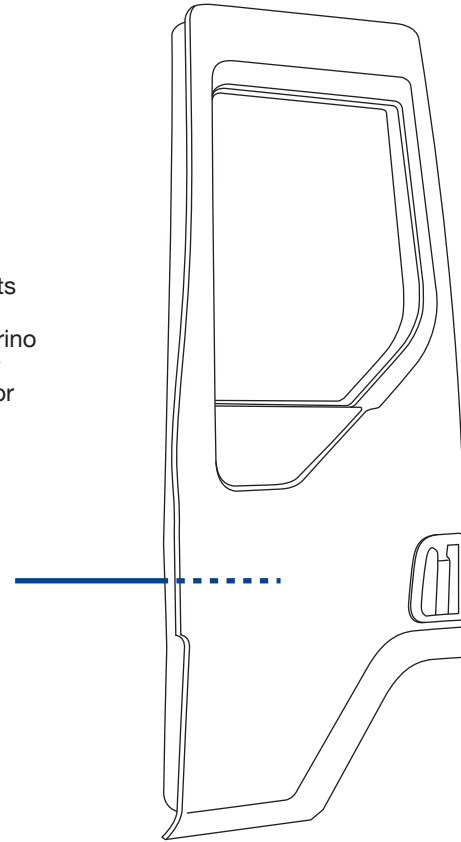
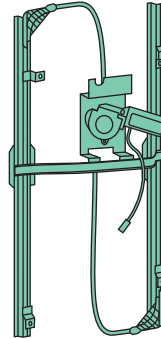

385/164
O.E.M. 1400754
385/165
O.E.M. 1400753



385/174
O.E.M. 1400754
385/175
O.E.M. 1400753



- IT Maschera di controllo per le porte Scania SCR/ 2 e SCR/ 3
EN Checking Jig for Scania Doors SCR/ 2 and SCR/ 3
DE Überprüfung der Scania (SCR/2 und SCR/3) Türen auf Paßgenauigkeit.

applicabile a | suitable to | verwendbar für:

LF55



LF0/500

1704604
(1700306)



II (E4) 024104
202x337 mm



IV (E4) 024105
200x197 mm

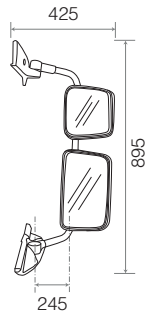

applicabilità:
applicable to:
Verwendbar für

DAF LF 45-55 05/2006 →

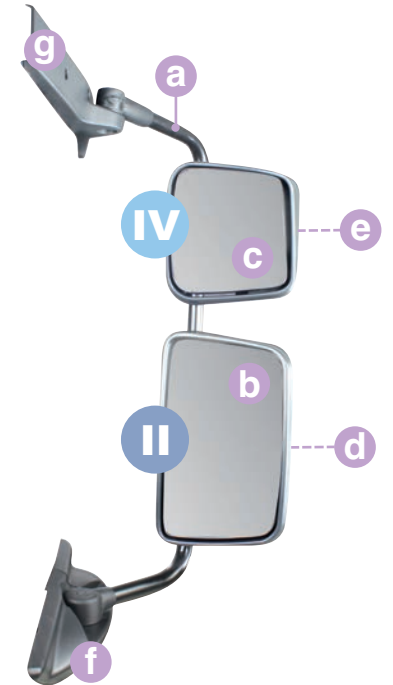

LF0/512

1735520

















244x370 mm

LF0/510

1781228



235x243 mm

<p>a PRM/508</p>	<p>1733893</p>			<p>+ g</p> <p>323x895 mm</p>
<p>b PRM/504</p> <p> </p>	<p>1737933</p>			<p>(E4) 024104</p> <p>202x337 mm</p>
<p>c LF0/504</p> <p>IV</p>	<p>1736865</p>			<p>(E4) 024105</p> <p>200x197 mm</p>
<p>d LF0/506</p> <p> </p>	<p>1736884</p>			<p>241x369 mm</p>
<p>e LF0/507</p> <p>IV</p>	<p>1736883</p>			<p>235x241 mm</p>
<p>f PRM/512</p> <p>(1409581)</p>	<p>1736923</p> <p>(1409581)</p>			
<p>g PRM/522</p>	<p>-</p>			

LF55

LF0/501

1700303



II (E4) 024104
202x337 mm



IV (E4) 024105
200x197 mm

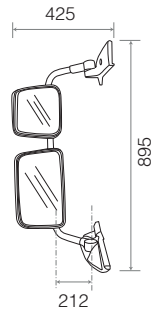

applicabilità:
applicable to:
Verwendbar für

DAF LF 45-55 05/2006→

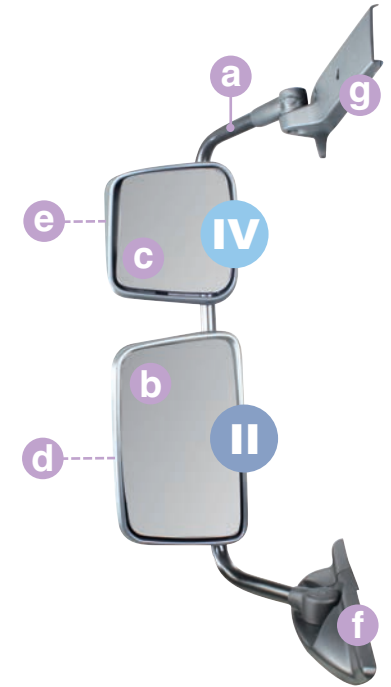

LF0/513

1735519



241x370 mm

II

LF0/511

1781227



234x245 mm

IV

a	PRM/509	1733892			+ g	300x895 mm
b	PRM/504	1737933			E4 024104	202x337 mm
II						
c	LF0/505	1736879			E4 024105	200x197 mm
IV						
d	LF0/506	1736884				241x369 mm
II						
e	LF0/507	1736883				235x241 mm
IV						
f	PRM/513	1736924 (1409576)				
g	PRM/523	-				



▲
IT Stampo in acciaio a iniezione per la produzione di griglia radiatore Daf LF euro 6
EN Steel injection moulding for the manufacturing of the radiator grill of the DAF LF Euro6
DE Spritzgusswerkzeug aus Stahl für die Herstellung des Kühlergitters des DAF LF Euro6



IT Stampo in acciaio a iniezione per la produzione di deviatore aria Daf LF euro 6
EN Steel injection moulding for the manufacturing of the air deflector for the DAF LF Euro6
DE Spritzgusswerkzeug aus Stahl für die Herstellung des Luftabweisers des DAF LF Euro6

applicabile a I suitable to I verwendbar für:

LF55

ZOOM

LF0/502

1704605
(1700269)



II E4 024104
202x337 mm



IV E4 024105
200x197 mm

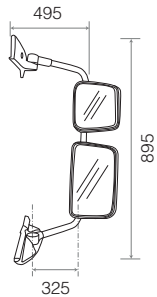

applicabilità:
applicable to:
Verwendbar für

DAF LF 45-55 05/2006→

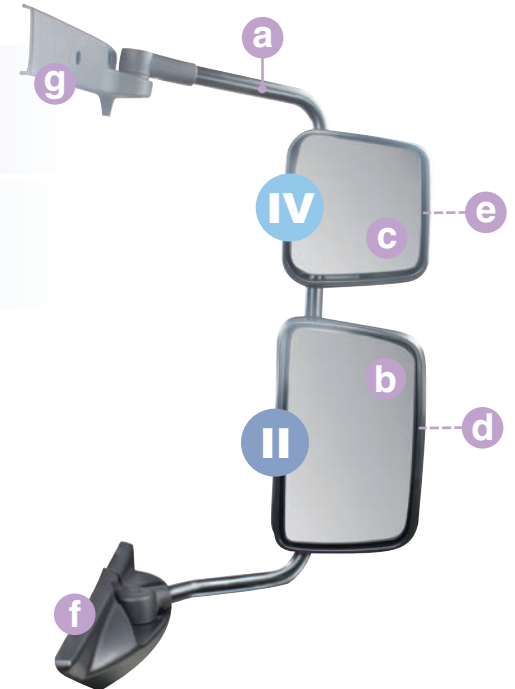

LF0/512

1735520



244x370 mm















II

LF0/510

1781228



235x243 mm

<p>a LF0/508</p>	<p>1736953</p>			<p>+ g 387x895 mm</p>
<p>b PRM/504</p> <p> </p>	<p>1737933</p>			<p>E4 024104 202x337 mm</p>
<p>c LF0/504</p> <p>IV</p>	<p>1736865</p>			<p>E4 024105 200x197 mm</p>
<p>d LF0/506</p> <p> </p>	<p>1736884</p>			<p>241x369 mm</p>
<p>e LF0/507</p> <p>IV</p>	<p>1736883</p>			<p>235x241 mm</p>
<p>f PRM/512</p>	<p>1736923 (1409581)</p>			
<p>g PRM/522</p>	<p>-</p>			

LF55



LF0/503

1700265



II (E4) 024104
202x337 mm



IV (E4) 024105
200x197 mm

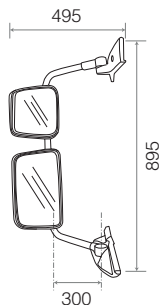

applicabilità:
applicable to:
Verwendbar für

DAF LF 45-55 05/2006→

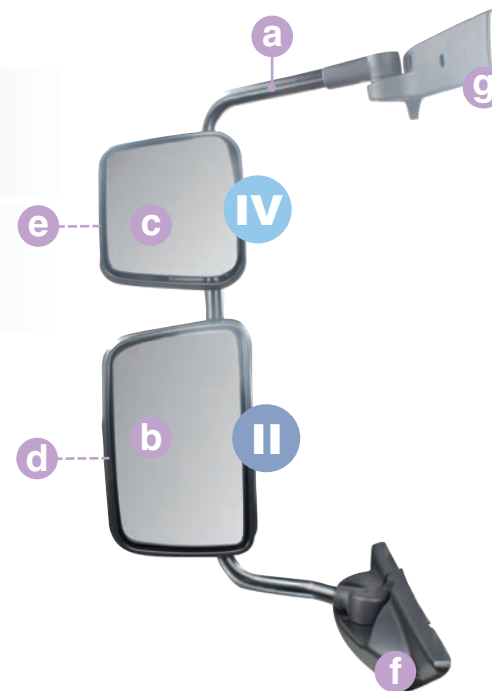

LF0/513

1735519



241x370 mm

LF0/511

1781227



234x245 mm

a	LF0/509	1736954			+ g 387x895 mm
b	PRM/504	1737933			E4 024104 202x337 mm
c	LF0/505	1736879			E4 024105 200x197 mm
IV					
d	LF0/506	1736884			241x369 mm
e	LF0/507	1736883			235x241 mm
IV					
f	PRM/513	1736924 (1409576)			
g	PRM/523	-			

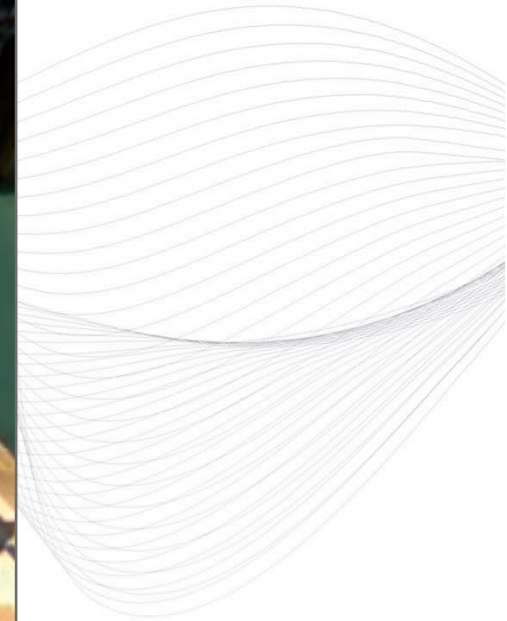
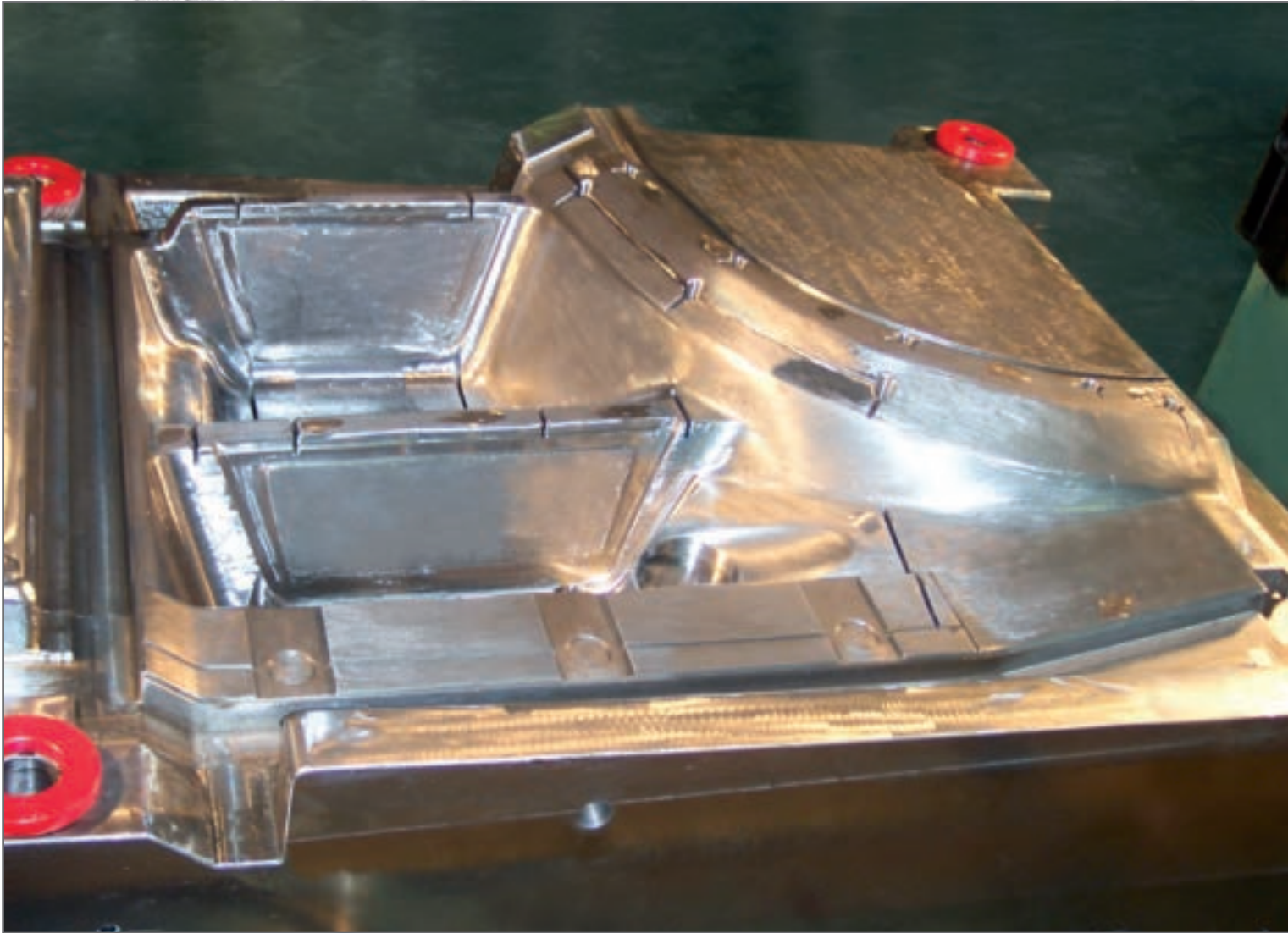

- ▲
- IT Stampo in acciaio temperato per la produzione di un parafrango anteriore in SMC del DAF XF
EN Harded steel mould for the SMC production of the front mudguard for the DAF XF vehicle
DE Gehärtete Stahlform für SMC Produktion für Einstiegskasten DAF XF



applicabile a | suitable to | verwendbar für

51

CF6
CF Euro6

applicabile a I suitable to I verwendbar für:

CF6 Euro 6

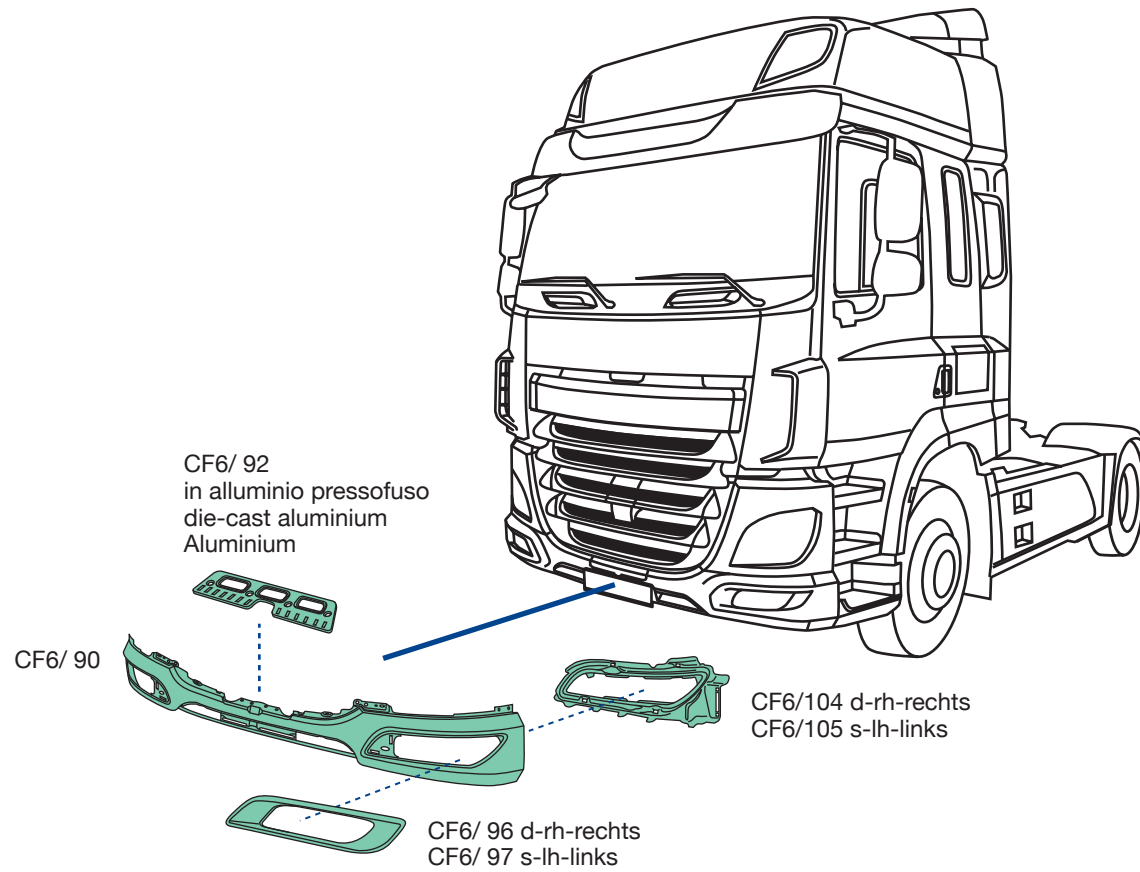

CF6/ 90
O.E.M. 1876631



CF6/ 92
O.E.M. 0964275



CF6/ 96
O.E.M. 1848558
CF6/ 97
O.E.M. 1848557



CF6/104
O.E.M. 1837655
CF6/105
O.E.M. 1837654

CF6 Euro 6

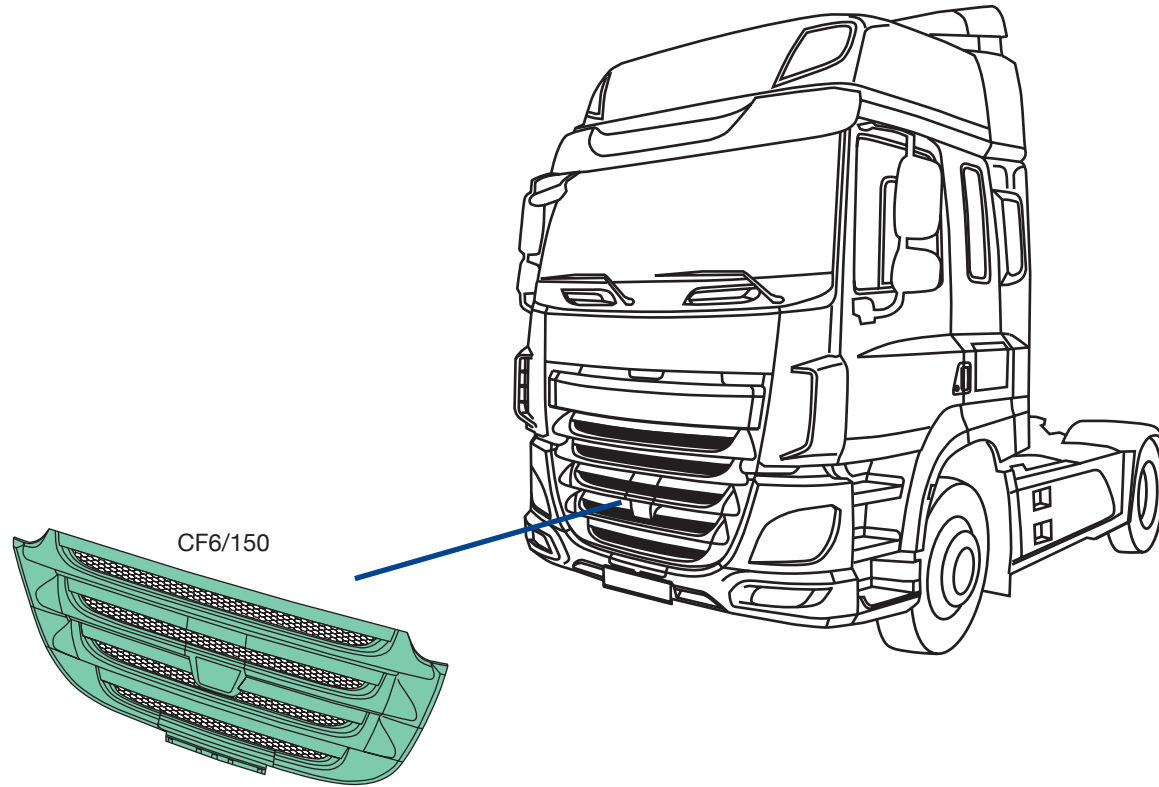

CF6/150



CF6/150
O.E.M. 1886592

applicabile a I suitable to I verwendbar für:

CF6 Euro 6

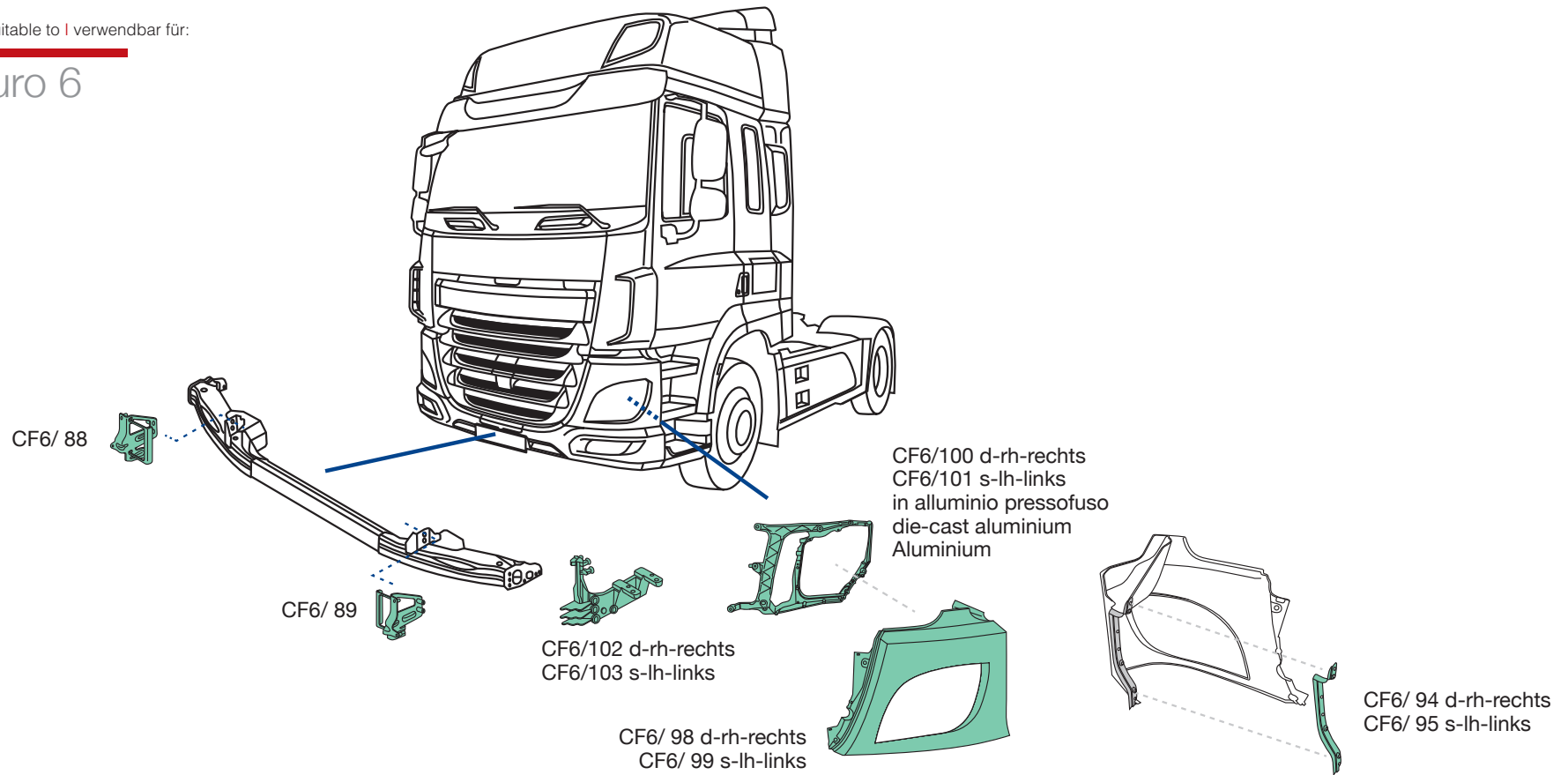

CF6/ 88
O.E.M. 1922986
CF6/ 89
O.E.M. 1922985



CF6/ 94
O.E.M. 1887135
CF6/ 95
O.E.M. 1887134



CF6/ 98
O.E.M. 1881351
CF6/ 99
O.E.M. 1881350



CF6/100
O.E.M. 1837642
CF6/101
O.E.M. 1837641



CF6/102
O.E.M. 1948152
CF6/103
O.E.M. 1948151

CF6 Euro 6

CF6/600

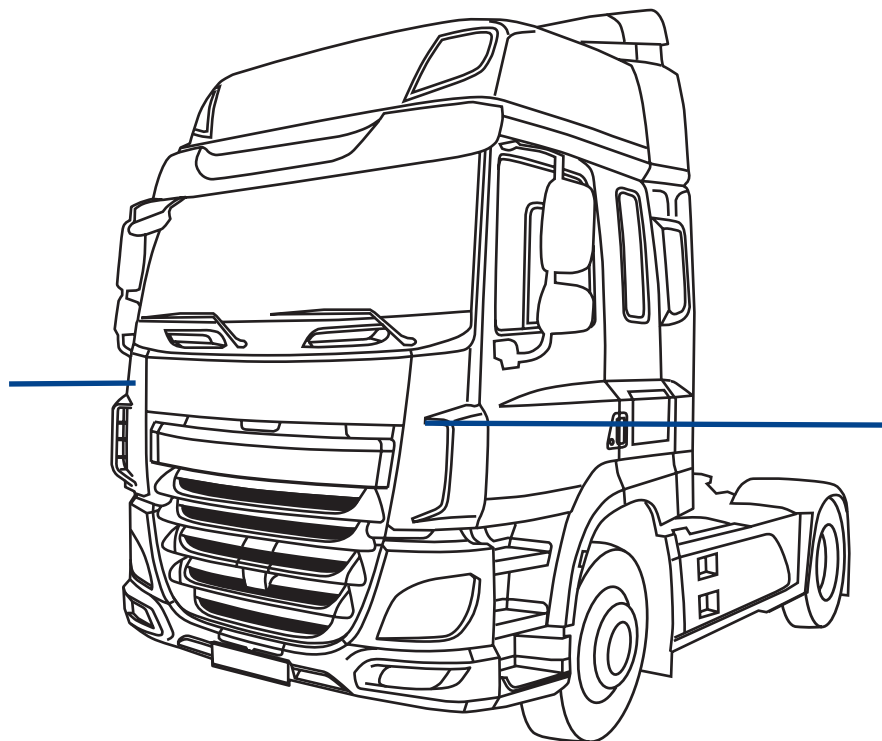
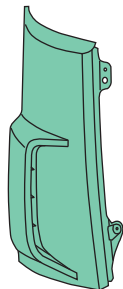

CF6/601

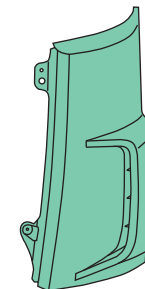

CF6/600
O.E.M. 1844276
CF6/601
O.E.M. 1844275

applicabile a I suitable to I verwendbar für:

CF6 Euro 6

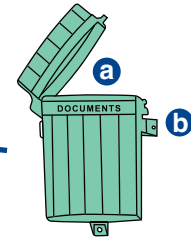
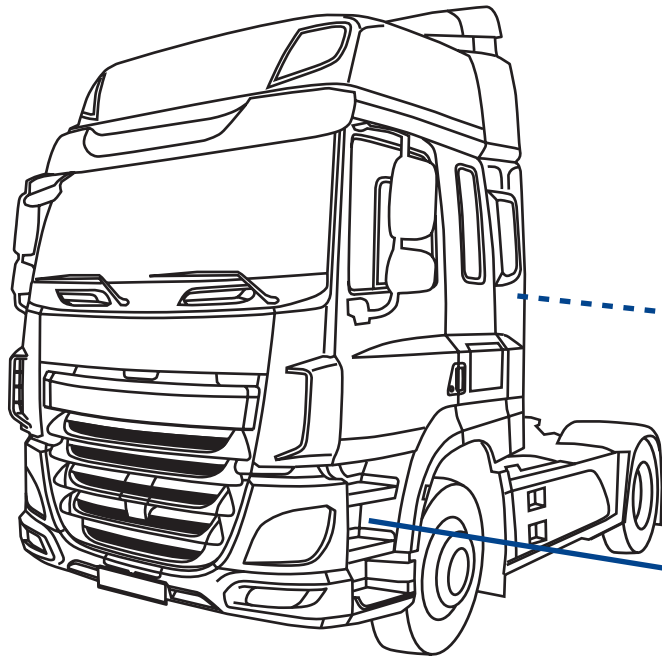

PDS/360

PDS/360

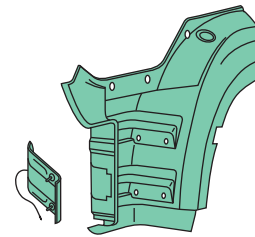
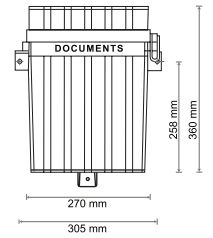

CF6/250 d-rh-rechts
CF6/251 s-lh-links

CF6/200 d-rh-rechts
CF6/201 s-lh-links
completo di
complete with
komplett mit
CF6/250 d-rh-rechts
CF6/251 s-lh-links



CF6/200
O.E.M. 1870503
CF6/201
O.E.M. 1870502



CF6/250
O.E.M. 1835103
CF6/251
O.E.M. 1835102



PDS/360
O.E.M. -

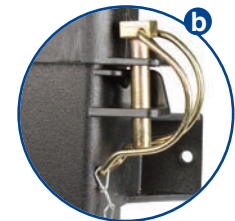

CF6 Euro 6

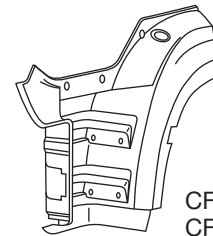
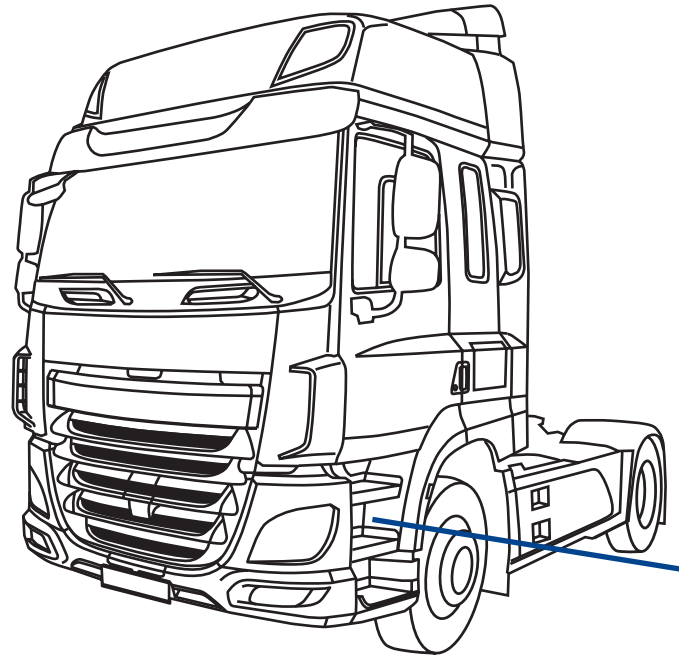

CF6/214 d-rh-rechts
CF6/215 s-lh-links
in alluminio pressofuso
die-cast aluminium
Aluminium



CF6/230 d-rh-rechts
CF6/231 s-lh-links

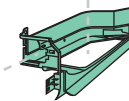

CF6/240 d-rh-rechts
CF6/241 s-lh-links



CF6/214
O.E.M. 1945874
CF6/215
O.E.M. 1945873



CF6/230
O.E.M. 1881347
CF6/231
O.E.M. 1881346



CF6/240
O.E.M. 1952792
CF6/241
O.E.M. 1952791

applicabile a | suitable to | verwendbar für:

CF6 Euro 6



CF0/400

O.E. 1312864 | 1312868 | 1298974

Adattabile a:
Suitable to:
passend für:

**DAF CF65 - CF75 - CF85
confort cab**

Materiale - Material - Material:
PMMA - Acrylglas



CF0/480

O.E. 1434304 | 1312872

KIT completo
di staffe
e minuterie.
Assembly KIT.
Befestigungssatz



L'immagine del prodotto è da considerarsi puramente indicativa | The product image is just for information | Die Produktbilder sind nur zur Information.

L	H	P	kg.
cm.	cm.	cm.	
216	32,5	13	3,505



CF0/405

O.E. 1785061

Adattabile a:
Suitable to:
passend für:

**DAF CF space cab
tetto alto - high roof
hohes Dach**

Materiale - Material - Material:
PMMA - Acrylglas



KIT completo di staffe e minuterie
IN ALLESTIMENTO
KIT complete of brackets and findings
NOT AVAILABLE YET
Befestigungssatz
IN ARBEIT



L	H	P	kg.
cm.	cm.	cm.	
220	40	26	3,905

CF6 Euro 6

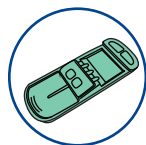

XF5/515



XF5/520
d|s-rh|lh
rechts|links



XF5/516
d-rh-rechts
XF5/517
s-lh-links



XF5/518
d-rh-rechts
XF5/519
s-lh-links
XF5/538
d-rh-rechts
XF5/539
s-lh-links



XF5/510
d|s-rh|lh
rechts|links

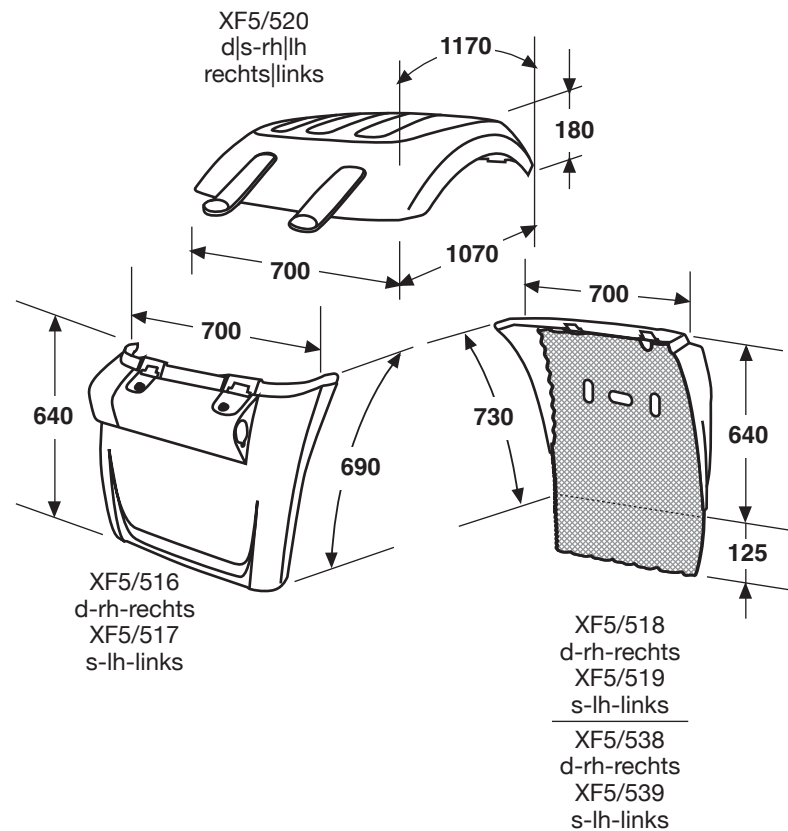

XF5/510
O.E.M. 1875567



XF5/515
O.E.M. 1927847



XF5/520

XF5/520
O.E.M. 1875551
d|s-rh|lh-rechts|links
nero, semipiatta, con cinghietti
black, semi-flat, with stretchers
schwarz, halbfach, mit Spanngummi

XF5/518
O.E.M. 1875554
d-rh-rechts
nero, con anti-spray, con staffe
black, with anti-spray, with brackets
schwarz, mit Spritzschutz, mit Klemme

XF5/538
O.E.M. -
d-rh-rechts
nero, senza anti-spray, con staffe
black, without anti-spray, with brackets
schwarz, ohne Spritzschutz, mit Klemme



XF5/516
O.E.M. 1875550
d-rh-rechts
nero, con staffe
black, with brackets
schwarz, mit Klemme



XF5/517
O.E.M. 1875549
s-lh-links
nero, con staffe
black, with brackets
schwarz, mit Klemme

XF5/519
O.E.M. 1875553
s-lh-links
nero, con anti-spray, con staffe
black, with anti-spray, with brackets
schwarz, mit Spritzschutz, mit Klemme

XF5/539
O.E.M. -
s-lh-links
nero, senza anti-spray, con staffe
black, without anti-spray, with brackets
schwarz, ohne Spritzschutz, mit Klemme

CF6 Euro 6

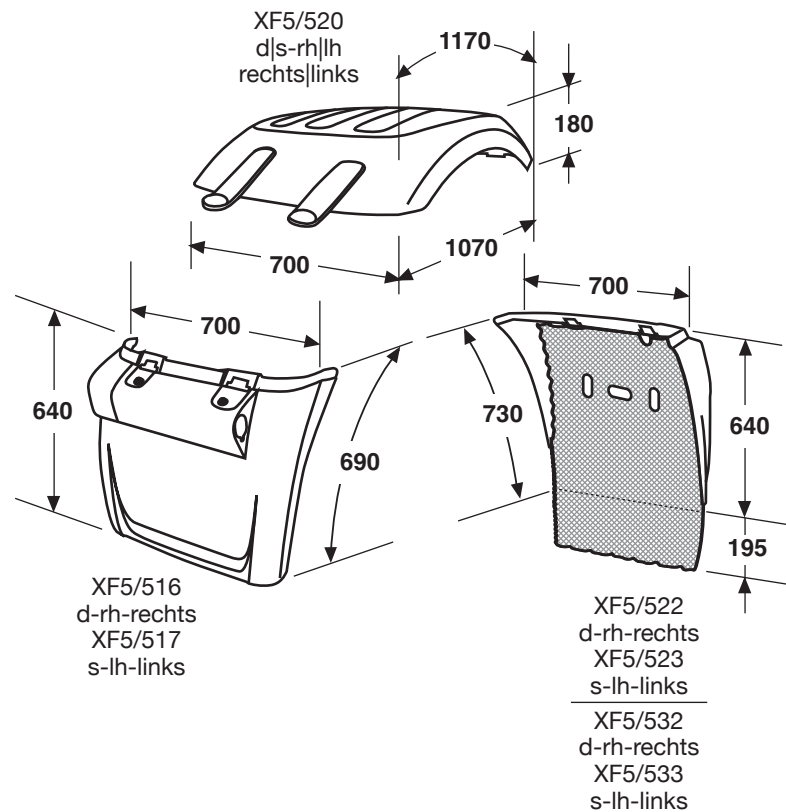
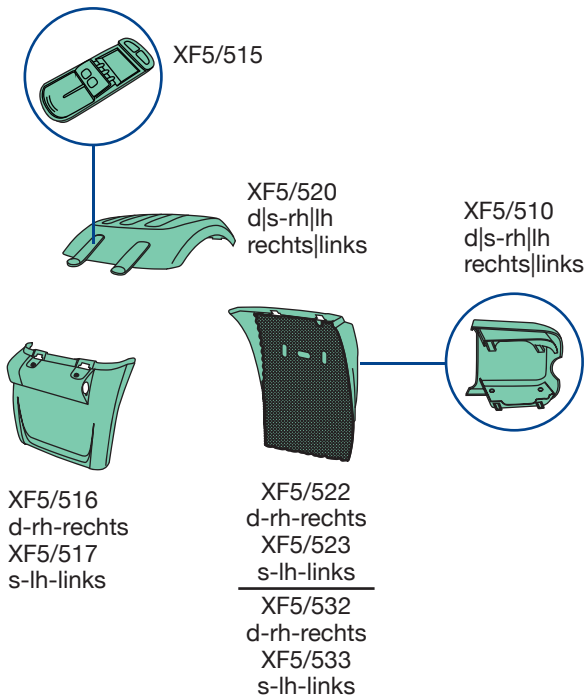

XF5/510
O.E.M. 1875567



XF5/515
O.E.M. 1927847

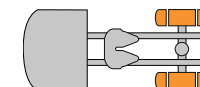

XF5/520
O.E.M. 1875551
d|s-rh|lh-rechts|links
nero, semipiatta, con cinghietti
black, semi-flat, with stretchers
schwarz, halbflach, mit Spanngummi



XF5/522
O.E.M. 1892198
d-rh-rechts
nero, con anti-spray, con staffe
black, with anti-spray, with brackets
schwarz, mit Spritzschutz, mit Klemme

XF5/532
O.E.M. -
d-rh-rechts
nero, senza anti-spray, con staffe
black, without anti-spray, with brackets
schwarz, ohne Spritzschutz, mit Klemme



XF5/520



XF5/517
O.E.M. 1875549
s-lh-links
nero, con staffe
black, with brackets
schwarz, mit Klemme

XF5/523
O.E.M. 1892197
s-lh-links
nero, con anti-spray, con staffe
black, with anti-spray, with brackets
schwarz, mit Spritzschutz, mit Klemme

XF5/533
O.E.M. -
s-lh-links
nero, senza anti-spray, con staffe
black, without anti-spray, with brackets
schwarz, ohne Spritzschutz, mit Klemme



XF5/516
O.E.M. 1875550
d-rh-rechts
nero, con staffe
black, with brackets
schwarz, mit Klemme

CF6 Euro 6

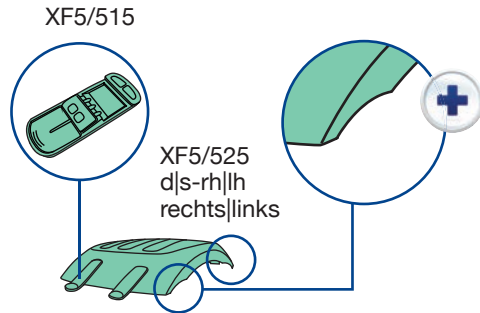

XF5/525
d|s-rh|lh
rechts|links

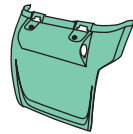

XF5/528
d-rh-rechts
XF5/529
s-lh-links

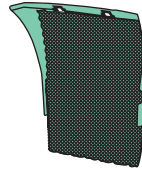

XF5/526
d-rh-rechts
XF5/527
s-lh-links
XF5/536
d-rh-rechts
XF5/537
s-lh-links

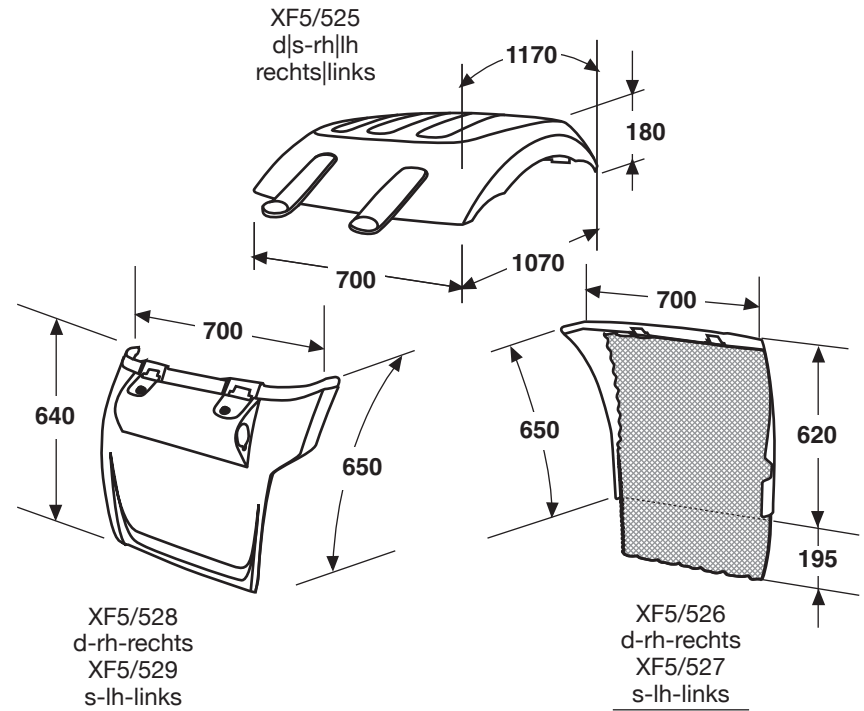

XF5/515
O.E.M. 1927847

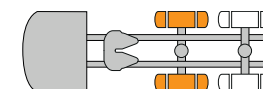

XF5/525
O.E.M. 1875552
d|s-rh|lh-rechts|links
nero, semipiatta, con cinghietti
black, semi-flat, with stretchers
schwarz, halbflach, -mit Spanngummi

XF5/526
O.E.M. 1892248
d-rh-rechts
nero, con anti-spray, con staffe
black, with anti-spray, with brackets
schwarz, mit Spritzschutz, mit Klemme

XF5/536
O.E.M. -
d-rh-rechts
nero, senza anti-spray, con staffe
black, without anti-spray, with brackets
schwarz, ohne Spritzschutz, mit Klemme



XF5/529
O.E.M. 1892245
s-lh-links
nero, con staffe
black, with brackets
schwarz, mit Klemme

XF5/527
O.E.M. 1892247
s-lh-links
nero, con anti-spray, con staffe
black, with anti-spray, with brackets
schwarz, mit Spritzschutz, mit Klemme

XF5/537
O.E.M. -
s-lh-links
nero, senza anti-spray, con staffe
black, without anti-spray, with brackets
schwarz, ohne Spritzschutz, mit Klemme

XF5/528
O.E.M. 1892246
d-rh-rechts
nero, con staffe
black, with brackets
schwarz, mit Klemme



CF6 Euro 6

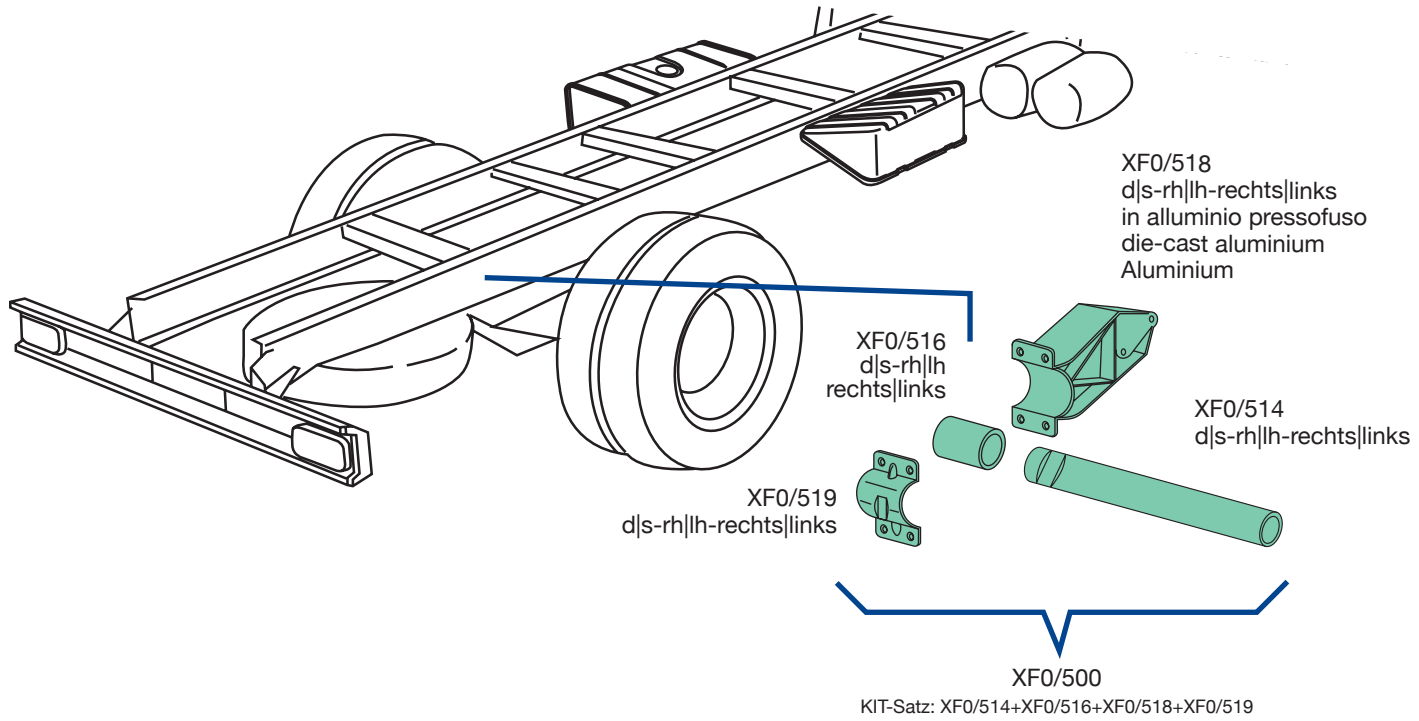

XF0/514
O.E.M. 1610454



XF0/516
O.E.M. 1629045



XF0/518
O.E.M. 2050044



XF0/519
O.E.M. 1629046



XF0/500
O.E.M. 1371224

CF6 Euro 6

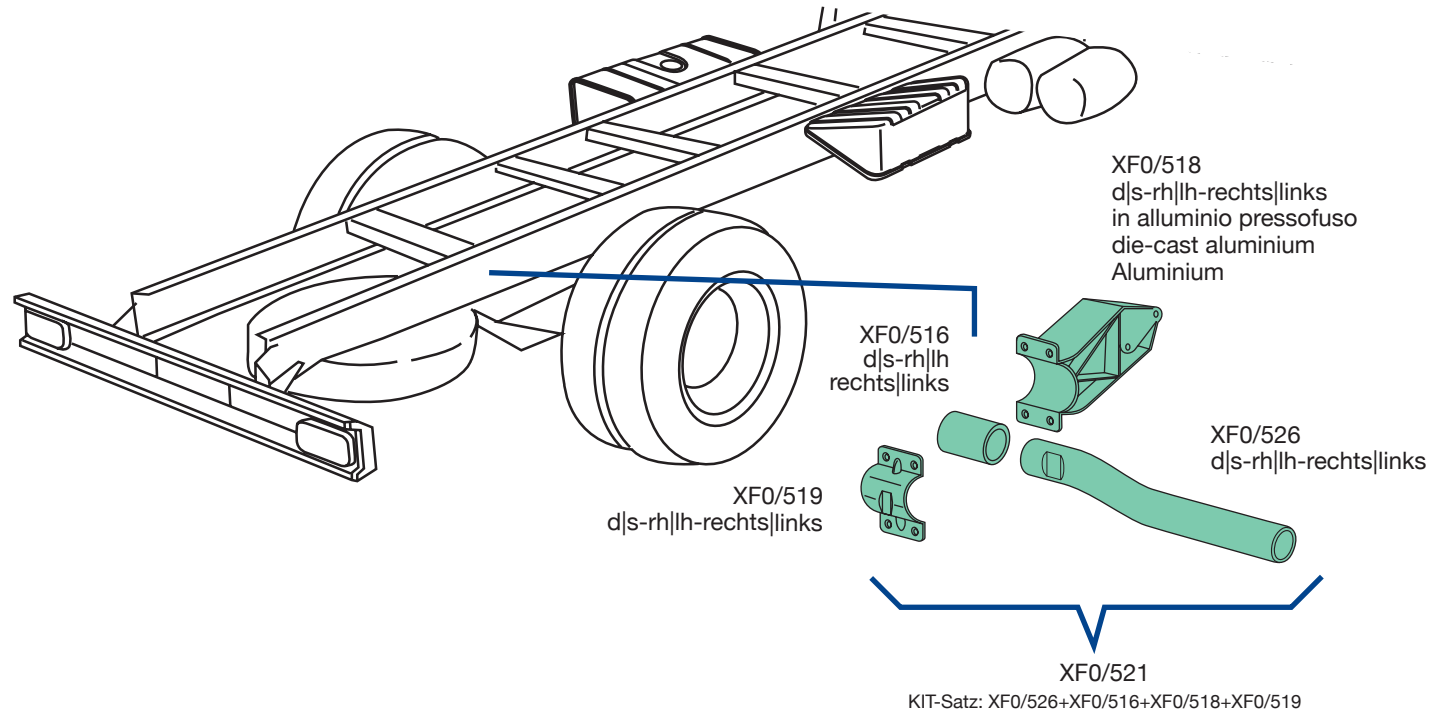

XF0/516
O.E.M. 1629045



XF0/518
O.E.M. 2050044



XF0/519
O.E.M. 1629046



XF0/526
O.E.M. 1629036



XF0/521
O.E.M. 1371226



IT Officina di riparazione
EN Workshop
DE Werkstatt



applicabile a | suitable to | verwendbar für

69

CF0
CF85

applicabile a I suitable to I verwendbar für:

CF85

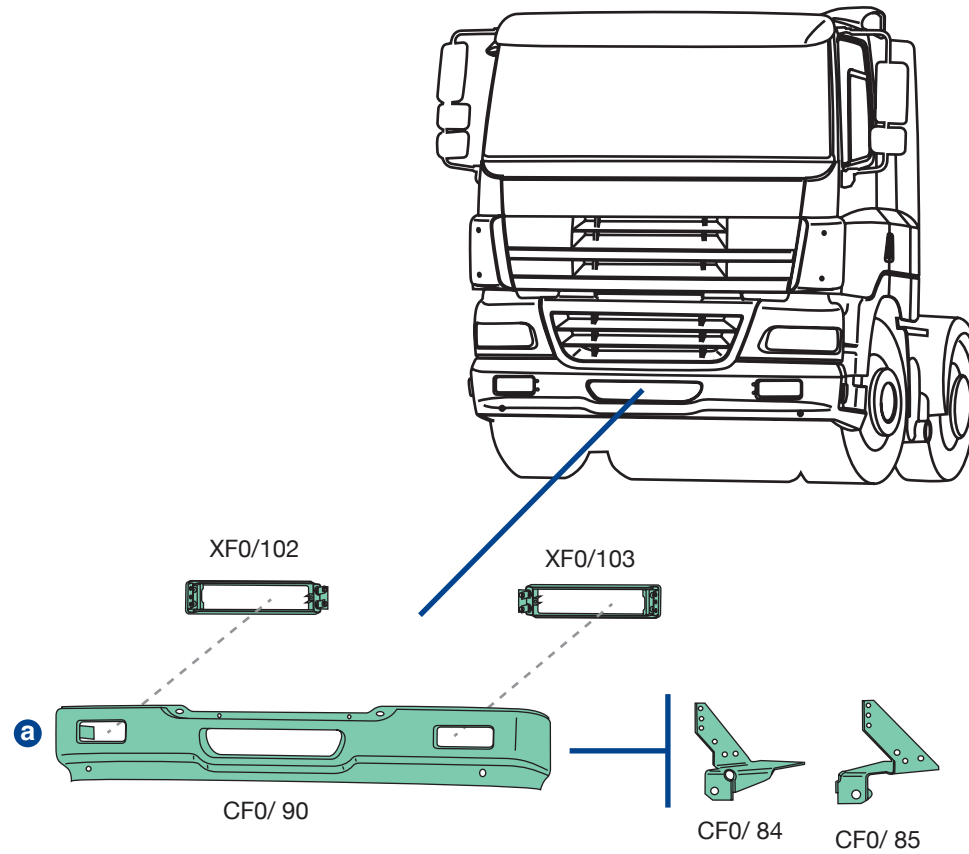

CF0/ 84
O.E.M. 1699473
CF0/ 85
O.E.M. 1699468



CF0/ 90
O.E.M. 1825005



XF0/102
O.E.M. 1449529
XF0/103
O.E.M. 1449528

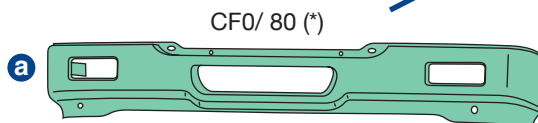
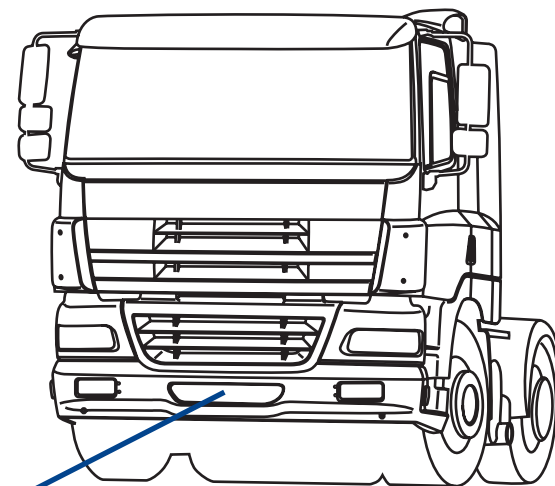

CF0/ 96



CF0/ 97



CF0/ 80
O.E.M. 1826227



CF0/ 96
O.E.M. 1683724
CF0/ 97
O.E.M. 1683723

applicabile a I suitable to I verwendbar für:

CF85

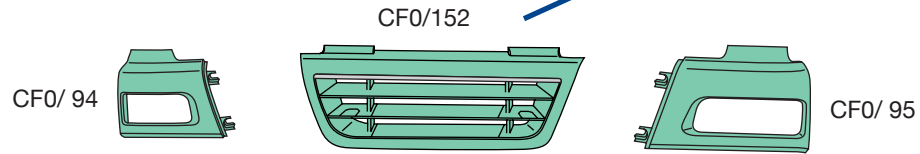
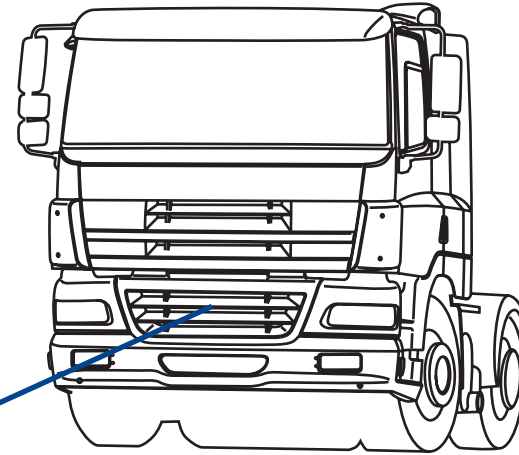

CF0/94
O.E.M. 1363374



CF0/95
O.E.M. 1363373



CF0/152
O.E.M. 1657685

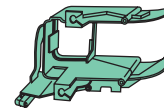

CF0/100 d-rh-rechts
CF0/101 s-lh-links
in alluminio pressofuso
die-cast aluminium
Aluminium

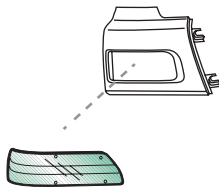

940/085
protezione faro (la coppia)
headlamp protection (pair of)
Scheinwerferschutz (Paar)

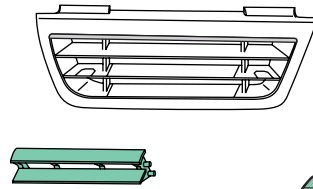

CF0/155

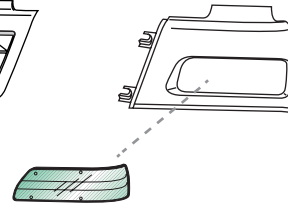

940/085
protezione faro (la coppia)
headlamp protection (pair of)
Scheinwerferschutz (Paar)



CF0/100
O.E.M. 1372802
CF0/101
O.E.M. 1372801



CF0/155
O.E.M. 1363370



940/085
O.E.M. -

applicabile a I suitable to I verwendbar für:

CF85

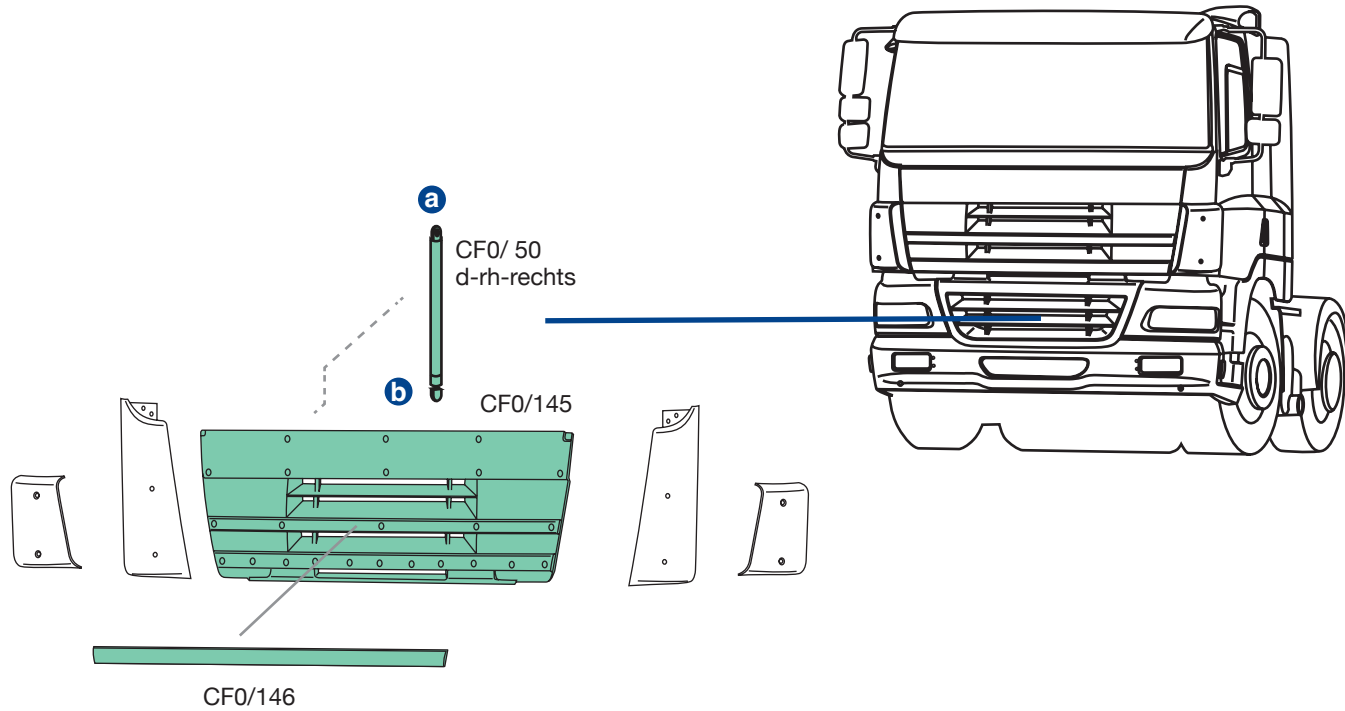

CF0/ 50
O.E.M. 1372540



CF0/145
O.E.M. 1786644



CF0/146
O.E.M. 1372536

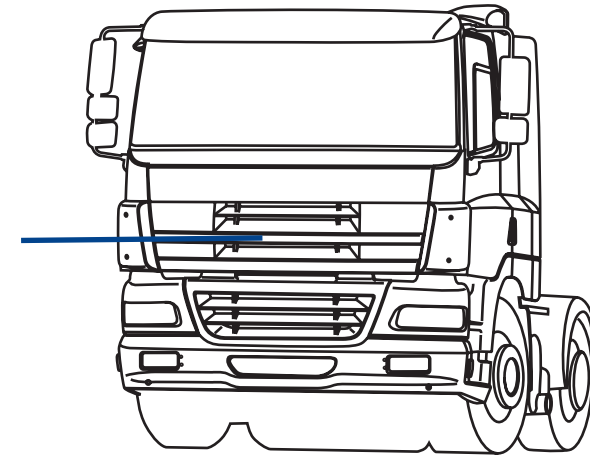
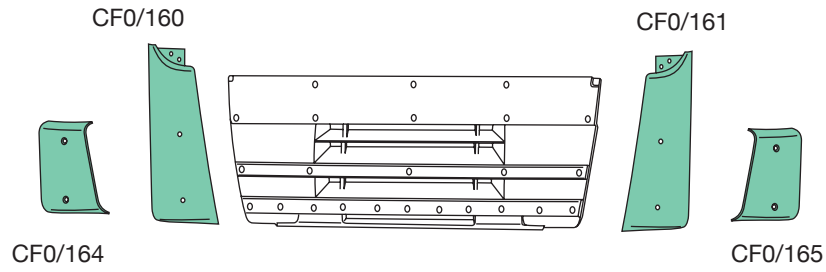

CF0/160
O.E.M. 1372533
CF0/161
O.E.M. 1372532



CF0/164
O.E.M. 1362871
CF0/165
O.E.M. 1362870

applicabile a | suitable to | verwendbar für:

CF85

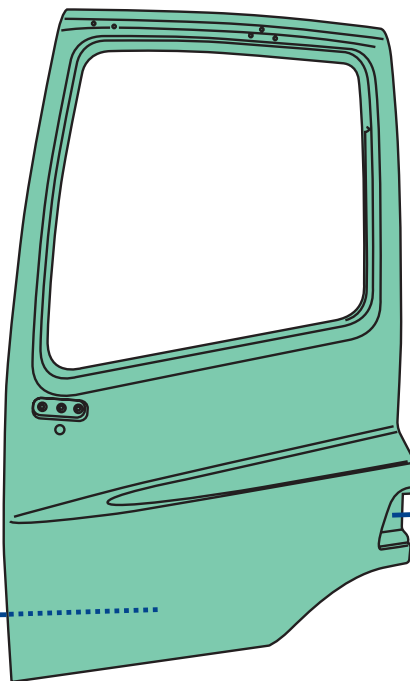
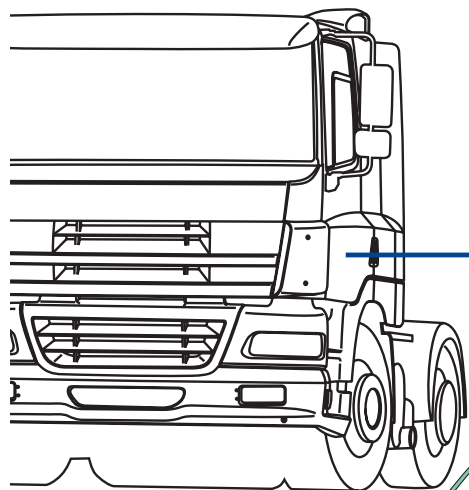

CF0/ 2 d-rh-rechts
CF0/ 3 s-lh-links

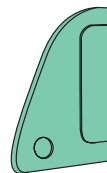

CF0/192 d-rh-rechts
CF0/193 s-lh-links

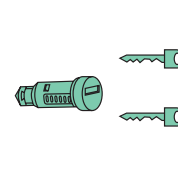
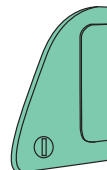

CF0/194 d-rh-rechts
CF0/195 s-lh-links

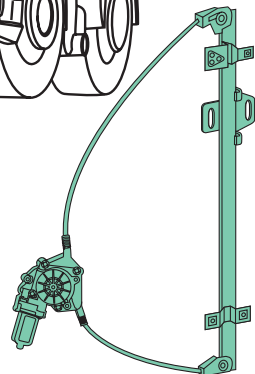

CF0/174 d-rh-rechts
CF0/175 s-lh-links
elettrico con motorino
electric with motor
elektrisch mit Motor



CF0/ 2
O.E.M. 1940527
CF0/ 3
O.E.M. 1940526



CF0/174
O.E.M. 1374569
CF0/175
O.E.M. 1374568



CF0/192
O.E.M. 1651635
CF0/193
O.E.M. 1651634



CF0/194
O.E.M. 1617041
CF0/195
O.E.M. 1617040

(a) Con anti-spray-With anti-spray-mit Spritzschutz

applicabile a | suitable to | verwendbar für:

CF85

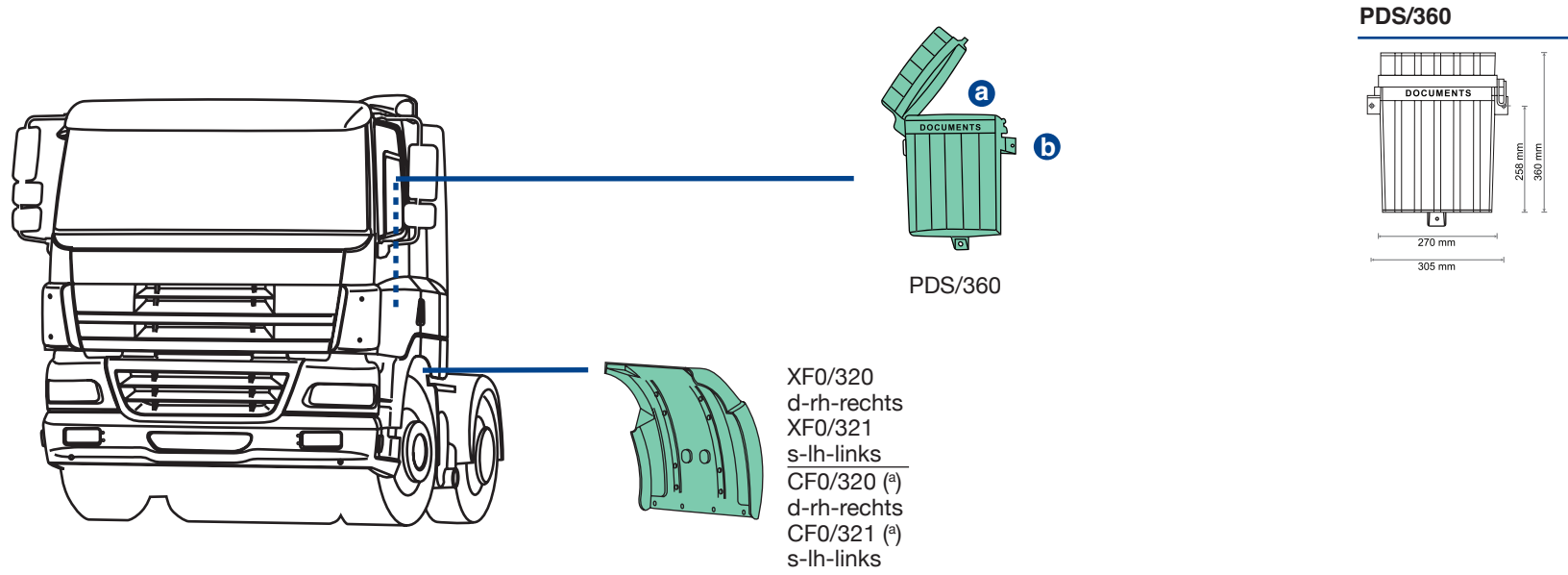

XF0/320
O.E.M. 1997262
XF0/321
O.E.M. 1997261

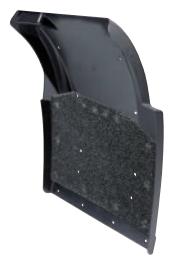

CF0/320
O.E.M. 1997258
CF0/321
O.E.M. 1997257



PDS/360
O.E.M. -

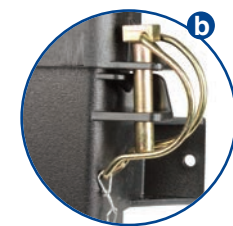

CF85

(*) Vernice di fondo-Unprocessed-grundiert
(°) Verniciato grigio-Grey painted-grau lackiert

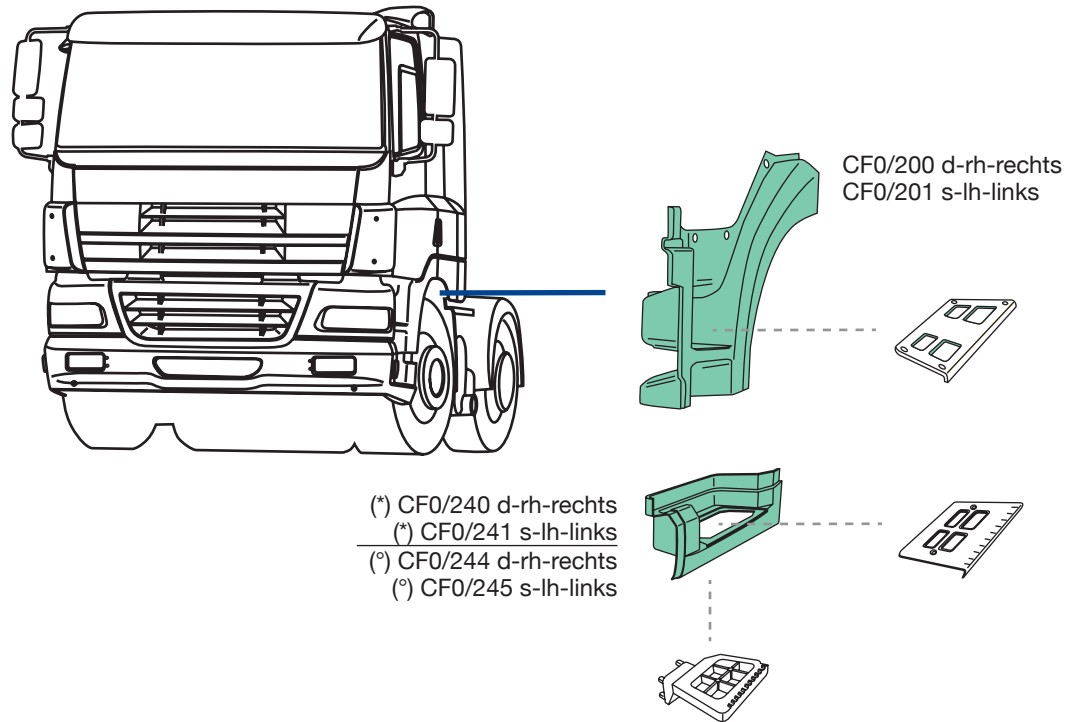

CF0/200
O.E.M. 1893902
CF0/201
O.E.M. 1893901



CF0/240
O.E.M. 1911155
CF0/241
O.E.M. 1911154



CF0/244
O.E.M. 1440243
CF0/245
O.E.M. 1440242

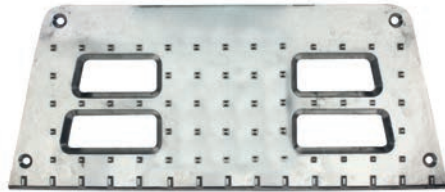
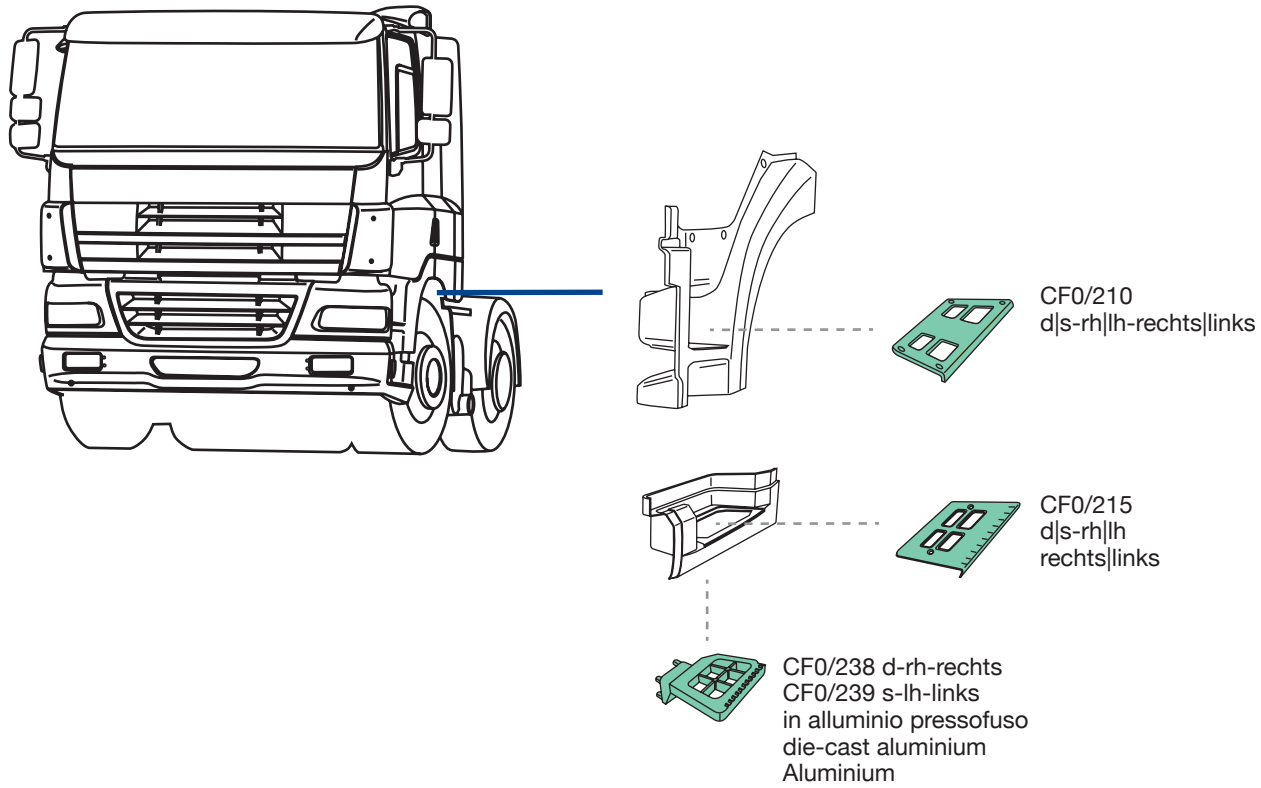

CF0/210
O.E.M. 0750899

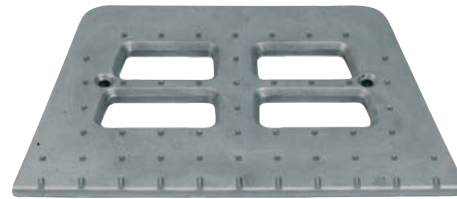

CF0/215
O.E.M. 0962101



CF0/238
O.E.M. 1638481
CF0/239
O.E.M. 1638480

CF85

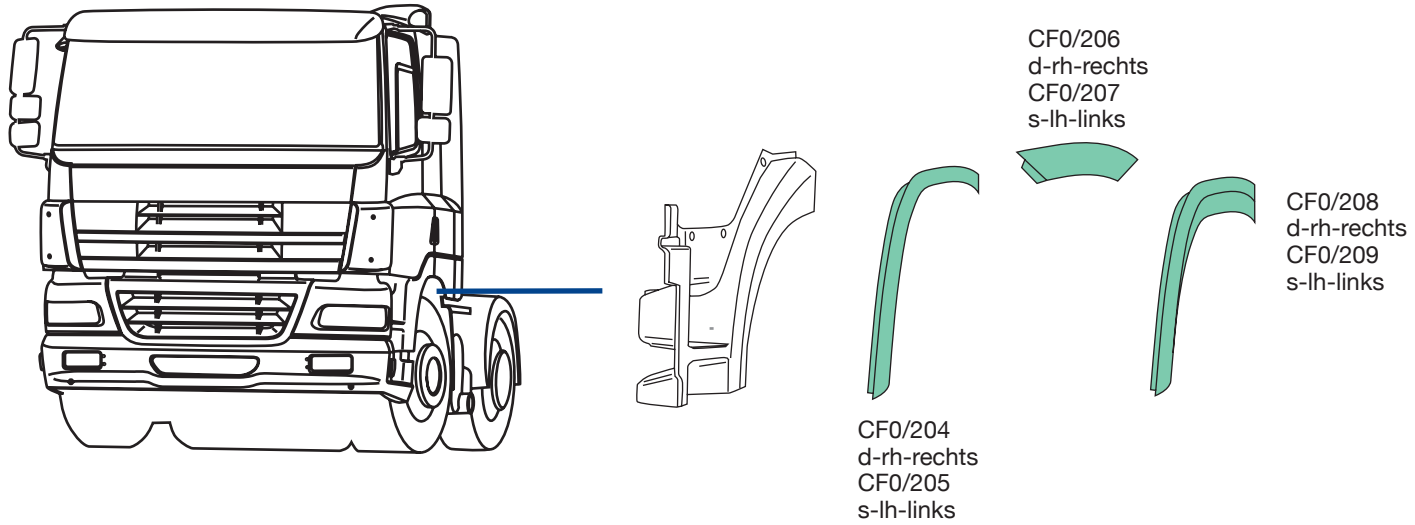

CF0/204
O.E.M. 1298528
CF0/205
O.E.M. 1298527



CF0/206
O.E.M. 1307511
CF0/207
O.E.M. 1307510



CF0/208
O.E.M. 1324633
CF0/209
O.E.M. 1324632



IT Robot di foratura e taglio visiera parasole
EN Sunvisors drilling and cutting robot
DE Bohr- und Schnitrobot für Sonnenblende

applicabile a | suitable to | verwendbar für:

CF85



CF0/400

O.E. 1312864 | 1312868 | 1298974

Adattabile a:
Suitable to:
passend für:

**DAF CF65 - CF75 - CF85
confort cab**

Materiale - Material - Material:
PMMA - Acrylglas



CF0/480

O.E. 1434304 | 1312872

KIT completo
di staffe
e minuterie.
Assembly KIT.
Befestigungssatz



L'immagine del prodotto è da considerarsi puramente indicativa | The product image is just for information | Die Produktbilder sind nur zur Information.

L	H	P	kg.
cm.	cm.	cm.	
216	32,5	13	3,505





CF0/405

O.E. 1785061

Adattabile a:
Suitable to:
passend für:

DAF CF space cab
tetto alto - high roof
hohes Dach

Materiale - Material - Material:
PMMA - Acrylglas

KIT completo di staffe e minuterie
IN ALLESTIMENTO
KIT complete of brackets and findings
NOT AVAILABLE YET
Befestigungssatz
IN ARBEIT



L	H	P	kg.
cm.	cm.	cm.	
220	40	26	3,905

CF0/410

O.E. 1371875

Adattabile a:
Suitable to:
passend für:

**DAF CF65 - CF75 - CF85
confort cab**

Materiale - Material - Material:
PMMA - Acrylglas

IN ALLESTIMENTO

NOT AVAILABLE YET

IN ARBEIT

L	H	P	kg.
cm.	cm.	cm.	
-	-	-	-



CF0/485

O.E. 1434334

KIT completo
di staffe
e minuterie.
Assembly KIT.
Befestigungssatz



L'immagine del prodotto è da considerarsi puramente indicativa | The product image is just for information | Die Produktbilder sind nur zur Information.

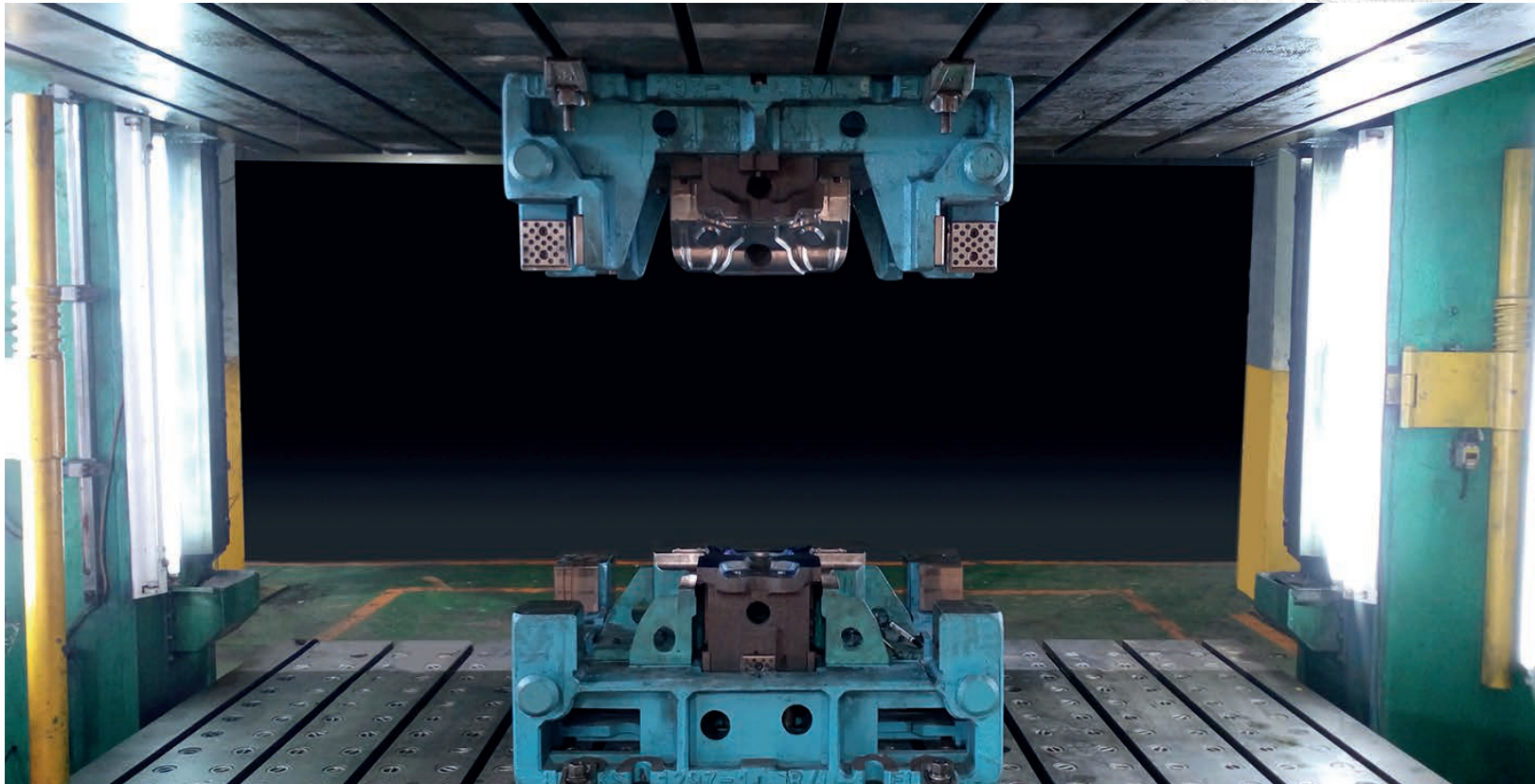

IT Prova di accoppiamento sotto pressa stampo a iniezione per ossatura portafaro
EN Headlamp housing injection moulding press matching test
DE Unterdruck Anpassung der Spritzgießform fuer den scheinwerfer traeger

applicabile a I suitable to I verwendbar für:

CF85



CF0/500

1952146
(1813005)



II (E4) 024094
177x363 mm



IV (E4) 024095
207x161 mm

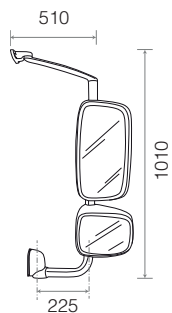

applicabilità:
applicable to:
Verwendbar für

DAF CF 65-75-85 07/2009→2011

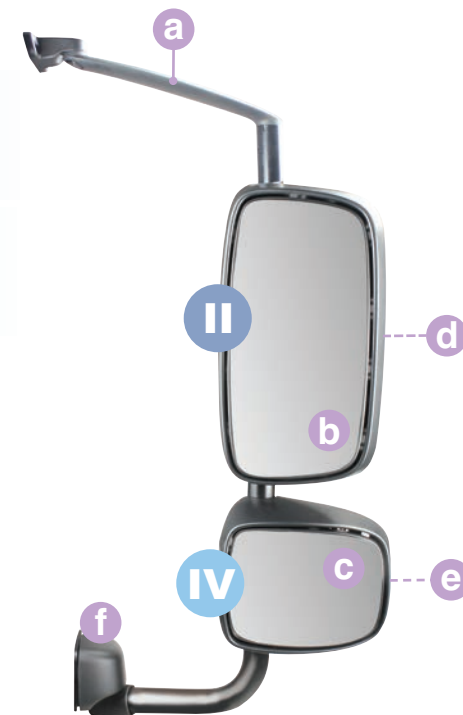

COVIND

XF5/509

1812862
(1689348)



224x412 mm

XF5/507

1817860
(1689347)



242x222 mm

a	CF0/502	1818353 (1788487) (1788976)			<p>+ f</p> <p>385x1010 mm</p>
b	XF5/502	1685330			<p>E4 024094</p> <p>177x363 mm</p>
c	XF5/503	1685331			<p>E4 024095</p> <p>207x161 mm</p>
IV					
d	XF5/506	1644325 (1659248)			<p>223x410 mm</p>
e	XF5/505	1644326 (1659249)			<p>242x218 mm</p>
IV					
f	XF5/512	1644323			

applicabile a I suitable to I verwendbar für:

CF85



CF0/501

1952141
(1808561)



II (E4) 024094
177x363 mm



IV (E4) 024095
207x161 mm

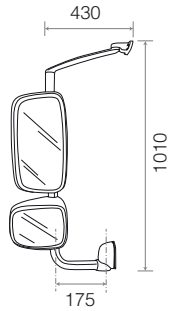

applicabilità:
applicable to:
Verwendbar für

DAF CF 65-75-85 07/2009→2011

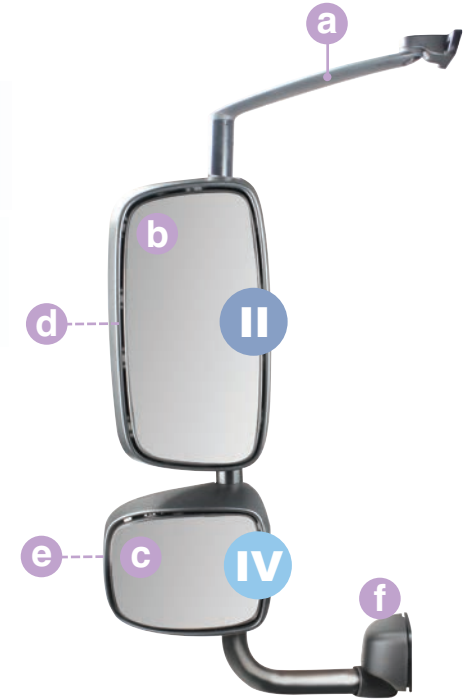

COVIND

XF5/509

1812862
(1689348)















224x412 mm

XF5/507

1817860
(1689347)



242x222 mm

<p>a CF0/503</p>	<p>1812859 (1788972)</p>			<p>+ f 375x1010 mm</p>
<p>b XF5/502</p> <p>II</p>	<p>1685330</p>			<p>E4 024094 177x363 mm</p>
<p>c XF5/503</p> <p>IV</p>	<p>1685331</p>			<p>E4 024095 207x161 mm</p>
<p>d XF5/506</p> <p>II</p>	<p>1644325 (1659248)</p>			<p>223x410 mm</p>
<p>e XF5/505</p> <p>IV</p>	<p>1644326 (1659249)</p>			<p>242x218 mm</p>
<p>f XF5/513</p>	<p>1644324</p>			

CF85

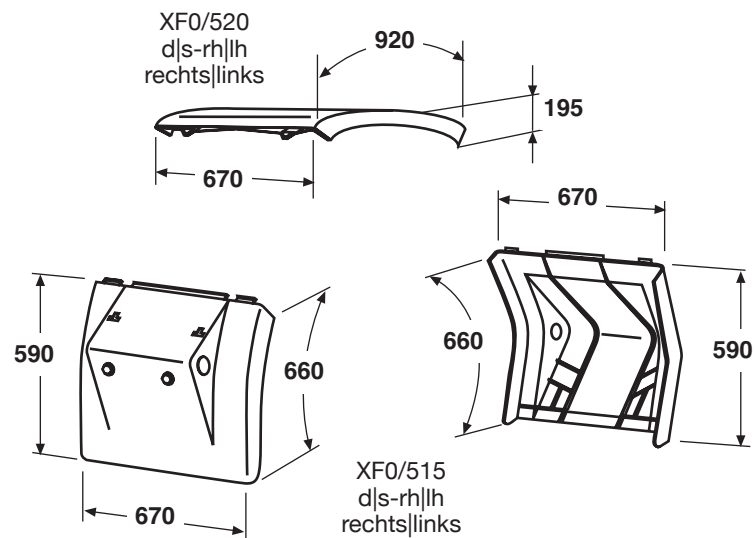
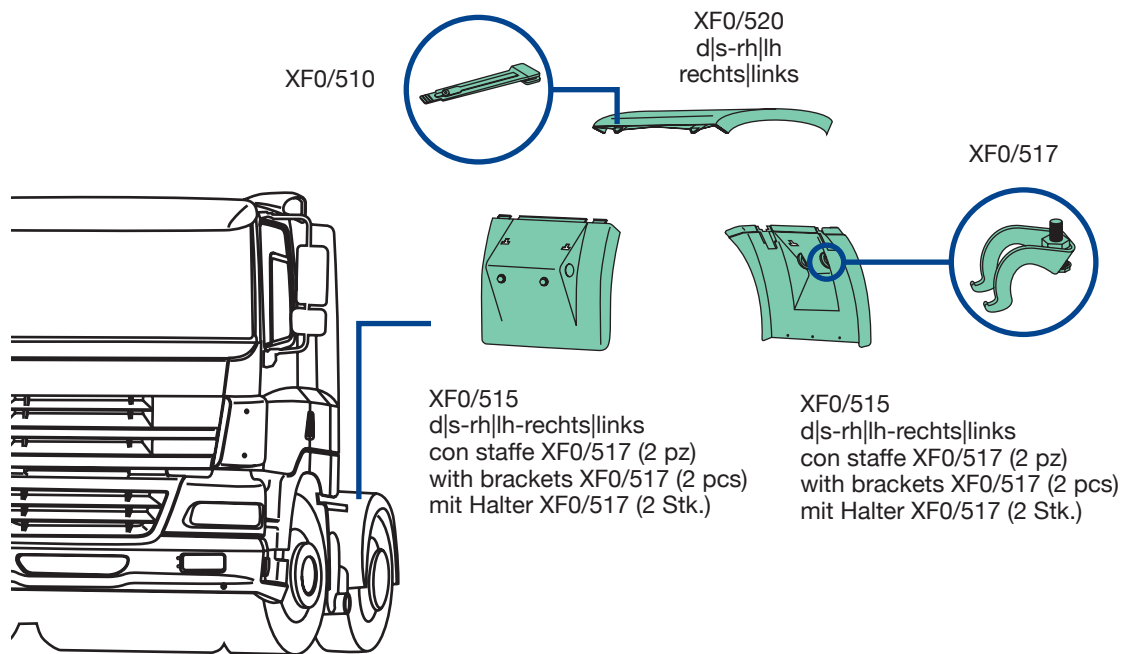

XF0/510
O.E.M. 1340450



XF0/517
O.E.M. 1649588

XF0/520
 O.E.M. 1328935
 d|s-rh|h-rechts|links
 grigio scuro, semipiatta con cinghietti
 dark grey, semi-flat with stretchers
 dunkelgrau, halbflach, mit Spanngummi



XF0/515

XF0/515
 O.E.M. 1328934
 d|s-rh|h-rechts|links
 grigio scuro, senza anti-spray, con staffe
 dark grey, without anti-spray, with brackets
 dunkelgrau, ohne Spritzschutz mit Klemme

CF85

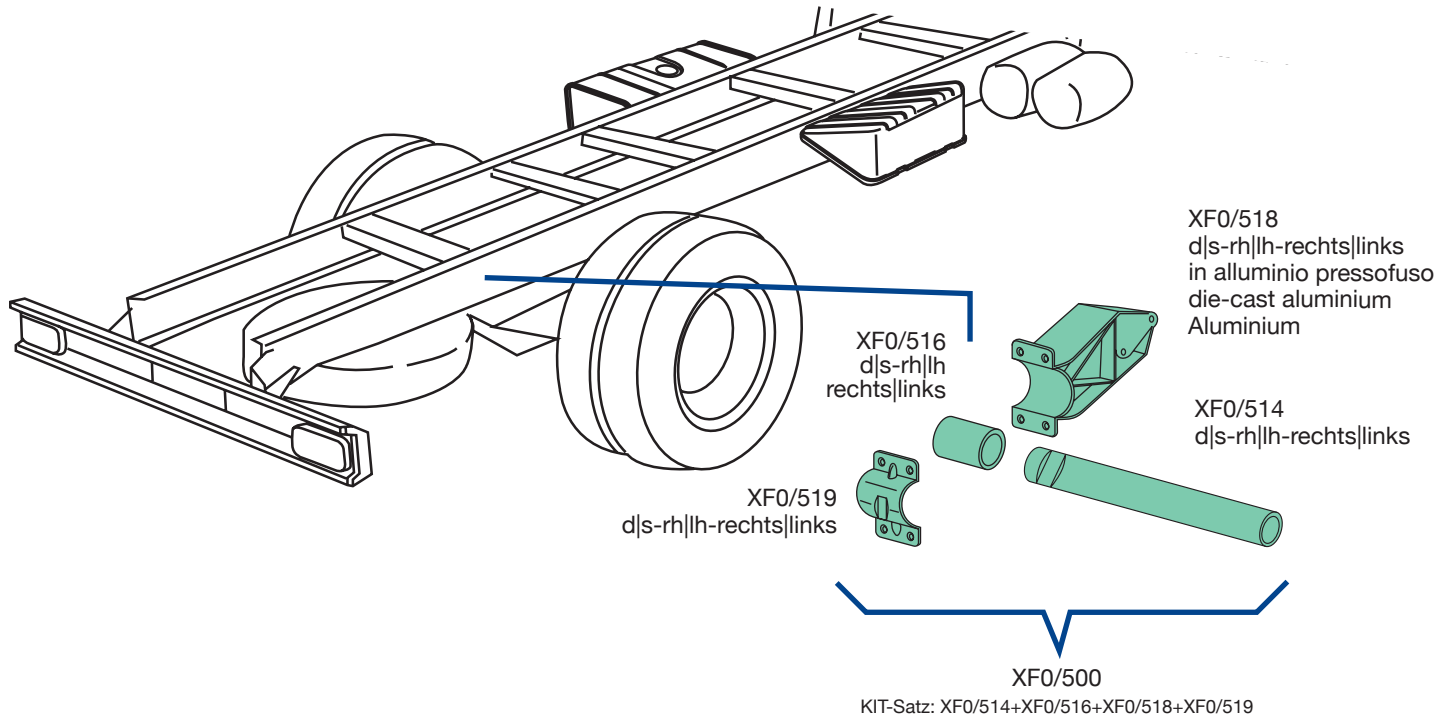

XF0/514
O.E.M. 1610454



XF0/516
O.E.M. 1629045



XF0/518
O.E.M. 2050044



XF0/519
O.E.M. 1629046



XF0/500
O.E.M. 1371224

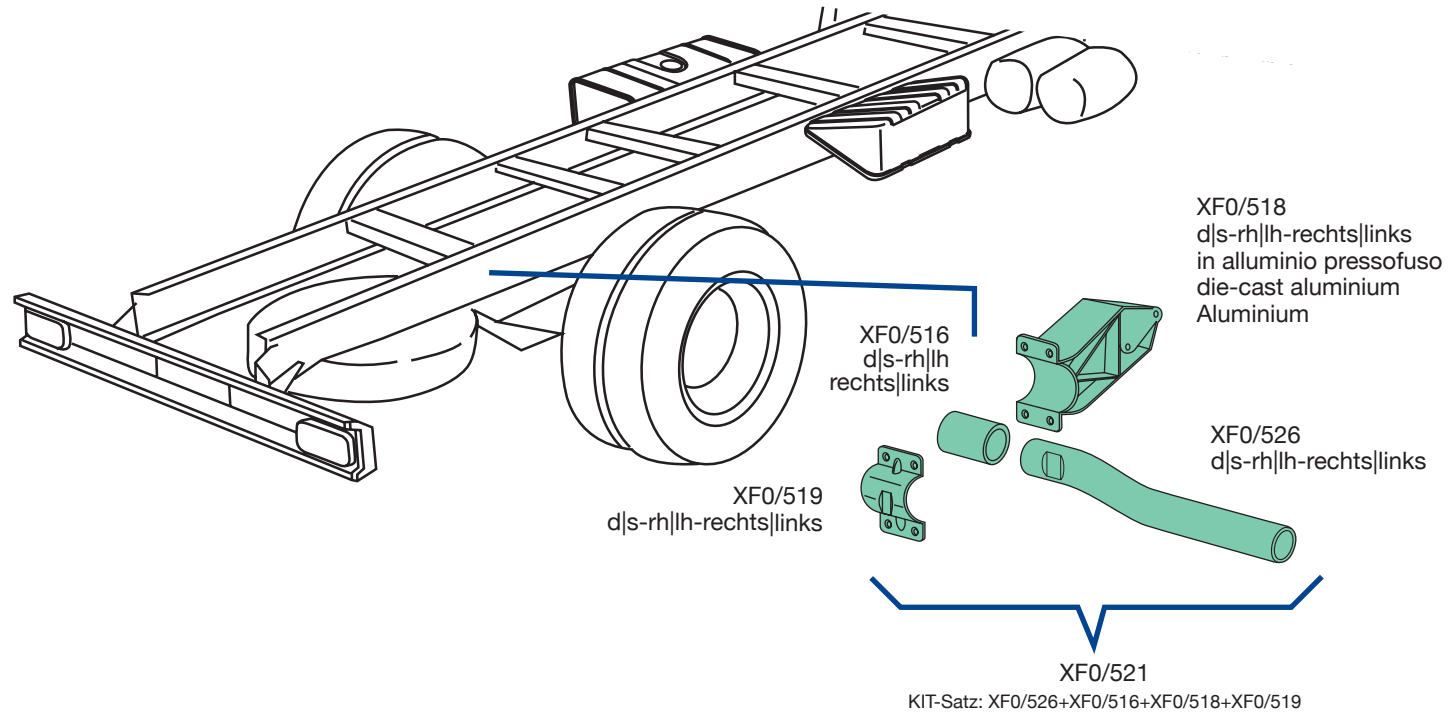

XF0/516
O.E.M. 1629045



XF0/518
O.E.M. 2050044



XF0/519
O.E.M. 1629046



XF0/526
O.E.M. 1629036



XF0/521
O.E.M. 1371226

applicabile a | suitable to | verwendbar für:

CF85

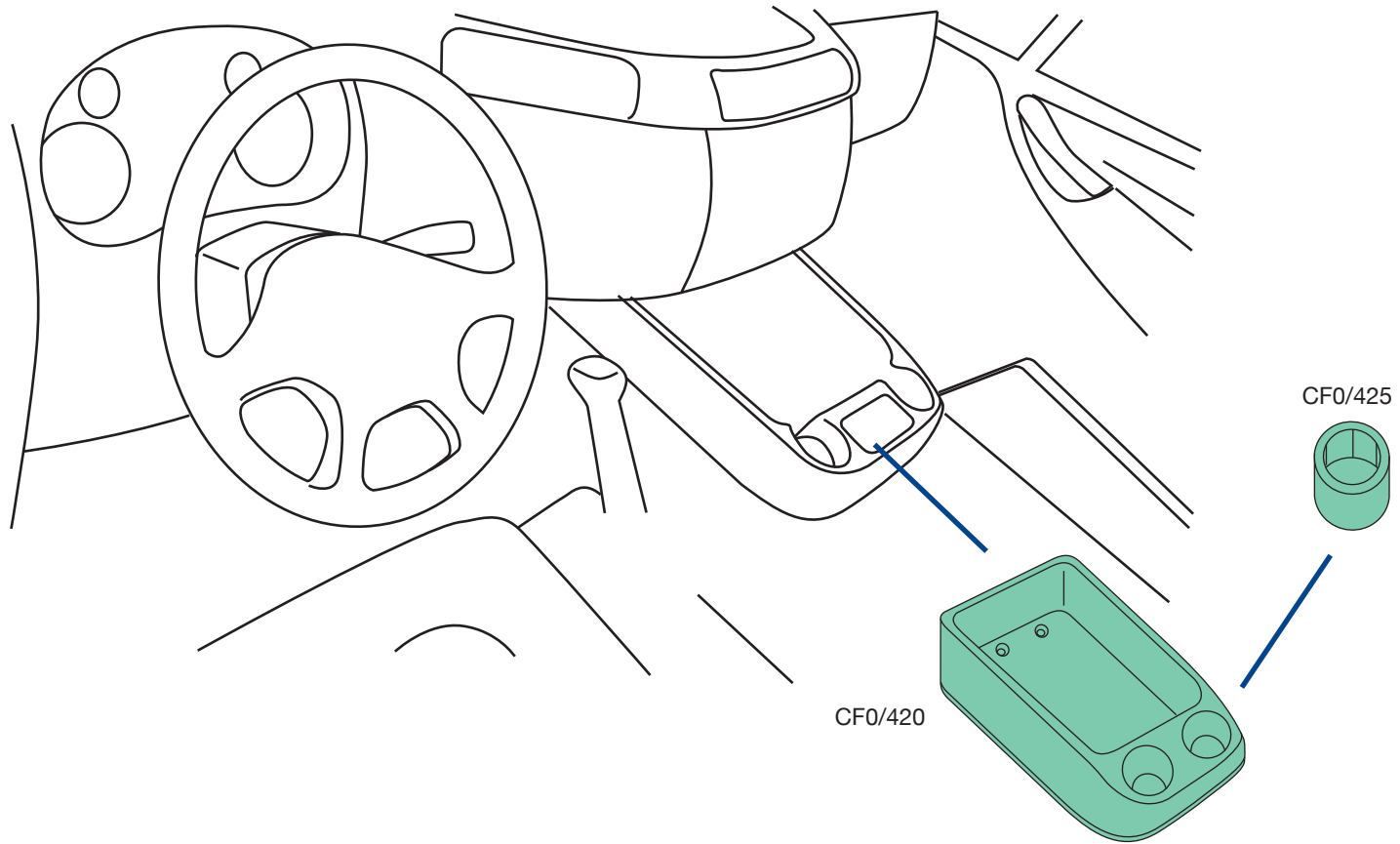

CF0/420
O.E.M. 1326479



CF0/425
O.E.M. 1331209

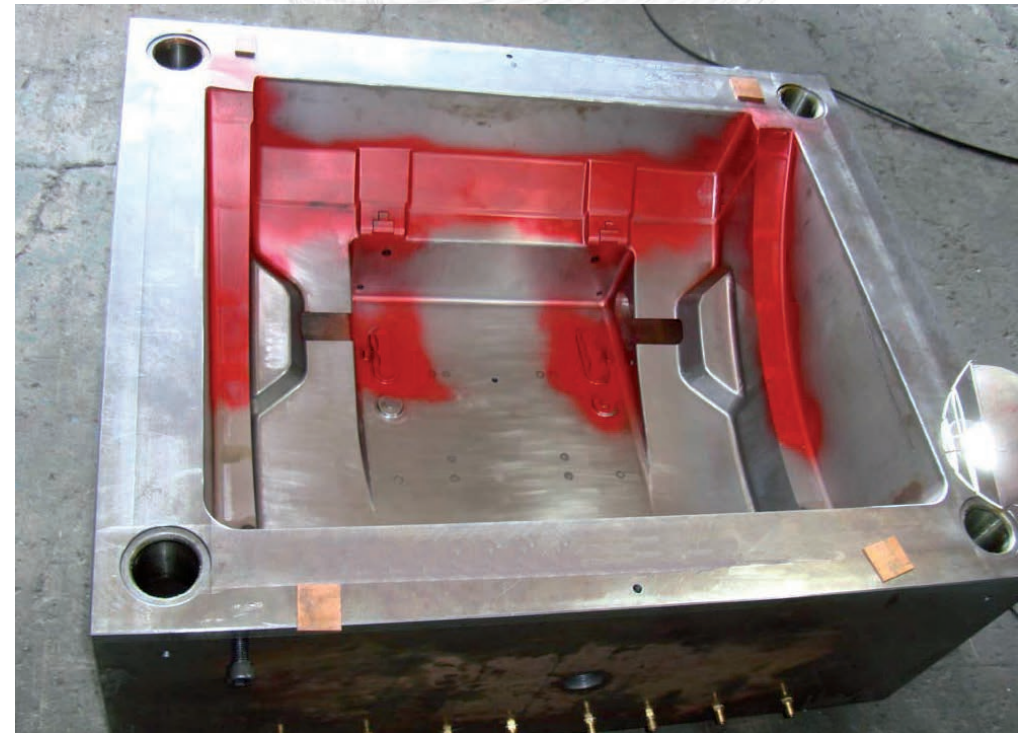
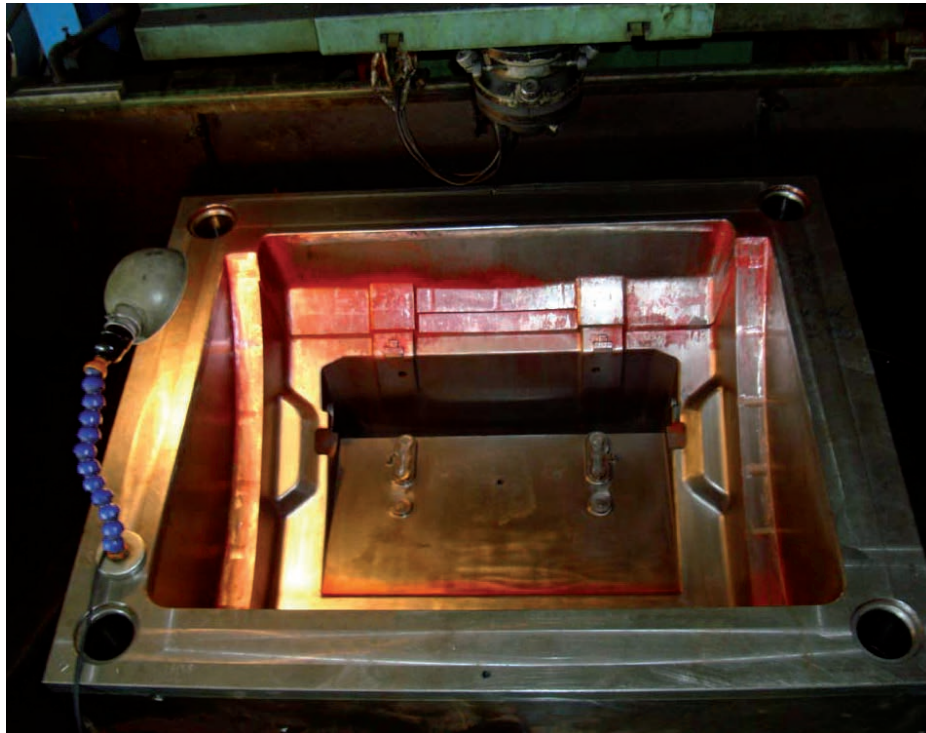

IT Stampo per lo stampaggio ad iniezione di un semiparafango posteriore
EN Mould for the production of the rear mudguard
DE Form zum Spritzgießen des Hinterachskotflügels

applicabile a I suitable to I verwendbar für:

CF85

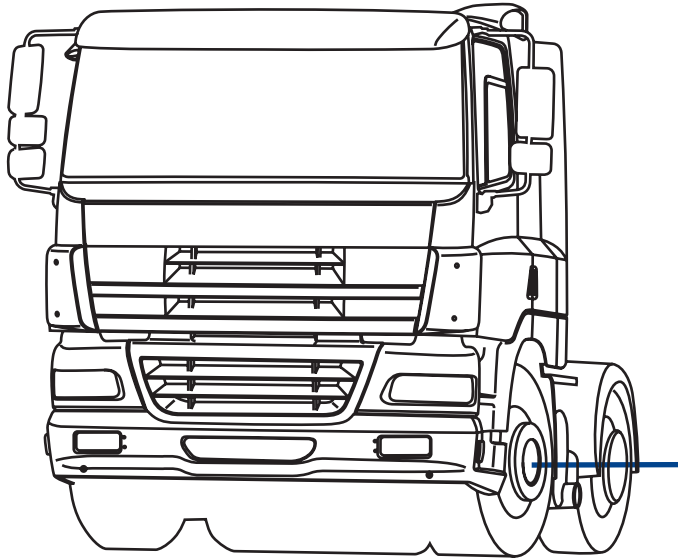

930/032

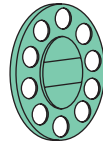

930/001
d-rh-rechts
930/002
s-lh-links



930/200
d|s-rh|lh
rechts|links

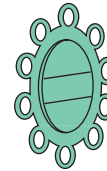

930/100
d-rh-rechts
930/101
s-lh-links



930/032
O.E.M. -



930/001
O.E.M. -
930/002
O.E.M. -



930/100
O.E.M. -
930/101
O.E.M. -

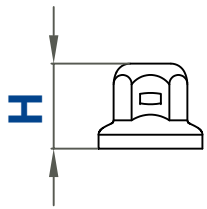

930/200
O.E.M. -

930/032 - Tappo copri bullone-Bolt cover-Radmutterkappe

H	45 mm
Per bulloni \varnothing -bolt \varnothing -Bolzen \varnothing	32 mm
Materiale-Material	acciaio inox-stainless steel Edelstahl
Kg	0,025

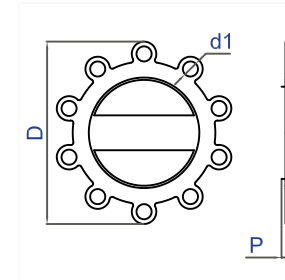
**930/100 d-rh-rechts - 930/101 s-lh-links**

D \varnothing 387 mm	P 30 mm
d1 nr. 10	d1 \varnothing 32 mm
Ventilata	si-yes-Ja
Ventilated-Belüftet	
Colore	cromato e nero-chrome and black
Colours-Farbe	verchromt und schwarz
Materiale-Material	acciaio inox e plastica stainless steel and plastic Edelstahl und Kunststoff
Kg	0,655

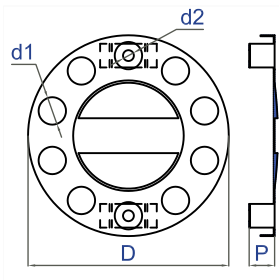
**930/001 d-rh-rechts - 930/002 s-lh-links**

D \varnothing 425 mm	P 50 mm
d1 nr. 10	d1 \varnothing 58 mm
d2 nr. 2	d2 \varnothing 23 mm
Ventilata	si-yes-ja
Ventilated-Belüftet	
Colore	cromato e nero-chrome and black
Colours-Farbe	verchromt und schwarz
Materiale-Material	acciaio inox e plastica stainless steel and plastic Edelstahl und Kunststoff
Kg	1,230

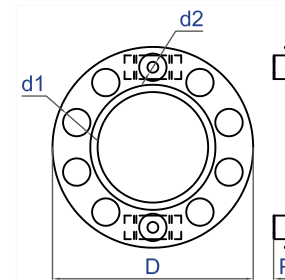
**930/200 d|s-rh|lh-rechts|links**

D \varnothing 425 mm	P 40 mm
d1 nr. 10	d1 \varnothing 58 mm
d2 nr. 2	d2 \varnothing 23 mm
Ventilata	no-nein
Ventilated-Belüftet	
Colore	cromato-chrome-verchromt
Colours-Farbe	
Materiale-Material	acciaio inox-stainless steel Edelstahl
Kg	1,155

applicabile a | suitable to | verwendbar für:

CF85

240/675



240/677



038/678

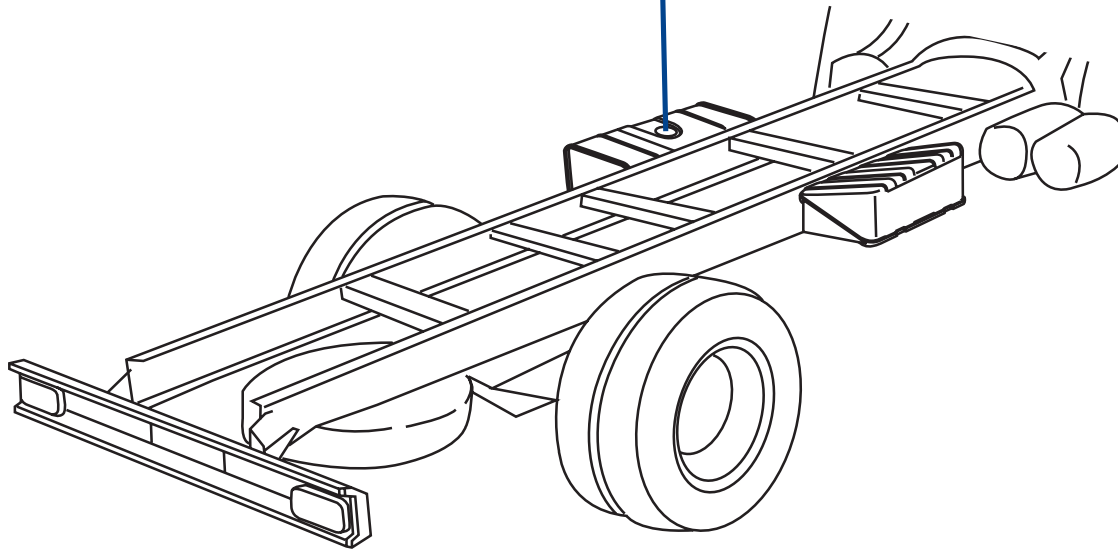

240/675

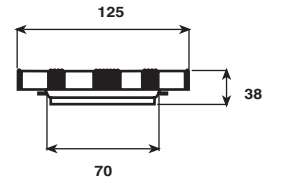

240/677

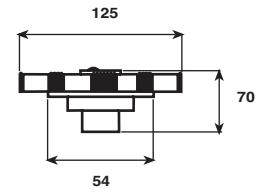

038/678

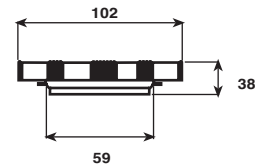

240/675
O.E.M. 41042699



240/677
O.E.M. 500043667



038/678
O.E.M. 4821320

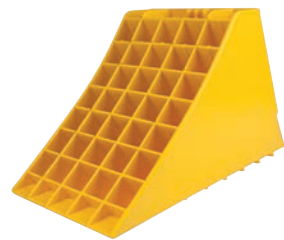
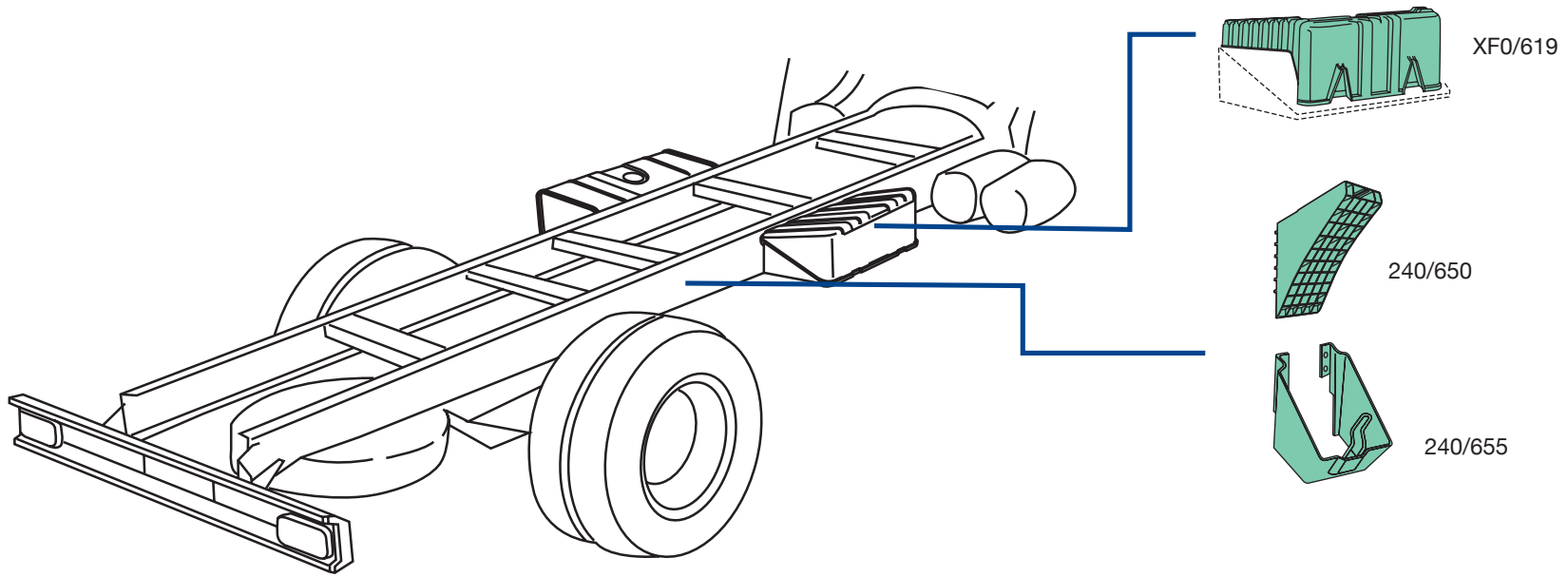

240/650
O.E.M. 99430053



240/655
O.E.M. 41026756



XF0/619
O.E.M. 1745335

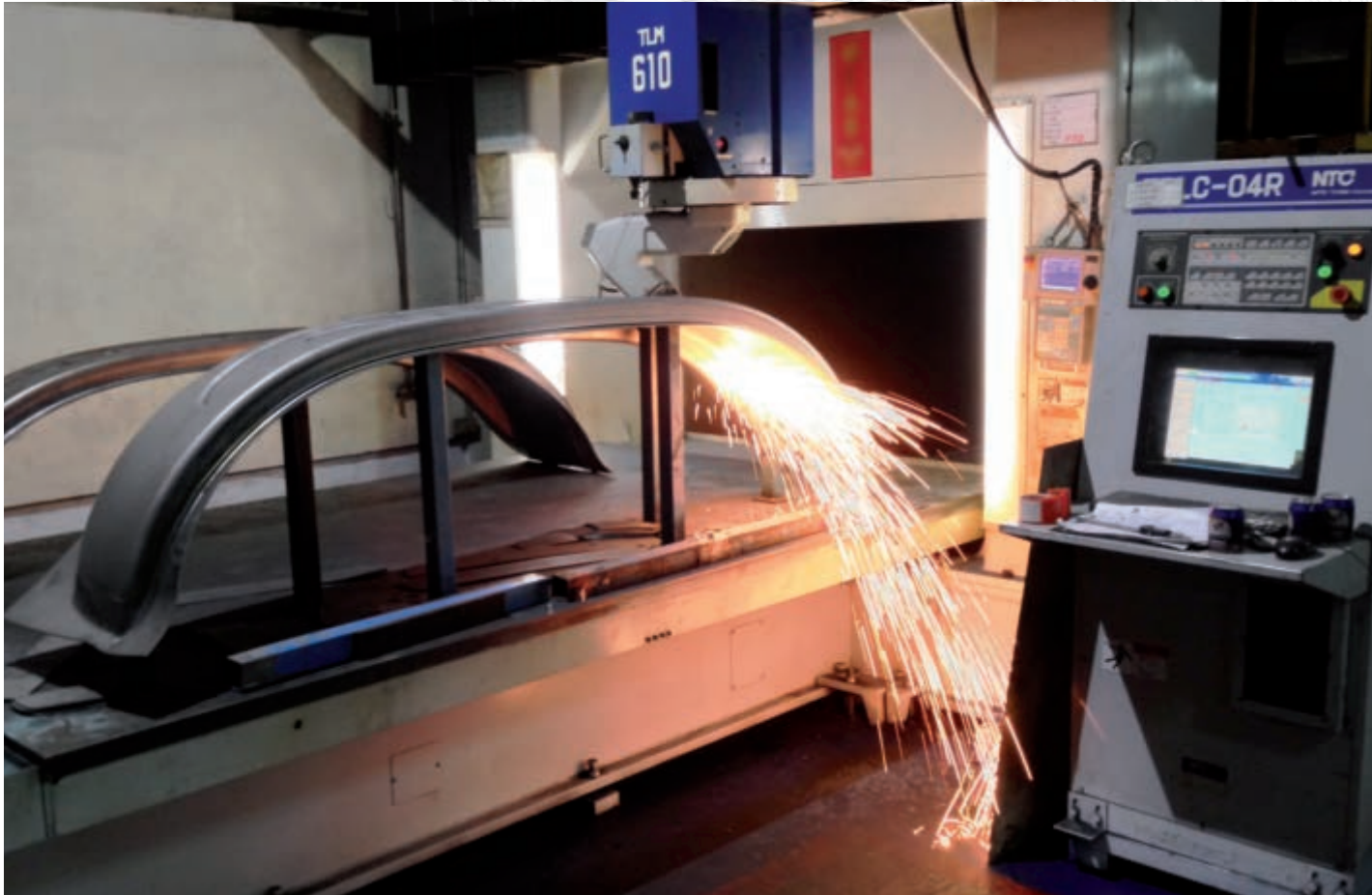

IT Robot di foratura e taglio laser
EN Drilling robot and laser cutting
DE Laserbohrung und Schneideroboter



applicabile a | suitable to | verwendbar für

101

XF6

XF106 Euro 6

applicabile a | suitable to | verwendbar für:

XF106 Euro 6

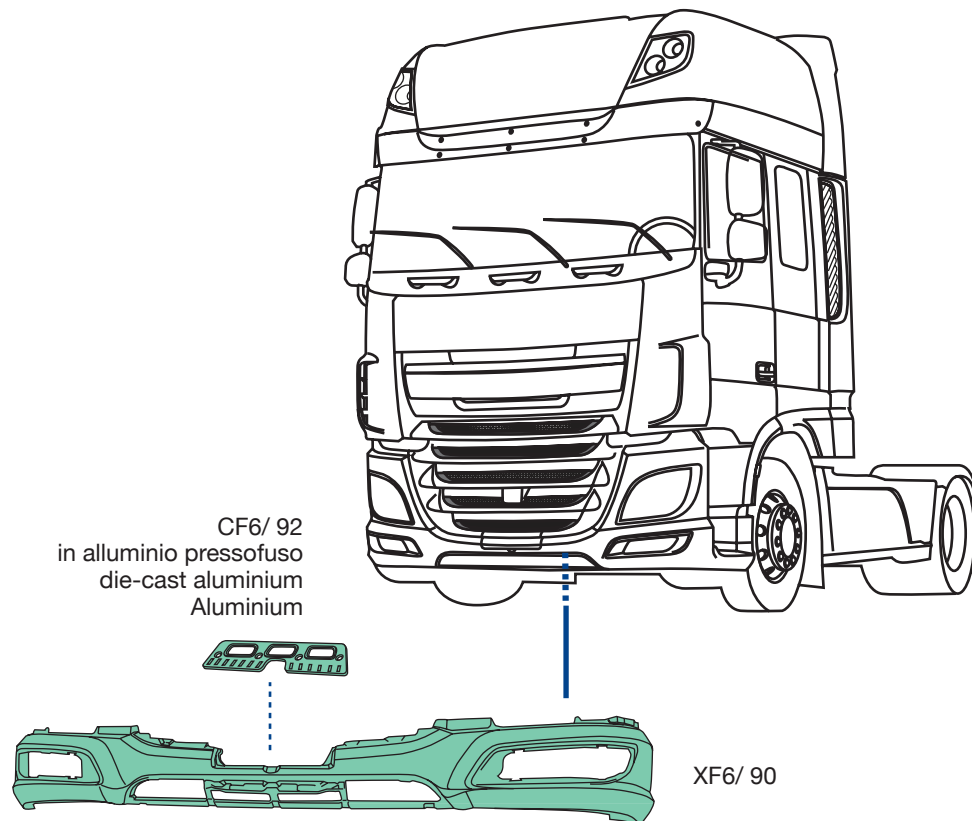

CF6/ 92
O.E.M. 0964275



XF6/ 90
O.E.M. 1953385

XF106 Euro 6

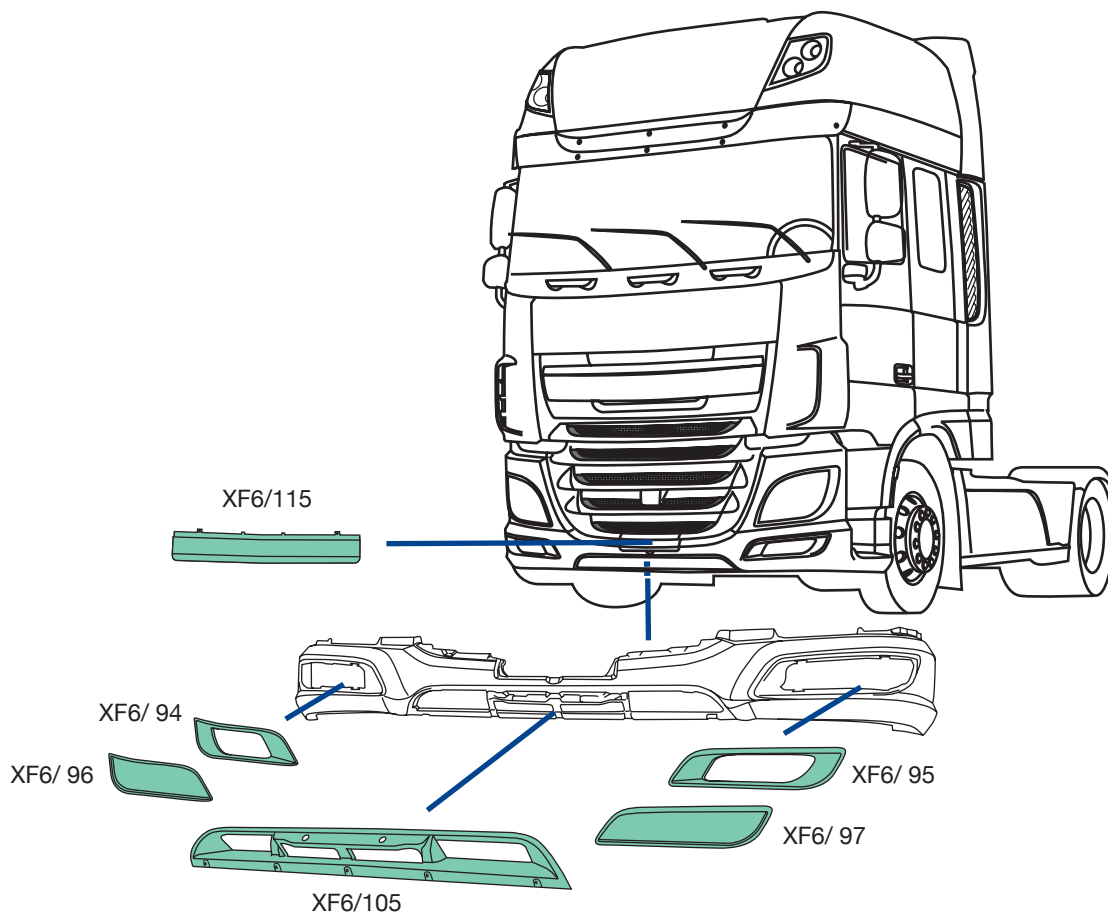

XF6/ 94
O.E.M. 1880379
XF6/ 95
O.E.M. 1880378



XF6/ 96
O.E.M. 1880398
XF6/ 97
O.E.M. 1880397



XF6/105
O.E.M. 1826510



XF6/115
O.E.M. 1861983

applicabile a I suitable to I verwendbar für:

XF106 Euro 6

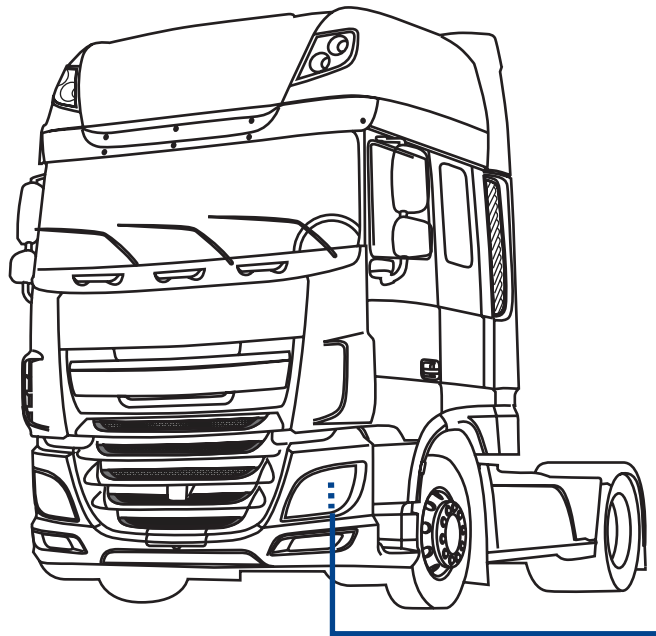

XF6/100 d-rh-rechts
XF6/101 s-lh-links
in alluminio pressofuso
die-cast aluminium
Aluminium

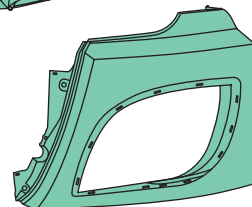
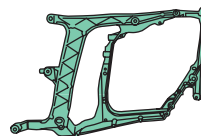

XF6/ 98 d-rh-rechts
XF6/ 99 s-lh-links



XF6/ 88 d-rh-rechts
XF6/ 89 s-lh-links
silver-silver-Silber



XF6/ 88
O.E.M. 1922031
XF6/ 89
O.E.M. 1922030



XF6/ 98
O.E.M. 1861950
XF6/ 99
O.E.M. 1861949



XF6/100
O.E.M. 1798449
XF6/101
O.E.M. 1798448

XF106 Euro 6

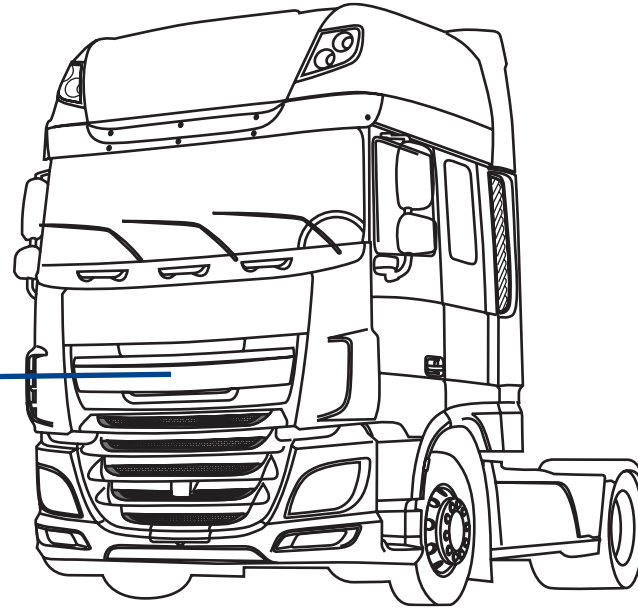
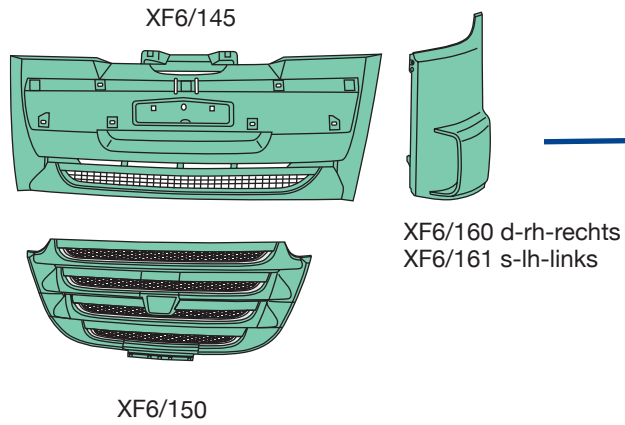

XF6/145
O.E.M. 1936285



XF6/150
O.E.M. 1886591



XF6/160
O.E.M. 1835710
XF6/161
O.E.M. 1835709

applicabile a I suitable to I verwendbar für:

XF106 Euro 6

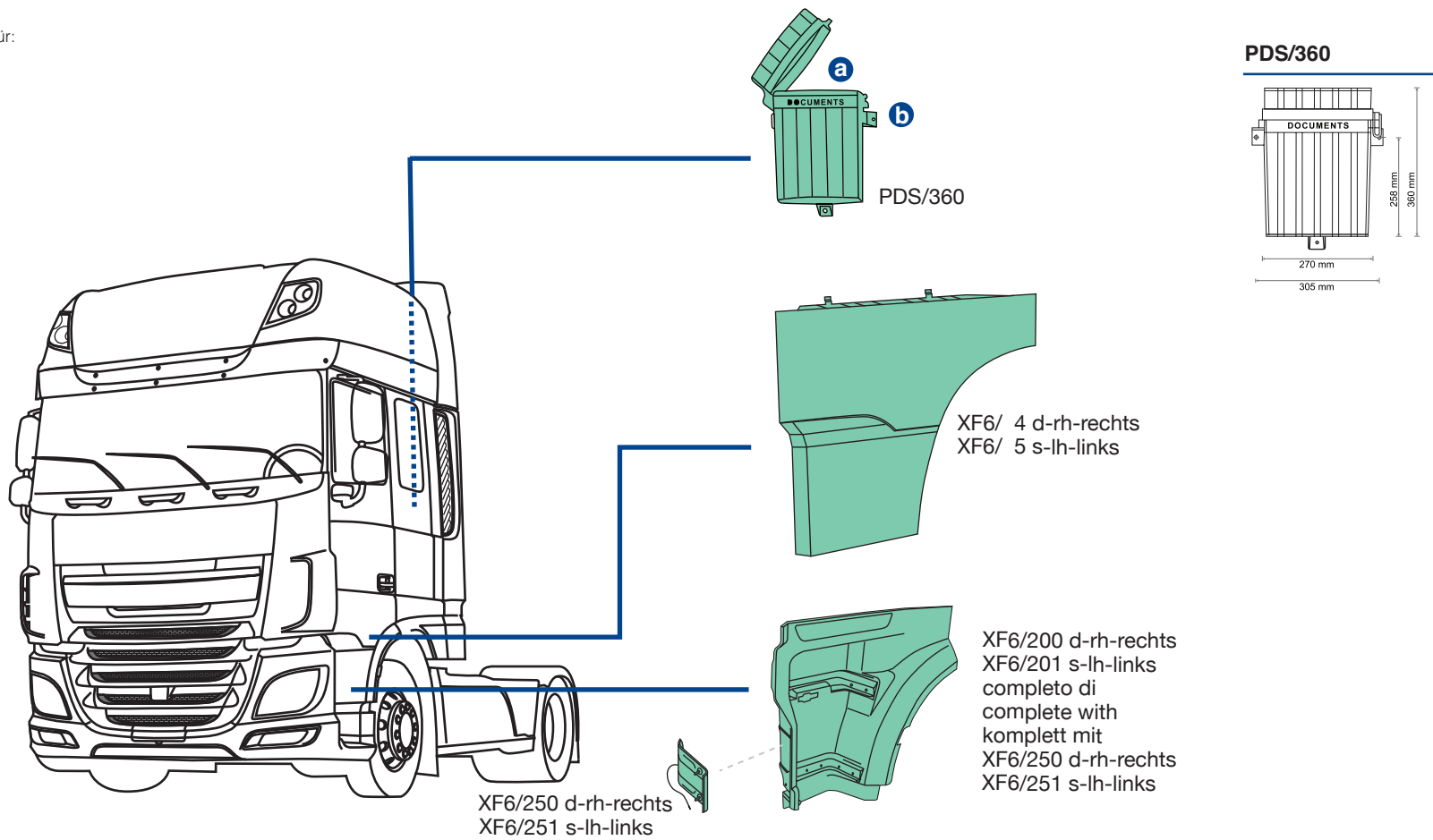

XF6/ 4
O.E.M. 2041670
XF6/ 5
O.E.M. 2041699



XF6/200
O.E.M. 1861673
XF6/201
O.E.M. 1861672



XF6/250
O.E.M. 1835065
XF6/251
O.E.M. 1835064



PDS/360
O.E.M. -

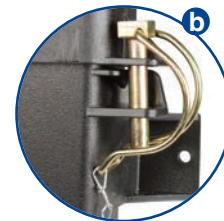

XF106 Euro 6

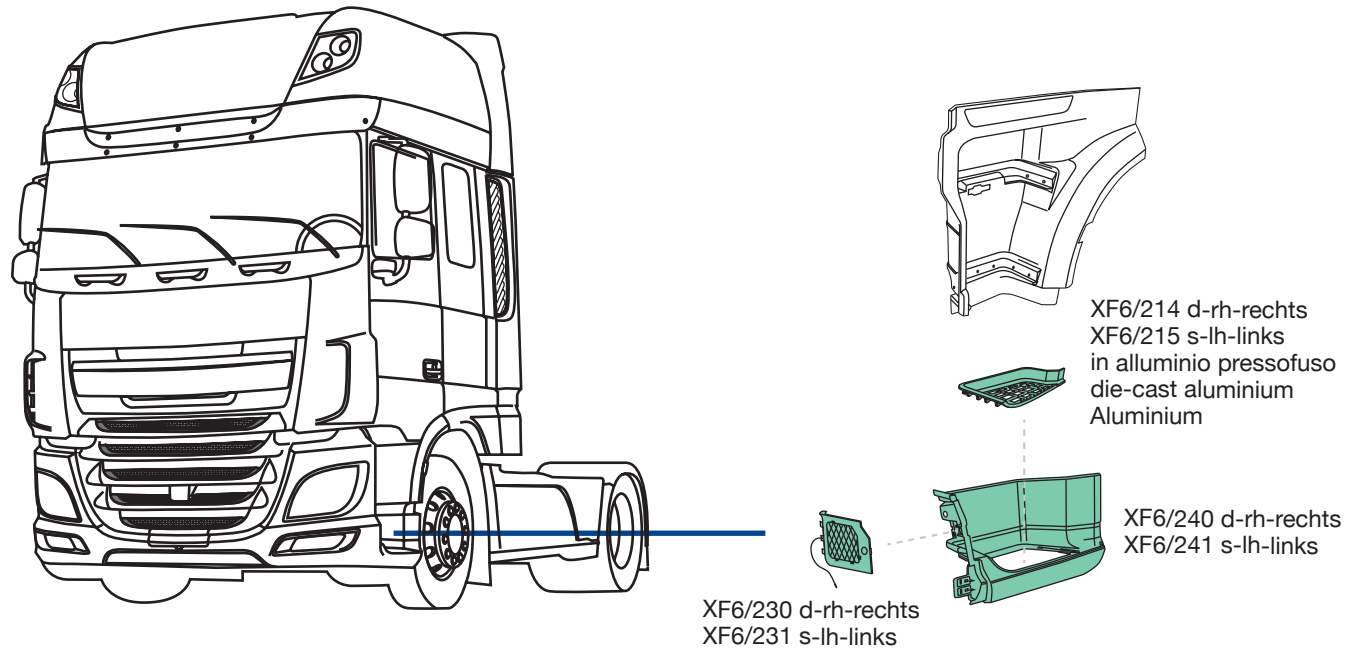

XF6/214
O.E.M. 1945872
XF6/215
O.E.M. 1945871



XF6/230
O.E.M. 1828856
XF6/231
O.E.M. 1828855



XF6/240
O.E.M. 1948244
XF6/241
O.E.M. 1948243

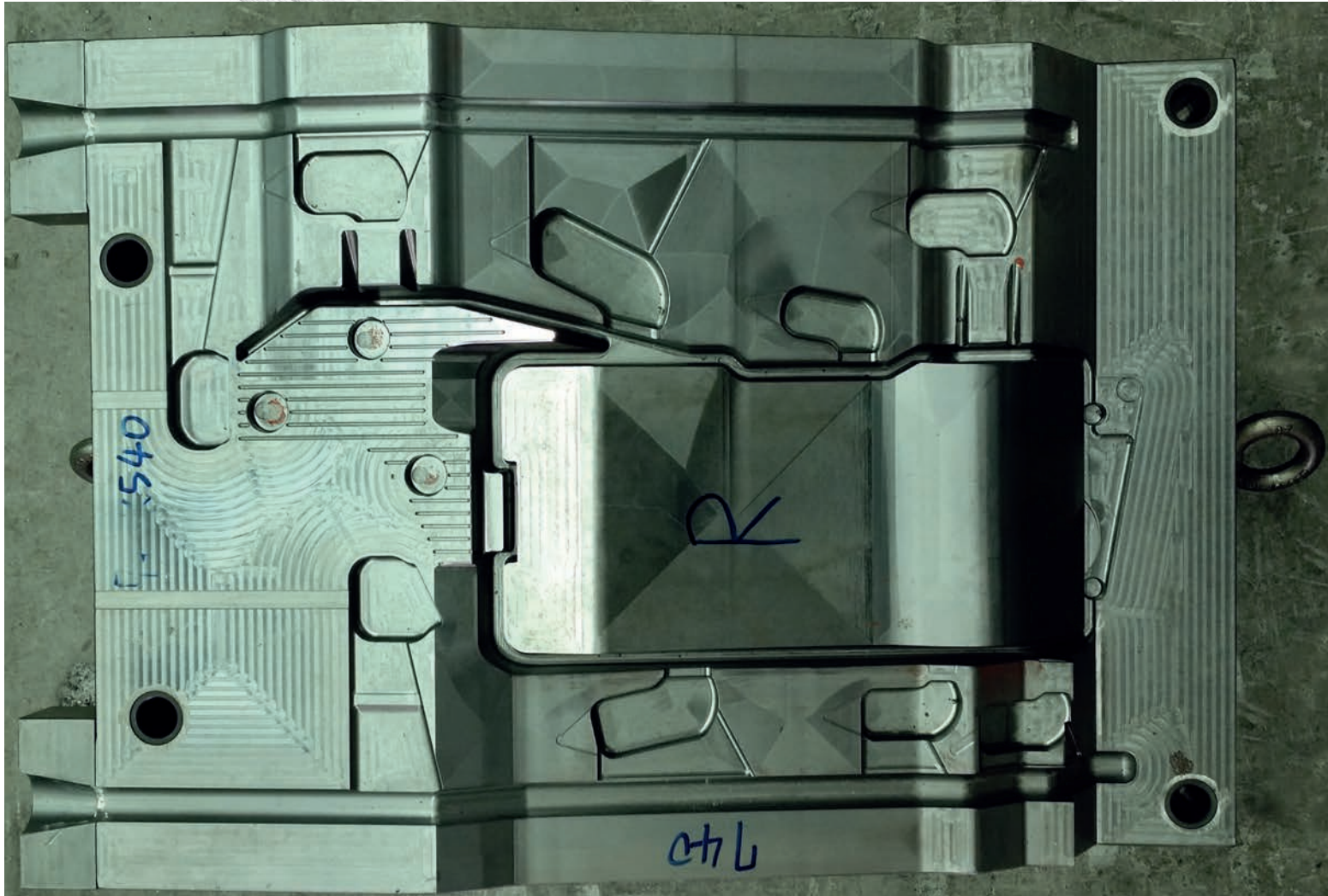

IT Stampo in acciaio a iniezione per la produzione di griglia radiatore Daf LF euro 6
EN Steel injection moulding for the manufacturing of the radiator grill of the DAF LF Euro6
DE Spritzgusswerkzeug aus Stahl für die Herstellung des Kühlergitters des DAF LF Euro6

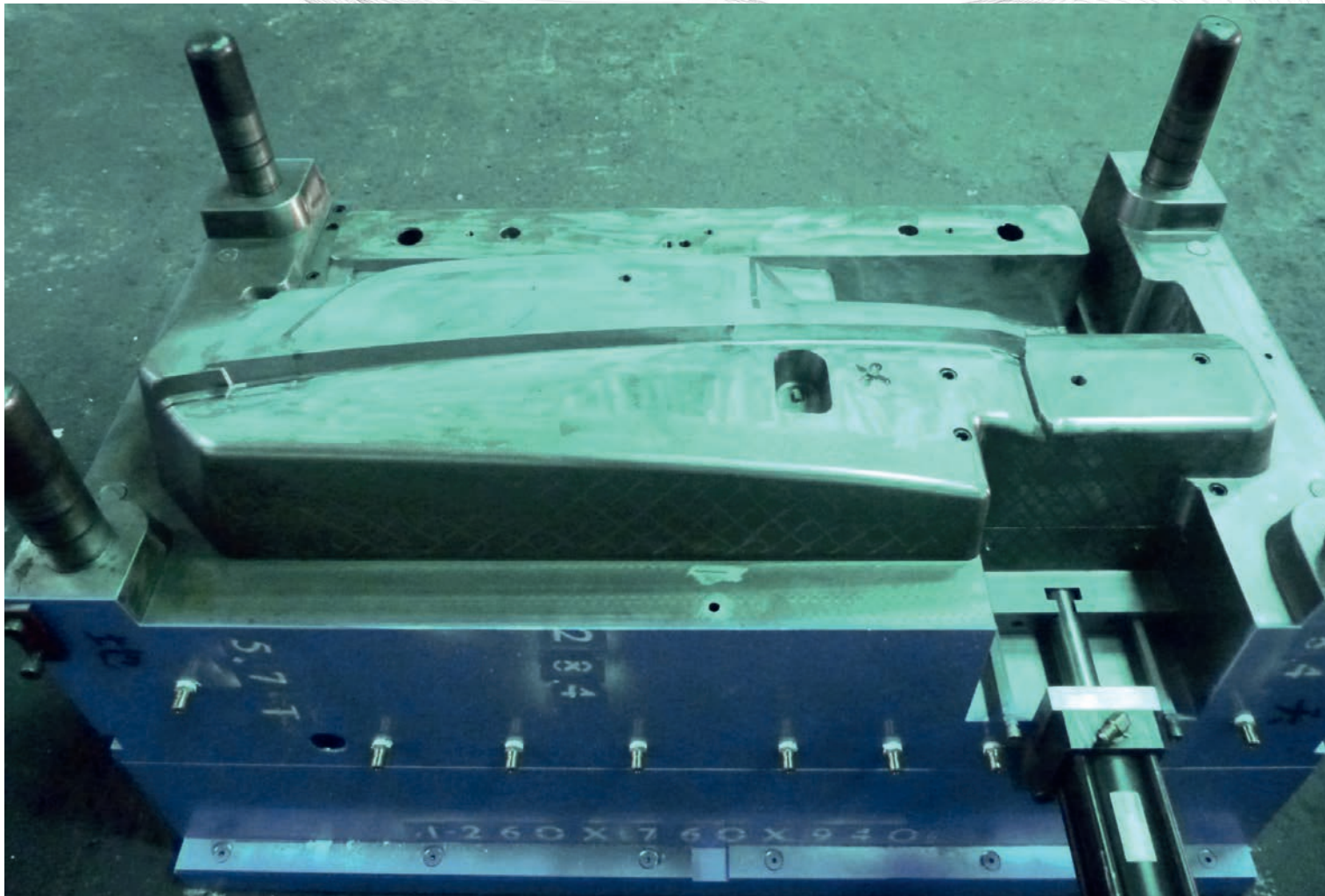

▲
IT Stampo in acciaio a iniezione per la produzione di deviatore aria Daf LF euro 6
EN Steel injection moulding for the manufacturing of the air deflector for the DAF LF Euro6
DE Spritzgusswerkzeug aus Stahl für die Herstellung des Luftabweisers des DAF LF Euro6

XF106 Euro 6

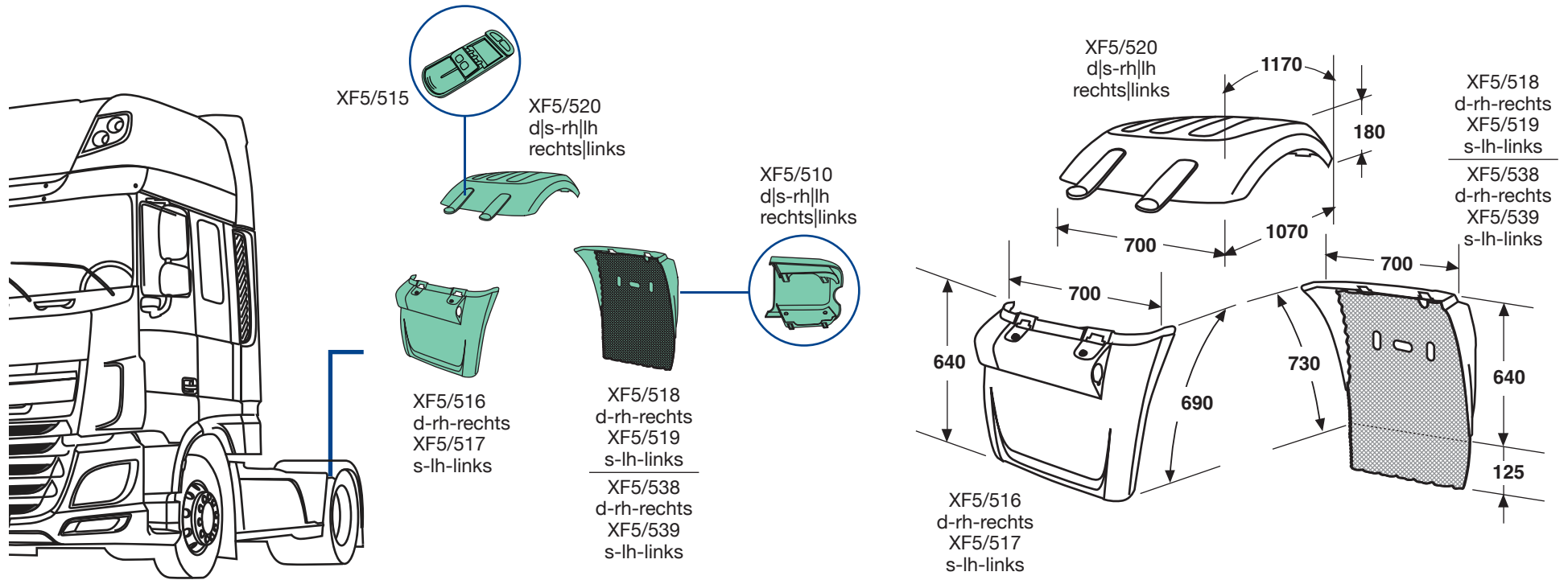

XF5/510
O.E.M. 1875567



XF5/515
O.E.M. 1927847



XF5/520
 O.E.M. 1875551
 d|s-rh|lh-rechts|links
 nero, semipiatta, con cinghietti
 black, semi-flat, with stretchers
 schwarz, halbflach, mit Spanngummi

XF5/518
 O.E.M. 1875554
 d-rh-rechts
 nero, con anti-spray, con staffe
 black, with anti-spray, with brackets
 schwarz, mit Spritzschutz, mit Klemme

XF5/538
 O.E.M. -
 d-rh-rechts
 nero, senza anti-spray, con staffe
 black, without anti-spray, with brackets
 schwarz, ohne Spritzschutz, mit Klemme



XF5/520



XF5/517
 O.E.M. 1875549
 s-lh-links
 nero, con staffe
 black, with brackets
 schwarz, mit Klemme

XF5/519
 O.E.M. 1875553
 s-lh-links
 nero, con anti-spray, con staffe
 black, with anti-spray, with brackets
 schwarz, mit Spritzschutz, mit Klemme

XF5/539
 O.E.M. -
 s-lh-links
 nero, senza anti-spray, con staffe
 black, without anti-spray, with brackets
 schwarz, ohne Spritzschutz, mit Klemme



XF5/516
 O.E.M. 1875550
 d-rh-rechts
 nero, con staffe
 black, with brackets
 schwarz, mit Klemme

XF106 Euro 6

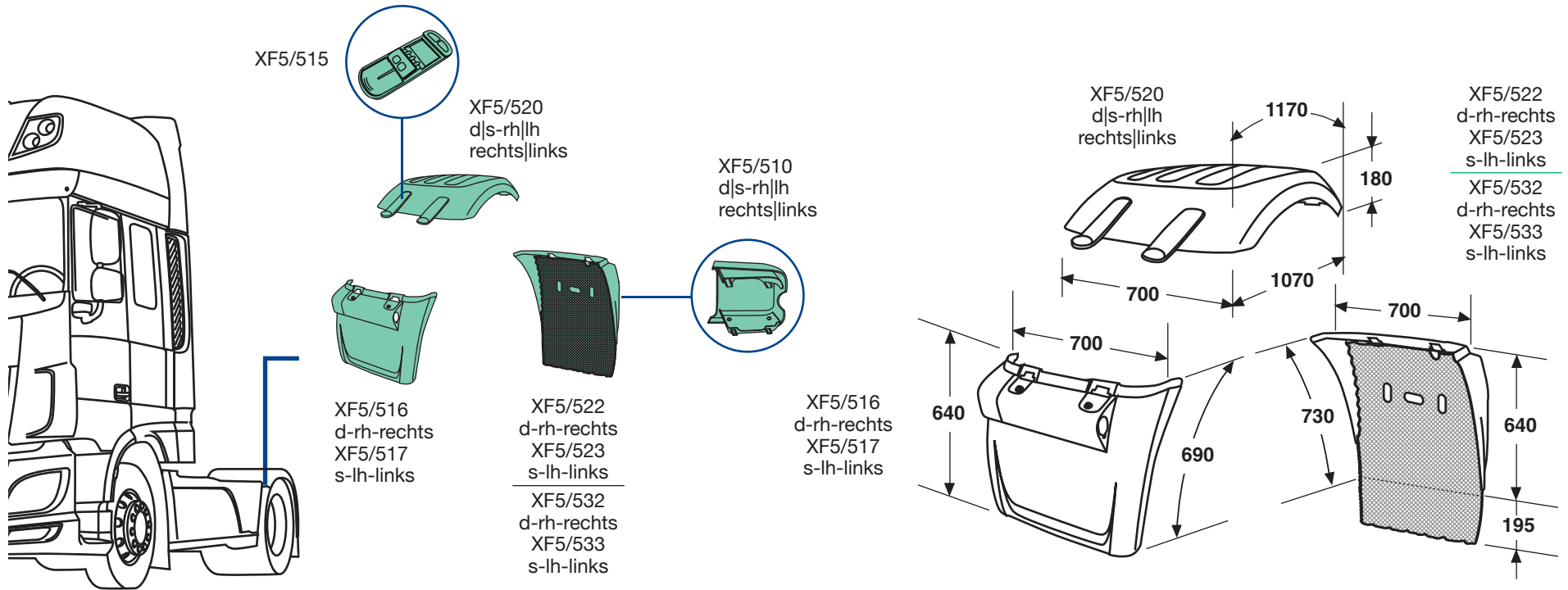

XF5/510
O.E.M. 1875567



XF5/515
O.E.M. 1927847

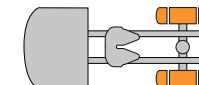

XF5/520
O.E.M. 1875551
d|s-rh|lh-rechts|links
nero, semipiatta, con cinghietti
black, semi-flat, with stretchers
schwarz, halbflach, mit Spanngummi

XF5/522
O.E.M. 1892198
d-rh-rechts
nero, con anti-spray, con staffe
black, with anti-spray, with brackets
schwarz, mit Spritzschutz, mit Klemme

XF5/532
O.E.M. -
d-rh-rechts
nero, senza anti-spray, con staffe
black, without anti-spray, with brackets
schwarz, ohne Spritzschutz, mit Klemme



vista esterna - external view - Außenansicht

XF5/520



XF5/517
O.E.M. 1875549
s-lh-links
nero, con staffe
black, with brackets
schwarz, mit Klemme

XF5/523
O.E.M. 1892197
s-lh-links
nero, con anti-spray, con staffe
black, with anti-spray, with brackets
schwarz, mit Spritzschutz, mit Klemme

XF5/533
O.E.M. -
s-lh-links
nero, senza anti-spray, con staffe
black, without anti-spray, with brackets
schwarz, ohne Spritzschutz, mit Klemme



XF5/516
O.E.M. 1875550
d-rh-rechts
nero, con staffe
black, with brackets
schwarz, mit Klemme

XF106 Euro 6

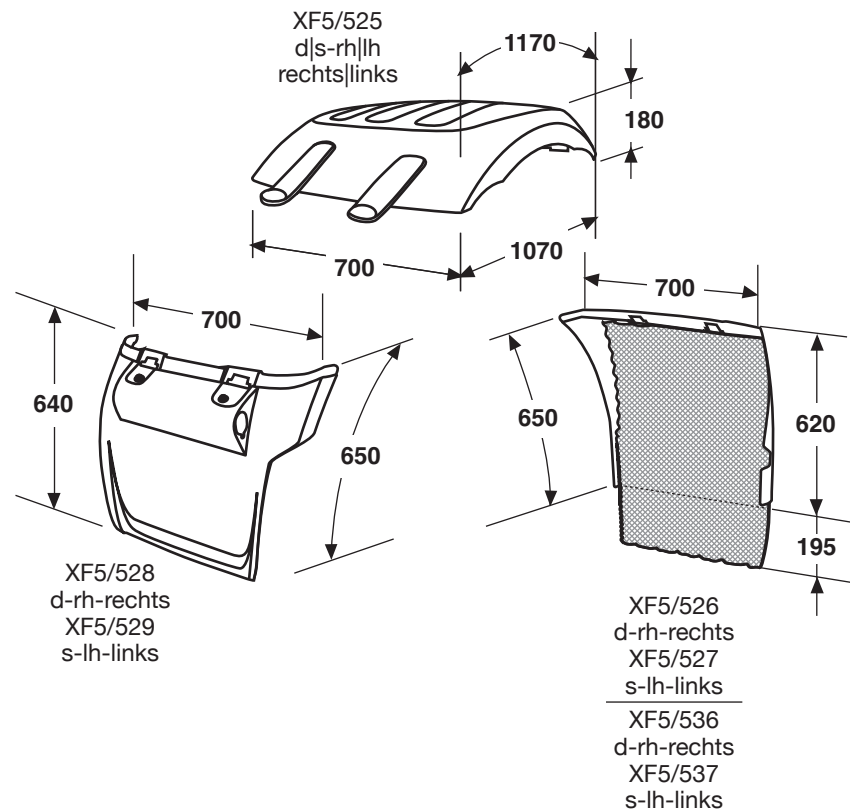
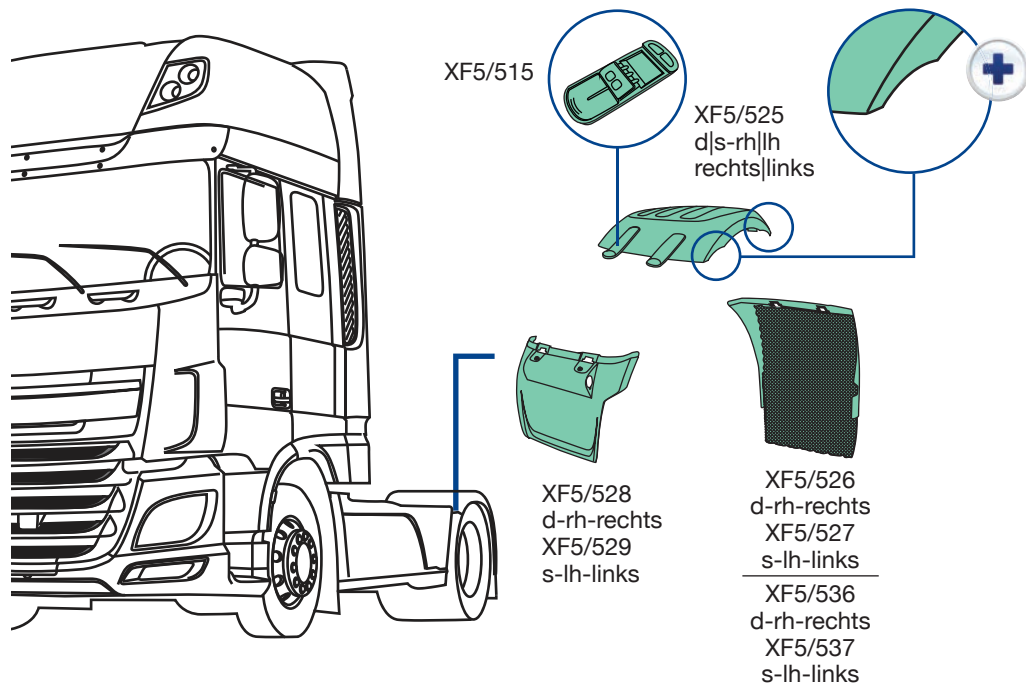

XF5/515
O.E.M. 1927847

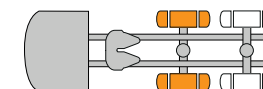

XF5/525
O.E.M. 1875552
d|s-rh||h-rechts|links
nero, semipiatta, con cinghietti
black, semi-flat, with stretchers
schwarz, halbflach, mit Spanngummi

XF5/526
O.E.M. 1892248
d-rh-rechts
nero, con anti-spray, con staffe
black, with anti-spray, with brackets
schwarz, mit Spritzschutz, mit Klemme

XF5/536
O.E.M. -
d-rh-rechts
nero, senza anti-spray, con staffe
black, without anti-spray, with brackets
schwarz, ohne Spritzschutz, mit Klemme



XF5/525



XF5/529
O.E.M. 1892245
s-lh-links
nero, con staffe
black, with brackets
schwarz, mit Klemme

XF5/527
O.E.M. 1892247
s-lh-links
nero, con anti-spray, con staffe
black, with anti-spray, with brackets
schwarz, mit Spritzschutz, mit Klemme

XF5/537
O.E.M. -
s-lh-links
nero, senza anti-spray, con staffe
black, without anti-spray, with brackets
schwarz, ohne Spritzschutz, mit Klemme



XF5/528
O.E.M. 1892246
d-rh-rechts
nero, con staffe
black, with brackets
schwarz, mit Klemme

XF106 Euro 6

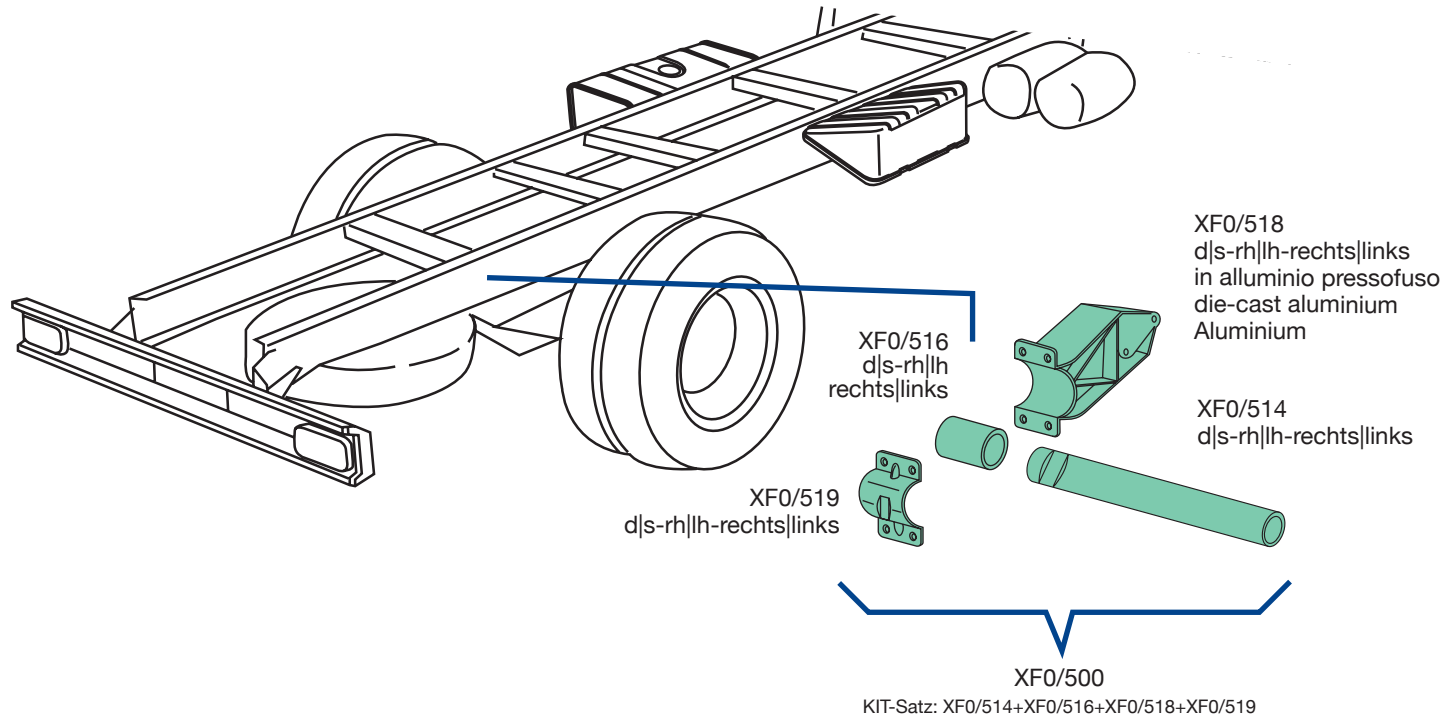

XF0/514
O.E.M. 1610454



XF0/516
O.E.M. 1629045



XF0/518
O.E.M. 2050044



XF0/519
O.E.M. 1629046

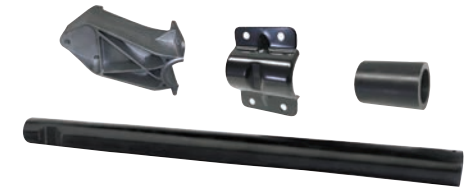

XF0/500
O.E.M. 1371224

XF106 Euro 6

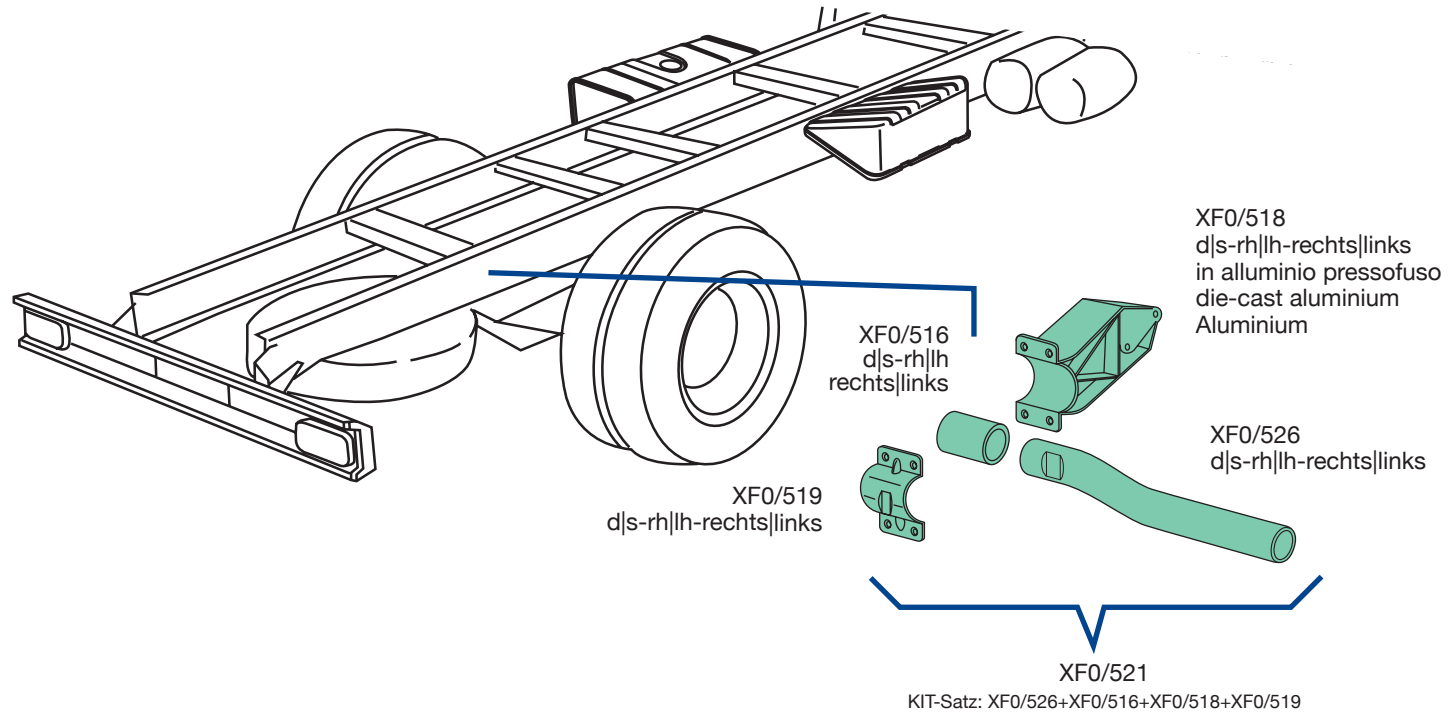

XF0/516
O.E.M. 1629045



XF0/518
O.E.M. 2050044



XF0/519
O.E.M. 1629046



XF0/526
O.E.M. 1629036



XF0/521
O.E.M. 1371226

applicabile a | suitable to | verwendbar für:

XF106 Euro 6

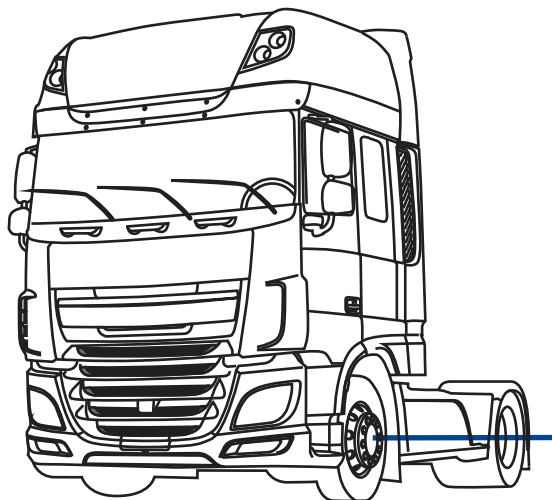

930/032



930/001
d-rh-rechts
930/002
s-lh-links



930/200
d|s-rh|lh
rechts|links



930/100
d-rh-rechts
930/101
s-lh-links



930/032
O.E.M. -



930/001
O.E.M. -
930/002
O.E.M. -



930/100
O.E.M. -
930/101
O.E.M. -

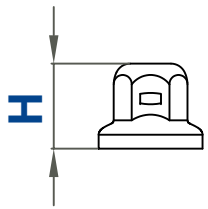

930/200
O.E.M. -

930/032 - Tappo copri bullone-Bolt cover-Radmutterkappe

H	45 mm
Per bulloni \varnothing -bolt \varnothing -Bolzen \varnothing	32 mm
Materiale-Material	acciaio inox-stainless steel Edelstahl
Kg	0,025

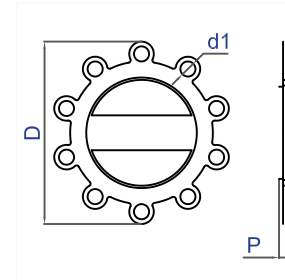
**930/100 d-rh-rechts - 930/101 s-lh-links**

D \varnothing 387 mm	P 30 mm
d1 nr. 10	d1 \varnothing 32 mm
Ventilata	si-yes-Ja
Ventilated-Belüftet	
Colore	cromato e nero-chrome and black
Colours-Farbe	verchromt und schwarz
Materiale-Material	acciaio inox e plastica stainless steel and plastic Edelstahl und Kunststoff
Kg	0,655

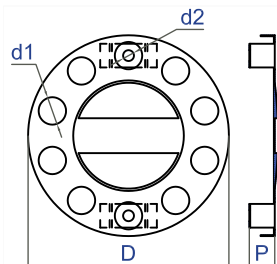
**930/001 d-rh-rechts - 930/002 s-lh-links**

D \varnothing 425 mm	P 50 mm
d1 nr. 10	d1 \varnothing 58 mm
d2 nr. 2	d2 \varnothing 23 mm
Ventilata	si-yes-ja
Ventilated-Belüftet	
Colore	cromato e nero-chrome and black
Colours-Farbe	verchromt und schwarz
Materiale-Material	acciaio inox e plastica stainless steel and plastic Edelstahl und Kunststoff
Kg	1,230

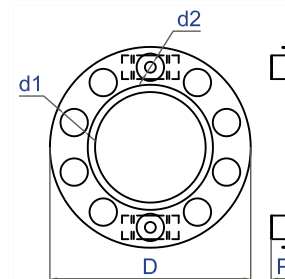
**930/200 d|s-rh|lh-rechts|links**

D \varnothing 425 mm	P 40 mm
d1 nr. 10	d1 \varnothing 58 mm
d2 nr. 2	d2 \varnothing 23 mm
Ventilata	no-nein
Ventilated-Belüftet	
Colore	cromato-chrome-verchromt
Colours-Farbe	
Materiale-Material	acciaio inox-stainless steel Edelstahl
Kg	1,155

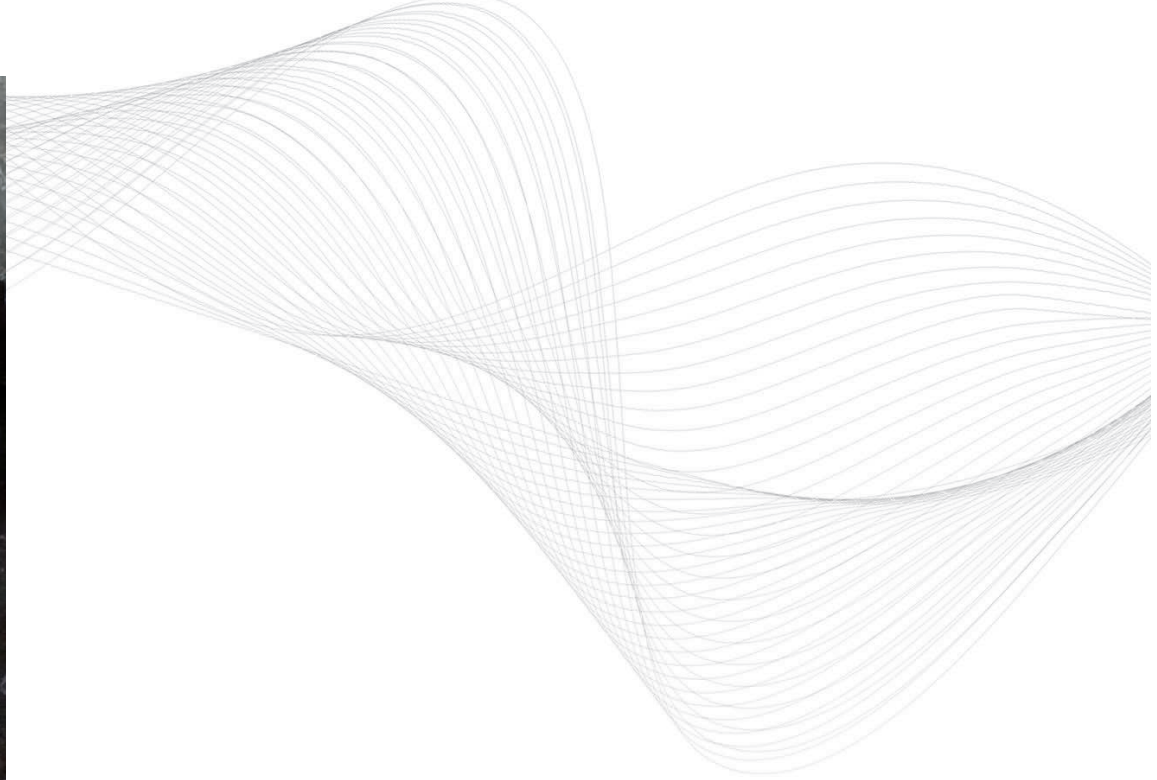
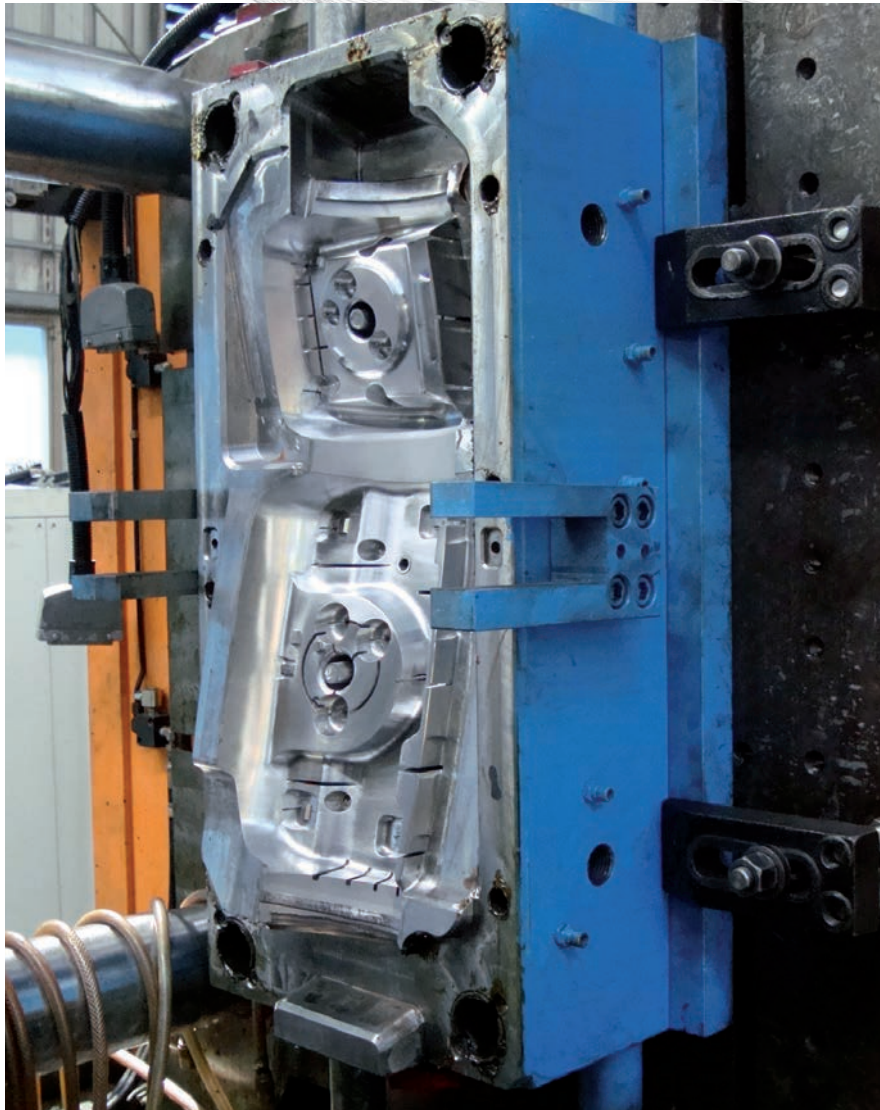

IT Stampo per la produzione di uno specchio retrovisore
EN Mould for the production of the rear mirror
DE Stahlform für die Produktion eines Rückspiegels



applicabile a | suitable to | verwendbar für

119

XF5
XF105

applicabile a | suitable to | verwendbar für:

XF105

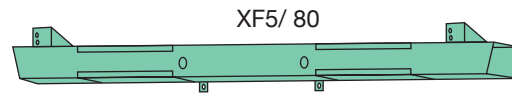
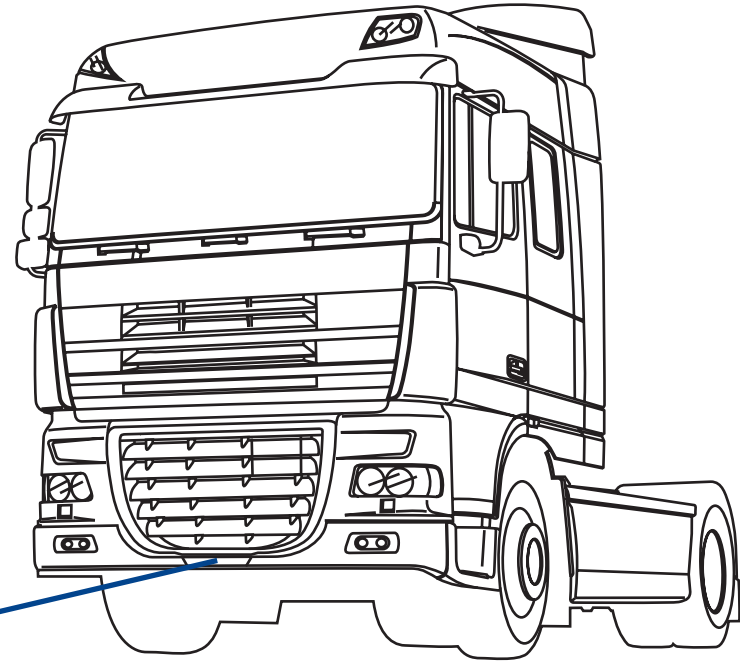

XF5/ 80

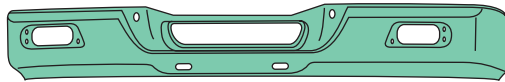

XF5/ 95



XF5/ 80
O.E.M. 1674548



XF5/ 95
O.E.M. 1825008

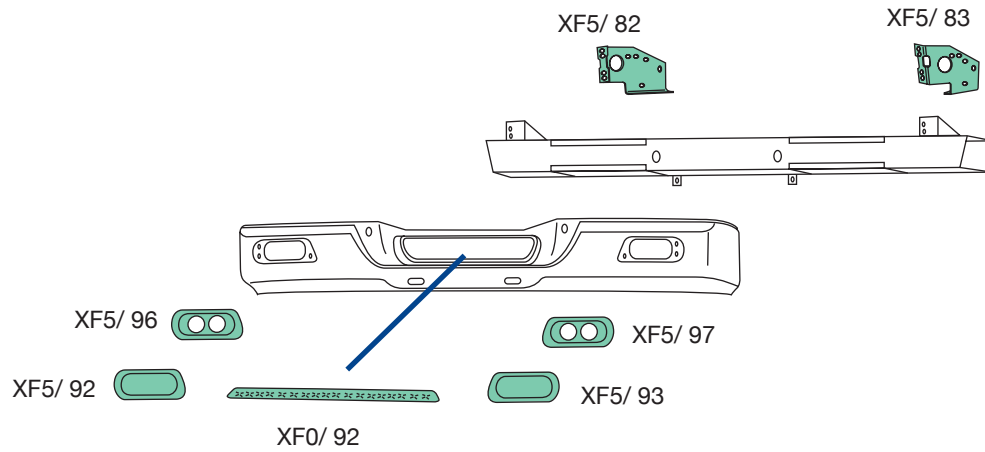

XF0/92
O.E.M. 0948779



XF5/82
O.E.M. 1693665
XF5/83
O.E.M. 1693664



XF5/92
O.E.M. 1695110
XF5/93
O.E.M. 1695109



XF5/96
O.E.M. 1973360
XF5/97
O.E.M. 1973359

applicabile a | suitable to | verwendbar für:

XF105

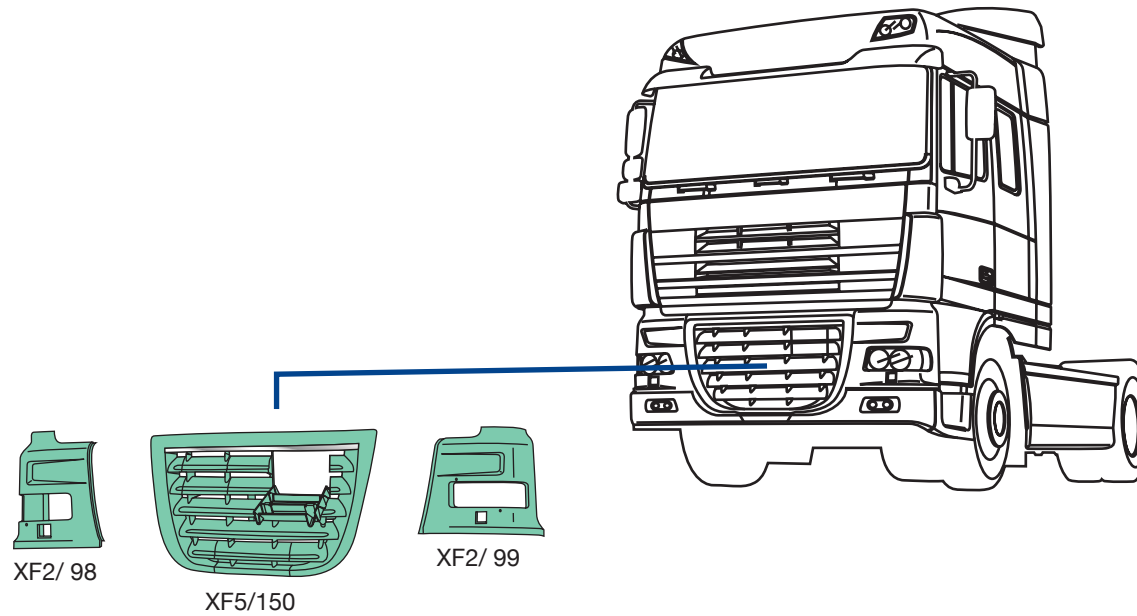

XF2/ 98

XF5/150

XF2/ 99



XF2/ 98
O.E.M. 1398285
XF2/ 99
O.E.M. 1398284



XF5/150
O.E.M. 1954514

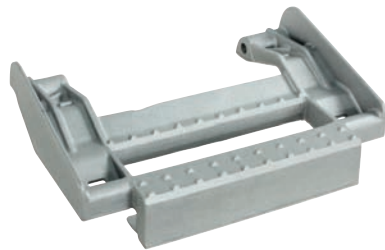
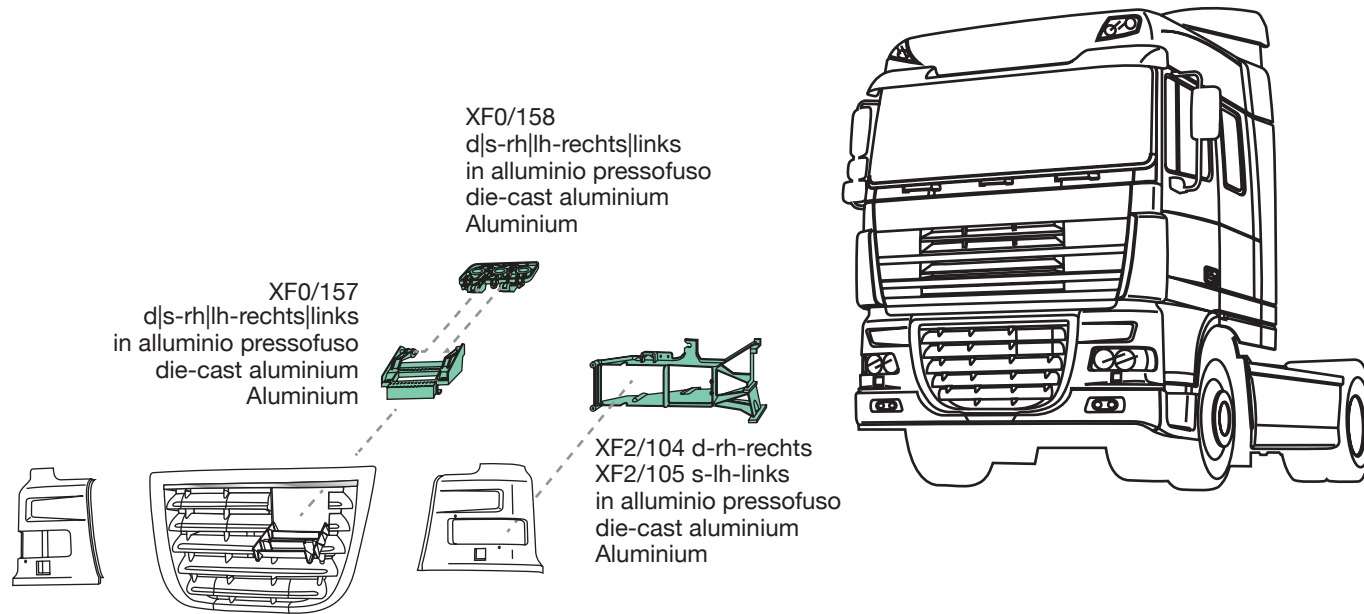

XF0/157
O.E.M. 1689404



XF0/158
O.E.M. 1735004



XF2/104
O.E.M. 1862946
XF2/105
O.E.M. 1862945

XF105

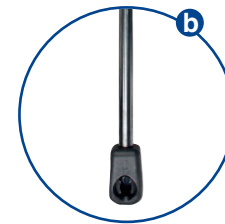
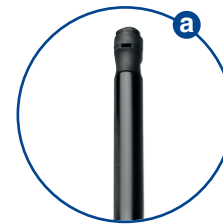
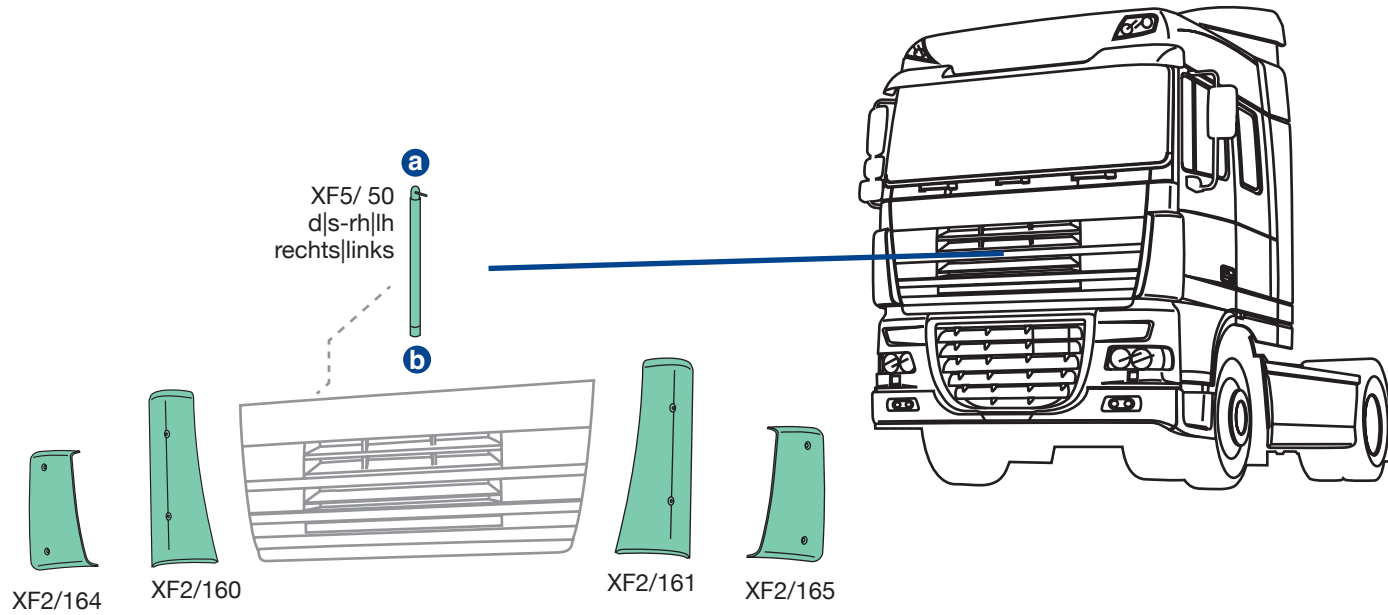



XF0/400

O.E. 1286384

Adattabile a:
Suitable to:
passend für:

DAF 95XF - XF95 - XF105
tetto alto - high roof
hohes Dach

Materiale - Material - Material:
PMMA - Acrylglas

KIT completo di staffe e minuterie
IN ALLESTIMENTO
KIT complete of brackets and findings
NOT AVAILABLE YET
Befestigungssatz
IN ARBEIT



L	H	P	kg.
cm.	cm.	cm.	
240	19	21,5	1,870

XFO/405

O.E. 1300557

Adattabile a:
Suitable to:
passend für:

DAF 95XF - XF95
XF105 space cab
tetto medio - medium roof
mittelhohes Dach

Materiale - Material - Material:
PMMA - Acrylglas



XFO/480

O.E. 1311766

KIT completo
di staffe
e minuterie.
Assembly KIT.
Befestigungssatz



L	H	P	kg.
cm.	cm.	cm.	
236	25	20	3,600



L'immagine del prodotto è da considerarsi puramente indicativa | The product image is just for information | Die Produktbilder sind nur zur Information.



XF0/425

O.E. 1651597

Adattabile a:

Suitable to:

passend für:

**DAF 95XF - XF95
XF105 super space cab**

Materiale - Material - Material:

PMMA - Acrylglas

KIT completo di staffe e minuterie
IN ALLESTIMENTO
KIT complete of brackets and findings
NOT AVAILABLE YET
Befestigungssatz
IN ARBEIT



L	H	P	kg.
cm.	cm.	cm.	
252	35	19,5	2,305

applicabile a I suitable to I verwendbar für:

XF105



XF5/500

II (E4) 024094
177x363 mm

IV (E4) 024095
207x161 mm

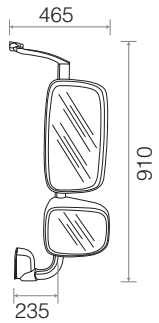

applicabilità:
applicable to:
Verwendbar für



DAF XF95 07/2009 →
DAF XF105 → 2011

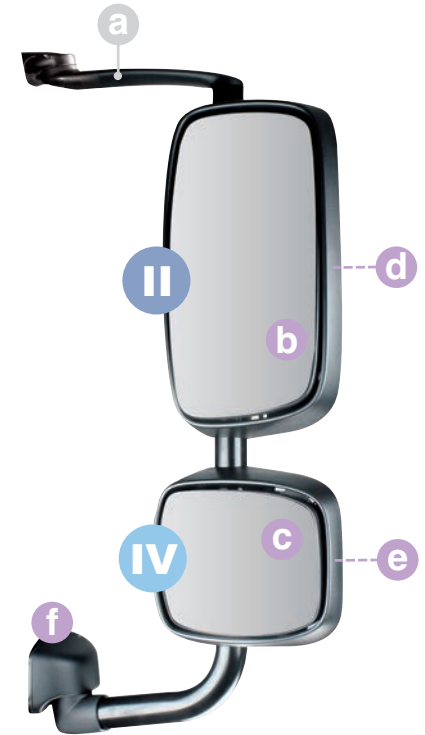

COVID

XF5/509

II

1812862
(1689348)



224x412 mm

XF5/507

IV

1817860
(1689347)



242x222 mm

a

b

XF5/502

1685330

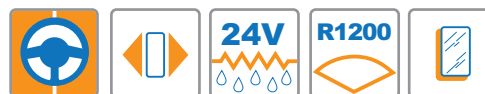

E4 024094

177x363 mm

II

c

XF5/503

1685331



E4 024095

207x161 mm

IV

d

XF5/506

1644325
(1659248)



223x410 mm

II

e

XF5/505

1644326
(1659249)



242x218 mm

IV

f

XF5/512

1644323



applicabile a I suitable to I verwendbar für:

XF105



XF5/501

II (E4) 024094
177x363 mm

IV (E4) 024095
207x161 mm

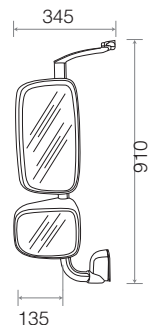

applicabilità:
applicable to:
verwendbar für



DAF XF95 07/2009→
DAF XF105→2011

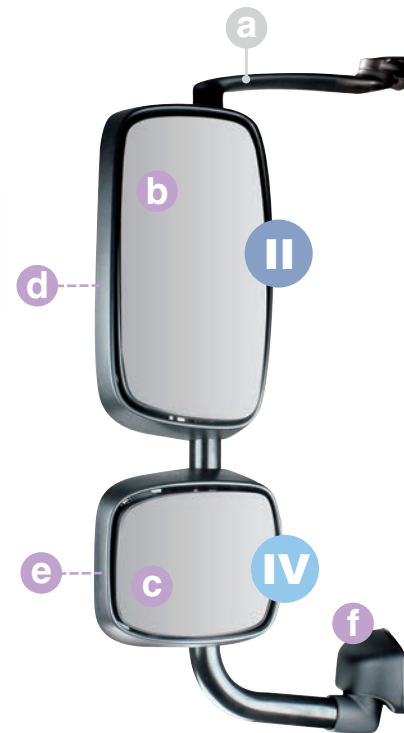

COVIND

XF5/509

II

1812862
(1689348)



224x412 mm

XF5/507

IV

1817860
(1689347)



242x222 mm

a	-	-			E4 024094	177x363 mm
b	XF5/502	1685330	II			
c	XF5/503	1685331			E4 024095	207x161 mm
IV						
d	XF5/506	1644325 (1659248)				223x410 mm
II						
e	XF5/505	1644326 (1659249)				242x218 mm
IV						
f	XF5/513	1644324				

XF105

(*) Vernice di fondo-Unprocessed-Grundiert
(°) Verniciato grigio-Grey painted-Grau lackiert

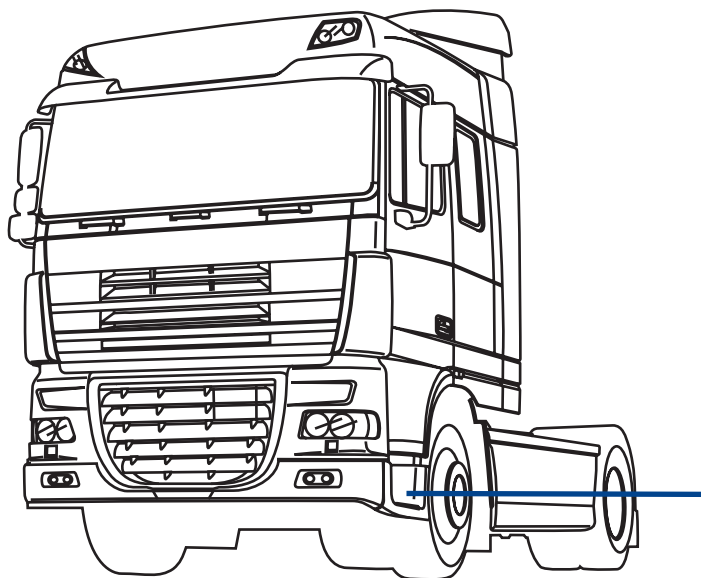

XF5/200 d-rh-rechts (°)
XF5/201 s-lh-links (°)

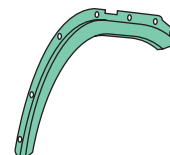
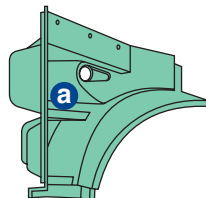

XF0/202 d-rh-rechts
XF0/203 s-lh-links

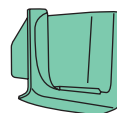

XF5/244 d-rh-rechts (*)
XF5/245 s-lh-links (*)

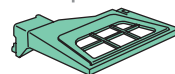

XF5/236 d-rh-rechts
XF5/237 s-lh-links
in alluminio pressofuso
die-cast aluminium
Aluminium



XF0/202
O.E.M. 1291165
XF0/203
O.E.M. 1291164



XF5/200
O.E.M. 1836305
XF5/201
O.E.M. 1836304

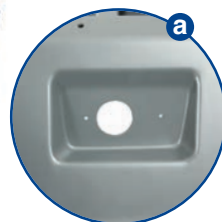

XF5/244
O.E.M. 1642683
XF5/245
O.E.M. 1642682



XF5/236
O.E.M. 1641631
XF5/237
O.E.M. 1641630

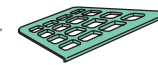
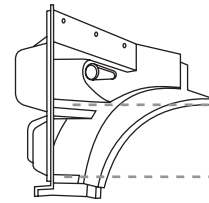
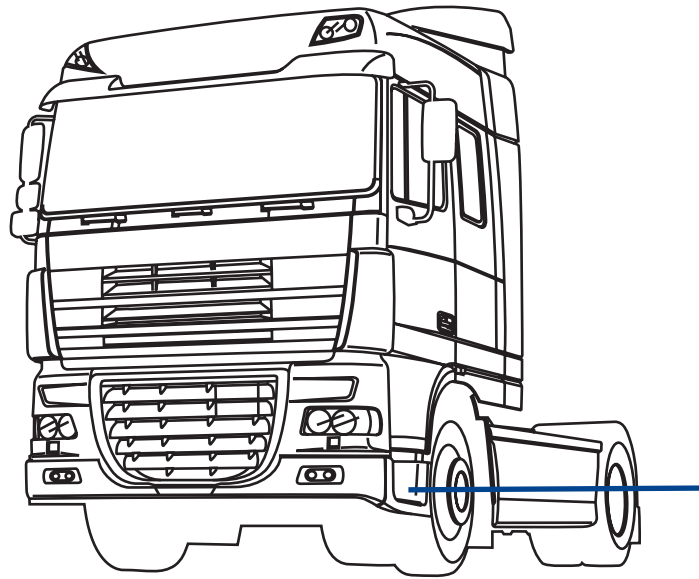

XF0/210
d|s-rh||h-rechts|links

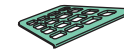

XF0/212
d|s-rh||h-rechts|links

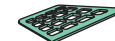
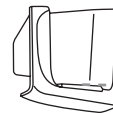

XF0/215
d|s-rh||h-rechts|links

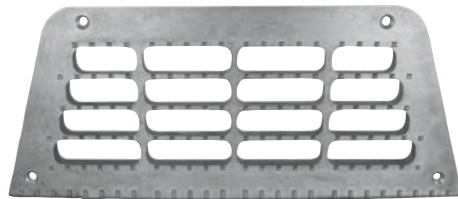

XF0/210
O.E.M. 0673144

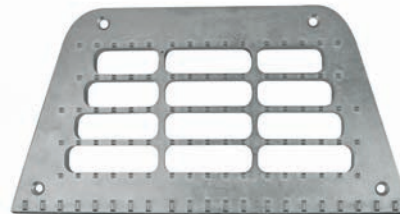

XF0/212
O.E.M. 0673143



XF0/215
O.E.M. 0962643

XF105

(a) Con anti-spray-With anti-spray-mit Spritzschutz

PDS/360

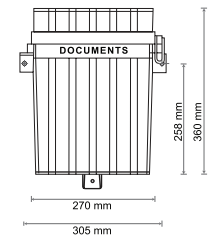
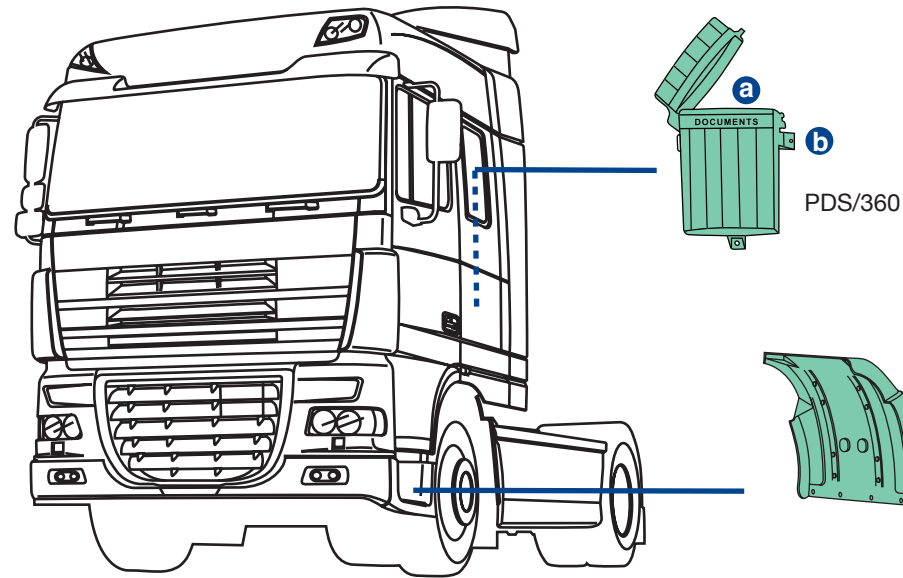

XF0/320 d-rh-rechts
 XF0/321 s-lh-links
 (a) CF0/320 d-rh-rechts
 (a) CF0/321 s-lh-links



XF0/320
 O.E.M. 1997262
XF0/321
 O.E.M. 1997261



CF0/320
 O.E.M. 1997258
CF0/321
 O.E.M. 1997257



PDS/360
 O.E.M. -

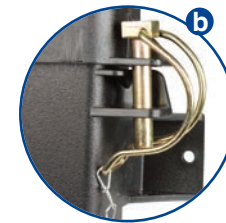

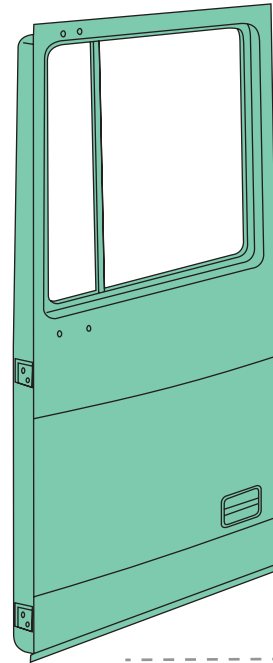

XF0/ 2 d-rh-rechts
XF0/ 3 s-lh-links
senza cerniere
without hinges
ohne Türscharniere

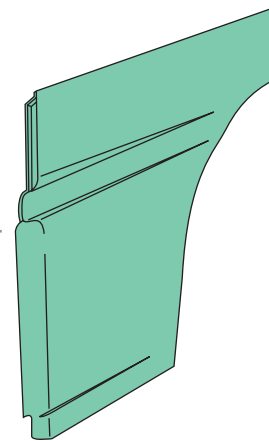

XF0/ 4 d-rh-rechts
XF0/ 5 s-lh-links



XF0/ 2
O.E.M. 1676219
XF0/ 3
O.E.M. 1676218



XF0/ 4
O.E.M. 1295620
XF0/ 5
O.E.M. 1295619

XF105

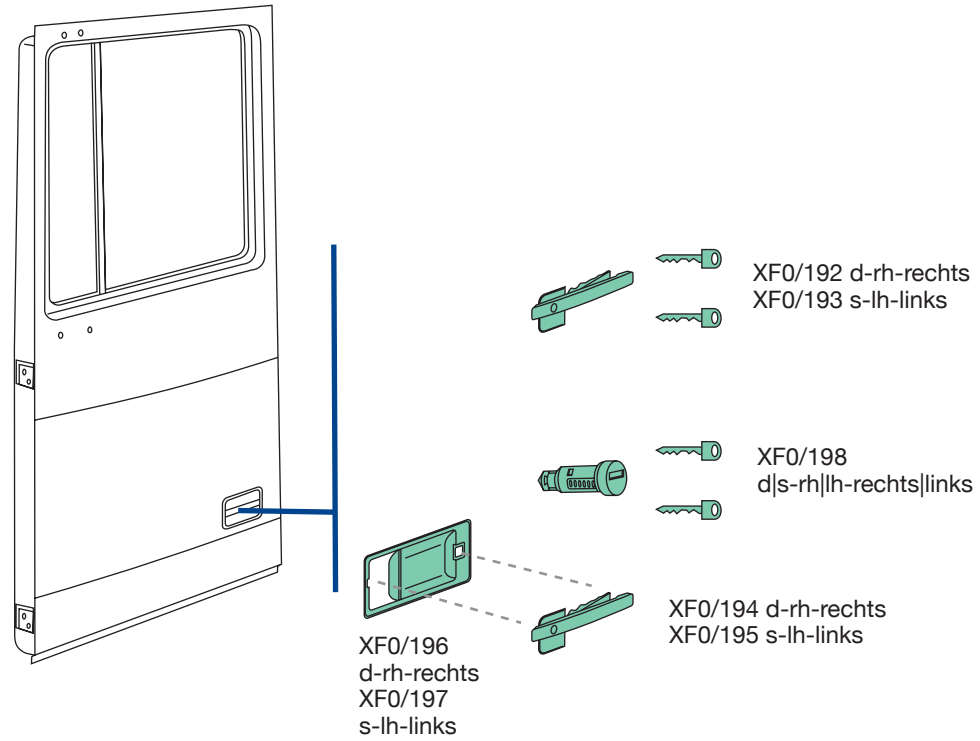

XF0/192
O.E.M. -
XF0/193
O.E.M. -



XF0/194
O.E.M. 1305482
XF0/195
O.E.M. 1305481



XF0/196
O.E.M. 1305480
XF0/197
O.E.M. 1305479



XF0/198
O.E.M. 1336529

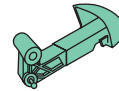
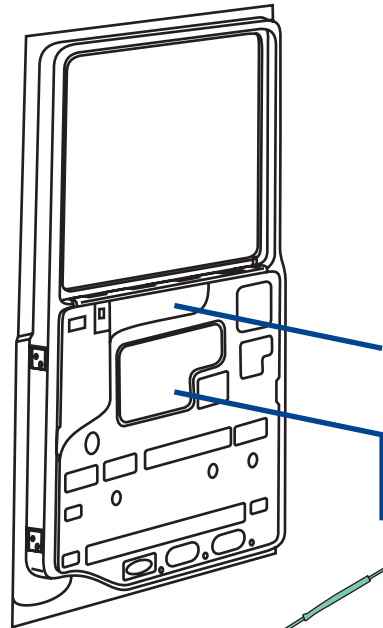

XF0/175 d-rh-rechts
XF0/176 s-lh-links
completa di leva
complete with lever
komplett mit Knauf und Hebel

XF0/164 d-rh-rechts
XF0/165 s-lh-links
elettrico con motorino
electric with motor
elektrisch mit Motor

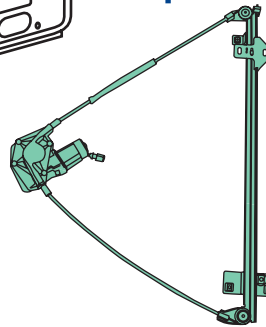

XF0/166 d-rh-rechts
XF0/167 s-lh-links
elettrico con motorino
electric with motor
elektrisch mit Motor

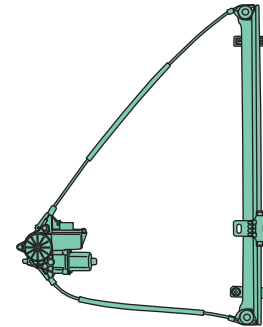

XF0/164
O.E.M. 1354703
XF0/165
O.E.M. 1354702



XF0/166
O.E.M. 1918146
XF0/167
O.E.M. 1918145



XF0/175
O.E.M. 1309408+1354697
XF0/176
O.E.M. 1309407+1354696

applicabile a | suitable to | verwendbar für:

XF105

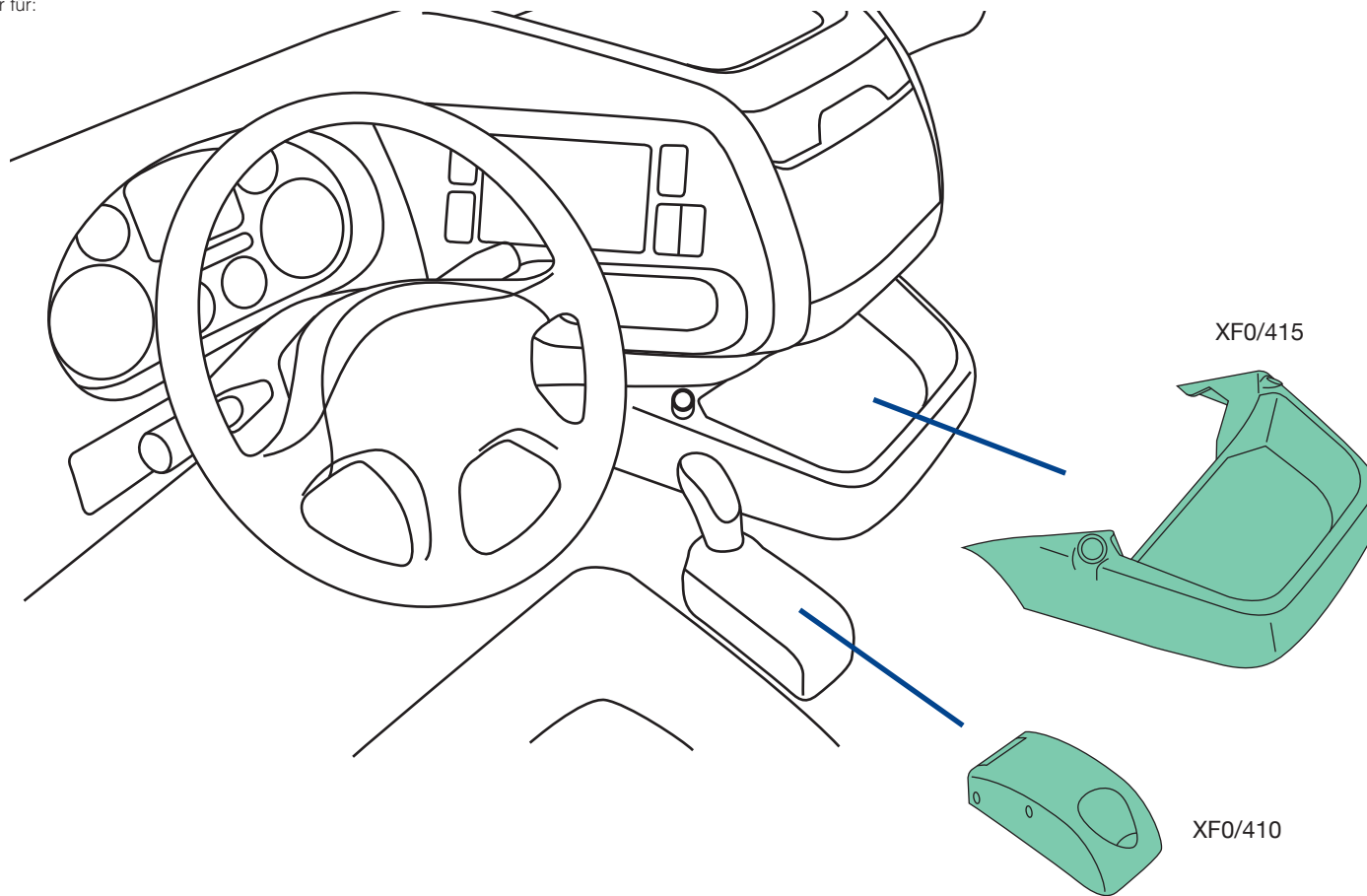

XF0/410
O.E.M. 1642302



XF0/415
O.E.M. 1334620

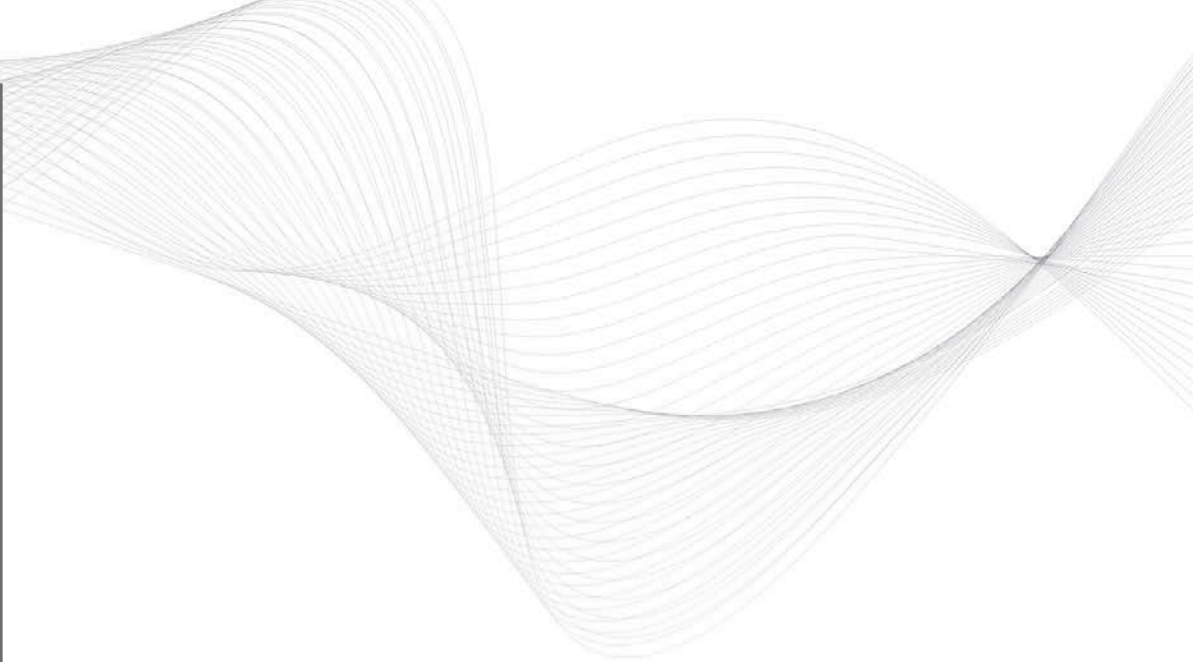

- IT Sagoma in polistirolo per costruzione stampo estensione porta destra
EN EPS profile for the construction of the mould for the right side door extension
DE Polystyrolschlabone für den Formbau der Türverlängerung

XF105

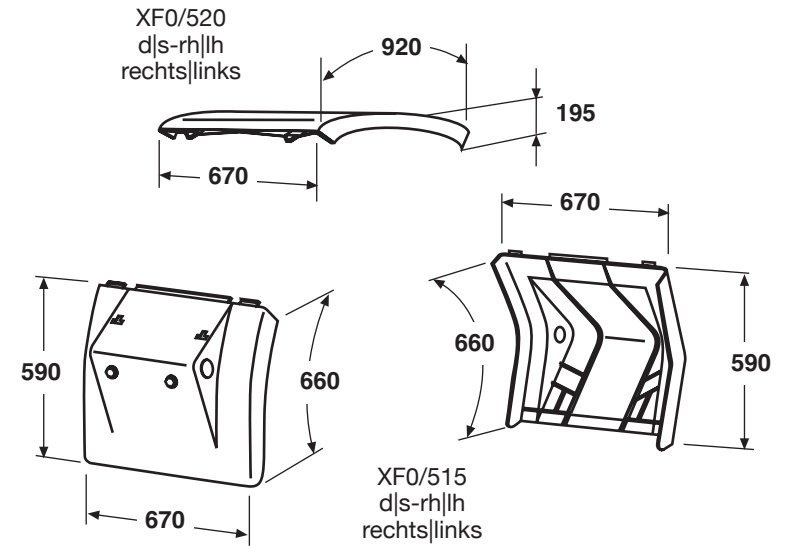
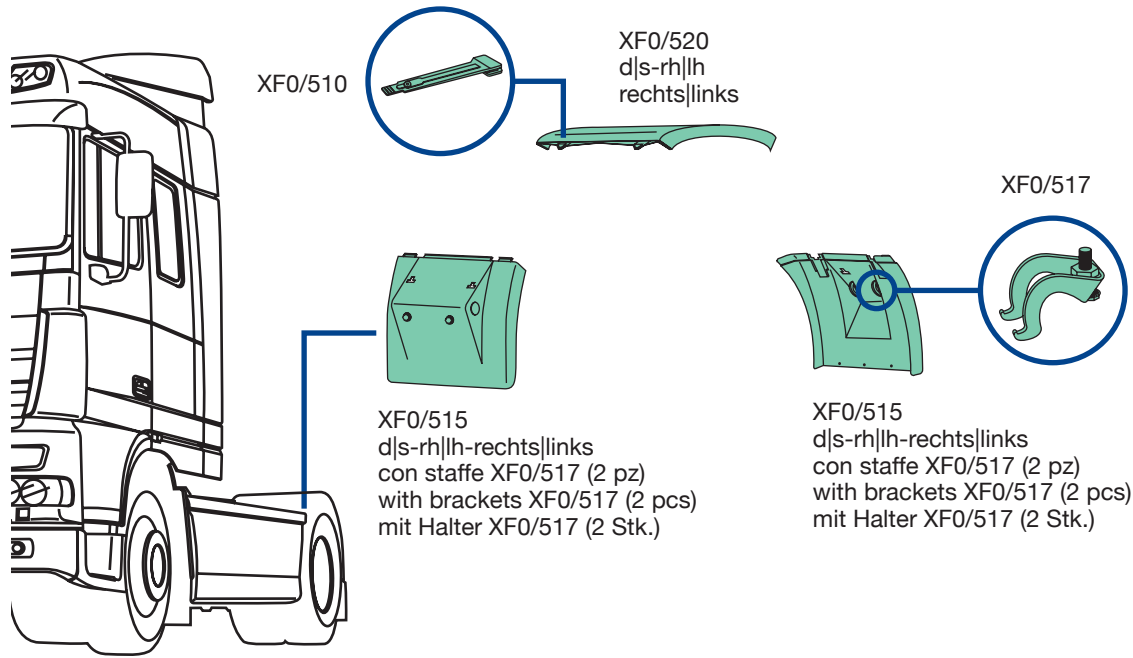

XF0/510
O.E.M. 1340450



XF0/517
O.E.M. 1649588

XF0/520
O.E.M. 1328935
d|s-rh|lh-rechts|links
grigio scuro, semipiatta, con cinghietti
dark grey, semi-flat, with stretchers
dunkelgrau, halbflach, mit Spanngummi



XF105

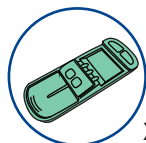

XF5/515

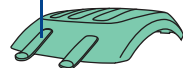

XF5/520
d|s-rh|lh
rechts|links



XF5/516
d-rh-rechts
XF5/517
s-lh-links

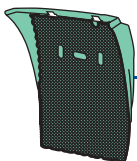

XF5/518
d-rh-rechts
XF5/519
s-lh-links
XF5/538
d-rh-rechts
XF5/539
s-lh-links



XF5/510
d|s-rh|lh
rechts|links

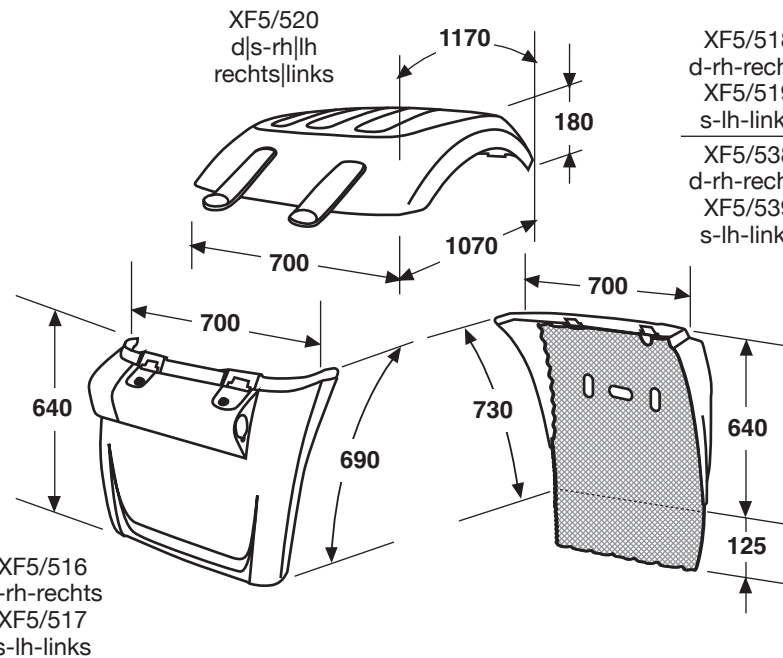

XF5/510
O.E.M. 1875567



XF5/515
O.E.M. 1927847

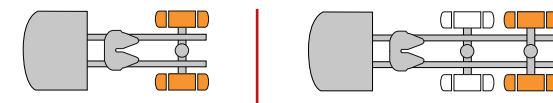

XF5/520
O.E.M. 1875551
d|s-rh|lh-rechts|links
nero, semipiatta, con cinghietti
black, semi-flat, with stretchers
schwarz, halbflach, mit Spanngummi



XF5/518
O.E.M. 1875554
d-rh-rechts
nero, con anti-spray, con staffe
black, with anti-spray, with brackets
schwarz, mit Spritzschutz, mit Klemme

XF5/538
O.E.M. -
d-rh-rechts
nero, senza anti-spray, con staffe
black, without anti-spray, with brackets
schwarz, ohne Spritzschutz, mit Klemme



XF5/516
O.E.M. 1875550
d-rh-rechts
nero, con staffe
black, with brackets
schwarz, mit Klemme

XF5/520



XF5/517
O.E.M. 1875549
s-lh-links
nero, con staffe
black, with brackets
schwarz, mit Klemme

XF5/519
O.E.M. 1875553
s-lh-links
nero, con anti-spray, con staffe
black, with anti-spray, with brackets
schwarz, mit Spritzschutz, mit Klemme

XF5/539
O.E.M. -
s-lh-links
nero, senza anti-spray, con staffe
black, without anti-spray, with brackets
schwarz, ohne Spritzschutz, mit Klemme

XF105

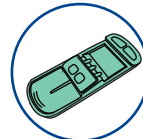

XF5/515



XF5/520
d|s-rh|lh
rechts|links



XF5/516
d-rh-rechts
XF5/517
s-lh-links



XF5/522
d-rh-rechts
XF5/523
s-lh-links

XF5/510
d|s-rh|lh
rechts|links

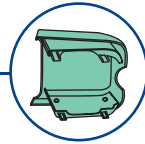

XF5/532
d-rh-rechts
XF5/533
s-lh-links

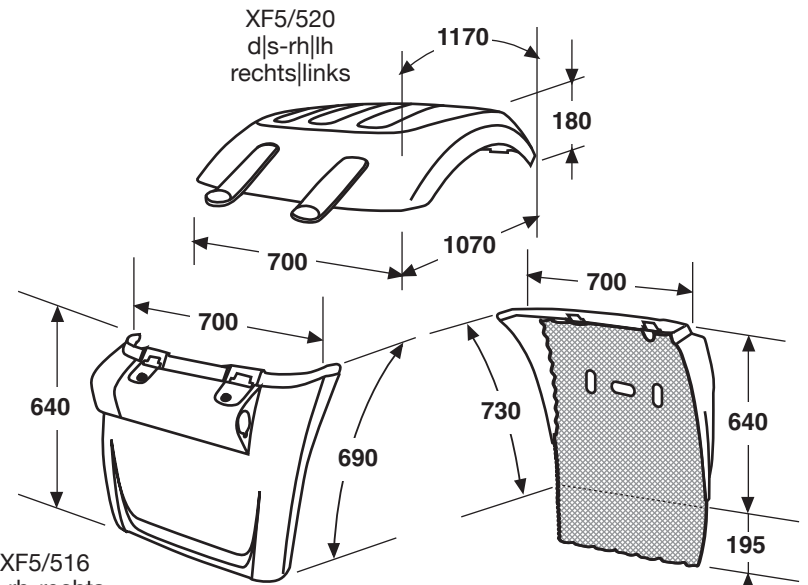

XF5/516
d-rh-rechts
XF5/517
s-lh-links

XF5/522
d-rh-rechts
XF5/523
s-lh-links
XF5/532
d-rh-rechts
XF5/533
s-lh-links



XF5/510
O.E.M. 1875567



XF5/515
O.E.M. 1927847

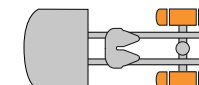

XF5/520
O.E.M. 187551
d|s-rh|lh-rechts|links
nero, semipiatta, con cinghietti
black, semi-flat, with stretchers
schwarz, halbflach, mit Spanngummi

XF5/522
O.E.M. 1892198
d-rh-rechts
nero, con anti-spray, con staffe
black, with anti-spray, with brackets
schwarz, mit Spritzschutz, mit Klemme

XF5/532
O.E.M. -
d-rh-rechts
nero, senza anti-spray, con staffe
black, without anti-spray, with brackets
schwarz, ohne Spritzschutz, mit Klemme



XF5/520



XF5/517
O.E.M. 1875549
s-lh-links
nero, con staffe
black, with brackets
schwarz, mit Klemme

XF5/523
O.E.M. 1892197
s-lh-links
nero, con anti-spray, con staffe
black, with anti-spray, with brackets
schwarz, mit Spritzschutz, mit Klemme

XF5/533
O.E.M. -
s-lh-links
nero, senza anti-spray, con staffe
black, without anti-spray, with brackets
schwarz, ohne Spritzschutz, mit Klemme



XF5/516
O.E.M. 1875550
d-rh-rechts
nero, con staffe
black, with brackets
schwarz, mit Klemme

XF105

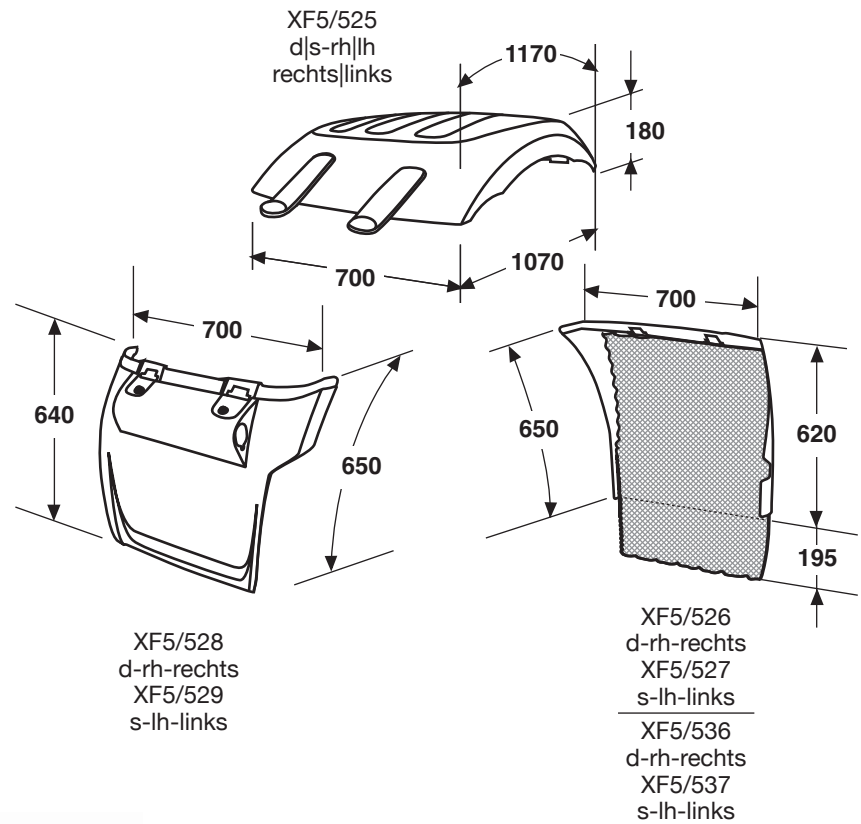
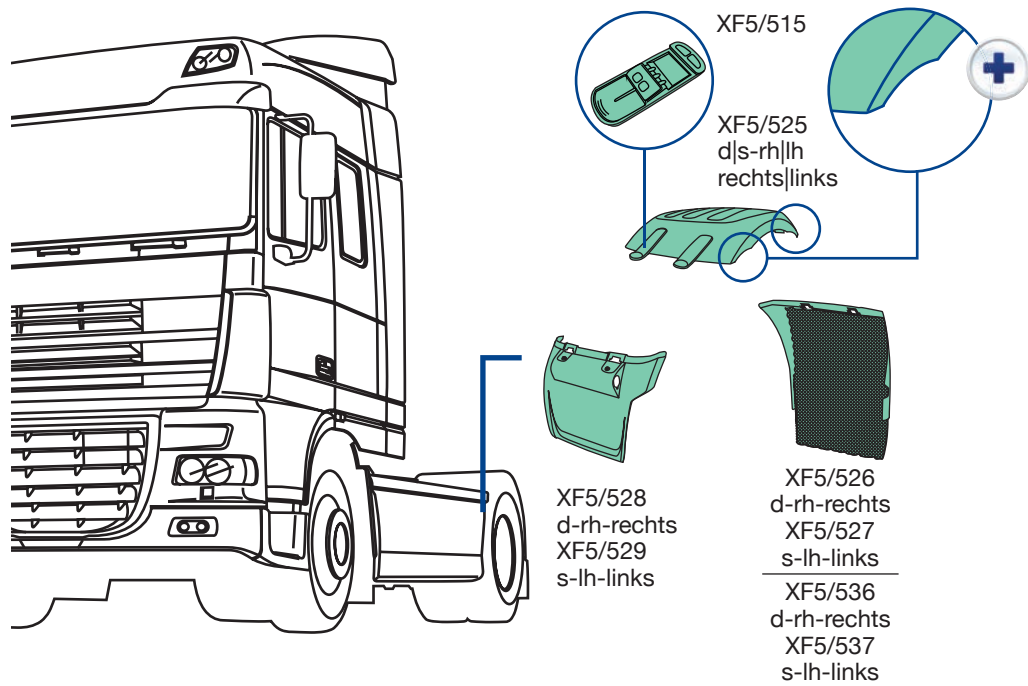

XF5/515
O.E.M. 1927847

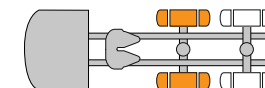

XF5/525
O.E.M. 1875552
d|s-rh|lh-rechts|links
nero, semipiatta, con cinghietti
black, semi-flat, with stretchers
schwarz, halbflach, mit Spanngummi

XF5/526
O.E.M. 1892248
d-rh-rechts
nero, con anti-spray, con staffe
black, with anti-spray, with brackets
schwarz, mit Spritzschutz, mit Klemme

XF5/536
O.E.M. -
d-rh-rechts
nero, senza anti-spray, con staffe
black, without anti-spray, with brackets
schwarz, ohne Spritzschutz, mit Klemme



XF5/525



XF5/529
O.E.M. 1892245
s-lh-links
nero, con staffe
black, with brackets
schwarz, mit Klemme

XF5/527
O.E.M. 1892247
s-lh-links
nero, con anti-spray, con staffe
black, with anti-spray, with brackets
schwarz, mit Spritzschutz, mit Klemme



XF5/528
O.E.M. 1892246
d-rh-rechts
nero, con staffe
black, with brackets
schwarz, mit Klemme

XF5/537
O.E.M. -
s-lh-links
nero, senza anti-spray, con staffe
black, without anti-spray, with brackets
schwarz, ohne Spritzschutz, mit Klemme

XF105

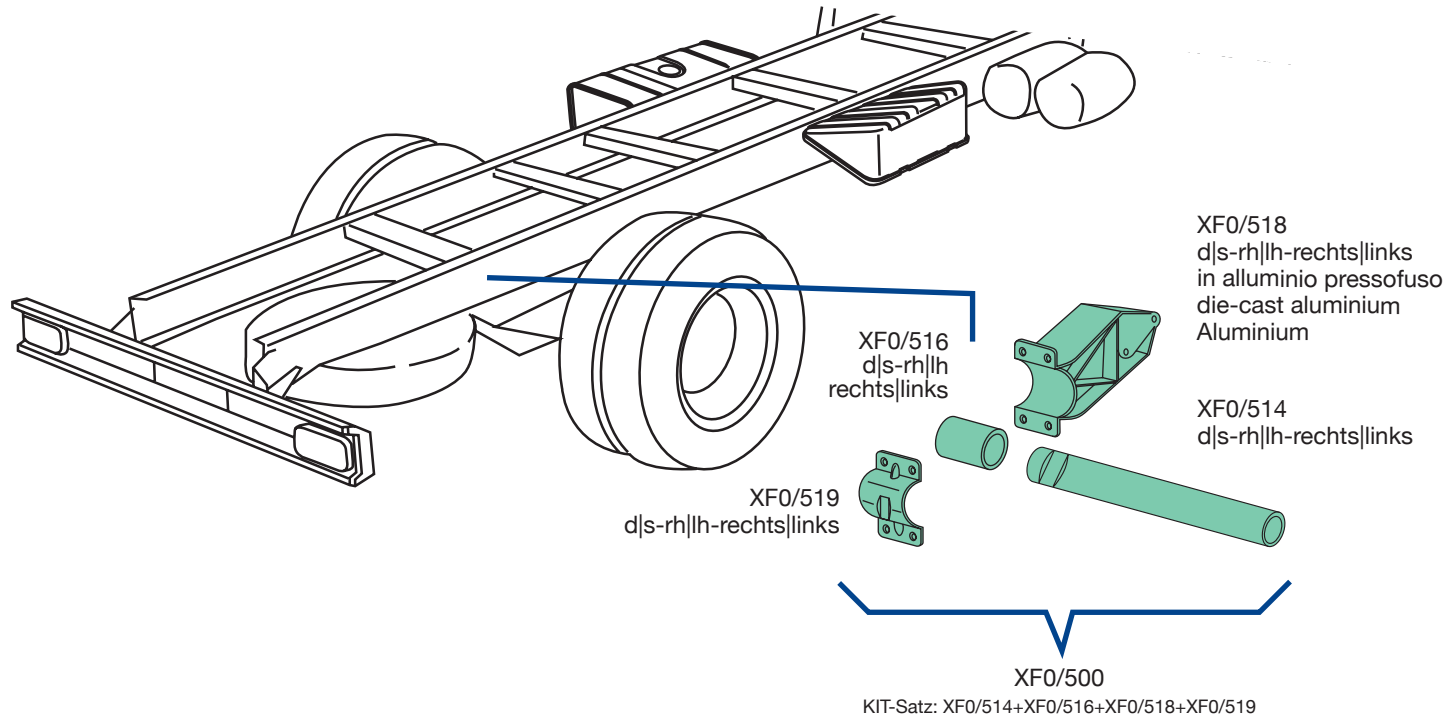

XF0/514
O.E.M. 1610454



XF0/516
O.E.M. 1629045



XF0/518
O.E.M. 2050044



XF0/519
O.E.M. 1629046

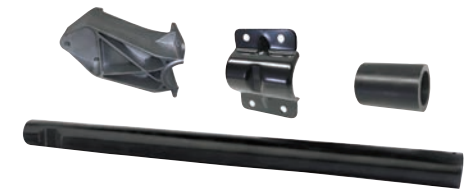

XF0/500
O.E.M. 1371224

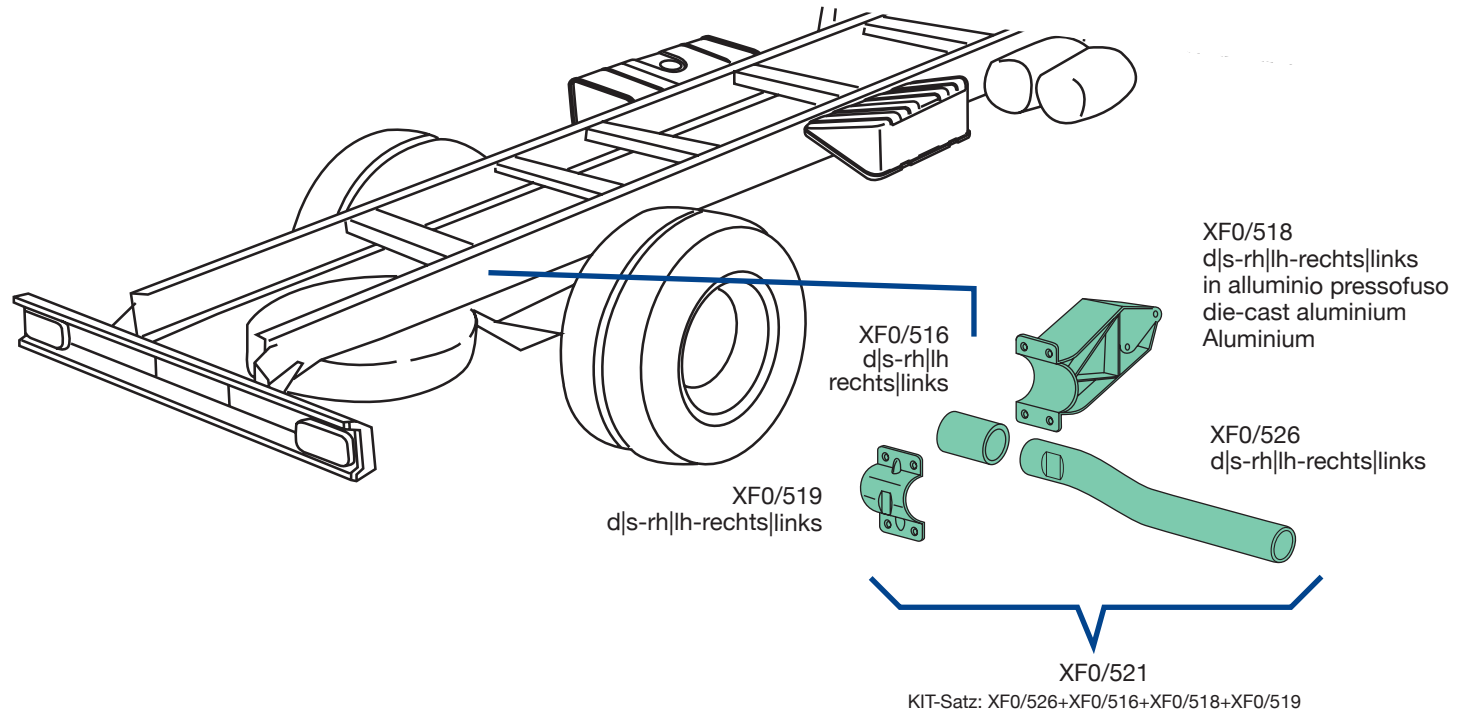

XF0/516
O.E.M. 1629045



XF0/518
O.E.M. 2050044



XF0/519
O.E.M. 1629046



XF0/526
O.E.M. 1629036



XF0/521
O.E.M. 1371226

applicabile a I suitable to I verwendbar für:

XF105

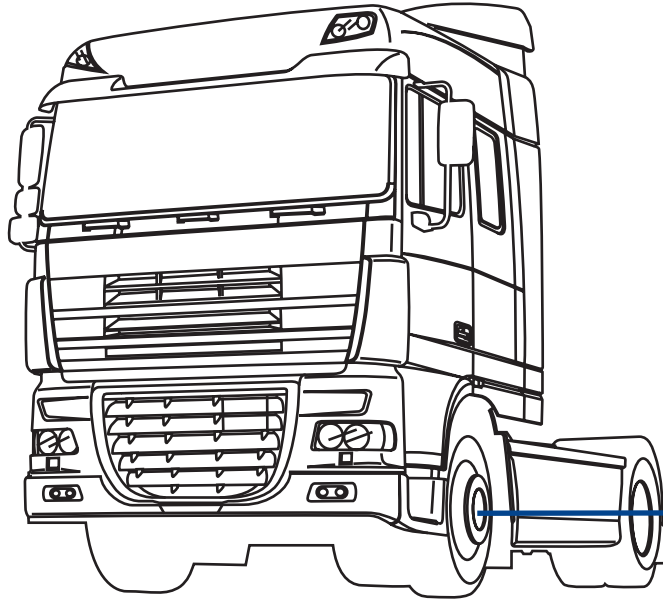

930/032



930/001
d-rh-rechts
930/002
s-lh-links



930/200
d|s-rh|lh
rechts|links

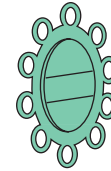

930/100
d-rh-rechts
930/101
s-lh-links



930/032
O.E.M. -



930/001
O.E.M. -
930/002
O.E.M. -



930/100
O.E.M. -
930/101
O.E.M. -

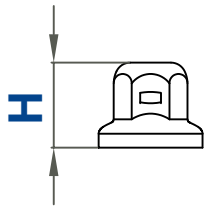

930/200
O.E.M. -

930/032 - Tappo copri bullone-Bolt cover-Radmutterkappe

H	45 mm
Per bulloni \varnothing -bolt \varnothing -Bolzen \varnothing	32 mm
Materiale-Material	acciaio inox-stainless steel Edelstahl
Kg	0,025

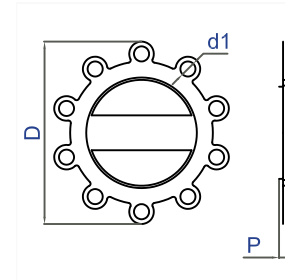
**930/100 d-rh-rechts - 930/101 s-lh-links**

D \varnothing 387 mm	P 30 mm
d1 nr. 10	d1 \varnothing 32 mm
Ventilata	si-yes-Ja
Ventilated-Belüftet	
Colore	cromato e nero-chrome and black
Colours-Farbe	verchromt und schwarz
Materiale-Material	acciaio inox e plastica stainless steel and plastic Edelstahl und Kunststoff
Kg	0,655

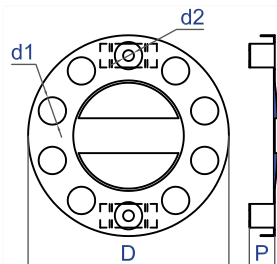
**930/001 d-rh-rechts - 930/002 s-lh-links**

D \varnothing 425 mm	P 50 mm
d1 nr. 10	d1 \varnothing 58 mm
d2 nr. 2	d2 \varnothing 23 mm
Ventilata	si-yes-ja
Ventilated-Belüftet	
Colore	cromato e nero-chrome and black
Colours-Farbe	verchromt und schwarz
Materiale-Material	acciaio inox e plastica stainless steel and plastic Edelstahl und Kunststoff
Kg	1,230

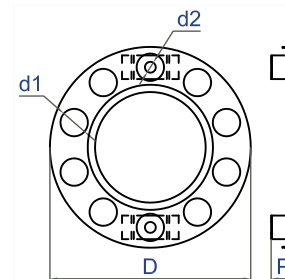
**930/200 d|s-rh|lh-rechts|links**

D \varnothing 425 mm	P 40 mm
d1 nr. 10	d1 \varnothing 58 mm
d2 nr. 2	d2 \varnothing 23 mm
Ventilata	no-nein
Ventilated-Belüftet	
Colore	cromato-chrome-verchromt
Colours-Farbe	
Materiale-Material	acciaio inox-stainless steel Edelstahl
Kg	1,155

applicabile a | suitable to | verwendbar für:

XF105

240/675



240/677

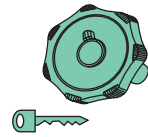

038/678

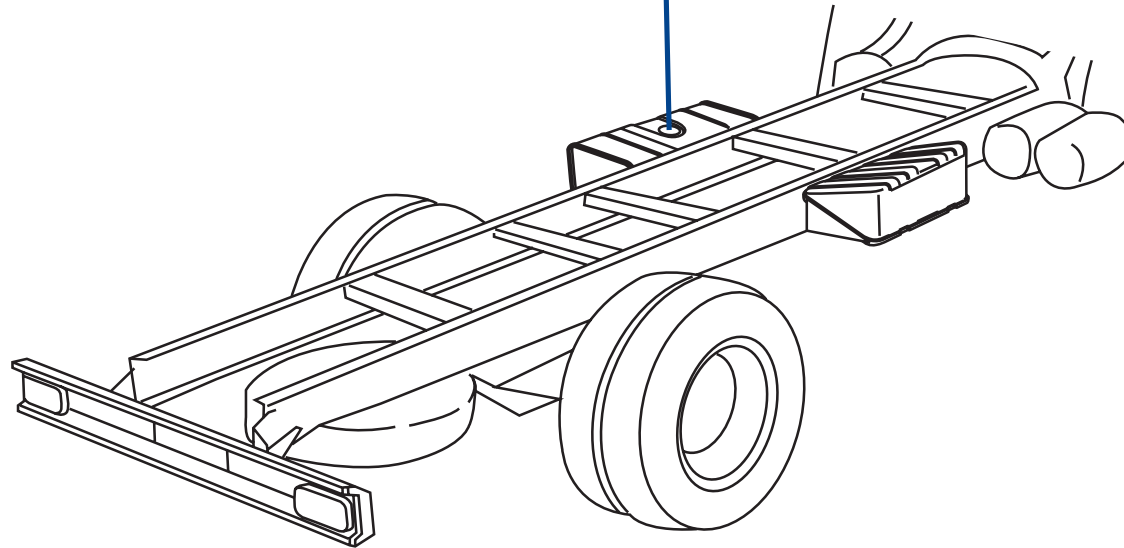
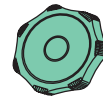

240/675

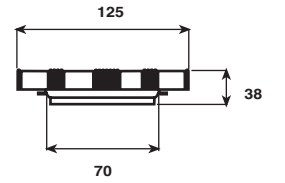

240/677

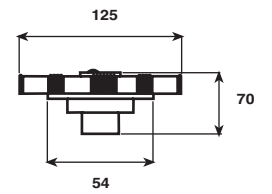

038/678

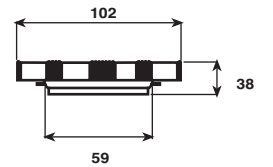

240/675
O.E.M. 41042699



240/677
O.E.M. 500043667



038/678
O.E.M. 4821320

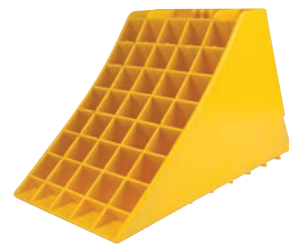
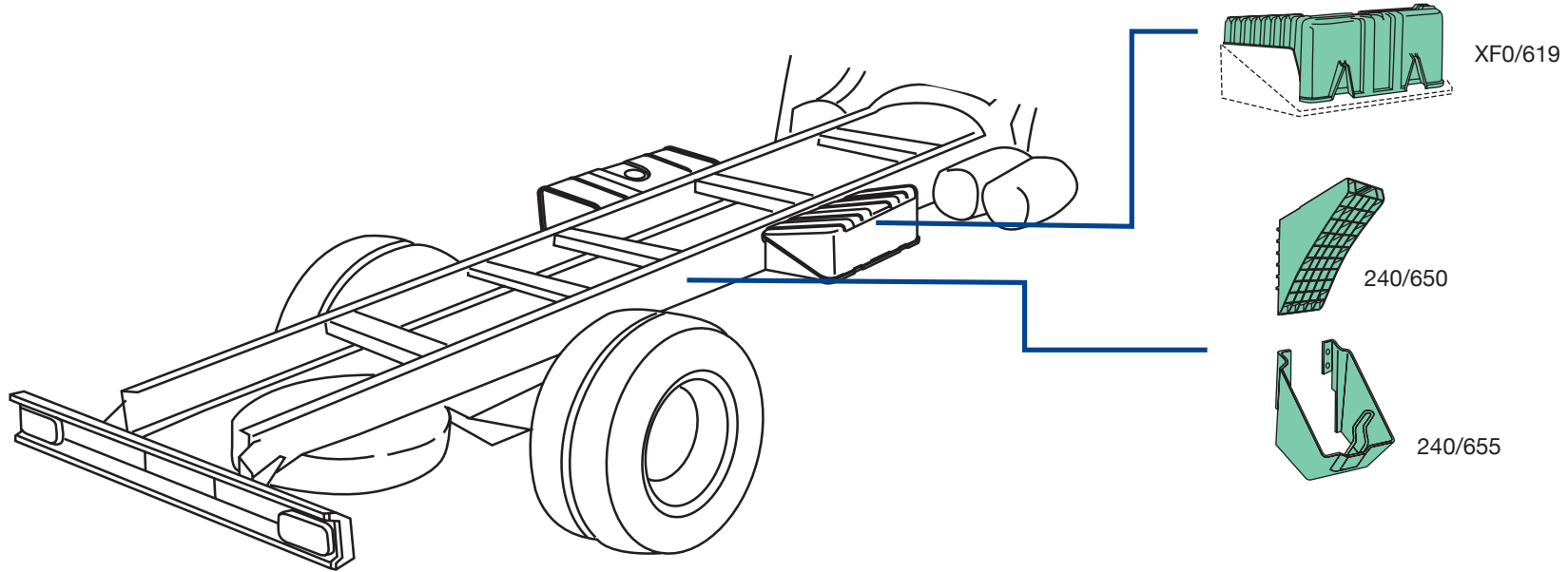

240/650
O.E.M. 99430053



240/655
O.E.M. 41026756



XF0/619
O.E.M. 1745335

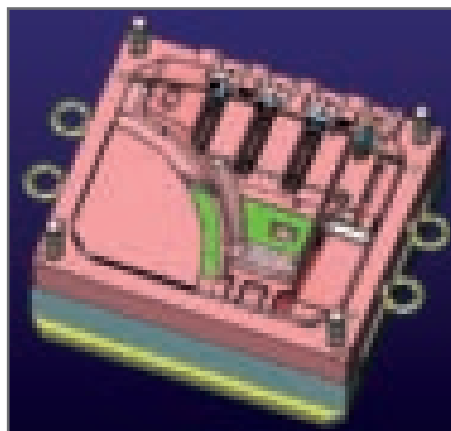
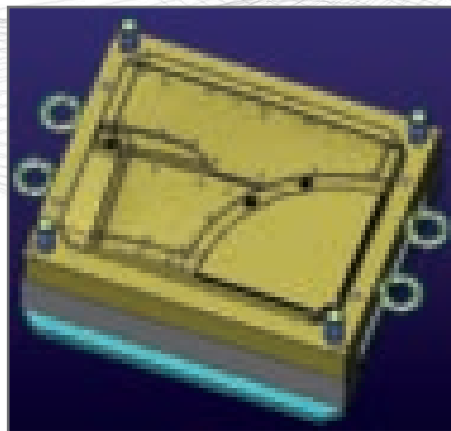

IT Progetto in 3D dell'estensione porta DAF XF106
EN 3D project of the door extension DAF XF106 vehicle
DE 3-D Projekt der Türverlängerung für DAF XF106



applicabile a | suitable to | verwendbar für 155

XF2
XF95

SECONDA SERIE | SECOND SERIES | ZWEITE SERIE

applicabile a | suitable to | verwendbar für:

XF95 | SECONDA SERIE | SECOND SERIE | ZWEITE SERIE

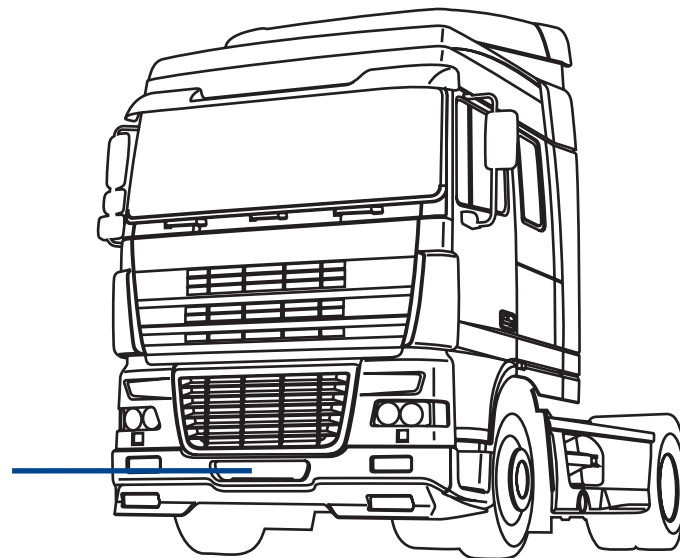
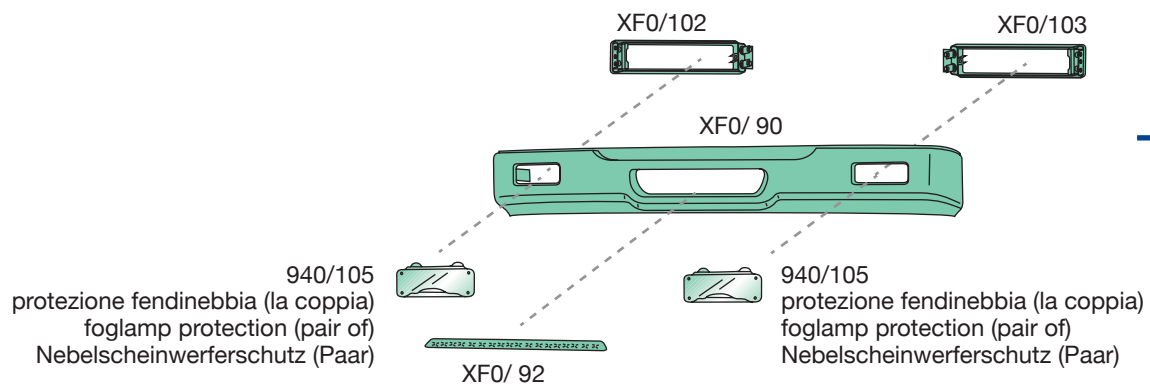

XF0/90
O.E.M. 1290191



XF0/92
O.E.M. 0948779



XF0/102
O.E.M. 1449529
XF0/103
O.E.M. 1449528



940/105
O.E.M. -

XF95 SECONDA SERIE | SECOND SERIE | ZWEITE SERIE



XF0/ 80
in ferro - iron - Stahl

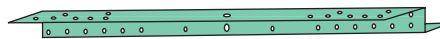

XF0/ 96
completo di minuterie per il fissaggio
with assembly screw kit
mit Befestigungssatz

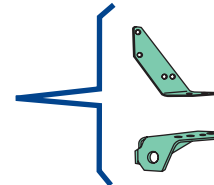

XF0/ 84 d-rh-rechts
XF0/ 85 s-lh-links

XF0/ 86 d-rh-rechts
XF0/ 87 s-lh-links



XF0/ 80
O.E.M. 1427140



XF0/ 96
O.E.M. 1317126



XF0/ 84
O.E.M. 1319679
XF0/ 85
O.E.M. 1319678



XF0/ 86
O.E.M. 1450977
XF0/ 87
O.E.M. 1450976

applicabile a | suitable to | verwendbar für:

XF95 | SECONDA SERIE | SECOND SERIE | ZWEITE SERIE

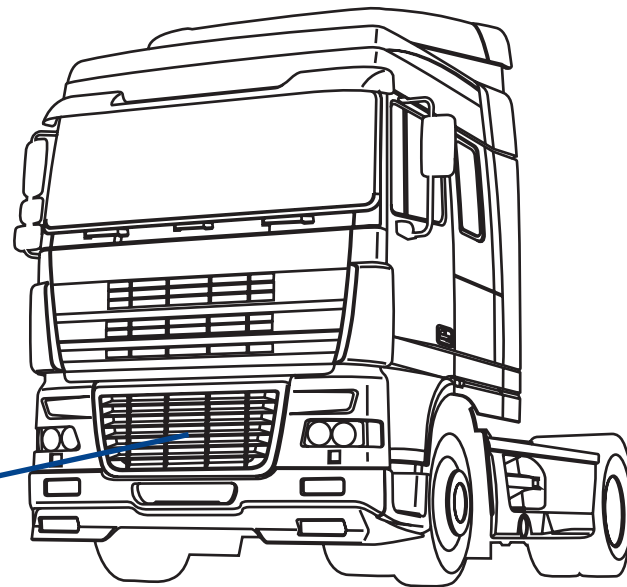

XF0/150
completo di
complete with
komplett mit
XF0/152-153

XF2/ 98

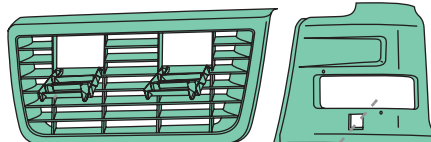

XF2/ 99

940/095
protezione faro (la coppia)
headlamp protection (pair of)
Scheinwerferschutz (Paar)

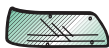

940/095
protezione faro (la coppia)
headlamp protection (pair of)
Scheinwerferschutz (Paar)



XF0/150
O.E.M. 1312789



XF2/ 98
O.E.M. 1398285
XF2/ 99
O.E.M. 1398284



940/095
O.E.M. -

XF95 SECONDA SERIE | SECOND SERIE | ZWEITE SERIE

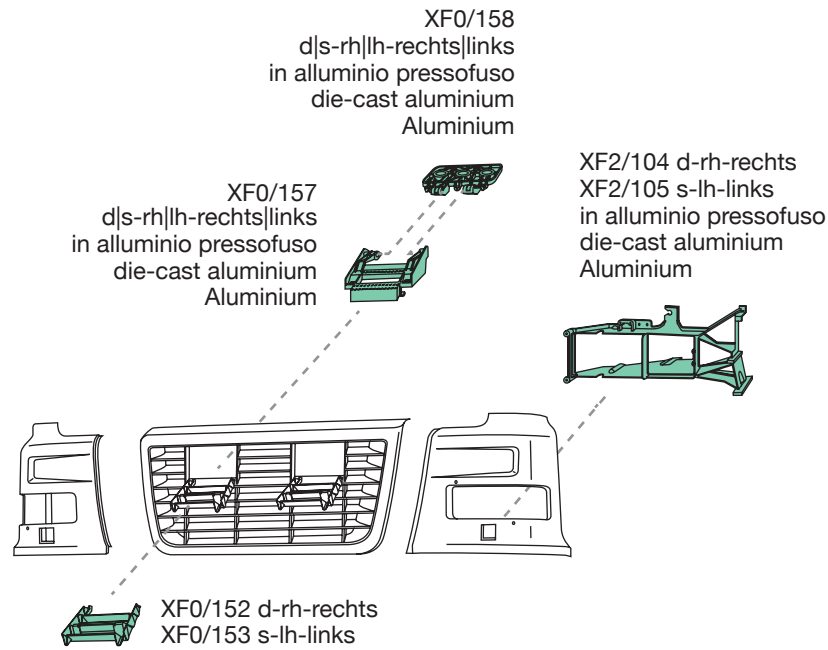

XF0/152
O.E.M. 1309113
XF0/153
O.E.M. 1309112

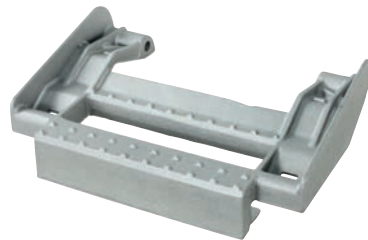

XF0/157
O.E.M. 1689404



XF0/158
O.E.M. 1735004



XF2/104
O.E.M. 1862946
XF2/105
O.E.M. 1862945

applicabile a | suitable to | verwendbar für:

XF95 | SECONDA SERIE | SECOND SERIE | ZWEITE SERIE

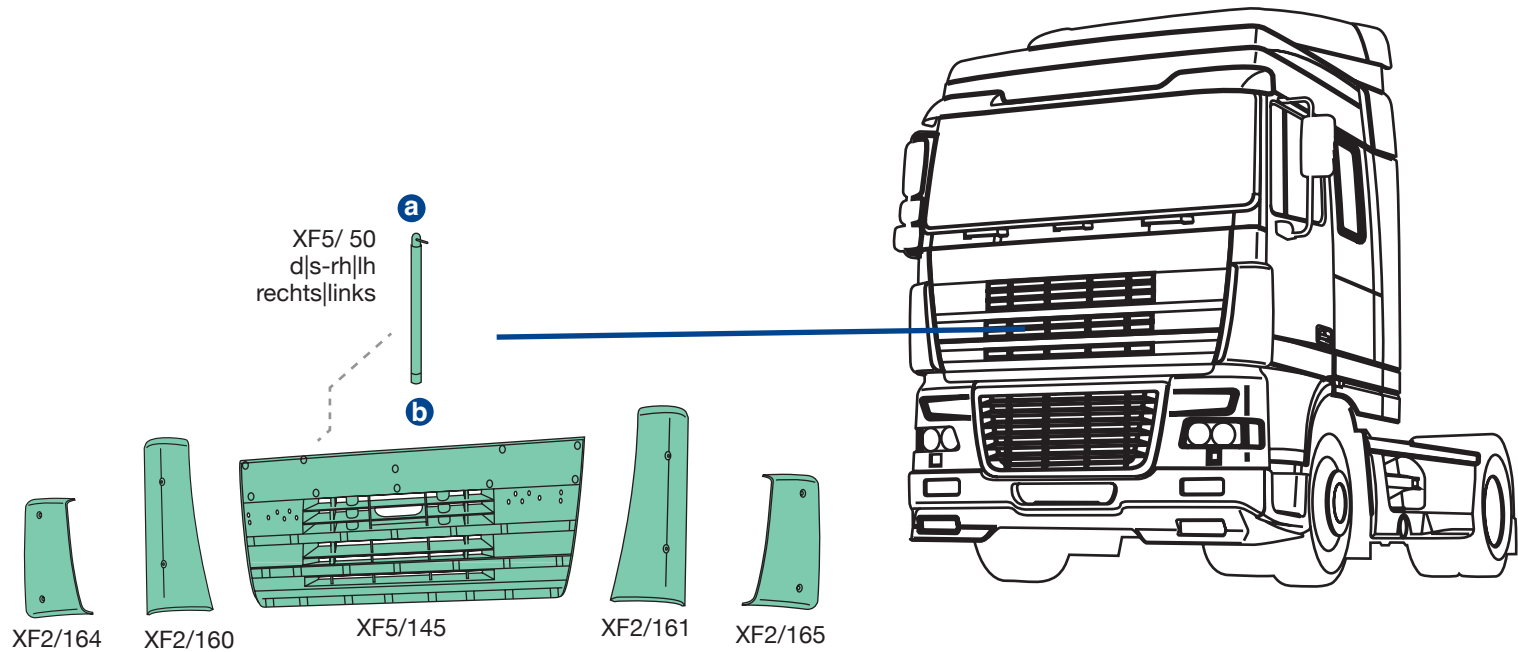

XF2/160
O.E.M. 1400012
XF2/161
O.E.M. 1400011



XF2/164
O.E.M. 1400014
XF2/165
O.E.M. 1400013



XF5/ 50
O.E.M. 1651601

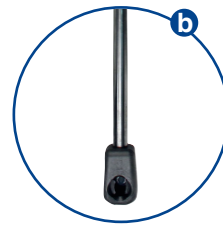

XF5/145
O.E.M. 1400004



XFO/400

O.E. 1286384

Adattabile a:
Suitable to:
passend für:

DAF 95XF - XF95 - XF105
tetto alto - high roof
hohes Dach

Materiale - Material - Material:
PMMA - Acrylglas

KIT completo di staffe e minuterie
IN ALLESTIMENTO
KIT complete of brackets and findings
NOT AVAILABLE YET
Befestigungssatz
IN ARBEIT



L	H	P	kg.
cm.	cm.	cm.	
240	19	21,5	1,870

applicabile a | suitable to | verwendbar für:

XF95 SECONDA SERIE | SECOND SERIE | ZWEITE SERIE



XF0/405

O.E. 1300557

Adattabile a:
Suitable to:
passend für:

DAF 95XF - XF95
XF105 space cab
tetto medio - medium roof
mittelhohes Dach

Materiale - Material - Material:
PMMA - Acrylglas



XF0/480

O.E. 1311766

KIT completo
di staffe
e minuterie.
Assembly KIT.
Befestigungssatz



L	H	P	kg.
cm.	cm.	cm.	
236	25	20	3,600



L'immagine del prodotto è da considerarsi puramente indicativa | The product image is just for information | Die Produktbilder sind nur zur Information.



XF0/425

O.E. 1651597

Adattabile a:
Suitable to:
passend für:

**DAF 95XF - XF95
XF105 super space cab**

Materiale - Material - Material:
PMMA - Acrylglas

KIT completo di staffe e minuterie
IN ALLESTIMENTO
KIT complete of brackets and findings
NOT AVAILABLE YET
Befestigungssatz
IN ARBEIT



L	H	P	kg.
cm.	cm.	cm.	
252	35	19,5	2,305

applicabile a I suitable to I verwendbar für:

XF95 SECONDA SERIE | SECOND SERIE | ZWEITE SERIE



XF0/502

II (E4) 024096

189x368 mm

IV (E4) 024097

204x195 mm

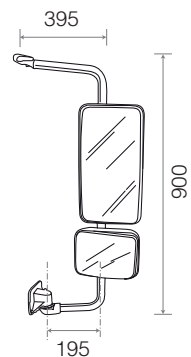

applicabilità:
applicable to:
Verwendbar für

DAF 95XF 2000 →
DAF XF95 →2006

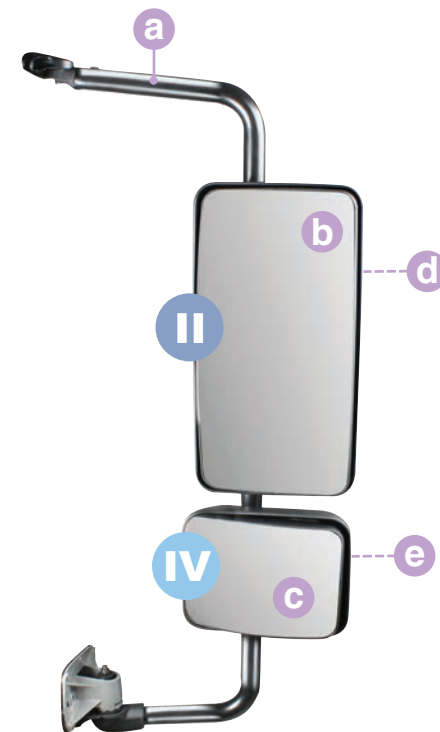

COVIND

XF0/525

1610184*
(1425105)*

II



203x380 mm

XF0/524

1610189

IV



216x167 mm

* OEM R1800_COVIND R1200 | OEM R400_COVIND R300 (view legenda)

<p>a XF0/512</p>	<p>1425118</p>			<p>280x900 mm</p>
<p>b XF0/504</p> <p>II</p>	<p>1610190* (1425109)*</p>			<p>E4 024096</p> <p>189x368 mm</p>
<p>c XF0/505</p> <p>IV</p>	<p>1610182</p>			<p>E4 024097</p> <p>204x195 mm</p>
<p>d XF0/507</p> <p>II</p>	<p>1425113</p>			<p>187x367 mm</p>
<p>e XF0/508</p> <p>IV</p>	<p>1425114</p>			<p>202x151 mm</p>

applicabile a | suitable to | verwendbar für:



XF95 SECONDA SERIE | SECOND SERIE | ZWEITE SERIE

XF0/503

1610263
(1397137)



|| E4 024096
189x368 mm

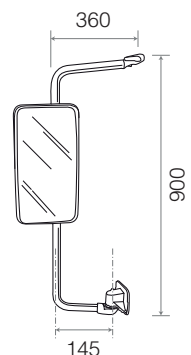

applicabilità:
applicable to:
Verwendbar für

DAF 95XF 2000 →
DAF XF95 → 2006

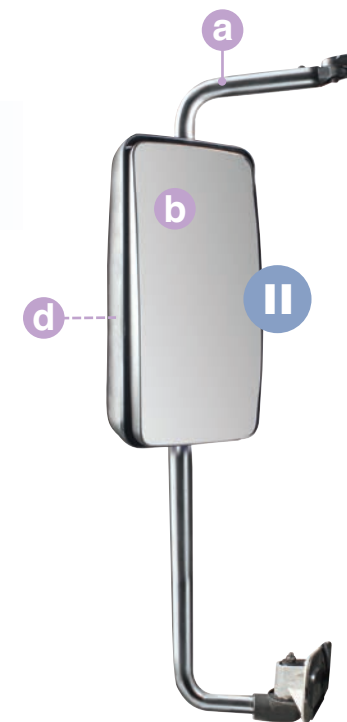

COVIND

XF0/525

1610184*
(1425105)*



203x380 mm

||

* OEM R1800_COVIND R1200 | OEM R1400_COVIND R300 (view legenda)

a XF0/513

1425116



235x900mm

b XF0/504

1610190*
(1425109)*



E4 024096

189x368 mm

d XF0/507

1425113



187x367mm

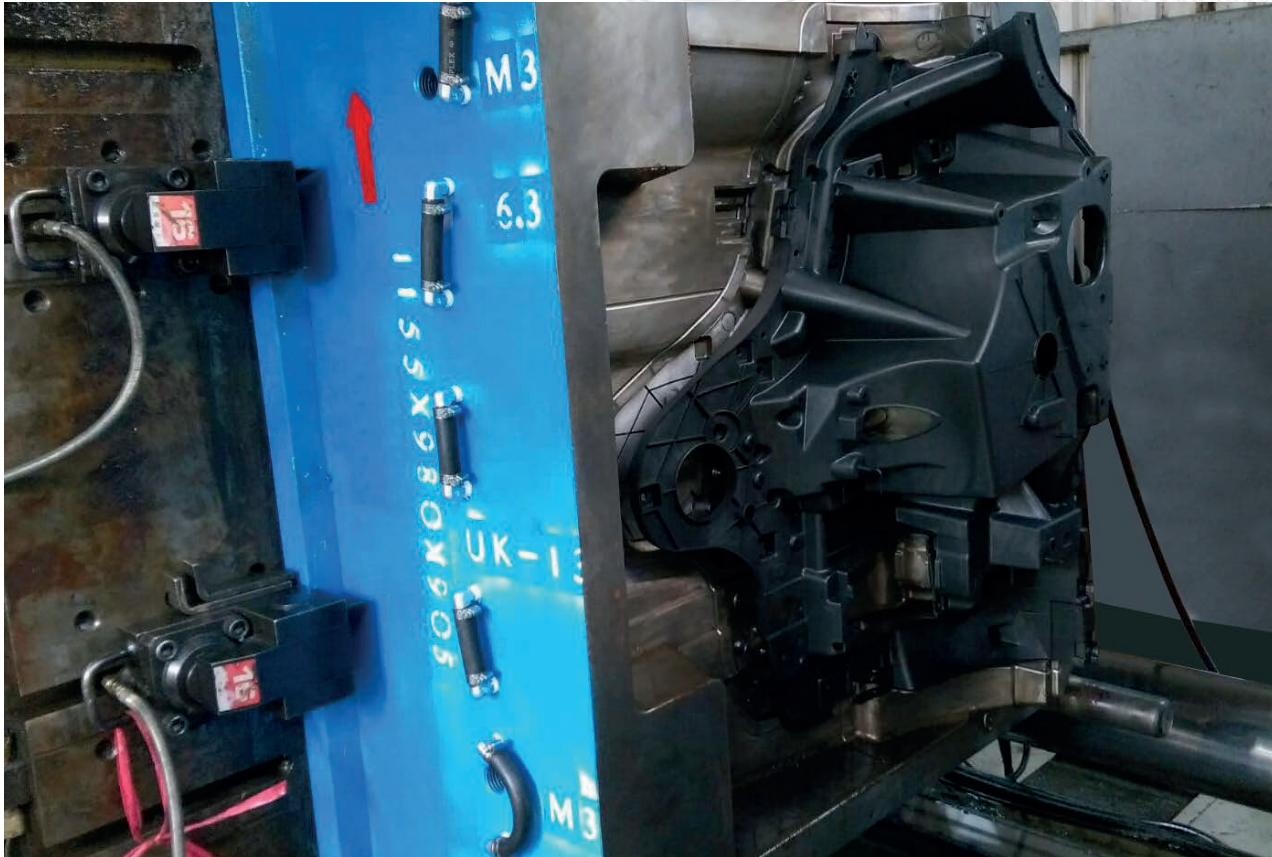

- IT Stampo a iniezione per ossatura portafaro destro
EN RH headlamp housing injection moulding
DE Spritzgusswerkzeug für rechten Scheinwerfer traeger



IT Stampo a iniezione per griglia
EN Grille housing injection moulding
DE Spritzgusswerkzeug für Grille

applicabile a I suitable to I verwendbar für:

XF95 SECONDA SERIE | SECOND SERIE | ZWEITE SERIE



XF5/500

II

E4 024094

177x363 mm

IV

E4 024095

207x161 mm

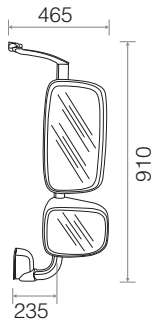

applicabilità:
applicable to:
Verwendbar für

DAF XF95 07/2009 →
DAF XF105 → 2011

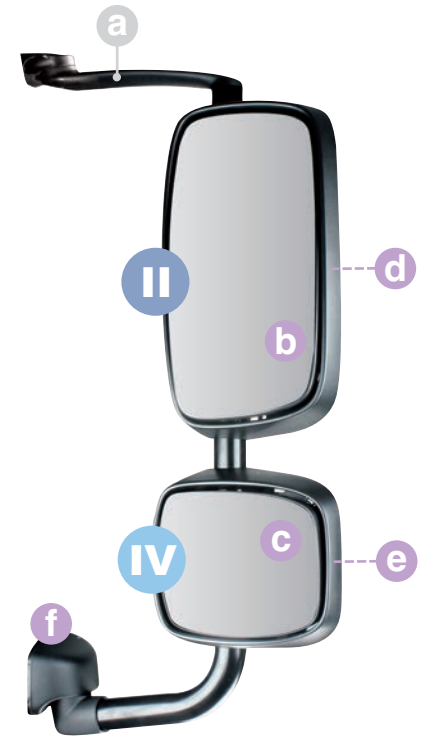

COVIND

XF5/509

II

1812862
(1689348)



224x412 mm

XF5/507

IV

1817860
(1689347)



242x222 mm

a

b

XF5/502

1685330

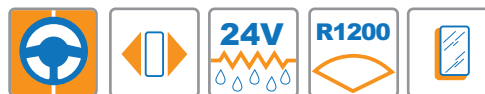

E4 024094

177x363 mm

II

c

XF5/503

1685331

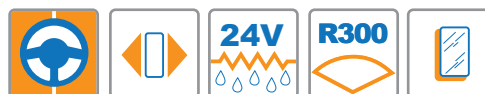

E4 024095

207x161 mm

IV

d

XF5/506

1644325
(1659248)



223x410 mm

II

e

XF5/505

1644326
(1659249)



242x218 mm

IV

f

XF5/512

1644323



applicabile a | suitable to | verwendbar für:

XF95 SECONDA SERIE | SECOND SERIE | ZWEITE SERIE



XF5/501

II (E4) 024094
177x363 mm

IV (E4) 024095
207x161 mm

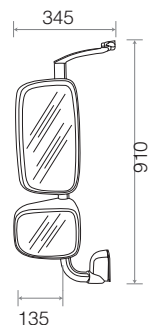

applicabilità:
applicable to:
verwendbar für



DAF XF95 07/2009 →
DAF XF105 → 2011

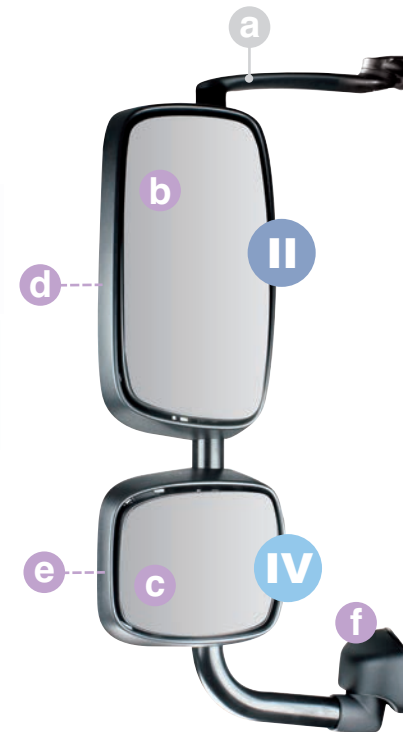

COVIND

XF5/509

II

1812862
(1689348)



224x412 mm

XF5/507

IV

1817860
(1689347)



242x222 mm

a	-	-								
b	XF5/502	1685330							E4 024094	177x363 mm
	II									
c	XF5/503	1685331							E4 024095	207x161 mm
	IV									
d	XF5/506	1644325 (1659248)								223x410 mm
	II									
e	XF5/505	1644326 (1659249)								242x218 mm
	IV									
f	XF5/513	1644324								

XF95 SECONDA SERIE | SECOND SERIE | ZWEITE SERIE

(*) Vernice di fondo - Unprocessed - Grundiert
(°) Verniciato grigio - Grey painted - Grau lackiert

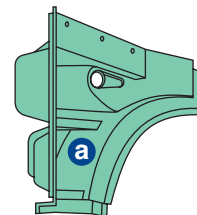
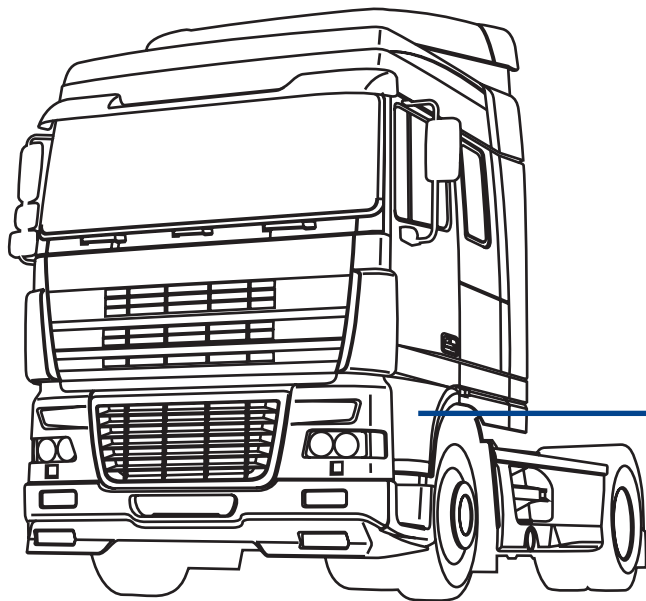

XF0/200 d-rh-rechts (°)
XF0/201 s-lh-links (°)

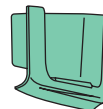

XF0/240 d-rh-rechts (*)
XF0/241 s-lh-links (*)

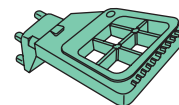

XF0/236 d-rh-rechts
XF0/237 s-lh-links
in alluminio pressofuso
die-cast aluminium
Aluminium

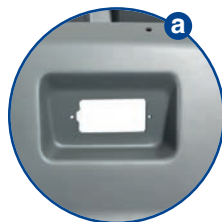

XF0/200
O.E.M. 1809266
XF0/201
O.E.M. 1809265

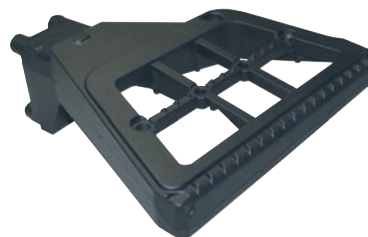

XF0/236
O.E.M. 1605933
XF0/237
O.E.M. 1605932



XF0/240
O.E.M. 1295735
XF0/241
O.E.M. 1295732

XF95 SECONDA SERIE | SECOND SERIE | ZWEITE SERIE

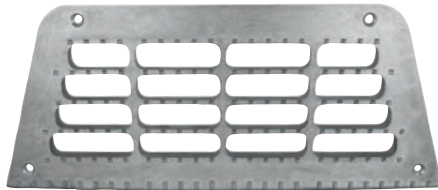
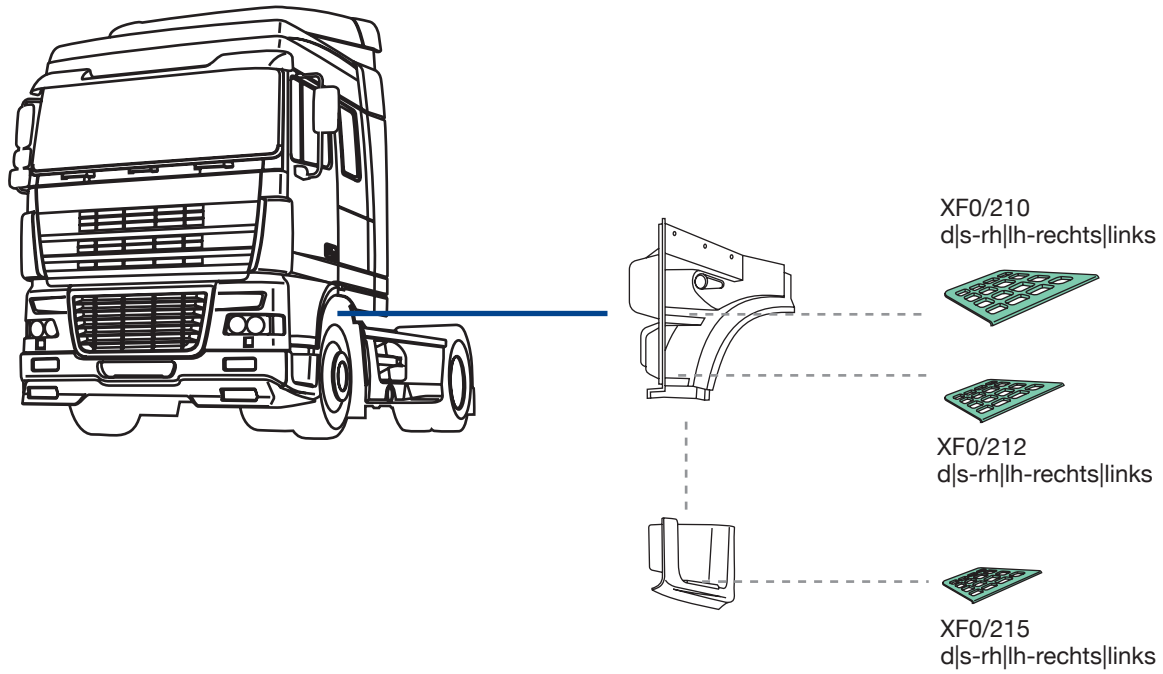

XF0/210
O.E.M. 0673144

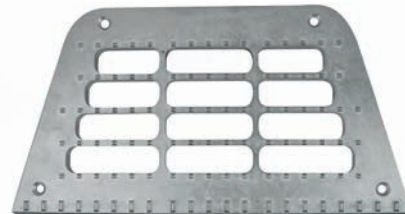

XF0/212
O.E.M. 0673143



XF0/215
O.E.M. 0962643

applicabile a | suitable to | verwendbar für:

XF95 SECONDA SERIE | SECOND SERIE | ZWEITE SERIE

(a) con anti-spray - with anti-spray - mit Spritzschutz

PDS/360

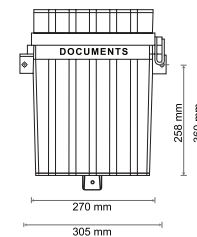
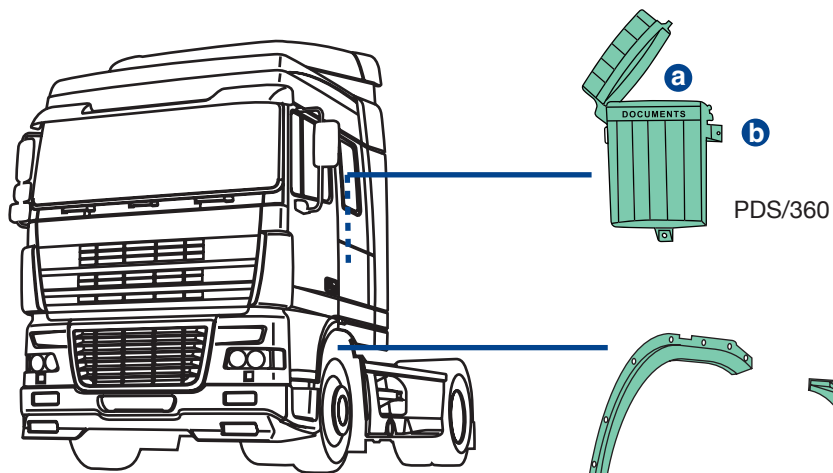

XF0/202 d-rh-rechts
XF0/203 s-lh-links

XF0/320 d-rh-rechts
XF0/321 s-lh-links
(a) CF0/320 d-rh-rechts
(a) CF0/321 s-lh-links



XF0/202
O.E.M. 1291165
XF0/203
O.E.M. 1291164



XF0/320
O.E.M. 1997262
XF0/321
O.E.M. 1997261



CF0/320
O.E.M. 1997258
CF0/321
O.E.M. 1997257



PDS/360
O.E.M. -

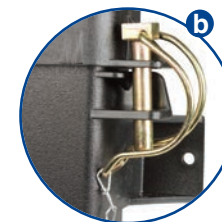

XF95 SECONDA SERIE | SECOND SERIE | ZWEITE SERIE

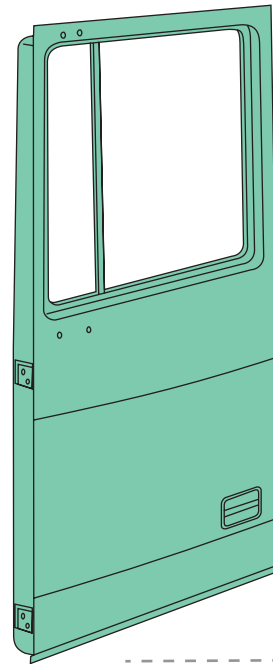

XF0/ 2 d-rh-rechts
XF0/ 3 s-lh-links
senza cerniere
without hinges
ohne Türscharniere

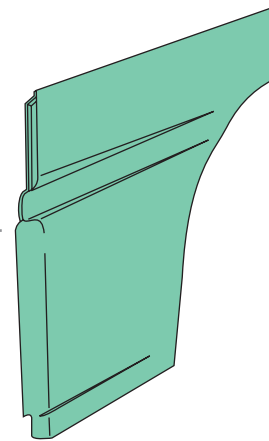

XF0/ 4 d-rh-rechts
XF0/ 5 s-lh-links



XF0/ 2
O.E.M. 1676219
XF0/ 3
O.E.M. 1676218



XF0/ 4
O.E.M. 1295620
XF0/ 5
O.E.M. 1295619

applicabile a | suitable to | verwendbar für:

XF95 | SECONDA SERIE | SECOND SERIE | ZWEITE SERIE

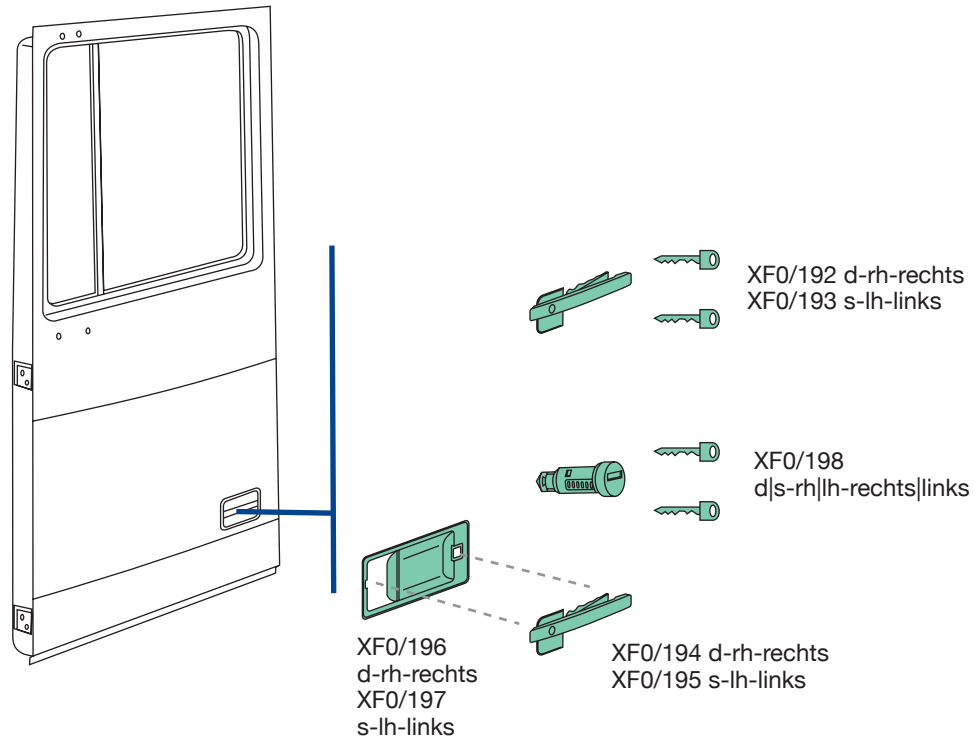

XF0/192
O.E.M. -
XF0/193
O.E.M. -



XF0/194
O.E.M. 1305482
XF0/195
O.E.M. 1305481



XF0/196
O.E.M. 1305480
XF0/197
O.E.M. 1305479



XF0/198
O.E.M. 1336529

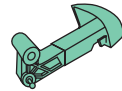
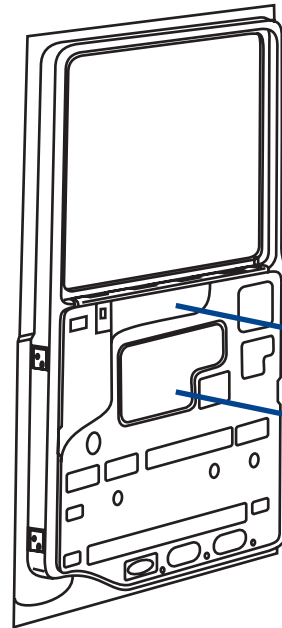

XF0/175 d-rh-rechts
XF0/176 s-lh-links
completa di leva
complete with lever
komplett mit Knauf und Hebel

XF0/164 d-rh-rechts
XF0/165 s-lh-links
elettrico con motorino
electric with motor
elektrisch mit Motor

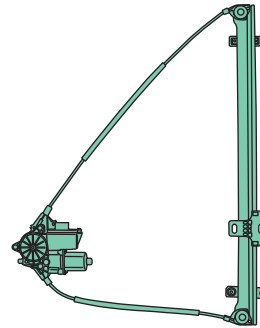
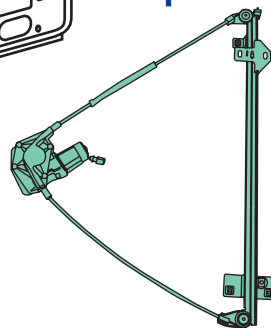

XF0/166 d-rh-rechts
XF0/167 s-lh-links
elettrico con motorino
electric with motor
elektrisch mit Motor



XF0/164
O.E.M. 1354703
XF0/165
O.E.M. 1354702



XF0/166
O.E.M. 1918146
XF0/167
O.E.M. 1918145



XF0/175
O.E.M. 1309408+1354697
XF0/176
O.E.M. 1309407+1354696

applicabile a | suitable to | verwendbar für:

XF95 SECONDA SERIE | SECOND SERIE | ZWEITE SERIE

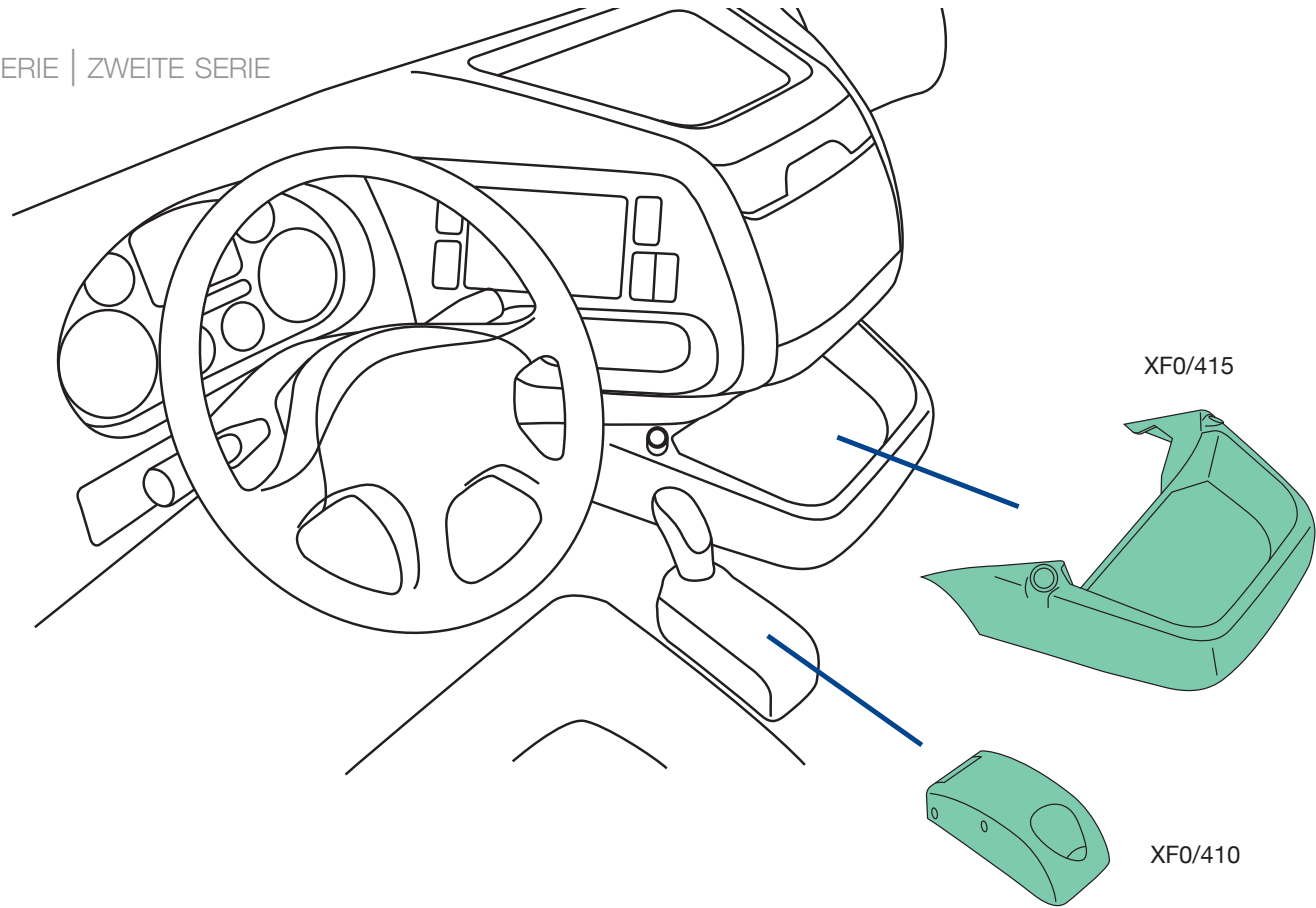

XF0/410
O.E.M. 1642302



XF0/415
O.E.M. 1334620

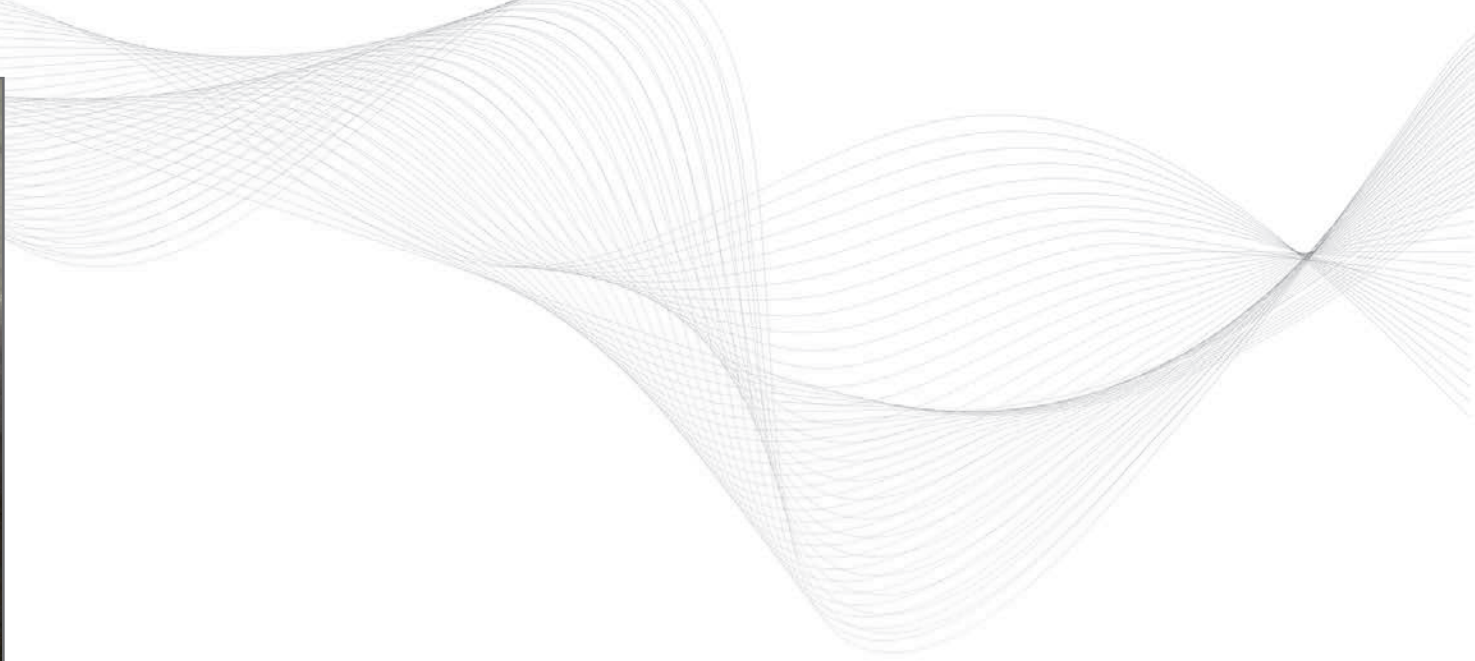

- IT Stampo in acciaio per la produzione di un paraurti.
EN Steel mould for the production for bumper.
DE Stahlwerkzeug für Stoßstangenfertigung.

XF95 SECONDA SERIE | SECOND SERIE | ZWEITE SERIE

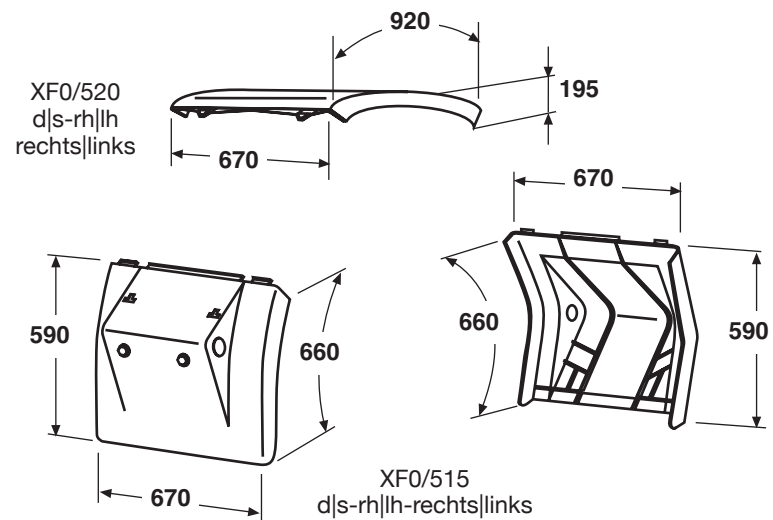
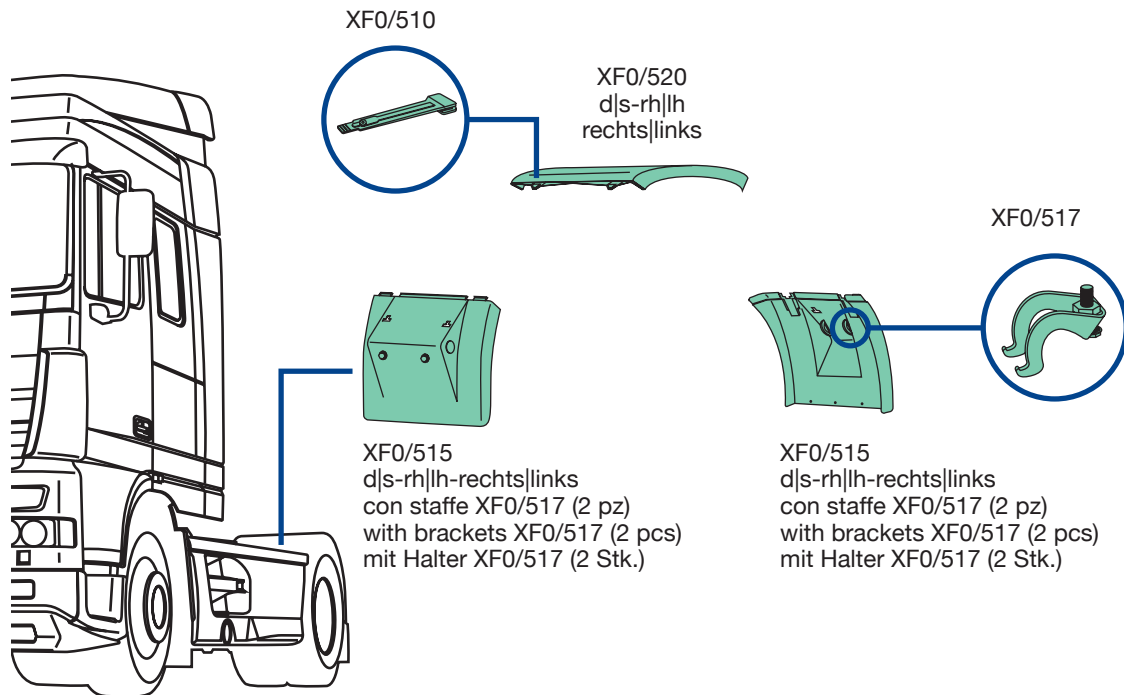

XF0/510
O.E.M. 1340450



XF0/517
O.E.M. 1649588

XF95 SECONDA SERIE | SECOND SERIE | ZWEITE SERIE

XF0/520
O.E.M. 1328935
d|s-rh|lh-rechts|links
grigio scuro, semipiatta, con cinghietti
dark grey, semi-flat, with stretchers
dunkelgrau, halbflach, mit Spanngummi



XF0/515

XF0/515
O.E.M. 1328934
d|s-rh|lh-rechts|links
grigio scuro, senza anti-spray, con staffe
dark grey, without anti-spray, with brackets
dunkelgrau, ohne Spritzschutz, mit Klemme

XF95 | SECONDA SERIE | SECOND SERIE | ZWEITE SERIE

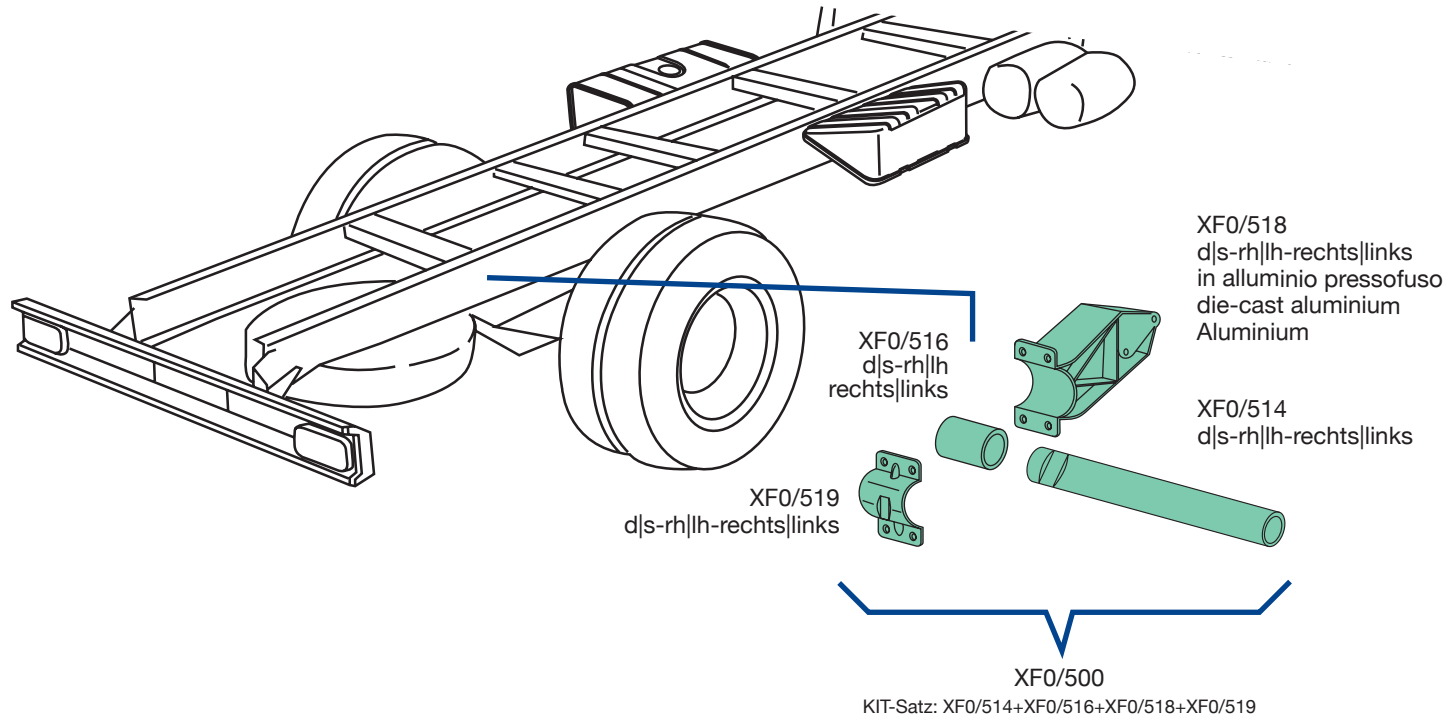

XF0/514
O.E.M. 1610454



XF0/516
O.E.M. 1629045



XF0/518
O.E.M. 2050044



XF0/519
O.E.M. 1629046



XF0/500
O.E.M. 1371224

XF95 SECONDA SERIE | SECOND SERIE | ZWEITE SERIE

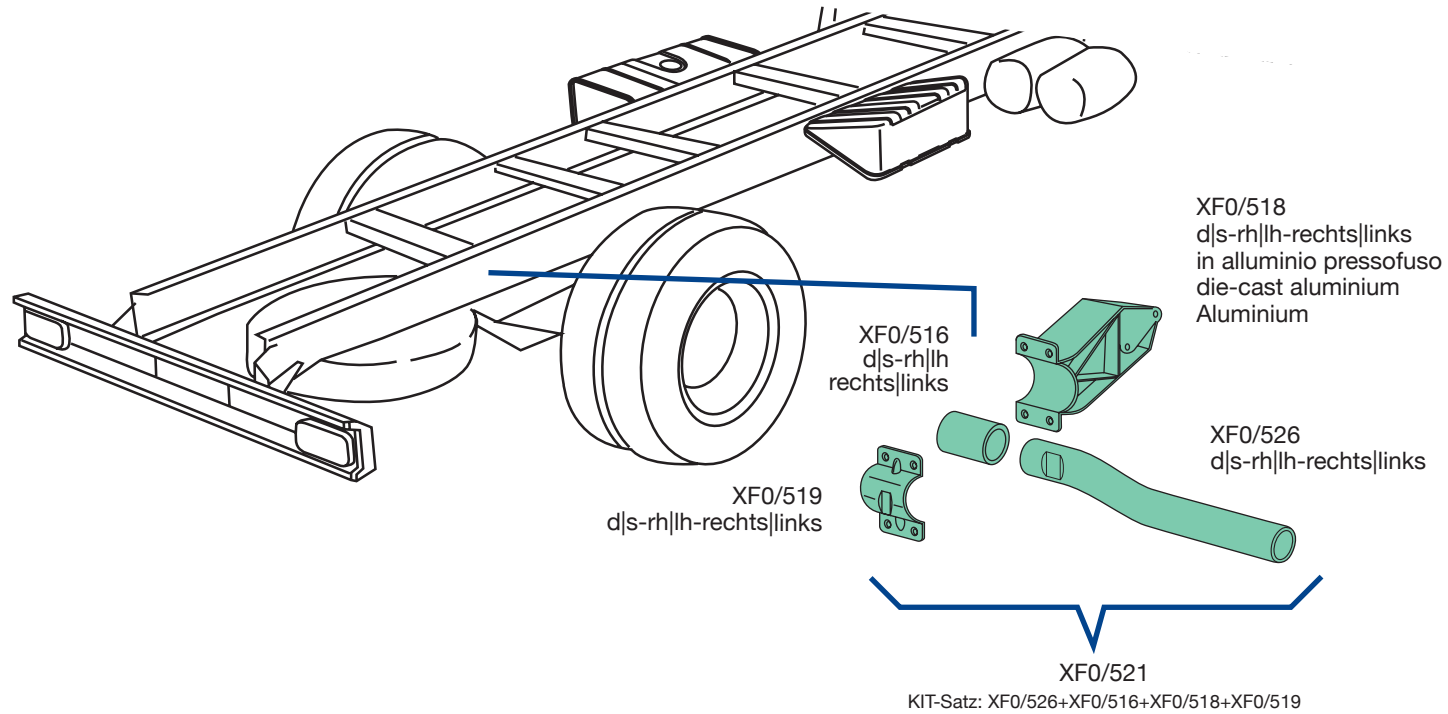

XF0/516
O.E.M. 1629045



XF0/518
O.E.M. 2050044



XF0/519
O.E.M. 1629046



XF0/526
O.E.M. 1629036



XF0/521
O.E.M. 1371226

applicabile a | suitable to | verwendbar für:

XF95 | SECONDA SERIE | SECOND SERIE | ZWEITE SERIE

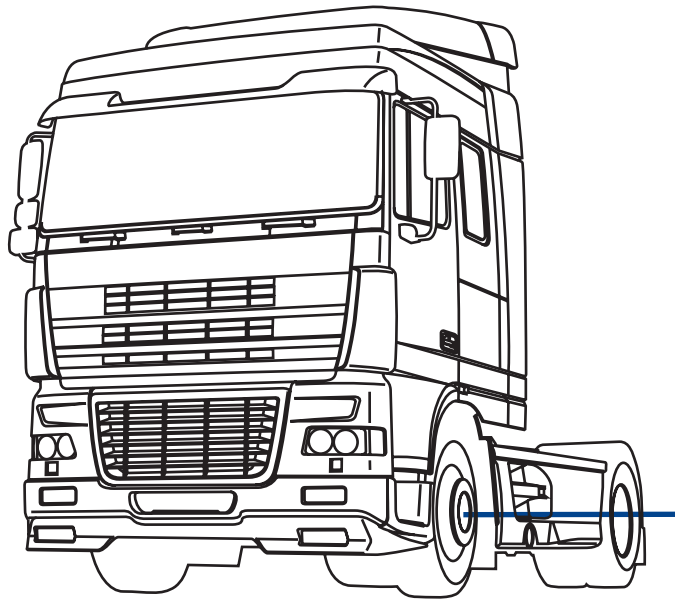

930/032



930/001
d-rh-rechts
930/002
s-lh-links



930/200
d|s-rh|lh
rechts|links

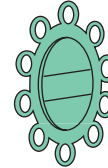

930/100
d-rh-rechts
930/101
s-lh-links



930/032
O.E.M. -



930/001
O.E.M. -
930/002
O.E.M. -



930/100
O.E.M. -
930/101
O.E.M. -

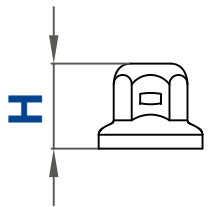

930/200
O.E.M. -

930/032 - Tappo copri bullone-Bolt cover-Radmutterkappe

H	45 mm
Per bulloni \varnothing -bolt \varnothing -Bolzen \varnothing	32 mm
Materiale-Material	acciaio inox-stainless steel Edelstahl
Kg	0,025

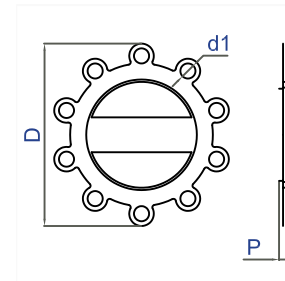
**930/100 d-rh-rechts - 930/101 s-lh-links**

D \varnothing 387 mm	P 30 mm
d1 nr. 10	d1 \varnothing 32 mm
Ventilata	si-yes-Ja
Ventilated-Belüftet	
Colore	cromato e nero-chrome and black
Colours-Farbe	verchromt und schwarz
Materiale-Material	acciaio inox e plastica stainless steel and plastic Edelstahl und Kunststoff
Kg	0,655

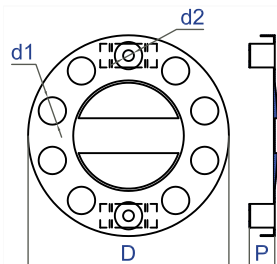
**930/001 d-rh-rechts - 930/002 s-lh-links**

D \varnothing 425 mm	P 50 mm
d1 nr. 10	d1 \varnothing 58 mm
d2 nr. 2	d2 \varnothing 23 mm
Ventilata	si-yes-ja
Ventilated-Belüftet	
Colore	cromato e nero-chrome and black
Colours-Farbe	verchromt und schwarz
Materiale-Material	acciaio inox e plastica stainless steel and plastic Edelstahl und Kunststoff
Kg	1,230

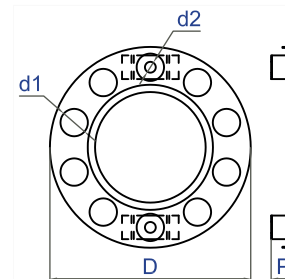
**930/200 d|s-rh|lh-rechts|links**

D \varnothing 425 mm	P 40 mm
d1 nr. 10	d1 \varnothing 58 mm
d2 nr. 2	d2 \varnothing 23 mm
Ventilata	no-nein
Ventilated-Belüftet	
Colore	cromato-chrome-verchromt
Colours-Farbe	
Materiale-Material	acciaio inox-stainless steel Edelstahl
Kg	1,155

applicabile a | suitable to | verwendbar für:

XF95 SECONDA SERIE | SECOND SERIE | ZWEITE SERIE

240/675



240/677

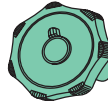

038/678

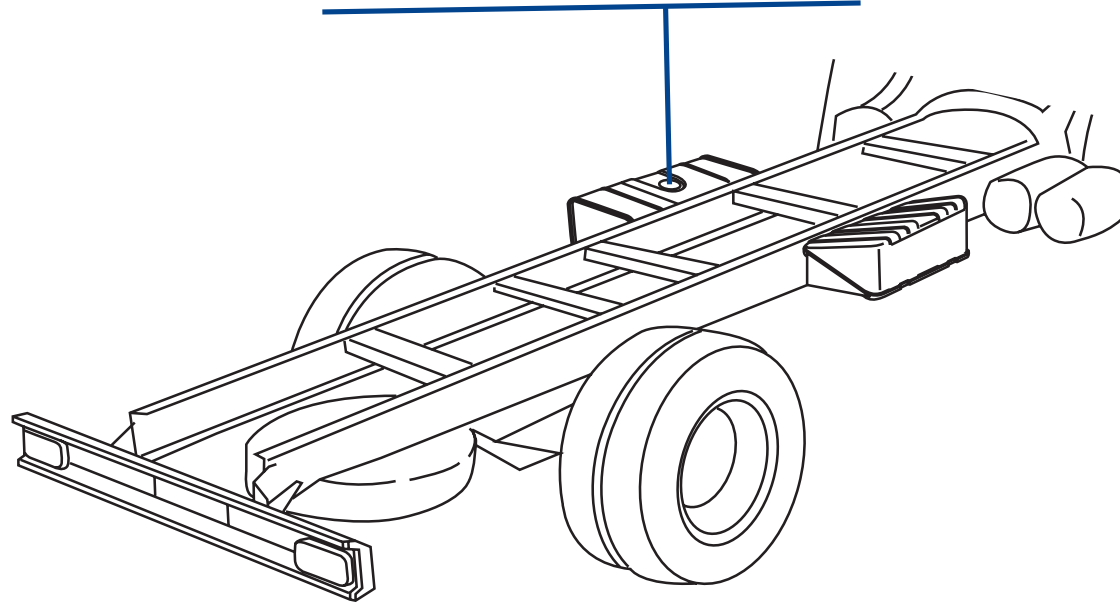
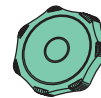

240/675

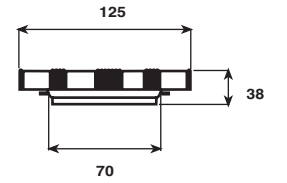

240/677

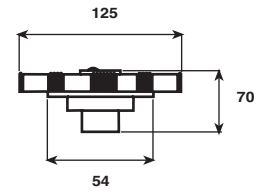

038/678

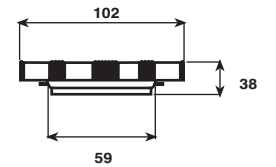

240/675
O.E.M. 41042699



240/677
O.E.M. 500043667



038/678
O.E.M. 4821320

XF95 SECONDA SERIE | SECOND SERIE | ZWEITE SERIE

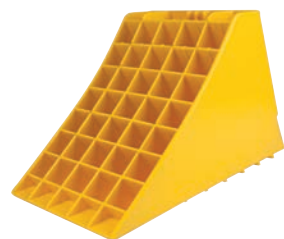
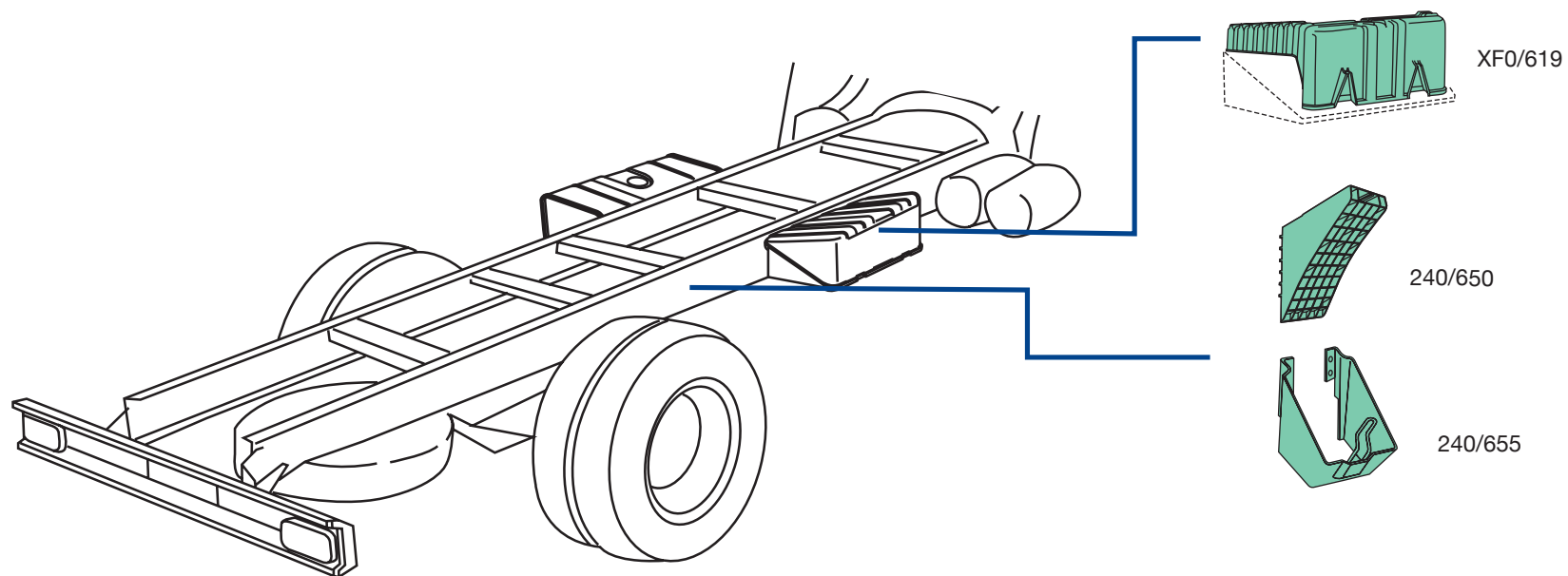

240/650
O.E.M. 99430053



240/655
O.E.M. 41026756



XF0/619
O.E.M. 1745335

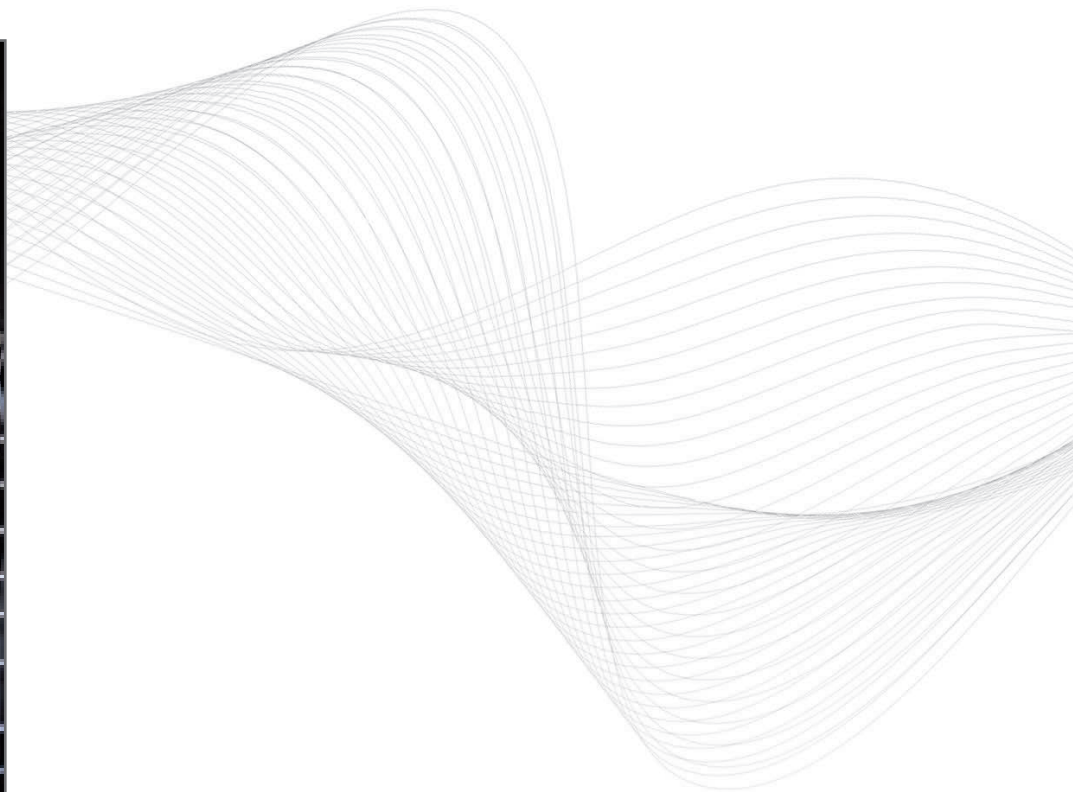

- IT Stampo in acciaio per la produzione di supporto faro DAF XF106
EN Hardened steel mould for head lamp seat DAF XF106 vehicle
DE Gehärtete Stahlform für die Produktion von Scheinwerferstützen für DAF XF106



applicabile a | suitable to | verwendbar für

191

XFO
95XF

PRIMA SERIE | FIRST SERIES | ERSTE SERIE

applicabile a | suitable to | verwendbar für:

95XF PRIMA SERIE | FIRST SERIE | ERSTE SERIE

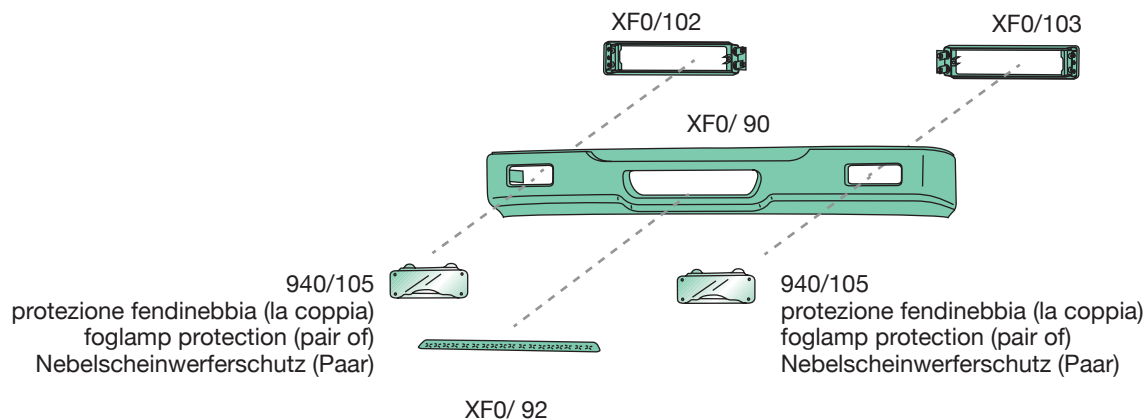
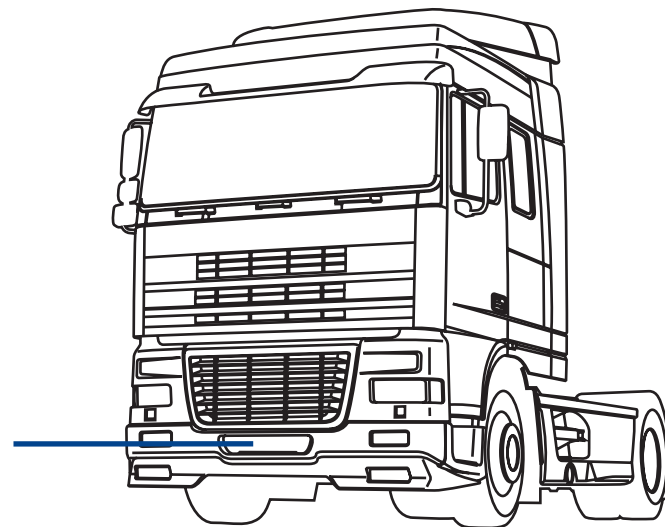

XF0/90
O.E.M. 1290191



XF0/92
O.E.M. 0948779



XF0/102
O.E.M. 1449529
XF0/103
O.E.M. 1449528



940/105
O.E.M. -

95XF PRIMA SERIE | FIRST SERIE | ERSTE SERIE



XF0/ 80
in ferro - iron - Stahl

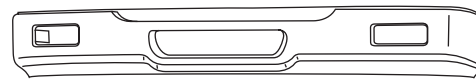
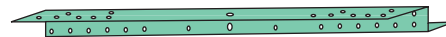

XF0/ 96
completo di minuterie per il fissaggio
with assembly screw kit
mit Befestigungssatz

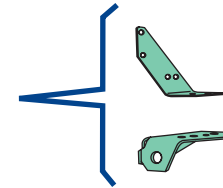

XF0/ 84 d-rh-rechts
XF0/ 85 s-lh-links

XF0/ 86 d-rh-rechts
XF0/ 87 s-lh-links



XF0/ 80
O.E.M. 1427140



XF0/ 96
O.E.M. 1317126



XF0/ 84
O.E.M. 1319679
XF0/ 85
O.E.M. 1319678



XF0/ 86
O.E.M. 1450977
XF0/ 87
O.E.M. 1450976

applicabile a | suitable to | verwendbar für:

95XF PRIMA SERIE | FIRST SERIE | ERSTE SERIE

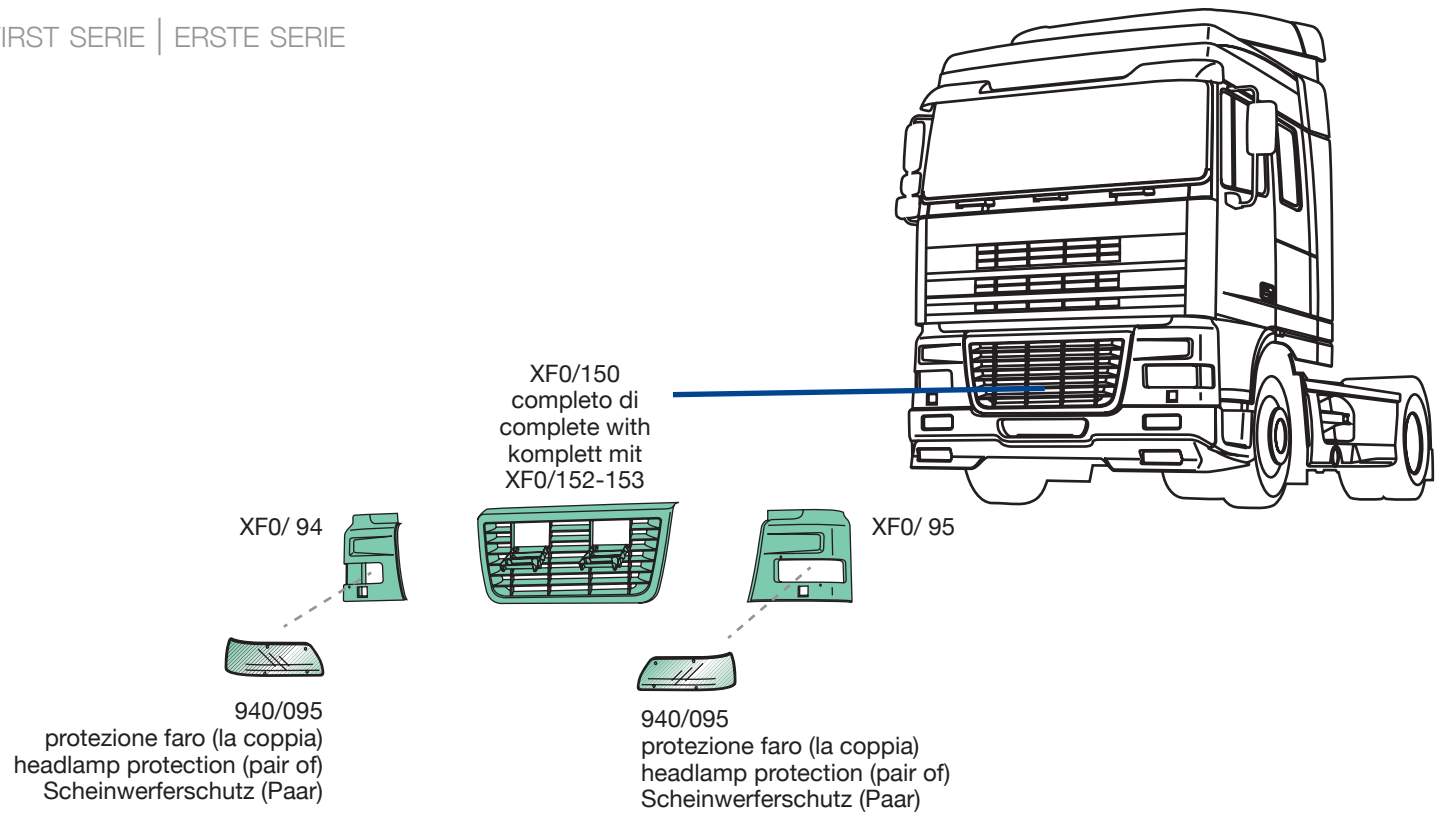

XF0/ 94
O.E.M. 1294949
XF0/ 95
O.E.M. 1294948



XF0/150
O.E.M. 1312789



940/095
O.E.M. -

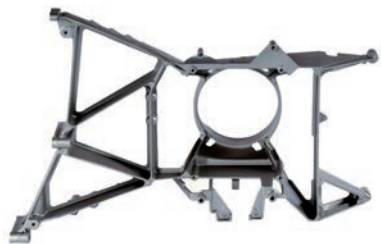
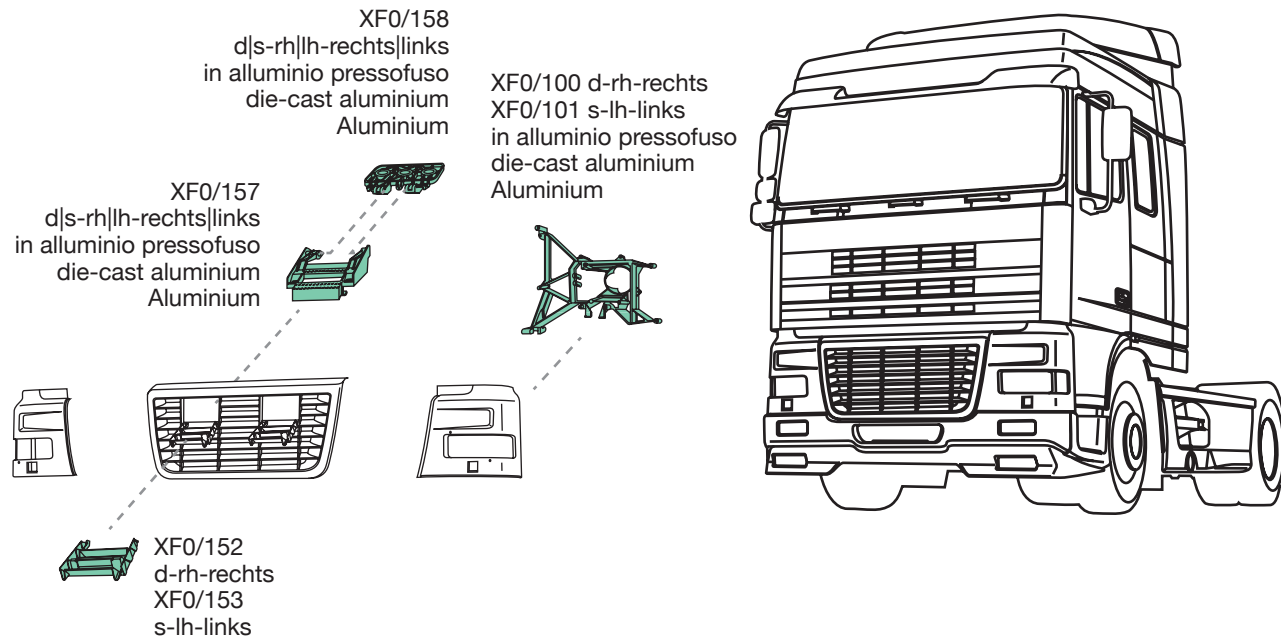

XF0/100
O.E.M. 1308795
XF0/101
O.E.M. 1308794



XF0/152
O.E.M. 1309113
XF0/153
O.E.M. 1309112

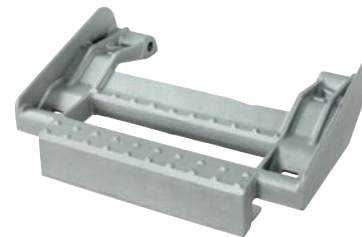

XF0/157
O.E.M. 1689404



XF0/158
O.E.M. 1735004

applicabile a | suitable to | verwendbar für:

95XF PRIMA SERIE | FIRST SERIE | ERSTE SERIE

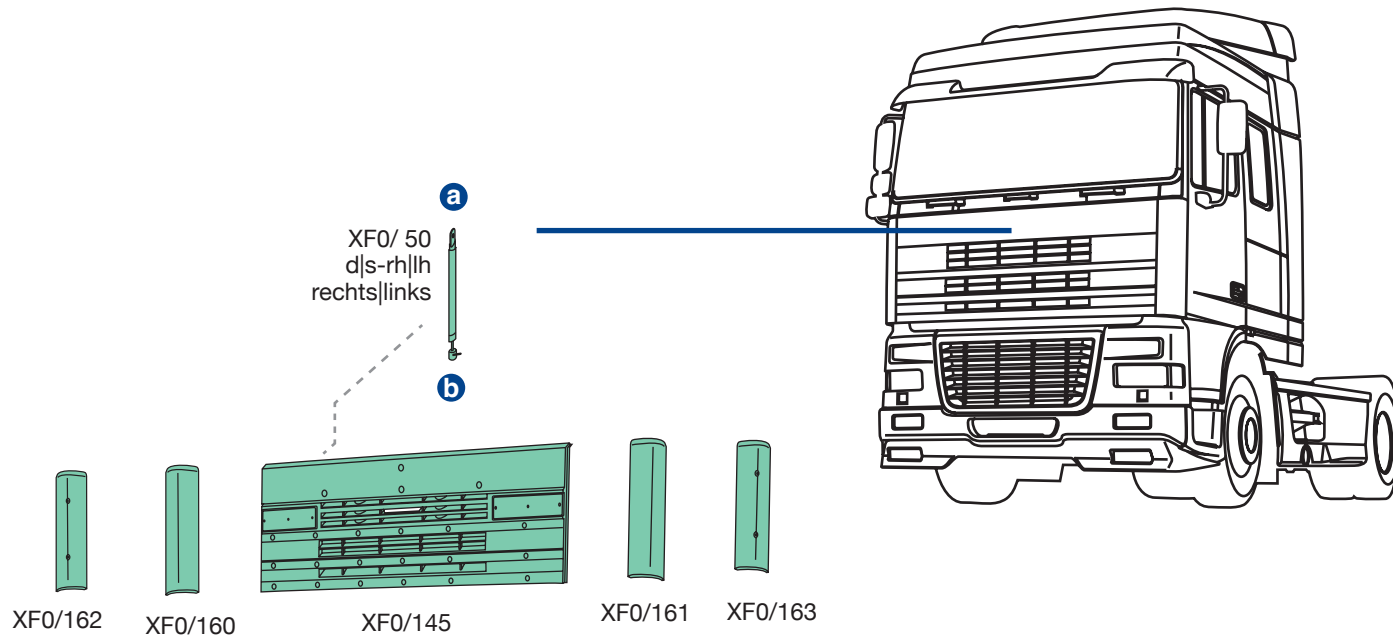

XF0/ 50
O.E.M. 1238280

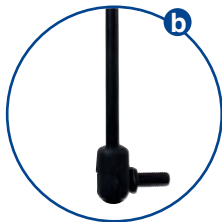

XF0/145
O.E.M. 1309400



XF0/160
O.E.M. 1302984
XF0/161
O.E.M. 1302983



XF0/162
O.E.M. 1299418
XF0/163
O.E.M. 1299417

PDS/360

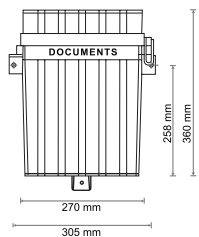

applicabile a I suitable to I verwendbar für:

95XF PRIMA SERIE | FIRST SERIE | ERSTE SERIE

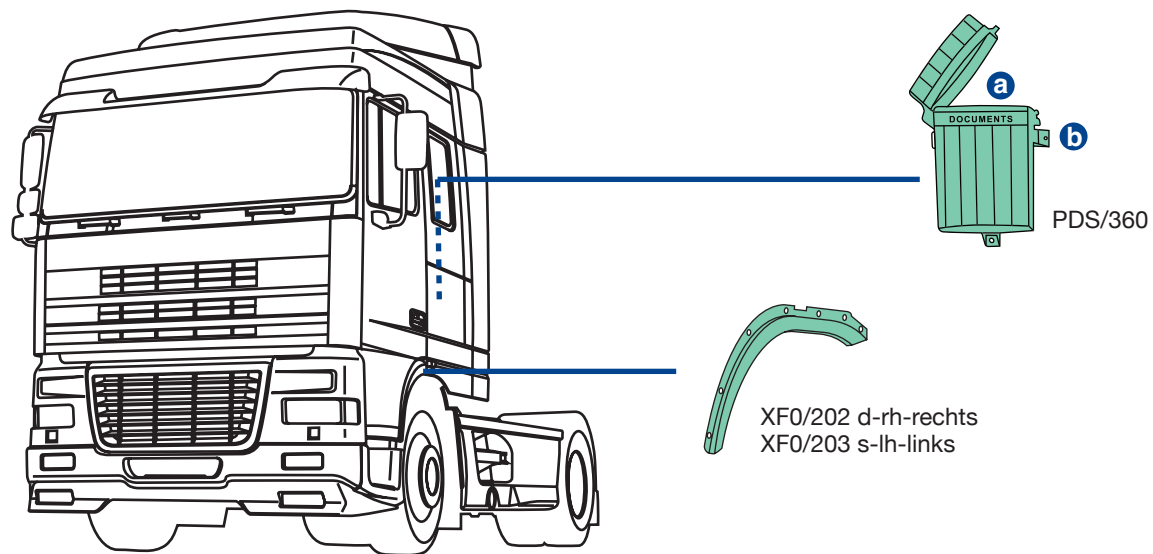

XF0/202
O.E.M. 1291165
XF0/203
O.E.M. 1291164



PDS/360
O.E.M. -

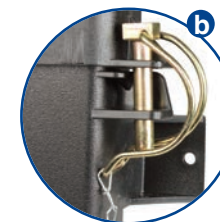

applicabile a | suitable to | verwendbar für:

95XF PRIMA SERIE | FIRST SERIE | ERSTE SERIE

(*) Vernice di fondo - Unprocessed - Grundiert
(°) Verniciato grigio - Grey painted - Grau lackiert

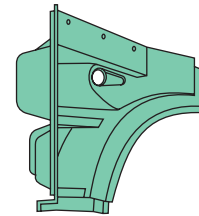
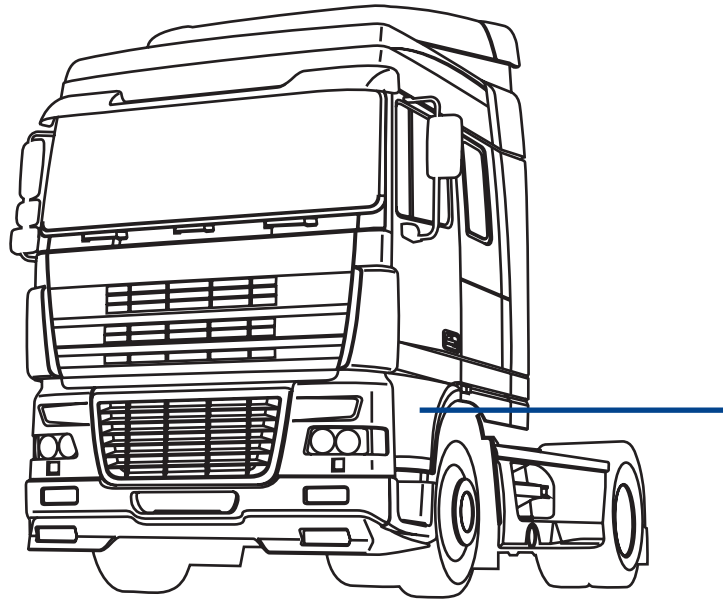

XF0/200 d-rh-rechts (°)
XF0/201 s-lh-links (°)



XF0/240 d-rh-rechts (*)
XF0/241 s-lh-links (*)

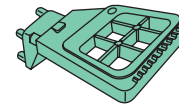

XF2/238 d-rh-rechts
XF2/239 s-lh-links
in alluminio pressofuso
die-cast aluminium
Aluminium



XF0/200
O.E.M. 1809266
XF0/201
O.E.M. 1809265



XF0/240
O.E.M. 1295735
XF0/241
O.E.M. 1295732



XF2/238
O.E.M. 1347132
XF2/239
O.E.M. 1347131

95XF PRIMA SERIE | FIRST SERIE | ERSTE SERIE

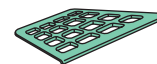
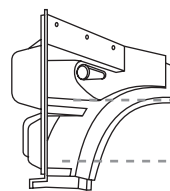

XF0/210
d|s-rh|lh-rechts|links

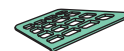

XF0/212
d|s-rh|lh-rechts|links

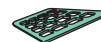
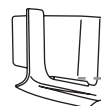

XF0/215
d|s-rh|lh-rechts|links

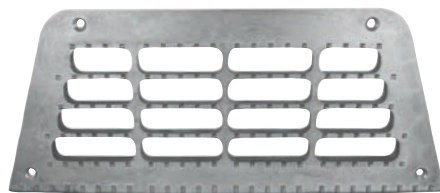

XF0/210
O.E.M. 0673144

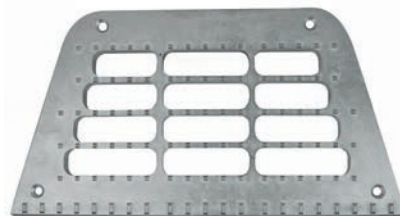

XF0/212
O.E.M. 0673143



XF0/215
O.E.M. 0962643

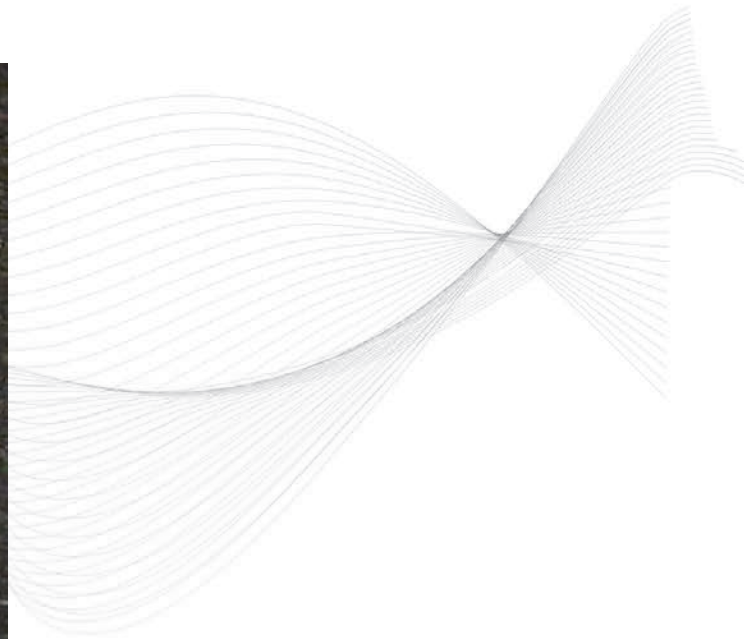
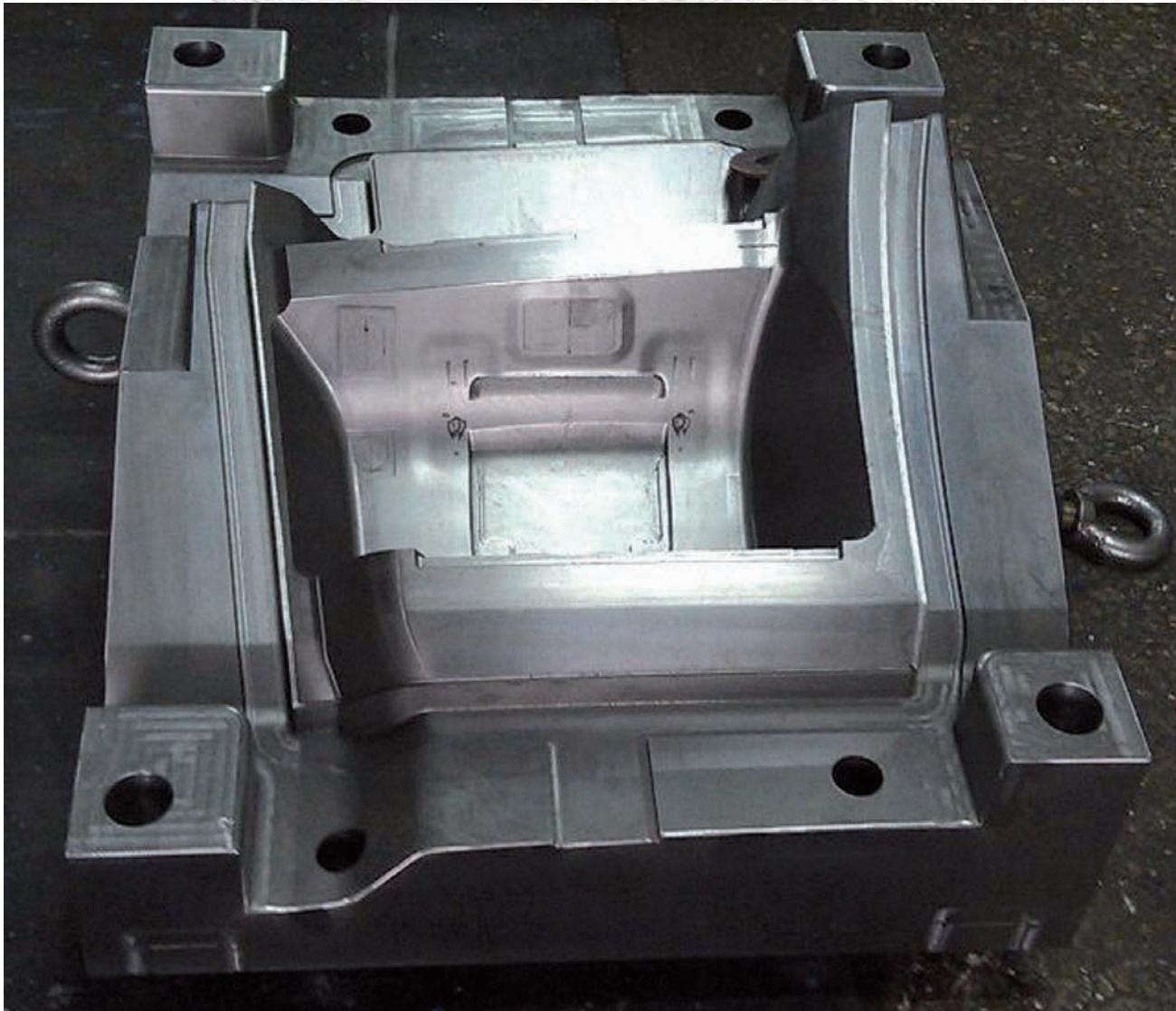

IT Stampo in acciaio temprato per la produzione di pedane
EN Hardened steel mold for footboard production
DE Gehärtete Stahlform für Einstieg Produktion



XFO/400

O.E. 1286384

Adattabile a:
Suitable to:
passend für:

DAF 95XF - XF95 - XF105
tetto alto - high roof
hohes Dach

Materiale - Material - Material:
PMMA - Acrylglas

KIT completo di staffe e minuterie
IN ALLESTIMENTO
KIT complete of brackets and findings
NOT AVAILABLE YET
Befestigungssatz
IN ARBEIT



L	H	P	kg.
cm.	cm.	cm.	
240	19	21,5	1,870

applicabile a | suitable to | verwendbar für:

95XF PRIMA SERIE | FIRST SERIE | ERSTE SERIE



XFO/405

O.E. 1300557

Adattabile a:
Suitable to:
passend für:

DAF 95XF - XF95
XF105 space cab
tetto medio - medium roof
mittelhohes Dach

Materiale - Material - Material:
PMMA - Acrylglas



XFO/480

O.E. 1311766

KIT completo
di staffe
e minuterie.
Assembly KIT.
Befestigungssatz



L	H	P	kg.
cm.	cm.	cm.	
236	25	20	3,600



L'immagine del prodotto è da considerarsi puramente indicativa | The product image is just for information | Die Produktbilder sind nur zur Information.

XF0/425

O.E. 1651597

Adattabile a:
Suitable to:
passend für:

**DAF 95XF - XF95
XF105 super space cab**

Materiale - Material - Material:
PMMA - Acrylglas



KIT completo di staffe e minuterie
IN ALLESTIMENTO
KIT complete of brackets and findings
NOT AVAILABLE YET
Befestigungssatz
IN ARBEIT



L	H	P	kg.
cm.	cm.	cm.	
252	35	19,5	2,305

applicabile a I suitable to I verwendbar für:

95XF PRIMA SERIE | FIRST SERIE | ERSTE SERIE



XF0/502

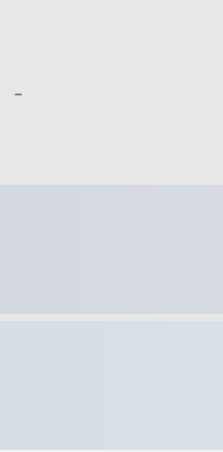

II (E4) 024096
189x368 mm



IV (E4) 024097
204x195 mm

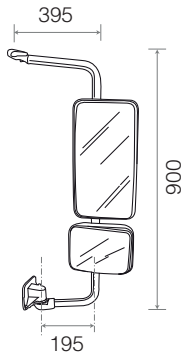

applicabilità:
applicable to:
Verwendbar für

DAF 95XF 2000 →
DAF XF95 →2006

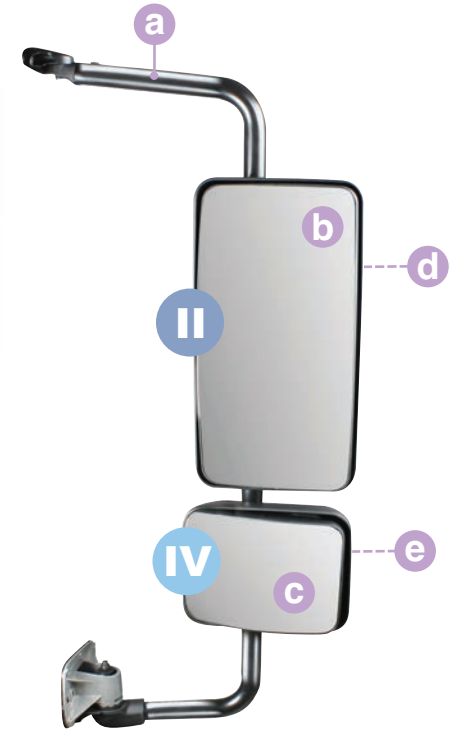

COVIND

XF0/525

1610184*
(1425105)*



203x380 mm

XF0/524

1610189



216x167 mm

* OEM R1800_COVIND R1200 | OEM R400_COVIND R300 (view legenda)

a	XF0/512	1425118			280x900 mm
b	XF0/504	1610190* (1425109)*			E4 024096 189x368 mm
c	XF0/505	1610182			E4 024097 204x195 mm
IV					
d	XF0/507	1425113			187x367 mm
e	XF0/508	1425114			202x151 mm
IV					

applicabile a I suitable to I verwendbar für:

95XF PRIMA SERIE | FIRST SERIE | ERSTE SERIE



XF0/503

1610263
(1397137)



|| E4 024096
189x368 mm

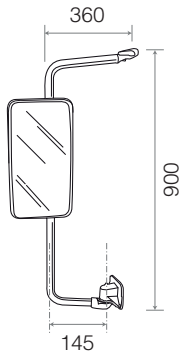

applicabilità:
applicable to:
Verwendbar für

DAF 95XF 2000→
DAF XF95→2006

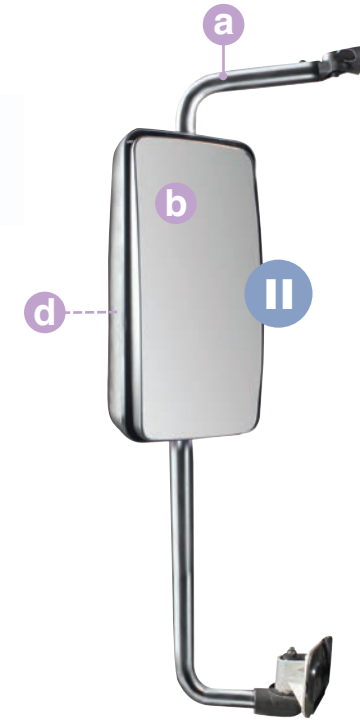

COVIND

XF0/525

1610184*
(1425105)*



203x380 mm

||

* OEM R1800_COVIND R1200 | OEM R1400_COVIND R300 (view legenda)

a XF0/513

1425116



235x900mm

b XF0/504

1610190*
(1425109)*



E4 024096

189x368 mm

d XF0/507

1425113



187x367mm

applicabile a | suitable to | verwendbar für:

95XF PRIMA SERIE | FIRST SERIE | ERSTE SERIE

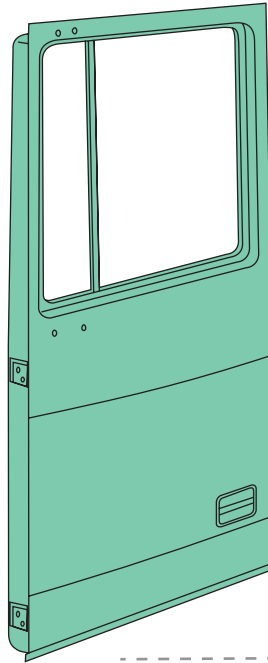

XF0/ 2 d-rh-rechts
XF0/ 3 s-lh-links
senza cerniere
without hinges
ohne Türscharniere

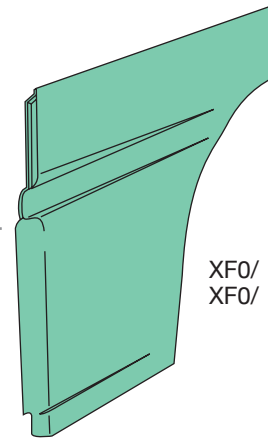

XF0/ 4 d-rh-rechts
XF0/ 5 s-lh-links



XF0/ 2
O.E.M. 1676219
XF0/ 3
O.E.M. 1676218



XF0/ 4
O.E.M. 1295620
XF0/ 5
O.E.M. 1295619

95XF PRIMA SERIE | FIRST SERIE | ERSTE SERIE

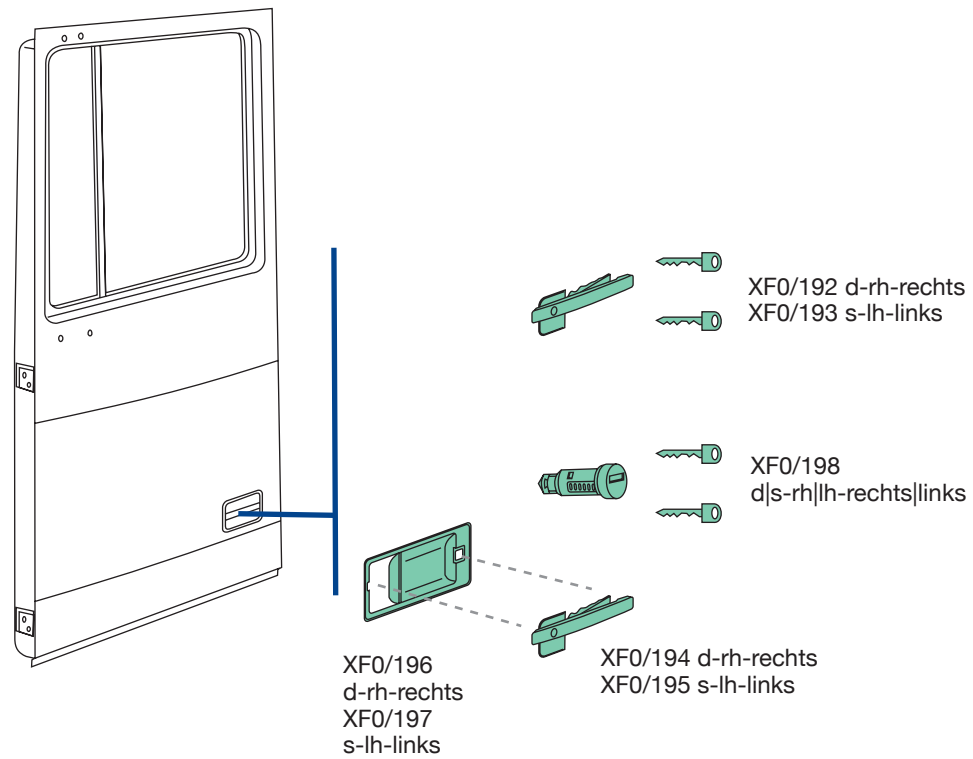

XF0/192
O.E.M. -
XF0/193
O.E.M. -



XF0/194
O.E.M. 1305482
XF0/195
O.E.M. 1305481



XF0/196
O.E.M. 1305480
XF0/197
O.E.M. 1305479



XF0/198
O.E.M. 1336529

applicabile a | suitable to | verwendbar für:

95XF PRIMA SERIE | FIRST SERIE | ERSTE SERIE

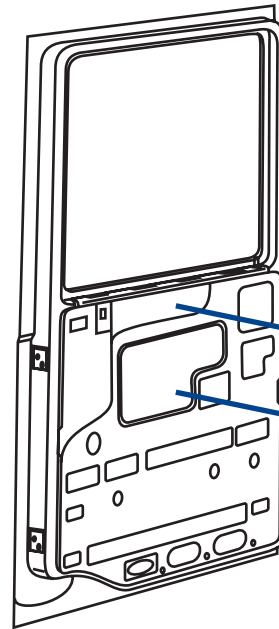

XF0/175 d-rh-rechts
XF0/176 s-lh-links
completa di leva
complete with lever
komplett mit Knauf und Hebel

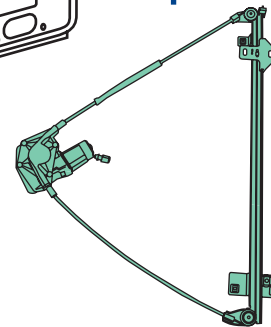

XF0/164 d-rh-rechts
XF0/165 s-lh-links
elettrico con motorino
electric with motor
elektrisch mit Motor



XF0/164
O.E.M. 1354703
XF0/165
O.E.M. 1354702



XF0/175
O.E.M. 1309408+1354697
XF0/176
O.E.M. 1309407+1354696

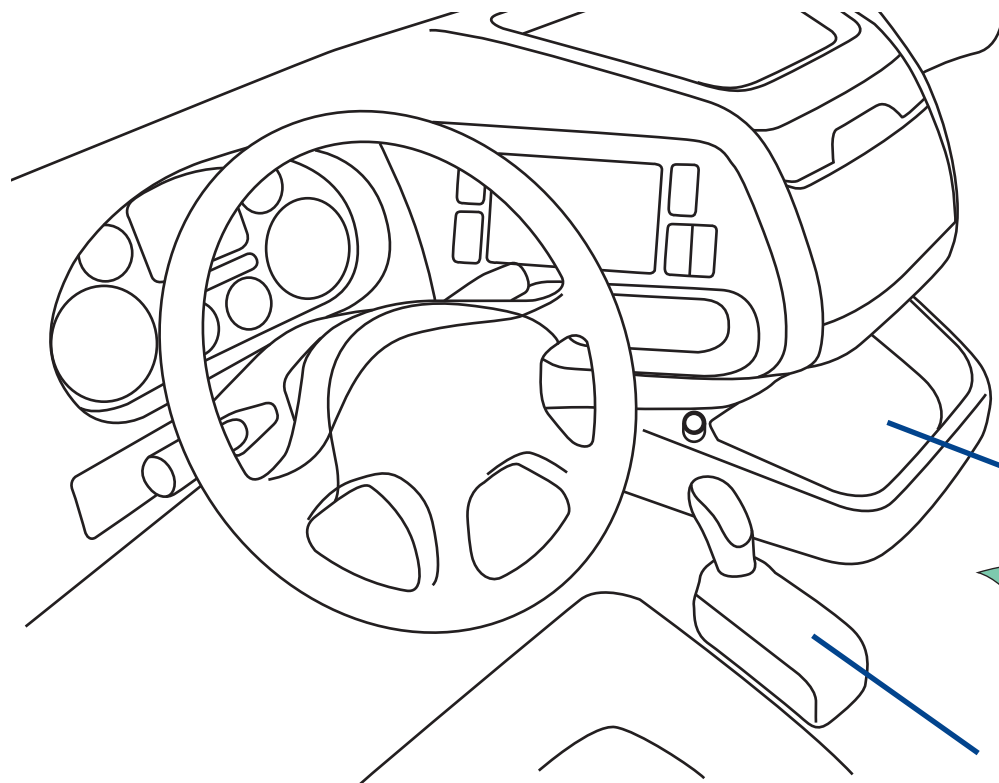

XF0/415

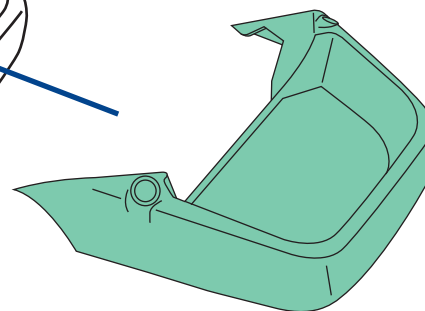

XF0/410

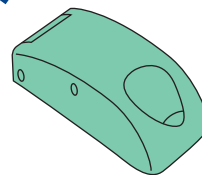

XF0/410
O.E.M. 1642302



XF0/415
O.E.M. 1334620

95XF PRIMA SERIE | FIRST SERIE | ERSTE SERIE

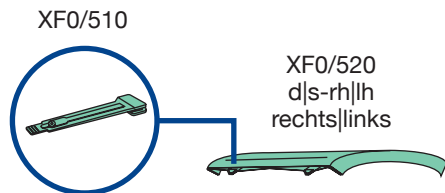

XF0/510

XF0/520
d|s-rh|lh
rechts|links

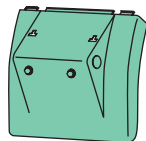

XF0/515
d|s-rh|lh-rechts|links
con staffe XF0/517 (2 pz)
with brackets XF0/517 (2 pcs)
mit Halter XF0/517 (2 Stk.)

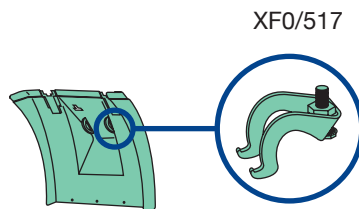

XF0/517

XF0/515
d|s-rh|lh-rechts|links
con staffe XF0/517 (2 pz)
with brackets XF0/517 (2 pcs)
mit Halter XF0/517 (2 Stk.)

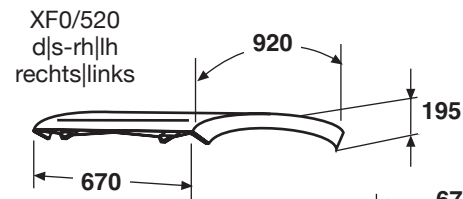

XF0/520
d|s-rh|lh
rechts|links

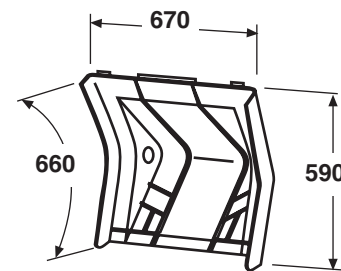
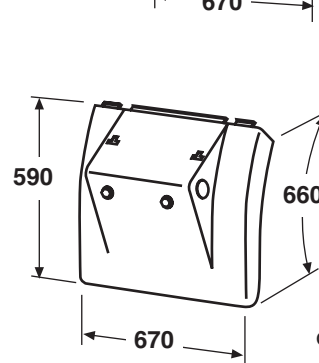

XF0/515
d|s-rh|lh-rechts|links



XF0/510
O.E.M. 1340450



XF0/517
O.E.M. 1649588

XF0/520
O.E.M. 1328935
d|s-rh|lh-rechts|links
grigio scuro, semipiatta, con cinghietti
dark grey, semi-flat, with stretchers
dunkelgrau, halbflach, mit Spanngummi



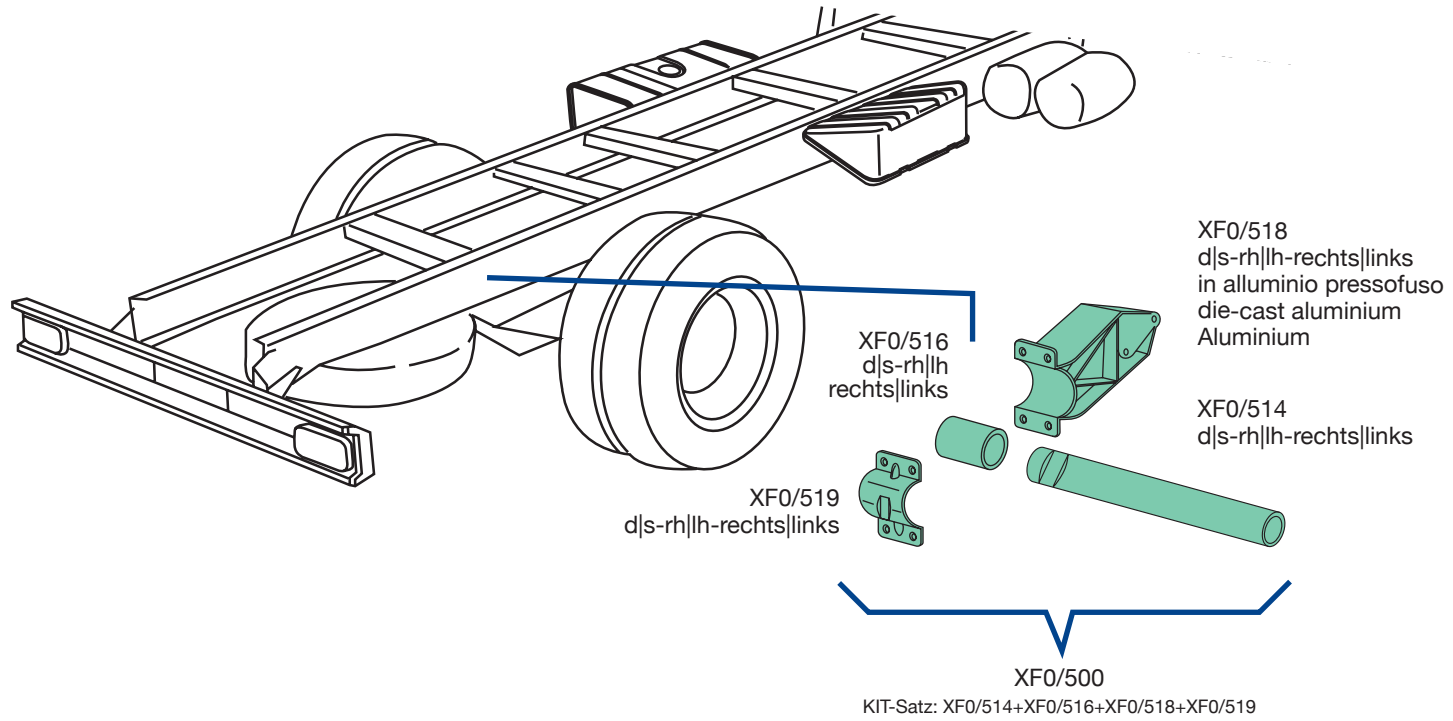

XF0/514
O.E.M. 1610454



XF0/516
O.E.M. 1629045



XF0/518
O.E.M. 2050044



XF0/519
O.E.M. 1629046



XF0/500
O.E.M. 1371224

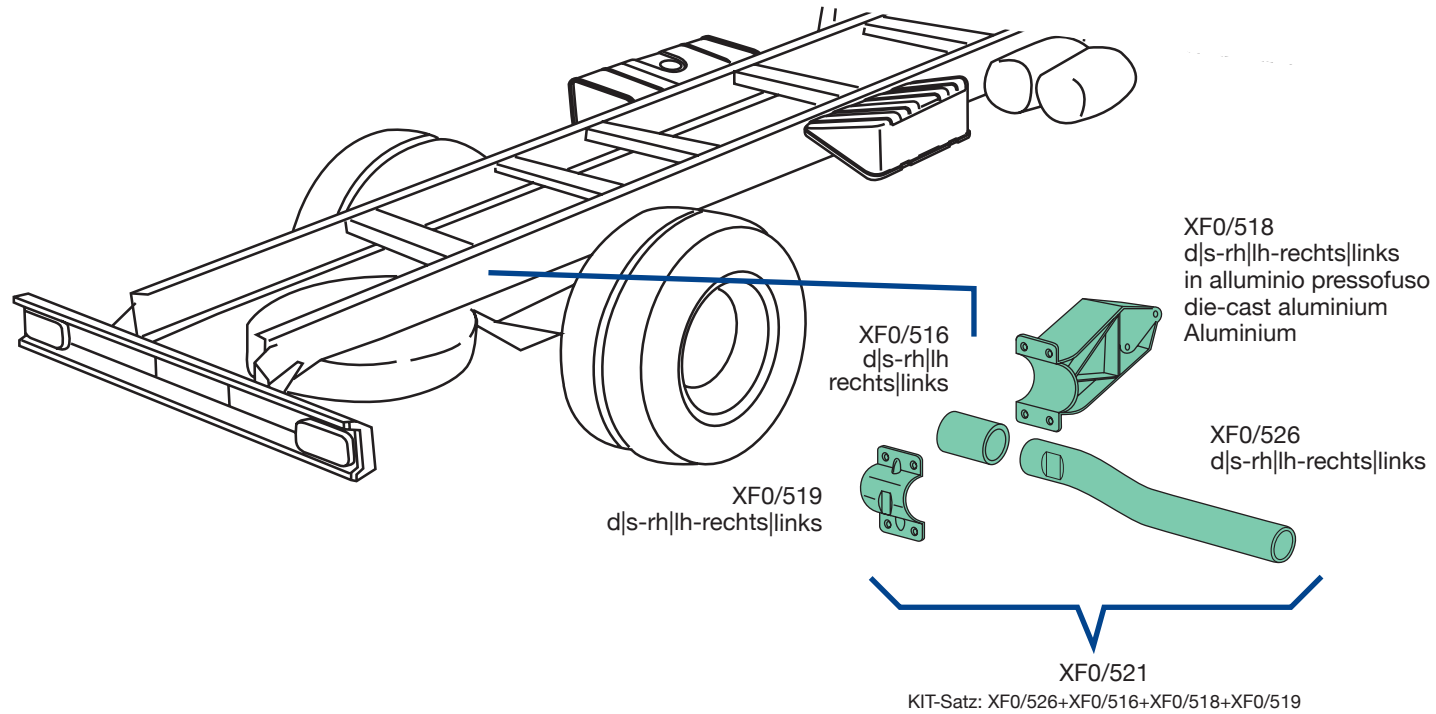

XF0/516
O.E.M. 1629045



XF0/518
O.E.M. 2050044



XF0/519
O.E.M. 1629046



XF0/526
O.E.M. 1629036



XF0/521
O.E.M. 1371226

applicabile a | suitable to | verwendbar für:

95XF PRIMA SERIE | FIRST SERIE | ERSTE SERIE

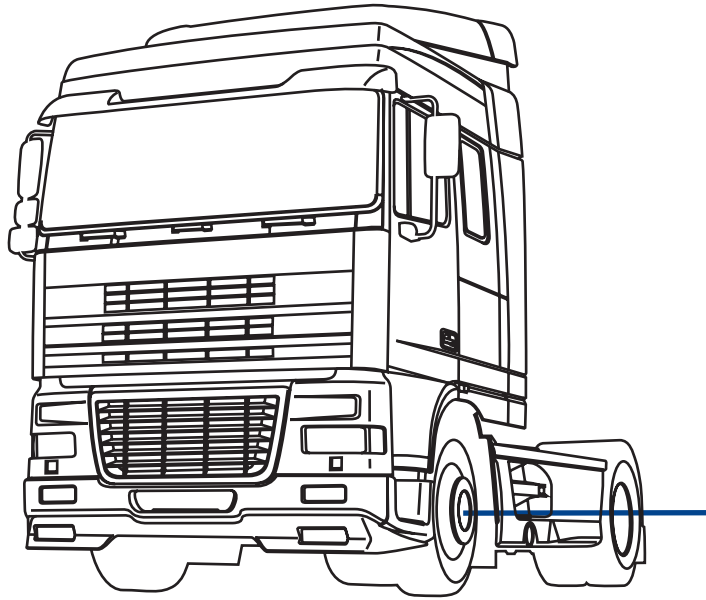

930/032



930/001
d-rh-rechts
930/002
s-lh-links



930/200
d|s-rh|lh
rechts|links

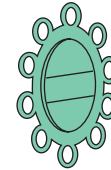

930/100
d-rh-rechts
930/101
s-lh-links



930/032
O.E.M. -



930/001
O.E.M. -
930/002
O.E.M. -



930/100
O.E.M. -
930/101
O.E.M. -

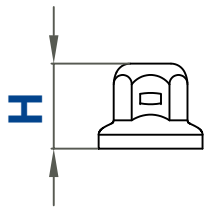

930/200
O.E.M. -

930/032 - Tappo copri bullone-Bolt cover-Radmutterkappe

H	45 mm
Per bulloni \varnothing -bolt \varnothing -Bolzen \varnothing	32 mm
Materiale-Material	acciaio inox-stainless steel Edelstahl
Kg	0,025

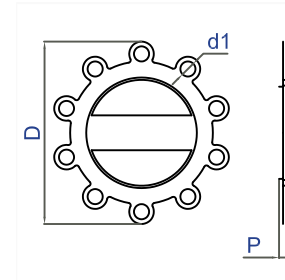
**930/100 d-rh-rechts - 930/101 s-lh-links**

D \varnothing 387 mm	P 30 mm
d1 nr. 10	d1 \varnothing 32 mm
Ventilata	si-yes-Ja
Ventilated-Belüftet	
Colore	cromato e nero-chrome and black
Colours-Farbe	verchromt und schwarz
Materiale-Material	acciaio inox e plastica stainless steel and plastic Edelstahl und Kunststoff
Kg	0,655

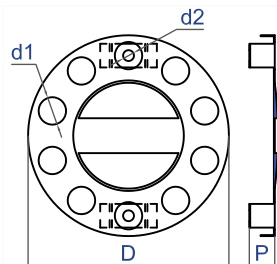
**930/001 d-rh-rechts - 930/002 s-lh-links**

D \varnothing 425 mm	P 50 mm
d1 nr. 10	d1 \varnothing 58 mm
d2 nr. 2	d2 \varnothing 23 mm
Ventilata	si-yes-ja
Ventilated-Belüftet	
Colore	cromato e nero-chrome and black
Colours-Farbe	verchromt und schwarz
Materiale-Material	acciaio inox e plastica stainless steel and plastic Edelstahl und Kunststoff
Kg	1,230

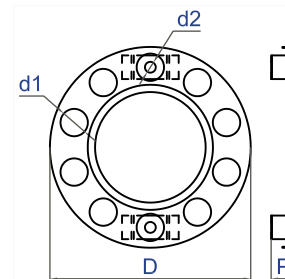
**930/200 d|s-rh|lh-rechts|links**

D \varnothing 425 mm	P 40 mm
d1 nr. 10	d1 \varnothing 58 mm
d2 nr. 2	d2 \varnothing 23 mm
Ventilata	no-nein
Ventilated-Belüftet	
Colore	cromato-chrome-verchromt
Colours-Farbe	
Materiale-Material	acciaio inox-stainless steel Edelstahl
Kg	1,155

applicabile a | suitable to | verwendbar für:

95XF PRIMA SERIE | FIRST SERIE | ERSTE SERIE

240/675

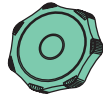

240/677

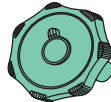

038/678

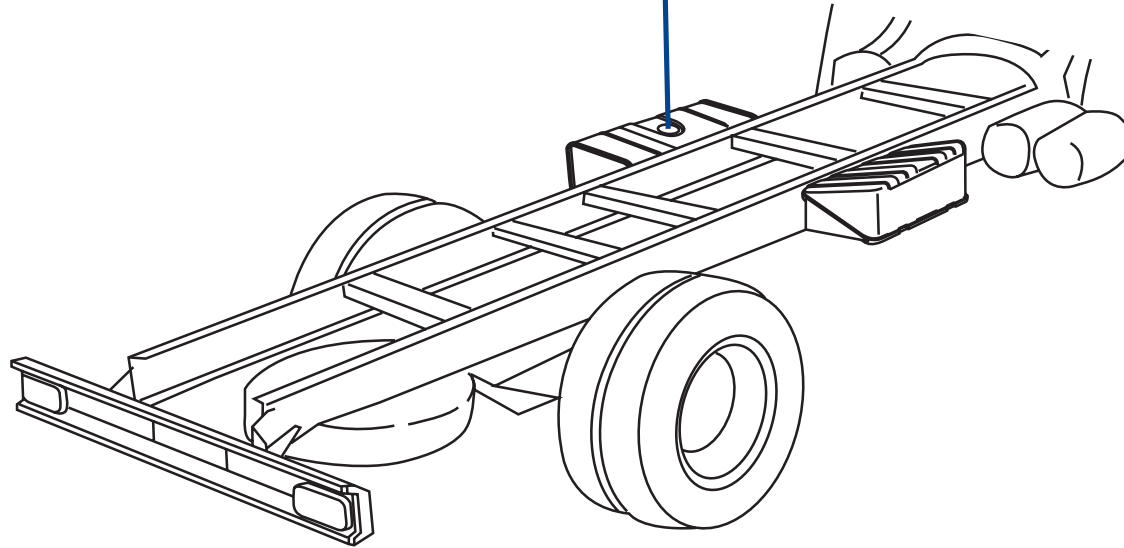

240/675

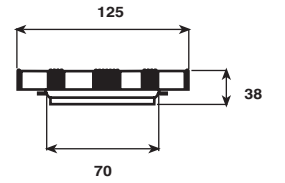

240/677

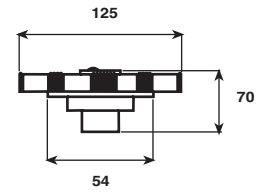

038/678

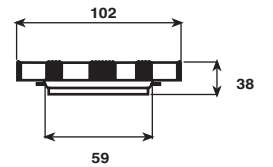

240/675
O.E.M. 41042699



240/677
O.E.M. 500043667



038/678
O.E.M. 4821320

95XF PRIMA SERIE | FIRST SERIE | ERSTE SERIE

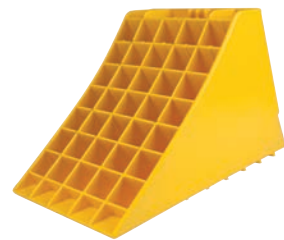
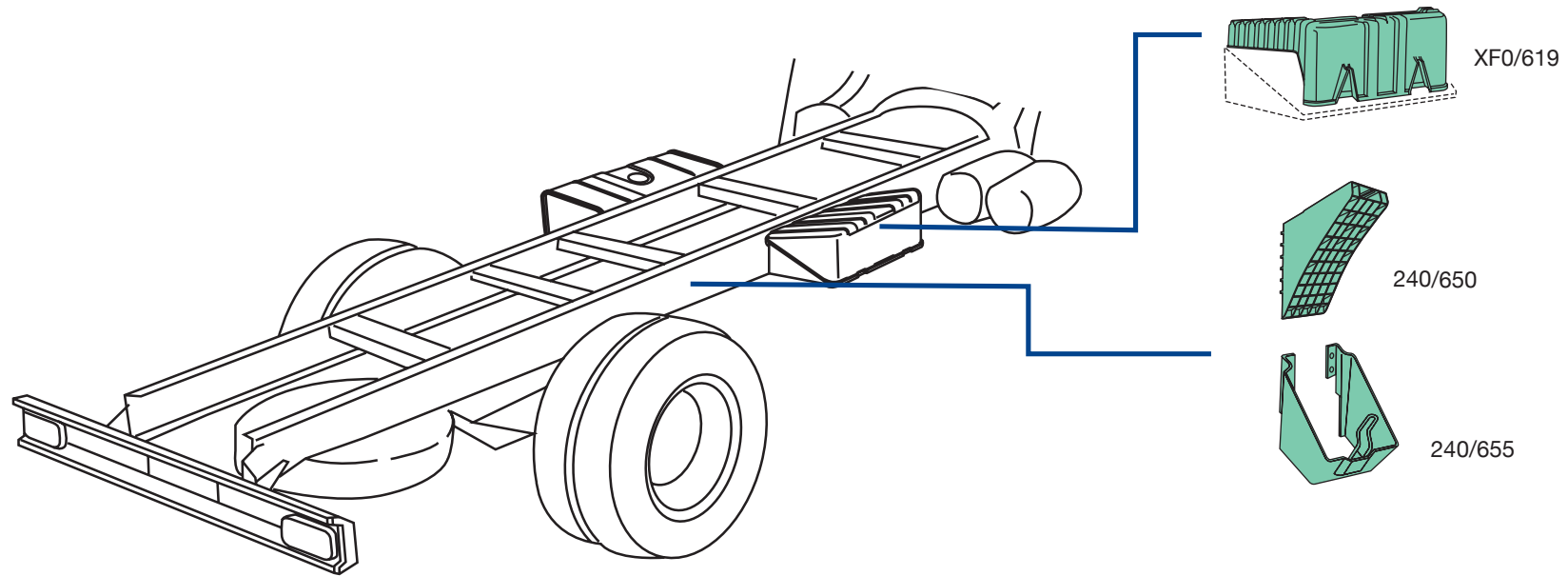

240/650
O.E.M. 99430053



240/655
O.E.M. 41026756



XF0/619
O.E.M. 1745335

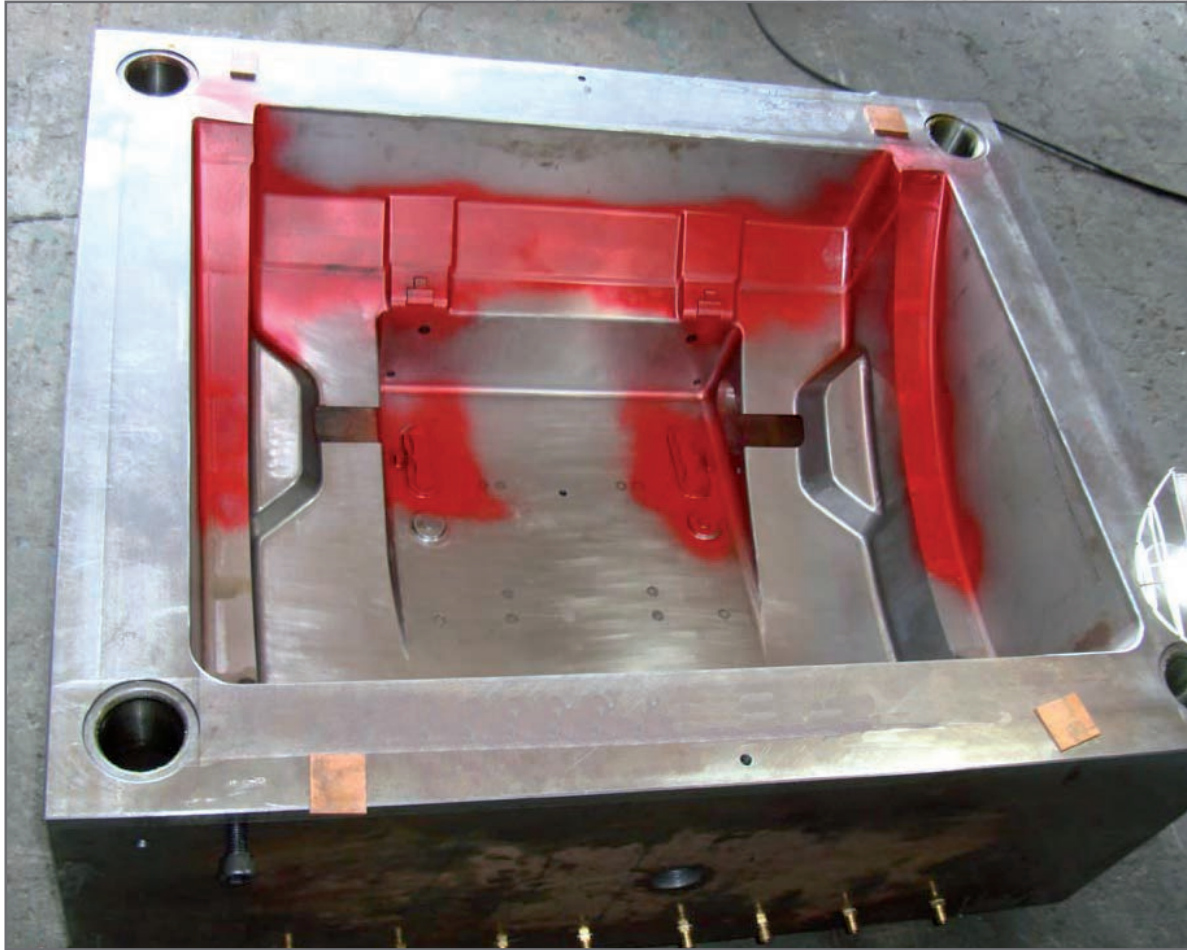

IT Stampo per lo stampaggio ad iniezione di un semiparafango posteriore

EN Mould for the production of the rear mudguard

DE Form zum Spritzgießen des Hinterachskotflügels

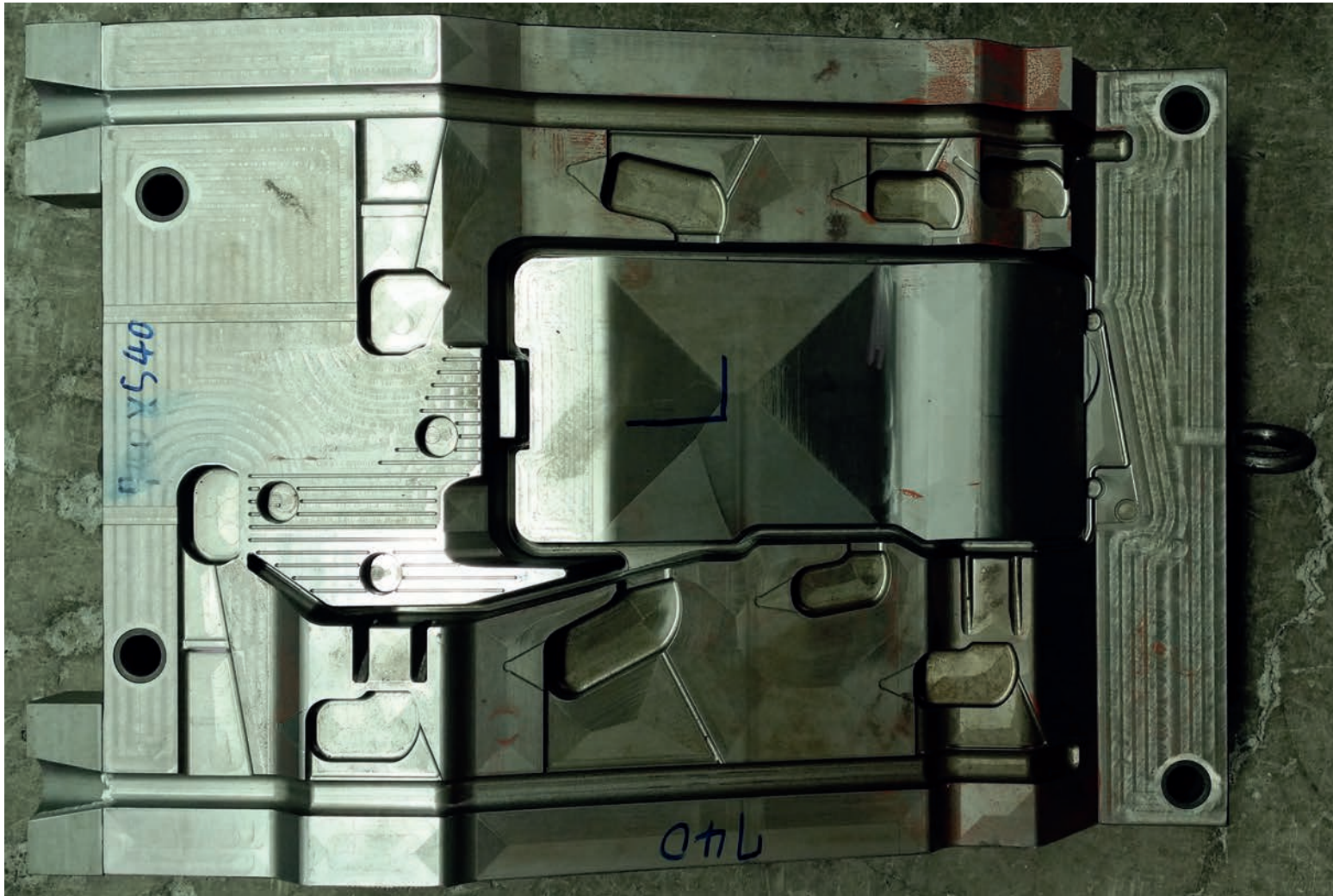



- ▲
- IT Stampo in acciaio a iniezione per la produzione di griglia radiatore Daf LF euro 6
 - EN Steel injection moulding for the manufacturing of the radiator grill of the DAF LF Euro6
 - DE Spritzgusswerkzeug aus Stahl für die Herstellung des Kühlergitters des DAF LF Euro6

COVIND SPA

SERVIZIO VENDITE ITALIA DOMESTIC SALES DPT.

 +39 011 8965702

 +39 011 8965714

 +39 011 8965719

 +39 011 8965756

E.MAIL vendite@covind.it

SERVIZIO VENDITE ESTERO INTERNATIONAL SALES DPT.

 +39 011 8965722

 +39 011 8965735

 +39 011 8965759

 +39 011 8005149

E.MAIL export@covind.it

COVIND S.P.A.

Strada della Cebrosa, 68-70-72

10036 Settimo Torinese (TO) - ITALY

☎ +39 011 8965711

☎ +39 011 8977830

✉ marketing@covind.it

www.covind.it

COVIND COV
IND COVIND
COVIND COV
IND COVIND
COVIND COV
IND COVIND
COVIND COV

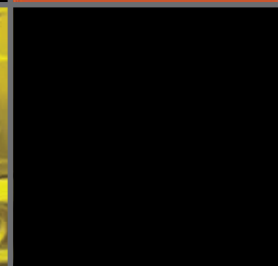

MOD7DAF02