

**CEI**

HIGH FIDELITY SPARE PARTS

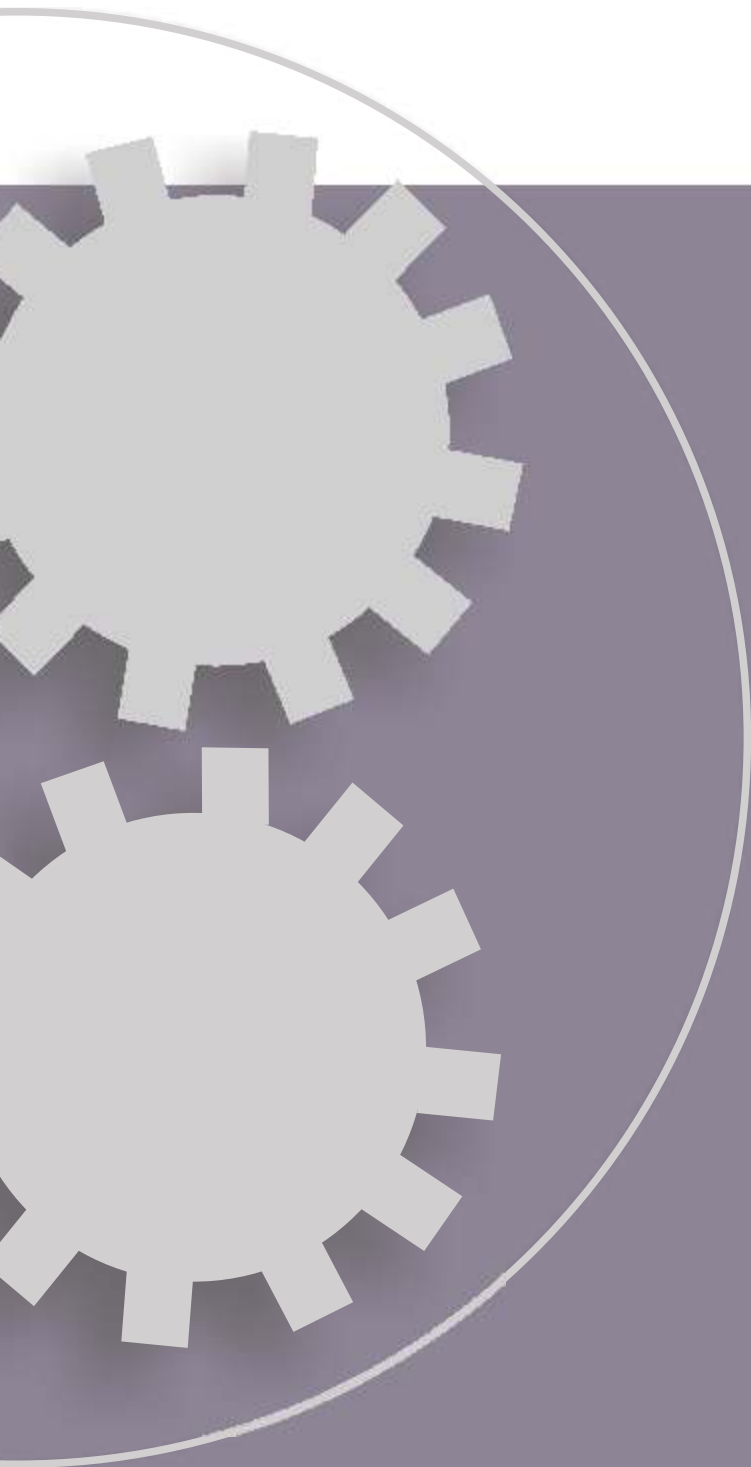

# DAF Axles

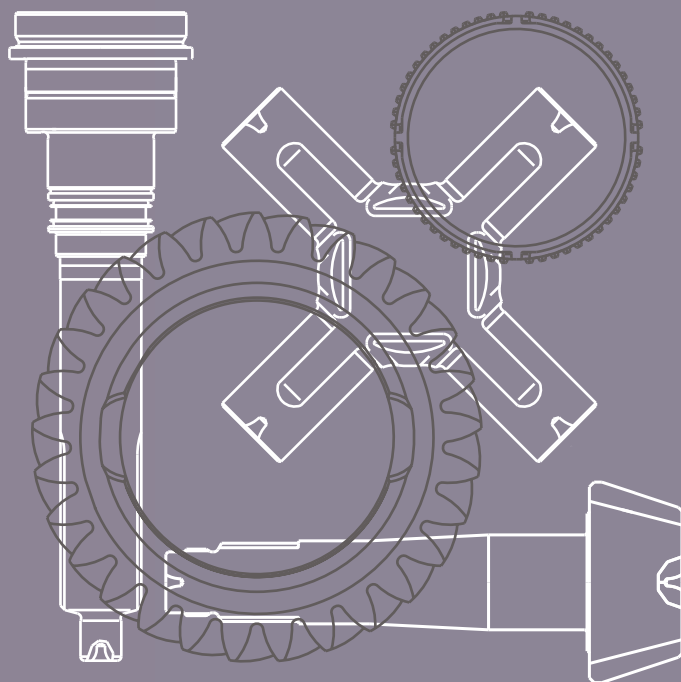

n°  
025



Aprile 2007

SPARE PARTS



Italia

# CERTIFICATO

Nr 50 100 3413 - Rev. 01

Si attesta che / *This is to certify that*

IL SISTEMA QUALITÀ DI  
THE QUALITY SYSTEM OF

**C.E.I.**

**COSTRUZIONE EMILIANA INGRANAGGI S.p.A.**

SEDE PRINCIPALE: SEDE PRODUTTIVA:  
VIA EMILIA 239 VIA DEL LAVORO 78  
I-40011 ANZOLA EMILIA (BO) I-40056 CREPELLANO (BO)

È CONFORME AI REQUISITI DELLA NORMA  
*HAS BEEN FOUND TO CONFORM TO THE REQUIREMENTS OF*

**UNI EN ISO 9001:2000**

Questo certificato è valido per il seguente campo di applicazione  
*This certificate is valid for the following product or service range*

**Progettazione, produzione e assemblaggi di parti ed  
accessori di ricambio per veicoli industriali (EA 22a)**

***Design, manufacture and assembling of spare parts and  
accessories for industrial vehicles (EA 22a)***

Data/date

2006-10-11

**SINCERT**

ACCREDITAMENTO ORGANISMI DI CERTIFICAZIONE E ISPEZIONE

SGQ N° 049A  
SGA N° 018D  
SCR N° 009F  
SSI N° 005G  
PRD N° 081B

Membro degli Accordi di Mutuo Riconoscimento EA e IAF  
Signatory of EA and IAF Mutual Recognition Agreements

Per l'Organismo di Certificazione  
For the Certification Body  
**TÜV Italia S.r.l.**

  
**Alessio Galiazso**  
Technical Responsible



**Rinnovo del certificato emesso per la prima volta in data 2003-10-21**

*"La validità del presente certificato è subordinata a sorveglianza periodica a 12 mesi e al riesame completo del sistema di gestione aziendale con periodicità triennale"*

*"The validity of the present certificate depends on the annual surveillance every 12 months and on the complete review of company's management system after three-years."*

# ELENCO CATALOGHI DISPONIBILI PER LE SEGUENTI GAMME DI NOSTRA PRODUZIONE

LIST OF THE AVAILABLE CATALOGUES FOR THE FOLLOWING PRODUCTION LINES  
LISTE DES CATALOGUES DISPONIBLES POUR LES GAMMES DE PRODUCTION SUIVANTES  
KATALOGE FÜR DIE FOLGENDEN PRODUKTION LINIEN  
LISTADO DE LOS CATALOGOS PARA LAS LINEAS SIGUIENTES



400.001 IVECO



400.025 DAF Axles



400.050 MERCEDES



400.055 M.A.N.Axles



400.075 RENAULT V.I.



400.080 SCANIA



400.090 VOLVO



400.095 ZF Old Range



400.195 ZF Ecosplit



400.295 ZF Ecomid



400.901 Ricambi



Figures part denominations references and data contained in this catalogue are not binding.  
CEI reserves the right to introduce any changes at any time without prior notice.

Le figure, le denominazioni, i riferimenti ed i dati contenuti nel presente catalogo non sono impegnativi.  
La CEI si riserva di apportare in ogni momento e senza preavviso tutte le variazioni che riterrà opportune.

Les figures, les dénominations, les références et les spécifications contenues dans ce catalogue ne sont pas engageantes.  
La CEI se réserve le droit d'apporter à tout moment et sans préavis les variations éventuelles qu'elle croit utiles.

Die in diesem Katalog enthalten Abbildungen, Benennungen Zeichen und Angaben sind unverbindlich.  
Die Firma CEI behält sich das Recht vor, jederzeit und ohne Viranzeige Änderungen vorzunehmen.

Las figuras, las denominaciones, las referencias y los datos contenidos en el presente catálogo no son empeñativos.  
CEI puede hacer en cada momento y sin preaviso todas las variaciones que sean oportunas.

#### **INTERCHANGEABILITY GUARANTY**

Our spare parts are interchangeable with the originals ones; our products bear our trade-mark.  
The original part numbers listed in this catalogue are for reference only.

#### **GARANZIA DI INTERCAMBIABILITÀ**

I nostri ricambi sono intercambiabili con gli originali; la nostra produzione riporta il nostro marchio.  
I riferimenti originali sono esposti a semplice titolo indicativo.

#### **GARANTIE D'INTERCHANGEABILITE**

Nos pièces détachées sont interchangeables avec les originaux.  
Notre production porte notre marque.  
Les numeros originaux mentionné dans ce catalogue sont seulement à titre indicatif.

#### **AUSTAUSCHBARKEITS-GARANTIE**

Unsere ersatzteile sind austauschbar mit den Originalzahnradern.  
Auf unseren Erzeugnissen ist unsere Schutzmarke aufgetragen.  
Die im gegenwärtigen Kalatolg genannten Originalnummern nur zum Hinweis dienen.

#### **GARANTIA DE INTERCAMBIABILIDAD**

Nuestros recambios son intercambiables con los originales.  
Todos nuestros productos, llevan grabada nuestra marca.  
Las referencias originales impresas en nuestro catalogo figuran exclusivamente a titulo indicativo.

---

**Suitable To :**  
**DAF**

---

**Assale Posteriore**  
**Rear Axle**

**1346**

**Modelli / Models**

**F85**

**F95**

**Assale Posteriore**  
**Rear Axle**

**1347**

**Modelli / Models**

**75CF - CF75**

**85CF - CF85**

**95XF - XF95**

**XF105**

Adattabile a : **DAF**  
Suitable To :

# Assale / Axle 1346

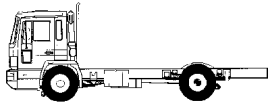

Ponte Posteriore  
Rear Axle

Differenziale Completo  
CON BLOCCAGGIO DIFF.  
Differential complete  
WITH DIFF. LOCK

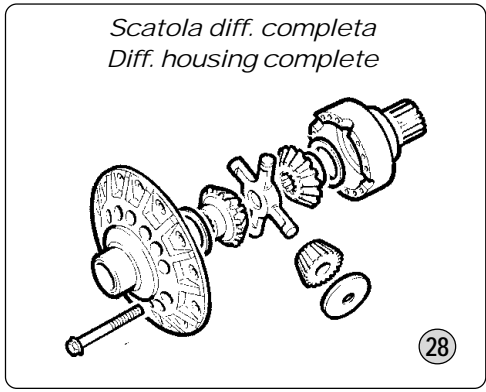
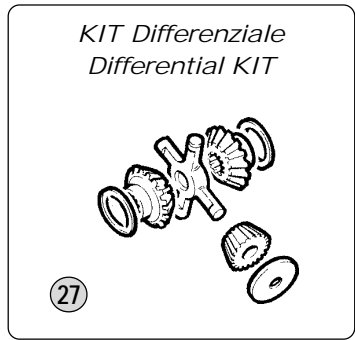
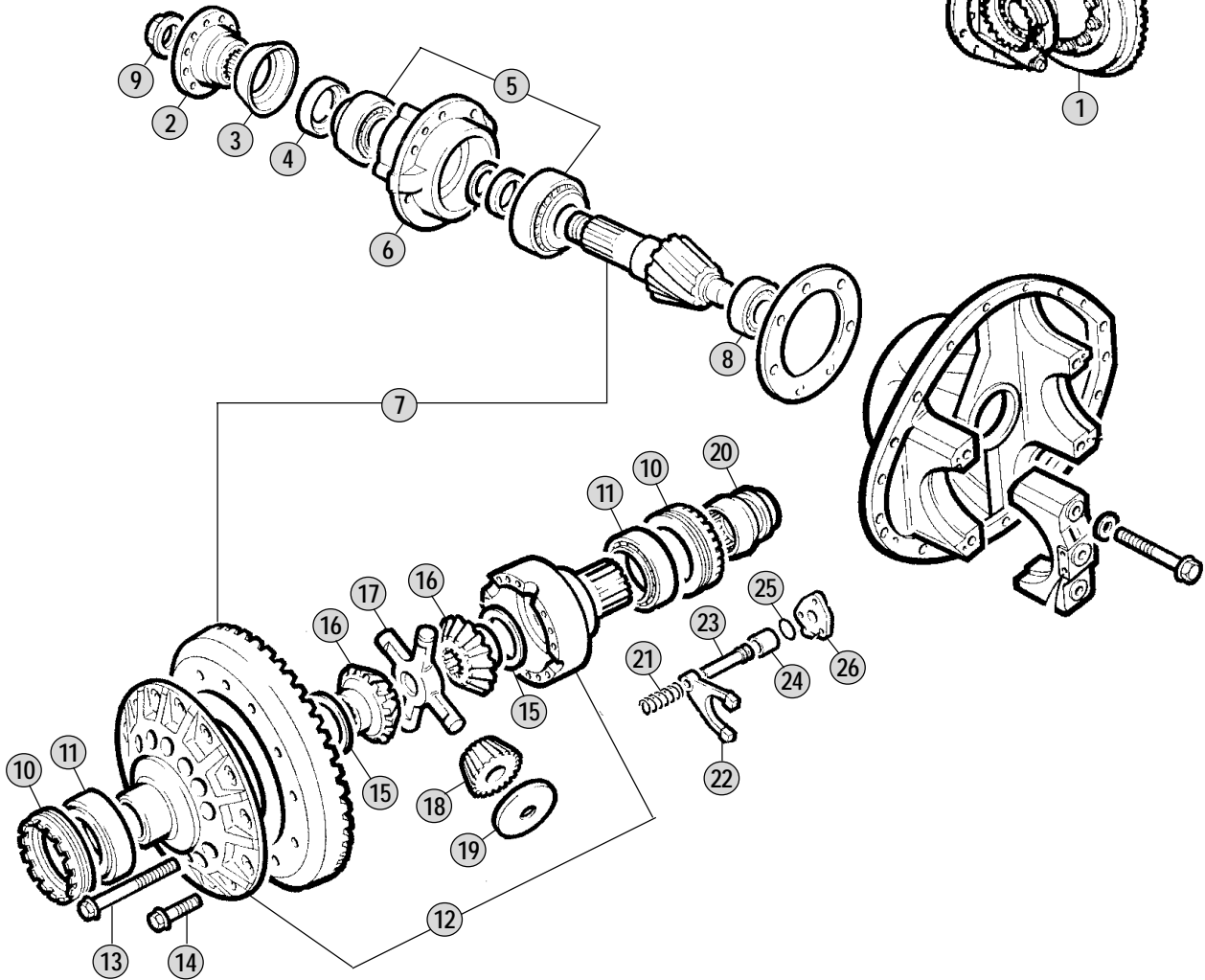
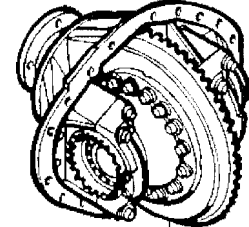

Models

DAF Assale / Axle 1346

F85

F95



All original equipment manufacturers' numbers, symbols and description used in this catalogue are for reference only, and it is not implied that any part listed is the product of these manufactures. Tutti i nostri particolari non sono originali ma con essi intercambiabili. I riferimenti originali, le figure, i modelli sono esposti a semplice titolo indicativo. La nostra produzione riporta il nostro marchio.



Adattabile a : **DAF**  
Suitable To :

# Assale / Axle 1347

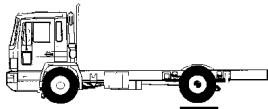

Ponte Posteriore  
Rear Axle

Differenziale Completo  
CON BLOCCAGGIO DIFF.  
Differential complete  
WITH DIFF. LOCK

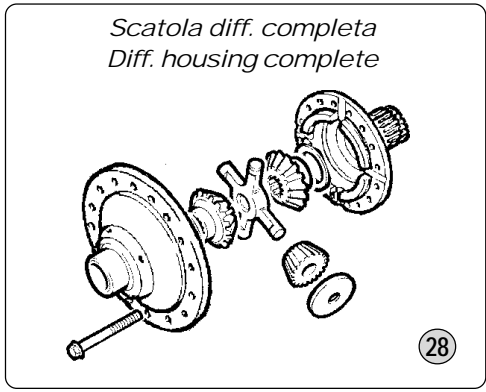
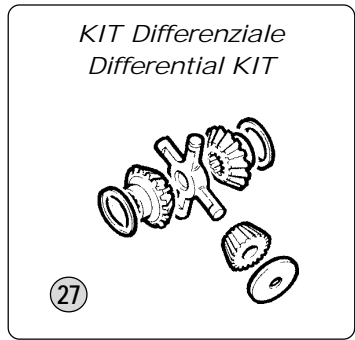
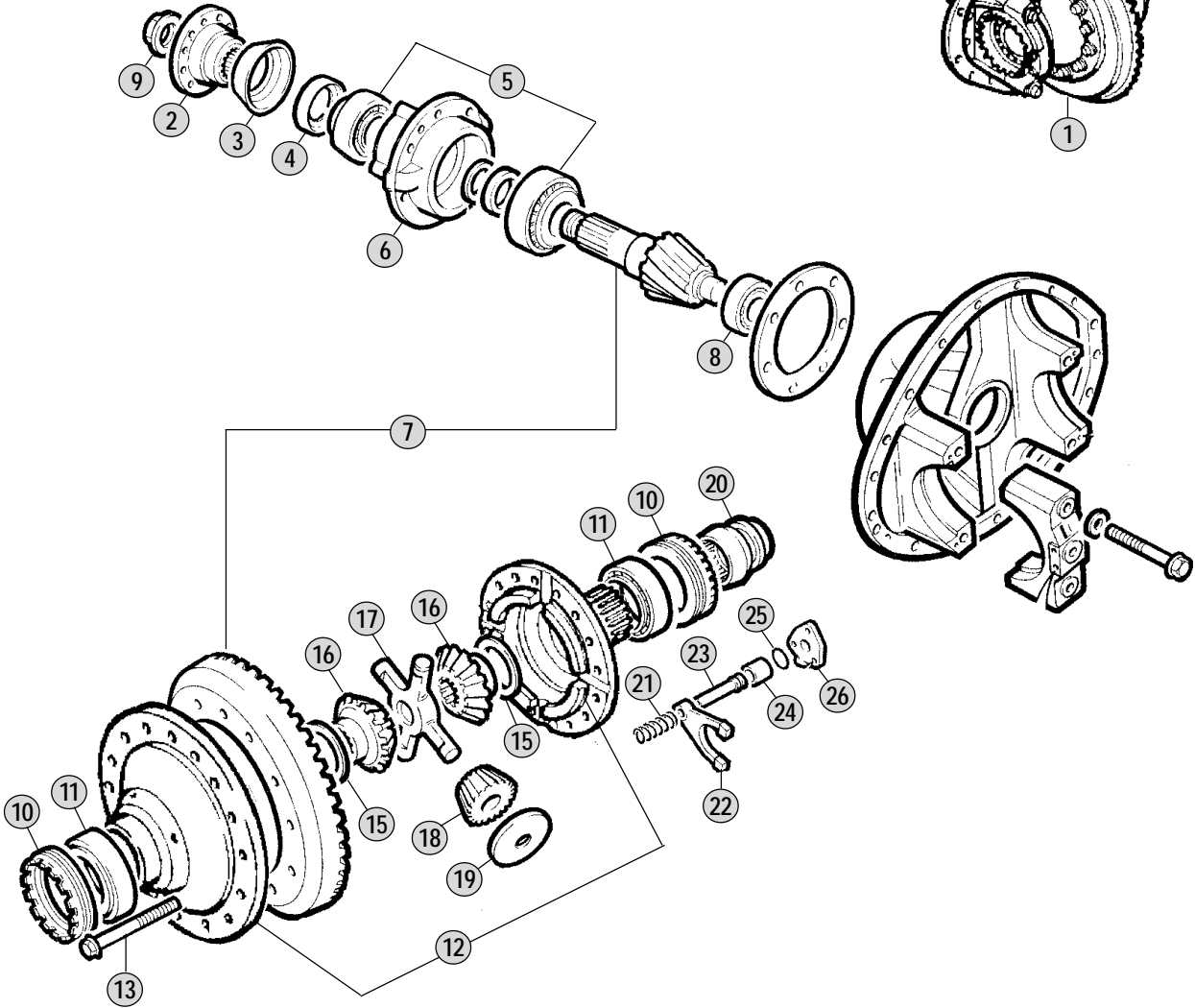
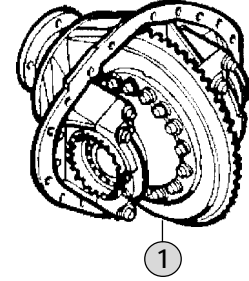

All original equipment manufacturers' numbers, symbols and description used in this catalogue are for reference only, and it is not implied that any part listed is the product of these manufactures. Tutti i nostri particolari non sono originali ma con essi intercambiabili. I riferimenti originali, le figure, i modelli sono esposti a semplice titolo indicativo. La nostra produzione riporta il nostro marchio.

Models

**DAF Assale / Axle 1347**  
75CF - CF75 - 85CF - CF85  
95XF - XF95 - XF105







# DAF Index

DAF no.	CEI no.	Tab.	Fig.	DAF no.	CEI no.	Tab.	Fig.	DAF no.	CEI no.	Tab.	Fig.
082998		0010	13	546006	<b>169.788</b>	0020	15	1426187	<i>280.673</i>	0020	1
083001	<i>194.885</i>	0010	7	546007	<b>169.789</b>	0010	19	1426190	<i>280.670</i>	0020	1
083002	<i>194.886</i>	0010	7	546007	<b>169.789</b>	0020	19	1628130		0020	22
083003	<i>194.887</i>	0010	7	546007	<i>See</i>	0546007					
083004	<i>194.888</i>	0010	7	593531	<i>See</i>	1287859					
083005	<i>194.889</i>	0010	7	641320		0010	9				
083483	<i>See</i>	660375		641320		0020	9				
088933	<b>187.593</b>	0020	13	658448	<i>130.718</i>	0010	11				
090755	<i>See</i>	1361375		658448	<i>130.718</i>	0020	11				
090758	<i>See</i>	1361377		660375		0010	14				
090771	<i>See</i>	1295669		682030	<i>See</i>	682237					
094995		0020	10	682060	<i>280.664</i>	0010	1				
205622	<i>See</i>	1278466		682237	<i>199.259</i>	0010	12				
376992		0010	4	683067	<b>199.086</b>	0020	12				
376992		0020	4	701745	<i>See</i>	660375					
382062	<i>280.666</i>	0010	1	762067	<i>280.668</i>	0010	1				
384808		0010	3	890248	<i>280.667</i>	0010	1				
384808		0020	3	890741	<i>280.665</i>	0010	1				
385516	<i>See</i>	1207132		1205426		0010	26				
385518		0010	23	1205426		0020	26				
385520	<i>154.387</i>	0010	20	1207132		0010	22				
385520	<i>154.387</i>	0020	20	1233804	<i>See</i>	1426184					
385677		0010	6	1233805	<i>See</i>	1426169					
386110	<i>See</i>	083001		1233810	<i>See</i>	1426187					
386111	<i>See</i>	083002		1238687		0020	6				
386112	<i>See</i>	083003		1246170	<i>280.672</i>	0020	1				
386736		0010	10	1278466		0010	25				
387157		0010	21	1278466		0020	25				
388958		0010	24	1287102		0010	4				
390238		0010	8	1287102		0020	4				
391741	<i>See</i>	1287859		1287859		0010	2				
391781	<i>See</i>	083004		1287859		0020	2				
396196	<b>133.118</b>	0010	17	1291189	<i>130.707</i>	0020	8				
396196	<b>133.118</b>	0020	17	1295669	<b>122.095</b>	0010	16				
396197	<b>182.069</b>	0010	18	1295669	<b>122.095</b>	0020	16				
396197	<b>182.069</b>	0020	18	1346529	<i>See</i>	1365793					
538466	<i>298.075</i>	0010	5	1361373	<i>194.890</i>	0020	7				
538466	<i>298.075</i>	0020	5	1361375	<b>194.827</b>	0020	7				
538580		0020	21	1361377	<i>194.828</i>	0020	7				
538581	<i>See</i>	1205426		1361379	<i>194.891</i>	0020	7				
538687		0020	23	1365793	<b>194.826</b>	0020	7				
538688		0020	24	1426169	<i>280.671</i>	0020	1				
546006	<b>169.788</b>	0010	15	1426184	<i>280.669</i>	0020	1				

Date

04 / **2007**

Table

## Index

CEI no.	DAF no.	Tab. Fig.	CEI no.	DAF no.	Tab. Fig.	CEI no.	DAF no.	Tab. Fig.
122.095	1295669	0010 16	298.075	538466	0020 5			
122.095	1295669	0020 16						
130.707	1291189	0020 8						
130.718	658448	0010 11						
130.718	658448	0020 11						
133.118	396196	0010 17						
133.118	396196	0020 17						
154.387	385520	0010 20						
154.387	385520	0020 20						
169.788	546006	0010 15						
169.788	546006	0020 15						
169.789	546007	0010 19						
169.789	546007	0020 19						
182.069	396197	0010 18						
182.069	396197	0020 18						
187.593	088933	0020 13						
194.826	1365793	0020 7						
194.827	1361375	0020 7						
194.828	1361377	0020 7						
194.885	083001	0010 7						
194.886	083002	0010 7						
194.887	083003	0010 7						
194.888	083004	0010 7						
194.889	083005	0010 7						
194.890	1361373	0020 7						
194.891	1361379	0020 7						
199.086	683067	0020 12						
199.087	CEI 199087	0020 28						
199.259	682237	0010 12						
280.664	682060	0010 1						
280.665	890741	0010 1						
280.666	382062	0010 1						
280.667	890248	0010 1						
280.668	762067	0010 1						
280.669	1426184	0020 1						
280.670	1426190	0020 1						
280.671	1426169	0020 1						
280.672	1246170	0020 1						
280.673	1426187	0020 1						
298.073	CEI 298073	0010 27						
298.073	CEI 298073	0020 27						
298.074	CEI 298074	0010 28						
298.075	538466	0010 5						

All original equipment manufacturers numbers, symbols, pictures, models and description used in this catalogue are for reference only, and it is not implied that any part listed is the product of these manufactures.  
Tutti i nostri particolari non sono originali ma con essi intercambiabili. I riferimenti originali, le figure, i modelli sono esposti a semplice titolo indicativo. La nostra produzione riporta il nostro marchio.

Date

04 / 2007

Table

**Ai Clienti / Importatori / Distributori prodotti C.E.I. S.p.A.:**

**“CONFORMITA’ A LEGGI E/O REGOLAMENTI SPECIFICI DELLA NAZIONE IMPORTATRICE”**

*C.E.I. S.p.A. assicura che i propri prodotti sono conformi alle Leggi e Regolamenti del Mercato Europeo e declina ogni responsabilità per applicazioni soggette a Leggi e Regolamenti specifici del Paese importatore, lasciando allo stesso la responsabilità di verificare la conformità del prodotto C.E.I. S.p.A. ai vincoli cogenti di Leggi e/o Regolamenti locali.*

*C.E.I. S.p.A. si dichiara disponibile, su richiesta del cliente, a valutare la possibilità di adeguare i propri prodotti ad eventuali specifiche esigenze che ci venissero sottoposte.*

**To Customer / Importers / Distributors of CEI Spa products :**

**“COMPLIANCE WITH LAWS AND/OR SPECIFIC REGULATIONS OF THE IMPORT COUNTRY”**

*C.E.I. S.p.A. ensures that its products conform to the laws and regulations of the European Community and declines any responsibility for applications subject to specific laws and regulations of the import country which is responsible to ascertain the conformity of CEI S.p.A. products to the local laws and/or regulations in force.*

*C.E.I. S.p.A. is available to evaluate the possibility of adapting its products for specific applications on request, should the need arise from any customer.*

**Aux clients / importateurs / distributeurs produits C.E.I. S.p.A.**

**“CONFORMITE AUX LOIS ET/OU REGLEMENTS SPECIFIQUES DU PAYS IMPORTATEUR “**

*La maison C.E.I. S.p.A. assure que ses produits sont conformes aux lois et règlements de la Communauté Européenne et décline toute responsabilité pour d'applications assujetties aux lois et règlements spécifiques du pays importateur , en laissant aux mêmes la responsabilité de vérifier la conformité du produit CEI aux obligations de lois et/ou règlements en vigueur propres du pays .*

*La maison C.E.I. S.p.A. se déclare disposée, sur requête du client, à évaluer la possibilité de conformer ses produits à d'éventuelles exigences spécifiques qui soient demandées.*

**A los clientes/importadores/distribidores del los productos CEI S.p.A.**

**“CONFORMIDAD A LAS LEYES Y/O LAS REGLAMENTACIONES ESPECIFICAS DE LA NACION IMPORTADORA “**

*CEI S.p.A certifica que sus productos están conformes con la leyes y las reglamentaciones del Mercado Europeo y declina cada responsabilidad por aplicaciones sujetas a leyes y reglamentaciones específicos del país importador, dejando al mismo la responsabilidad de averiguar la conformidad del producto CEI con los vinculos en vigencia de leyes y/o reglamentaciones locales.*

*CEI está disponible, bajo petición del cliente a evaluar la posibilidad de conformar sus productos con eventuales exigencias específicas.*



E' vietato a chiunque utilizzare le immagini ed i dati di questo catalogo per fini diversi dalla semplice consultazione. CEI perseguirà penalmente, nelle opportuni sedi giudiziarie, chi dovesse utilizzare servilmente, anche tramite semplice fotocopiatura, scanner ecc., le immagini di questo catalogo per propri fini.

It is forbidden to use pictures and data contained in this catalogue for aims other than reference purpose. CEI will prosecute those using the imaging contained here in for one's own purpose, even by means of photocopier or scanner, in the appropriate forum.

Il est interdit à quiconque d'utiliser les images et les informations de ce catalogue dans un but autre qu'une simple consultation. CEI poursuivra civilement et pénalement, dans les sièges juridiques opportuns, tous ceux qui utiliseront servilement, y compris par simple photocopie, scannage, etc. (même à simple titre d'exemple), les images de ce catalogue pour des objectifs autres que ceux prévus par Cei spa.

Queda prohibido a toda persona utilizar las imágenes y los datos de este catálogo con otra finalidad que no sea la de consulta. CEI perseguirá civil y penalmente, ante la jurisdicción que corresponda, a toda persona que incurra en imitación servil, incluso mediante el simple fotocopiado, escaneado, etc. (la indicación vale sólo a título de ejemplo), de las imágenes de este catálogo, con finalidades ajenas a las de CEI S.p.a.

Die Anwendung der Bilder und Daten dieses Katalogs für andere Zwecke als die des Nachschlagens ist verboten. CEI behält sich vor, gegen diejenigen bei den entsprechend zuständigen Gerichtsstellen zivil- und strafrechtlich vorzugehen, die die Bilder dieses Katalogs auch nur durch einfaches Kopieren, Einscannen, usw. für andere Zwecke als die der Firma Cei spa verwenden sollten.

---

**Edizione Aprile 2007**

**Pagine nr. 9**

Stampa

Grafiche CAMPASS - BOLOGNA

**C.E.I.  
COSTRUZIONE  
EMILIANA  
INGRANAGGI S.P.A.**

VIA EMILIA 239  
P.O. BOX 180  
40011 ANZOLA EMILIA  
BOLOGNA  
ITALY

TEL. +39 051 6506200 (r.a.)  
FAX +39 051 733832  
EXPORT FAX +39 051 734128

**INTERNET**

<http://www.cei.it>

**E-MAIL**

Informazioni: [cei@cei.it](mailto:cei@cei.it)  
Commerciale Italia: [italia@cei.it](mailto:italia@cei.it)  
Export: [export@cei.it](mailto:export@cei.it)  
Acquisti: [purchasingdept@cei.it](mailto:purchasingdept@cei.it)  
Amministrazione: [accountdept@cei.it](mailto:accountdept@cei.it)

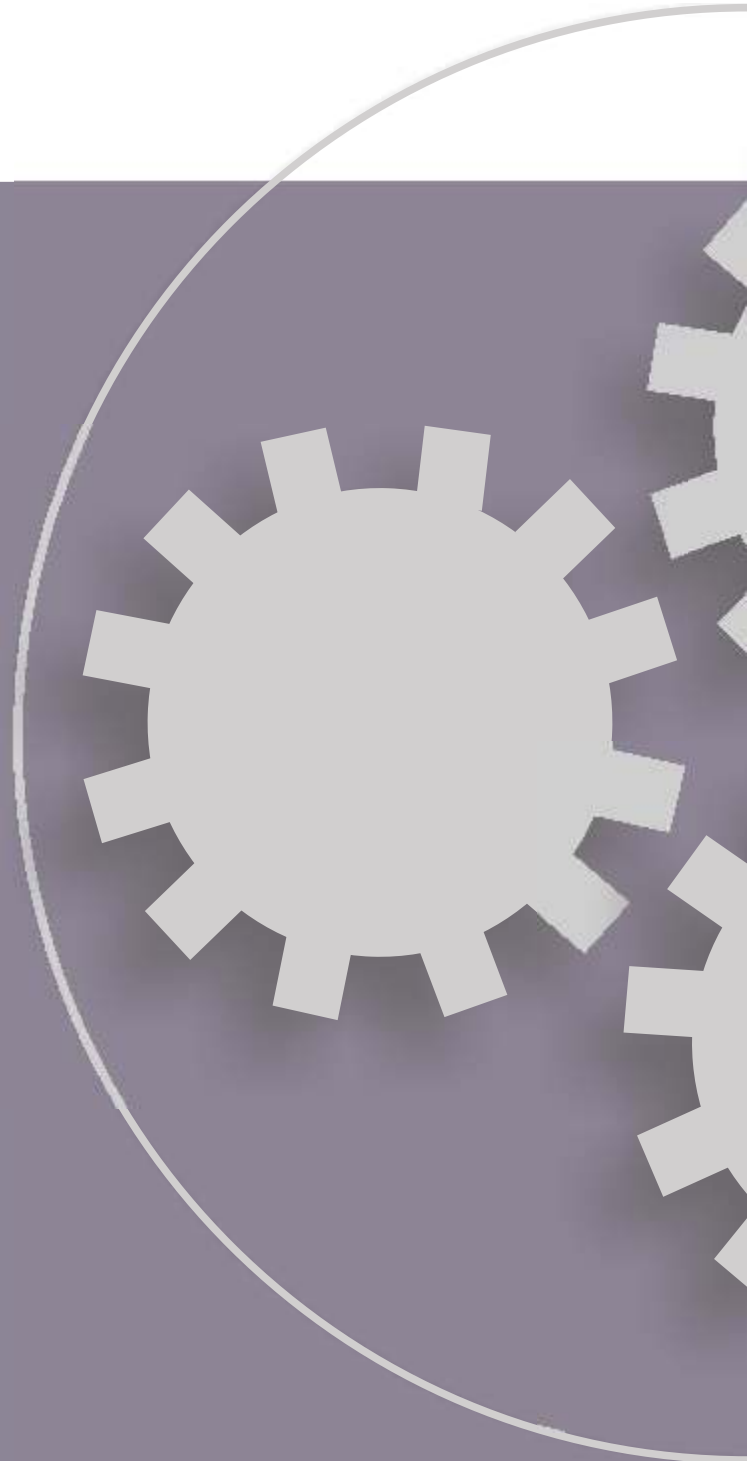

H I G H F I D E L I T Y