

www.aydinsan.com.tr

KALİPER TAMİR TAKIMI KATALOĐU CALIPER REPAIR KIT CATALOGUE



KNORR

SB5 SERIES

CALIPER REPAIR KITS

KALİPER TAMİR TAKIMI

AYDINSAN 

www.aydinsan.com.tr

AYS Code 4K002



Caliper Guides & Seals Repair Kit
I1328090062

Pos.	AYS Code	Description	Dimension	Qty
1	4K502	GUIDE PIN (SHORT)	Ø34 x 80 mm	1
2	4K507	GUIDE PIN (LONG)	Ø36 x 145 mm	1
3	4K518	BOLT (LONG)	M16x1,5 x 150 mm	1
4	4K514	BOLT (SHORT)	M16x1,5 x 85 mm	1
5	4K521	BRONZE BUSH	Ø40 x Ø36 x 82 mm	1
6	4K532	OUTER BOOT		1
7	4K531	INNER BOOT		1
8	4K551	RING		1
9	4K552	OUTER BOOT CLIP		1
10	4K525	RUBBER BUSH		1

AYS Code 4K004



Caliper Outer Boots & Steel Caps K001301

Pos.	AYS Code	Description	Dimension	Qty
1	4K532	OUTER BOOT		6
2	4K541	STEEL CAP		6
3	4K552	OUTER BOOT CLIP		6
4	4K553	O-RING		6

AYS Code 4K006



Caliper Rubber Bush & Guide Repair Kit
I1368470064

Pos.	AYS Code	Description	Dimension	Qty
1	4K502	GUIDE PIN (SHORT)	Ø34 x 80 mm	1
2	4K514	BOLT (SHORT)	M16x1,5 x 85 mm	1
3	4K525	RUBBER BUSH		1

AYS Code 4K014



Caliper Bridge Assembly

Pos.	AYS Code	Description	Dimension	Qty
1	4K594	BRIDGE ASSEMBLY		1
2	4K572	SPRING	Ø21 x 51,5 mm	2

AYS Code 4K015



Caliper Piston Repair Kit ii304130065

Pos.	AYS Code	Description	Dimension	Qty
1	4K533	TAPPET & BOOT ASSEMBLY	Ø74 mm	2
2	4K520	TAPPET BUSH	Ø18 x Ø16 x 10 mm	2

AYS Code 4K016



Caliper Piston & Seals Repair Kit K000944

Pos.	AYS Code	Description	Dimension	Qty
1	4K533	TAPPET & BOOT ASSEMBLY	Ø74 mm	2
2	4K520	TAPPET BUSH	Ø18 x Ø16 x 10 mm	2
3	4K537	INNER SEAL		2

AYS Code 4K022

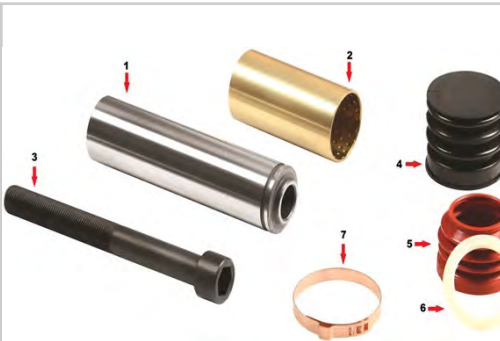

Caliper Guides & Seals Repair Kit K000935

Pos.	AYS Code	Description	Dimension	Qty
1	4K507	GUIDE PIN (LONG)	Ø36 x 145 mm	1
2	4K521	BRONZE BUSH	Ø40 x Ø36 x 82 mm	1
3	4K518	BOLT (LONG)	M16x1,5 x 150 mm	1
4	4K532	OUTER BOOT		1
5	4K531	INNER BOOT		1
6	4K551	RING		1
7	4K552	OUTER BOOT CLIP		1

AYS Code 4K051

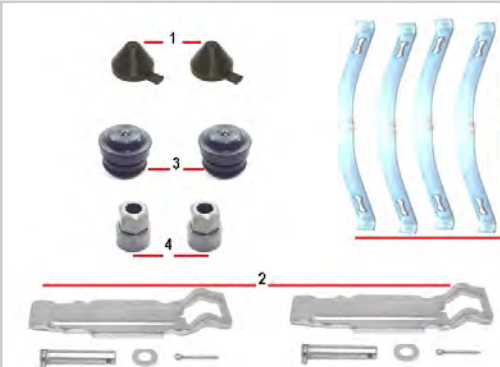

Caliper Pad Retainer Repair Kit

Pos.	AYS Code	Description	Dimension	Qty
1	4K557	Adjuster Cap		2
2	4K028	Caliper Pad Retainer Repair Kit		2
3	4K558	Adjuster Cap		2
4	4K563	Adjusting Mechanism Adapter		2
5	4K559	Shoe Retainer		2

AYS Code **4K054**

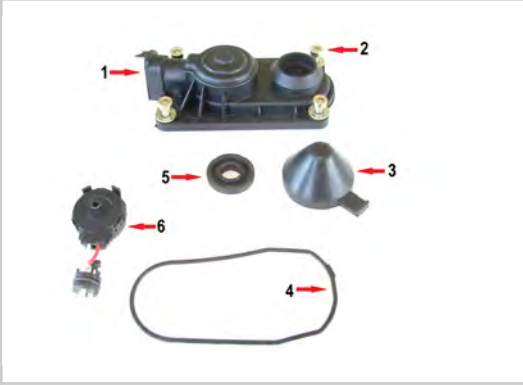

Caliper Plastic Cover (with sensor)

Pos.	AYS Code	Description	Dimension	Qty
1	4K549	Cover		1
2	4K575	Screw with Rivet		4
3	4K557	AdjusterCap		1
4	4K565	Seal		1
5	4K550	Seal		1
6	4K547	Sensor with (2 cable)		1

<p>AYS Code 4K008</p>	<p>AYS Code 4K008-01</p>	<p>AYS Code 4K012</p>
		
<p>Caliper Calibration Bolt (Special)</p>	<p>Caliper Calibration Bolt (Normal)</p>	<p>Caliper Adjusting Shaft</p>
<p>AYS Code 4K064</p>	<p>AYS Code 4K067</p>	<p>AYS Code 4K068</p>
		
<p>Caliper Adjusting Mechanism</p>	<p>Caliper Bearing Support</p>	<p>Caliper Plug Set</p>
<p>AYS Code 4K168</p>	<p>AYS Code 4K169</p>	<p>AYS Code 4K180</p>
		
<p>Caliper Roller Bearings</p>	<p>Caliper Chain (12 links)</p>	<p>Caliper Lever</p>

KNORR

SB6/SB7 SERIES

CALIPER REPAIR KITS

KALİPER TAMİR TAKIMI



AYS Code 4K002



Caliper Guides & Seals Repair Kit
II328090062

Pos.	AYS Code	Description	Dimension	Qty
1	4K502	GUIDE PIN (SHORT)	Ø34 x 80 mm	1
2	4K507	GUIDE PIN (LONG)	Ø36 x 145 mm	1
3	4K518	BOLT (LONG)	M16x1,5 x 150 mm	1
4	4K514	BOLT (SHORT)	M16x1,5 x 85 mm	1
5	4K521	BRONZE BUSH	Ø40 x Ø36 x 82 mm	1
6	4K532	OUTER BOOT		1
7	4K531	INNER BOOT		1
8	4K551	RING		1
9	4K552	OUTER BOOT CLIP		1
10	4K525	RUBBER BUSH		1

AYS Code 4K003



Caliper Guides & Seals Repair Kit
K001532

Pos.	AYS Code	Description	Dimension	Qty
1	4K505	GUIDE PIN (LONG)	Ø36 x 114 mm	1
2	4K501	GUIDE PIN (SHORT)	Ø32 x 80 mm	1
3	4K514	BOLT (SHORT)	M16x1,5 x 85 mm	1
4	4K513	BOLT (SHORT)	M16x1,5 x 80 mm	1
5	4K521	BRONZE BUSH	Ø40 x Ø36 x 82mm	1
6	4K524	METAL-RUBBER BUSH	Ø35mm (metal end)	1
7	4K542	CAP		1
8	4K531	INNER BOOT		1
9	4K551	RING		1
10	4K541	STEEL CAP		1
11	4K553	O-RING		1

AYS Code 4K004



Caliper Outer Boots & Steel Caps
K001301

Pos.	AYS Code	Description	Dimension	Qty
1	4K532	OUTER BOOT		6
2	4K541	STEEL CAP		6
3	4K552	OUTER BOOT CLIP		6
4	4K553	O-RING		6

AYS Code 4K006



Caliper Rubber Bush & Guide Repair Kit
II368470064

Pos.	AYS Code	Description	Dimension	Qty
1	4K502	GUIDE PIN (SHORT)	Ø34 x 80 mm	1
2	4K514	BOLT (SHORT)	M16x1,5 x 85 mm	1
3	4K525	RUBBER BUSH		1

AYS Code 4K015



Caliper Piston Repair Kit
304130065

Pos.	AYS Code	Description	Dimension	Qty
1	4K533	TAPPET & BOOT ASSEMBLY	Ø74 mm	2
2	4K520	TAPPET BUSH	Ø18 x Ø16 x 10 mm	2

AYS Code 4K016



Caliper Pistons & Seals Repair Kit
K010604

Pos.	AYS Code	Description	Dimension	Qty
1	4K533	TAPPET & BOOT ASSEMBLY	Ø74 mm	2
2	4K520	TAPPET BUSH	Ø18 x Ø16 x 10 mm	2
3	4K537	INNER SEAL		2

AYS Code 4K017



Caliper Guides & Seals Repair Kit
K000375

Pos.	AYS Code	Description	Dimension	Qty
1	4K505	GUIDE PIN (LONG)	Ø36 x 114 mm	1
2	4K501	GUIDE PIN (SHORT)	Ø32 x 80 mm	1
3	4K514	BOLT (SHORT)	M16x1,5 x 85 mm	1
4	4K513	BOLT (SHORT)	M16x1,5 x 80 mm	1
5	4K521	BRONZE BUSH	Ø40 x Ø36 x 82 mm	1
6	4K522	METAL-RUBBER BUSH	Ø39 mm (metal end)	1
7	4K542	CAP		1
8	4K531	INNER BOOT		1
9	4K551	RING		1
10	4K541	STEEL CAP		1
11	4K553	O-RING		1

AYS Code 4K018



Caliper Guides & Seals Repair Kit
K000696

Pos.	AYS Code	Description	Dimension	Qty
1	4K505	GUIDE PIN (LONG)	Ø36 x 114 mm	1
2	4K514	BOLT (SHORT)	M16x1,5 x 85 mm	1
3	4K521	BRONZE BUSH	Ø40 x Ø36 x 82 mm	1
4	4K541	STEEL CAP		1
5	4K531	INNER BOOT		1
6	4K551	RING		1
7	4K553	O-RING		1

AYS Code 4K019

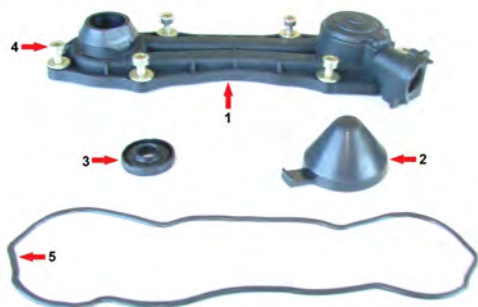

Caliper Plastic Cover (without sensor)

Pos.	AYS Code	Description	Dimension	Qty
1	4K546	Cover		1
2	4K557	Adjuster Cap		1
3	4K550	Seal		1
4	4K575	Screw with Rivet		6
5	4K554	Seal		1

AYS Code 4K022



Caliper Guides & Seals Repair Kit K000935

Pos.	AYS Code	Description	Dimension	Qty
1	4K507	GUIDE PIN (LONG)	Ø36 x 145 mm	1
2	4K521	BRONZE BUSH	Ø40 x Ø36 x 82 mm	1
3	4K518	BOLT (LONG)	M16x1,5 x 150 mm	1
4	4K532	OUTER BOOT		1
5	4K531	INNER BOOT		1
6	4K551	RING		1
7	4K552	OUTER BOOT CLIP		1

AYS Code 4K023



Caliper Guide & Seals Repair Kit II358510062

Pos.	AYS Code	Description	Dimension	Qty
1	4K507	GUIDE PIN (LONG)	Ø36 x 145 mm	1
2	4K503	GUIDE PIN (SHORT)	Ø34 x 120 mm	1
3	4K518	BOLT (LONG)	M16x1,5 x 150 mm	1
4	4K516	BOLT (SHORT)	M16x1,5 x 125 mm	1
5	4K521	BRONZE BUSH	Ø40 x Ø36 x 82 mm	1
6	4K526	RUBBER BUSH (LONG)	Ø40 x Ø34 x 95 mm	1
7	4K532	OUTER BOOT		1
8	4K552	OUTER BOOT CLIP		1
9	4K551	RING		1
10	4K531	INNER BOOT		1

AYS Code 4K024



Caliper Guide & Seals Repair Kit II179320062

Pos.	AYS Code	Description	Dimension	Qty
1	4K506	GUIDE PIN (LONG)	Ø36 x 134 mm	1
2	4K503	GUIDE PIN (SHORT)	Ø34 x 120 mm	1
3	4K517	BOLT (LONG)	M16x1,5 x 140 mm	1
4	4K516	BOLT (SHORT)	M16x1,5 x 125 mm	1
5	4K521	BRONZE BUSH	Ø40 x Ø36 x 82 mm	1
6	4K526	RUBBER BUSH (LONG)	Ø40 x Ø34 x 95 mm	1
7	4K539	INNER BOOT		1
8	4K540	OUTER BOOT (SHORT)		1
9	4K552	OUTER BOOT CLIP		1

AYS Code 4K025



Caliper Guides & Seals Repair Kit K000132

Pos.	AYS Code	Description	Dimension	Qty
1	4K502	GUIDE PIN (SHORT)	Ø34 x 80 mm	1
2	4K506	GUIDE PIN (LONG)	Ø36 x 134 mm	1
3	4K517	BOLT (LONG)	M16x1,5 x 140 mm	1
4	4K514	BOLT (SHORT)	M16x1,5 x 85 mm	1
5	4K521	BRONZE BUSH	Ø40 x Ø36 x 82 mm	1
6	4K532	OUTER BOOT		1
7	4K531	INNER BOOT		1
8	4K551	RING		1
9	4K552	OUTER BOOT CLIP		1
10	4K525	RUBBER BUSH		1

AYS Code 4K026



Caliper Steel Cap Repair Kit II39769F0063

Pos.	AYS Code	Description	Dimension	Qty
1	4K541	STEEL CAP		1
2	4K553	O-RING		1

AYS Code 4K027



Caliper Guides & Seals Repair Kit ii39769F0062

Pos.	AYS Code	Description	Dimension	Qty
1	4K505	GUIDE PIN (LONG)	Ø36 x 114 mm	1
2	4K502	GUIDE PIN (SHORT)	Ø34 x 80 mm	1
3	4K514	BOLT (SHORT)	M16x1,5 x 85 mm	2
4	4K521	BRONZE BUSH	Ø40 x Ø36 x 82 mm	1
5	4K541	STEEL CAP		1
6	4K553	O-RING		1
7	4K551	RING		1
8	4K531	INNER BOOT		1
9	4K525	RUBBER BUSH		1

AYS Code 4K032



Caliper Bridge Assembly

Pos.	AYS Code	Description	Dimension	Qty
1	4K591	BRIDGE ASSEMBLY		1
2	4K571	SPRING	Ø25 x 49 mm	1

AYS Code 4K033

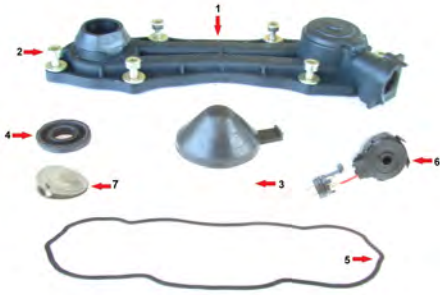

Caliper Sensor Cover (2 cables inside)

Pos.	AYS Code	Description	Dimension	Qty
1	4K546	Cover		1
2	4K575	Screw with Rivet		6
3	4K557	Adjuster Cap		1
4	4K550	Seal		1
5	4K554	Seal		1
6	4K547	Sensor (2 Cable)		1
7	4K559	Tappet		1

AYS Code 4K037

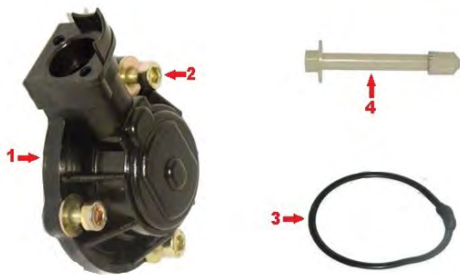

Caliper Sensor Cover (without sensor)

Pos.	AYS Code	Description	Dimension	Qty
1	4K566	Sensor Cover		1
2	4K575	Screw With Rivet		3
3	4K567	Sensor Operating Rod		1
4	4K570	Seal		1

AYS Code 4K050



Caliper Guides & Seals Repair Kit

Pos.	AYS Code	Description	Dimension	Qty
1	4K507	GUIDE PIN (LONG)	Ø36 x 145 mm	1
2	4K501	GUIDE PIN (SHORT)	Ø32 x 80 mm	1
3	4K518	BOLT (LONG)	M16x1,5 x 150 mm	1
4	4K513	BOLT (SHORT)	M16 x 1,5 x 80 mm	1
5	4K531	INNER BOOT		1
6	4K551	RING		1
7	4K552	OUTER BOOT CLIP		1
8	4K532	OUTER BOOT		1
9	4K523	METAL-RUBBER BUSH	Ø39 mm	1
10	4K521	BRONZE BUSH	Ø40 x Ø36 x 82 mm	1

AYS Code 4K051



Caliper Pad Retainer Repair Kit

Pos.	AYS Code	Description	Dimension	Qty
1	4K557	Adjuster Cap		2
2	4K028	Caliper Pad Retainer Repair Kit		2
3	4K558	Adjuster Cap		2
4	4K563	Adjusting Mechanism Adapter		2
5	4K559	Shoe Retainer		2

AYS Code 4K055



Caliper Plastic Cover (with sensor 2 cable)

Pos.	AYS Code	Description	Dimension	Qty
1	4K566	SENSOR COVER		1
2	4K575	SCREW WITH RIVET		3
3	4K547	SENSOR (2 CABLE)		1
4	4K567	SENSOR OPERATING ROD		1
5	4K570	SEAL		1

AYS Code 4K061



Caliper Guides & Seals Repair Kit

Pos.	AYS Code	Description	Dimension	Qty
1		GUIDE PIN (LONG)	Ø36 x 114 mm	1
2		GUIDE PIN (SHORT)	Ø32 x 84 mm	1
3		BOLT (SHORT)	M16 x 1,5 x 80mm	1
4		BOLT (LONG)	M16 x 1,5 x 87 mm	1
5		BRONZE BUSH	Ø40 x Ø36 x 82 mm	1
6		INNER BOOT		1
7		STEEL CAP	Ø50 x 28mm	1
8		STEEL CAP (Ø40) (Short)	Ø40 x 15mm	1
9		RING	S	1
10		O-RING	S	1
11		STEEL CAP (Ø42)	Ø42,5 x 37mm	1
12		METAL-RUBBER BUSH (SHORT)	Ø39 mm	1
13		RING		1
14		INNER BOOT		1

AYS Code 4K181



Caliper Guides & Seals Repair Kit K000365

Pos.	AYS Code	Description	Dimension	Qty
1	4K505	GUIDE PIN (LONG)	Ø36 x 114 mm	1
2	4K501	GUIDE PIN (SHORT)	Ø32 x 80 mm	1
3	4K502	GUIDE PIN (SHORT)	Ø34 x 80 mm	1
4	4K513	BOLT (SHORT)	M16x1,5 x 80 mm	1
5	4K514	BOLT (LONG)	M16x1,5 x 85 mm	2
6	4K521	BRONZE BUSH	Ø40 x Ø36 x 82 mm	1
7	4K523	METAL-RUBBER BUSH	short version	1
8	4K531	INNER BOOT		1
9	4K551	RING		1
10	4K541	STEEL CAP		1
11	4K553	O-RING		1
12	4K525	RUBBER BUSH		1
13	4K543	COVER	Ø40 mm	1







AYS Code 4K184

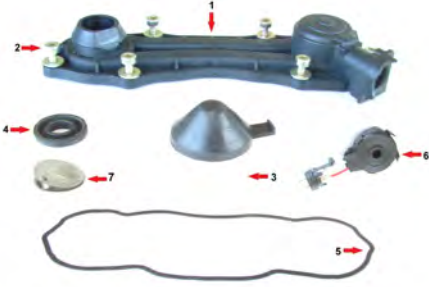

Caliper Guide & Seals Repair Kit K010813

Pos.	AYS Code	Description	Dimension	Qty
1	4K505	GUIDE PIN (LONG)	Ø36 x 114 mm	1
2	4K504	GUIDE PIN (SHORT)	Ø36 x 64 mm	1
3	4K514	BOLT (SHORT)	M16x1,5 x 85 mm	1
4	4K511	BOLT (SHORT)	M16x1,5 x 70 mm	1
5	4K521	BRONZE BUSH	Ø40 x Ø36 x 82 mm	1
6	4K551	RING		2
7	4K531	INNER BOOT		2
8	4K527	GUIDE SLEEVE	Ø40 x Ø36 x 20 mm	1
9	4K544	COVER	Ø40 mm (long)	1
10	4K541	STEEL CAP		1
11	4K553	O-RING		1

<p>AYS Code 4K008</p>	<p>AYS Code 4K008-01</p>	<p>AYS Code 4K010</p>
<p>Caliper Calibration Bolt (Special)</p>	<p>Caliper Calibration Bolt (Normal)</p>	<p>Caliper Adjusting Mechanism Adapter Set</p>
<p>AYS Code 4K011</p>	<p>AYS Code 4K028</p>	<p>AYS Code 4K029</p>
<p>Caliper Adjusting Mechanism Wheel Set</p>	<p>Caliper Pad Retainer Repair Kit</p>	<p>Caliper Pad Retainer Repair Kit (Special)</p>
<p>AYS Code 4K029-01</p>	<p>AYS Code 4K030</p>	<p>AYS Code 4K031</p>
<p>Caliper Adjusting Mechanism (Normal)</p>	<p>Caliper Adjusting Shaft (with spring)</p>	<p>Caliper Chain (29 links)</p>
<p>AYS Code 4K034</p>	<p>AYS Code 4K035</p>	<p>AYS Code 4K036</p>
<p>Caliper Adjusting Shaft (Without Spring)</p>	<p>Caliper Lever (Angle 0° - 114 mm)</p>	<p>Caliper Lever (Angle 12° - 123 mm)</p>

<p>AYS Code 4K068</p>	<p>AYS Code 4K070</p>	<p>AYS Code 4K168</p>
		
<p>Caliper Plug Set</p>	<p>Caliper Sensor Cover (3 Cables sensor inside)</p>	<p>Caliper Roller Bearings</p>
<p>AYS Code 4K171</p>	<p>AYS Code 4K182</p>	<p>AYS Code 4K186</p>
		
<p>Caliper Lever (Angle 0° - 127 mm)</p>	<p>Caliper Lever Bearing Set</p>	<p>Caliper Lever K000259</p>
<p>AYS Code 4K190</p>		
		
<p>Caliper Lever (For Bus)</p>		

KNORR

SN5 SERIES

CALIPER REPAIR KITS

KALİPER TAMİR TAKIMI



AYS Code 4K001



Caliper Piston Repair Kit K001929

Pos.	AYS Code	Description	Dimension	Qty
1	4K536	TAPPET & BOOT ASSEMBLY	Ø69 mm	1
2	4K520	TAPPET BUSH	Ø18 x Ø16 x 10 mm	1

AYS Code 4K047

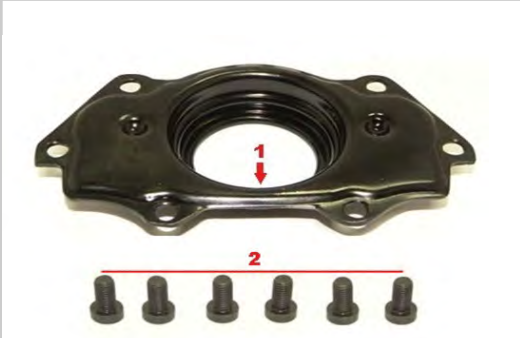

Caliper Cover

Pos.	AYS Code	Description	Dimension	Qty
1	4K598	COVER		1
2	4K573	BOLT (SHORT)	M8 x 16 mm	6

AYS Code 4K049



Caliper Bridge Assembly Repair Kit

Pos.	AYS Code	Description	Dimension	Qty
1	4K595	BRIDGE ASSEMBLY		1
2	4K572	SPRING	Ø21 x 51,5 mm	2
3	4K573	BOLT (SHORT)	M8 x 16 mm	6
4	4K560	ADJUSTER SCREW GAITER		1
5	4K598	COVER		1

AYS Code 4K051

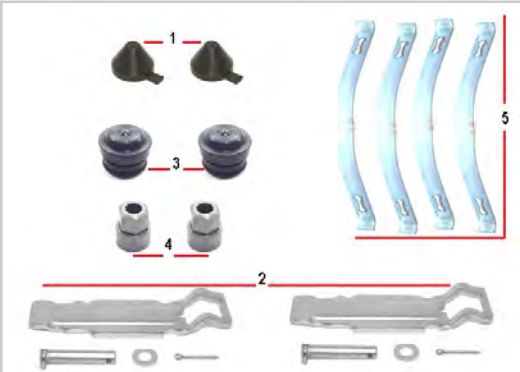

Caliper Pad Retainer Repair Kit

Pos.	AYS Code	Description	Dimension	Qty
1	4K557	Adjuster Cap		2
2	4K028	Caliper Pad Retainer Repair Kit		2
3	4K558	Adjuster Cap		2
4	4K563	Adjusting Mechanism Adapter		2
5	4K559	Shoe Retainer		2

AYS Code 4K054



Caliper Plastic Cover (with sensor 2 cable)

Pos.	AYS Code	Description	Dimension	Qty
1	4K549	Cover		1
2	4K575	Screw with Rivet		4
3	4K557	Adjuster Cap		1
4	4K565	Seal		1
5	4K550	Seal		1
6	4K547	Sensor with (2 cable)		1

AYS Code 4K173



Caliper Guides & Seals Repair Kit K001928

Pos.	AYS Code	Description	Dimension	Qty
1	4K509	GUIDE PIN (LONG)	Ø30 x 99 mm	1
2	4K508	GUIDE PIN (SHORT)	Ø30 x 71,5 mm	1
3	4K515	BOLT (SHORT)	M16x1,5 x 105 mm	1
4	4K512	BOLT (SHORT)	M16x1,5 x 75 mm	1
5	4K528	BRONZE BUSH	Ø34 x Ø30 x 65 mm	1
6	4K535	INNER BOOT (SMALL)		2
7	4K556	BOOT RETAINER RING		2
8	4K545	COVER	Ø34 mm	2
9	4K529	GUIDE SLEEVE	Ø34 x Ø30 x 20 mm	1

AYS Code 4K177



Caliper Bridge Assembly









Pos.	AYS Code	Description	Dimension	Qty
1	4K595	BRIDGE ASSEMBLY		1
2	4K572	SPRING	Ø21 x 51,5 mm	2

AYS Code 4K189



Caliper Plastic Cover (without sensor)

Pos.	AYS Code	Description	Dimension	Qty
1	4K549	Cover		1
2	4K575	Screw with Rivet		4
3	4K557	Adjuster Cap		1
4	4K565	Seal		1
5	4K550	Seal		1

<p>AYS Code 4K007</p>	<p>AYS Code 4K008</p>	<p>AYS Code 4K008-01</p>
		
<p>Caliper Chain (14 links)</p>	<p>Caliper Calibration Bolt (Special)</p>	<p>Caliper Calibration Bolt (Normal)</p>
<p>AYS Code 4K013</p>	<p>AYS Code 4K048</p>	<p>AYS Code 4K068</p>
		
<p>Caliper Adjusting Mechanism</p>	<p>Adjuster Screw Gaiter</p>	<p>Caliper Plug Set</p>
<p>AYS Code 4K174</p>	<p>AYS Code 4K175</p>	<p>AYS Code 4K183</p>
		
<p>Caliper Roller Bearings</p>	<p>Caliper Adjusting Shaft</p>	<p>Caliper Lever</p>

KNORR

SN6/SN7/SK7 SERIES

CALIPER REPAIR KITS

KALİPER TAMİR TAKIMI

AYDINSAN 

www.aydinsan.com.tr

AYS Code 4K019

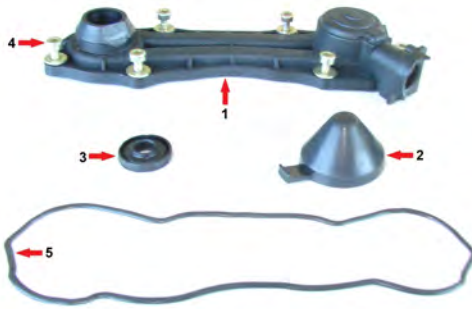

Caliper Plastic Cover (without sensor)

Pos.	AYS Code	Description	Dimension	Qty
1	4K546	Cover		1
2	4K557	Adjuster Cap		1
3	4K550	Seal		1
4	4K575	Screw with Rivet		6
5	4K554	Seal		1

AYS Code 4K020

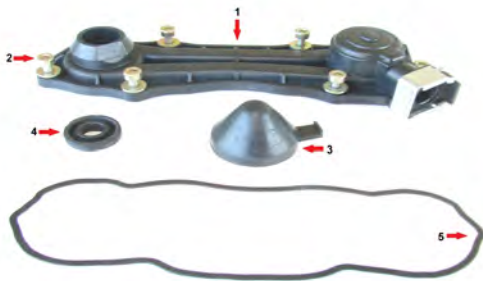

Caliper Plastik Cover (without sensor)

Pos.	AYS Code	Description	Dimension	Qty
1	4K548	Cover		1
2	4K575	Screw with Rivet		6
3	4K557	Adjuster Cap		1
4	4K550	Seal		1
5	4K554	Seal		1

AYS Code 4K021

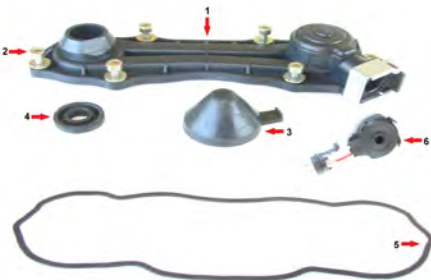

Caliper Plastik Cover (with sensor 2 cable)

Pos.	AYS Code	Description	Dimension	Qty
1	4K548	Cover		1
2	4K575	Screw with Rivet		6
3	4K557	Adjuster Cap		1
4	4K550	Seal		1
5	4K554	Seal		1
6	4K547	Sensor (2 cable)		1

AYS Code 4K033

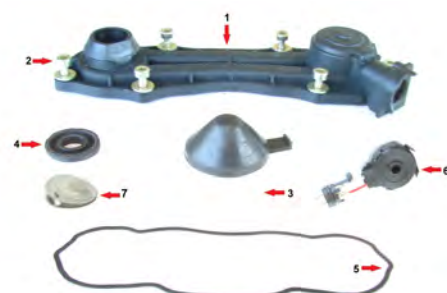

Caliper Sensor Cover (2 cables inside)

Pos.	AYS Code	Description	Dimension	Qty
1	4K546	Cover		1
2	4K575	Screw with Rivet		6
3	4K557	Adjuster Cap		1
4	4K550	Seal		1
5	4K554	Seal		1
6	4K547	Sensor (2 Cable)		1
7	4K559	Tappet		1

AYS Code 4K037



Caliper Sensor Cover

Pos.	AYS Code	Description	Dimension	Qty
1	4K566	Sensor Cover		1
2	4K575	Screw With Rivet		3
3	4K567	Sensor Operating Rod		1
4	4K570	Seal		1

AYS Code 4K038



Caliper Piston Repair Kit

Pos.	AYS Code	Description	Dimension	Qty
1	4K534	TAPPET & BOOT ASSEMBLY		2
2	4K520	TAPPET BUSH		2

AYS Code 4K039



Caliper Guides & Seals Repair Kit K000472

Pos.	AYS Code	Description	Dimension	Qty
1	4K505	GUIDE PIN (LONG)	Ø36 x 114 mm	1
2	4K501	GUIDE PIN (SHORT)	Ø32 x 80 mm	1
3	4K514	BOLT (SHORT)	M16x1,5 x 85 mm	1
4	4K513	BOLT (SHORT)	M16x1,5 x 80 mm	1
5	4K521	BRONZE BUSH	Ø40 x Ø36 x 82 mm	1
6	4K522	METAL-RUBBER BUSH	Ø39 mm (metal end)	1
7	4K531	INNER BOOT		1
8	4K551	RING		1
9	4K543	COVER	Ø40 mm	1
10	4K542	CAP		1

AYS Code 4K040



Caliper Guides & Seals Repair Kit K001915

Pos.	AYS Code	Description	Dimension	Qty
1	4K505	GUIDE PIN (LONG)	Ø36 x 114 mm	1
2	4K501	GUIDE PIN (SHORT)	Ø32 x 80 mm	1
3	4K513	BOLT (SHORT)	M16x1,5 x 80 mm	1
4	4K514	BOLT (SHORT)	M16x1,5 x 85 mm	1
5	4K521	BRONZE BUSH	Ø40 x Ø36 x 82 mm	1
6	4K523	METAL-RUBBER BUSH	Short version	1
7	4K531	INNER BOOT		1
8	4K551	RING		1
9	4K543	COVER	Ø40 mm	1

AYS Code 4K041



Caliper Bridge Assembly

Pos.	AYS Code	Description	Dimension	Qty
1	4K592	BRIDGE ASSEMBLY		1
2	4K571	SPRING	Ø25 x 49 mm	1

AYS Code 4K042



Caliper Bridge Assembly

Pos.	AYS Code	Description	Dimension	Qty
1	4K593	BRIDGE ASSEMBLY		1
2	4K571	SPRING	Ø25 x 49 mm	1

AYS Code 4K045



Caliper Cover

Pos.	AYS Code	Description	Dimension	Qty
1	4K596	COVER WITH GASKET		1
2	4K573	BOLT	M8 x 16 mm	8

AYS Code 4K046



Caliper Cover

Pos.	AYS Code	Description	Dimension	Qty
1	4K599	COVER		1
2	4K573	BOLT (SHORT)	M8 x 16 mm	6
3	4K574	BOLT (LONG)	M8 x 50 mm	2

AYS Code 4K051



Caliper Pad Retainer Repair Kit

Pos.	AYS Code	Description	Dimension	Qty
1	4K557	Adjuster Cap		2
2	4K028	Caliper Pad Retainer Repair Kit		2
3	4K558	Adjuster Cap		2
4	4K563	Adjusting Mechanism Adapter		2
5	4K559	Shoe Retainer		2

AYS Code 4K055



Caliper Plastic Cover (with sensor)

Pos.	AYS Code	Description	Dimension	Qty
1	4K566	SENSOR COVER		1
2	4K575	SCREW WITH RIVET		3
3	4K547	SENSOR (2 CABLE)		1
4	4K567	SENSOR OPERATING ROD		1
5	4K570	SEAL		1

AYS Code 4K127



Caliper Pistons & Seals Repair Kit
K010603/K001300

Pos.	AYS Code	Description	Dimension	Qty
1	4K534	TAPPET & BOOT ASSEMBLY	Ø69 mm	2
2	4K520	TAPPET BUSH	Ø18 x Ø16 x 10 mm	2
3	4K538	INNER SEAL		2

AYS Code 4K164



Caliper Guides & Seals Repair Kit
K004100 K010766

Pos.	AYS Code	Description	Dimension	Qty
1	4K505	GUIDE PIN (LONG)	Ø36 x 114 mm	1
2	4K504	GUIDE PIN (SHORT)	Ø36 x 64 mm	1
3	4K514	BOLT (SHORT)	M16x1,5 x 85 mm	1
4	4K511	BOLT (SHORT)	M16x1,5 x 70 mm	1
5	4K521	BRONZE BUSH	Ø40 x Ø36 x 82 mm	1
6	4K551	RING		2
7	4K531	INNER BOOT		2
8	4K527	GUIDE SLEEVE	Ø40 x Ø36 x 20 mm	1
9	4K544	COVER	Ø40 mm (long)	1
10	4K543	COVER	Ø40 mm	1

AYS Code 4K166



Caliper Adjuster Cap Kit K000945

Pos.	AYS Code	Description	Dimension	Qty
1	4K557	ADJUSTER CAP		10
2	4K558	ADJUSTER CAP		10
3	4K563	MECHANISM ADAPTER		10

AYS Code 4K167



Caliper Adjuster Cap Kit K000029

Pos.	AYS Code	Description	Dimension	Qty
1	4K557	ADJUSTER CAP		10
2	4K563	MECHANISM ADAPTER		10

AYS Code 4K181



Caliper Guides & Seals Repair Kit K000365

Pos.	AYS Code	Description	Dimension	Qty
1	4K505	GUIDE PIN (LONG)	Ø36 x 114 mm	1
2	4K501	GUIDE PIN (SHORT)	Ø32 x 80 mm	1
3	4K502	GUIDE PIN (SHORT)	Ø34 x 80 mm	1
4	4K513	BOLT (SHORT)	M16x1,5 x 80 mm	1
5	4K514	BOLT (LONG)	M16x1,5 x 85 mm	2
6	4K514	BRONZE BUSH	Ø40 x Ø36 x 82 mm	2
7	4K523	METAL-RUBBER BUSH	short version	1
8	4K531	INNER BOOT		1
9	4K551	RING		1
10	4K541	STEEL CAP		1
11	4K553	O-RING		1
12	4K525	RUBBER BUSH		1
13	4K543	COVER	Ø40 mm	1

AYS Code 4K185



Caliper Bush & Guide Repair Kit K000698

Pos.	AYS Code	Description	Dimension	Qty
1	4K501	GUIDE PIN (SHORT)	Ø32 x 80 mm	1
2	4K513	BOLT (SHORT)	M16x1,5 x 80 mm	1
3	4K522	METAL-RUBBER BUSH	Ø39 mm (metal end)	1
4	4K542	CAP		1

AYS Code 4K187



Caliper Adjuster Cap Kit













Pos.	AYS Code	Description	Dimension	Qty
1	4K561	ADJUSTER CAP		10
2	4K558	ADJUSTER CAP		10
3	4K563	MECHANISM ADAPTER		10

AYS Code 4K188



Caliper Adjuster Cap Kit

Pos.	AYS Code	Description	Dimension	Qty
1	4K561	ADJUSTER CAP		10
2	4K563	MECHANISM ADAPTER		10

<p>AYS Code 4K005</p>	<p>AYS Code 4K008</p>	<p>AYS Code 4K008-01</p>
		
<p>Caliper Roller Bearings</p>	<p>Caliper Calibration Bolt (Special)</p>	<p>Caliper Calibration Bolt (Normal)</p>
<p>AYS Code 4K010</p>	<p>AYS Code 4K011</p>	<p>AYS Code 4K028</p>
		
<p>Caliper Adjusting Mechanism Adapter Set</p>	<p>Caliper Adjusting Mechanism Wheel Set</p>	<p>Caliper Pad Retainer Repair Kit</p>
<p>AYS Code 4K029</p>	<p>AYS Code 4K029-01</p>	<p>AYS Code 4K030</p>
		
<p>Caliper Adjusting Mechanism (Special)</p>	<p>Caliper Adjusting Mechanism (Normal)</p>	<p>Caliper Adjusting Shaft (with spring)</p>
<p>AYS Code 4K031</p>	<p>AYS Code 4K035</p>	<p>AYS Code 4K043</p>
		
<p>Caliper Chain (29 links)</p>	<p>Caliper Lever (Angle 0° - 114 mm)</p>	<p>Caliper Lever (Angle 0° - 126 mm)</p>

<p>AYS Code 4K044</p>	<p>AYS Code 4K068</p>	<p>AYS Code 4K176</p>
<p>Caliper Lever (Angle 0° - 113 mm)</p>	<p>Caliper Plug Set</p>	<p>Caliper Lever (Angle 12° - 123 mm)</p>
<p>AYS Code 4K178</p>	<p>AYS Code 4K179</p>	<p>AYS Code 4K182</p>
<p>Caliper Lever (Angle 0° - 113 mm)</p>	<p>Caliper Lever (Angle 12° - 122 mm)</p>	<p>Caliper Lever Bearing Set</p>

KNORR

SL7/SM7 SERIES

CALIPER REPAIR KITS

KALİPER TAMİR TAKIMI



AYS Code 4K019

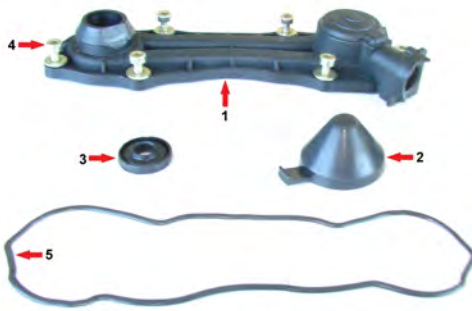

Caliper Plastic Cover (without sensor)

Pos.	AYS Code	Description	Dimension	Qty
1	4K546	Cover		1
2	4K557	Adjuster Cap		1
3	4K550	Seal		1
4	4K575	Screw with Rivet		6
5	4K554	Seal		1

AYS Code 4K040



Caliper Guides & Seals Repair Kit K001915

Pos.	AYS Code	Description	Dimension	Qty
1	4K505	GUIDE PIN (LONG)	Ø36 x 114 mm	1
2	4K501	GUIDE PIN (SHORT)	Ø32 x 80 mm	1
3	4K513	BOLT (SHORT)	M16x1,5 x 80 mm	1
4	4K514	BOLT (SHORT)	M16x1,5 x 85 mm	1
5	4K521	BRONZE BUSH	Ø40 x Ø36 x 82 mm	1
6	4K523	METAL-RUBBER BUSH	Short version	1
7	4K531	INNER BOOT		1
8	4K551	RING		1
9	4K543	COVER	Ø40 mm	1

AYS Code 4K042



Caliper Bridge Assembly

Pos.	AYS Code	Description	Dimension	Qty
1	4K593	BRIDGE ASSEMBLY		1
2	4K571	SPRING	Ø25 x 49 mm	1

AYS Code 4K046



Caliper Cover

Pos.	AYS Code	Description	Dimension	Qty
1	4K599	COVER		1
2	4K573	BOLT (SHORT)	M8 x 16 mm	6
3	4K574	BOLT (LONG)	M8 x 50 mm	2

AYS Code 4K053

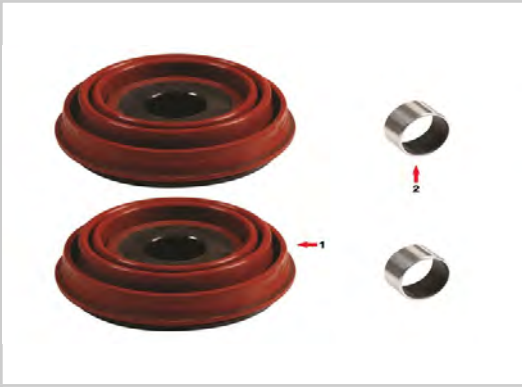

Caliper Piston Repair Kit







Pos.	AYS Code	Description	Dimension	Qty
1	4K568	TAPPET & BOOT ASSEMBLY(54mm Tappet)	Ø69 mm	2
2	4K569	TAPPET BUSH	Ø17xØ15x7mm	2

AYS Code 4K056



Caliper Piston & Seal Repair Kit

Pos.	AYS Code	Description	Dimension	Qty
1	4K568	TAPPET & BOOT ASSEMBLY (54mm Tappet)	Ø69 mm	2
2	4K569	TAPPET BUSH	Ø17xØ15x7mm	2
3	4K538	INNER SEAL		2

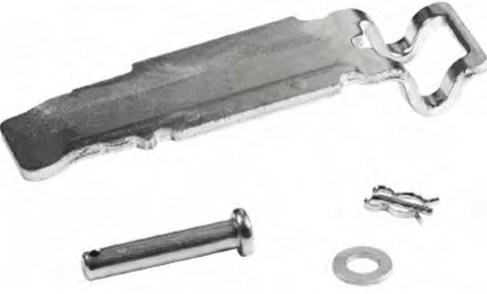
<p>AYS Code 4K009</p>	<p>AYS Code 4K009-01</p>	<p>AYS Code 4K029</p>
		
<p>Caliper Calibration Bolt (Special)</p>	<p>Caliper Calibration Bolt (Normal)</p>	<p>Caliper Adjusting Mechanism (Special)</p>
<p>AYS Code 4K029-01</p>	<p>AYS Code 4K031</p>	<p>AYS Code 4K052</p>
		
<p>Caliper Adjusting Mechanism (Normal)</p>	<p>Caliper Chain (29 links)</p>	<p>Caliper Adjusting Shaft (Without Spring)</p>
<p>AYS Code 4K057</p>	<p>AYS Code 4K060</p>	
		
<p>Caliper Lever</p>	<p>Caliper Pad Retainer Repair Kit</p>	

KNORR

SETS

CALIPER REPAIR KITS

KALİPER TAMİR TAKIMI

AYDINSAN 

www.aydinsan.com.tr

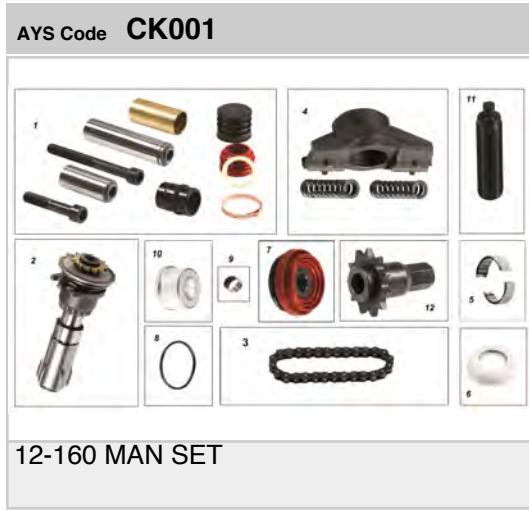

Pos.	AYS Code	Description	Dimension	Qty
1	4K002	Caliper Guides & Seals Repair Kit		1
2	4K013	Caliper Adjusting Mechanism		1
3	4K169	Caliper Chain (12 links)		1
4	4K014	Caliper Bridge Assembly		1
5	4K168	Caliper Roller Bearings		1
6	4K537	Inner Seal		1
7	4K533	Tappet & Boot Assembly	Ø74 mm	1
9	4K553	O-ring		1
9	4K520	Teflon Bush	Ø18 x Ø16 x 10 mm	1
10	4K541	Steel Cap		1
11	4K008	Caliper Calibration Bolt		1
12	4K012	Caliper Adjusting Shaft		1



Pos.	AYS Code	Description	Dimension	Qty
1	4K173	Caliper Guides & Seals Repair Kit		1
2	4K560	Adjuster Screw Gaiter		1
3	4K001	Caliper Piston Repair Kit		1
4	4K177	Caliper Bridge Assembly		1
5	4K174	Caliper Roller Bearings		1
6	4K175	Caliper Adjusting Shaft		1
7	4K013	Caliper Adjusting Mechanism		1
8	4K008	Caliper Calibration Bolt		1
9	4K007	Caliper Chain (14 links)		1
10	4K047	Caliper Cover		1



Pos.	AYS Code	Description	Dimension	Qty
1	4K040	Caliper Guides & Seals Repair Kit		1
2	4K016	Caliper Piston & Seals Repair Kit		1
3	4K008	Caliper Calibration Bolt		2
4	4K032	Caliper Bridge Assembly		1
5	4K031	Caliper Chain (29 links)		1
6	4K029	Caliper Adjusting Mechanism		1
7	4K030	Caliper Adjusting Shaft (with spring)		1
8	4K168	Caliper Roller Bearings		1



Pos.	AYS Code	Description	Dimension	Qty
1	4K164	Caliper Guides & Seals Repair Kit		1
2	4K127	Caliper Pistons & Seals Repair Kit		1
3	4K042	Caliper Bridge Assembly		1
4	4K168	Caliper Roller Bearings		1
5	4K030	Caliper Adjusting Shaft (with spring)		1
6	4K029	Caliper Adjusting Mechanism		1
7	4K045	Caliper Cover		1
8	4K031	Caliper Chain (29 links)		1
9	4K008	Caliper Calibration Bolt		2



Pos.	AYS Code	Description	Dimension	Qty
1	4K040	Caliper Guides & Seals Repair Kit		1
2	4K016	Caliper Piston & Seals Repair Kit		1
3	4K032	Caliper Bridge Assembly		1
4	4K031	Caliper Chain (29 links)		1
5	4K030	Caliper Adjusting Shaft (with spring)		1
6	4K008	Caliper Calibration Bolt		2
7	4K029	Caliper Adjusting Mechanism		1
8	4K005	Caliper Roller Bearings		1



Pos.	AYS Code	Description	Dimension	Qty
1	4K039	Caliper Guides & Seals Repair Kit		1
2	4K127	Caliper Pistons & Seals Repair Kit		1
3	4K008	Caliper Calibration Bolt		2
4	4K029	Caliper Adjusting Mechanism		1
5	4K031	Caliper Chain (29 links)		1
6	4K030	Caliper Adjusting Shaft (with spring)		1
7	4K005	Caliper Roller Bearings		1
8	4K045	Caliper Cover		1
9	4K041	Caliper Bridge Assembly		1



Pos.	AYS Code	Description	Dimension	Qty
1	4K003	Caliper Guides & Seals Repair Kit		1
2	4K127	Caliper Pistons & Seals Repair Kit		1
3	4K008	Caliper Calibration Bolt		2
4	4K029	Caliper Adjusting Mechanism		1
5	4K031	Caliper Chain (29 links)		1
6	4K030	Caliper Adjusting Shaft (with spring)		1
7	4K042	Caliper Bridge Assembly		1
8	4K168	Caliper Roller Bearings		1
9	4K045	Caliper Cover		1



Pos.	AYS Code	Description	Dimension	Qty
1	4K040	Caliper Guides & Seals Repair Kit		1
2	4K041	Caliper Bridge Assembly		1
3	4K005	Caliper Roller Bearings		1
4	4K031	Caliper Chain (29 links)		1
5	4K030	Caliper Adjusting Shaft (with spring)		1
6	4K029	Caliper Adjusting Mechanism		1
7	4K016	Caliper Piston & Seals Repair Kit		1
8	4K008	Caliper Calibration Bolt		2

MERITOR

D3 TYPE

CALIPER REPAIR KITS

KALİPER TAMİR TAKIMI



AYS Code 4M057



Caliper Seal and Circlip Kit

Pos.	AYS Code	Description	Dimension	Qty
1	4M734	SEAL		10
2	4M674	CIRCLIP		10

AYS Code 4M083



Caliper Guides & Seals Repair Kit SJ4011 / SJ4012

Pos.	AYS Code	Description	Dimension	Qty
1	4M503	GUIDE PIN (LONG)	Ø32 x 117 mm	1
2	4M555	BOLT (LONG)	M18x1,5 x 120 mm	1
3	4M502	GUIDE PIN (SHORT)	Ø32 x 73 mm	1
4	4M554	BOLT (SHORT)	M18x1,5 x 95 mm	1
5	4M522	PLAIN BUSH	Ø36 x Ø32 x 40 mm	2
6	4M581	DUST EXCLUDER		2
7	4M547	STEEL CAP	Ø61 mm	2
8	4M524	BRONZE OVAL BUSH	Ø36 x Ø33,2/32,5 x 30 mm	1
9	4M541	STEEL CAP	Ø37 mm	2

AYS Code 4M084



Caliper Overhaul Repair Kit (Front - Left)

Pos.	AYS Code	Description	Dimension	Qty
1	4M733	DUST COVER		1
2	4M088	SHAFT ASSEMBLY (SHORT - LEFT)	26 TEETH	1
3	4M689	Screw	M8 x 40mm	4
4	4M688	Screw	M8 x 16mm	2
5	4M102	SHAFT ROLLER BEARING		1
6	4M101	SHAFT ROLLER BEARING		1
7	4M103	WAVY WASHER		1
8	4M629	PLASTIC COVER		1
9	4M661	LARGE SPRING (LEFT)		1
10	4M630	DUST EXCLUDER		1
11	4M104	SHAFT BUSH		1
12	4M105	ADJUSTER BOLT		1
13	4M096	TAPPET ADJUSTER ASSEMBLY (LEFT)		1
14	4M100	GEAR		1
15	4M662	SMALL SPRING (LEFT)		1
16	4M631	ADJUSTER COVER		1

AYS Code 4M085



Caliper Overhaul Repair Kit (Front - Right)

Pos.	AYS Code	Description	Dimension	Qty
1	4M733	DUST COVER		1
2	4M089	SHAFT ASSEMBLY (SHORT - RIGHT)	26 TEETH	1
3	4M689	Screw	M8 x 40mm	4
4	4M688	Screw	M8 x 16mm	2
5	4M102	SHAFT ROLLER BEARING		1
6	4M101	SHAFT ROLLER BEARING		1
7	4M103	WAVY WASHER		1
8	4M629	PLASTIC COVER		1
9	4M663	LARGE SPRING (RIGHT)		1
10	4M630	DUST EXCLUDER		1
11	4M104	SHAFT BUSH		1
12	4M105	ADJUSTER BOLT		1
13	4M097	TAPPET ADJUSTER ASSEMBLY (RIGHT)		1
14	4M100	GEAR		1
15	4M664	SMALL SPRING (RIGHT)		1
16	4M631	ADJUSTER COVER		1

AYS Code 4M086



Caliper Overhaul Repair Kit (Rear - Left)

Pos.	AYS Code	Description	Dimension	Qty
1	4M733	DUST COVER		1
2	4M092	SHAFT ASSEMBLY (LONG - LEFT)	26 TEETH	1
3	4M689	Screw	M8 x 40mm	4
4	4M688	Screw	M8 x 16mm	2
5	4M096	TAPPET ADJUSTER ASSEMBLY (LEFT)		1
6	4M102	SHAFT ROLLER BEARING		1
7	4M101	SHAFT ROLLER BEARING		1
8	4M103	WAVY WASHER		1
9	4M629	PLASTIC COVER		1
10	4M661	LARGE SPRING (LEFT)		1
11	4M630	DUST EXCLUDER		1
12	4M104	SHAFT BUSH		1
13	4M105	ADJUSTER BOLT		1
14	4M100	GEAR		1
15	4M662	SMALL SPRING (LEFT)		1
16	4M631	ADJUSTER COVER		1

AYS Code 4M087



Caliper Overhaul Repair Kit (Rear - Right)

Pos.	AYS Code	Description	Dimension	Qty
1	4M733	DUST COVER		1
2	4M093	SHAFT ASSEMBLY (LONG - RIGHT)	26 TEETH	1
3	4M689	Screw	M8 x 40mm	4
4	4M688	Screw	M8 x 16mm	2
5	4M102	SHAFT ROLLER BEARING		1
6	4M101	SHAFT ROLLER BEARING		1
7	4M103	WAVY WASHER		1
8	4M629	PLASTIC COVER		1
9	4M663	LARGE SPRING (RIGHT)		1
10	4M630	DUST EXCLUDER		1
11	4M104	SHAFT BUSH		1
12	4M105	ADJUSTER BOLT		1
13	4M097	TAPPET ADJUSTER ASSEMBLY (RIGHT)		1
14	4M100	GEAR		1
15	4M664	SMALL SPRING (RIGHT)		1
16	4M631	ADJUSTER COVER		1

AYS Code 4M098



Caliper Dust Cover

Pos.	AYS Code	Description	Dimension	Qty
1	4M733	DUST COVER		1
2	4M689	SCREW	M8 x 40mm	4
3	4M688	SCREW	M8 x 16mm	2

AYS Code 4M099



Caliper Dust Cover & Seals Repair Kit

Pos.	AYS Code	Description	Dimension	Qty
1	4M733	DUST COVER		1
2	4M629	PLASTIC COVER		1
3	4M631	ADJUSTER COVER		1
4	4M689	Screw	M8 x 40mm	4
5	4M630	DUST EXCLUDER		1
6	4M688	Screw	M8 x 16mm	2

AYS Code 4M106

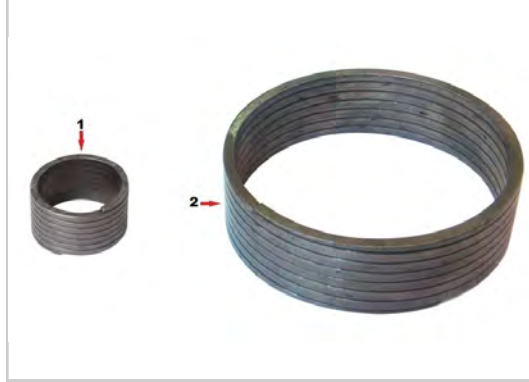

Caliper Spring Set (Left)

Pos.	AYS Code	Description	Dimension	Qty
1	4M662	SMALL SPRING (LEFT)		1
2	4M661	LARGE SPRING (LEFT)		1

AYS Code 4M107

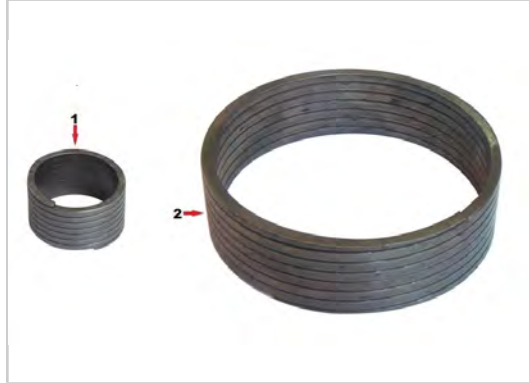

Caliper Spring Set (Right)

Pos.	AYS Code	Description	Dimension	Qty
1	4M664	SMALL SPRING (RIGHT)		1
2	4M663	LARGE SPRING (RIGHT)		1

AYS Code 4M185

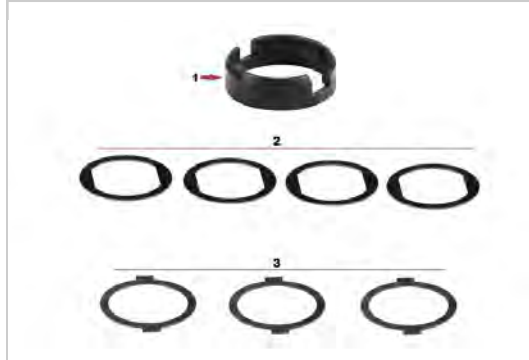

Caliper Clutch Repair Kit

Pos.	AYS Code	Description	Dimension	Qty
1	4M650	CLUTCH		1
2	4M652	CLUTCH PLATE		4
3	4M651	CLUTCH PLATE		3

AYS Code 4M244



Caliper Repair Kit (Left)

Pos.	AYS Code	Description	Dimension	Qty
1	4M100	Gear		
2	4M105	Adjuster Bolt		
3	4M662	Small Spring (Left)		
4	4M706	Washer		
5	4M631	Adjuster Cover		









AYS Code **4M245**



Caliper Repair Kit (Right)

Pos.	AYS Code	Description	Dimension	Qty
1	4M100	Gear		
2	4M105	Adjuster Bolt		
3	4M664	Small Spring (Right)		
4	4M706	Washer		
5	4M631	Adjuster Cover		

<p>AYS Code 4M056</p>	<p>AYS Code 4M088</p>	<p>AYS Code 4M089</p>
<p>Caliper Circlip Kit</p>	<p>Caliper Shaft Assembly (Short - Left)</p>	<p>Caliper Shaft Assembly (Short - Right)</p>
<p>AYS Code 4M090</p>	<p>AYS Code 4M091</p>	<p>AYS Code 4M092</p>
<p>Caliper Shaft Assembly (Short - Left)</p>	<p>Caliper Shaft Assembly (Short - Right)</p>	<p>Caliper Shaft Assembly (Long - Left)</p>
<p>AYS Code 4M093</p>	<p>AYS Code 4M094</p>	<p>AYS Code 4M095</p>
<p>Caliper Shaft Assembly (Long - Right)</p>	<p>Caliper Shaft Support (Left)</p>	<p>Caliper Shaft Support (Right)</p>
<p>AYS Code 4M096</p>	<p>AYS Code 4M097</p>	<p>AYS Code 4M100</p>
<p>Caliper Tappet Adjuster Assembly (Left)</p>	<p>Caliper Tappet Adjuster Assembly (Right)</p>	<p>Caliper Gear</p>

<p>AYS Code 4M101</p>	<p>AYS Code 4M102</p>	<p>AYS Code 4M103</p>
		
<p>Caliper Shaft Roller Bearing</p>	<p>Caliper Shaft Roller Bearing</p>	<p>Caliper Wavy Washer</p>
<p>AYS Code 4M104</p>	<p>AYS Code 4M105</p>	<p>AYS Code 4M186</p>
		
<p>Caliper Shaft Bush</p>	<p>Caliper Adjuster Bolt</p>	<p>Caliper Return Spring</p>
<p>AYS Code 4M187</p>	<p>AYS Code 4M252</p>	
		
<p>Caliper Push Plate</p>	<p>Caliper Calibration Bolt Seal</p>	

MERITOR

DUCO TYPE

CALIPER REPAIR KITS

KALİPER TAMİR TAKIMI



AYS Code 4M108



Caliper Guides & Seals Repair Kit MCK118

Pos.	AYS Code	Description	Dimension	Qty
1	4M559	BOLT	M20x2 x 124 mm	2
2	4M507	GUIDE PIN	Ø35 x 102 mm	2
3	4M582	DUST EXCLUDER		2
4	4M530	PLASTIC BUSH	Ø39 x Ø35 x 76,5 mm	1
5	4M542	STEEL CAP	Ø40 mm	2
6	4M525	BRONZE OVAL BUSH	Ø39 x Ø36,2/35,3 x 30 mm	2
7	4M571	DUST EXCLUDER RETAINER	Ø39 / Ø37 mm	2

AYS Code 4M109



Caliper Guides & Seals Repair Kit MCK116

Pos.	AYS Code	Description	Dimension	Qty
1	4M507	GUIDE PIN (LONG)	Ø35 x 102 mm	1
2	4M559	BOLT (LONG)	M20x2 x 124 mm	1
3	4M504	GUIDE PIN (SHORT)	Ø35 x 60 mm	1
4	4M557	BOLT (SHORT)	M20x2 x 83 mm	1
5	4M530	PLASTIC BUSH	Ø39 x Ø35 x 76,5 mm	1
6	4M582	DUST EXCLUDER		2
7	4M571	DUST EXCLUDER RETAINER	Ø39 / Ø37 mm	2
8	4M525	BRONZE OVAL BUSH	Ø39 x Ø36,2/35,3 x 30 mm	1
9	4M542	STEEL CAP	Ø40 mm	2

AYS Code 4M110



Caliper Guide & Dust Cover Repair Kit MCK1299

Pos.	AYS Code	Description	Dimension	Qty
1	4M507	GUIDE PIN	Ø35 x 102 mm	1
2	4M582	DUST EXCLUDER		2
3	4M542	STEEL CAP	Ø40 mm	2

AYS Code 4M112



Caliper Tappet Head Repair Kit MCK1238

Pos.	AYS Code	Description	Dimension	Qty
1	4M584	TAPPET DUST EXCLUDER		2
2	4M611	PISTON HEAD		2
3	4M613	PISTON HEAD CIRCLIP		2

AYS Code 4M113

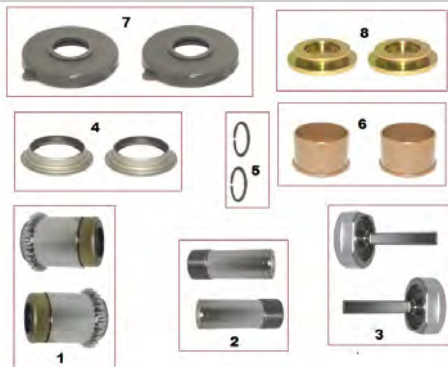

Caliper Adjuster Tappet Repair Kit (Left)
MCK1236

Pos.	AYS Code	Description	Dimension	Qty
1	4M608	TAPPET GEAR (LEFT)		2
2	4M608-01	TAPPET SCREW (LEFT)		2
3	4M608-02	TAPPET PIN		2
4	4M579	DUST EXCLUDER RETAINER	Ø49 / 45 mm	2
5	4M613	PISTON HEAD CIRCLIP		2
6	4M532	PLASTIC BUSH	Ø49 x Ø45 x 30 mm	2
7	4M584	TAPPET DUST EXCLUDER		2
8	4M611	PISTON HEAD		2

AYS Code 4M114

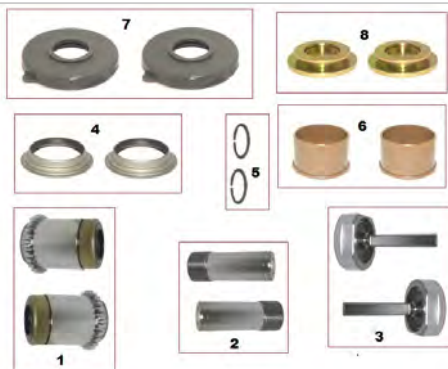

Caliper Adjuster Tappet Repair Kit (Right)
MCK1237

Pos.	AYS Code	Description	Dimension	Qty
1	4M609	TAPPET GEAR (RIGHT)		2
2	4M609-01	TAPPET SCREW (RIGHT)		2
3	4M609-02	TAPPET PIN		2
4	4M579	DUST EXCLUDER RETAINER	Ø49 / 45 mm	2
5	4M613	PISTON HEAD CIRCLIP		2
6	4M532	PLASTIC BUSH	Ø49 x Ø45 x 30 mm	2
7	4M584	TAPPET DUST EXCLUDER		2
8	4M611	PISTON HEAD		2

AYS Code 4M115



Caliper Gear & Springs Repair
Kit MCK1067

Pos.	AYS Code	Description	Dimension	Qty
1	4M648	INTERMEDIATE GEAR		1
2	4M666	FRICTION SPRING		1
3	4M665	RETURN SPRING		1

AYS Code 4M120



Caliper Lever Repair Kit (Axial - Right)
SJ4097

Pos.	AYS Code	Description	Dimension	Qty
1	4M691	CALIPER LEVER (RIGHT)		1
2	4M633	HALF BEARING		2
3	4M071	ROLLER BEARING SET		1
4	4M628	ACTUATOR SEAL		1

AYS Code 4M121

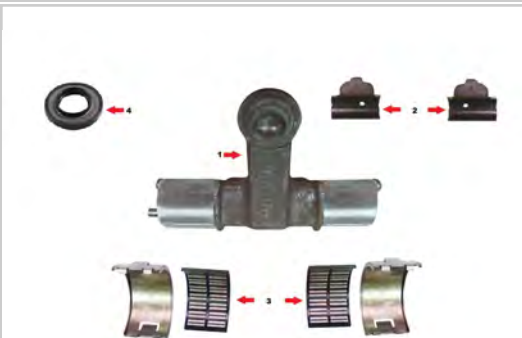

Caliper Lever Repair Kit (Axial - Left)
SJ4096

Pos.	AYS Code	Description	Dimension	Qty
1	4M692	CALIPER LEVER (LEFT)		1
2	4M633	HALF BEARING		2
3	4M071	ROLLER BEARING SET		1
4	4M628	ACTUATOR SEAL		1

AYS Code 4M122



Caliper Lever Repair Kit (Radial L/R)
MCK4108

Pos.	AYS Code	Description	Dimension	Qty
1	4M693	CALIPER LEVER		1
2	4M628	ACTUATOR SEAL		1
3	4M071	ROLLER BEARING SET		1
4	4M672	HALF BEARING		2

AYS Code 4M124

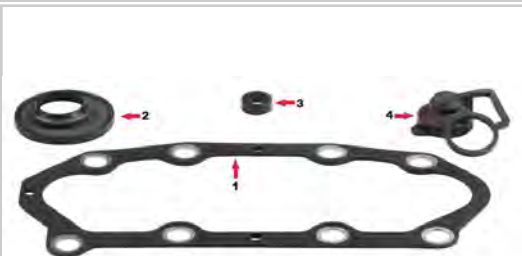

Caliper Cover Plate Seal Repair Kit
SJ4109

Pos.	AYS Code	Description	Dimension	Qty
1	4M624	GASKET		1
2	4M628	ACTUATOR SEAL		1
3	4M627	ADJUSTER SEAL		1
4	4M163	ADJUSTER DUST COVER		1

AYS Code 4M125



Caliper Cover Plate Seal Repair Kit
SJ4105

Pos.	AYS Code	Description	Dimension	Qty
1	4M625	GASKET		1
2	4M163	ADJUSTER DUST COVER		1
3	4M628	ACTUATOR SEAL		1
4	4M627	ADJUSTER SEAL		1

AYS Code 4M126



Caliper Cover Plate Seal Repair Kit MCK1041

Pos.	AYS Code	Description	Dimension	Qty
1	4M626	GASKET		1
2	4M627	ADJUSTER SEAL		1
3	4M163	ADJUSTER DUST COVER		1
4	4M628	ACTUATOR SEAL		1

AYS Code 4M204

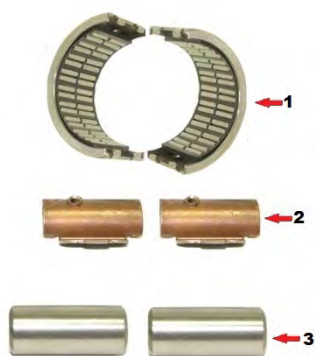

Caliper Half Bearing Repair Kit (Radial)

Pos.	AYS Code	Description	Dimension	Qty
1	4M071	ROLLER BEARING SET		1
2	4M672	HALF BEARING		2
3	4M634	ROLLER		2

AYS Code 4M208



Caliper Adjuster Seal & Cover Repair Kit

Pos.	AYS Code	Description	Dimension	Qty
1	4M163	ADJUSTER DUST COVER		1
2	4M627	ADJUSTER SEAL		1
3	4M704	DUST COVER RETAINER		1

AYS Code 4M226

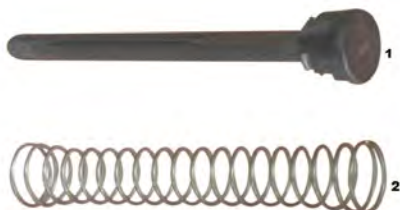

Caliper Visual Indicator













Pos.	AYS Code	Description	Dimension	Qty
1	4M722	VISUAL INDICATOR		1
2	4M670	VISUAL INDICATOR SPRING	Ø16 x Ø80 mm	1

AYS Code **4M253**

Pos.	AYS Code	Description	Dimension	Qty
1	4M253	Pad Retainer		1
2	4M698	Screw	M10 x 1.25 / 20 mm	1



Caliper Pad Retainer Repair Kit.

<p>AYS Code 4M071</p>	<p>AYS Code 4M111</p>	<p>AYS Code 4M116</p>
		
<p>Caliper Roller Bearings</p>	<p>Caliper Tappet Dust Covers MCK1139</p>	<p>Caliper Automatic Adjuster (Radial - L/R) MCK1113</p>
<p>AYS Code 4M118</p>	<p>AYS Code 4M119</p>	<p>AYS Code 4M123</p>
		
<p>Caliper Automatic Adjuster (Axial - Right) MCK1112</p>	<p>Caliper Automatic Adjuster (Axial - Left) MCK1111</p>	<p>Caliper Tappet Anti-Rotation Plate 68322900PK10</p>
<p>AYS Code 4M163</p>	<p>AYS Code 4M221</p>	<p>AYS Code 4M249</p>
		
<p>Caliper Adjuster Dust Cover 68322655PK10</p>	<p>Caliper Dust Excluder Retainer Set</p>	<p>Caliper Gear Mechanism Right</p>
<p>AYS Code 4M250</p>	<p>AYS Code 4M255</p>	<p>AYS Code 4M256</p>
		
<p>Caliper Gear Mechanism Left</p>	<p>Caliper Pad Retainer Repair Kit</p>	<p>Caliper Pad Retainer Repair Kit</p>

MERITOR

DX.195/225 TYPE

CALIPER REPAIR KITS

KALİPER TAMİR TAKIMI



AYS Code 4M048



Caliper Overhaul Repair Kit MCK1171

Pos.	AYS Code	Description	Dimension	Qty
1	4M512	GUIDE PIN (LONG)	Ø32 x 97,5 mm	1
2	4M519	GUIDE PIN (SHORT)	Ø32 x 97,5 mm	1
3	4K514	BOLT (LONG)	M16x1,5 x 85 mm	1
4	4M551	BOLT (SHORT)	M16x1,5 x 55 mm	1
5	4M587	PISTON DUST EXCLUDER		2
6	4M543	STEEL CAP	Ø42 mm	2
7	4M588	GUIDE PIN DUST EXCLUDER		2
8	4M616	SEAL		2
9	4M632	GASKET		1
10	4M533	PLAIN BUSH	Ø36 x Ø32 x 55 mm	2
11	4M637	WASHER	Ø19 / Ø13 mm	1
12	4M686	PLUG SCREW		1
13	4M685	PLATE SCREW	M12x1,75 x 29 mm	4
14	4M684	PLATE SCREW	M12x1,75 x 23 mm	2
15	4M683	PISTON SCREW	M10x1,5 x 20 mm	2
16	4M682	COVER PLATE SCREW	M8x1,25 x 20 mm	2

AYS Code 4M049



Caliper Shaft Assembly

Pos.	AYS Code	Description	Dimension	Qty
1	4M646	ECCENTRIC SHAFT		1
2	4M593	ECCENTRIC SHAFT BEARING	Ø52 / Ø46 x 20 mm	2
3	4M636	ECCENTRIC SHAFT SEAL	Ø44 / Ø35 mm	1

AYS Code 4M053



Caliper Push Plate Repair Kit (Right)

Pos.	AYS Code	Description	Dimension	Qty
1	4M205	PUSH PLATE		1
2	4M228	CALIBRATION BOLT		2
3	4M683	PISTON SCREW	M10x1,5 x 20 mm	2

AYS Code 4M054



Caliper Push Plate Repair Kit (Left)

Pos.	AYS Code	Description	Dimension	Qty
1	4M205	PUSH PLATE		1
2	4M229	CALIBRATION BOLT		2
3	4M683	PISTON SCREW	M10x1,5 x 20 mm	2

AYS Code 4M193



Caliper Guide & Caps Repair Kit
MCK1171/N

Pos.	AYS Code	Description	Dimension	Qty
1	4M512	GUIDE PIN	Ø32 x 97,5 mm	2
2	4K514	BOLT (LONG)	M16x1,5 x 85 mm	1
3	4M551	BOLT (SHORT)	M16x1,5 x 55 mm	1
4	4M533	PLAIN BUSH	Ø36 x Ø32 x 55 mm	2
5	4M543	STEEL CAP	Ø42 mm	2

AYS Code 4M236



Caliper Shaft Bearing

Pos.	AYS Code	Description	Dimension	Qty
1	4M632	GASKET		1
2	4M682	SCREW	M8x1,25 x 20 mm	2
3	4M699	SHAFT BEARING		1

AYS Code 4M238



Caliper Centering Gear Set

Pos.	AYS Code	Description	Dimension	Qty
1	4M729	GEAR		1
2	4M728	FORK GEAR		1

AYS Code 4M240



Caliper Adjusting Mechanism Repair Kit
Right

Pos.	AYS Code	Description	Dimension	Qty
1	4M675	Adjusting Mechanism Right		1
2	4M676	Calibration Bolt		1
3	4M673	Spring		1
4	4M678	Washer		2
5	4M679	Ring		2
6	4M677	Clamp		2

AYS Code 4M241



Caliper Adjusting Mechanism Repair Kit Left

Pos.	AYS Code	Description	Dimension	Qty
1	4M680	Adjusting Mechanism (Left)		
2	4M676	Calibration Bolt		
3	4M673	Spring		
4	4M678	Washer		
5	4M679	Ring		
6	4M677	Clamp		

AYS Code 4M242



Caliper Bearing Repair Kit





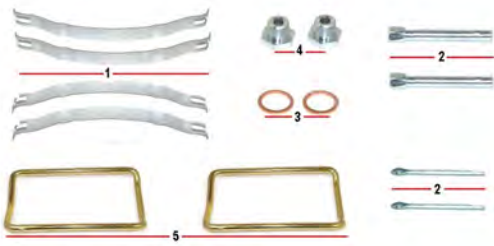







Pos.	AYS Code	Description	Dimension	Qty
1	4M687	BEARING OUTER RACE		1
2	4M050	ROLLER BEARING		1
3	4M593	EXCENTRIC SHAFT ROLLER BEARING	Ø52 / Ø46 x 20 mm	2

AYS Code 4M248



Caliper Pad Retainer Repair Kit

Pos.	AYS Code	Description	Dimension	Qty
1	4M248-02	Shoe Retainer		4
2	4M710	Fixing Pin		2
3	4M248-03	Washer		2
4	4M248-01	Screw		2
5	4M237	Pad Retainer		2

<p>AYS Code 4M050</p>	<p>AYS Code 4M062</p>	<p>AYS Code 4M164</p>
		
<p>Caliper Roller Bearing</p>	<p>Caliper Shaft Lever</p>	<p>Shaft Dust Cover</p>
<p>AYS Code 4M165</p>	<p>AYS Code 4M194</p>	<p>AYS Code 4M205</p>
		
<p>Cover Plate Seal</p>	<p>Caliper Bridge Assembly</p>	<p>Caliper Push Plate</p>
<p>AYS Code 4M228</p>	<p>AYS Code 4M229</p>	<p>AYS Code 4M233</p>
		
<p>Caliper Calibration Bolt (Right)</p>	<p>Caliper Calibration Bolt (Left)</p>	<p>Caliper Adjustment Sleeve (Driven)-(Left)</p>
<p>AYS Code 4M234</p>	<p>AYS Code 4M237</p>	<p>AYS Code 4M243</p>
		
<p>Caliper Adjustment Sleeve (Driven)-(Right)</p>	<p>Caliper Pad Retainer</p>	<p>Caliper Bearing Outer Race Set</p>

MERITOR

ELSA1 TYPE

CALIPER REPAIR KITS

KALİPER TAMİR TAKIMI



AYS Code 4M070

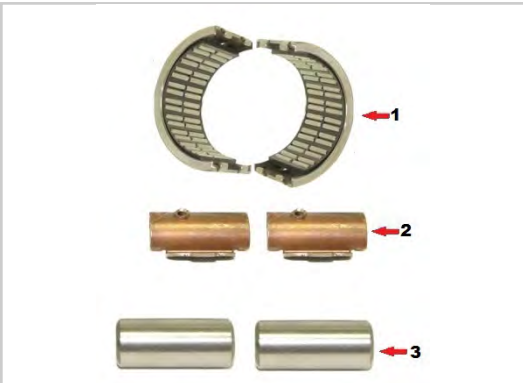

Caliper Half Bearing Repair Kit (Axial) SJ4112

Pos.	AYS Code	Description	Dimension	Qty
1	4M071	ROLLER BEARING SET		1
2	4M633	HALF BEARING		2
3	4M634	ROLLER		2

AYS Code 4M077

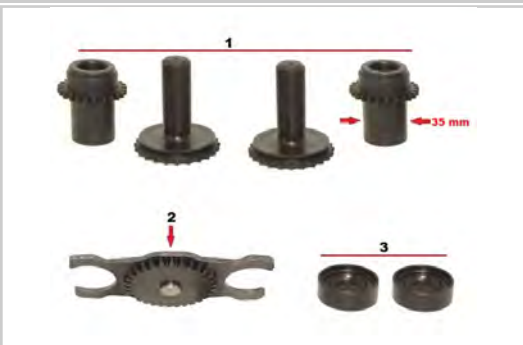

Caliper Tappet Adjusting Mechanism (Right)

Pos.	AYS Code	Description	Dimension	Qty
1	4M075	TAPPET GEAR ASSEMBLY (RIGHT)		2
2	4M649	INTERMEDIATE GEAR		1
3	4M635	STEEL CAP		2

AYS Code 4M078

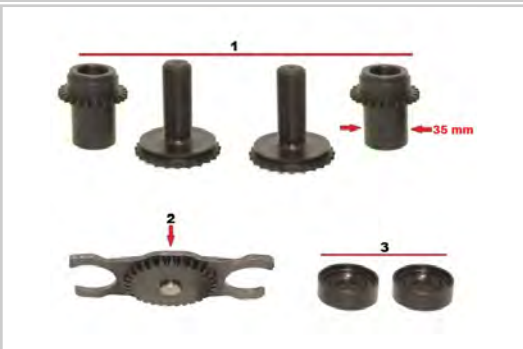

Caliper Tappet Adjusting Mechanism (Left)

Pos.	AYS Code	Description	Dimension	Qty
1	4M076	TAPPET GEAR ASSEMBLY (LEFT)		2
2	4M649	INTERMEDIATE GEAR		1
3	4M635	STEEL CAP		2

AYS Code 4M080



Caliper Spring & Retainers Repair Kit (Right)

Pos.	AYS Code	Description	Dimension	Qty
1	4M668	LEVER SPRING (RIGHT)		1
2	4M640	LEVER PIN RETAINER		1
3	4M705	SPRING RETAINER		1
4	4M639	SPRING BRACKET		1

AYS Code 4M081



Caliper Spring & Retainers Repair Kit (Left)

Pos.	AYS Code	Description	Dimension	Qty
1	4M669	LEVER SPRING (LEFT)		1
2	4M640	LEVER PIN RETAINER		1
3	4M705	SPRING RETAINER		1
4	4M639	SPRING BRACKET		1

AYS Code 4M141



Caliper Guides & Seals Repair Kit MCK1103

Pos.	AYS Code	Description	Dimension	Qty
1	4M560	BOLT (LONG)	M20x1,5 x 150 mm	1
2	4M509	GUIDE PIN (LONG)	Ø35 x 135 mm	1
3	4M511	GUIDE PIN WITH BOLT END	Ø28,5 x 85 mm	1
4	4M572	DUST EXCLUDER RETAINER	Ø39 / Ø36,5-35,5 mm	1
5	4M574	DUST EXCLUDER RETAINER	Ø40 / Ø30,5 mm	1
6	4M582	DUST EXCLUDER		2
7	4M529	RUBBER BUSH	Ø40 x Ø29 x 27 mm	1
8	4M521	PLAIN BUSH	Ø39 x Ø35 x 30 mm	2
9	4M544	STEEL CAP	Ø44 mm	2

AYS Code 4M217



Caliper Tappet Adjusting Mechanism (Right)

Pos.	AYS Code	Description	Dimension	Qty
1	4M215	TAPPET GEAR ASSEMBLY (RIGHT)	Ø37,5 mm	2
2	4M653	INTERMEDIATE GEAR	Ø37,5 mm	1
3	4M635	STEEL CAP		2

AYS Code 4M218



Caliper Tappet Adjusting Mechanism (Left)

Pos.	AYS Code	Description	Dimension	Qty
1	4M216	TAPPET GEAR ASSEMBLY (LEFT)	Ø37,5 mm	2
2	4M635	STEEL CAP		2
3	4M653	INTERMEDIATE GEAR	Ø37,5 mm	1

AYS Code 4M254



Caliper Pad Retainer Repair Kit.











Pos.	AYS Code	Description	Dimension	Qty
1	4M254	Pad Retainer		1
2	4M698	Screw	M10 x 1.25 / 20 mm	1

AYS Code 4M255

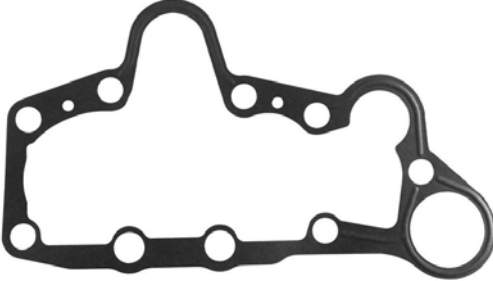
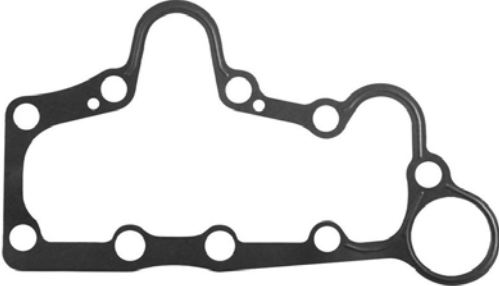
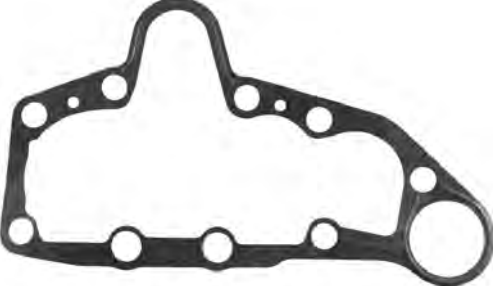

Caliper Mechanism, Piston & Cover Kit

Pos.	AYS Code	Description	Dimension	Qty
1	4M134	ADJUSTER MECHANISM		1
2	4M135	CALIBRATION GEAR		2
3	4M197	CALIBRATION MECHANISM		1

<p>AYS Code 4M069</p>	<p>AYS Code 4M071</p>	<p>AYS Code 4M072</p>
		
<p>Caliper Tappet Dust Covers ST1156</p>	<p>Caliper Roller Bearings</p>	<p>Caliper Adjusting Mechanism Clutch (Right)</p>
<p>AYS Code 4M073</p>	<p>AYS Code 4M074</p>	<p>AYS Code 4M075</p>
		
<p>Caliper Adjusting Mechanism Clutch (Left)</p>	<p>Caliper Adjusting Mechanism</p>	<p>Caliper Tappet Gear Assembly (Right)</p>
<p>AYS Code 4M076</p>	<p>AYS Code 4M079</p>	<p>AYS Code 4M211</p>
		
<p>Caliper Tappet Gear Assembly (Left)</p>	<p>Caliper Locking Shim 68321678PK10</p>	<p>Caliper Cover Plate Seal</p>
<p>AYS Code 4M212</p>	<p>AYS Code 4M213</p>	<p>AYS Code 4M215</p>
		
<p>Caliper Cover Plate Seal</p>	<p>Caliper Cover Plate Seal</p>	<p>Caliper Tappet Gear Assembly (Right)----- / Unscrews to the right (clockwise)</p>

AYS Code **4M216**



Caliper Tappet Gear Assembly (Left) ----- /
Unscrews to the left (anticlockwise)

AYS Code **4M219**



Caliper Lever (Right)

AYS Code **4M220**



Caliper Lever (Left)

MERITOR

ELSA2/195/225 TYPE

CALIPER REPAIR KITS

KALİPER TAMİR TAKIMI



AYS Code 4M064

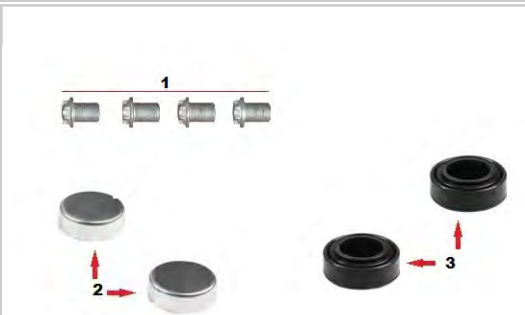

Caliper Boot & Bolts Repair Kit MCK1253

Pos.	AYS Code	Description	Dimension	Qty
1	4M563	BOLT	M14x1,5 x 40 mm	4
2	4M548	STEEL CAP	Ø44 mm	2
3	4M582	DUST EXCLUDER		2

AYS Code 4M065



Caliper Guide & Seals Repair Kit MCK1298

Pos.	AYS Code	Description	Dimension	Qty
1	4M514	GUIDE PIN (LONG)	Ø35 x 117 mm	1
2	4M555	BOLT (LONG)	M18x1,5 x 120 mm	1
3	4M513	GUIDE PIN (LONG)	Ø31 x 77,5 mm	1
4	4M553	BOLT (SHORT)	M18x1,5 x 85 mm	1
5	4M582	DUST EXCLUDER		2
6	4M521	PLAIN BUSH	39 x 35 x 30 mm	2
7	4M548	STEEL CAP	Ø44 mm	2
8	4M571	DUST EXCLUDER RETAINER	Ø39 / Ø37 mm	2
9	4M564	BOLT	M16x1,5 x 40 mm	4
10	4M528	BRONZE OVAL BUSH	42 x 33,0/31,8 x 30 mm	1
11	4M563	BOLT	M14x1,5 x 40 mm	4

AYS Code 4M066

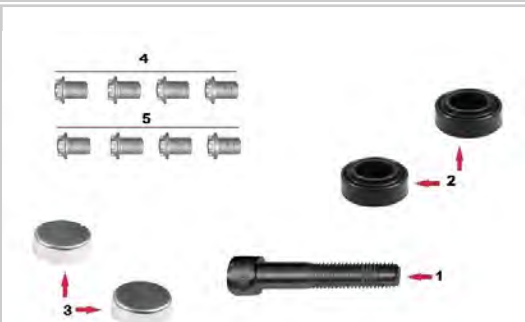

Caliper Bolts Repair Kit MCK1310

Pos.	AYS Code	Description	Dimension	Qty
1	4M555	BOLT (LONG)	M18x1,5 x 120 mm	1
2	4M582	DUST EXCLUDER		2
3	4M548	STEEL CAP	Ø44 mm	2
4	4M564	BOLT	M16x1,5 x 40 mm	4
5	4M563	BOLT	M14x1,5 x 40 mm	4

AYS Code 4M070

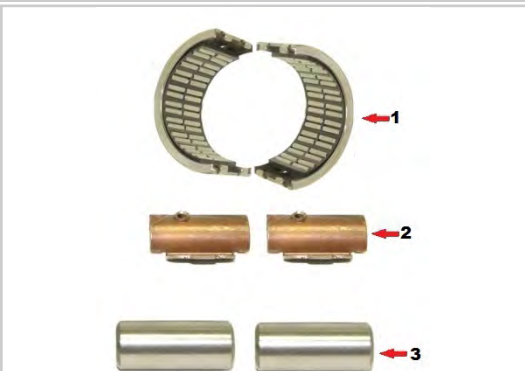

Caliper Half Bearing Repair Kit (Axial) SJ4112

Pos.	AYS Code	Description	Dimension	Qty
1	4M071	ROLLER BEARING SET		1
2	4M633	HALF BEARING		2
3	4M634	ROLLER		2

AYS Code 4M133



Caliper Guide & Seals Repair Kit MCK1243

Pos.	AYS Code	Description	Dimension	Qty
1	4M556	BOLT (LONG)	M18x1,5 x 150 mm	1
2	4M553	BOLT (SHORT)	M18x1,5 x 85 mm	1
3	4M510	GUIDE PIN (LONG)	Ø35 x 144 mm	1
4	4M681	SCREW	M10x1,25 x 20 mm	1
5	4M501	GUIDE PIN (SHORT)	Ø31 x 83,5 mm	1
6	4M552	BRIDGE BOLT	M16x1,5 x 40 mm	4
7	4M582	DUST EXCLUDER		2
8	4M545	STEEL CAP	Ø44 mm	2
9	4M575	DUST EXCLUDER RETAINER	Ø42 / Ø37 mm	2
10	4M521	PLAIN BUSH	Ø39 x Ø35 x 30 mm	2
11	4M528	BRONZE OVAL BUSH	Ø42 x Ø33,0/31,8 x 30 mm	1

AYS Code 4M136



Caliper Calibration Mechanism Cap (Aluminium)

Pos.	AYS Code	Description	Dimension	Qty
1	4M562	Screw		8
2	4M660	Gasket		1
3	4M732	Cover		1

AYS Code 4M139



Caliper Adjusting Mechanism Sealings

Pos.	AYS Code	Description	Dimension	Qty
1	4M534	TEFLON BUSHING		2
2	4M580	DUST EXCLUDER RETAINER		2
3	4M638	SEAL		2

AYS Code 4M189



Caliper Tappet Head Repair Kit

Pos.	AYS Code	Description	Dimension	Qty
1	4M584	TAPPET DUST EXCLUDER		2
2	4M612	PISTON HEAD		2
3	4M614	PISTON HEAD RING		2

AYS Code 4M191



Caliper Seals & Bolts Repair Kit MCK1088

Pos.	AYS Code	Description	Dimension	Qty
1	4M552	BRIDGE BOLT	M16x1,5 x 40 mm	4
2	4M545	STEEL CAP	Ø44 mm	2
3	4M584	TAPPET DUST EXCLUDER		2
4	4M199	ACTUATOR SEAL		1
5	4M192	ADJUSTER DUST BOOT		1
6	4M582	DUST EXCLUDER		2

AYS Code 4M195



Caliper Lever (length 123 mm)

Pos.	AYS Code	Description	Dimension	Qty
1	4M633	HALF BEARING		2
2	4M195	CALIPER LEVER		1

AYS Code 4M197



Caliper Calibration Mechanism Cap (Aluminium)

Pos.	AYS Code	Description	Dimension	Qty
1	4M561	Screw		8
2	4M623	Gasket		1
3	4M730	Cover		1

AYS Code 4M204

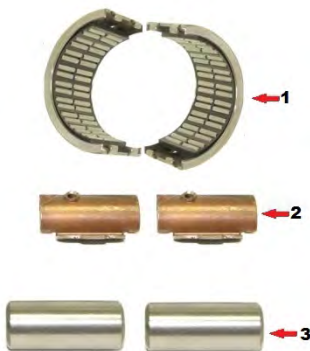

Caliper Half Bearing Repair Kit (Radial)

Pos.	AYS Code	Description	Dimension	Qty
1	4M071	ROLLER BEARING SET		1
2	4M672	HALF BEARING		2
3	4M634	ROLLER		2

AYS Code 4M206



Caliper Lever (Radial)

Pos.	AYS Code	Description	Dimension	Qty
1	4M206	CALIPER LEVER		1
2	4M672	HALF BEARING		2

AYS Code 4M207

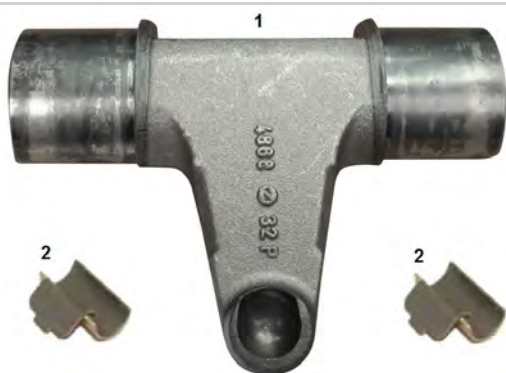

Caliper Lever (length 114 mm)

Pos.	AYS Code	Description	Dimension	Qty
1	4M207	CALIPER LEVER		1
2	4M633	HALF BEARING		2

AYS Code 4M209



Caliper Adjuster Seal & Cover Repair Kit

Pos.	AYS Code	Description	Dimension	Qty
1	4M627	ADJUSTER SEAL		1
2	4M192	ADJUSTER DUST COVER		1
3	4M704	DUST COVER RETAINER		1

AYS Code 4M210



Caliper Guide & Seals Repair Kit
MCK1254

Pos.	AYS Code	Description	Dimension	Qty
1	4M514	GUIDE PIN (LONG)	Ø35 x 117 mm	1
2	4M513	GUIDE PIN (SHORT)	Ø31 x 77,5 mm	1
3	4M555	BOLT (LONG)	M18x1,5 x 120 mm	1
4	4M553	BOLT (SHORT)	M18x1,5 x 85 mm	1
5	4M552	BRIDGE BOLT	M16x1,5 x 40 mm	4
6	4M528	BRONZE OVAL BUSH	Ø42 x Ø33,0/31,8 x 30 mm	1
7	4M681	SCREW	M10x1,25 x 20 mm	1
8	4M548	STEEL CAP (SHORT VERSION)	Ø44 mm	2
9	4M571	DUST EXCLUDER RETAINER	Ø39 / Ø37 mm	2
10	4M582	DUST EXCLUDER		2
11	4M521	PLAIN BUSH	Ø39 x Ø35 x 30 mm	2

AYS Code 4M214



Caliper Guide & Seals Repair Kit
MCK1086

Pos.	AYS Code	Description	Dimension	Qty
1	4M516	GUIDE PIN (LONG)	Ø35 x 128,5 mm	1
2	4M515	OVAL GUIDE PIN (SHORT)	Ø35 / 33 x 67 mm	1
3	4M560	BOLT (LONG)	M20x1,5 x 150 mm	1
4	4M558	BOLT (SHORT)	M20x1,5 x 90 mm	1
5	4M552	BRIDGE BOLT	M16x1,5 x 40 mm	4
6	4M582	DUST EXCLUDER		2
7	4M701	DUST EXCLUDER RETAINER	Ø41,5 / Ø37 mm	2
8	4M521	PLAIN BUSH	Ø39 x Ø35 x 30 mm	3
9	4M681	SCREW	M10x1,25 x 20 mm	1
10	4M702	DUST EXCLUDER RETAINER	Ø42,5 / Ø35,5 mm	2
11	4M545	STEEL CAP	Ø44 mm	2

AYS Code 4M224



Caliper Mechanism, Piston & Cover Kit

Pos.	AYS Code	Description	Dimension	Qty
	4M134	ADJUSTER MECHANISM		1
	4M135	CALIBRATION GEAR		2
	4M136	CALIBRATION MECHANISM CAP		1

AYS Code 4M225



Caliper Mechanism, Piston & Cover Kit

Pos.	AYS Code	Description	Dimension	Qty
	4M134	ADJUSTER MECHANISM		1
	4M135	CALIBRATION GEAR		2
	4M197	CALIBRATION MECHANISM CAP		1

AYS Code 4M227



Caliper Visual Indicator

Pos.	AYS Code	Description	Dimension	Qty
1	4M723	VISUAL INDICATOR		1
2	4M671	VISUAL INDICATOR SPRING	Ø14 x Ø80 mm	1

AYS Code 4M230



Caliper Calibration Mechanism Cap (Aluminium)

Pos.	AYS Code	Description	Dimension	Qty
1	4M659	Gasket		1
3	4M562	Screw		8
3	4M562	Cover		1

AYS Code 4M231



Caliper Guide & Seals Repair Kit

Pos.	AYS Code	Description	Dimension	Qty
1	4M510	GUIDE PIN (LONG)	Ø35 x 144 mm	1
2	4M556	BOLT (LONG)	M18x1,5 x 150 mm	1
3	4M553	BOLT (SHORT)	M18x1,5 x 85 mm	1
4	4M501	GUIDE PIN (SHORT)	Ø31 x 83,5 mm	1
5	4M536	METAL-RUBBER BUSH	Ø42 x Ø31 x 45 mm	1
6	4M582	DUST EXCLUDER		2
7	4M681	SCREW	M10x1,25 x 20 mm	1
8	4M545	STEEL CAP	Ø44 mm	2
9	4M521	PLAIN BUSH	Ø39 x Ø35 x 30 mm	2
10	4M575	DUST EXCLUDER RETAINER	Ø42 / Ø37 mm	2
11	4M552	BRIDGE BOLT	M16x1,5 x 40 mm	4

AYS Code 4M239



Caliper Pad Retainer Repair Kit

Pos.	AYS Code	Description	Dimension	Qty
1	4M239	Pad Retainer		1
2	4M681	Screw	M10 x 1.25 / 20 mm	1

AYS Code 4M246



Caliper Mechanism, Piston & Cover Kit

Pos.	AYS Code	Description	Dimension	Qty
	4M232	Adjuster Mechanism		1
	4M235	Calibration Gear		2
	4M230	Calibration Mechanism Cap		1

AYS Code **4M247**



Caliper Guide & Seals Repair Kit

Pos.	AYS Code	Description	Dimension	Qty
1	4M518	GUIDE PIN (LONG)	Ø35 x 117 mm	1
2	4M555	BOLT (LONG)	M18x1,5 x 120 mm	2
3	4M517	GUIDE PIN (LONG)	Ø31 x 117 mm	1
4	4M552	BRIDGE BOLT	M16x1,5 x 40 mm	4
5	4M571	DUST EXCLUDER RETAINER	Ø39 / Ø37 mm	2
6	4M681	SCREW	M10x1,25 x 20 mm	1
7	4M528	BRONZE OVAL BUSH	Ø42 x Ø33,0/31,8 x 30 mm	2
8	4M582	DUST EXCLUDER		2
9	4M548	STEEL CAP (SHORT VERSION)	Ø44 mm	2
10	4M521	PLAIN BUSH	Ø39 x Ø35 x 30 mm	2

AYS Code **4M071**



Caliper Roller Bearings

AYS Code **4M111**



Caliper Tappet Dust Covers MCK1139

AYS Code **4M134**



Caliper Adjuster Mechanism

AYS Code **4M135**



Caliper Calibration Gear

AYS Code **4M137**



Caliper Adjuster Gear (Left)

AYS Code **4M138**



Caliper Adjuster Gear (Right)

AYS Code **4M140**



Caliper Bearing Caps

AYS Code **4M142**



Caliper Tappet Dust Covers MCK1139

AYS Code **4M188**



Caliper Adjuster Gear

AYS Code **4M192**



Caliper Adjuster Dust Boot 68322655PK10

AYS Code **4M199**





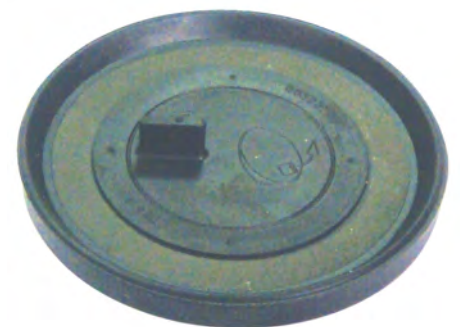

Caliper Actuator Seal 68323746PK10

AYS Code **4M200**



Caliper Actuator Seal

AYS Code 4M232	AYS Code 4M235	AYS Code 4M255
		
Caliper Adjuster Mechanism	Caliper Calibration Gear	Caliper Pad Retainer Repair Kit
AYS Code 4M256	AYS Code 4M257	
		
Caliper Pad Retainer Repair Kit	Caliper Lever Bearing Set	

MERITOR

LISA TYPE

CALIPER REPAIR KITS

KALİPER TAMİR TAKIMI



AYS Code 4M128



Caliper Guides & Seals Repair Kit SJ4076

Pos.	AYS Code	Description	Dimension	Qty
1	4M508	GUIDE PIN (LONG)	Ø35 x 131,5 mm	1
2	4M560	BOLT (LONG)	M20x1,5 x 150 mm	1
3	4M506	GUIDE PIN (SHORT)	Ø35 x 78 mm	1
4	4M558	BOLT (SHORT)	M20x1,5 x 90 mm	1
5	4M526	BRONZE OVAL BUSH	Ø39 x Ø36,2/35,3 x 47,5 mm	1
6	4M521	PLAIN BUSH	Ø39 x Ø35 x 30 mm	2
7	4M523	PLAIN BUSH	Ø41 x Ø35 x 30 mm	2
8	4M582	DUST EXCLUDER		2
9	4M546	STEEL CAP	Ø45 mm	2
10	4M576	DUST EXCLUDER RETAINER	Ø47 / Ø37 mm	2

AYS Code 4M196



Caliper Bush & Bearing Kit SJ4031

Pos.	AYS Code	Description	Dimension	Qty
1	4M615	WASHER	Ø73 / Ø47 mm	1
2	4M578	DUST EXCLUDER RETAINER	Ø44 / Ø37,5 mm	1
3	4M531	PLAIN BUSH	Ø44 x Ø40 x 15 mm	1
4	4M591	SHAFT ROLLER BEARING	Ø72,5 / Ø46 x 8,5 mm	1
5	4M592	SHAFT ROLLER BEARING	Ø52 / Ø46 x 16 mm	1

AYS Code 4M198



Caliper Overhaul Seal Kit SJ4078

Pos.	AYS Code	Description	Dimension	Qty
1	4M620	GASKET		1
2	4M618	SHAFT OUTER SEAL	Ø57 / Ø40 mm	1
3	4M619	SHAFT SEAL COVER	Ø55,5 / Ø42 mm	1
4	4M617	SHAFT INNER SEAL	Ø52 / Ø39 mm	1
5	4M582	DUST EXCLUDER		2
6	4M546	STEEL CAP	Ø45 mm	2
7	4M586	TAPPET DUST EXCLUDER		1
8	4M621	ADJUSTER DUST COVER		1
9	4M622	SEAL		1

AYS Code 4M222



Caliper Operating Shaft Repair Kit (Left)
MCK1151 / MCK1021

Pos.	AYS Code	Description	Dimension	Qty
1	4M654	OPERATION SHAFT (LEFT)		1
2	4M658	ANTI ROTATION PIN		1
3	4M656	FIXED RAMP (LEFT)		1
4	4M647	BALL		3

AYS Code **4M223**



Pos.	AYS Code	Description	Dimension	Qty
1	4M658	ANTI ROTATION PIN		1
2	4M657	FIXED RAMP (RIGHT)		1
3	4M647	BALL		3
4	4M655	OPERATION SHAFT (RIGHT)		1

Caliper Operating Shaft Repair Kit (Right)
MCK1152 / MCK1022

<p>AYS Code 4M129</p>	<p>AYS Code 4M130</p>	<p>AYS Code 4M131</p>
		
<p>Caliper Tappet Adjuster Assembly (Left) SJ4073</p>	<p>Caliper Tappet Adjuster Assembly (Right) SJ4074</p>	<p>Caliper Adjusting Mechanism (Left) SJ4113</p>
<p>AYS Code 4M132</p>	<p>AYS Code 4M190</p>	
		
<p>Caliper Adjusting Mechanism (Right) SJ4114</p>	<p>Caliper Push Plate</p>	

MERITOR

SETS

CALIPER REPAIR KITS

KALİPER TAMİR TAKIMI

AYDINSAN 

www.aydinsan.com.tr

AYS Code CM002



RENAULT 420 SET (OLD MODEL) RIGHT

Pos.	AYS Code	Description	Dimension	Qty
1	4M070	Caliper Half Bearing Repair Kit (Axial)		1
2	4M133	Caliper Guide & Seals Repair Kit		1
3	4M136	Caliper Calibration Mechanism Cap (Aluminium)		1
4	4M138	Caliper Adjuster Gear (Right)		1
5	4M134	Caliper Adjuster Mechanism		1
6	4M209	Caliper Adjuster Seal & Cover Repair Kit		1
7	4M135	Caliper Calibration Gear		2
8	4M142	Caliper Tappet Dust Covers		1
9	4M200	Caliper Actuator Seal		1
10	4M227	Caliper Visual Indicator		1
11	4M140	Caliper Bearing Caps		1

AYS Code CM003



RENAULT 420 - MAN TGA SET (NEW MODEL) LEFT

Pos.	AYS Code	Description	Dimension	Qty
1	4M070	Caliper Half Bearing Repair Kit (Axial)		1
2	4M214	Caliper Guide & Seals Repair Kit		1
3	4M140	Caliper Bearing Caps		1
4	4M235	Caliper Calibration Gear		2
5	4M232	Caliper Adjuster Mechanism		1
6	4M209	Caliper Adjuster Seal & Cover Repair Kit		1
7	4M137	Caliper Adjuster Gear (Left)		1
8	4M142	Caliper Tappet Dust Covers		1
9	4M200	Caliper Actuator Seal		1
10	4M227	Caliper Visual Indicator		1
11	4M230	Caliper Calibration Mechanism Cap (Aluminium)		1

AYS Code CM004



RENAULT 420 - MAN TGA SET (NEW MODEL) RIGHT

Pos.	AYS Code	Description	Dimension	Qty
1	4M070	Caliper Half Bearing Repair Kit (Axial)		1
2	4M214	Caliper Guide & Seals Repair Kit		1
3	4M140	Caliper Bearing Caps		1
4	4M235	Caliper Calibration Gear		2
5	4M138	Caliper Adjuster Gear (Right)		1
6	4M209	Caliper Adjuster Seal & Cover Repair Kit		1
7	4M232	Caliper Adjuster Mechanism		1
8	4M142	Caliper Tappet Dust Covers		1
9	4M200	Caliper Actuator Seal		1
10	4M227	Caliper Visual Indicator		1
11	4M230	Caliper Calibration Mechanism Cap (Aluminium)		1

AYS Code CM005



RENAULT 440 SET

Pos.	AYS Code	Description	Dimension	Qty
1	4M070	Caliper Half Bearing Repair Kit (Axial)		1
2	4M210	Caliper Guide & Seals Repair Kit		1
3	4M197	Caliper Calibration Mechanism Cap (Aluminium)		1
4	4M135	Caliper Calibration Gear		2
5	4M209	Caliper Adjuster Seal & Cover Repair Kit		1
6	4M142	Caliper Tappet Dust Covers		1
7	4M188	Caliper Adjuster Gear		1
8	4M134	Caliper Adjuster Mechanism		1
9	4M199	Caliper Actuator Seal		1
10	4M227	Caliper Visual Indicator		1
11	4M140	Caliper Bearing Caps		1

AYS Code CM006



RENAULT 370 - 390 - 400 SET LEFT

Pos.	AYS Code	Description	Dimension	Qty
1	4M128	Caliper Guides & Seals Repair Kit		1
2	4M586	Tappet Dust Excluder		1
3	4M620	Cover Gasket		1
4	4M617	Shaft Inner Seal	Ø52 / Ø39 mm	1
5	4M622	O-ring		1
6	4M621	Adjuster Dust Cover		1
7	4M619	Shaft Seal Cover	Ø55,5 / Ø42 mm	1
8	4M618	Shaft Outer Seal	Ø57 / Ø40 mm	1
9	4M129	Caliper Tappet Adjuster Assembly (Left)		1
10	4M222	Caliper Operating Shaft Repair Kit (Left)		1
11	4M190	Caliper Push Plate		1
12	4M196	Caliper Bush & Bearing Kit		1
13	4M131	Caliper Adjusting Mechanism (Left)		1

AYS Code CM007



RENAULT 370 - 390 - 400 SET RIGHT

Pos.	AYS Code	Description	Dimension	Qty
1	4M128	Caliper Guides & Seals Repair Kit		1
2	4M586	Tappet Dust Excluder		1
3	4M620	Cover Gasket		1
4	4M617	Shaft Inner Seal	Ø52 / Ø39 mm	1
5	4M622	O-ring		1
6	4M621	Adjuster Dust Cover		1
7	4M619	Shaft Seal Cover	Ø55,5 / Ø42 mm	1
8	4M618	Shaft Outer Seal	Ø57 / Ø40 mm	1
9	4M223	Caliper Operating Shaft Repair Kit (Right)		1
10	4M130	Caliper Tappet Adjuster Assembly (Right)		1
11	4M190	Caliper Push Plate		1
12	4M132	Caliper Adjusting Mechanism (Right)		1
13	4M196	Caliper Bush & Bearing Kit		1

AYS Code CM008



463 - 464 MAN SET (NEW MODEL) RIGHT

Pos.	AYS Code	Description	Dimension	Qty
1	4M141	Caliper Guides & Seals Repair Kit		1
2	4M077	Caliper Tappet Adjusting Mechanism (Right)		1
3	4M079	Caliper Locking Shim		1
4	4M070	Caliper Half Bearing Repair Kit (Axial)		1
5	4M072	Caliper Adjusting Mechanism Clutch (Right)		1
6	4M211	Caliper Cover Plate Seal		1
7	4M074	Caliper Adjusting Mechanism		1
8	4M080	Caliper Spring & Retainers Repair Kit (Right)		1

AYS Code CM009

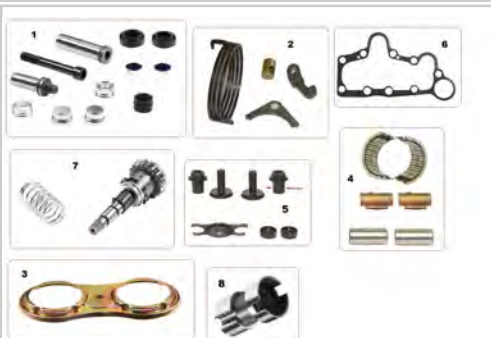

463 - 464 MAN SET (NEW MODEL) LEFT

Pos.	AYS Code	Description	Dimension	Qty
1	4M141	Caliper Guides & Seals Repair Kit		1
2	4M081	Caliper Spring & Retainers Repair Kit (Left)		1
3	4M079	Caliper Locking Shim		1
4	4M070	Caliper Half Bearing Repair Kit (Axial)		1
5	4M078	Caliper Tappet Adjusting Mechanism (Left)		1
6	4M212	Caliper Cover Plate Seal		1
7	4M074	Caliper Adjusting Mechanism		1
8	4M073	Caliper Adjusting Mechanism Clutch (Left)		1

AYS Code CM010



463 - 464 MAN SET (OLD MODEL) RIGHT

Pos.	AYS Code	Description	Dimension	Qty
1	4M141	Caliper Guides & Seals Repair Kit		1
2	4M080	Caliper Spring & Retainers Repair Kit (Right)		1
3	4M079	Caliper Locking Shim		1
4	4M070	Caliper Half Bearing Repair Kit (Axial)		1
5	4M072	Caliper Adjusting Mechanism Clutch (Right)		1
6	4M213	Caliper Cover Plate Seal		1
7	4M074	Caliper Adjusting Mechanism		1
8	4M217	Caliper Tappet Adjusting Mechanism (Right)		1

AYS Code CM011



463 - 464 MAN SET (OLD MODEL) LEFT

Pos.	AYS Code	Description	Dimension	Qty
1	4M141	Caliper Guides & Seals Repair Kit		1
2	4M081	Caliper Spring & Retainers Repair Kit (Left)		1
3	4M079	Caliper Locking Shim		1
4	4M070	Caliper Half Bearing Repair Kit (Axial)		1
5	4M073	Caliper Adjusting Mechanism Clutch (Left)		1
6	4M213	Caliper Cover Plate Seal		1
7	4M074	Caliper Adjusting Mechanism		1
8	4M218	Caliper Tappet Adjusting Mechanism (Left)		1

AYS Code CM012



VOLVO SET REAR-RIGHT

Pos.	AYS Code	Description	Dimension	Qty
1	4M109	Caliper Guides & Seals Repair Kit		1
2	4M114	Caliper Adjuster Tappet Repair Kit (Right)		1
3	4M070	Caliper Half Bearing Repair Kit (Axial)		1
4	4M126	Caliper Cover Plate Seal Repair Kit		1
5	4M115	Caliper Gear & Springs Repair Kit		1
6	4M118	Caliper Tappet Adjusting Mechanism (Left)		1
7	4M226	Caliper Visual Indicator		1
8	4M123	Caliper Tappet Anti-Rotation Plate		1

AYS Code CM013



VOLVO SET REAR-LEFT

Pos.	AYS Code	Description	Dimension	Qty
1	4M109	Caliper Guides & Seals Repair Kit		1
2	4M113	Caliper Adjuster Tappet Repair Kit (Left)		1
3	4M070	Caliper Half Bearing Repair Kit (Axial)		1
4	4M126	Caliper Cover Plate Seal Repair Kit		1
5	4M115	Caliper Gear & Springs Repair Kit		1
6	4M119	Caliper Automatic Adjuster (Axial - Left)		1
7	4M226	Caliper Visual Indicator		1
8	4M123	Caliper Tappet Anti-Rotation Plate		1

AYS Code CM015



DX 195 SET (RIGHT)

Pos.	AYS Code	Description	Dimension	Qty
1	4M048	Caliper Overhaul Repair Kit		1
2	4M194	Caliper Bridge Assembly		1
3	4M234	Caliper Adjustment Sleeve (Driven)-(Right)		1
4	4M050	Caliper Roller Bearing		1
5	4M062	Caliper Shaft Lever		1
6	4M053	Caliper Push Plate Repair Kit (Right)		1
7	4M724	Shaft Dust Cover		1
8	4M725	Cover Plate Seal		1
9	4M238	Caliper Centering Gear Set		1
10	4M240	Caliper Adjusting Mechanism Repair Kit Right		1
11	4M699	Shaft Bearing		1
12	4M049	Caliper Shaft Assembly		1

AYS Code CM016



DX 195 SET (LEFT)

Pos.	AYS Code	Description	Dimension	Qty
1	4M048	Caliper Overhaul Repair Kit		1
2	4M194	Caliper Bridge Assembly		1
3	4M233	Caliper Adjustment Sleeve (Driven)-(Left)		1
4	4M050	Caliper Roller Bearing		1
5	4M062	Caliper Shaft Lever		1
6	4M054	Caliper Push Plate Repair Kit (Left)		1
7	4M724	Shaft Dust Cover		1
8	4M725	Cover Plate Seal		1
9	4M238	Caliper Centering Gear Set		1
10	4M241	Caliper Adjusting Mechanism Repair Kit Left		1
11	4M699	Shaft Bearing		1
12	4M049	Caliper Shaft Assembly		1

AYS Code CM12



VOLVO SET FRONT

Pos.	AYS Code	Description	Dimension	Qty
1	4M108	Caliper Guides & Seals Repair Kit		1
2	4M114	Caliper Adjuster Tappet Repair Kit (Right)		1
3	4M070	Caliper Half Bearing Repair Kit (Axial)		1
4	4M124	Caliper Cover Plate Seal Repair Kit		1
5	4M115	Caliper Gear & Springs Repair Kit		1
6	4M116	Caliper Automatic Adjuster (Radial - L/R)		1
7	4M226	Caliper Visual Indicator		1
8	4M123	Caliper Tappet Anti-Rotation Plate		1

WABCO

PAN 17 TYPE

CALIPER REPAIR KITS

KALİPER TAMİR TAKIMI



AYS Code 4W143



Caliper Guides & Seals Repair Kit 12 999 699

Pos.	AYS Code	Description	Dimension	Qty
1	4W501	GUIDE PIN (SHORT)	30 x 78 mm	1
2	4W502	GUIDE PIN (LONG)	30 x 91 mm	1
3	4K511	BOLT (SHORT)	M16x1,5 x 70 mm	1
4	4W513	BOLT (LONG)	M16x1,5 x 90 mm	1
5	4K529	GUIDE PIN BUSH	34 x 30 x 20 mm	3
6	4W532	GUIDE PIN GAITER		2
7	4W541	STEEL COVER		2
8	4W531	ADJUSTER SCREW GAITER		1
9	4W551	PLUG		1

AYS Code 4W144



Caliper Seals & Boots Repair Kit

Pos.	AYS Code	Description	Dimension	Qty
1	4W532	GUIDE PIN GAITER		2
2	4W531	ADJUSTER SCREW GAITER		1

AYS Code 4W145



Caliper Adjusting Mechanism

Pos.	AYS Code	Description	Dimension	Qty
1	4W561	ADJUSTER PIN	L1 = 13,30 mm L2=78mm	1
2	4W146	CALIBRATION BOLT	Short Pin	1
3	4W564	RETAINER		1
4	4W555	SPRING RETAINER		1
5	4W565	SPRING	Ø42,5 x 22 mm	1
6	4W563	CLUTCH		1

AYS Code 4W150

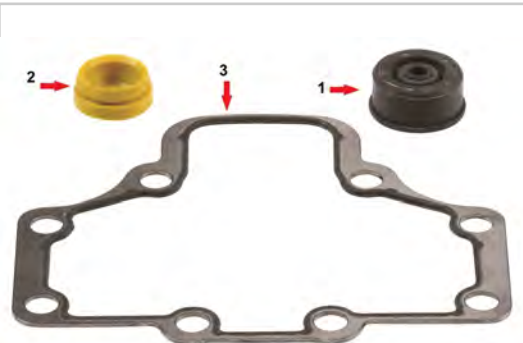

Caliper Gasket & Seals Repair Kit

Pos.	AYS Code	Description	Dimension	Qty
1	4W552	SEAL		1
2	4W551	PLUG		1
3	4W553	GASKET		1

AYS Code 4W166



Caliper Washers & Circlips Repair Kit

Pos.	AYS Code	Description	Dimension	Qty
1	4W558	WASHER	Ø45 x Ø32 mm	
2	4W555	SPRING RETAINER		1
3	4W566	SPRING	Ø22,5 x 24 mm	1
4	4W557	WASHER	Ø49,4 x Ø35,5 mm	1
5	4W554	WASHER	Ø41,4 x Ø14,25 mm	1
6	4W556	CIRCLIP		1

AYS Code 4W167



Caliper Adjusting Mechanism Support

Pos.	AYS Code	Description	Dimension	Qty
1	4W571	MECHANISM SUPPORT		1
2	4W567	SPRING	Ø20,5 x 41 mm	2

AYS Code 4W169



Caliper Seals Repair Kit 640 175 920 2

Pos.	AYS Code	Description	Dimension	Qty
1	4W531	ADJUSTER SCREW GAITER		1
2	4W552	SEAL		1
3	4W551	PLUG		1

AYS Code 4W170



Caliper Bolts, Seals & Gasket Repair Kit











Pos.	AYS Code	Description	Dimension	Qty
1	4W513	BOLT (LONG)	M16x1,5 x 90 mm	1
2	4K511	BOLT (SHORT)	M16x1,5 x 70 mm	1
3	4W515	COVER SCREW	M10x1 x 40 mm	8
4	4W552	SEAL		1
5	4K529	GUIDE PIN BUSH	34 x 30 x 20 mm	3
6	4W553	GASKET		1
7	4W541	STEEL COVER		2
8	4W532	GUIDE PIN GAITER		2
9	4W531	ADJUSTER SCREW GAITER		1
10	4W551	PLUG		1

AYS Code **4W172**



Caliper Adjusting Mechanism Assembly

Pos.	AYS Code	Description	Dimension	Qty
	4W145	ADJUSTING MECHANISM		1
	4W166	WASHERS & CIRCLIPS REPAIR KIT		1
	4W167	ADJUSTING MECHANISM SUPPORT		1

<p>AYS Code 4W146</p>	<p>AYS Code 4W147</p>	<p>AYS Code 4W148</p>
		
<p>Caliper Calibration Bolt (With Short Pin)</p>	<p>Caliper Calibration Bolt (Slotted)</p>	<p>Caliper Roller Bearings</p>
<p>AYS Code 4W149</p>	<p>AYS Code 4W151</p>	<p>AYS Code 4W152</p>
		
<p>Caliper Lever & Pin</p>	<p>Caliper Push Plate Slotted (Left)</p>	<p>Caliper Push Plate Slotted (Right)</p>
<p>AYS Code 4W153</p>	<p>AYS Code 4W154</p>	<p>AYS Code 4W178</p>
		
<p>Caliper Push Plate With Pin (Left)</p>	<p>Caliper Push Plate With Pin (Right)</p>	<p>Caliper Pad Retainer Repair Kit</p>
<p>AYS Code 4W213</p>	<p>AYS Code 4W252</p>	
		
<p>Steel Cap Kit (Ø34,5 x 38,5 mm)</p>	<p>Caliper Seals</p>	

WABCO

PAN 19-1 / 22-1 TYPE

CALIPER REPAIR KITS

KALİPER TAMİR TAKIMI



AYS Code 4W150

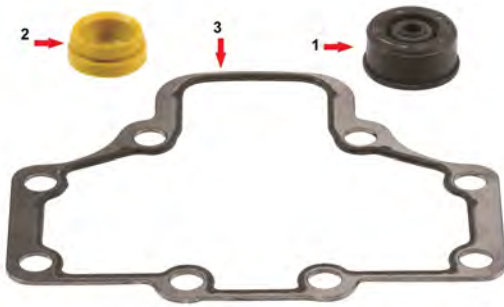

Caliper Gasket & Seals Repair Kit

Pos.	AYS Code	Description	Dimension	Qty
1	4W552	SEAL		1
2	4W551	PLUG		1
3	4W553	GASKET		1

AYS Code 4W155



Caliper Guides & Seals Repair Kit 12 999 738

Pos.	AYS Code	Description	Dimension	Qty
1	4W503	GUIDE PIN (SHORT)	38 x 76 mm	1
2	4W504	GUIDE PIN (LONG)	38 x 118 mm	1
3	4W514	BOLT (LONG)	M16x1,5 x 120 mm	1
4	4K513	BOLT (SHORT)	M16x1,5 x 80 mm	1
5	4W522	GUIDE PIN BUSH	42 x 38 x 30 mm	3
6	4W533	GUIDE PIN GAITER (GREEN)		2
7	4W531	ADJUSTER SCREW GAITER		1
8	4W551	PLUG		1
9	4W534	GUIDE PIN GAITER (WHITE)		2
10	4W542	STEEL COVER (SHORT)		2
11	4W544	RING		2
12	4W543	STEEL COVER (LONG)		2

AYS Code 4W156



Caliper Guides & Seals Repair Kit 12 999 776

Pos.	AYS Code	Description	Dimension	Qty
1	4W514	BOLT (LONG)	M16x1,5 x 120 mm	1
2	4K513	BOLT (SHORT)	M16x1,5 x 80 mm	1
3	4W503	GUIDE PIN (SHORT)	38 x 76 mm	1
4	4W504	GUIDE PIN (LONG)	38 x 118 mm	1
5	4W522	GUIDE PIN BUSH	42 x 38 x 30 mm	3
6	4W533	GUIDE PIN GAITER		2
7	4W544	RING		2
8	4W543	STEEL COVER (LONG)		2
9	4W542	STEEL COVER (SHORT)		1
10	4W531	ADJUSTER SCREW GAITER		1
11	4W551	PLUG		1

AYS Code 4W157



Caliper Adjusting Mechanis

Pos.	AYS Code	Description	Dimension	Qty
1	4W562	ADJUSTER PIN	18,80mm 83,5mm	1
2	4W165	CALIBRATION BOLT	Long Pin	1
3	4W564	RETAINER		1
4	4W555	SPRING RETAINER		1
5	4W565	SPRING	Ø42,5 x 22 mm	1
6	4W563	CLUTCH		1

AYS Code 4W160

Pos.	AYS Code	Description	Dimension	Qty
1	4W531	ADJUSTER SCREW GAITER		1
2	4W533	GUIDE PIN GAITER		2



Caliper Seals & Boots Repair Kit

AYS Code 4W166

Pos.	AYS Code	Description	Dimension	Qty
1	4W558	WASHER	Ø45 x Ø32 mm	1
2	4W555	SPRING RETAINER		1
3	4W566	SPRING	Ø22,5 x 24 mm	1
4	4W557	WASHER	Ø49,4 x Ø35,5 mm	1
5	4W554	WASHER	Ø41,4 x Ø14,25 mm	1
6	4W556	CIRCLIP		1



Caliper Washers & Circlips Repair Kit

AYS Code 4W168

Pos.	AYS Code	Description	Dimension	Qty
1	4W572	MECHANISM SUPPORT		1
2	4W567	SPRING	Ø20,5 x 41 mm	2



Caliper Adjusting Mechanism Support

AYS Code 4W169

Pos.	AYS Code	Description	Dimension	Qty
1	4W531	ADJUSTER SCREW GAITER		1
2	4W552	SEAL		1
3	4W551	PLUG		1



Caliper Seals Repair Kit 640 175 920 2











Pos.	AYS Code	Description	Dimension	Qty
	4W171	GAITER RETAINER	Ø44 x Ø38 mm	10



Pos.	AYS Code	Description	Dimension	Qty
	4W157	ADJUSTING MECHANISM		1
	4W166	WASHERS & CIRCLIPS REPAIR KIT		1
	4W168	ADJUSTING MECHANISM SUPPORT		1



Pos.	AYS Code	Description	Dimension	Qty
1	4W514	BOLT (LONG)	M16x1,5 x 120 mm	1
2	4K513	BOLT (SHORT)	M16x1,5 x 80 mm	1
3	4W515	COVER SCREW	M10x1 x 50,5 mm	8
4	4W552	SEAL		1
5	4W522	GUIDE PIN BUSH	42 x 38 x 30 mm	3
6	4W553	GASKET		1
7	4W542	STEEL COVER (SHORT)		1
8	4W533	GUIDE PIN GAITER (GREEN)		2
9	4W531	ADJUSTER SCREW GAITER		1
10	4W551	PLUG		1
11	4W543	STEEL COVER (LONG)		1

<p>AYS Code 4W148</p>	<p>AYS Code 4W149</p>	<p>AYS Code 4W158</p>
		
<p>Caliper Roller Bearings</p>	<p>Caliper Lever & Pin</p>	<p>Caliper Push Plate (Left - PAN19)</p>
<p>AYS Code 4W159</p>	<p>AYS Code 4W161</p>	<p>AYS Code 4W162</p>
		
<p>Caliper Push Plate (Right - PAN19)</p>	<p>Caliper Push Plate (Left - PAN22)</p>	<p>Caliper Push Plate (Right - PAN22)</p>
<p>AYS Code 4W165</p>	<p>AYS Code 4W175</p>	<p>AYS Code 4W177</p>
		
<p>Caliper Calibration Bolt (With Long Pin)</p>	<p>Caliper Pad Retainer Repair Kit</p>	<p>Caliper Pad Retainer Repair Kit</p>

WABCO

PAN 19-2 / 22-2 TYPE

CALIPER REPAIR KITS

KALİPER TAMİR TAKIMI

AYDINSAN 

www.aydinsan.com.tr



Pos.	AYS Code	Description	Dimension	Qty
	4W171	GAITER RETAINER	Ø44 x Ø38 mm	10



Pos.	AYS Code	Description	Dimension	Qty
1	4W503	GUIDE PIN (SHORT)	38 x 76 mm	1
2	4W504	GUIDE PIN (LONG)	38 x 118 mm	1
3	4W514	BOLT (LONG)	M16x1,5 x 120 mm	1
4	4K513	BOLT (SHORT)	M16x1,5 x 80 mm	1
5	4W522	GUIDE PIN BUSH	42 x 38 x 30 mm	3
6	4W536	PISTON HEAD WITH SEALING	Ø69,50 mm	2
7	4W551	PLUG		2
8	4W542	STEEL COVER (SHORT)		1
9	4W534	GUIDE PIN GAITER		2
10	4W543	STEEL COVER (LONG)		1
11	4W544	RING		2



Pos.	AYS Code	Description	Dimension	Qty
1	4W503	GUIDE PIN (SHORT)	38 x 76 mm	1
2	4W504	GUIDE PIN (LONG)	38 x 118 mm	1
3	4W514	BOLT (LONG)	M16x1,5 x 120 mm	1
4	4K513	BOLT (SHORT)	M16x1,5 x 80 mm	1
5	4W522	GUIDE PIN BUSH	42 x 38 x 30 mm	3
6	4W534	GUIDE PIN GAITER		2
7	4W542	STEEL COVER (SHORT)		1
8	4W543	STEEL COVER (LONG)		1







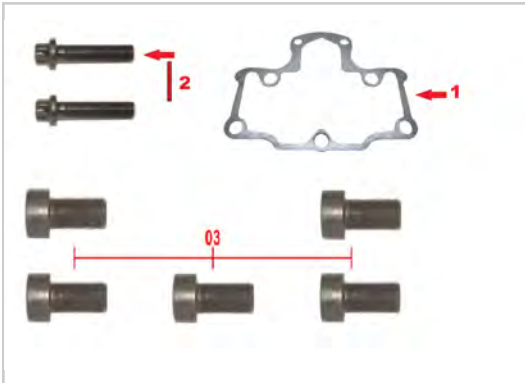





Pos.	AYS Code	Description	Dimension	Qty
	4W536	PISTON HEAD WITH SEALING	Ø69,50 mm	2

AYS Code **4W208**



Caliper Gasket & Bolts Repair Kit

Pos.	AYS Code	Description	Dimension	Qty
1	4W207	COVER GASKET		1
2	4W515	COVER SCREW	M10x1 x 40 mm	2
3	4M552	COVER BOLT	M16x1,5 x 40 mm	5

<p>AYS Code 4W176</p>	<p>AYS Code 4W180</p>	<p>AYS Code 4W181</p>
		
<p>Caliper Pad Retainer Repair Kit</p>	<p>Caliper Adjuster Mechanism Gear</p>	<p>Caliper Adjuster Lever</p>
<p>AYS Code 4W204</p>	<p>AYS Code 4W205</p>	<p>AYS Code 4W206</p>
		
<p>Caliper Bridge Assembly</p>	<p>Caliper Calibration Bolt (Left)</p>	<p>Caliper Calibration Bolt (Right)</p>
<p>AYS Code 4W207</p>	<p>AYS Code 4W209</p>	<p>AYS Code 4W210</p>
		
<p>Caliper Cover Gasket</p>	<p>Caliper Outer Roller Bearing</p>	<p>Caliper Outer Roller Bearing</p>
<p>AYS Code 4W211</p>	<p>AYS Code 4W212</p>	
		
<p>Caliper Calibration Bolt (Left)</p>	<p>Caliper Calibration Bolt (Right)</p>	

WABCO











MAXX 22 (MAN-TGX, TGS)

CALIPER REPAIR KITS

KALİPER TAMİR TAKIMI

AYDINSAN 

www.aydinsan.com.tr

<p>AYS Code 4W130</p>	<p>AYS Code 4W131</p>	<p>AYS Code 4W132</p>
		
<p>Caliper Adjusting Mechanism</p>	<p>Caliper Lever&Pin</p>	<p>Caliper Adjusting Mechanism Support</p>
<p>AYS Code 4W133</p>	<p>AYS Code 4W134</p>	<p>AYS Code 4W135</p>
		
<p>Caliper Washer & Circlip Repair Kit</p>	<p>Caliper Roller Bearing</p>	<p>Caliper Half Bearing Repair Kit</p>
<p>AYS Code 4W136</p>	<p>AYS Code 4W138</p>	<p>AYS Code 4W139</p>
		
<p>Caliper Seal Repair Kit</p>	<p>Caliper Cover</p>	<p>Caliper Cover Seal Repair Kit</p>
<p>AYS Code 4W141</p>		
		
<p>Caliper Adjusting Mechanism Assembly</p>		

WABCO

1000 V-G

CALIPER REPAIR KITS

KALİPER TAMİR TAKIMI

AYDINSAN 

www.aydinsan.com.tr

AYS Code **4W251**

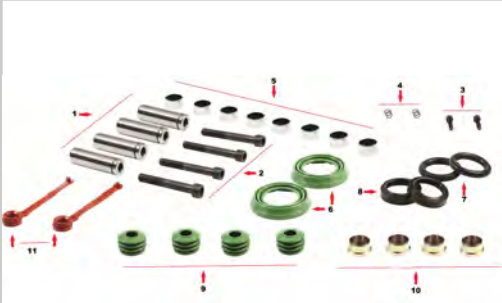

Caliper Guides & Seals Repair Kit 12 999 729

Pos.	AYS Code	Description	Dimension	Qty
1	4W505	Guide Pin	Ø25 x 81mm	4
2	4W516	Bolt	M11 x 1,5 x 90 mm	4
3	4W569	Screw	M06 x 1,5 x 20 mm	2
4	4W568	Spring		2
5	4W523	Teflon Bush	Ø34 x 15 mm	8
6	4W537	Ajuster Screw Gaiter		2
7	4W571	Gasket		2
8	4W540	Cover Plate Seal		2
9	4W538	Guide Pin Gaiter		4
10	4W560	Steel Cap	Ø26 mm	4
11	4W570	Tappet with Gasket		2

WABCO

SETS

CALIPER REPAIR KITS

KALİPER TAMİR TAKIMI

AYDINSAN 

www.aydinsan.com.tr



Pos.	AYS Code	Description	Dimension	Qty
1	4W152	Caliper Push Plate Slotted (Right)		1
2	4W552	Mechanism Seal		1
3	4W553	Cover Gasket		1
4	4W515	Bolt (M10x40)	M10 x 1 x 40 mm	8
5	4W145	Caliper Adjusting Mechanism		1
6	4W166	Caliper Washers & Circlips Repair Kit		1
7	4W167	Caliper Adjusting Mechanism Support		1
8	4W148	Caliper Roller Bearings		1
9	4W143	Caliper Guides & Seals Repair Kit		1
10	4W550	Caliper Seal		1



Pos.	AYS Code	Description	Dimension	Qty
1	4W151	Caliper Push Plate Slotted (Left)		1
2	4W552	Mechanism Seal		1
3	4W553	Cover Gasket		1
4	4W515	Bolt (M10x40)	M10 x 1 x 40 mm	8
5	4W145	Caliper Adjusting Mechanism		1
6	4W166	Caliper Washers & Circlips Repair Kit		1
7	4W167	Caliper Adjusting Mechanism Support		1
8	4W148	Caliper Roller Bearings		1
9	4W143	Caliper Guides & Seals Repair Kit		1
10	4W550	Caliper Seal		1



Pos.	AYS Code	Description	Dimension	Qty
1	4W159	Caliper Push Plate (Right - PAN19)		1
2	4W552	Mechanism Seal		1
3	4W553	Cover Gasket		1
4	4W515	Bolt (M10x40)	M10 x 1 x 40 mm	8
5	4W157	Caliper Adjusting Mechanism		1
6	4W166	Caliper Washers & Circlips Repair Kit		1
7	4W168	Caliper Adjusting Mechanism Support		1
8	4W148	Caliper Roller Bearings		1
9	4W156	Caliper Guides & Seals Repair Kit		1

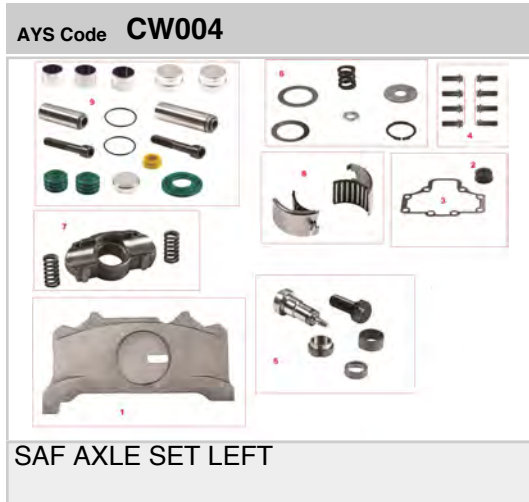

Pos.	AYS Code	Description	Dimension	Qty
1	4W158	Caliper Push Plate (Left - PAN19)		1
2	4W552	Mechanism Seal		1
3	4W553	Cover Gasket		1
4	4W515	Bolt (M10x40)	M10 x 1 x 40 mm	8
5	4W157	Caliper Adjusting Mechanism		1
6	4W166	Caliper Washers & Circlips Repair Kit		1
7	4W168	Caliper Adjusting Mechanism Support		1
8	4W148	Caliper Roller Bearings		1
9	4W156	Caliper Guides & Seals Repair Kit		1

HALDEX

MARK II-III SERIES

CALIPER REPAIR KITS

KALİPER TAMİR TAKIMI

AYDINSAN 

www.aydinsan.com.tr



Pos.	AYS Code	Description	Dimension	Qty
1	4H514	CALIBRATION BOLT		1
2	4H557	WASHER		1



Pos.	AYS Code	Description	Dimension	Qty
	4H515	CALIBRATION BOLT		1
	4H558	WASHER		1



Pos.	AYS Code	Description	Dimension	Qty
1	4H532	GUIDE PIN DUST COVER		6
2	4H551	PLUG		1
3	4H531	TAPPET DUST COVER		2



Pos.	AYS Code	Description	Dimension	Qty
	4H551	PLUG		2
	4H012	ADJUSTING BOLT		2
	4H552	ADJUSTING BOLT SEAL		2

AYS Code 4H022

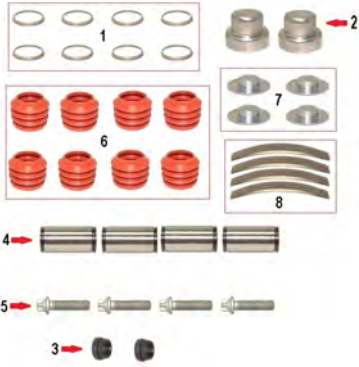

Caliper Guide & Seals Repair Kit

Pos.	AYS Code	Description	Dimension	Qty
1	4H553	DUST COVER RETAINER		8
2	4H541	STEEL COVER	Ø57 mm	2
3	4H551	PLUG		2
4	4H502	GUIDE PIN	Ø35 x 70 mm	4
5	4H512	GUIDE PIN BOLT	M14 x 2 x 53 mm	4
6	4H532	GUIDE PIN DUST COVER		8
7	4H543	STEEL COVER		4
8	4H521	GUIDE PIN BUSH		4

AYS Code 4H023

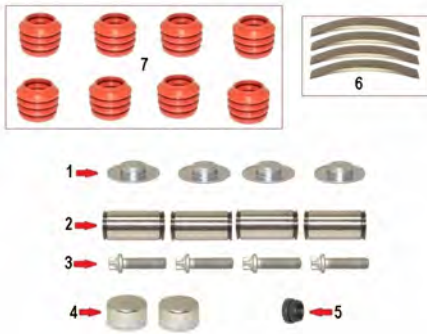

Caliper Guide & Seals Repair Kit

Pos.	AYS Code	Description	Dimension	Qty
1	4H543	STEEL COVER		4
2	4H501	GUIDE PIN	Ø35 x 64 mm	4
3	4H511	GUIDE PIN BOLT	M14 x 2 x 42 mm	4
4	4H542	STEEL COVER	Ø42 mm	2
5	4H551	PLUG		1
6	4H521	GUIDE PIN BUSH		4
7	4H532	GUIDE PIN DUST COVER		6

AYS Code 4H031

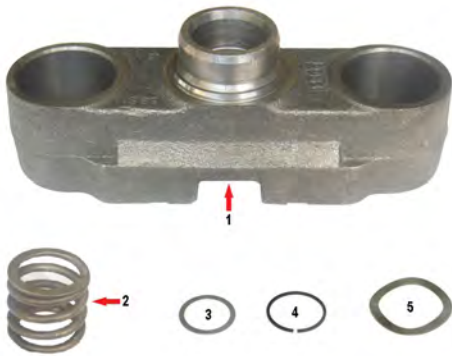

Caliper Bridge Assembly Repair Kit

Pos.	AYS Code	Description	Dimension	Qty
1	4H570	BRIDGE ASSEMBLY		1
2	4H563	SPRING		1
3	4H554	WASHER		1
4	4H555	WASHER		1
5	4H556	WASHER		1

AYS Code 4H032



Caliper Pad Retainer Repair Kit





Pos.	AYS Code	Description	Dimension	Qty
1	4H032	Pad Retainer		1
2	4H516	Screw	M10 x 1.5 / 25 mm	1

AYS Code **4H034**

Pos.	AYS Code	Description	Dimension	Qty
	4H509	COVER		1
	4M561	SCREW	M8 x 45mm	4

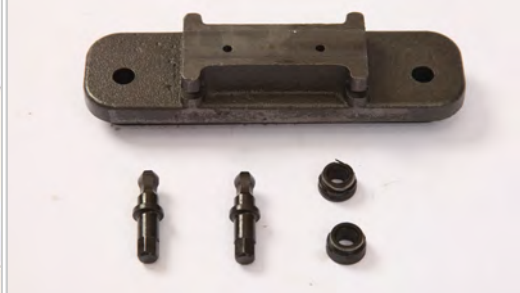

Caliper Cover

<p>AYS Code 4H002</p>	<p>AYS Code 4H003</p>	<p>AYS Code 4H019</p>
		
<p>Caliper Roller Bearings</p>	<p>Caliper Push Plate</p>	<p>Caliper Adjustment Sleeve (Driven)</p>
<p>AYS Code 4H020</p>	<p>AYS Code 4H026</p>	<p>AYS Code 4H027</p>
		
<p>Caliper Adjustment Sleeve (Driving)</p>	<p>Caliper Lever</p>	<p>Caliper Adjusting Mechanism</p>
<p>AYS Code 4H029</p>	<p>AYS Code 4H046</p>	<p>AYS Code 4H047</p>
		
<p>Caliper Mechanism Clamp</p>	<p>Caliper Mechanism, Piston & Cover Kit</p>	<p>Caliper Mechanism Metal Top Cover Kit</p>

HALDEX

MARK IV SERIES

CALIPER REPAIR KITS

KALİPER TAMİR TAKIMI

AYDINSAN  BRAKE SYSTEMS

www.aydinsan.com.tr

AYS Code 4H032

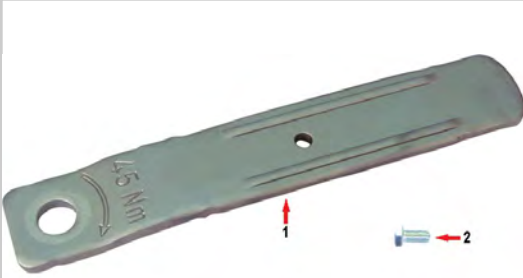

Caliper Pad Retainer Repair Kit

Pos.	AYS Code	Description	Dimension	Qty
1	4H032	Pad Retainer		1
2	4H516	Screw	M10 x 1.5 / 25 mm	1

AYS Code 4H039



Caliper Calibration Bolt Kit (Piston)

Pos.	AYS Code	Description	Dimension	Qty
1		Calibration Bolt (Right)		1
2		Calibration Bolt (Left)		1

AYS Code 4H040

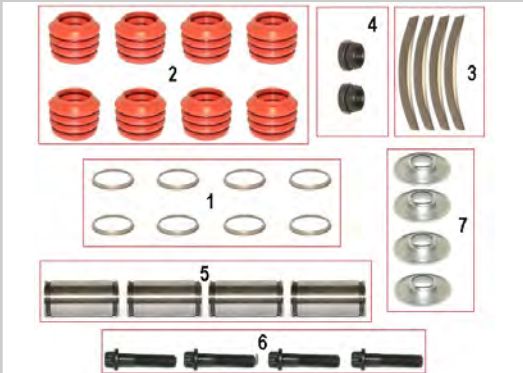

Caliper Guide & Seals Repair Kit

Pos.	AYS Code	Description	Dimension	Qty
1	4H553	DUST COVER EXCLUDER		8
2	4H532	GUIDE PIN DUST COVER		8
3	4H521	GUIDE PIN BUSH		4
4	4H551	PLUG		2
5	4H504	GUIDE PIN	Ø35 x 70 mm	4
6	4H519	GUIDE PIN BOLT	M14 x 2mm x 61 mm	4
7	4H544	STEEL COVER		4

AYS Code 4H042



Caliper Cover

Pos.	AYS Code	Description	Dimension	Qty
	4H510	COVER		1
	4H520	SCREW	M8 x 60mm	4

AYS Code 4H043



Caliper Dust Cover&Spring Repair Kit













Pos.	AYS Code	Description	Dimension	Qty
	4H533	TAPPET DUST COVER		2
	4H566	PROTECTION SPRING		2

AYS Code 4H044



Caliper Circlip Kit

Pos.	AYS Code	Description	Dimension	Qty
1	4H560	Circlip		6
2	4H567	Circlip		6

<p>AYS Code 4H037</p>	<p>AYS Code 4H038</p>	<p>AYS Code 4H041</p>
		
<p>Caliper Mechanism Clamp</p>	<p>Caliper Spring Repair Kit</p>	<p>Caliper Mechanism</p>
<p>AYS Code 4H045</p>	<p>AYS Code 4H048</p>	<p>AYS Code 4H049</p>
		
<p>Caliper Bridge Assembly Repair Kit</p>	<p>Caliper Bearings</p>	<p>Caliper Bearings</p>
<p>AYS Code 4H050</p>	<p>AYS Code 4H051</p>	<p>AYS Code 4H052</p>
		
<p>Caliper Lever</p>	<p>Caliper Tappet Repair Kit</p>	<p>Caliper Mechanism Metal Top Cover Kit</p>
<p>AYS Code 4H053</p>	<p>AYS Code 4H054</p>	<p>AYS Code 4H055</p>
		
<p>Caliper Mechanism Gear (Left)</p>	<p>Caliper Mechanism Gear (Right)</p>	<p>Caliper Mechanism, Piston & Cover Kit</p>

HALDEX

MODUL X-GEN 1 SERIES

CALIPER REPAIR KITS

KALİPER TAMİR TAKIMI

AYDINSAN 

www.aydinsan.com.tr

AYS Code 4H004

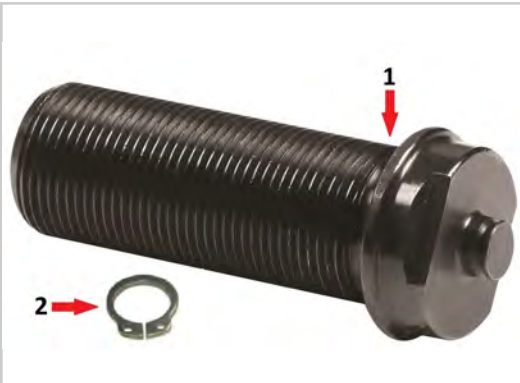

Caliper Calibration Bolt

Pos.	AYS Code	Description	Dimension	Qty
1	4H514	CALIBRATION BOLT		1
2	4H557	WASHER		1

AYS Code 4H007



Caliper Dust Covers and Seals Repair Kit

Pos.	AYS Code	Description	Dimension	Qty
1	4H532	GUIDE PIN DUST COVER		6
2	4H551	PLUG		1
3	4H531	TAPPET DUST COVER		2

AYS Code 4H015



Caliper Dust Cover & Spring Repair Kit

Pos.	AYS Code	Description	Dimension	Qty
1	4H561	PROTECTION SPRING		2
2	4H531	TAPPET DUST COVER		2

AYS Code 4H024

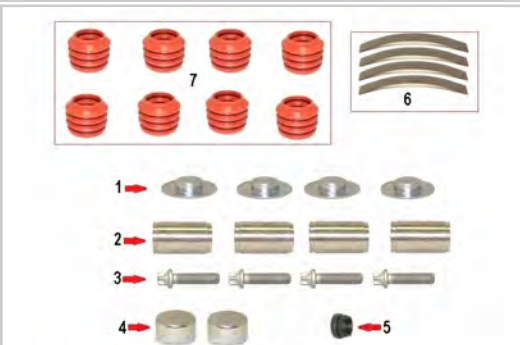

Caliper Guide & Seals Repair Kit

Pos.	AYS Code	Description	Dimension	Qty
1	4H543	STEEL COVER		4
2	4H503	GUIDE PIN	Ø35 x 64 mm	4
3	4H511	GUIDE PIN BOLT	M14 x 2 x 42 mm	4
4	4H542	STEEL COVER	Ø42 mm	2
5	4H551	PLUG		1
6	4H521	GUIDE PIN BUSH		4
7	4H532	GUIDE PIN DUST COVER		6

AYS Code 4H030



Caliper Cover

Pos.	AYS Code	Description	Dimension	Qty
1	4H508	COVER		1
2	4H513	SCREW	M8 x 30mm	4

AYS Code 4H031

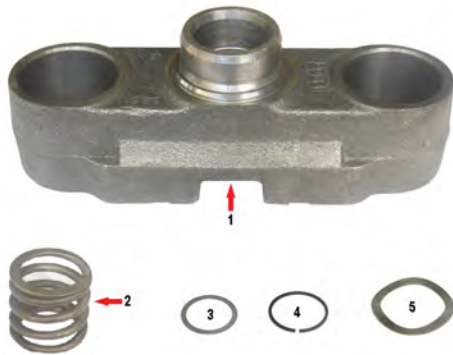

Caliper Bridge Assembly Repair Kit

Pos.	AYS Code	Description	Dimension	Qty
1	4H570	BRIDGE ASSEMBLY		1
2	4H563	SPRING		1
3	4H554	WASHER		1
4	4H555	WASHER		1
5	4H556	WASHER		1

AYS Code 4H032



Caliper Pad Retainer Repair Kit

Pos.	AYS Code	Description	Dimension	Qty
1	4H032	Pad Retainer		1
2	4H516	Screw	M10 x 1.5 / 25 mm	1

<p>AYS Code 4H002</p>	<p>AYS Code 4H009</p>	<p>AYS Code 4H012</p>
		
<p>Caliper Roller Bearings</p>	<p>Caliper Gear Wheel</p>	<p>Caliper Adjusting Bolt</p>
<p>AYS Code 4H020</p>	<p>AYS Code 4H026</p>	<p>AYS Code 4H027</p>
		
<p>Caliper Adjustment Sleeve (Driving)</p>	<p>Caliper Lever</p>	<p>Caliper Adjusting Mechanism</p>
<p>AYS Code 4H033</p>	<p>AYS Code 4H056</p>	
		
<p>Caliper Lever Pin</p>	<p>Caliper Mechanism Clamp</p>	

HALDEX

MODUL X-GEN 2 SERIES

CALIPER REPAIR KITS

KALİPER TAMİR TAKIMI

AYDINSAN  BRAKE SYSTEMS

www.aydinsan.com.tr

AYS Code 4H015

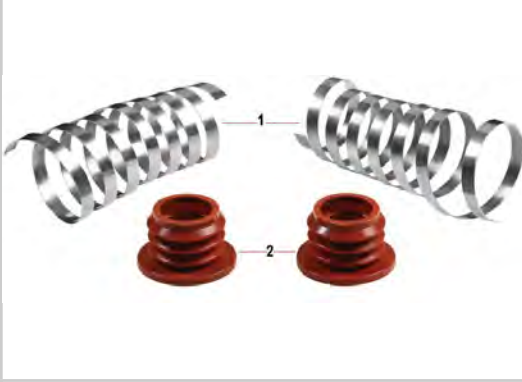

Caliper Dust Cover & Spring Repair Kit

Pos.	AYS Code	Description	Dimension	Qty
1	4H561	PROTECTION SPRING		2
2	4H531	TAPPET DUST COVER		2

AYS Code 4H016

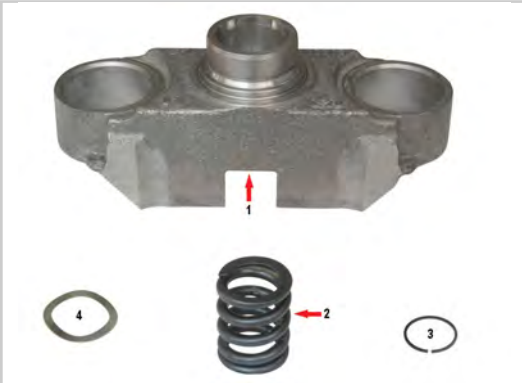

Caliper Bridge Assembly Repair Kit

Pos.	AYS Code	Description	Dimension	Qty
1	4H563	BRIDGE ASSEMBLY		1
2	4H563	SPRING		1
3	4H555	WASHER		1
4	4H556	WASHER		1

AYS Code 4H024

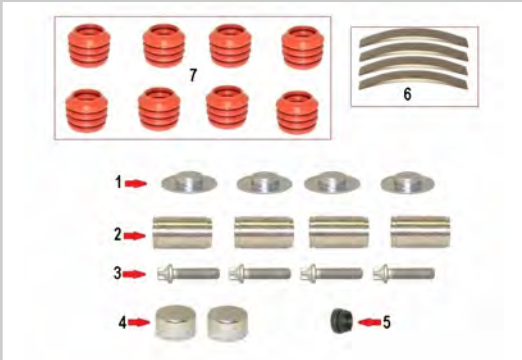

Caliper Guide & Seals Repair Kit

Pos.	AYS Code	Description	Dimension	Qty
1	4H521	GUIDE PIN BUSH		4
1	4H543	STEEL COVER		4
2	4H503	GUIDE PIN	Ø35 x 64 mm	4
3	4H511	GUIDE PIN BOLT	M14 x 2 x 42 mm	4
4	4H542	STEEL COVER	Ø42 mm	2
5	4H551	PLUG		1
7	4H532	GUIDE PIN DUST COVER		6

AYS Code 4H030



Caliper Cover

Pos.	AYS Code	Description	Dimension	Qty
1	4H508	COVER		1
2	4H513	SCREW	M8 x 30mm	4

AYS Code 4H032



Caliper Pad Retainer Repair Kit

Pos.	AYS Code	Description	Dimension	Qty
1	4H032	Pad Retainer		1
2	4H516	Screw	M10 x 1.5 / 25 mm	1

AYS Code 4H035



Caliper Mechanism, Piston & Cover Kit

Pos.	AYS Code	Description	Dimension	Qty
	4H005	Caliper Calibration Bolt (Piston Version)		2
	4H008	Caliper Adjustment Sleeve (Driving)		1
	4H009	Caliper Gear Wheel		1
	4H010	Caliper Adjustment Sleeve (Driven)		1
	4H011	Caliper Adjusting Mechanism		1
	4H012	Caliper Adjusting Bolt		1
	4H013	Caliper Roller Bearings		1
	4H014	Caliper Roller Bearings		1
	4H015	Caliper Dust Cover & Spring Repair Kit		1
	4H016	Caliper Bridge Assembly Repair Kit		1
	4H017	Caliper Synchronisation Plate		1
	4H018	Caliper Mechanism Clamp		1
	4H025	Caliper Lever		1
	4H028	Caliper Lever Pin		1
	4H030	Caliper Cover		1
	4H551	Plug		1

AYS Code 4H036

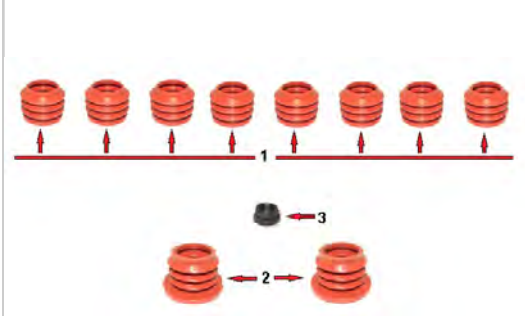

Caliper Dust Covers and Seals Repair Kit

Pos.	AYS Code	Description	Dimension	Qty
1	4H532	GUIDE PIN DUST COVER		8
2	4H531	TAPPET DUST COVER		2
3	4H551	PLUG		1

<p>AYS Code 4H008</p>	<p>AYS Code 4H009</p>	<p>AYS Code 4H010</p>
<p>Caliper Adjustment Sleeve (Driving)</p>	<p>Caliper Gear Wheel</p>	<p>Caliper Adjustment Sleeve (Driven)</p>
<p>AYS Code 4H011</p>	<p>AYS Code 4H012</p>	<p>AYS Code 4H013</p>
<p>Caliper Adjusting Mechanism</p>	<p>Caliper Adjusting Bolt</p>	<p>Caliper Roller Bearings</p>
<p>AYS Code 4H014</p>	<p>AYS Code 4H017</p>	<p>AYS Code 4H018</p>
<p>Caliper Roller Bearings</p>	<p>Caliper Synchronisation Plate</p>	<p>Caliper Mechanism Clamp</p>
<p>AYS Code 4H025</p>	<p>AYS Code 4H028</p>	
<p>Caliper Lever</p>	<p>Caliper Lever Pin</p>	

HALDEX

SETS

CALIPER REPAIR KITS

KALİPER TAMİR TAKIMI

AYDINSAN  BRAKE SYSTEMS

www.aydinsan.com.tr



Pos.	AYS Code	Description	Dimension	Qty
1	4H016	Caliper Bridge Assembly		1
2	4H017	Caliper Synchronisation Plate		1
3	4H012	Caliper Adjusting Bolt		1
4	4H014	Caliper Roller Bearings		1
5	4H008	Caliper Adjustment Sleeve (Driving)		1
6	4H552	Adjusting Bolt Seal		1
7	4H024	Caliper Guide & Seals Repair Kit		1
8	4H010	Caliper Adjustment Sleeve (Driven)		1
9	4H011	Caliper Adjusting Mechanism		1
10	4H009	Caliper Gear Wheel		1
11	4H018	Caliper Mechanism Clamp		1
12	4H005	Caliper Calibration Bolt (Piston version)		2
13	4H013	Caliper Roller Bearings		1
14	4H028	Caliper Lever Pin		1
15	4H015	Caliper Dust Cover & Spring Repair Kit		1



Pos.	AYS Code	Description	Dimension	Qty
1	4H021	Caliper Adjuster Bolts & Seals Repair Kit		1
2	4H020	Caliper Adjustment Sleeve (Driving)		1
3	4H019	Caliper Adjustment Sleeve (Driven)		1
4	4H031	Caliper Bridge Assembly Repair Kit		1
5	4H022	Caliper Guide & Seals Repair Kit		1
6	4H029	Caliper Mechanism Clamp		2
7	4H027	Caliper Adjusting Mechanism		1
8	4H001	Caliper Roller Bearing		1
9	4H009	Caliper Gear Wheel		1
10	4H015	Caliper Dust Cover & Spring Repair Kit		1
11	4H004	Caliper Calibration Bolt (Push plate version)		2
12	4H002	Caliper Roller Bearing		1
13	4H003	Caliper Push Plate		1



Pos.	AYS Code	Description	Dimension	Qty
1	4H021	Caliper Adjuster Bolts & Seals Repair Kit		1
2	4H020	Caliper Adjustment Sleeve (Driving)		1
3	4H019	Caliper Adjustment Sleeve (Driven)		1
4	4H031	Caliper Bridge Assembly Repair Kit		1
5	4H023	Caliper Guide & Seals Repair Kit		1
6	4H029	Caliper Mechanism Clamp		2
7	4H027	Caliper Adjusting Mechanism		1
8	4H001	Caliper Roller Bearing		1
9	4H009	Caliper Gear Wheel		1
10	4H015	Caliper Dust Cover & Spring Repair Kit		1
11	4H006	Caliper Calibration Bolt (Push plate version)		2
12	4H002	Caliper Roller Bearing		1
13	4H003	Caliper Push Plate		1

BPW

TSB3709/4309/4312

CALIPER REPAIR KITS

KALİPER TAMİR TAKIMI

AYDINSAN 

www.aydinsan.com.tr



Pos.	AYS Code	Description	Dimension	Qty
1	4B505	INNER BOOT		2
2	4B506	WASHER(PLASTIC)		2
3	4B509	O-RING		1
4	4B511	PLUG		1
5	4B510	PLASTIC CAP		2
6	4B508	BRONZE BUSH	Ø41 x Ø37 x 30 mm	1
7	4B507	BRONZE BUSH	Ø41 x Ø37 x 73 mm	1



Pos.	AYS Code	Description	Dimension	Qty
1	4B501	GUIDE PIN (LONG)	Ø37 x 123 mm	1
2	4B502	GUIDE PIN (SHORT)	Ø36 x 70 mm	1
3	4B503	BOLT (LONG)	M16 x 1.5 x 100 mm	1
4	4K511	BOLT (SHORT)	M16 x 1.5 x 70 mm	1
5	4B510	PLASTIC CAP		2
6	4B509	O-RING		1
7	4B518	PIN CIRCLIP		1
8	4B508	BRONZE BUSH	Ø41 x Ø37 x 30 mm	1
9	4B507	BRONZE BUSH	Ø41 x Ø37 x 73 mm	1



Pos.	AYS Code	Description	Dimension	Qty
1	4B502	GUIDE PIN (SHORT)	Ø36 x 70 mm	1
2	4B501	GUIDE PIN (LONG)	Ø37 x 123 mm	1
3	4K511	BOLT (SHORT)	M16 x 1.5 x 70 mm	1
4	4B503	BOLT (LONG)	M16 x 1.5 x 100 mm	1
5	4B507	BRONZE BUSH	Ø41 x Ø37 x 73 mm	1
6	4B508	BRONZE BUSH	Ø41 x Ø37 x 30 mm	1
7	4B505	INNER BOOT		2
8	4B510	PLASTIC CAP		2
9	4B509	O-RING		1
10	4B518	PIN CIRCLIP		1
11	4B506	WASHER(PLASTIC)		2
12	4B511	PLUG		1



Pos.	AYS Code	Description	Dimension	Qty
1	4B512	TAPPET		2
2	4B513	TAPPET BOOT		2
3	4B514	LOCKER		2
4	4B515	CLAMP		2

AYS Code 4B007



Caliper Tappet & Boot Repair Kit





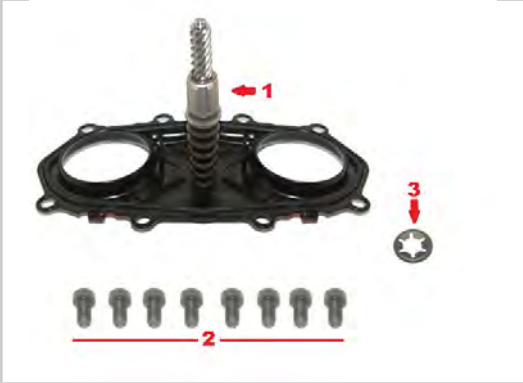







Pos.	AYS Code	Description	Dimension	Qty
1	4B519	TAPPET (WITH PIN)		2
2	4B514	LOCKER		2
3	4B513	TAPPET BOOT		2
4	4B515	CLAMP		2

AYS Code 4B010

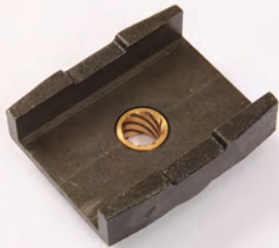

Caliper Cover Mechanism

Pos.	AYS Code	Description	Dimension	Qty
1	4B520	MECHANISM COVER		1
2	4K573	SCREW	Ø8 x 16 mm	8
3	4B521	MECHANISM SEAL		1

<p>AYS Code 4B005</p>	<p>AYS Code 4B006</p>	<p>AYS Code 4B008</p>
		
<p>Caliper Roller Bearing</p>	<p>Caliper Flat Bearings</p>	<p>Caliper Calibration Bolt</p>
<p>AYS Code 4B009</p>	<p>AYS Code 4B011</p>	<p>AYS Code 4B012</p>
		
<p>Caliper Mechanism Bearing House</p>	<p>Caliper Mechanism Seal Se</p>	<p>Caliper Shaft Roller Bearing Kit</p>
<p>AYS Code 4B013</p>	<p>AYS Code 4B014</p>	<p>AYS Code 4B015</p>
		
<p>Caliper Bridge Assembly</p>	<p>Caliper Calibration Bolt Housing</p>	<p>Caliper Plug Set</p>
<p>AYS Code 4B016</p>	<p>AYS Code 4B017</p>	<p>AYS Code 4B018</p>
		
<p>Caliper Mechanism Bearing House</p>	<p>Caliper Mechanism Housing</p>	<p>Caliper Adjusting Mechanism</p>

AYS Code **4B020**



Caliper Pad Retainer Repair Kit

AYS Code **4B021**



Caliper Pad Retainer Repair Kit

AYS Code **4B022**



Caliper Lever Repair Kit

AYS Code **4B023**



Caliper Mechanism, Piston & Cover Kit

AYS Code **4B024**



Caliper Pad Retainer Repair Kit

SAF

SBS 2220

CALIPER REPAIR KITS

KALİPER TAMİR TAKIMI

AYDINSAN  BRAKE SYSTEMS

www.aydinsan.com.tr

AYS Code 4S001



Caliper Guides & Seals Repair Kit











Pos.	AYS Code	Description	Dimension	Qty
1	4S504	INNER BOOT		2
2	4S507	STEEL CAP (Ø45) (Long)	22mm	1
3	4S506	STEEL CAP (Ø42) (Short)	26mm	1
4	4S513	BUSH RETAINER	Ø39,5 x Ø36 x 14,5 mm	1
5	4S508	WASHER		2
6	4S505	BUSH	Ø39 x 30 mm	2
7	4S503	PLASTIC OVAL BUSH	Ø35,7xØ35,4x87mm	1
8	4S501	GUIDE PIN (Long)	Ø35 x 120 mm	1
9	4S502	GUIDE PIN (Short)	Ø35,5 x 87 mm	1
10	4K513	BOLT (Short)	M16x1,5 x 80 mm	2

AYS Code 4S002



Caliper Adjuster Gear Plastic

Pos.	AYS Code	Description	Dimension	Qty
1	4S515	Seal		5
2	4S512	Adjuster Gear Plastic		5

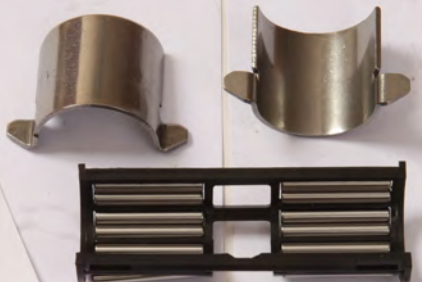
<p>AYS Code 4S003</p>	<p>AYS Code 4S004</p>	<p>AYS Code 4S005</p>
		
<p>Caliper Adjuster Screw Gaiter Kit</p>	<p>Caliper Plastic Adjuster Gear Kit</p>	<p>Caliper Calibration Bolt</p>
<p>AYS Code 4S006</p>	<p>AYS Code 4S007</p>	<p>AYS Code 4S008</p>
		
<p>Caliper Plastic Cap</p>	<p>Caliper Plastic Cap</p>	<p>Caliper Mechanism</p>
<p>AYS Code 4S009</p>	<p>AYS Code 4S010</p>	<p>AYS Code 4S011</p>
		
<p>Caliper Mechanism Bearing House</p>	<p>Caliper Mechanism Locking Plastic Repair Kit</p>	<p>Caliper Mechanism Bearing House</p>
<p>AYS Code 4S012</p>	<p>AYS Code 4S013</p>	<p>AYS Code 4S014</p>
		
<p>Caliper Mechanism Bearing Repair Kit</p>	<p>Caliper Mechanism Plate</p>	<p>Caliper Bearings</p>

<p>AYS Code 4S015</p>	<p>AYS Code 4S016</p>	<p>AYS Code 4S017</p>
		
<p>Caliper Bearing</p>	<p>Caliper Bearing Repair Kit</p>	<p>Caliper Mechanism Set</p>
<p>AYS Code 4S018</p>	<p>AYS Code 4S019</p>	
		
<p>Caliper Lever</p>	<p>Caliper Pad Retainer Repair Kit</p>	