

# 00

## INDEX

**AUGER NR.**

-

**O.E.M. NR.**







| Auger Nr. | O.E.M. Nr.   | Page Nr. | Auger Nr. | O.E.M. Nr.   | Page Nr. |
|-----------|--------------|----------|-----------|--------------|----------|
| 15105     | 8226293000B  | 16.8     | 21009     | 4235060010   | 20.25    |
| 20002     | 0542941010S  | 13.47    | 21010     | -            | 13.36    |
| 20002     | 4881MBS      | 13.47    | 21010     | -            | 19.10    |
| 20004     | 0542940910S  | 13.47    | 21010     | -            | 9.8      |
| 20004     | 940MBS       | 13.47    | 21010     | BZ3370       | 20.26    |
| 20005     | 0542940030S  | 13.47    | 21011     | 945157       | 20.26    |
| 20005     | 941MBS       | 13.47    | 21011     | 0203272700   | 13.36    |
| 20029     | 0542941010S1 | 13.47    | 21011     | 051007       | 9.8      |
| 20030     | -            | 13.48    | 21011     | 0544413010   | 13.36    |
| 20031     | -            | 13.48    | 21011     | 4231049000   | 20.26    |
| 20032     | 0542940010S  | 13.47    | 21011     | 79537        | 20.26    |
| 20032     | 881MBS       | 13.47    | 21011     | AFA9104001   | 19.10    |
| 20033     | -            | 13.48    | 21011     | ASX0014-018  | 19.10    |
| 20034     | 0542940910S1 | 13.47    | 21012     | -            | 13.36    |
| 20035     | -            | 13.48    | 21012     | -            | 19.10    |
| 20036     | 0542940030S1 | 13.48    | 21012     | -            | 9.8      |
| 20114     | 0542940010S1 | 13.48    | 21012     | BX3417       | 20.26    |
| 21000     | -            | 13.37    | 21013     | 945154       | 20.26    |
| 21000     | BS7304       | 20.24    | 21013     | 0203273200   | 13.36    |
| 21001     | 0544441010   | 13.37    | 21013     | 0203362000   | 13.36    |
| 21001     | 0544441010   | 20.24    | 21013     | 051009       | 9.8      |
| 21002     | -            | 13.38    | 21013     | 0544414010   | 13.36    |
| 21002     | -            | 20.24    | 21013     | 175 202      | 20.26    |
| 21003     | 0544444010   | 13.38    | 21013     | 4231059000   | 20.26    |
| 21003     | 0544444010   | 20.24    | 21013     | 79302        | 20.26    |
| 21004     | -            | 13.35    | 21013     | ASX0014-019  | 19.10    |
| 21004     | -            | 14.25    | 21014     | -            | 13.36    |
| 21004     | -            | 19.10    | 21014     | -            | 19.11    |
| 21004     | BS3300       | 20.25    | 21014     | -            | 9.9      |
| 21005     | 0203277000   | 13.35    | 21014     | BX3535       | 20.26    |
| 21005     | 0203277100   | 13.35    | 21015     | 77348        | 20.26    |
| 21005     | 0544432010   | 13.35    | 21015     | 0203273100   | 13.36    |
| 21005     | 0544432020   | 13.35    | 21015     | 0203273100   | 13.36    |
| 21005     | 334652       | 20.25    | 21015     | 051012       | 9.9      |
| 21005     | 3454106560   | 14.25    | 21015     | 0544415010   | 13.36    |
| 21005     | 3454108160   | 14.25    | 21015     | 0544415100   | 13.36    |
| 21005     | 4231047100   | 20.25    | 21015     | 0544415110   | 13.36    |
| 21005     | 5812866      | 20.25    | 21015     | 175 203      | 20.26    |
| 21005     | 58128660     | 20.25    | 21015     | 1H312161-609 | 19.11    |
| 21005     | AJV4526      | 19.10    | 21015     | 4231069000   | 20.26    |
| 21006     | -            | 13.35    | 21015     | 79303        | 20.26    |
| 21006     | -            | 14.25    | 21015     | 945153       | 20.26    |
| 21006     | BS3404       | 20.25    | 21015     | ASX0014-020  | 19.11    |
| 21007     | 0203277400   | 13.35    | 21016     | -            | 13.36    |
| 21007     | 0203277500   | 13.35    | 21016     | -            | 14.26    |
| 21007     | 0544434010   | 13.35    | 21016     | -            | 19.11    |
| 21007     | 0544434020   | 13.35    | 21016     | -            | 9.9      |
| 21007     | 337900       | 20.25    | 21016     | BX3605       | 20.26    |
| 21007     | 3454106760   | 14.25    | 21017     | 0203272900   | 13.37    |
| 21007     | 3454108260   | 14.25    | 21017     | 051017       | 9.9      |
| 21007     | 4235050000   | 20.25    | 21017     | 0544416010   | 13.37    |
| 21008     | -            | 13.35    | 21017     | 0544416100   | 13.37    |
| 21008     | -            | 14.25    | 21017     | 0544416110   | 13.37    |
| 21008     | BS3509       | 20.25    | 21017     | 175 204      | 20.26    |
| 21009     | 0203277800   | 13.35    | 21017     | 4231079000   | 20.26    |
| 21009     | 0203277900   | 13.35    | 21017     | 4454103900   | 14.26    |
| 21009     | 0544436010   | 13.35    | 21017     | 79545        | 20.26    |
| 21009     | 0544436020   | 13.35    | 21017     | 82830500000  | 9.9      |
| 21009     | 337902       | 20.25    | 21017     | 945152       | 20.26    |
| 21009     | 3454106960   | 14.25    | 21017     | ASX0014-021  | 19.11    |



| Auger Nr. | O.E.M. Nr.  | Page Nr. | Auger Nr. | O.E.M. Nr.  | Page Nr. |
|-----------|-------------|----------|-----------|-------------|----------|
| 21017     | M020272-03  | 19.11    | 31030     | 4079000501  | 14.26    |
| 21018     | -           | 13.37    | 31031     | 4079000701  | 14.26    |
| 21018     | -           | 20.27    | 51075     | 1230004700  | 14.4     |
| 21018     | -           | 9.9      | 51137     | 82262320660 | 16.8     |
| 21019     | 335890      | 20.27    | 51972     | 82262960690 | 16.8     |
| 21019     | 0203273900  | 13.37    | 52066     | 0331096050  | 13.43    |
| 21019     | 050408      | 9.9      | 52067     | 0331096060  | 13.43    |
| 21019     | 0544420010  | 13.37    | 52068     | 0331097070  | 13.43    |
| 21019     | 0544420040  | 13.37    | 52069     | 0331097080  | 13.43    |
| 21019     | 0544420100  | 13.37    | 52070     | 0331096040  | 13.43    |
| 21019     | 0544420110  | 13.37    | 52071     | 0331097040  | 13.43    |
| 21019     | 0945470     | 20.27    | 52072     | 0331097160  | 13.43    |
| 21019     | 9253713000  | 20.27    | 52073     | 0331097030  | 13.43    |
| 21019     | BX7515      | 20.27    | 52074     | 0331097130  | 13.43    |
| 21020     | -           | 13.37    | 52074     | 0331097280  | 13.43    |
| 21020     | -           | 20.27    | 52074     | 8241021350  | 16.7     |
| 21021     | 0544421010  | 13.37    | 52075     | 0331098070  | 13.43    |
| 21021     | 0544421040  | 13.37    | 52076     | 0331097320  | 13.43    |
| 21021     | 0544421110  | 13.37    | 52076     | 8241999460  | 16.7     |
| 21021     | 343320      | 20.27    | 52077     | 0331097140  | 13.43    |
| 21021     | 9253723000  | 20.27    | 52077     | 0331097290  | 13.43    |
| 21900     | -           | 20.39    | 52077     | 8241021349  | 16.7     |
| 21900     | 050457      | 9.10     | 52078     | 0331098060  | 13.43    |
| 21901     | -           | 20.39    | 52079     | 0331097310  | 13.43    |
| 21902     | -           | 20.39    | 52079     | 8241999459  | 16.7     |
| 21903     | -           | 20.39    | 52080     | 0331097150  | 13.43    |
| 21904     | -           | 20.39    | 52080     | 0331097270  | 13.43    |
| 21904     | 0220041300  | 13.38    | 52080     | 8241037365  | 16.7     |
| 21904     | 1030977424  | 13.38    | 52081     | 0331098140  | 13.43    |
| 21904     | 8285417000  | 16.5     | 52081     | 0331098190  | 13.43    |
| 21905     | -           | 20.39    | 52081     | 8241037364  | 16.7     |
| 21905     | 0220041700  | 13.38    | 52082     | 0331098040  | 13.43    |
| 21905     | 050458      | 9.10     | 52083     | 0331097300  | 13.43    |
| 21906     | -           | 20.39    | 52083     | 8241999546  | 16.7     |
| 21906     | 0220041500  | 13.38    | 52084     | 0331098130  | 13.43    |
| 21907     | -           | 20.39    | 52085     | 0331098020  | 13.43    |
| 21908     | -           | 20.39    | 52086     | 0331038200  | 13.43    |
| 21909     | -           | 20.39    | 52087     | 0331098210  | 13.43    |
| 21909     | 050460      | 9.10     | 52087     | 8241999447  | 16.7     |
| 21910     | -           | 20.39    | 52087     | 8241999547  | 16.7     |
| 21910     | 050461      | 9.10     | 52088     | 0331038210  | 13.43    |
| 21911     | -           | 20.39    | 52089     | 0331099020  | 13.43    |
| 21911     | 050462      | 9.10     | 52089     | 0331099150  | 13.43    |
| 21912     | -           | 20.39    | 52090     | 0331099010  | 13.43    |
| 21951     | 9507300050  | 20.39    | 52090     | 0331099160  | 13.43    |
| 31000     | 21224263    | 17.16    | 52091     | 0331098240  | 13.43    |
| 31001     | 21225115    | 17.16    | 52092     | 0331097220  | 13.43    |
| 31002     | 21212670    | 17.16    | 52093     | 0331098180  | 13.43    |
| 31003     | 21227349    | 17.16    | 52100     | 0335367090  | 13.7     |
| 31004     | 0308834020  | 13.39    | 52100     | 0535367090  | 13.7     |
| 31005     | 0308834040  | 13.39    | 52101     | 0335367080  | 13.7     |
| 31006     | 0308834010  | 13.39    | 52101     | 0535367080  | 13.7     |
| 31007     | 0308834030  | 13.39    | 52102     | 0203160100  | 13.8     |
| 31008     | 0308835010  | 13.39    | 52102     | 0511396050  | 13.8     |
| 31009     | 0308835030  | 13.39    | 52103     | 0511390060  | 13.1     |
| 31013     | MO 69018    | 19.11    | 52104     | 0511393030  | 13.1     |
| 31016     | 351605      | 16.5     | 52104     | 4177301600  | 14.1     |
| 31016     | 1792411131  | 16.5     | 52105     | 0203160600  | 13.1     |
| 31016     | 17924111310 | 16.5     | 52105     | 21222609    | 17.1     |
| 31029     | 4079000400  | 14.26    | 52105     | 8241202905  | 16.1     |



| Auger Nr. | O.E.M. Nr. | Page Nr. | Auger Nr. | O.E.M. Nr. | Page Nr. |
|-----------|------------|----------|-----------|------------|----------|
| 52106     | 0511398080 | 13.1     | 52154     | 031244300S | 13.13    |
| 52107     | 0511393020 | 13.8     | 52155     | 0980102150 | 13.13    |
| 52107     | 0511396060 | 13.8     | 52156     | 0980106090 | 13.14    |
| 52108     | 750841     | 9.8      | 52157     | -          | 13.13    |
| 52108     | 0203160500 | 13.1     | 52158     | 0980102220 | 13.15    |
| 52108     | 0203166500 | 13.1     | 52159     | 0980100242 | 13.15    |
| 52108     | 21208093   | 17.1     | 52160     | 0980102130 | 13.13    |
| 52108     | 8241000421 | 16.1     | 52160     | 0980102140 | 13.13    |
| 52110     | 0511397100 | 13.1     | 52161     | 0980100370 | 13.14    |
| 52116     | 0311396040 | 13.8     | 52162     | 0980100140 | 13.16    |
| 52116     | 0311398060 | 13.8     | 52162     | 8241000622 | 16.2     |
| 52118     | 0203169000 | 13.2     | 52163     | 0980100141 | 13.16    |
| 52118     | 21215601R  | 17.1     | 52164     | 0980100142 | 13.15    |
| 52119     | -          | 13.8     | 52165     | 0980100430 | 13.15    |
| 52120     | 0321224250 | 13.40    | 52166     | 0980102160 | 13.14    |
| 52121     | 0321225080 | 13.40    | 52167     | 0318190100 | 13.7     |
| 52122     | 0321223090 | 13.40    | 52168     | 0318190020 | 13.7     |
| 52122     | 8241999292 | 16.6     | 52168     | 0318190060 | 13.7     |
| 52123     | 0321223020 | 13.40    | 52168     | 0318190061 | 13.7     |
| 52123     | 8241016244 | 16.6     | 52168     | 1169000301 | 14.4     |
| 52124     | 0321224070 | 13.40    | 52168     | 8241000430 | 16.1     |
| 52124     | 8241999464 | 16.6     | 52169     | 0318190010 | 13.7     |
| 52125     | 0321224020 | 13.40    | 52169     | 0318190050 | 13.7     |
| 52125     | 8241037372 | 16.6     | 52169     | 1318100102 | 14.4     |
| 52126     | 0321205010 | 13.41    | 52169     | 8241000422 | 16.1     |
| 52126     | 0321225020 | 13.41    | 52175     | 0326216030 | 13.44    |
| 52126     | 8241030286 | 16.6     | 52175     | 8241021348 | 16.7     |
| 52127     | 0321226010 | 13.41    | 52176     | 0326216020 | 13.44    |
| 52128     | 0321222010 | 13.41    | 52176     | 1011000700 | 14.28    |
| 52129     | 0321222040 | 13.41    | 52177     | 0326217080 | 13.44    |
| 52130     | 0321222050 | 13.41    | 52177     | 8241037363 | 16.7     |
| 52131     | 0321223010 | 13.41    | 52178     | 0326217030 | 13.44    |
| 52132     | 0321207010 | 13.42    | 52178     | 0326217110 | 13.44    |
| 52132     | 0321227010 | 13.42    | 52183     | 9900000093 | 13.28    |
| 52133     | 0322902100 | 13.25    | 52184     | 9900000071 | 13.28    |
| 52133     | 8241999300 | 16.5     | 52185     | 9900000088 | 13.28    |
| 52134     | 0322902010 | 13.25    | 52186     | 9900000080 | 13.28    |
| 52134     | 8241016214 | 16.5     | 52187     | 9900000073 | 13.28    |
| 52135     | 0322902030 | 13.25    | 52188     | 9900000040 | 13.28    |
| 52135     | 8241000618 | 16.5     | 52189     | 9900000850 | 13.29    |
| 52136     | 0322902090 | 13.25    | 52190     | 9900000075 | 13.29    |
| 52136     | 8241999301 | 16.5     | 52191     | 9900000042 | 13.29    |
| 52137     | 0322902170 | 13.25    | 52192     | 9900000095 | 13.29    |
| 52138     | 0322902160 | 13.25    | 52193     | 9900000076 | 13.29    |
| 52139     | 0322902180 | 13.26    | 52194     | 9900000072 | 13.29    |
| 52140     | 0322902190 | 13.26    | 52195     | 9900000070 | 13.30    |
| 52141     | 0322902161 | 13.26    | 52196     | 9900000097 | 13.30    |
| 52142     | 0318802020 | 13.12    | 52197     | 9900000089 | 13.30    |
| 52143     | 0311314010 | 13.26    | 52198     | 9900000094 | 13.30    |
| 52143     | 8241016213 | 16.4     | 52199     | 9900000087 | 13.30    |
| 52144     | 0311314030 | 13.26    | 52200     | 9900000098 | 13.30    |
| 52145     | 0312043090 | 13.27    | 52201     | 0301093330 | 13.45    |
| 52145     | 0312063010 | 13.27    | 52202     | 0301093340 | 13.45    |
| 52146     | 0312043100 | 13.27    | 52203     | 0337025160 | 13.45    |
| 52147     | 0312043140 | 13.27    | 52204     | 0337026220 | 13.46    |
| 52148     | 0312043120 | 13.27    | 52204     | 0337026240 | 13.46    |
| 52150     | 0311244340 | 13.23    | 52205     | 4230017600 | 14.17    |
| 52150     | 0311344300 | 13.23    | 52206     | 1230010602 | 14.17    |
| 52152     | -          | 13.13    | 52206     | 1230010603 | 14.17    |
| 52153     | -          | 13.13    | 52206     | 1230010604 | 14.17    |



| Auger Nr. | O.E.M. Nr.    | Page Nr. | Auger Nr. | O.E.M. Nr.   | Page Nr. |
|-----------|---------------|----------|-----------|--------------|----------|
| 52206     | 6503721R      | 15.8     | 52242     | 3005017300   | 14.20    |
| 52207     | 1230100204    | 14.19    | 52243     | 3005011701   | 14.20    |
| 52207     | 3230100204    | 14.19    | 52244     | 3005014100   | 14.20    |
| 52208     | 1230100203    | 14.19    | 52245     | 3005005500   | 14.20    |
| 52209     | 1230100100    | 14.19    | 52246     | 3005000902   | 14.20    |
| 52209     | 1230100101    | 14.19    | 52247     | 21204703     | 17.13    |
| 52210     | 1230200101    | 14.19    | 52248     | 21204849     | 17.11    |
| 52210     | 1639000W      | 15.9     | 52249     | 21209990     | 17.13    |
| 52210     | 21006585      | 17.14    | 52250     | 21205667     | 17.11    |
| 52210     | 3230200101    | 14.19    | 52251     | 21011746     | 17.1     |
| 52210     | 500362        | 18.5     | 52251     | 500958       | 18.1     |
| 52210     | CF1001312     | 19.7     | 52253     | 21020676     | 17.1     |
| 52211     | 1072001800    | 14.19    | 52253     | 503624       | 18.1     |
| 52211     | 1072001801    | 14.19    | 52255     | 21 24754     | 17.1     |
| 52211     | 1656000E      | 15.9     | 52256     | 21011745     | 17.1     |
| 52211     | 21016723      | 17.14    | 52257     | 15213430     | 17.14    |
| 52211     | 21204602      | 17.14    | 52258     | 15220224     | 17.14    |
| 52212     | 1072001701    | 14.19    | 52258     | 15224821     | 17.14    |
| 52212     | 1655000W      | 15.9     | 52259     | 15204595     | 17.14    |
| 52212     | 21016722      | 17.14    | 52260     | AXL132       | 17.8     |
| 52212     | 21204601      | 17.14    | 52261     | AXL122       | 17.8     |
| 52213     | 4131000800    | 14.6     | 52262     | 10690588     | 17.7     |
| 52214     | 1350200104    | 14.18    | 52263     | SUS1         | 17.3     |
| 52215     | 1350200101    | 14.18    | 52264     | SUS2         | 17.3     |
| 52215     | 1350200102    | 14.18    | 52265     | SUS3         | 17.3     |
| 52215     | 1350200103    | 14.18    | 52266     | -            | 18.1     |
| 52216     | -             | 18.10    | 52266     | SUS4         | 17.3     |
| 52216     | -             | 19.8     | 52267     | 21202329     | 17.15    |
| 52216     | 1350200201    | 14.18    | 52267     | 21202330     | 17.15    |
| 52216     | 1669000G      | 15.8     | 52268     | 21008062     | 17.15    |
| 52217     | 4177301000    | 14.1     | 52268     | 21008063     | 17.15    |
| 52217     | 506242        | 18.1     | 52269     | 15220648     | 17.15    |
| 52217     | 6504210X      | 15.1     | 52269     | 21220647     | 17.15    |
| 52217     | M001502       | 18.12    | 52270     | 15224518     | 17.15    |
| 52217     | M001502       | 19.1     | 52270     | 21224522     | 17.15    |
| 52218     | 3268004600    | 14.6     | 52271     | 6502810F     | 15.9     |
| 52219     | 3268004500    | 14.6     | 52272     | 6504785Y     | 15.9     |
| 52220     | 3268004800    | 14.7     | 52272     | M010544      | 18.11    |
| 52221     | 3268004700    | 14.7     | 52273     | 6504771P     | 15.9     |
| 52222     | 3268000701    | 14.12    | 52273     | M007363      | 18.11    |
| 52223     | 3317000400    | 14.13    | 52275     | 6502103X     | 15.4     |
| 52224     | 3317000600    | 14.13    | 52276     | 6503723T     | 15.4     |
| 52225     | 3317000400SMB | 14.11    | 52277     | AJA0483001   | 19.8     |
| 52226     | 3434361800    | 14.8     | 52277     | AJA0483002   | 19.8     |
| 52226     | 3434362000    | 14.8     | 52278     | AEJA0441002A | 19.7     |
| 52227     | 3434362200    | 14.8     | 52279     | 21202104     | 17.2     |
| 52228     | 3317001100    | 14.13    | 52279     | 770701       | 18.1     |
| 52229     | -             | 14.10    | 52279     | UJA0033001   | 19.1     |
| 52230     | -             | 14.9     | 52280     | AJB0006001   | 19.8     |
| 52231     | -             | 14.11    | 52280     | AJB0006002   | 19.8     |
| 52232     | 3268000702    | 14.9     | 52281     | AEJA0441001  | 19.7     |
| 52233     | 3434363700    | 14.11    | 52282     | UJA0030001   | 19.1     |
| 52234     | 3434363800    | 14.9     | 52283     | AEJA0442001  | 19.7     |
| 52235     | 3434363600    | 14.9     | 52286     | 100114       | 19.2     |
| 52236     | 3268000600    | 14.11    | 52287     | 100113       | 19.2     |
| 52237     | 3317001000    | 14.13    | 52288     | CF1014969    | 19.3     |
| 52238     | 3317000900    | 14.13    | 52289     | -            | 19.3     |
| 52239     | 3317001600    | 14.13    | 52290     | CF100149     | 19.4     |
| 52240     | 3317003600    | 14.14    | 52296     | 0339745100   | 13.9     |
| 52241     | 3005014700    | 14.20    | 52296     | 0539745100   | 13.9     |



| Auger Nr. | O.E.M. Nr.  | Page Nr. | Auger Nr. | O.E.M. Nr.  | Page Nr. |
|-----------|-------------|----------|-----------|-------------|----------|
| 52300     | 0339734010  | 13.9     | 52341     | 0980102120  | 13.16    |
| 52301     | 0539745010  | 13.9     | 52342     | 0908446350  | 13.18    |
| 52301     | 0539746060  | 13.9     | 52343     | 0908446360  | 13.18    |
| 52301     | 0539746070  | 13.9     | 52344     | -           | 13.14    |
| 52304     | 0308442050  | 13.24    | 52345     | 0980102020  | 13.19    |
| 52305     | 0308452060  | 13.24    | 52346     | 0980102030  | 13.19    |
| 52306     | 0300108030  | 13.24    | 52347     | 0980102040  | 13.19    |
| 52306     | 0308452280  | 13.24    | 52348     | 0917723090  | 13.18    |
| 52306     | 8241092582  | 16.3     | 52349     | 0533184010  | 13.17    |
| 52307     | 0308442020  | 13.24    | 52350     | 0908446110  | 13.18    |
| 52307     | 8241129630  | 16.3     | 52351     | 0980102010  | 13.19    |
| 52308     | 0308452080  | 13.24    | 52352     | 0980102910  | 13.17    |
| 52309     | 0308452210  | 13.24    | 52353     | 0980102230  | 13.15    |
| 52310     | 0539728010  | 13.9     | 52354     | 9900000084  | 13.31    |
| 52311     | 0539745040  | 13.9     | 52355     | 0908446120  | 13.18    |
| 52311     | 0539745050  | 13.9     | 52356     | 0980102100  | 13.17    |
| 52311     | 8241021355  | 16.2     | 52357     | 3434363900  | 14.8     |
| 52312     | 0539746120  | 13.9     | 52359     | 4177000800  | 14.1     |
| 52313     | 0339744060  | 13.10    | 52360     | 1304001600  | 14.27    |
| 52313     | 8241999333  | 16.2     | 52361     | 1304004601  | 14.27    |
| 52314     | 0539756040  | 13.10    | 52362     | 1447002101  | 14.5     |
| 52314     | 0539756070  | 13.10    | 52362     | 1447003100  | 14.5     |
| 52314     | 0539757030  | 13.10    | 52363     | 1230003500  | 14.17    |
| 52315     | 0311302050  | 13.2     | 52365     | 1230014400  | 14.17    |
| 52316     | 0311301150  | 13.2     | 52366     | 4230018000  | 14.17    |
| 52317     | 0320034050  | 13.2     | 52367     | -           | 15.8     |
| 52318     | 0311301140  | 13.2     | 52367     | 1350200500  | 14.18    |
| 52319     | 0320034030  | 13.3     | 52367     | M003060     | 18.10    |
| 52320     | 0311302040  | 13.3     | 52367     | M003060     | 19.8     |
| 52321     | 0308446230  | 13.20    | 52368     | 1265000700  | 14.16    |
| 52322     | 0311233080  | 13.23    | 52368     | 1642000S    | 15.7     |
| 52322     | 8241999331  | 16.4     | 52368     | 21006610    | 17.13    |
| 52323     | 0311233040  | 13.23    | 52368     | AJA0504001  | 19.6     |
| 52323     | 8241000443  | 16.4     | 52368     | M002971     | 18.10    |
| 52324     | 0317723100  | 13.20    | 52368     | M002971     | 19.6     |
| 52324     | 0317723101  | 13.20    | 52369     | 1395100100  | 14.16    |
| 52325     | 0308446220  | 13.21    | 52370     | 2095203900  | 14.1     |
| 52325     | 8241999330  | 16.3     | 52372     | 1395101300  | 14.16    |
| 52326     | 0316723020  | 13.23    | 52373     | 1214002301  | 14.16    |
| 52327     | 0308446040  | 13.21    | 52373     | 1214002302  | 14.16    |
| 52328     | 0333134050  | 13.22    | 52374     | 3434360400  | 14.11    |
| 52329     | 0320034020  | 13.22    | 52375     | 3434360000  | 14.12    |
| 52329     | 8241129641  | 16.3     | 52376     | 327019000   | 14.3     |
| 52330     | 0308455110  | 13.21    | 52376     | 5399002070  | 14.3     |
| 52330     | 8241129634  | 16.3     | 52377     | 3005010800  | 14.21    |
| 52331     | 0333134020  | 13.22    | 52503     | 0980102090  | 13.17    |
| 52332     | 0333134010  | 13.22    | 52504     | 3434360100  | 14.12    |
| 52332     | 8241999222  | 16.3     | 52509     | 0004291431  | 20.28    |
| 52333     | 0311222070  | 13.23    | 52509     | 4325000200  | 20.28    |
| 52333     | 0311222210  | 13.23    | 52509     | 4520021000  | 20.28    |
| 52333     | 0311222240  | 13.23    | 52509     | 4520021070  | 20.28    |
| 52333     | 0311222300  | 13.23    | 52513     | 0004293530  | 20.31    |
| 52333     | 8241000894  | 16.4     | 52513     | 0109915     | 20.31    |
| 52334     | 0311302060  | 13.3     | 52513     | 1504064     | 20.31    |
| 52335     | 0980102090S | 13.17    | 52513     | 4522002110  | 20.31    |
| 52336     | 0980102110S | 13.16    | 52513     | 4680365     | 20.31    |
| 52337     | 0980102100S | 13.17    | 52513     | 5000440154  | 20.31    |
| 52338     | 0980102110  | 13.16    | 52513     | 61577724    | 20.31    |
| 52339     | 0980102120S | 13.16    | 52513     | 81512206024 | 20.31    |
| 52340     | 9900000037  | 13.31    | 52514     | 0004293930  | 20.31    |



| Auger Nr. | O.E.M. Nr.   | Page Nr. | Auger Nr. | O.E.M. Nr.   | Page Nr. |
|-----------|--------------|----------|-----------|--------------|----------|
| 52514     | 0004298030   | 20.31    | 52580     | -            | 13.34    |
| 52514     | 1584598      | 20.31    | 52580     | -            | 14.24    |
| 52514     | 2515298      | 20.31    | 52580     | -            | 15.3     |
| 52514     | 5000442713   | 20.31    | 52580     | -            | 17.4     |
| 52514     | 81512206094  | 20.31    | 52580     | -            | 19.9     |
| 52514     | 8157983      | 20.31    | 52580     | 8971205104   | 20.23    |
| 52514     | 9522002210   | 20.31    | 52581     | -            | 13.34    |
| 52515     | 0004293630   | 20.31    | 52581     | -            | 14.24    |
| 52515     | 1505065      | 20.31    | 52581     | -            | 15.3     |
| 52515     | 4522002120   | 20.31    | 52581     | -            | 17.4     |
| 52515     | 4680365      | 20.31    | 52581     | -            | 19.9     |
| 52515     | 5000440155   | 20.31    | 52581     | 8971205204   | 20.23    |
| 52515     | 61578000     | 20.31    | 52582     | -            | 13.34    |
| 52515     | 81512206025  | 20.31    | 52582     | -            | 14.24    |
| 52516     | 0004294030   | 20.31    | 52582     | -            | 15.3     |
| 52516     | 0004298130   | 20.31    | 52582     | -            | 17.4     |
| 52516     | 0632566      | 20.31    | 52582     | -            | 19.9     |
| 52516     | 1584599      | 20.31    | 52582     | 8971205304   | 20.23    |
| 52516     | 2515210      | 20.31    | 52583     | -            | 13.34    |
| 52516     | 318159       | 20.31    | 52583     | -            | 14.24    |
| 52516     | 5000442714   | 20.31    | 52583     | -            | 15.3     |
| 52516     | 81512206093  | 20.31    | 52583     | -            | 17.4     |
| 52516     | 8157984      | 20.31    | 52583     | -            | 19.9     |
| 52516     | 9522002220   | 20.31    | 52583     | 8971205404   | 20.23    |
| 52517     | 0109912      | 20.31    | 52584     | -            | 13.34    |
| 52517     | 2519879      | 20.31    | 52584     | -            | 14.24    |
| 52517     | 4522000110   | 20.31    | 52584     | -            | 15.3     |
| 52517     | 88512206003  | 20.31    | 52584     | -            | 17.4     |
| 52518     | 0004297930   | 20.31    | 52584     | -            | 19.9     |
| 52518     | 330301       | 20.31    | 52584     | 8971205504   | 20.23    |
| 52518     | 5000608011   | 20.31    | 52585     | -            | 13.34    |
| 52518     | 60135772     | 20.31    | 52585     | -            | 14.24    |
| 52518     | 81512206075  | 20.31    | 52585     | -            | 15.3     |
| 52518     | 9522000210   | 20.31    | 52585     | -            | 17.4     |
| 52519     | 0004293430   | 20.31    | 52585     | -            | 19.9     |
| 52519     | 4522000120   | 20.31    | 52585     | 8971205164   | 20.23    |
| 52519     | 81512206033  | 20.31    | 52586     | -            | 13.34    |
| 52520     | 0004295930   | 20.31    | 52586     | -            | 14.24    |
| 52520     | 0004297930   | 20.31    | 52586     | -            | 15.3     |
| 52520     | 2516345      | 20.31    | 52586     | -            | 17.4     |
| 52520     | 2516835      | 20.31    | 52586     | -            | 19.9     |
| 52520     | 330302       | 20.31    | 52586     | 8971205264   | 20.23    |
| 52520     | 81512206038  | 20.31    | 52587     | -            | 13.34    |
| 52520     | 81512206040  | 20.31    | 52587     | -            | 14.24    |
| 52520     | 9522000220   | 20.31    | 52587     | -            | 15.3     |
| 52521     | 8JA003831001 | 20.34    | 52587     | -            | 17.4     |
| 52522     | 8JA003832001 | 20.34    | 52587     | -            | 19.9     |
| 52523     | -            | 20.35    | 52587     | 8971205344   | 20.23    |
| 52576     | -            | 13.34    | 52588     | -            | 13.34    |
| 52576     | -            | 14.24    | 52588     | -            | 14.24    |
| 52576     | -            | 15.3     | 52588     | -            | 15.3     |
| 52576     | -            | 17.4     | 52588     | -            | 17.4     |
| 52576     | -            | 19.9     | 52588     | -            | 19.9     |
| 52576     | 8971204924   | 20.23    | 52588     | 8971205464   | 20.23    |
| 52578     | -            | 13.34    | 52590     | 8975500204   | 20.31    |
| 52578     | -            | 14.24    | 52591     | 8JA003832001 | 20.34    |
| 52578     | -            | 15.3     | 52592     | 8JA003834001 | 20.34    |
| 52578     | -            | 17.4     | 52593     | 0000721512   | 20.30    |
| 52578     | -            | 19.9     | 52593     | 0000721812   | 20.30    |
| 52578     | 8971205054   | 20.23    | 52593     | 0000721912   | 20.30    |





| Auger Nr. | O.E.M. Nr.   | Page Nr. | Auger Nr. | O.E.M. Nr.  | Page Nr. |
|-----------|--------------|----------|-----------|-------------|----------|
| 52593     | 0000722212   | 20.30    | 52767     | 0539746030  | 13.11    |
| 52593     | SZ 11159     | 20.30    | 52768     | 0300108010  | 13.24    |
| 52594     | 0000720112   | 20.30    | 52768     | 0300108050  | 13.24    |
| 52594     | SZ 1115      | 20.30    | 52768     | 0308442010  | 13.24    |
| 52595     | 0004290000   | 20.30    | 52769     | 0308475240  | 13.21    |
| 52595     | 0004303026   | 20.30    | 52770     | 0533144020  | 13.22    |
| 52595     | 0004303226   | 20.30    | 52773     | 0580152720  | 13.19    |
| 52595     | 0004304826   | 20.30    | 52774     | 1447005800  | 14.5     |
| 52595     | 0004304926   | 20.30    | 52775     | 1447003300  | 14.5     |
| 52595     | 000482024001 | 20.30    | 52775     | 6501811Y    | 15.8     |
| 52595     | SZ 1114      | 20.30    | 52776     | 1447005000  | 14.5     |
| 52595     | SZ 1124      | 20.30    | 52777     | 1093000500  | 14.27    |
| 52595     | SZ 1130      | 20.30    | 52778     | 1093001200  | 14.27    |
| 52595     | SZ 1161      | 20.30    | 52779     | 1447003800  | 14.5     |
| 52596     | 14994568     | 9.7      | 52780     | 0539726050  | 13.11    |
| 52597     | 01027204     | 9.7      | 52780     | 1447003600  | 14.6     |
| 52598     | 14994876     | 9.7      | 52781     | 3213002301  | 14.15    |
| 52599     | 223905       | 9.7      | 52781     | 3213002302  | 14.15    |
| 52632     | 4325000200   | 20.29    | 52782     | M009279     | 18.9     |
| 52641     | 4771389000   | 16.1     | 52782     | M009279     | 19.4     |
| 52661     | AXL126       | 17.10    | 52784     | 21205194    | 17.5     |
| 52662     | AXL106       | 17.9     | 52785     | 21221224    | 17.5     |
| 52674     | 0004342301   | 20.29    | 52891     | 1643000C    | 15.8     |
| 52674     | 4630131100   | 20.29    | 52900     | 21224673    | 17.17    |
| 52674     | B0481007029  | 20.29    | 52904     | 21205193    | 17.12    |
| 52674     | W4630131100  | 20.29    | 52906     | 21220859    | 17.5     |
| 52675     | 0004342401   | 20.29    | 52907     | 21220727    | 17.17    |
| 52675     | 4630131140   | 20.29    | 52908     | 21202627    | 17.17    |
| 52675     | B0481007010  | 20.29    | 52910     | 1230008400  | 14.17    |
| 52675     | W4630131140  | 20.29    | 52910     | 1230008401  | 14.17    |
| 52676     | 0004340807   | 20.29    | 52910     | 1650000S    | 15.8     |
| 52676     | 9343000010   | 20.29    | 52910     | 21016666    | 17.13    |
| 52676     | B0481019002  | 20.29    | 52910     | 501787      | 18.4     |
| 52676     | W9343000030  | 20.29    | 52911     | 21200920    | 17.15    |
| 52703     | 4771388000   | 16.1     | 52911     | 21200921    | 17.15    |
| 52704     | 3268003400   | 14.10    | 52912     | 15221568    | 17.15    |
| 52708     | 9735000000   | 20.28    | 52912     | 21221567    | 17.15    |
| 52715     | 0980106090   | 13.14    | 52913     | AXL105      | 17.19    |
| 52716     | AXL112       | 17.7     | 52914     | AXL104      | 17.19    |
| 52717     | AXL111       | 17.6     | 52915     | AXL117      | 17.10    |
| 52750     | 028158BHC    | 9.8      | 52916     | AXL125      | 17.8     |
| 52751     | 3434360200   | 14.15    | 52917     | ARJB0006701 | 19.8     |
| 52752     | 3317000500   | 14.14    | 52918     | AJA0558001  | 19.6     |
| 52758     | 0339733070   | 13.10    | 52919     | AJA0507001  | 19.6     |
| 52759     | 0339733060   | 13.10    | 52920     | AJB0119001  | 19.7     |
| 52760     | 0539726030   | 13.10    | 52920     | M002874     | 18.9     |
| 52760     | 0539727010   | 13.10    | 52920     | M002874     | 19.7     |
| 52760     | 0539736050   | 13.10    | 52921     | -           | 18.4     |
| 52760     | 1447003700   | 14.6     | 52921     | 1652010R    | 15.7     |
| 52761     | 0539734170   | 13.10    | 52921     | 21020039    | 17.12    |
| 52762     | 0539735010   | 13.11    | 52921     | M002866     | 18.10    |
| 52762     | 0539735030   | 13.11    | 52921     | M002866     | 19.6     |
| 52763     | 0539746130   | 13.11    | 52995     | 1230006300  | 14.4     |
| 52764     | 0539735020   | 13.11    | 52995     | 1230013000  | 14.4     |
| 52764     | 0539745140   | 13.11    | 53031     | 9900000081  | 13.31    |
| 52764     | 0539746090   | 13.11    | 53032     | 9900000106  | 13.31    |
| 52764     | 8900020184   | 16.2     | 53033     | 9900000083  | 13.31    |
| 52765     | 0539726020   | 13.11    | 53035     | 1230006000  | 14.4     |
| 52765     | 8241024267   | 16.2     | 53035     | 1230013100  | 14.4     |
| 52766     | 0539758030   | 13.11    | 53036     | 1230004800  | 14.4     |



| Auger Nr. | O.E.M. Nr.   | Page Nr. | Auger Nr. | O.E.M. Nr.  | Page Nr. |
|-----------|--------------|----------|-----------|-------------|----------|
| 53037     | 3341104819   | 14.3     | 53516     | 0339744100  | 13.12    |
| 53039     | 21205204     | 17.12    | 53517     | 0337007620  | 13.44    |
| 53040     | A2310521213  | 17.14    | 53518     | 0337007600  | 13.44    |
| 53041     | AXL140       | 17.8     | 53520     | 0908466020  | 13.18    |
| 53045     | -            | 20.40    | 53521     | 0980106190  | 13.31    |
| 53046     | -            | 20.40    | 53522     | 0585700040  | 13.6     |
| 53047     | -            | 20.40    | 53523     | 0585700120  | 13.6     |
| 53048     | -            | 20.40    | 53524     | 0980100431  | 13.15    |
| 53049     | -            | 20.40    | 53525     | 0908446390  | 13.19    |
| 53059     | 0301004150   | 13.46    | 53526     | 0980106280  | 13.5     |
| 53059     | 8241999293   | 16.7     | 53527     | 0980106290  | 13.5     |
| 53062     | 3005003703   | 14.21    | 53528     | 0980102470  | 13.20    |
| 53064     | 015262210351 | 16.4     | 53529     | 090102450   | 13.20    |
| 53065     | 015262210151 | 16.4     | 53530     | 9900000101  | 13.32    |
| 53066     | AXL124       | 17.7     | 53531     | 9900000109  | 13.32    |
| 53067     | AXL31        | 17.6     | 53532     | 9900000102  | 13.32    |
| 53113     | SK1259       | 8.1      | 53533     | 9900000100  | 13.32    |
| 53114     | SK2105-25    | 8.1      | 53534     | 9900000108  | 13.32    |
| 53156     | 21209705     | 17.15    | 53535     | 9900000103  | 13.32    |
| 53156     | 21209706     | 17.15    | 53536     | 9900000105  | 13.33    |
| 53157     | 786123       | 18.5     | 53537     | 0585700090  | 13.6     |
| 53158     | 500363       | 18.4     | 53538     | 0334105050S | 13.6     |
| 53159     | 503087       | 18.4     | 53539     | 0980102440  | 13.20    |
| 53160     | 534601       | 18.2     | 53540     | 0301099690S | 13.33    |
| 53161     | -            | 18.2     | 53540     | 0301099710S | 13.33    |
| 53162     | AJA0753002   | 19.6     | 53541     | 0203160100S | 13.8     |
| 53163     | AJA0753001   | 19.6     | 53541     | 0511396050S | 13.8     |
| 53164     | AEJA0442001S | 19.4     | 53542     | 0203160500S | 13.5     |
| 53165     | M010676      | 15.5     | 53542     | 0203166500S | 13.5     |
| 53165     | M010676      | 18.9     | 53543     | 0980102460  | 13.20    |
| 53165     | M010676      | 19.3     | 53544     | 0980106770  | 13.5     |
| 53167     | ARJA0199703  | 19.5     | 53545     | 0585700150  | 13.5     |
| 53171     | -            | 14.21    | 53546     | 0585700180  | 13.5     |
| 53175     | ROE53386     | 9.4      | 53547     | 0301096620S | 13.33    |
| 53176     | R53206       | 9.4      | 53547     | 0301096630S | 13.33    |
| 53177     | R53207       | 9.4      | 53548     | 0301098630S | 13.33    |
| 53178     | R53208       | 9.4      | 53548     | 0301098640S | 13.33    |
| 53179     | R53209       | 9.4      | 53549     | 0317716280S | 13.6     |
| 53180     | ROE53376     | 9.4      | 53550     | 0317716290S | 13.6     |
| 53181     | R53362       | 9.5      | 53551     | 0980106400  | 13.33    |
| 53182     | -            | 9.5      | 53552     | 0980106410  | 13.33    |
| 53189     | 0308446050   | 13.21    | 53553     | 0585700030  | 13.6     |
| 53203     | 0980106091   | 13.14    | 53555     | 4177302800  | 14.2     |
| 53204     | 100114(S)    | 19.2     | 53556     | 4230017201  | 14.18    |
| 53205     | 100113(S)    | 19.2     | 53557     | 1265001900  | 14.16    |
| 53210     | 21023758     | 17.6     | 53558     | 1447006000  | 14.5     |
| 53210     | -            | 19.3     | 53559     | 1177200200  | 14.1     |
| 53299     | 6401000J     | 15.1     | 53560     | 1177100102  | 14.1     |
| 53506     | 0339734100   | 13.12    | 53562     | 3213002301S | 14.15    |
| 53506     | 0339734110   | 13.12    | 53562     | 3213002302S | 14.15    |
| 53506     | 8241129654   | 16.2     | 53563     | 3268000801  | 14.12    |
| 53507     | 0308466150   | 13.21    | 53564     | 3434364300  | 14.3     |
| 53508     | 0311301340   | 13.3     | 53565     | 3434364400  | 14.3     |
| 53509     | 0301091580   | 13.27    | 53566     | 3268003300  | 14.12    |
| 53510     | 0301091590   | 13.27    | 53567     | 3268003700  | 14.11    |
| 53511     | 0308446300   | 13.22    | 53568     | 3268003200  | 14.12    |
| 53512     | 0316724010   | 13.23    | 53569     | 3434361900  | 14.7     |
| 53513     | 0339733080   | 13.12    | 53570     | 3434365200  | 14.8     |
| 53514     | 0339733090   | 13.12    | 53571     | 3434361400  | 14.9     |
| 53515     | 0316723090   | 13.23    | 53572     | 3434361300  | 14.9     |



| Auger Nr. | O.E.M. Nr.  | Page Nr. | Auger Nr. | O.E.M. Nr. | Page Nr. |
|-----------|-------------|----------|-----------|------------|----------|
| 53573     | 3434361100  | 14.10    | 53776     | -          | 17.13    |
| 53574     | 3434361000  | 14.10    | 53777     | -          | 17.12    |
| 53575     | 3434363400  | 14.10    | 53778     | 21006563   | 17.11    |
| 53576     | 3434364200  | 14.8     | 53779     | 21023389   | 17.5     |
| 53577     | 3434360800  | 14.14    | 53779     | 503320     | 18.2     |
| 53578     | 3434361500  | 14.14    | 53781     | 21223112   | 17.17    |
| 53579     | 3434364000  | 14.8     | 53783     | -          | 17.13    |
| 53580     | 3268003500  | 14.10    | 53784     | -          | 17.12    |
| 53581     | 3434361200  | 14.14    | 53785     | 90508004   | 17.19    |
| 53582     | 3434363500  | 14.14    | 53786     | 21223742   | 17.2     |
| 53583     | -           | 14.15    | 53787     | 21227205   | 17.2     |
| 53584     | -           | 14.15    | 53788     | 21022348   | 17.5     |
| 53585     | 3005017700  | 14.21    | 53789     | AXL123     | 17.7     |
| 53586     | 3005013500  | 14.21    | 53790     | AXLM4      | 17.8     |
| 53587     | 3005013900  | 14.21    | 53791     | AXLLM1     | 17.8     |
| 53588     | 3005014900  | 14.22    | 53792     | AXL101     | 17.18    |
| 53589     | 3005015900  | 14.22    | 53793     | AXL102     | 17.18    |
| 53590     | 3005005300  | 14.22    | 53794     | AXL103     | 17.18    |
| 53591     | 3005004500  | 14.22    | 53795     | AXL114     | 17.18    |
| 53592     | 3005012500  | 14.22    | 53796     | -          | 17.6     |
| 53593     | 3005016100  | 14.22    | 53797     | AXL6       | 17.9     |
| 53594     | 3005017100  | 14.23    | 53798     | 15205204   | 17.9     |
| 53595     | 3050100800  | 14.3     | 53799     | AXL7       | 17.11    |
| 53596     | 3005018300  | 14.23    | 53800     | AXL14      | 17.10    |
| 53597     | 3005005700  | 14.23    | 53801     | -          | 17.10    |
| 53598     | 3005007900  | 14.23    | 53802     | 15226632   | 17.9     |
| 53599     | 3005020901  | 14.23    | 53803     | 15226262   | 17.9     |
| 53685     | 1395100500  | 14.16    | 53804     | 21222609S  | 17.3     |
| 53745     | 6115000X    | 15.1     | 53805     | 21223742S  | 17.3     |
| 53746     | 6127000M    | 15.1     | 53806     | 21227205S  | 17.3     |
| 53747     | 2210000Z    | 15.1     | 53807     | 21221224S  | 17.11    |
| 53748     | 6024000P    | 15.10    | 53808     | -          | 17.7     |
| 53748     | 6503954M    | 15.10    | 53809     | -          | 17.7     |
| 53749     | 6502801E    | 15.10    | 53810     | -          | 17.10    |
| 53750     | 6502802F    | 15.10    | 53811     | -          | 17.9     |
| 53751     | 6502809R    | 15.9     | 53812     | -          | 17.10    |
| 53752     | 6502382B    | 15.7     | 53813     | -          | 17.11    |
| 53753     | 6502103X(S) | 15.4     | 53814     | 500808/9   | 18.5     |
| 53754     | 6503723T(S) | 15.4     | 53815     | 501875/6   | 18.5     |
| 53755     | -           | 15.2     | 53816     | 501574     | 18.4     |
| 53756     | 6503338F    | 15.5     | 53817     | 500356     | 18.4     |
| 53757     | 6503338F(S) | 15.5     | 53818     | 506498     | 18.2     |
| 53758     | 6502102W    | 15.5     | 53819     | 502765     | 18.5     |
| 53759     | 6502102W(S) | 15.5     | 53820     | 786228     | 18.2     |
| 53760     | 6504775W    | 15.6     | 53821     | -          | 18.2     |
| 53761     | 6504775W(S) | 15.6     | 53822     | -          | 18.3     |
| 53762     | -           | 15.4     | 53823     | -          | 18.3     |
| 53763     | -           | 15.6     | 53824     | -          | 18.3     |
| 53764     | 6502105Z    | 15.2     | 53825     | 08307075   | 18.7     |
| 53765     | 6502105Z(S) | 15.2     | 53826     | 02001004   | 18.8     |
| 53766     | -           | 15.2     | 53827     | 08709045   | 18.7     |
| 53767     | 6502101T    | 15.6     | 53828     | 02001001   | 18.8     |
| 53768     | 2211015T    | 15.2     | 53829     | 08804062   | 18.7     |
| 53769     | -           | 15.2     | 53830     | 08804086   | 18.7     |
| 53770     | -           | 15.2     | 53831     | 06311046   | 18.7     |
| 53771     | -           | 15.6     | 53832     | 05703006   | 18.7     |
| 53772     | -           | 15.6     | 53833     | 08803055   | 18.8     |
| 53773     | -           | 15.7     | 53834     | 08612004   | 18.8     |
| 53774     | -           | 15.7     | 53835     | 08206009   | 18.8     |
| 53775     | 21205193S   | 17.12    | 53836     | -          | 18.6     |



| Auger Nr. | O.E.M. Nr.   | Page Nr. | Auger Nr. | O.E.M. Nr.  | Page Nr. |
|-----------|--------------|----------|-----------|-------------|----------|
| 53837     | 08910060     | 18.6     | 53946     | 0321225310  | 13.42    |
| 53838     | 08902022     | 18.6     | 53947     | 0203159800  | 13.2     |
| 53839     | -            | 18.6     | 53965     | 0311323010  | 13.3     |
| 53840     | -            | 18.6     | 53966     | 0537007430  | 13.45    |
| 53841     | M050147      | 15.5     | 53967     | 03010052200 | 13.46    |
| 53841     | M050147      | 18.9     | 53975     | 0321226140  | 13.42    |
| 53841     | M050147      | 19.3     | 53996     | 0337007450  | 13.45    |
| 53842     | AJB0001001   | 19.8     | 53996     | 8241999299  | 16.7     |
| 53842     | AJB0002001   | 19.8     | 53997     | 3213000406  | 14.15    |
| 53843     | AJB0407001   | 19.12    | 53998     | 0301005210  | 13.46    |
| 53844     | AJA0577001   | 19.12    | 53999     | 0301006120  | 13.46    |
| 53845     | AJA0492001   | 19.12    | 54000     | 0337007440  | 13.45    |
| 53846     | AJA0492001 S | 19.12    | 54001     | 0339735050  | 13.12    |
| 53847     | M008892      | 18.12    | 54002     | 0539734160  | 13.12    |
| 53847     | M008892      | 19.12    | 54003     | 4011003901  | 14.28    |
| 53848     | AJA0504002   | 19.6     | 54004     | 2011004001  | 14.28    |
| 53848     | M007371      | 18.10    | 54004     | 6502188Z    | 15.10    |
| 53849     | 7000107D     | 15.8     | 54005     | 1345000801  | 14.29    |
| 53849     | AJA0487001   | 19.7     | 54021     | UJA0324001  | 19.1     |
| 53849     | M007150      | 18.9     | 54022     | UJA0034001  | 19.1     |
| 53851     | AEJB0003002  | 19.4     | 54023     | 21206000    | 17.2     |
| 53852     | AEJB0003001  | 19.4     | 54024     | 21202094    | 17.2     |
| 53853     | ARJA0199702  | 19.4     | 54025     | 0334105030  | 13.4     |
| 53854     | -            | 19.5     | 54026     | 0334105050  | 13.4     |
| 53855     | -            | 19.5     | 54027     | 0317716250  | 13.4     |
| 53856     | M008949      | 19.2     | 54028     | 0334105040  | 13.4     |
| 53857     | -            | 19.5     | 54029     | 6113300A    | 15.1     |
| 53858     | -            | 19.5     | 54030     | 0317716280  | 13.4     |
| 53863     | 25345        | 9.3      | 54031     | 0317716290  | 13.4     |
| 53864     | 67471        | 9.3      | 54032     | 21015626    | 17.2     |
| 53865     | SK212153     | 8.2      | 54033     | 0334015370  | 13.4     |
| 53866     | MCK1171/N    | 20.12    | 54033     | 4343008088  | 14.2     |
| 53867     | MCK1102/N    | 20.12    | 54034     | 4343104888  | 14.2     |
| 53868     | MCK1253      | 20.12    | 54035     | 4343105300  | 14.2     |
| 53869     | MCK1254      | 20.12    | 54041     | -           | 19.1     |
| 53870     | MCK1139      | 20.13    | 54041     | 0334015230  | 13.4     |
| 53871     | MCK1238      | 20.13    | 54042     | 0334015080  | 13.4     |
| 53872     | MCK1171      | 20.13    | 54042     | 0334015080  | 13.8     |
| 53873     | MCK1192      | 20.13    | 54042     | 0334015100  | 13.4     |
| 53874     | 5001837006   | 20.13    | 54042     | 0334015100  | 13.8     |
| 53875     | II368470064  | 20.7     | 54042     | 0334015200  | 13.4     |
| 53876     | K000696      | 20.7     | 54042     | 0334015200  | 13.8     |
| 53877     | K000687      | 20.7     | 54042     | 0334015270  | 13.4     |
| 53878     | II304130065  | 20.7     | 54042     | 0334015270  | 13.8     |
| 53879     | II39769F0063 | 20.7     | 54043     | 6502176T    | 15.1     |
| 53880     | K000945      | 20.7     | 54044     | 21222234    | 17.2     |
| 53881     | K001300      | 20.8     | 54044     | 6504212Z    | 15.1     |
| 53882     | II358510062  | 20.8     | 54045     | 21223744    | 17.2     |
| 53883     | 93161192     | 20.8     | 54046     | 21222233    | 17.2     |
| 53884     | II197140062  | 20.8     | 54048     | 2033000M    | 15.1     |
| 53885     | II179320062  | 20.8     | 54049     | -           | 14.7     |
| 53886     | II197330062  | 20.8     | 54049     | 6114000K    | 15.1     |
| 53887     | K001274      | 20.9     | 54050     | -           | 15.1     |
| 53888     | K000375      | 20.9     | 54050     | 21206001    | 17.2     |
| 53889     | 42541412     | 20.9     | 54051     | -           | 15.1     |
| 53890     | II328090062  | 20.9     | 54051     | 0252208126  | 13.4     |
| 53890     | II339680062  | 20.9     | 54051     | 0252208126  | 13.8     |
| 53890     | II369100062  | 20.9     | 54051     | 0252208182  | 13.4     |
| 53929     | -            | 18.3     | 54051     | 0252208182  | 13.8     |
| 53930     | -            | 18.3     | 54051     | 0326015010  | 13.4     |



| Auger Nr. | O.E.M. Nr.   | Page Nr. | Auger Nr. | O.E.M. Nr.   | Page Nr. |
|-----------|--------------|----------|-----------|--------------|----------|
| 54051     | 0326015010   | 13.8     | 54172     | 5001866400   | 20.14    |
| 54052     | 21016115     | 17.2     | 54173     | 5001858718   | 20.14    |
| 54053     | -            | 19.1     | 54173     | 5001860792   | 20.14    |
| 54053     | 4247402280   | 14.2     | 54174     | 5001866398   | 20.14    |
| 54053     | 99527003     | 17.2     | 54175     | 5001822994   | 20.14    |
| 54056     | 0252209126   | 13.4     | 54178     | K000944      | 20.10    |
| 54058     | 4202100680   | 14.2     | 54277     | 1011008000   | 14.28    |
| 54059     | 0252074604   | 13.4     | 54278     | 1011008100   | 14.28    |
| 54068     | K000029      | 20.9     | 54279     | 1011007001   | 14.29    |
| 54069     | K000472      | 20.9     | 54280     | 1011007101   | 14.29    |
| 54070     | K001925      | 20.10    | 54281     | 4177002000   | 14.2     |
| 54071     | K001532      | 20.10    | 54282     | 1230003200   | 14.18    |
| 54072     | K001301      | 20.10    | 54283     | 3304008600   | 14.27    |
| 54073     | SK2006       | 8.1      | 54284     | 4304009300   | 14.27    |
| 54074     | SK2007       | 8.1      | 54285     | 4177302600   | 14.2     |
| 54075     | SK 2121-69   | 8.1      | 54395     | 010242178931 | 16.6     |
| 54076     | SK 2121-15   | 8.3      | 54405     | 21205193S1   | 17.12    |
| 54077     | SK2421-78    | 8.1      | 54406     | 21224762     | 17.19    |
| 54078     | SK2421-55    | 8.3      | 54407     | 21226003     | 17.19    |
| 54089     | SK3121-61    | 8.2      | 54408     | 21226038     | 17.17    |
| 54092     | SK3121-063   | 8.3      | 54409     | 21226119     | 17.17    |
| 54097     | SK3121-58    | 8.2      | 54410     | 21226090     | 17.19    |
| 54098     | SKE001370220 | 8.2      | 54411     | M002564      | 18.12    |
| 54099     | SK2521-76    | 8.2      | 54412     | M007916      | 18.12    |
| 54100     | SK3353-009   | 8.4      | 54413     | M010552      | 18.9     |
| 54101     | SK1513       | 8.4      | 54414     | CR2672201    | 19.12    |
| 54102     | SK2421-50    | 8.4      | 54419     | 502461S      | 18.5     |
| 54103     | SK3121-071   | 8.4      | 54419     | 502462S      | 18.5     |
| 54104     | SK3221-01    | 8.4      | 54435     | 0203160100S1 | 13.8     |
| 54105     | SK3106-003   | 8.3      | 54435     | 0511396050S1 | 13.8     |
| 54107     | SK870-1      | 8.5      | 54522     | II39769F0062 | 20.11    |
| 54126     | SK310520     | 8.5      | 54523     | K001929      | 20.11    |
| 54127     | ROE53367     | 9.5      | 54524     | K001928      | 20.11    |
| 54128     | ROE53051     | 9.5      | 54525     | K003902      | 20.11    |
| 54129     | ROE53004     | 9.5      | 54526     | K004100      | 20.11    |
| 54130     | ROE53244     | 9.5      | 54527     | 12999199VT   | 20.20    |
| 54131     | ROE55008     | 9.6      | 54528     | 12999729VT   | 20.20    |
| 54132     | ROE55005     | 9.6      | 54529     | MCK1103      | 20.15    |
| 54133     | ROE52011     | 9.6      | 54530     | MCK1134      | 20.15    |
| 54134     | ROE52009     | 9.6      | 54531     | SJ4077       | 20.15    |
| 54135     | ROE52002     | 9.6      | 54532     | SJ4052       | 20.15    |
| 54138     | ROE67855     | 9.1      | 54533     | SP8597       | 20.15    |
| 54139     | ROE67859     | 9.1      | 54534     | SP9670       | 20.15    |
| 54140     | ROE67472     | 9.1      | 54535     | SP8567       | 20.16    |
| 54141     | ROE25475     | 9.1      | 54536     | SP9669       | 20.16    |
| 54142     | ROE67056     | 9.1      | 54537     | SP8564       | 20.16    |
| 54143     | ROE70172     | 9.1      | 54538     | SJ1034       | 20.16    |
| 54144     | ROE70432     | 9.2      | 54539     | SJ1030       | 20.16    |
| 54145     | ROE25476     | 9.2      | 54540     | SP8565       | 20.16    |
| 54146     | ROE70043     | 9.2      | 54541     | SJ1022       | 20.17    |
| 54147     | ROE70625     | 9.2      | 54542     | SP8566       | 20.17    |
| 54148     | ROE70089     | 9.2      | 54543     | SJ1035       | 20.17    |
| 54149     | ROE59277     | 9.2      | 54544     | SP8902       | 20.17    |
| 54167     | 0980106320   | 13.38    | 54545     | SJ1037       | 20.17    |
| 54167     | K010603      | 20.10    | 54546     | SJ1213       | 20.17    |
| 54168     | 0980102630   | 13.38    | 54547     | SJ4078       | 20.18    |
| 54168     | K010604      | 20.10    | 54548     | SJ4076       | 20.18    |
| 54169     | 5001866989   | 20.13    | 54549     | MCK1213      | 20.18    |
| 54170     | MCK1086      | 20.14    | 54549     | SJ4011       | 20.18    |
| 54171     | MCK1243      | 20.14    | 54550     | MCK1102      | 20.18    |



| Auger Nr. | O.E.M. Nr. | Page Nr. | Auger Nr. | O.E.M. Nr.  | Page Nr. |
|-----------|------------|----------|-----------|-------------|----------|
| 54551     | MCK1116    | 20.18    | 54703     | SZ 1208     | 20.30    |
| 54552     | SJ4021     | 20.18    | 54704     | 0004300126  | 20.30    |
| 54553     | MCK1135    | 20.19    | 54704     | 0004300226  | 20.30    |
| 54554     | MCK1299    | 20.19    | 54704     | 0004303426  | 20.30    |
| 54555     | SJ4053     | 20.19    | 54704     | 0482006009  | 20.30    |
| 54556     | MCK1118    | 20.19    | 54704     | 4214110200  | 20.30    |
| 54557     | 5000821966 | 20.19    | 54704     | 4214110230  | 20.30    |
| 54558     | 12999677VT | 20.20    | 54704     | 4214110860  | 20.30    |
| 54559     | 12999738VT | 20.20    | 54704     | SZ 1200     | 20.30    |
| 54559     | 3434382701 | 14.23    | 54705     | 0000720112  | 20.30    |
| 54560     | 12999552VT | 20.21    | 54705     | 81157009006 | 20.30    |
| 54561     | 12999704VT | 20.21    | 54705     | 81157015001 | 20.30    |
| 54562     | 12999746VT | 20.21    | 54705     | 81157016079 | 20.30    |
| 54563     | 12999076VT | 20.21    | 54705     | 81157016091 | 20.30    |
| 54564     | 12999197VT | 20.21    | 54705     | 81157016099 | 20.30    |
| 54565     | 12999580VT | 20.21    | 54705     | 81157016112 | 20.30    |
| 54566     | 12999699VT | 20.22    | 54705     | 81157016116 | 20.30    |
| 54567     | 12999543VT | 20.22    | 54705     | 81157016119 | 20.30    |
| 54568     | 12999551VT | 20.22    | 54706     | 0001400359  | 20.30    |
| 54569     | 12999678VT | 20.22    | 54706     | 0001400459  | 20.30    |
| 54570     | 12999141VT | 20.22    | 54706     | 0001400759  | 20.30    |
| 54644     | 4230017000 | 14.28    | 54706     | 0001400859  | 20.30    |
| 54675     | -          | 15.4     | 54706     | SZ 1200     | 20.30    |
| 54676     | M046565    | 18.11    | 54707     | 3550700475  | 20.30    |
| 54676     | M046573    | 18.11    | 54707     | 4470700175  | 20.30    |
| 54677     | M002904    | 18.11    | 54708     | -           | 20.35    |
| 54677     | M002912    | 18.11    | 54709     | -           | 20.35    |
| 54678     | M009309    | 18.11    | 54710     | -           | 20.35    |
| 54679     | M051275    | 18.11    | 54711     | -           | 20.35    |
| 54680     | M009260    | 18.11    | 54712     | -           | 20.35    |
| 54681     | 21224663   | 17.2     | 54713     | -           | 20.35    |
| 54682     | ROE71124   | 9.3      | 54714     | -           | 20.35    |
| 54683     | ROE71125   | 9.3      | 54715     | -           | 20.34    |
| 54684     | K001915    | 20.11    | 54716     | -           | 20.34    |
| 54685     | K000935    | 20.12    | 54717     | 4460083902  | 20.38    |
| 54686     | K000132    | 20.12    | 54718     | 1505282     | 20.38    |
| 54687     | 9522010040 | 20.31    | 54718     | 6500664     | 20.38    |
| 54688     | 9522010020 | 20.31    | 54718     | 4460084142  | 20.38    |
| 54689     | 9522010030 | 20.31    | 54719     | -           | 20.38    |
| 54690     | 9522010010 | 20.31    | 54720     | -           | 20.38    |
| 54691     | 9522010080 | 20.31    | 54721     | -           | 20.34    |
| 54692     | 9522010070 | 20.31    | 54722     | -           | 20.34    |
| 54693     | -          | 20.39    | 54723     | -           | 20.34    |
| 54694     | -          | 20.39    | 54724     | -           | 20.34    |
| 54695     | -          | 20.39    | 54725     | 1506023     | 20.38    |
| 54696     | -          | 20.39    | 54725     | 6500657     | 20.38    |
| 54697     | -          | 20.39    | 54725     | 11058261    | 20.38    |
| 54698     | -          | 20.39    | 54725     | 4460083802  | 20.38    |
| 54699     | -          | 20.39    | 54726     | 1506027     | 20.38    |
| 54700     | -          | 20.39    | 54726     | 6500662     | 20.38    |
| 54701     | -          | 20.39    | 54726     | 4460084042  | 20.38    |
| 54702     | 0004300126 | 20.30    | 54727     | -           | 20.38    |
| 54702     | 4214110860 | 20.30    | 54728     | -           | 20.38    |
| 54702     | 4214113010 | 20.30    | 54729     | -           | 20.34    |
| 54703     | 0004300626 | 20.30    | 54730     | -           | 20.34    |
| 54703     | 0004300626 | 20.30    | 54731     | -           | 20.34    |
| 54703     | 0004301026 | 20.30    | 54732     | -           | 20.34    |
| 54703     | 0482006013 | 20.30    | 54733     | -           | 20.34    |
| 54703     | 4214110250 | 20.30    | 54734     | -           | 20.34    |
| 54703     | 4214113060 | 20.30    | 54735     | -           | 20.38    |



| Auger Nr. | O.E.M. Nr. | Page Nr. | Auger Nr. | O.E.M. Nr.   | Page Nr. |
|-----------|------------|----------|-----------|--------------|----------|
| 54736     | -          | 20.38    | 54831     | M002693      | 18.10    |
| 54737     | -          | 20.38    | 54831     | M002693      | 19.3     |
| 54738     | -          | 20.38    | 54833     | 1151001300   | 14.7     |
| 54739     | -          | 20.38    | 54834     | 1151000800   | 14.7     |
| 54740     | -          | 20.38    | 54835     | 0328154140   | 13.4     |
| 54741     | -          | 20.38    | 54836     | 0328154180   | 13.4     |
| 54742     | -          | 20.38    | 54837     | 0316435010   | 13.4     |
| 54743     | -          | 20.36    | 54838     | 0316435020   | 13.4     |
| 54744     | -          | 20.36    | 54869     | -            | 14.7     |
| 54745     | -          | 20.36    | 54870     | 4373001000   | 14.7     |
| 54746     | -          | 20.36    | 54872     | 1229K4795    | 17.6     |
| 54747     | -          | 20.37    | 54880     | 21016330     | 17.18    |
| 54748     | -          | 20.37    | 54881     | 21020663     | 17.18    |
| 54749     | -          | 20.37    | 54882     | 21220158     | 17.18    |
| 54750     | -          | 20.37    | 54883     | 21200321     | 17.18    |
| 54751     | -          | 20.33    | 54909     | -            | 19.7     |
| 54752     | -          | 20.33    | 54915     | 21210215     | 17.5     |
| 54753     | -          | 20.33    | 54916     | 1646000J     | 15.7     |
| 54754     | -          | 20.33    | 54916     | 21006614     | 17.6     |
| 54755     | -          | 20.33    | 54916     | 500372       | 18.3     |
| 54756     | -          | 20.33    | 54916     | M003001      | 18.10    |
| 54757     | -          | 20.33    | 54916     | M003001      | 19.3     |
| 54758     | -          | 20.33    | 54917     | 0318120080   | 13.4     |
| 54759     | -          | 20.33    | 54919     | 0537700020   | 13.26    |
| 54760     | -          | 20.33    | 54920     | 0518913190   | 13.4     |
| 54761     | -          | 20.33    | 55155     | SK260404     | 8.5      |
| 54762     | -          | 20.33    | 55156     | SKE001009800 | 8.5      |
| 54763     | -          | 20.33    | 55157     | SKE001440000 | 8.5      |
| 54764     | -          | 20.33    | 55160     | SKE001940001 | 8.2      |
| 54765     | -          | 20.33    | 55166     | SKE001007020 | 8.3      |
| 54766     | -          | 20.33    | 55167     | SK262102     | 8.3      |
| 54767     | -          | 20.31    | 55176     | 5001831176   | 20.19    |
| 54768     | -          | 20.31    | 55177     | ROE53019     | 9.3      |
| 54769     | -          | 20.31    | 55178     | ROE25477     | 9.3      |
| 54770     | -          | 20.28    | 55179     | SJ1033       | 20.20    |
| 54771     | -          | 20.28    | 55180     | SJ1018       | 20.20    |
| 54772     | -          | 20.28    | 55181     | 4177302800S  | 14.3     |
| 54773     | -          | 20.28    | 55182     | 4177302600S  | 14.3     |
| 54774     | -          | 20.28    | 55208     | 64225252     | 17.16    |
| 54775     | -          | 20.28    | 55222     | ST1036       | 17.16    |
| 54776     | -          | 20.28    | 55223     | SP7984       | 17.16    |
| 54777     | -          | 20.28    | 55225     | 3268005100   | 14.6     |
| 54778     | -          | 20.28    | 55226     | 3268005000   | 14.7     |
| 54779     | -          | 20.28    | 55275     | 4331502900   | 14.2     |
| 54780     | -          | 20.28    | 55276     | 4343205510   | 14.2     |
| 54781     | -          | 20.28    | 55286     | -            | 20.22    |
| 54782     | -          | 20.29    | 55294     | -            | 20.2     |
| 54789     | 0334015220 | 13.8     | 55295     | -            | 20.1     |
| 54794     | 1051100800 | 14.2     | 55296     | -            | 20.1     |
| 54795     | 1214000606 | 14.7     | 55297     | -            | 20.1     |
| 54796     | 4343001388 | 14.2     | 55298     | -            | 20.1     |
| 54804     | 21210819   | 17.19    | 55299     | -            | 20.1     |
| 54805     | 21220759   | 17.19    | 55300     | -            | 20.1     |
| 54806     | 21205571   | 17.19    | 55301     | -            | 20.1     |
| 54807     | 21020818   | 17.19    | 55302     | -            | 20.2     |
| 54808     | 21220726   | 17.19    | 55303     | -            | 20.2     |
| 54809     | 21221061   | 17.19    | 55304     | -            | 20.2     |
| 54831     | -          | 17.6     | 55305     | -            | 20.1     |
| 54831     | 6504774T   | 15.7     | 55306     | -            | 20.1     |
| 54831     | AJA0506001 | 19.3     | 55307     | -            | 20.1     |



| Auger Nr. | O.E.M. Nr. | Page Nr. | Auger Nr. | O.E.M. Nr.   | Page Nr. |
|-----------|------------|----------|-----------|--------------|----------|
| 55308     | -          | 20.1     | 55368     | -            | 20.5     |
| 55309     | -          | 20.1     | 55369     | -            | 20.5     |
| 55310     | -          | 20.1     | 55370     | -            | 20.5     |
| 55311     | -          | 20.1     | 55371     | -            | 20.5     |
| 55312     | -          | 20.1     | 55372     | -            | 20.5     |
| 55313     | -          | 20.1     | 55373     | -            | 20.6     |
| 55314     | -          | 20.1     | 55374     | -            | 20.6     |
| 55315     | -          | 20.1     | 55375     | -            | 20.6     |
| 55316     | -          | 20.1     | 55376     | -            | 20.6     |
| 55317     | -          | 20.2     | 55377     | -            | 20.6     |
| 55318     | -          | 20.2     | 55378     | -            | 20.6     |
| 55319     | -          | 20.2     | 55379     | -            | 20.6     |
| 55320     | -          | 20.2     | 55380     | -            | 20.6     |
| 55321     | -          | 20.2     | 55381     | -            | 20.6     |
| 55322     | -          | 20.2     | 55382     | -            | 20.6     |
| 55323     | -          | 20.2     | 55383     | -            | 20.6     |
| 55324     | -          | 20.2     | 55384     | -            | 20.2     |
| 55325     | -          | 20.2     | 55385     | -            | 20.28    |
| 55326     | -          | 20.2     | 55386     | -            | 20.28    |
| 55327     | -          | 20.2     | 55387     | -            | 20.32    |
| 55328     | -          | 20.2     | 55388     | -            | 20.32    |
| 55329     | -          | 20.2     | 55389     | -            | 20.32    |
| 55330     | -          | 20.2     | 55390     | -            | 20.32    |
| 55331     | -          | 20.3     | 55391     | -            | 20.32    |
| 55332     | -          | 20.3     | 55392     | -            | 20.32    |
| 55333     | -          | 20.3     | 55393     | -            | 20.32    |
| 55334     | -          | 20.3     | 55394     | -            | 20.32    |
| 55335     | -          | 20.3     | 55395     | -            | 20.32    |
| 55336     | -          | 20.3     | 55396     | -            | 20.32    |
| 55337     | -          | 20.3     | 55397     | -            | 20.32    |
| 55338     | -          | 20.3     | 55398     | -            | 20.32    |
| 55339     | -          | 20.3     | 55399     | -            | 20.32    |
| 55340     | -          | 20.3     | 55400     | -            | 20.32    |
| 55341     | -          | 20.3     | 55401     | -            | 20.32    |
| 55342     | -          | 20.3     | 55402     | -            | 20.32    |
| 55343     | -          | 20.3     | 55403     | -            | 20.32    |
| 55344     | -          | 20.4     | 55404     | -            | 20.32    |
| 55345     | -          | 20.4     | 55405     | -            | 20.32    |
| 55346     | -          | 20.3     | 55406     | -            | 20.32    |
| 55347     | -          | 20.4     | 55407     | -            | 20.32    |
| 55348     | -          | 20.4     | 55408     | -            | 20.32    |
| 55349     | -          | 20.4     | 55409     | -            | 20.32    |
| 55350     | -          | 20.4     | 55410     | -            | 20.32    |
| 55351     | -          | 20.4     | 55411     | -            | 20.32    |
| 55352     | -          | 20.4     | 55412     | -            | 20.32    |
| 55353     | -          | 20.4     | 55413     | -            | 20.35    |
| 55354     | -          | 20.4     | 55414     | -            | 20.35    |
| 55355     | -          | 20.4     | 55415     | -            | 20.35    |
| 55356     | -          | 20.4     | 55416     | -            | 20.35    |
| 55357     | -          | 20.4     | 55417     | -            | 20.35    |
| 55358     | -          | 20.4     | 55418     | -            | 20.35    |
| 55359     | -          | 20.5     | 55419     | -            | 20.35    |
| 55360     | -          | 20.5     | 55420     | -            | 20.35    |
| 55361     | -          | 20.5     | 55504     | 0337007600TS | 13.44    |
| 55362     | -          | 20.5     | 55505     | 0301091530   | 13.27    |
| 55363     | -          | 20.5     |           |              |          |
| 55364     | -          | 20.5     |           |              |          |
| 55365     | -          | 20.5     |           |              |          |
| 55366     | -          | 20.5     |           |              |          |
| 55367     | -          | 20.5     |           |              |          |



# 00

## INDEX

**O.E.M. NR.**  
-  
**AUGER NR.**







| Auger Nr.                              | O.E.M. Nr. | Page Nr. | Auger Nr.              | O.E.M. Nr. | Page Nr. |
|--|------------|----------|------------------------|------------|----------|
| <b>JOST</b>                            |            |          | ROE25476               | 54145      | 9.2      |
| SK 2121-15                             | 54076      | 8.3      | ROE25477               | 55178      | 9.3      |
| SK 2121-69                             | 54075      | 8.1      | ROE52002               | 54135      | 9.6      |
| SK1259                                 | 53113      | 8.1      | ROE52009               | 54134      | 9.6      |
| SK1513                                 | 54101      | 8.4      | ROE52011               | 54133      | 9.6      |
| SK2006                                 | 54073      | 8.1      | ROE53004               | 54129      | 9.5      |
| SK2007                                 | 54074      | 8.1      | ROE53019               | 55177      | 9.3      |
| SK2105-25                              | 53114      | 8.1      | ROE53051               | 54128      | 9.5      |
| SK212153                               | 53865      | 8.2      | ROE53244               | 54130      | 9.5      |
| SK2421-50                              | 54102      | 8.4      | ROE53367               | 54127      | 9.5      |
| SK2421-55                              | 54078      | 8.3      | ROE53376               | 53180      | 9.4      |
| SK2421-78                              | 54077      | 8.1      | ROE53386               | 53175      | 9.4      |
| SK2521-76                              | 54099      | 8.2      | ROE55005               | 54132      | 9.6      |
| SK260404                               | 55155      | 8.5      | ROE55008               | 54131      | 9.6      |
| SK262102                               | 55167      | 8.3      | ROE59277               | 54149      | 9.2      |
| SK310520                               | 54126      | 8.5      | ROE67056               | 54142      | 9.1      |
| SK3106-003                             | 54105      | 8.3      | ROE67472               | 54140      | 9.1      |
| SK3121-063                             | 54092      | 8.3      | ROE67855               | 54138      | 9.1      |
| SK3121-071                             | 54103      | 8.4      | ROE67859               | 54139      | 9.1      |
| SK3121-58                              | 54097      | 8.2      | ROE70043               | 54146      | 9.2      |
| SK3121-61                              | 54089      | 8.2      | ROE70089               | 54148      | 9.2      |
| SK3221-01                              | 54104      | 8.4      | ROE70172               | 54143      | 9.1      |
| SK3353-009                             | 54100      | 8.4      | ROE70432               | 54144      | 9.2      |
| SK870-1                                | 54107      | 8.5      | ROE70625               | 54147      | 9.2      |
| SKE001007020                           | 55166      | 8.3      | ROE71124               | 54682      | 9.3      |
| SKE001009800                           | 55156      | 8.5      | ROE71125               | 54683      | 9.3      |
| SKE001370220                           | 54098      | 8.2      | -                      | 53182      | 9.5      |
| SKE001440000                           | 55157      | 8.5      | -                      | 21010      | 9.8      |
| SKE001940001                           | 55160      | 8.2      | -                      | 21012      | 9.8      |
| <b>ROCKINGER / RINGFEDER / SCHMITZ</b> |            |          | -                      | 21014      | 9.9      |
| 01027204                               | 52597      | 9.7      | -                      | 21016      | 9.9      |
| 028158BHC                              | 52750      | 9.8      | -                      | 21018      | 9.9      |
| 050408                                 | 21019      | 9.9      | <b>BERGISCHE AXSEN</b> |            |          |
| 050457                                 | 21900      | 9.10     | 0203159800             | 53947      | 13.2     |
| 050458                                 | 21905      | 9.10     | 0203160100             | 52102      | 13.8     |
| 050460                                 | 21909      | 9.10     | 0203160100S            | 53541      | 13.8     |
| 050461                                 | 21910      | 9.10     | 0203160100S1           | 54435      | 13.8     |
| 050462                                 | 21911      | 9.10     | 0203160500             | 52108      | 13.1     |
| 051007                                 | 21011      | 9.8      | 0203160500S            | 53542      | 13.5     |
| 051009                                 | 21013      | 9.8      | 0203160600             | 52105      | 13.1     |
| 051012                                 | 21015      | 9.9      | 0203166500             | 52108      | 13.1     |
| 051017                                 | 21017      | 9.9      | 0203166500S            | 53542      | 13.5     |
| 14994568                               | 52596      | 9.7      | 0203169000             | 52118      | 13.2     |
| 14994876                               | 52598      | 9.7      | 0203272700             | 21011      | 13.36    |
| 223905                                 | 52599      | 9.7      | 0203272900             | 21017      | 13.37    |
| 25345                                  | 53863      | 9.3      | 0203273100             | 21015      | 13.36    |
| 67471                                  | 53864      | 9.3      | 0203273100             | 21015      | 13.36    |
| 750841                                 | 52108      | 9.8      | 0203273200             | 21013      | 13.36    |
| 82830500000                            | 21017      | 9.9      | 0203273900             | 21019      | 13.37    |
| R53206                                 | 53176      | 9.4      | 0203277000             | 21005      | 13.35    |
| R53207                                 | 53177      | 9.4      | 0203277100             | 21005      | 13.35    |
| R53208                                 | 53178      | 9.4      | 0203277400             | 21007      | 13.35    |
| R53209                                 | 53179      | 9.4      | 0203277500             | 21007      | 13.35    |
| R53362                                 | 53181      | 9.5      | 0203277800             | 21009      | 13.35    |
| ROE25475                               | 54141      | 9.1      | 0203277900             | 21009      | 13.35    |



# INDEX 00

## O.E.M. Nr. - Auger Nr.

| Auger Nr.   | O.E.M. Nr. | Page Nr. | Auger Nr.   | O.E.M. Nr. | Page Nr. |
|-------------|------------|----------|-------------|------------|----------|
| 0203362000  | 21013      | 13.36    | 0311301140  | 52318      | 13.2     |
| 0220041300  | 21904      | 13.38    | 0311301150  | 52316      | 13.2     |
| 0220041500  | 21906      | 13.38    | 0311301340  | 53508      | 13.3     |
| 0220041700  | 21905      | 13.38    | 0311302040  | 52320      | 13.3     |
| 0252074604  | 54059      | 13.4     | 0311302050  | 52315      | 13.2     |
| 0252208126  | 54051      | 13.4     | 0311302060  | 52334      | 13.3     |
| 0252208126  | 54051      | 13.8     | 0311314010  | 52143      | 13.26    |
| 0252208182  | 54051      | 13.4     | 0311314030  | 52144      | 13.26    |
| 0252208182  | 54051      | 13.8     | 0311323010  | 53965      | 13.3     |
| 0252209126  | 54056      | 13.4     | 0311344300  | 52150      | 13.23    |
| 0300108010  | 52768      | 13.24    | 0311396040  | 52116      | 13.8     |
| 0300108030  | 52306      | 13.24    | 0311398060  | 52116      | 13.8     |
| 0300108050  | 52768      | 13.24    | 0312043090  | 52145      | 13.27    |
| 0301004150  | 53059      | 13.46    | 0312043100  | 52146      | 13.27    |
| 0301005210  | 53998      | 13.46    | 0312043120  | 52148      | 13.27    |
| 03010052200 | 53967      | 13.46    | 0312043140  | 52147      | 13.27    |
| 0301006120  | 53999      | 13.46    | 0312063010  | 52145      | 13.27    |
| 0301091530  | 55505      | 13.27    | 031244300S  | 52154      | 13.13    |
| 0301091580  | 53509      | 13.27    | 0316435010  | 54837      | 13.4     |
| 0301091590  | 53510      | 13.27    | 0316435020  | 54838      | 13.4     |
| 0301093330  | 52201      | 13.45    | 0316723020  | 52326      | 13.23    |
| 0301093340  | 52202      | 13.45    | 0316723090  | 53515      | 13.23    |
| 0301096620S | 53547      | 13.33    | 0316724010  | 53512      | 13.23    |
| 0301096630S | 53547      | 13.33    | 0317716250  | 54027      | 13.4     |
| 0301098630S | 53548      | 13.33    | 0317716280  | 54030      | 13.4     |
| 0301098640S | 53548      | 13.33    | 0317716280S | 53549      | 13.6     |
| 0301099690S | 53540      | 13.33    | 0317716290  | 54031      | 13.4     |
| 0301099710S | 53540      | 13.33    | 0317716290S | 53550      | 13.6     |
| 0308442010  | 52768      | 13.24    | 0317723100  | 52324      | 13.20    |
| 0308442020  | 52307      | 13.24    | 0317723101  | 52324      | 13.20    |
| 0308442050  | 52304      | 13.24    | 0318120080  | 54917      | 13.4     |
| 0308446040  | 52327      | 13.21    | 0318190010  | 52169      | 13.7     |
| 0308446050  | 53189      | 13.21    | 0318190020  | 52168      | 13.7     |
| 0308446220  | 52325      | 13.21    | 0318190050  | 52169      | 13.7     |
| 0308446230  | 52321      | 13.20    | 0318190060  | 52168      | 13.7     |
| 0308446300  | 53511      | 13.22    | 0318190061  | 52168      | 13.7     |
| 0308452060  | 52305      | 13.24    | 0318190100  | 52167      | 13.7     |
| 0308452080  | 52308      | 13.24    | 0318802020  | 52142      | 13.12    |
| 0308452210  | 52309      | 13.24    | 0320034020  | 52329      | 13.22    |
| 0308452280  | 52306      | 13.24    | 0320034030  | 52319      | 13.3     |
| 0308455110  | 52330      | 13.21    | 0320034050  | 52317      | 13.2     |
| 0308466150  | 53507      | 13.21    | 0321205010  | 52126      | 13.41    |
| 0308475240  | 52769      | 13.21    | 0321207010  | 52132      | 13.42    |
| 0308834010  | 31006      | 13.39    | 0321222010  | 52128      | 13.41    |
| 0308834020  | 31004      | 13.39    | 0321222040  | 52129      | 13.41    |
| 0308834030  | 31007      | 13.39    | 0321222050  | 52130      | 13.41    |
| 0308834040  | 31005      | 13.39    | 0321223010  | 52131      | 13.41    |
| 0308835010  | 31008      | 13.39    | 0321223020  | 52123      | 13.40    |
| 0308835030  | 31009      | 13.39    | 0321223090  | 52122      | 13.40    |
| 0311222070  | 52333      | 13.23    | 0321224020  | 52125      | 13.40    |
| 0311222210  | 52333      | 13.23    | 0321224070  | 52124      | 13.40    |
| 0311222240  | 52333      | 13.23    | 0321224250  | 52120      | 13.40    |
| 0311222300  | 52333      | 13.23    | 0321225020  | 52126      | 13.41    |
| 0311233040  | 52323      | 13.23    | 0321225080  | 52121      | 13.40    |
| 0311233080  | 52322      | 13.23    | 0321225310  | 53946      | 13.42    |
| 0311244340  | 52150      | 13.23    | 0321226010  | 52127      | 13.41    |



| Auger Nr.  | O.E.M. Nr. | Page Nr. | Auger Nr.    | O.E.M. Nr. | Page Nr. |
|------------|------------|----------|--------------|------------|----------|
| 0321226140 | 53975      | 13.42    | 0333134050   | 52328      | 13.22    |
| 0321227010 | 52132      | 13.42    | 0334015080   | 54042      | 13.4     |
| 0322902010 | 52134      | 13.25    | 0334015080   | 54042      | 13.8     |
| 0322902030 | 52135      | 13.25    | 0334015100   | 54042      | 13.4     |
| 0322902090 | 52136      | 13.25    | 0334015100   | 54042      | 13.8     |
| 0322902100 | 52133      | 13.25    | 0334015200   | 54042      | 13.4     |
| 0322902160 | 52138      | 13.25    | 0334015200   | 54042      | 13.8     |
| 0322902161 | 52141      | 13.26    | 0334015220   | 54789      | 13.8     |
| 0322902170 | 52137      | 13.25    | 0334015230   | 54041      | 13.4     |
| 0322902180 | 52139      | 13.26    | 0334015270   | 54042      | 13.4     |
| 0322902190 | 52140      | 13.26    | 0334015270   | 54042      | 13.8     |
| 0326015010 | 54051      | 13.4     | 0334015370   | 54033      | 13.4     |
| 0326015010 | 54051      | 13.8     | 0334105030   | 54025      | 13.4     |
| 0326216020 | 52176      | 13.44    | 0334105040   | 54028      | 13.4     |
| 0326216030 | 52175      | 13.44    | 0334105050   | 54026      | 13.4     |
| 0326217030 | 52178      | 13.44    | 0334105050S  | 53538      | 13.6     |
| 0326217080 | 52177      | 13.44    | 0335367080   | 52101      | 13.7     |
| 0326217110 | 52178      | 13.44    | 0335367090   | 52100      | 13.7     |
| 0328154140 | 54835      | 13.4     | 0337007440   | 54000      | 13.45    |
| 0328154180 | 54836      | 13.4     | 0337007450   | 53996      | 13.45    |
| 0331038200 | 52086      | 13.43    | 0337007600   | 53518      | 13.44    |
| 0331038210 | 52088      | 13.43    | 0337007600TS | 55504      | 13.44    |
| 0331096040 | 52070      | 13.43    | 0337007620   | 53517      | 13.44    |
| 0331096050 | 52066      | 13.43    | 0337025160   | 52203      | 13.45    |
| 0331096060 | 52067      | 13.43    | 0337026220   | 52204      | 13.46    |
| 0331097030 | 52073      | 13.43    | 0337026240   | 52204      | 13.46    |
| 0331097040 | 52071      | 13.43    | 0339733060   | 52759      | 13.10    |
| 0331097070 | 52068      | 13.43    | 0339733070   | 52758      | 13.10    |
| 0331097080 | 52069      | 13.43    | 0339733080   | 53513      | 13.12    |
| 0331097130 | 52074      | 13.43    | 0339733090   | 53514      | 13.12    |
| 0331097140 | 52077      | 13.43    | 0339734010   | 52300      | 13.9     |
| 0331097150 | 52080      | 13.43    | 0339734100   | 53506      | 13.12    |
| 0331097160 | 52072      | 13.43    | 0339734110   | 53506      | 13.12    |
| 0331097220 | 52092      | 13.43    | 0339735050   | 54001      | 13.12    |
| 0331097270 | 52080      | 13.43    | 0339744060   | 52313      | 13.10    |
| 0331097280 | 52074      | 13.43    | 0339744100   | 53516      | 13.12    |
| 0331097290 | 52077      | 13.43    | 0339745100   | 52296      | 13.9     |
| 0331097300 | 52083      | 13.43    | 0511390060   | 52103      | 13.1     |
| 0331097310 | 52079      | 13.43    | 0511393020   | 52107      | 13.8     |
| 0331097320 | 52076      | 13.43    | 0511393030   | 52104      | 13.1     |
| 0331098020 | 52085      | 13.43    | 0511396050   | 52102      | 13.8     |
| 0331098040 | 52082      | 13.43    | 0511396050S  | 53541      | 13.8     |
| 0331098060 | 52078      | 13.43    | 0511396050S1 | 54435      | 13.8     |
| 0331098070 | 52075      | 13.43    | 0511396060   | 52107      | 13.8     |
| 0331098130 | 52084      | 13.43    | 0511397100   | 52110      | 13.1     |
| 0331098140 | 52081      | 13.43    | 0511398080   | 52106      | 13.1     |
| 0331098180 | 52093      | 13.43    | 0518913190   | 54920      | 13.4     |
| 0331098190 | 52081      | 13.43    | 0533144020   | 52770      | 13.22    |
| 0331098210 | 52087      | 13.43    | 0533184010   | 52349      | 13.17    |
| 0331098240 | 52091      | 13.43    | 0535367080   | 52101      | 13.7     |
| 0331099010 | 52090      | 13.43    | 0535367090   | 52100      | 13.7     |
| 0331099020 | 52089      | 13.43    | 0537007430   | 53966      | 13.45    |
| 0331099150 | 52089      | 13.43    | 0537700020   | 54919      | 13.26    |
| 0331099160 | 52090      | 13.43    | 0539726020   | 52765      | 13.11    |
| 0333134010 | 52332      | 13.22    | 0539726030   | 52760      | 13.10    |
| 0333134020 | 52331      | 13.22    | 0539726050   | 52780      | 13.11    |



| Auger Nr.    | O.E.M. Nr. | Page Nr. | Auger Nr.   | O.E.M. Nr. | Page Nr. |
|--------------|------------|----------|-------------|------------|----------|
| 0539727010   | 52760      | 13.10    | 0585700040  | 53522      | 13.6     |
| 0539728010   | 52310      | 13.9     | 0585700090  | 53537      | 13.6     |
| 0539734160   | 54002      | 13.12    | 0585700120  | 53523      | 13.6     |
| 0539734170   | 52761      | 13.10    | 0585700150  | 53545      | 13.5     |
| 0539735010   | 52762      | 13.11    | 0585700180  | 53546      | 13.5     |
| 0539735020   | 52764      | 13.11    | 090102450   | 53529      | 13.20    |
| 0539735030   | 52762      | 13.11    | 0908446110  | 52350      | 13.18    |
| 0539736050   | 52760      | 13.10    | 0908446120  | 52355      | 13.18    |
| 0539745010   | 52301      | 13.9     | 0908446350  | 52342      | 13.18    |
| 0539745040   | 52311      | 13.9     | 0908446360  | 52343      | 13.18    |
| 0539745050   | 52311      | 13.9     | 0908446390  | 53525      | 13.19    |
| 0539745100   | 52296      | 13.9     | 0908466020  | 53520      | 13.18    |
| 0539745140   | 52764      | 13.11    | 0917723090  | 52348      | 13.18    |
| 0539746030   | 52767      | 13.11    | 0980100140  | 52162      | 13.16    |
| 0539746060   | 52301      | 13.9     | 0980100141  | 52163      | 13.16    |
| 0539746070   | 52301      | 13.9     | 0980100142  | 52164      | 13.15    |
| 0539746090   | 52764      | 13.11    | 0980100242  | 52159      | 13.15    |
| 0539746120   | 52312      | 13.9     | 0980100370  | 52161      | 13.14    |
| 0539746130   | 52763      | 13.11    | 0980100430  | 52165      | 13.15    |
| 0539756040   | 52314      | 13.10    | 0980100431  | 53524      | 13.15    |
| 0539756070   | 52314      | 13.10    | 0980102010  | 52351      | 13.19    |
| 0539757030   | 52314      | 13.10    | 0980102020  | 52345      | 13.19    |
| 0539758030   | 52766      | 13.11    | 0980102030  | 52346      | 13.19    |
| 0542940010S  | 20032      | 13.47    | 0980102040  | 52347      | 13.19    |
| 0542940010S1 | 20114      | 13.48    | 0980102090  | 52503      | 13.17    |
| 0542940030S  | 20005      | 13.47    | 0980102090S | 52335      | 13.17    |
| 0542940030S1 | 20036      | 13.48    | 0980102100  | 52356      | 13.17    |
| 0542940910S  | 20004      | 13.47    | 0980102100S | 52337      | 13.17    |
| 0542940910S1 | 20034      | 13.47    | 0980102110  | 52338      | 13.16    |
| 0542941010S  | 20002      | 13.47    | 0980102110S | 52336      | 13.16    |
| 0542941010S1 | 20029      | 13.47    | 0980102120  | 52341      | 13.16    |
| 0544413010   | 21011      | 13.36    | 0980102120S | 52339      | 13.16    |
| 0544414010   | 21013      | 13.36    | 0980102130  | 52160      | 13.13    |
| 0544415010   | 21015      | 13.36    | 0980102140  | 52160      | 13.13    |
| 0544415100   | 21015      | 13.36    | 0980102150  | 52155      | 13.13    |
| 0544415110   | 21015      | 13.36    | 0980102160  | 52166      | 13.14    |
| 0544416010   | 21017      | 13.37    | 0980102220  | 52158      | 13.15    |
| 0544416100   | 21017      | 13.37    | 0980102230  | 52353      | 13.15    |
| 0544416110   | 21017      | 13.37    | 0980102440  | 53539      | 13.20    |
| 0544420010   | 21019      | 13.37    | 0980102460  | 53543      | 13.20    |
| 0544420040   | 21019      | 13.37    | 0980102470  | 53528      | 13.20    |
| 0544420100   | 21019      | 13.37    | 0980102630  | 54168      | 13.38    |
| 0544420110   | 21019      | 13.37    | 0980102910  | 52352      | 13.17    |
| 0544421010   | 21021      | 13.37    | 0980106090  | 52156      | 13.14    |
| 0544421040   | 21021      | 13.37    | 0980106090  | 52715      | 13.14    |
| 0544421110   | 21021      | 13.37    | 0980106091  | 53203      | 13.14    |
| 0544432010   | 21005      | 13.35    | 0980106190  | 53521      | 13.31    |
| 0544432020   | 21005      | 13.35    | 0980106280  | 53526      | 13.5     |
| 0544434010   | 21007      | 13.35    | 0980106290  | 53527      | 13.5     |
| 0544434020   | 21007      | 13.35    | 0980106320  | 54167      | 13.38    |
| 0544436010   | 21009      | 13.35    | 0980106400  | 53551      | 13.33    |
| 0544436020   | 21009      | 13.35    | 0980106410  | 53552      | 13.33    |
| 0544441010   | 21001      | 13.37    | 0980106770  | 53544      | 13.5     |
| 0544444010   | 21003      | 13.38    | 1030977424  | 21904      | 13.38    |
| 0580152720   | 52773      | 13.19    | 4881MBS     | 20002      | 13.47    |
| 0585700030   | 53553      | 13.6     | 881MBS      | 20032      | 13.47    |



| Auger Nr.  | O.E.M. Nr. | Page Nr. | Auger Nr.           | O.E.M. Nr. | Page Nr. |
|------------|------------|----------|---------------------|------------|----------|
| 940MBS     | 20004      | 13.47    | -                   | 21020      | 13.37    |
| 941MBS     | 20005      | 13.47    | -                   | 21002      | 13.38    |
| 9900000037 | 52340      | 13.31    | -                   | 20030      | 13.48    |
| 9900000040 | 52188      | 13.28    | -                   | 20031      | 13.48    |
| 9900000042 | 52191      | 13.29    | -                   | 20033      | 13.48    |
| 9900000070 | 52195      | 13.30    | -                   | 20035      | 13.48    |
| 9900000071 | 52184      | 13.28    | -                   | 52119      | 13.8     |
| 9900000072 | 52194      | 13.29    | <b>SAUER ACHSEN</b> |            |          |
| 9900000073 | 52187      | 13.28    | 1011000700          | 52176      | 14.28    |
| 9900000075 | 52190      | 13.29    | 1011007001          | 54279      | 14.29    |
| 9900000076 | 52193      | 13.29    | 1011007101          | 54280      | 14.29    |
| 9900000080 | 52186      | 13.28    | 1011008000          | 54277      | 14.28    |
| 9900000081 | 53031      | 13.31    | 1011008100          | 54278      | 14.28    |
| 9900000083 | 53033      | 13.31    | 1051100800          | 54794      | 14.2     |
| 9900000084 | 52354      | 13.31    | 1072001701          | 52212      | 14.19    |
| 9900000087 | 52199      | 13.30    | 1072001800          | 52211      | 14.19    |
| 9900000088 | 52185      | 13.28    | 1072001801          | 52211      | 14.19    |
| 9900000089 | 52197      | 13.30    | 1093000500          | 52777      | 14.27    |
| 9900000093 | 52183      | 13.28    | 1093001200          | 52778      | 14.27    |
| 9900000094 | 52198      | 13.30    | 1151000800          | 54834      | 14.7     |
| 9900000095 | 52192      | 13.29    | 1151001300          | 54833      | 14.7     |
| 9900000097 | 52196      | 13.30    | 1169000301          | 52168      | 14.4     |
| 9900000098 | 52200      | 13.30    | 1177100102          | 53560      | 14.1     |
| 9900000100 | 53533      | 13.32    | 1177200200          | 53559      | 14.1     |
| 9900000101 | 53530      | 13.32    | 1214000606          | 54795      | 14.7     |
| 9900000102 | 53532      | 13.32    | 1214002301          | 52373      | 14.16    |
| 9900000103 | 53535      | 13.32    | 1214002302          | 52373      | 14.16    |
| 9900000105 | 53536      | 13.33    | 1230003200          | 54282      | 14.18    |
| 9900000106 | 53032      | 13.31    | 1230003500          | 52363      | 14.17    |
| 9900000108 | 53534      | 13.32    | 1230004700          | 51075      | 14.4     |
| 9900000109 | 53531      | 13.32    | 1230004800          | 53036      | 14.4     |
| 9900000850 | 52189      | 13.29    | 1230006000          | 53035      | 14.4     |
| -          | 52152      | 13.13    | 1230006300          | 52995      | 14.4     |
| -          | 52153      | 13.13    | 1230008400          | 52910      | 14.17    |
| -          | 52157      | 13.13    | 1230008401          | 52910      | 14.17    |
| -          | 52344      | 13.14    | 1230010602          | 52206      | 14.17    |
| -          | 52576      | 13.34    | 1230010603          | 52206      | 14.17    |
| -          | 52578      | 13.34    | 1230010604          | 52206      | 14.17    |
| -          | 52580      | 13.34    | 1230013000          | 52995      | 14.4     |
| -          | 52581      | 13.34    | 1230013100          | 53035      | 14.4     |
| -          | 52582      | 13.34    | 1230014400          | 52365      | 14.17    |
| -          | 52583      | 13.34    | 1230100100          | 52209      | 14.19    |
| -          | 52584      | 13.34    | 1230100101          | 52209      | 14.19    |
| -          | 52585      | 13.34    | 1230100203          | 52208      | 14.19    |
| -          | 52586      | 13.34    | 1230100204          | 52207      | 14.19    |
| -          | 52587      | 13.34    | 1230200101          | 52210      | 14.19    |
| -          | 52588      | 13.34    | 1265000700          | 52368      | 14.16    |
| -          | 21004      | 13.35    | 1265001900          | 53557      | 14.16    |
| -          | 21006      | 13.35    | 1304001600          | 52360      | 14.27    |
| -          | 21008      | 13.35    | 1304004601          | 52361      | 14.27    |
| -          | 21010      | 13.36    | 1318100102          | 52169      | 14.4     |
| -          | 21012      | 13.36    | 1345000801          | 54005      | 14.29    |
| -          | 21014      | 13.36    | 1350200101          | 52215      | 14.18    |
| -          | 21016      | 13.36    | 1350200102          | 52215      | 14.18    |
| -          | 21000      | 13.37    | 1350200103          | 52215      | 14.18    |
| -          | 21018      | 13.37    |                     |            |          |



| Auger Nr.   | O.E.M. Nr. | Page Nr. | Auger Nr.     | O.E.M. Nr. | Page Nr. |
|-------------|------------|----------|---------------|------------|----------|
| 1350200104  | 52214      | 14.18    | 3268004500    | 52219      | 14.6     |
| 1350200201  | 52216      | 14.18    | 3268004600    | 52218      | 14.6     |
| 1350200500  | 52367      | 14.18    | 3268004700    | 52221      | 14.7     |
| 1395100100  | 52369      | 14.16    | 3268004800    | 52220      | 14.7     |
| 1395100500  | 53685      | 14.16    | 3268005000    | 55226      | 14.7     |
| 1395101300  | 52372      | 14.16    | 3268005100    | 55225      | 14.6     |
| 1447002101  | 52362      | 14.5     | 327019000     | 52376      | 14.3     |
| 1447003100  | 52362      | 14.5     | 3304008600    | 54283      | 14.27    |
| 1447003300  | 52775      | 14.5     | 3317000400    | 52223      | 14.13    |
| 1447003600  | 52780      | 14.6     | 3317000400SMB | 52225      | 14.11    |
| 1447003700  | 52760      | 14.6     | 3317000500    | 52752      | 14.14    |
| 1447003800  | 52779      | 14.5     | 3317000600    | 52224      | 14.13    |
| 1447005000  | 52776      | 14.5     | 3317000900    | 52238      | 14.13    |
| 1447005800  | 52774      | 14.5     | 3317001000    | 52237      | 14.13    |
| 1447006000  | 53558      | 14.5     | 3317001100    | 52228      | 14.13    |
| 2011004001  | 54004      | 14.28    | 3317001600    | 52239      | 14.13    |
| 2095203900  | 52370      | 14.1     | 3317003600    | 52240      | 14.14    |
| 3005000902  | 52246      | 14.20    | 3341104819    | 53037      | 14.3     |
| 3005003703  | 53062      | 14.21    | 3434360000    | 52375      | 14.12    |
| 3005004500  | 53591      | 14.22    | 3434360100    | 52504      | 14.12    |
| 3005005300  | 53590      | 14.22    | 3434360200    | 52751      | 14.15    |
| 3005005500  | 52245      | 14.20    | 3434360400    | 52374      | 14.11    |
| 3005005700  | 53597      | 14.23    | 3434360800    | 53577      | 14.14    |
| 3005007900  | 53598      | 14.23    | 3434361000    | 53574      | 14.10    |
| 3005010800  | 52377      | 14.21    | 3434361100    | 53573      | 14.10    |
| 3005011701  | 52243      | 14.20    | 3434361200    | 53581      | 14.14    |
| 3005012500  | 53592      | 14.22    | 3434361300    | 53572      | 14.9     |
| 3005013500  | 53586      | 14.21    | 3434361400    | 53571      | 14.9     |
| 3005013900  | 53587      | 14.21    | 3434361500    | 53578      | 14.14    |
| 3005014100  | 52244      | 14.20    | 3434361800    | 52226      | 14.8     |
| 3005014700  | 52241      | 14.20    | 3434361900    | 53569      | 14.7     |
| 3005014900  | 53588      | 14.22    | 3434362000    | 52226      | 14.8     |
| 3005015900  | 53589      | 14.22    | 3434362200    | 52227      | 14.8     |
| 3005016100  | 53593      | 14.22    | 3434363400    | 53575      | 14.10    |
| 3005017100  | 53594      | 14.23    | 3434363500    | 53582      | 14.14    |
| 3005017300  | 52242      | 14.20    | 3434363600    | 52235      | 14.9     |
| 3005017700  | 53585      | 14.21    | 3434363700    | 52233      | 14.11    |
| 3005018300  | 53596      | 14.23    | 3434363800    | 52234      | 14.9     |
| 3005020901  | 53599      | 14.23    | 3434363900    | 52357      | 14.8     |
| 3050100800  | 53595      | 14.3     | 3434364000    | 53579      | 14.8     |
| 3213000406  | 53997      | 14.15    | 3434364200    | 53576      | 14.8     |
| 3213002301  | 52781      | 14.15    | 3434364300    | 53564      | 14.3     |
| 3213002301S | 53562      | 14.15    | 3434364400    | 53565      | 14.3     |
| 3213002302  | 52781      | 14.15    | 3434365200    | 53570      | 14.8     |
| 3213002302S | 53562      | 14.15    | 3434382701    | 54559      | 14.23    |
| 3230100204  | 52207      | 14.19    | 3454106560    | 21005      | 14.25    |
| 3230200101  | 52210      | 14.19    | 3454106760    | 21007      | 14.25    |
| 3268000600  | 52236      | 14.11    | 3454106960    | 21009      | 14.25    |
| 3268000701  | 52222      | 14.12    | 3454108160    | 21005      | 14.25    |
| 3268000702  | 52232      | 14.9     | 3454108260    | 21007      | 14.25    |
| 3268000801  | 53563      | 14.12    | 4011003901    | 54003      | 14.28    |
| 3268003200  | 53568      | 14.12    | 4079000400    | 31029      | 14.26    |
| 3268003300  | 53566      | 14.12    | 4079000501    | 31030      | 14.26    |
| 3268003400  | 52704      | 14.10    | 4079000701    | 31031      | 14.26    |
| 3268003500  | 53580      | 14.10    | 4131000800    | 52213      | 14.6     |
| 3268003700  | 53567      | 14.11    | 4177000800    | 52359      | 14.1     |





| Auger Nr.      | O.E.M. Nr. | Page Nr. | Auger Nr.         | O.E.M. Nr. | Page Nr. |
|----------------|------------|----------|-------------------|------------|----------|
| 4177002000     | 54281      | 14.2     | 1669000G          | 52216      | 15.8     |
| 4177301000     | 52217      | 14.1     | 2033000M          | 54048      | 15.1     |
| 4177301600     | 52104      | 14.1     | 2210000Z          | 53747      | 15.1     |
| 4177302600     | 54285      | 14.2     | 2211015T          | 53768      | 15.2     |
| 4177302600S    | 55182      | 14.3     | 6024000P          | 53748      | 15.10    |
| 4177302800     | 53555      | 14.2     | 6113300A          | 54029      | 15.1     |
| 4177302800S    | 55181      | 14.3     | 6114000K          | 54049      | 15.1     |
| 4202100680     | 54058      | 14.2     | 6115000X          | 53745      | 15.1     |
| 4230017000     | 54644      | 14.28    | 6127000M          | 53746      | 15.1     |
| 4230017201     | 53556      | 14.18    | 6401000J          | 53299      | 15.1     |
| 4230017600     | 52205      | 14.17    | 6501811Y          | 52775      | 15.8     |
| 4230018000     | 52366      | 14.17    | 6502101T          | 53767      | 15.6     |
| 4247402280     | 54053      | 14.2     | 6502102W          | 53758      | 15.5     |
| 4304009300     | 54284      | 14.27    | 6502102W(S)       | 53759      | 15.5     |
| 4331502900     | 55275      | 14.2     | 6502103X          | 52275      | 15.4     |
| 4343001388     | 54796      | 14.2     | 6502103X(S)       | 53753      | 15.4     |
| 4343008088     | 54033      | 14.2     | 6502105Z          | 53764      | 15.2     |
| 4343104888     | 54034      | 14.2     | 6502105Z(S)       | 53765      | 15.2     |
| 4343105300     | 54035      | 14.2     | 6502176T          | 54043      | 15.1     |
| 4343205510     | 55276      | 14.2     | 6502188Z          | 54004      | 15.10    |
| 4373001000     | 54870      | 14.7     | 6502382B          | 53752      | 15.7     |
| 4454103900     | 21017      | 14.26    | 6502801E          | 53749      | 15.10    |
| 5399002070     | 52376      | 14.3     | 6502802F          | 53750      | 15.10    |
| -              | 52229      | 14.10    | 6502809R          | 53751      | 15.9     |
| -              | 52231      | 14.11    | 6502810F          | 52271      | 15.9     |
| -              | 53583      | 14.15    | 6503338F          | 53756      | 15.5     |
| -              | 53584      | 14.15    | 6503338F(S)       | 53757      | 15.5     |
| -              | 53171      | 14.21    | 6503721R          | 52206      | 15.8     |
| -              | 52576      | 14.24    | 6503723T          | 52276      | 15.4     |
| -              | 52578      | 14.24    | 6503723T(S)       | 53754      | 15.4     |
| -              | 52580      | 14.24    | 6503954M          | 53748      | 15.10    |
| -              | 52581      | 14.24    | 6504210X          | 52217      | 15.1     |
| -              | 52582      | 14.24    | 6504212Z          | 54044      | 15.1     |
| -              | 52583      | 14.24    | 6504771P          | 52273      | 15.9     |
| -              | 52584      | 14.24    | 6504774T          | 54831      | 15.7     |
| -              | 52585      | 14.24    | 6504775W          | 53760      | 15.6     |
| -              | 52586      | 14.24    | 6504775W(S)       | 53761      | 15.6     |
| -              | 52587      | 14.24    | 6504785Y          | 52272      | 15.9     |
| -              | 52588      | 14.24    | 7000107D          | 53849      | 15.8     |
| -              | 21004      | 14.25    | M010676           | 53165      | 15.5     |
| -              | 21006      | 14.25    | M050147           | 53841      | 15.5     |
| -              | 21008      | 14.25    |                   |            |          |
| -              | 21016      | 14.26    |                   |            |          |
| -              | 54049      | 14.7     |                   |            |          |
| -              | 54869      | 14.7     |                   |            |          |
| -              | 52230      | 14.9     |                   |            |          |
| <b>TRAILOR</b> |            |          | <b>KASSBOHRER</b> |            |          |
| 1639000W       | 52210      | 15.9     | 351605            | 31016      | 16.5     |
| 1642000S       | 52368      | 15.7     | 1792411131        | 31016      | 16.5     |
| 1643000C       | 52891      | 15.8     | 17924111310       | 31016      | 16.5     |
| 1646000J       | 54916      | 15.7     | 010242178931      | 54395      | 16.6     |
| 1650000S       | 52910      | 15.8     | 015262210151      | 53065      | 16.4     |
| 1652010R       | 52921      | 15.7     | 015262210351      | 53064      | 16.4     |
| 1655000W       | 52212      | 15.9     | 4771388000        | 52703      | 16.1     |
| 1656000E       | 52211      | 15.9     | 4771389000        | 52641      | 16.1     |
|                |            |          | 82262320660       | 51137      | 16.8     |
|                |            |          | 8226293000B       | 15105      | 16.8     |
|                |            |          | 82262960690       | 51972      | 16.8     |
|                |            |          | 8241000421        | 52108      | 16.1     |
|                |            |          | 8241000422        | 52169      | 16.1     |



| Auger Nr.  | O.E.M. Nr. | Page Nr. | Auger Nr.  | O.E.M. Nr. | Page Nr. |
|------------|------------|----------|------------|------------|----------|
| 8241000430 | 52168      | 16.1     | 21006585   | 52210      | 17.14    |
| 8241000443 | 52323      | 16.4     | 21006610   | 52368      | 17.13    |
| 8241000618 | 52135      | 16.5     | 21006614   | 54916      | 17.6     |
| 8241000622 | 52162      | 16.2     | 21008062   | 52268      | 17.15    |
| 8241000894 | 52333      | 16.4     | 21008063   | 52268      | 17.15    |
| 8241016213 | 52143      | 16.4     | 21011745   | 52256      | 17.1     |
| 8241016214 | 52134      | 16.5     | 21011746   | 52251      | 17.1     |
| 8241016244 | 52123      | 16.6     | 21015626   | 54032      | 17.2     |
| 8241021348 | 52175      | 16.7     | 21016115   | 54052      | 17.2     |
| 8241021349 | 52077      | 16.7     | 21016330   | 54880      | 17.18    |
| 8241021350 | 52074      | 16.7     | 21016666   | 52910      | 17.13    |
| 8241021355 | 52311      | 16.2     | 21016722   | 52212      | 17.14    |
| 8241024267 | 52765      | 16.2     | 21016723   | 52211      | 17.14    |
| 8241030286 | 52126      | 16.6     | 21020039   | 52921      | 17.12    |
| 8241037363 | 52177      | 16.7     | 21020663   | 54881      | 17.18    |
| 8241037364 | 52081      | 16.7     | 21020676   | 52253      | 17.1     |
| 8241037365 | 52080      | 16.7     | 21020818   | 54807      | 17.19    |
| 8241037372 | 52125      | 16.6     | 21022348   | 53788      | 17.5     |
| 8241092582 | 52306      | 16.3     | 21023389   | 53779      | 17.5     |
| 8241129630 | 52307      | 16.3     | 21023758   | 53210      | 17.6     |
| 8241129634 | 52330      | 16.3     | 21200321   | 54883      | 17.18    |
| 8241129641 | 52329      | 16.3     | 21200920   | 52911      | 17.15    |
| 8241129654 | 53506      | 16.2     | 21200921   | 52911      | 17.15    |
| 8241202905 | 52105      | 16.1     | 21202094   | 54024      | 17.2     |
| 8241999222 | 52332      | 16.3     | 21202104   | 52279      | 17.2     |
| 8241999292 | 52122      | 16.6     | 21202329   | 52267      | 17.15    |
| 8241999293 | 53059      | 16.7     | 21202330   | 52267      | 17.15    |
| 8241999299 | 53996      | 16.7     | 21202627   | 52908      | 17.17    |
| 8241999300 | 52133      | 16.5     | 21204601   | 52212      | 17.14    |
| 8241999301 | 52136      | 16.5     | 21204602   | 52211      | 17.14    |
| 8241999330 | 52325      | 16.3     | 21204703   | 52247      | 17.13    |
| 8241999331 | 52322      | 16.4     | 21204849   | 52248      | 17.11    |
| 8241999333 | 52313      | 16.2     | 21205193   | 52904      | 17.12    |
| 8241999447 | 52087      | 16.7     | 21205193S  | 53775      | 17.12    |
| 8241999459 | 52079      | 16.7     | 21205193S1 | 54405      | 17.12    |
| 8241999460 | 52076      | 16.7     | 21205194   | 52784      | 17.5     |
| 8241999464 | 52124      | 16.6     | 21205204   | 53039      | 17.12    |
| 8241999546 | 52083      | 16.7     | 21205571   | 54806      | 17.19    |
| 8241999547 | 52087      | 16.7     | 21205667   | 52250      | 17.11    |
| 8285417000 | 21904      | 16.5     | 21206000   | 54023      | 17.2     |
| 8900020184 | 52764      | 16.2     | 21206001   | 54050      | 17.2     |
| <b>ROR</b> |            |          | 21208093   | 52108      | 17.1     |
| 10690588   | 52262      | 17.7     | 21209705   | 53156      | 17.15    |
| 1229K4795  | 54872      | 17.6     | 21209706   | 53156      | 17.15    |
| 15204595   | 52259      | 17.14    | 21209990   | 52249      | 17.13    |
| 15205204   | 53798      | 17.9     | 21210215   | 54915      | 17.5     |
| 15213430   | 52257      | 17.14    | 21210819   | 54804      | 17.19    |
| 15220224   | 52258      | 17.14    | 21212670   | 31002      | 17.16    |
| 15220648   | 52269      | 17.15    | 21215601R  | 52118      | 17.1     |
| 15221568   | 52912      | 17.15    | 21220158   | 54882      | 17.18    |
| 15224518   | 52270      | 17.15    | 21220647   | 52269      | 17.15    |
| 15224821   | 52258      | 17.14    | 21220726   | 54808      | 17.19    |
| 15226262   | 53803      | 17.9     | 21220727   | 52907      | 17.17    |
| 15226632   | 53802      | 17.9     | 21220759   | 54805      | 17.19    |
| 21006563   | 53778      | 17.11    | 21220859   | 52906      | 17.5     |
|            |            |          | 21221061   | 54809      | 17.19    |



| Auger Nr.   | O.E.M. Nr. | Page Nr. | Auger Nr.                      | O.E.M. Nr. | Page Nr. |
|-------------|------------|----------|--------------------------------|------------|----------|
| 21221224    | 52785      | 17.5     | SUS3                           | 52265      | 17.3     |
| 21221224S   | 53807      | 17.11    | SUS4                           | 52266      | 17.3     |
| 21221567    | 52912      | 17.15    | -                              | 53801      | 17.10    |
| 21222233    | 54046      | 17.2     | -                              | 53810      | 17.10    |
| 21222234    | 54044      | 17.2     | -                              | 53812      | 17.10    |
| 21222609    | 52105      | 17.1     | -                              | 53813      | 17.11    |
| 21222609S   | 53804      | 17.3     | -                              | 53777      | 17.12    |
| 21223112    | 53781      | 17.17    | -                              | 53784      | 17.12    |
| 21223742    | 53786      | 17.2     | -                              | 53776      | 17.13    |
| 21223742S   | 53805      | 17.3     | -                              | 53783      | 17.13    |
| 21223744    | 54045      | 17.2     | -                              | 52576      | 17.4     |
| 21224263    | 31000      | 17.16    | -                              | 52578      | 17.4     |
| 21224522    | 52270      | 17.15    | -                              | 52580      | 17.4     |
| 21224663    | 54681      | 17.2     | -                              | 52581      | 17.4     |
| 21224673    | 52900      | 17.17    | -                              | 52582      | 17.4     |
| 21224762    | 54406      | 17.19    | -                              | 52583      | 17.4     |
| 21225115    | 31001      | 17.16    | -                              | 52584      | 17.4     |
| 21226003    | 54407      | 17.19    | -                              | 52585      | 17.4     |
| 21226038    | 54408      | 17.17    | -                              | 52586      | 17.4     |
| 21226090    | 54410      | 17.19    | -                              | 52587      | 17.4     |
| 21226119    | 54409      | 17.17    | -                              | 52588      | 17.4     |
| 21227205    | 53787      | 17.2     | -                              | 53796      | 17.6     |
| 21227205S   | 53806      | 17.3     | -                              | 54831      | 17.6     |
| 21227349    | 31003      | 17.16    | -                              | 53808      | 17.7     |
| 2124754     | 52255      | 17.1     | -                              | 53809      | 17.7     |
| 64225252    | 55208      | 17.16    | -                              | 53811      | 17.9     |
| 90508004    | 53785      | 17.19    | <b>YORK / SAE-GIGANT / SMB</b> |            |          |
| 99527003    | 54053      | 17.2     | 02001001                       | 53828      | 18.8     |
| A2310521213 | 53040      | 17.14    | 02001004                       | 53826      | 18.8     |
| AXL101      | 53792      | 17.18    | 05703006                       | 53832      | 18.7     |
| AXL102      | 53793      | 17.18    | 06311046                       | 53831      | 18.7     |
| AXL103      | 53794      | 17.18    | 08206009                       | 53835      | 18.8     |
| AXL104      | 52914      | 17.19    | 08307075                       | 53825      | 18.7     |
| AXL105      | 52913      | 17.19    | 08612004                       | 53834      | 18.8     |
| AXL106      | 52662      | 17.9     | 08709045                       | 53827      | 18.7     |
| AXL111      | 52717      | 17.6     | 08803055                       | 53833      | 18.8     |
| AXL112      | 52716      | 17.7     | 08804062                       | 53829      | 18.7     |
| AXL114      | 53795      | 17.18    | 08804086                       | 53830      | 18.7     |
| AXL117      | 52915      | 17.10    | 08902022                       | 53838      | 18.6     |
| AXL122      | 52261      | 17.8     | 08910060                       | 53837      | 18.6     |
| AXL123      | 53789      | 17.7     | 500356                         | 53817      | 18.4     |
| AXL124      | 53066      | 17.7     | 500362                         | 52210      | 18.5     |
| AXL125      | 52916      | 17.8     | 500363                         | 53158      | 18.4     |
| AXL126      | 52661      | 17.10    | 500372                         | 54916      | 18.3     |
| AXL132      | 52260      | 17.8     | 500808/9                       | 53814      | 18.5     |
| AXL14       | 53800      | 17.10    | 500958                         | 52251      | 18.1     |
| AXL140      | 53041      | 17.8     | 501574                         | 53816      | 18.4     |
| AXL31       | 53067      | 17.6     | 501787                         | 52910      | 18.4     |
| AXL6        | 53797      | 17.9     | 501875/6                       | 53815      | 18.5     |
| AXL7        | 53799      | 17.11    | 502461S                        | 54419      | 18.5     |
| AXLLM1      | 53791      | 17.8     | 502462S                        | 54419      | 18.5     |
| AXLM4       | 53790      | 17.8     | 502765                         | 53819      | 18.5     |
| SP7984      | 55223      | 17.16    | 503087                         | 53159      | 18.4     |
| ST1036      | 55222      | 17.16    | 503320                         | 53779      | 18.2     |
| SUS1        | 52263      | 17.3     | 503624                         | 52253      | 18.1     |
| SUS2        | 52264      | 17.3     |                                |            |          |



| Auger Nr.       | O.E.M. Nr. | Page Nr. | Auger Nr.    | O.E.M. Nr. | Page Nr. |
|-----------------|------------|----------|--------------|------------|----------|
| 506242          | 52217      | 18.1     | AEJB0003002  | 53851      | 19.4     |
| 506498          | 53818      | 18.2     | AFA9104001   | 21011      | 19.10    |
| 534601          | 53160      | 18.2     | AJA0483001   | 52277      | 19.8     |
| 770701          | 52279      | 18.1     | AJA0483002   | 52277      | 19.8     |
| 786123          | 53157      | 18.5     | AJA0487001   | 53849      | 19.7     |
| 786228          | 53820      | 18.2     | AJA0492001   | 53845      | 19.12    |
| M001502         | 52217      | 18.12    | AJA0492001 S | 53846      | 19.12    |
| M002564         | 54411      | 18.12    | AJA0504001   | 52368      | 19.6     |
| M002693         | 54831      | 18.10    | AJA0504002   | 53848      | 19.6     |
| M002866         | 52921      | 18.10    | AJA0506001   | 54831      | 19.3     |
| M002874         | 52920      | 18.9     | AJA0507001   | 52919      | 19.6     |
| M002904         | 54677      | 18.11    | AJA0558001   | 52918      | 19.6     |
| M002912         | 54677      | 18.11    | AJA0577001   | 53844      | 19.12    |
| M002971         | 52368      | 18.10    | AJA0753001   | 53163      | 19.6     |
| M003001         | 54916      | 18.10    | AJA0753002   | 53162      | 19.6     |
| M003060         | 52367      | 18.10    | AJB0001001   | 53842      | 19.8     |
| M007150         | 53849      | 18.9     | AJB0002001   | 53842      | 19.8     |
| M007363         | 52273      | 18.11    | AJB0006001   | 52280      | 19.8     |
| M007371         | 53848      | 18.10    | AJB0006002   | 52280      | 19.8     |
| M007916         | 54412      | 18.12    | AJB0119001   | 52920      | 19.7     |
| M008892         | 53847      | 18.12    | AJB0407001   | 53843      | 19.12    |
| M009260         | 54680      | 18.11    | AJV4526      | 21005      | 19.10    |
| M009279         | 52782      | 18.9     | ARJA0199702  | 53853      | 19.4     |
| M009309         | 54678      | 18.11    | ARJA0199703  | 53167      | 19.5     |
| M010544         | 52272      | 18.11    | ARJB0006701  | 52917      | 19.8     |
| M010552         | 54413      | 18.9     | ASX0014-018  | 21011      | 19.10    |
| M010676         | 53165      | 18.9     | ASX0014-019  | 21013      | 19.10    |
| M046565         | 54676      | 18.11    | ASX0014-020  | 21015      | 19.11    |
| M046573         | 54676      | 18.11    | ASX0014-021  | 21017      | 19.11    |
| M050147         | 53841      | 18.9     | CF1001312    | 52210      | 19.7     |
| M051275         | 54679      | 18.11    | CF100149     | 52290      | 19.4     |
| -               | 52266      | 18.1     | CF1014969    | 52288      | 19.3     |
| -               | 53161      | 18.2     | CR2672201    | 54414      | 19.12    |
| -               | 53821      | 18.2     | M001502      | 52217      | 19.1     |
| -               | 53822      | 18.3     | M002693      | 54831      | 19.3     |
| -               | 53823      | 18.3     | M002866      | 52921      | 19.6     |
| -               | 53824      | 18.3     | M002874      | 52920      | 19.7     |
| -               | 53929      | 18.3     | M002971      | 52368      | 19.6     |
| -               | 53930      | 18.3     | M003001      | 54916      | 19.3     |
| -               | 52921      | 18.4     | M003060      | 52367      | 19.8     |
| -               | 53836      | 18.6     | M008892      | 53847      | 19.12    |
| -               | 53839      | 18.6     | M008949      | 53856      | 19.2     |
| -               | 53840      | 18.6     | M009279      | 52782      | 19.4     |
| -               | 52216      | 18.10    | M010676      | 53165      | 19.3     |
| <b>FRUEHAUF</b> |            |          | M020272-03   | 21017      | 19.11    |
| 100113          | 52287      | 19.2     | M050147      | 53841      | 19.3     |
| 100113(S)       | 53205      | 19.2     | MO 69018     | 31013      | 19.11    |
| 100114          | 52286      | 19.2     | UJA0030001   | 52282      | 19.1     |
| 100114(S)       | 53204      | 19.2     | UJA0033001   | 52279      | 19.1     |
| 1H312161-609    | 21015      | 19.11    | UJA0034001   | 54022      | 19.1     |
| AEJA0441001     | 52281      | 19.7     | UJA0324001   | 54021      | 19.1     |
| AEJA0441002A    | 52278      | 19.7     | -            | 54041      | 19.1     |
| AEJA0442001     | 52283      | 19.7     | -            | 54053      | 19.1     |
| AEJA0442001S    | 53164      | 19.4     | -            | 21004      | 19.10    |
| AEJB0003001     | 53852      | 19.4     | -            | 21010      | 19.10    |
|                 |            |          | -            | 21012      | 19.10    |



| Auger Nr.              | O.E.M. Nr. | Page Nr. | Auger Nr.    | O.E.M. Nr. | Page Nr. |
|------------------------|------------|----------|--------------|------------|----------|
| -                      | 21014      | 19.11    | 0004340807   | 52676      | 20.29    |
| -                      | 21016      | 19.11    | 0004342301   | 52674      | 20.29    |
| -                      | 52289      | 19.3     | 0004342401   | 52675      | 20.29    |
| -                      | 53210      | 19.3     | 000482024001 | 52595      | 20.30    |
| -                      | 53854      | 19.5     | 0109912      | 52517      | 20.31    |
| -                      | 53855      | 19.5     | 0109915      | 52513      | 20.31    |
| -                      | 53857      | 19.5     | 0482006009   | 54704      | 20.30    |
| -                      | 53858      | 19.5     | 0482006013   | 54703      | 20.30    |
| -                      | 54909      | 19.7     | 0544441010   | 21001      | 20.24    |
| -                      | 52216      | 19.8     | 0544444010   | 21003      | 20.24    |
| -                      | 52576      | 19.9     | 0632566      | 52516      | 20.31    |
| -                      | 52578      | 19.9     | 0945470      | 21019      | 20.27    |
| -                      | 52580      | 19.9     | 11058261     | 54725      | 20.38    |
| -                      | 52581      | 19.9     | 12999076VT   | 54563      | 20.21    |
| -                      | 52582      | 19.9     | 12999141VT   | 54570      | 20.22    |
| -                      | 52583      | 19.9     | 12999197VT   | 54564      | 20.21    |
| -                      | 52584      | 19.9     | 12999199VT   | 54527      | 20.20    |
| -                      | 52585      | 19.9     | 12999543VT   | 54567      | 20.22    |
| -                      | 52586      | 19.9     | 12999551VT   | 54568      | 20.22    |
| -                      | 52587      | 19.9     | 12999552VT   | 54560      | 20.21    |
| -                      | 52588      | 19.9     | 12999580VT   | 54565      | 20.21    |
| <b>UNIVERSAL PARTS</b> |            |          | 12999677VT   | 54558      | 20.20    |
| 0000720112             | 52594      | 20.30    | 12999678VT   | 54569      | 20.22    |
| 0000720112             | 54705      | 20.30    | 12999699VT   | 54566      | 20.22    |
| 0000721512             | 52593      | 20.30    | 12999704VT   | 54561      | 20.21    |
| 0000721812             | 52593      | 20.30    | 12999729VT   | 54528      | 20.20    |
| 0000721912             | 52593      | 20.30    | 12999738VT   | 54559      | 20.20    |
| 0000722212             | 52593      | 20.30    | 12999746VT   | 54562      | 20.21    |
| 0001400359             | 54706      | 20.30    | 1504064      | 52513      | 20.31    |
| 0001400459             | 54706      | 20.30    | 1505065      | 52515      | 20.31    |
| 0001400759             | 54706      | 20.30    | 1505282      | 54718      | 20.38    |
| 0001400859             | 54706      | 20.30    | 1506023      | 54725      | 20.38    |
| 0004290000             | 52595      | 20.30    | 1506027      | 54726      | 20.38    |
| 0004291431             | 52509      | 20.28    | 1584598      | 52514      | 20.31    |
| 0004293430             | 52519      | 20.31    | 1584599      | 52516      | 20.31    |
| 0004293530             | 52513      | 20.31    | 175 202      | 21013      | 20.26    |
| 0004293630             | 52515      | 20.31    | 175 203      | 21015      | 20.26    |
| 0004293930             | 52514      | 20.31    | 175 204      | 21017      | 20.26    |
| 0004294030             | 52516      | 20.31    | 2515210      | 52516      | 20.31    |
| 0004295930             | 52520      | 20.31    | 2515298      | 52514      | 20.31    |
| 0004297930             | 52518      | 20.31    | 2516345      | 52520      | 20.31    |
| 0004297930             | 52520      | 20.31    | 2516835      | 52520      | 20.31    |
| 0004298030             | 52514      | 20.31    | 2519879      | 52517      | 20.31    |
| 0004298130             | 52516      | 20.31    | 318159       | 52516      | 20.31    |
| 0004300126             | 54702      | 20.30    | 330301       | 52518      | 20.31    |
| 0004300126             | 54704      | 20.30    | 330302       | 52520      | 20.31    |
| 0004300226             | 54704      | 20.30    | 334652       | 21005      | 20.25    |
| 0004300626             | 54703      | 20.30    | 335890       | 21019      | 20.27    |
| 0004300626             | 54703      | 20.30    | 337900       | 21007      | 20.25    |
| 0004301026             | 54703      | 20.30    | 337902       | 21009      | 20.25    |
| 0004303026             | 52595      | 20.30    | 343320       | 21021      | 20.27    |
| 0004303226             | 52595      | 20.30    | 3550700475   | 54707      | 20.30    |
| 0004303426             | 54704      | 20.30    | 4214110200   | 54704      | 20.30    |
| 0004304826             | 52595      | 20.30    | 4214110230   | 54704      | 20.30    |
| 0004304926             | 52595      | 20.30    | 4214110250   | 54703      | 20.30    |
|                        |            |          | 4214110860   | 54702      | 20.30    |



| Auger Nr.   | O.E.M. Nr. | Page Nr. | Auger Nr.    | O.E.M. Nr. | Page Nr. |
|-------------|------------|----------|--------------|------------|----------|
| 4214110860  | 54704      | 20.30    | 81157015001  | 54705      | 20.30    |
| 4214113010  | 54702      | 20.30    | 81157016079  | 54705      | 20.30    |
| 4214113060  | 54703      | 20.30    | 81157016091  | 54705      | 20.30    |
| 4231047100  | 21005      | 20.25    | 81157016099  | 54705      | 20.30    |
| 4231049000  | 21011      | 20.26    | 81157016112  | 54705      | 20.30    |
| 4231059000  | 21013      | 20.26    | 81157016116  | 54705      | 20.30    |
| 4231069000  | 21015      | 20.26    | 81157016119  | 54705      | 20.30    |
| 4231079000  | 21017      | 20.26    | 81512206024  | 52513      | 20.31    |
| 4235050000  | 21007      | 20.25    | 81512206025  | 52515      | 20.31    |
| 4235060010  | 21009      | 20.25    | 81512206033  | 52519      | 20.31    |
| 42541412    | 53889      | 20.9     | 81512206038  | 52520      | 20.31    |
| 4325000200  | 52509      | 20.28    | 81512206040  | 52520      | 20.31    |
| 4325000200  | 52632      | 20.29    | 81512206075  | 52518      | 20.31    |
| 4460083802  | 54725      | 20.38    | 81512206093  | 52516      | 20.31    |
| 4460083902  | 54717      | 20.38    | 81512206094  | 52514      | 20.31    |
| 4460084042  | 54726      | 20.38    | 8157983      | 52514      | 20.31    |
| 4460084142  | 54718      | 20.38    | 8157984      | 52516      | 20.31    |
| 4470700175  | 54707      | 20.30    | 88512206003  | 52517      | 20.31    |
| 4520021000  | 52509      | 20.28    | 8971204924   | 52576      | 20.23    |
| 4520021070  | 52509      | 20.28    | 8971205054   | 52578      | 20.23    |
| 4522000110  | 52517      | 20.31    | 8971205104   | 52580      | 20.23    |
| 4522000120  | 52519      | 20.31    | 8971205164   | 52585      | 20.23    |
| 4522002110  | 52513      | 20.31    | 8971205204   | 52581      | 20.23    |
| 4522002120  | 52515      | 20.31    | 8971205264   | 52586      | 20.23    |
| 4630131100  | 52674      | 20.29    | 8971205304   | 52582      | 20.23    |
| 4630131140  | 52675      | 20.29    | 8971205344   | 52587      | 20.23    |
| 4680365     | 52513      | 20.31    | 8971205404   | 52583      | 20.23    |
| 4680365     | 52515      | 20.31    | 8971205464   | 52588      | 20.23    |
| 5000440154  | 52513      | 20.31    | 8971205504   | 52584      | 20.23    |
| 5000440155  | 52515      | 20.31    | 8975500204   | 52590      | 20.31    |
| 5000442713  | 52514      | 20.31    | 8JA003831001 | 52521      | 20.34    |
| 5000442714  | 52516      | 20.31    | 8JA003832001 | 52522      | 20.34    |
| 5000608011  | 52518      | 20.31    | 8JA003832001 | 52591      | 20.34    |
| 5000821966  | 54557      | 20.19    | 8JA003834001 | 52592      | 20.34    |
| 5001822994  | 54175      | 20.14    | 9253713000   | 21019      | 20.27    |
| 5001831176  | 55176      | 20.19    | 9253723000   | 21021      | 20.27    |
| 5001837006  | 53874      | 20.13    | 93161192     | 53883      | 20.8     |
| 5001858718  | 54173      | 20.14    | 9343000010   | 52676      | 20.29    |
| 5001860792  | 54173      | 20.14    | 945152       | 21017      | 20.26    |
| 5001866398  | 54174      | 20.14    | 945153       | 21015      | 20.26    |
| 5001866400  | 54172      | 20.14    | 945154       | 21013      | 20.26    |
| 5001866989  | 54169      | 20.13    | 945157       | 21011      | 20.26    |
| 5812866     | 21005      | 20.25    | 9507300050   | 21951      | 20.39    |
| 58128660    | 21005      | 20.25    | 9522000210   | 52518      | 20.31    |
| 60135772    | 52518      | 20.31    | 9522000220   | 52520      | 20.31    |
| 61577724    | 52513      | 20.31    | 9522002210   | 52514      | 20.31    |
| 61578000    | 52515      | 20.31    | 9522002220   | 52516      | 20.31    |
| 6500657     | 54725      | 20.38    | 9522010010   | 54690      | 20.31    |
| 6500662     | 54726      | 20.38    | 9522010020   | 54688      | 20.31    |
| 6500664     | 54718      | 20.38    | 9522010030   | 54689      | 20.31    |
| 77348       | 21015      | 20.26    | 9522010040   | 54687      | 20.31    |
| 79302       | 21013      | 20.26    | 9522010070   | 54692      | 20.31    |
| 79303       | 21015      | 20.26    | 9522010080   | 54691      | 20.31    |
| 79537       | 21011      | 20.26    | 9735000000   | 52708      | 20.28    |
| 79545       | 21017      | 20.26    | B0481007010  | 52675      | 20.29    |
| 81157009006 | 54705      | 20.30    | B0481007029  | 52674      | 20.29    |



| Auger Nr.    | O.E.M. Nr. | Page Nr. | Auger Nr.   | O.E.M. Nr. | Page Nr. |
|--------------|------------|----------|-------------|------------|----------|
| B0481019002  | 52676      | 20.29    | MCK1243     | 54171      | 20.14    |
| BS3300       | 21004      | 20.25    | MCK1253     | 53868      | 20.12    |
| BS3404       | 21006      | 20.25    | MCK1254     | 53869      | 20.12    |
| BS3509       | 21008      | 20.25    | MCK1299     | 54554      | 20.19    |
| BS7304       | 21000      | 20.24    | SJ1018      | 55180      | 20.20    |
| BX3417       | 21012      | 20.26    | SJ1022      | 54541      | 20.17    |
| BX3535       | 21014      | 20.26    | SJ1030      | 54539      | 20.16    |
| BX3605       | 21016      | 20.26    | SJ1033      | 55179      | 20.20    |
| BX7515       | 21019      | 20.27    | SJ1034      | 54538      | 20.16    |
| BZ3370       | 21010      | 20.26    | SJ1035      | 54543      | 20.17    |
| II179320062  | 53885      | 20.8     | SJ1037      | 54545      | 20.17    |
| II197140062  | 53884      | 20.8     | SJ1213      | 54546      | 20.17    |
| II197330062  | 53886      | 20.8     | SJ4011      | 54549      | 20.18    |
| II304130065  | 53878      | 20.7     | SJ4021      | 54552      | 20.18    |
| II328090062  | 53890      | 20.9     | SJ4052      | 54532      | 20.15    |
| II339680062  | 53890      | 20.9     | SJ4053      | 54555      | 20.19    |
| II358510062  | 53882      | 20.8     | SJ4076      | 54548      | 20.18    |
| II368470064  | 53875      | 20.7     | SJ4077      | 54531      | 20.15    |
| II369100062  | 53890      | 20.9     | SJ4078      | 54547      | 20.18    |
| II39769F0062 | 54522      | 20.11    | SP8564      | 54537      | 20.16    |
| II39769F0063 | 53879      | 20.7     | SP8565      | 54540      | 20.16    |
| K000029      | 54068      | 20.9     | SP8566      | 54542      | 20.17    |
| K000132      | 54686      | 20.12    | SP8567      | 54535      | 20.16    |
| K000375      | 53888      | 20.9     | SP8597      | 54533      | 20.15    |
| K000472      | 54069      | 20.9     | SP8902      | 54544      | 20.17    |
| K000687      | 53877      | 20.7     | SP9669      | 54536      | 20.16    |
| K000696      | 53876      | 20.7     | SP9670      | 54534      | 20.15    |
| K000935      | 54685      | 20.12    | SZ 1114     | 52595      | 20.30    |
| K000944      | 54178      | 20.10    | SZ 1115     | 52594      | 20.30    |
| K000945      | 53880      | 20.7     | SZ 11159    | 52593      | 20.30    |
| K001274      | 53887      | 20.9     | SZ 1124     | 52595      | 20.30    |
| K001300      | 53881      | 20.8     | SZ 1130     | 52595      | 20.30    |
| K001301      | 54072      | 20.10    | SZ 1161     | 52595      | 20.30    |
| K001532      | 54071      | 20.10    | SZ 1200     | 54704      | 20.30    |
| K001915      | 54684      | 20.11    | SZ 1200     | 54706      | 20.30    |
| K001925      | 54070      | 20.10    | SZ 1208     | 54703      | 20.30    |
| K001928      | 54524      | 20.11    | W4630131100 | 52674      | 20.29    |
| K001929      | 54523      | 20.11    | W4630131140 | 52675      | 20.29    |
| K003902      | 54525      | 20.11    | W9343000030 | 52676      | 20.29    |
| K004100      | 54526      | 20.11    | -           | 55295      | 20.1     |
| K010603      | 54167      | 20.10    | -           | 55296      | 20.1     |
| K010604      | 54168      | 20.10    | -           | 55297      | 20.1     |
| MCK1086      | 54170      | 20.14    | -           | 55298      | 20.1     |
| MCK1102      | 54550      | 20.18    | -           | 55299      | 20.1     |
| MCK1102/N    | 53867      | 20.12    | -           | 55300      | 20.1     |
| MCK1103      | 54529      | 20.15    | -           | 55301      | 20.1     |
| MCK1116      | 54551      | 20.18    | -           | 55305      | 20.1     |
| MCK1118      | 54556      | 20.19    | -           | 55306      | 20.1     |
| MCK1134      | 54530      | 20.15    | -           | 55307      | 20.1     |
| MCK1135      | 54553      | 20.19    | -           | 55308      | 20.1     |
| MCK1139      | 53870      | 20.13    | -           | 55309      | 20.1     |
| MCK1171      | 53872      | 20.13    | -           | 55310      | 20.1     |
| MCK1171/N    | 53866      | 20.12    | -           | 55311      | 20.1     |
| MCK1192      | 53873      | 20.13    | -           | 55312      | 20.1     |
| MCK1213      | 54549      | 20.18    | -           | 55313      | 20.1     |
| MCK1238      | 53871      | 20.13    | -           | 55314      | 20.1     |



| Auger Nr. | O.E.M. Nr. | Page Nr. | Auger Nr. | O.E.M. Nr. | Page Nr. |
|-----------|------------|----------|-----------|------------|----------|
| -         | 55315      | 20.1     | -         | 54769      | 20.31    |
| -         | 55316      | 20.1     | -         | 55387      | 20.32    |
| -         | 55294      | 20.2     | -         | 55388      | 20.32    |
| -         | 55302      | 20.2     | -         | 55389      | 20.32    |
| -         | 55303      | 20.2     | -         | 55390      | 20.32    |
| -         | 55304      | 20.2     | -         | 55391      | 20.32    |
| -         | 55317      | 20.2     | -         | 55392      | 20.32    |
| -         | 55318      | 20.2     | -         | 55393      | 20.32    |
| -         | 55319      | 20.2     | -         | 55394      | 20.32    |
| -         | 55320      | 20.2     | -         | 55395      | 20.32    |
| -         | 55321      | 20.2     | -         | 55396      | 20.32    |
| -         | 55322      | 20.2     | -         | 55397      | 20.32    |
| -         | 55323      | 20.2     | -         | 55398      | 20.32    |
| -         | 55324      | 20.2     | -         | 55399      | 20.32    |
| -         | 55325      | 20.2     | -         | 55400      | 20.32    |
| -         | 55326      | 20.2     | -         | 55401      | 20.32    |
| -         | 55327      | 20.2     | -         | 55402      | 20.32    |
| -         | 55328      | 20.2     | -         | 55403      | 20.32    |
| -         | 55329      | 20.2     | -         | 55404      | 20.32    |
| -         | 55330      | 20.2     | -         | 55405      | 20.32    |
| -         | 55384      | 20.2     | -         | 55406      | 20.32    |
| -         | 55286      | 20.22    | -         | 55407      | 20.32    |
| -         | 21002      | 20.24    | -         | 55408      | 20.32    |
| -         | 21018      | 20.27    | -         | 55409      | 20.32    |
| -         | 21020      | 20.27    | -         | 55410      | 20.32    |
| -         | 54770      | 20.28    | -         | 55411      | 20.32    |
| -         | 54771      | 20.28    | -         | 55412      | 20.32    |
| -         | 54772      | 20.28    | -         | 54751      | 20.33    |
| -         | 54773      | 20.28    | -         | 54752      | 20.33    |
| -         | 54774      | 20.28    | -         | 54753      | 20.33    |
| -         | 54775      | 20.28    | -         | 54754      | 20.33    |
| -         | 54776      | 20.28    | -         | 54755      | 20.33    |
| -         | 54777      | 20.28    | -         | 54756      | 20.33    |
| -         | 54778      | 20.28    | -         | 54757      | 20.33    |
| -         | 54779      | 20.28    | -         | 54758      | 20.33    |
| -         | 54780      | 20.28    | -         | 54759      | 20.33    |
| -         | 54781      | 20.28    | -         | 54760      | 20.33    |
| -         | 55385      | 20.28    | -         | 54761      | 20.33    |
| -         | 55386      | 20.28    | -         | 54762      | 20.33    |
| -         | 54782      | 20.29    | -         | 54763      | 20.33    |
| -         | 55331      | 20.3     | -         | 54764      | 20.33    |
| -         | 55332      | 20.3     | -         | 54765      | 20.33    |
| -         | 55333      | 20.3     | -         | 54766      | 20.33    |
| -         | 55334      | 20.3     | -         | 54715      | 20.34    |
| -         | 55335      | 20.3     | -         | 54716      | 20.34    |
| -         | 55336      | 20.3     | -         | 54721      | 20.34    |
| -         | 55337      | 20.3     | -         | 54722      | 20.34    |
| -         | 55338      | 20.3     | -         | 54723      | 20.34    |
| -         | 55339      | 20.3     | -         | 54724      | 20.34    |
| -         | 55340      | 20.3     | -         | 54729      | 20.34    |
| -         | 55341      | 20.3     | -         | 54730      | 20.34    |
| -         | 55342      | 20.3     | -         | 54731      | 20.34    |
| -         | 55343      | 20.3     | -         | 54732      | 20.34    |
| -         | 55346      | 20.3     | -         | 54733      | 20.34    |
| -         | 54767      | 20.31    | -         | 54734      | 20.34    |
| -         | 54768      | 20.31    | -         | 52523      | 20.35    |





| Auger Nr. | O.E.M. Nr. | Page Nr. | Auger Nr. | O.E.M. Nr. | Page Nr. |
|-----------|------------|----------|-----------|------------|----------|
| -         | 54708      | 20.35    | -         | 54701      | 20.39    |
| -         | 54709      | 20.35    | -         | 55344      | 20.4     |
| -         | 54710      | 20.35    | -         | 55345      | 20.4     |
| -         | 54711      | 20.35    | -         | 55347      | 20.4     |
| -         | 54712      | 20.35    | -         | 55348      | 20.4     |
| -         | 54713      | 20.35    | -         | 55349      | 20.4     |
| -         | 54714      | 20.35    | -         | 55350      | 20.4     |
| -         | 55413      | 20.35    | -         | 55351      | 20.4     |
| -         | 55414      | 20.35    | -         | 55352      | 20.4     |
| -         | 55415      | 20.35    | -         | 55353      | 20.4     |
| -         | 55416      | 20.35    | -         | 55354      | 20.4     |
| -         | 55417      | 20.35    | -         | 55355      | 20.4     |
| -         | 55418      | 20.35    | -         | 55356      | 20.4     |
| -         | 55419      | 20.35    | -         | 55357      | 20.4     |
| -         | 55420      | 20.35    | -         | 55358      | 20.4     |
| -         | 54743      | 20.36    | -         | 53045      | 20.40    |
| -         | 54744      | 20.36    | -         | 53046      | 20.40    |
| -         | 54745      | 20.36    | -         | 53047      | 20.40    |
| -         | 54746      | 20.36    | -         | 53048      | 20.40    |
| -         | 54747      | 20.37    | -         | 53049      | 20.40    |
| -         | 54748      | 20.37    | -         | 55359      | 20.5     |
| -         | 54749      | 20.37    | -         | 55360      | 20.5     |
| -         | 54750      | 20.37    | -         | 55361      | 20.5     |
| -         | 54719      | 20.38    | -         | 55362      | 20.5     |
| -         | 54720      | 20.38    | -         | 55363      | 20.5     |
| -         | 54727      | 20.38    | -         | 55364      | 20.5     |
| -         | 54728      | 20.38    | -         | 55365      | 20.5     |
| -         | 54735      | 20.38    | -         | 55366      | 20.5     |
| -         | 54736      | 20.38    | -         | 55367      | 20.5     |
| -         | 54737      | 20.38    | -         | 55368      | 20.5     |
| -         | 54738      | 20.38    | -         | 55369      | 20.5     |
| -         | 54739      | 20.38    | -         | 55370      | 20.5     |
| -         | 54740      | 20.38    | -         | 55371      | 20.5     |
| -         | 54741      | 20.38    | -         | 55372      | 20.5     |
| -         | 54742      | 20.38    | -         | 55373      | 20.6     |
| -         | 21900      | 20.39    | -         | 55374      | 20.6     |
| -         | 21901      | 20.39    | -         | 55375      | 20.6     |
| -         | 21902      | 20.39    | -         | 55376      | 20.6     |
| -         | 21903      | 20.39    | -         | 55377      | 20.6     |
| -         | 21904      | 20.39    | -         | 55378      | 20.6     |
| -         | 21905      | 20.39    | -         | 55379      | 20.6     |
| -         | 21906      | 20.39    | -         | 55380      | 20.6     |
| -         | 21907      | 20.39    | -         | 55381      | 20.6     |
| -         | 21908      | 20.39    | -         | 55382      | 20.6     |
| -         | 21909      | 20.39    | -         | 55383      | 20.6     |
| -         | 21910      | 20.39    |           |            |          |
| -         | 21911      | 20.39    |           |            |          |
| -         | 21912      | 20.39    |           |            |          |
| -         | 54693      | 20.39    |           |            |          |
| -         | 54694      | 20.39    |           |            |          |
| -         | 54695      | 20.39    |           |            |          |
| -         | 54696      | 20.39    |           |            |          |
| -         | 54697      | 20.39    |           |            |          |
| -         | 54698      | 20.39    |           |            |          |
| -         | 54699      | 20.39    |           |            |          |
| -         | 54700      | 20.39    |           |            |          |



# 08







## JOST









| Auger Nr.    | OEM Nr.    | Description                        | Model  | Picture  |
|--------------|------------|------------------------------------|--|--|
| <b>54075</b> | SK 2121-69 | Rep. Kit for Bearing<br>161x177x65 | JSK 37 C<br>JSK 37 CW<br>JSK 37 C-Z<br>LP 37 CZ<br>DR 37 C-Z<br>SO 37 C-Z  |  <p>53113<br/>53114</p> |
| <b>54077</b> | SK 2421-78 | Rep. Kit for Bearing<br>191x240x66 | JSK 38 C1 / C1- 2/ ...Z<br>JSK 38 MC / MC- 2/ ...Z<br>LP 38 C<br>DR 38 C-1, DR 38 C-2, DR 38 C-3<br>DR 38 C-1/160, DR 38 C-2/160,<br>DR 38 C-3/160<br>JSK 38 C-1<br>JSK 38 C-1-2<br>JSK 38 C-3   |  <p>54073<br/>54074</p> |
| <b>53113</b> | SK 1259    | Rubber Mounting<br>161x177x65      | JSK 37 C<br>JSK 37 CW<br>JSK 36 CV<br>JSK 37 C-Z<br>LP 36 CV<br>LP 37 CZ<br>DR 36 CV<br>DR 37 C-Z  |                        |
| <b>53114</b> | SK 2105-25 | Rubber Mounting<br>105x115x16      | JSK 37 C<br>JSK 37 CW<br>JSK 36 CV<br>JSK 37 C-Z<br>LP 36 CV<br>LP 37 CZ<br>DR 36 CV<br>DR 37 C-Z  |                       |
| <b>54073</b> | SK 2006    | Rubber Mounting<br>191x240x66      | JSK 38 C1 / C1- 2 / ...Z<br>JSK 38 MC / MC- 2 / ...Z<br>LP 38 C<br>DR 38 C-1, DR 38 C-2, DR 38 C-3<br>DR 38 C-1/160, DR 38 C-2/160,<br>DR 38 C-3/160<br>JSK 38 C-1<br>JSK 38 C-1-2<br>JSK 38 C-3 |                       |
| <b>54074</b> | SK 2007    | Rubber Mounting<br>150x184x38.5    | JSK 38 C1 / C1- 2 / ...Z<br>JSK 38 MC / MC- 2 / ...Z<br>LP 38 C<br>DR 38 C-1, DR 38 C-2, DR 38 C-3<br>DR 38 C-1/160, DR 38 C-2/160,<br>DR 38 C-3/160<br>JSK 38 C-1<br>JSK 38 C-1-2<br>JSK 38 C-3 |                       |

| Auger Nr.    | OEM Nr.       | Description                                 | Model  | Picture   |
|--------------|---------------|---|--|---|
| <b>53865</b> | SK 2121-53    | Rep. Kit for Bearing<br><br>ø71xø110x55     | JSK 36 A / 37 A / 37-15 A  |    |
| <b>54089</b> | SK 3121-61    | Rep. Kit for Bearing<br><br>ø49.5xø70x102   | JSK 37 E<br>JSK 37 EW<br>JSK 37 EA<br>JSK 37 EAW<br>JSK 37 ER<br>JSK 37 ERW<br>JSK 37 ME140<br>JSK 37 ME140W |    |
| <b>54097</b> | SK 3121-58    | Rep. Kit for Bearing<br><br>ø49.5xø70x102   | JSK 37 E<br>JSK 37 EA<br>JSK 37 ME140  |   |
| <b>54098</b> | SKE 001370220 | Rep. Kit for Bearing<br><br>M20x2.5/79.5    | JSK 42<br>JSK 42 K2 - K6<br>JSK 42/42 MK   |  |
| <b>54099</b> | SK 2521-76    | Rep. Kit for Bearing<br><br>ø95.5xø105x93.5 | JSK 38 G1 / G1-2/ ...Z   |  |
| <b>55160</b> | SKE 001940001 | Rep. Kit for Bearing                        | JSK 42 K7<br>JSK 42 K8   |  |

| Auger Nr.    | OEM Nr.       | Description                                     | Model  | Picture   |
|--------------|---------------|---|--|---|
| <b>55167</b> | SK 2621-02    | Rep. Kit for Bearing<br><br>M20x1.5/ø26x121     | JSK 3-2  |    |
| <b>54092</b> | SK 3121-063   | Rep. Kit for Handle<br>Extension Complete       | JSK 37 C<br>JSK 37 CW<br>JSK 37 E<br>JSK 37 EW<br>JSK 37 EA<br>JSK 37 EAW<br>JSK 37 ER<br>JSK 37 ERW<br>JSK 37 ME140W<br>JSK 38 C1 / C1- 2"/ ...Z<br>JSK 38 G1 / G1-2"/ ...Z<br>JSK 38 MC / MC- 2"/ ...Z<br>JSK 50 |    |
| <b>54105</b> | SK 3106-003   | Rep. Kit Countersunk<br>With Bolt               | JSK 37 CW<br>JSK 37 EW<br>JSK 37 EAW<br>JSK 37 ERW<br>JSK 37 ME140W  |  |
| <b>55166</b> | SKE 001007020 | Rep. Kit Countersunk<br>With Bolt               | JSK 42<br>JSK 42 K2 - K6<br>JSK 42 K8<br>JSK 42/42 MK  |  |
| <b>54076</b> | SK 2121-15    | Rep. Kit for Bolt<br>Assembly<br><br>M16x2/110  | JSK 37 C<br>JSK 37 CW<br>JSK 37 C-Z<br>LP 37 CZ<br>DR 37 C-Z<br>SO 37 C-Z  |  |
| <b>54078</b> | SK 2421-55    | Rep. Kit for Bolt<br>Assembly<br><br>M20x2.5/45 | JSK 38 C1 / C1- 2/ ...Z<br>JSK 38 MC / MC- 2/ ...Z<br>LP 38 C<br>DR 38 C-1, DR 38 C-2, DR 38 C-3<br>DR 38 C-1/160, DR 38 C-2/160,<br>DR 38 C-3/160<br>JSK 38 C-1<br>JSK 38 C-1-2<br>JSK 38 C-3                     |  |

| Auger Nr.    | OEM Nr.     | Description                                   | Model   | Picture   |
|--------------|-------------|---|---|---|
| <b>54100</b> | SK 3353-009 | Rep. Kit for Bolt Assembly<br><br>M10x1.5/25  | DR 37 G-240-16<br>JSK 37 G<br>LP 37 G-240-16 -2   |    |
| <b>54101</b> | SK 1513     | Rep. Kit for Bolt Assembly<br><br>M16x2/40    | JSK 36 DA<br>JSK 36 DV<br>JSK 37 C<br>JSK 37 CW<br>JSK 37 E<br>JSK 37 EW<br>JSK 37 EA<br>JSK 37 EAW<br>JSK 37 ER<br>JSK 37 ERW<br>JSK 37 ME140<br>JSK 37 ME140W   |    |
| <b>54102</b> | SK 2421-50  | Rep. Kit for Bolt Assembly<br><br>M10x1.5/35  | JSK 36 DA<br>JSK 36 DV<br>JSK 37 C<br>JSK 37 CW<br>JSK 37 E<br>JSK 37 EW<br>JSK 37 EA<br>JSK 37 EAW<br>JSK 37 ER<br>JSK 37 ERW<br>JSK 37 ME140<br>JSK 37 ME140W<br>JSK 38 C1 / C1- 2/ ...Z<br>JSK 38 G1 / G1-2/ ...Z<br>JSK 38 MC / MC- 2/ ...Z<br>JSK 50 |  |
| <b>54103</b> | SK 3121-071 | Rep. Kit for Bolt Assembly<br><br>M12x1.75/25 | JSK 37 E<br>JSK 37 EW<br>JSK 37 EA/EAW<br>JSK 37 ER<br>JSK 37 ERW<br>JSK 37 ME140<br>JSK 37 ME140W  |  |
| <b>54104</b> | SK 3221-01  | Rep. Kit for Bolt Assembly<br><br>M20x2.5/95  | JSK 37 C<br>JSK 37 CW<br>JSK 37 E<br>JSK 37 EW<br>JSK 37 EA<br>JSK 37 EAW<br>JSK 37 ER<br>JSK 37 ERW<br>JSK 37 ME140<br>JSK 37 ME140W   |  |



| Auger Nr.    | OEM Nr.       | Description                                   | Model  | Picture   |
|--------------|---------------|---|--|---|
| <b>54107</b> | SK 870-1      | Rep. Kit for Bolt Assembly<br><br>M20x2.5/120 | JSK 36 A / 37 A / 37-15 A  |    |
| <b>54126</b> | SK 3105-20    | Tension Spring<br><br>ø47x144                 | JSK 36 DA/DV<br>JSK 37<br>C/CW/E/EW/EA/EAW/ER/ERW/ME<br>140/ME140W<br>JSK 42<br>JSK 42 K2-K6<br>JSK 42 K7 (Scania)<br>JJSK 42 K8 (Volvo)<br>JSK 42/42 MK |    |
| <b>55156</b> | SKE 001009800 | Tension Spring<br><br>ø23.5x57                | JSK 42<br>JSK 42 K2-K6<br>JSK 42 K7<br>JSK 42 K8<br>JSK 42 / 42 MK<br>JSK 40 / 40W<br>JSK 42 / 42W   |  |
| <b>55157</b> | SKE 001440000 | Tension Spring<br><br>ø16x105                 | JSK 42<br>JSK 42 K2-K6<br>JSK 42 K7<br>JSK 42 K8<br>JSK 42 / 42 MK<br>JSK 40 / 40W<br>JSK 42 / 42W   |  |
| <b>55155</b> | SK 2604-04    | Plastic Bushing<br><br>ø26xø32x60             | JSK 3-2  |  |



# 09





**ROCKINGER  
RINGFEDER  
SCHMITZ**





| Auger Nr.    | OEM Nr.  | Description                                   | Model                   | Picture   |
|--------------|----------|---|-------------------------|---|
| <b>54138</b> | ROE67855 | Rep. Kit for Towing Hitch<br><br>ø41xø75.5x17 | RO256                   |    |
| <b>54139</b> | ROE67859 | Rep. Kit for Towing Hitch<br><br>ø52xø97x22.5 | RO263                   |    |
| <b>54140</b> | ROE67472 | Rep. Kit for Towing Hitch<br><br>ø42xø91.5x20 | RO42<br>RO285<br>RO260  |   |
| <b>54141</b> | ROE25475 | Rep. Kit for Towing Hitch<br><br>ø64xø102x20  | RO430<br>RO433<br>RO530 |  |
| <b>54142</b> | ROE67056 | Rep. Kit for Towing Hitch<br><br>ø42xø91.5x20 | RO225/227               |  |
| <b>54143</b> | ROE70172 | Rep. Kit for Towing Hitch<br><br>ø37xø75x16   | RO225/227               |  |





| Auger Nr.    | OEM Nr.  | Description                                       | Model                   | Picture   |
|--------------|----------|---|-------------------------|---|
| <b>54144</b> | ROE70432 | Rep. Kit for Towing Hitch<br><br>ø66xø102.5x26.5  | RO700<br>RO700 E        |    |
| <b>54145</b> | ROE25476 | Rep. Kit for Towing Hitch<br><br>ø41.5xø87.5x21   | RO400<br>RO500          |    |
| <b>54146</b> | ROE70043 | Rep. Kit for Towing Hitch<br><br>ø35              | RO42                    |   |
| <b>54147</b> | ROE70625 | Rep. Kit for Towing Hitch<br><br>ø35              | RO42                    |  |
| <b>54148</b> | ROE70089 | Rep. Kit for Towing Hitch<br><br>ø105.5xø121x22.5 | RO715 A<br>RO715 E      |  |
| <b>54149</b> | ROE59277 | Rep. Kit for Towing Hitch<br><br>ø104xø110x20     | RO430<br>RO433<br>RO530 |  |

| Auger Nr.    | OEM Nr.  | Description                                    | Model                         | Picture   |
|--------------|----------|--|-------------------------------|---|
| <b>55178</b> | ROE25477 | Rep. Kit for Towing Hitch<br><br>ø50           | RO400<br>RO500                |    |
| <b>53864</b> | ROE67471 | Rep. Kit for Towing Hitch<br><br>ø52xø97x22    | RO42<br>RO285<br>RO260        |    |
| <b>53863</b> | ROE25345 | Rep. Kit for Towing Hitch<br><br>ø60.5xø109x24 | RO500                         |   |
| <b>54682</b> | ROE71124 | Rep.Kit for Towing Hitch                       | RO400<br>RO430<br>RO841 (460) |  |
| <b>54683</b> | ROE71125 | Rep.Kit for Towing Hitch                       | RO500<br>RO530<br>RO560       |  |
| <b>55177</b> | ROE53019 | Metal Bushing<br><br>ø48xø68x55.5              | RO56/561 (ABG VERSION)        |  |

| Auger Nr.    | OEM Nr.  | Description                     | Model | Picture   |
|--------------|----------|---------------------------------|-------|---|
| <b>53175</b> | ROE53386 | Metal Bushing<br>ø40xø48x29.3   | -     |    |
| <b>53176</b> | R53206   | Metal Bushing<br>ø40xø48.5x29.3 | -     |    |
| <b>53177</b> | R53207   | Metal Bushing<br>ø40xø49x29.3   | -     |   |
| <b>53178</b> | R53208   | Metal Bushing<br>ø40xø49.5x29.3 | -     |  |
| <b>53179</b> | R53209   | Metal Bushing<br>ø40xø50x29.3   | -     |  |
| <b>53180</b> | ROE53376 | Metal Bushing<br>ø50xø60x45     | -     |  |



| Auger Nr.    | OEM Nr.  | Description                       | Model                  | Picture   |
|--------------|----------|-----------------------------------|------------------------|---|
| <b>53181</b> | R53362   | Metal Bushing<br>ø50xø60.5x45     | -                      |    |
| <b>53182</b> | R53363   | Metal Bushing<br>ø50xø61x45       | -                      |    |
| <b>54127</b> | ROE53367 | Metal Bushing<br>ø49xø64x46       | RO715 A<br>RO715 E     |   |
| <b>54130</b> | ROE53244 | Metal Bushing<br>ø38/ø46xø75x63.5 | RO56/561 (ABG-VERSION) |  |
| <b>54128</b> | ROE53051 | Metal Bushing<br>ø41xø49x30       | RO480/483/580          |  |
| <b>54129</b> | ROE53004 | Metal Bushing<br>ø50.5xø60.5x46   | RO480/483/580          |  |







| Auger Nr.    | OEM Nr.  | Description                      | Model                           | Picture   |
|--------------|----------|----------------------------------|---------------------------------|---|
| <b>54133</b> | ROE52011 | Bolt for Towing Hitch<br>ø18x113 | RO56/561 (ABG-VERSION)          |    |
| <b>54134</b> | ROE52009 | Bolt for Towing Hitch<br>ø18x139 | RO56/561 (ABG-VERSION)          |    |
| <b>54135</b> | ROE52002 | Bolt for Towing Hitch<br>ø20x117 | RO56/561 (ABG-VERSION)          |   |
| <b>54131</b> | ROE55008 | Tension Spring<br>ø30x99         | RO256                           |  |
| <b>54132</b> | ROE55005 | Tension Spring<br>ø32.5x129      | RO56/561 (ABG-VERSION)<br>RO256 |  |

# 09 RINGFEDER



| Auger Nr.    | OEM Nr.  | Description                        | Model | Picture   |
|--------------|----------|------------------------------------|-------|---|
| <b>52596</b> | 14994568 | Rubber Mounting<br>ø63xø110x26.5   | -     |    |
| <b>52597</b> | 01027204 | Rubber Mounting<br>ø58.5xø110x26.5 | -     |    |
| <b>52598</b> | 14994876 | Plastic Bushing<br>ø62.5xø67x71.5  | -     |   |
| <b>52599</b> | 223905   | Plastic Bushing<br>ø59xø67x64.5    | -     |  |

| Auger Nr.    | OEM Nr.   | Description   | Model      | Picture   |
|--------------|-----------|---|------------|---|
| <b>52108</b> | 750841    | Rubber Bushing for Spring<br><br>ø50xø100.5x130                                       | -          |    |
| <b>52750</b> | 028158BHC | Rubber Bushing for Spring<br><br>ø30xø69x102  | -          |    |
| <b>21010</b> | -         | Service Brake Chamber (for drum brake)  | T16 STR 75 |   |
| <b>21011</b> | 051007    | Service Brake Chamber (for drum brake) (with repair kit)<br><br>112.5/353xM16x1.5x164 | T16 STR 75 |  |
| <b>21012</b> | -         | Service Brake Chamber (for drum brake)<br><br>113/126xM16x1.5x174                     | T20 STR 75 |  |
| <b>21013</b> | 051009    | Service Brake Chamber (for drum brake) (with repair kit)<br><br>113/353xM16x1.5x174   | T20 STR 75 |  |

| Auger Nr.    | OEM Nr.                   | Description  | Model            | Picture   |
|--------------|---------------------------|--|------------------|---|
| <b>21014</b> | -                         | Service Brake Chamber<br>(for drum brake)<br><br>112.5/126xM16x1.5x186                                 | T24 STR 75       |    |
| <b>21015</b> | 051012                    | Service Brake Chamber<br>(for drum brake)<br>(with repair kit)<br><br>112.5/353xM16x1.5x186            | T24 STR 75       |    |
| <b>21016</b> | -                         | Service Brake Chamber<br>(for drum brake)<br><br>117.5/131xM16x1.5x208                                 | T30 STR 75       |   |
| <b>21017</b> | 051017<br>8.283.050.000.0 | Service Brake Chamber<br>(for drum brake)<br>(with repair kit)<br><br>117.5/358xM16x1.5x208            | T30 STR 75       |  |
| <b>21018</b> | -                         | Double Diaphragm Brake<br>Chamber (for drum brake)<br><br>274.5/560.5xM16x1.5x208                      | T24-30 STR 75/75 |  |
| <b>21019</b> | 050408                    | Double Diaphragm Brake<br>Chamber (for drum brake)<br>(with repair kit)<br><br>274.5/602.5xM16x1.5x208 | T24-30 STR 75/75 |  |



| Auger Nr. | O.E.M. Nr. | Dia. | Capacity | Description |
|-----------|------------|------|----------|-------------|
| 21900     | 050457     | ø206 | 10 L     | -           |
| 21905     | 050458     | ø276 | 40 L     | -           |
| 21909     | 050460     | ø396 | 60 L     | -           |
| 21910     | 050461     | ø396 | 80 L     | -           |
| 21911     | 050462     | ø396 | 100 L    | -           |

# 13

## BERGISCHE ACHSEN







| Group                       | Page |
|-----------------------------|------|
| Spring Suspension . . . . . | 001  |
| Stabilizer . . . . .        | 008  |
| Brake . . . . .             | 009  |
| Axle & Wheel . . . . .      | 040  |
| Air Suspension . . . . .    | 047  |





| Auger Nr.    | OEM Nr.                        | Description                                     | Model                         | Picture   |
|--------------|--------------------------------|---|-------------------------------|---|
| <b>52103</b> | 05.113.90.06.0                 | Rubber Bushing for Spring<br><br>ø24xø50x68     | Trailing Arm ( width 100 mm ) |    |
| <b>52104</b> | 05.113.93.03.0                 | Rubber Bushing for Spring<br><br>ø36xø65.5xø68  | -                             |    |
| <b>52105</b> | 02.0316.06.00                  | Rubber Bushing for Spring<br><br>ø30xø60x102    | Trailing Arm ( width 100 mm ) |   |
| <b>52106</b> | 05.113.98.08.0                 | Rubber Bushing for Spring<br><br>ø40xø84x130    | -                             |  |
| <b>52108</b> | 02.0316.65.00<br>02.0316.05.00 | Rubber Bushing for Spring<br><br>ø50xø100.5x130 | VB-K, VB-C Series             |  |
| <b>52110</b> | 05.113.97.10.0                 | Rubber Bushing for Spring<br><br>ø60xø105x145   | -                             |  |

| Auger Nr.    | OEM Nr.        | Description                                  | Model                         | Picture   |
|--------------|----------------|--|-------------------------------|---|
| <b>52118</b> | 02.0316.90.00  | Rubber Bushing for Spring<br><br>ø30xø57x102 | Trailing Arm ( width 100 mm ) |    |
| <b>53947</b> | 02.0315.98.00  | Rubber Bushing for Spring<br><br>ø30xø60x72  | Trailing arm ( width 70 mm )  |    |
| <b>52315</b> | 03.113.02.05.0 | Bushing for Spring Pin<br><br>ø32xø58x30     | -                             |   |
| <b>52316</b> | 03.113.01.15.0 | Bushing for Spring Pin<br><br>ø30xø58x30     | -                             |  |
| <b>52317</b> | 03.200.34.05.0 | Bushing for Spring Pin<br><br>ø30.5xø50x29.5 | VB - C<br>VBT- C              |  |
| <b>52318</b> | 03.113.01.14.0 | Bushing for Spring Pin<br><br>ø30xø58x35     | -                             |  |

| Auger Nr.    | OEM Nr.        | Description                                      | Model   | Picture   |
|--------------|----------------|--|---|---|
| <b>52319</b> | 03.200.34.03.0 | Bushing for Spring Pin<br><br>ø30xø50x43.5       | VBT-C   |    |
| <b>52320</b> | 03.113.02.04.0 | Bushing for Spring Pin<br><br>ø32xø58x35         | -   |    |
| <b>52334</b> | 03.113.02.06.0 | Bushing for Spring Pin<br><br>ø30.5xø54.5x24     | Trailing arm ( width 100 mm )   |  |
| <b>53508</b> | 03.113.01.34.0 | Bushing for Spring Pin<br><br>ø30.5xø56x29       | Trailing arm ( width 100 mm )   |  |
| <b>53965</b> | 03.113.23.01.0 | Bushing for Spring Pin<br><br>30.5/42.5xø73.5x24 | Trailing arm ( width 100 mm )<br>Trailing arm ( width 70 mm )<br>(Airlight II ) |  |



| Auger Nr.    | O.E.M. Nr.   | A       | B     | C     | D    | Type | Repair Kit  |
|--------------|--|---------|-------|-------|------|------|---|
| <b>54025</b> | 03.3410.50.30  | M30x3.5 | 202.5 | 30.5  | -    | 1    | 53523-53526-53527   |
| <b>54026</b> | 03.3410.50.50  | M30x3.5 | 173   | 30.5  | -    | 1    | 53538-53546   |
| <b>54028</b> | 03.3410.50.40  | M30x3.5 | 202   | 30.5  | -    | 1    | 53537-53545   |
| <b>54027</b> | 03.1771.62.50  | M42x3   | 232   | ø50   | -    | 2    | 53542   |
| <b>54030</b> | 03.1771.62.80  | M42x3   | 230.5 | ø60   | -    | 2    | 53549   |
| <b>54031</b> | 03.1771.62.90  | M42x3   | 242.5 | ø60   | -    | 2    | 53550   |
| <b>54033</b> | 03.3401.53.70  | M30x3.5 | 260   | SW46  | -    | 3    | 53544   |
| <b>54041</b> | 03.3401.52.30  | M30x3.5 | 210   | SW46  | -    | 3    | 53522   |
| <b>54042</b> | 03.3401.52.00 - 03.3401.52.70<br>03.3401.51.00 - 03.3401.50.80 | M30x3.5 | 190   | SW46  | -    | 3    | 53553   |
| <b>54051</b> | 02.5220.81.26<br>02.5220.81.82<br>03.2601.50.10                | M30x3.5 | 27.1  | SW46  | -    | 4    | 53522-53523-53526<br>53527-53537-53538<br>53544-53545-53546-53553 |
| <b>54056</b> | 02.5220.91.26  | M42x3   | 32.6  | SW65  | -    | 4    | 53542   |
| <b>54059</b> | 02.5207.46.04  | M42x3   | 23    | SW65  | -    | 4    | 53549-53550   |
| <b>54835</b> | 03.2815.41.40  | 31      | 72    | 103.5 | 8    | 5    | 53537   |
| <b>54836</b> | 03.2815.41.80  | 31      | 57.5  | 103.5 | 8    | 5    | 53545-53546   |
| <b>54837</b> | 03.1643.50.10  | ø30     | 121   | 125   | 11.5 | 6    | 53545   |
| <b>54838</b> | 03.1643.50.20  | ø30     | 121   | 126   | 14.5 | 6    | 53546   |
| <b>54917</b> | 03.1812.00.80  | ø30.5   | 50    | 59    | 20.5 | 7    | 53537   |
| <b>54920</b> | 05.1891.31.90  | ø50.5   | 155   | 184.5 | -    | 8    | 53544   |

| Auger Nr.    | OEM Nr.                            | Description   | Model  | Picture   |
|--------------|------------------------------------|---|--|---|
| <b>53526</b> | 09.801.06.28.0                     | Rep. Kit Spring Bolt Assembly<br><br>ø30xø57x102    | Trailing arm ( width 100 mm )                  |    |
| <b>53527</b> | 09.801.06.29.0                     | Rep. Kit Spring Bolt Assembly<br><br>ø30xø60x102    | Trailing arm ( width 100 mm )                  |    |
| <b>53542</b> | 02.0316.65.00 S<br>02.0316.05.00 S | Rep. Kit Spring Bolt Assembly<br><br>ø50xø100.5x130 | -  |   |
| <b>53544</b> | 09.801.06.77.0                     | Rep. Kit Spring Bolt Assembly<br><br>ø30xø57x102    | Trailing arm ( width 100 mm )                  |  |
| <b>53545</b> | 05.857.00.15.0                     | Rep. Kit Spring Bolt Assembly<br><br>M30x3.5/202    | Trailing arm ( width 100 mm )                  |  |
| <b>53546</b> | 05.857.00.18.0                     | Rep. Kit Spring Bolt Assembly<br><br>M30x3.5/173    | Trailing arm ( width 70 mm )<br>(Airlight II ) |  |

| Auger Nr.    | OEM Nr.          | Description                                      | Model                         | Picture   |
|--------------|------------------|--|-------------------------------|---|
| <b>53537</b> | 05.857.00.09.0   | Rep. Kit Spring Bolt Assembly<br><br>M30x3.5/202 | Trailing arm ( width 100 mm ) |    |
| <b>53522</b> | 05.857.00.04.0   | Rep. Kit Spring Bolt Assembly<br><br>M30x3.5/210 | Trailing arm ( width 100 mm ) |    |
| <b>53523</b> | 05.857.00.12.0   | Rep. Kit Spring Bolt Assembly<br><br>M30x3.5/202 | Trailing arm ( width 100 mm ) |   |
| <b>53538</b> | 03.341.05.05.0 S | Rep. Kit Spring Bolt Assembly<br><br>M30x3.5/173 | -                             |  |
| <b>53549</b> | 03.177.16.28.0 S | Spring Pin Set<br><br>M42x3/230                  | -                             |  |
| <b>53550</b> | 03.177.16.29.0 S | Spring Pin Set<br><br>M42x3/242.5                | -                             |  |
| <b>53553</b> | 05.857.00.03.0   | Rep. Kit Spring Bolt Assembly<br><br>M30x3.5/190 | Trailing arm ( width 100 mm ) |  |

| Auger Nr.    | OEM Nr.  | Description  | Model | Picture   |
|--------------|--|--|-------|---|
| <b>52167</b> | 03.181.90.10.0                                     | Slider<br>59/90x25                                     | -     |    |
| <b>52168</b> | 03.181.90.06.0<br>03.181.90.06.1<br>03.181.90.02.0 | Slider<br>112/158x64                                   | -     |    |
| <b>52169</b> | 03.181.90.05.0<br>03.181.90.01.0                   | Slider<br>69/74x109                                    | -     |  |
| <b>52100</b> | 05.353.67.09.0<br>03.353.67.09.0                   | Grip Head for Axle Rod,<br>Left<br><br>ø30/M36x2Lx198  | -     |  |
| <b>52101</b> | 05.353.67.08.0<br>03.353.67.08.0                   | Grip Head for Axle Rod,<br>Right<br><br>ø30/M36x2Rx198 | -     |  |





| Auger Nr. | O.E.M. Nr.   | A       | B    | C    | Type | Repair Kit  |
|-----------|--|---------|------|------|------|-------------|
| 54042     | 03.340.15.20.0 - 03.340.15.08.0 - 03.340.15.10.0 - 03.3401.52.70 | M30x3.5 | 190  | SW46 | 1    | 53541       |
| 54789     | 03.340.15.22.0   | M30x3.5 | 120  | SW46 | 1    | 52119       |
| 54051     | 03.260.15.01.0 - 02.5220.81.26 - 02.5220.81.82                   | M30x3.5 | 27.1 | SW46 | 2    | 52119-53541 |

| Auger Nr. | OEM Nr. | Description | Model | Picture |
|-----------|---------|-------------|-------|---------|
|-----------|---------|-------------|-------|---------|

|              |                                  |  |   |   |
|--------------|----------------------------------|--|---|---|
| <b>52116</b> | 03.113.98.06.0<br>03.113.96.04.0 | Stabilizer Plastic Bearing<br><br>ø50x94 | - |  |
|--------------|----------------------------------|--|---|---|

|              |   |  |     |  |
|--------------|---|--|-----|--|
| <b>52119</b> | - | Stabilizer Bearing Kit<br><br>ø30xø52.5x68 | --- |  |
|--------------|---|--|-----|--|







|              |                                      |  |   |   |
|--------------|--------------------------------------|--|---|---|
| <b>53541</b> | 05.113.96.05.0 S<br>02.031.60.10.0 S | Stabilizer Bearing Kit<br><br>ø36xø60x68 | - |  |
|--------------|--------------------------------------|--|---|---|

|              |                                  |   |   |   |
|--------------|----------------------------------|---|---|---|
| <b>52102</b> | 05.113.96.05.0<br>02.031.60.10.0 | Stabilizer Rubber Bushing<br><br>ø36xø60x68 | - |  |
|--------------|----------------------------------|---|---|---|







|              |                                  |   |                 |   |
|--------------|----------------------------------|---|-----------------|---|
| <b>52107</b> | 05.113.96.06.0<br>05.113.93.02.0 | Stabilizer Rubber Bushing<br><br>ø30xø52.5x68 | VBU, VBQ Series |  |
|--------------|----------------------------------|---|-----------------|---|

|              |  |                           |   |   |
|--------------|--|---------------------------|---|---|
| <b>54435</b> | 05.113.96.05.0 S1<br>02.031.60.10.0 S1 | Stabilizer Rubber Bushing | - |  |
|--------------|--|---------------------------|---|---|















| Auger Nr.    | OEM Nr.  | Description                        | Model   | Picture   |
|--------------|--|------------------------------------|---|---|
| <b>52296</b> | 05.397.45.10.0<br>03.397.45.10.0                   | Brake Shoe Spring<br><br>ø21.5x106 | K Series (SN 36..)  |    |
| <b>52300</b> | 03.397.34.01.0                                     | Brake Shoe Spring<br><br>ø20.5x100 | -   |    |
| <b>52301</b> | 05.397.46.07.0<br>05.397.46.06.0<br>05.397.45.01.0 | Brake Shoe Spring<br><br>ø25x261   | H Series (SN 42..)<br>H..LL Series (SN 42..)<br>H (M) ..L Series (SN 42..)  |   |
| <b>52310</b> | 05.397.28.01.0                                     | Return Spring<br><br>29.5x120      | H Series (SN 42..)<br>K Series (SN 36..)<br>N Series (SN 30..)<br>H..LL Series (SN 42..)<br>K..LL Series (SN 36..)<br>N..LL Series (SN 30..)<br>H (M)..L Series (SN 42..)<br>K..L Series (SN 36..)<br>N..L Series (SN 30..) |  |
| <b>52311</b> | 05.397.45.05.0<br>05.397.45.04.0                   | Brake Shoe Spring<br><br>ø22x155   | -   |  |
| <b>52312</b> | 05.397.46.12.0                                     | Brake Shoe Spring<br><br>24x166    | N Series (SN 30..)  |  |

| Auger Nr.    | OEM Nr.  | Description                    | Model  | Picture   |
|--------------|--|--------------------------------|--|---|
| <b>52313</b> | 03.397.44.06.0                                     | Brake Shoe Spring<br>ø21x105   | H Series (SN 42..)<br>K Series (SN 36..)<br>N Series (SN 30..)<br>H..LL Series (SN 42..)<br>K..LL Series (SN 36..)<br>H (M)..L Series (SN 42..)<br>K..L Series (SN 36..) |    |
| <b>52314</b> | 05.397.56.07.0<br>05.397.56.04.0<br>05.397.57.03.0 | Brake Shoe Spring<br>ø25x269   | H Series (SN 42..)   |    |
| <b>52758</b> | 03.397.33.07.0                                     | Brake Shoe Spring<br>ø18.5x118 | H Series (SN 42..)<br>K Series (SN 36..)<br>H..LL Series (SN 42..)<br>K..LL Series (SN 36..)<br>H (M)..L Series (SN 42..)<br>K..L Series (SN 36..)                       |   |
| <b>52759</b> | 03.397.33.06.0                                     | Brake Shoe Spring<br>ø18.5x125 | H Series (SN 42..)<br>K Series (SN 36..)<br>H..LL Series (SN 42..)<br>K..LL Series (SN 36..)<br>H (M)..L Series (SN 42..)<br>K..L Series (SN 36..)                       |  |
| <b>52760</b> | 05.397.26.03.0<br>05.397.27.01.0<br>05.397.36.05.0 | Return Spring<br>ø25.5x146     | H / H..LL / H (M)..L Series (SN42..)<br>K / K..LL / K..L Series (SN 36..)<br>N / N..LL / N..L Series (SN 30..)   |  |
| <b>52761</b> | 05.397.34.17.0                                     | Brake Shoe Spring<br>ø20x180   | N Series (SN 30..)   |  |





| Auger Nr.    | OEM Nr.        | Description       | Model   | Picture   |
|--------------|----------------|-------------------|---|---|
| <b>52762</b> | 05.397.35.03.0 | Brake Shoe Spring | N Series (SN 30..)                              |    |
|              | 05.397.35.01.0 | ø22.5x163         | N..LL Series (SN 30..)<br>N..L Series (SN 30..) |   |
| <b>52763</b> | 05.397.46.13.0 | Brake Shoe Spring | K Series (SN 36..)                              |    |
|              |                | ø24.5x235         | K..LL Series (SN 36..)<br>K..L Series (SN 36..) |   |
| <b>52764</b> | 05.397.45.14.0 | Brake Shoe Spring | K Series (SN 36..)                              |    |
|              | 05.397.35.02.0 |                   | K..LL Series (SN 36..)                          |   |
|              | 05.397.46.09.0 | ø23.5x216         | K..L Series (SN 36..)                           |   |
| <b>52765</b> | 05.397.26.02.0 | Return Spring     | H Series (SN 42..)                              |  |
|              |                |                   | K Series (SN 36..)                              |   |
|              |                | ø22.5x233         | N Series (SN 30..)                              |   |
|              |                |                   | H..LL Series (SN 42..)                          |   |
|              |                |                   | K..LL Series (SN 36..)                          |   |
|              |                |                   | N..LL Series (SN 30..)                          |   |
|              |                |                   | K..L Series (SN 36..)                           |   |
|              |                |                   | N..L Series (SN 30..)                           |   |
| <b>52766</b> | 05.397.58.03.0 | Brake Shoe Spring | H Series (SN 42..)                              |  |
|              |                |                   | H..LL Series (SN 42..)                          |   |
|              |                | ø35x272           | H (M)..L Series (SN 42..)                       |   |
| <b>52767</b> | 05.397.46.03.0 | Brake Shoe Spring | -   |  |
|              |                | ø24.5x263         |   |   |
| <b>52780</b> | 05.397.26.05.0 | Return Spring     | -   |  |
|              |                | ø22.5x180         |   |   |

| Auger Nr.    | OEM Nr.                          | Description                    | Model  | Picture   |
|--------------|----------------------------------|--------------------------------|--|---|
| <b>53506</b> | 03.397.34.10.0<br>03.397.34.11.0 | Brake Shoe Spring<br>ø21x178   | -  |    |
| <b>53513</b> | 03.397.33.08.0                   | Brake Shoe Spring<br>ø18.5x134 | N Series (SN 30..)   |    |
| <b>53514</b> | 03.397.33.09.0                   | Brake Shoe Spring<br>ø18.5x128 | N Series (SN 30..)   |   |
| <b>53516</b> | 03.397.44.10.0                   | Brake Shoe Spring<br>ø21x119   | K Series (SN 36..)   |  |
| <b>54001</b> | 03.397.35.05.0                   | Brake Shoe Spring<br>ø20x220   | -  |  |
| <b>54002</b> | 05.397.34.16.0                   | Brake Shoe Spring<br>ø20x167   | N Series (SN 30..)   |  |
| <b>52142</b> | 03.188.02.02.0                   | C Clip<br>33x9.5               | H Series (SN 42..)<br>K Series (SN 36..)<br>N Series (SN 30..)<br>H..LL Series (SN 42..)<br>K..LL Series (SN 36..)<br>H (M)..L Series (SN 42..)<br>K..L Series (SN 36..) |  |

| Auger Nr.    | OEM Nr.                          | Description                      | Model  | Picture   |
|--------------|----------------------------------|----------------------------------|--|---|
| <b>52152</b> | -                                | Rep. Kit for Camshaft<br><br>ø42 | -  |  <p>52150, 52136, 52143, 52145, 52133</p>          |
| <b>52153</b> | -                                | Rep. Kit for Camshaft<br><br>ø42 | -  |  <p>52150, 52133, 52143, 52136, 52145, 52146</p>   |
| <b>52154</b> | 03.112.44.30.0 S                 | Rep. Kit for Camshaft<br><br>ø42 | -  |  <p>52150, 52143, 52134, 52135, 52145</p>         |
| <b>52155</b> | 09.801.02.15.0                   | Rep. Kit for Camshaft<br><br>ø42 | H Series (SN 42..)<br>K Series (SN 36..)<br>N Series (SN 30..) |  <p>52136, 52143, 52133</p>                      |
| <b>52157</b> | -                                | Rep. Kit for Camshaft<br><br>ø42 | -  |  <p>52150, 52133, 52143, 52136, 52145, 52146</p> |
| <b>52160</b> | 09.801.02.13.0<br>09.801.02.14.0 | Rep. Kit for Camshaft<br><br>ø42 | H Series (SN 42..)<br>K Series (SN 36..)<br>N Series (SN 30..) |  <p>52133, 52136, 52147, 52150, 52143, 52146</p> |

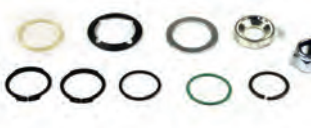
| Auger Nr.    | OEM Nr.          | Description                  | Model  | Picture  |
|--------------|------------------|------------------------------|--|--|
| <b>52161</b> | 09.801.00.37.0   | Rep. Kit for Camshaft<br>ø42 | -  |  <p>52146 52145 52143</p>                   |
| <b>52166</b> | 09.801.02.16.0   | Rep. Kit for Camshaft<br>ø42 | -  |  <p>52133 52143 52136</p>                   |
| <b>52344</b> | -                | Rep. Kit for Camshaft<br>ø42 | -  |  <p>52147 52150 52143 52146</p>            |
| <b>52156</b> | 09.801.06.09.0 S | Rep. Kit for Camshaft<br>ø42 | -  |  <p>52150 52140 52147 54919<br/>52139</p> |
| <b>52715</b> | 09.801.06.09.0   | Rep. Kit for Camshaft<br>ø42 | -  |  <p>52139 52150 52147<br/>52140</p>       |
| <b>53203</b> | 09.801.06.09.1   | Rep. Kit for Camshaft<br>ø42 | H Series (SN 42..)<br>K Series (SN 36..)<br>N Series (SN 30..) |  <p>52139 52140 54919 52150 52147</p>     |

| Auger Nr.    | OEM Nr.        | Description                      | Model  | Picture  |
|--------------|----------------|----------------------------------|--|--|
| <b>52158</b> | 09.801.02.22.0 | Rep. Kit for Camshaft<br><br>ø42 | H / KH Series  |  <p>52137 52150<br/>52146 52144 52138<br/>52147 52148</p> |
| <b>52353</b> | 09.801.02.23.0 | Rep. Kit for Camshaft<br><br>ø42 | NH / NR Series   |  <p>52150 52144<br/>52137 52138 52147<br/>52148 52146</p> |
| <b>52164</b> | 09.801.00.14.2 | Rep. Kit for Camshaft            | H Series (SN 42..)<br>K Series (SN 36..)<br>N Series (SN 30..) |  <p>52145</p>  |
| <b>52159</b> | 09.801.00.24.2 | Rep. Kit for Camshaft            | NH / NR Series   |  <p>52147</p>   |
| <b>52165</b> | 09.801.00.43.0 | Rep. Kit for Camshaft            | -  |  <p>52147</p>   |
| <b>53524</b> | 09.801.00.43.1 | Rep. Kit for Camshaft            | H Series (SN 42..)<br>K Series (SN 36..)<br>N Series (SN 30..) |  <p>52147</p>   |





| Auger Nr.    | OEM Nr.          | Description                               | Model   | Picture   |
|--------------|------------------|---|---|---|
| <b>52162</b> | 09.801.00.14.0   | Rep. Kit for Camshaft                     | -   |    |
| <b>52163</b> | 09.801.00.14.1   | Rep. Kit for Camshaft                     | -   |    |
| <b>52336</b> | 09.801.02.11.0 S | Rep. Kit for Brake Shoe<br><br>ø22xø42x59 | -   |   |
| <b>52338</b> | 09.801.02.11.0   | Rep. Kit for Brake Shoe<br><br>ø22xø42x59 | H Series (SN 42..)<br>N ..LL Series (SN 30..)<br>N ..L Series (SN 30..) |  |
| <b>52339</b> | 09.801.02.12.0 S | Rep. Kit for Brake Shoe<br><br>ø22xø42x59 | -   |  |
| <b>52341</b> | 09.801.02.12.0   | Rep. Kit for Brake Shoe<br><br>ø22xø42x59 | N Series (SN 30..)  |  |

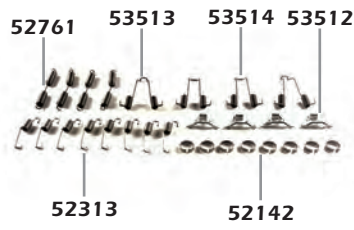
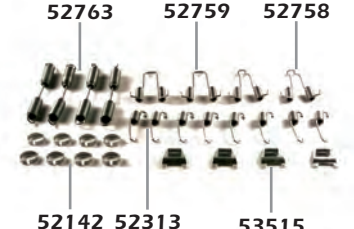

| Auger Nr.    | OEM Nr.          | Description                               | Model  | Picture   |
|--------------|------------------|---|--|---|
| <b>52335</b> | 09.801.02.09.0 S | Rep. Kit for Brake Shoe<br><br>ø32xø42x78 | -  |    |
| <b>52503</b> | 09.801.02.09.0   | Rep. Kit for Brake Shoe<br><br>ø32xø42x78 | -  |    |
| <b>52337</b> | 09.801.02.10.0 S | Rep. Kit for Brake Shoe<br><br>ø26xø42x78 | -  |   |
| <b>52356</b> | 09.801.02.10.0   | Rep. Kit for Brake Shoe<br><br>ø26xø42x78 | H Series (SN 42..)<br>K Series (SN 36..)<br>H..LL Series (SN 42..)<br>K..LL Series (SN 36..)<br>H (M)..L Series (SN 42..)<br>K..L Series (SN 36..) |  |
| <b>52349</b> | 05.331.84.01.0   | Rep. Kit for Brake Shoe<br><br>ø25        | EH Series  |  |
| <b>52352</b> | 09.801.02.91.0   | Rep. Kit for Brake Shoe<br><br>ø26        | H Series (SN 42..)<br>K Series (SN 36..)<br>N Series (SN 30..)<br>K..LL Series (SN 36..)<br>K..L Series (SN 36..)                                  |  |

| Auger Nr.    | OEM Nr.        | Description                                | Model  | Picture   |
|--------------|----------------|--|--|---|
| <b>52342</b> | 09.084.46.35.0 | Rep. Kit for Brake Shoe<br>ø36x145         | H Series (SN 42..)   |    |
| <b>52343</b> | 09.084.46.36.0 | Rep. Kit for Brake Shoe<br>ø36x135         | H Series (SN 42..)<br>K Series (SN 36..)<br>H..LL Series (SN 42..)<br>K..LL Series (SN 36..)<br>H (M)..L Series (SN 42..)<br>K..L Series (SN 36..) |    |
| <b>52348</b> | 09.177.23.09.0 | Rep. Kit for Brake Shoe<br>M20x1.5/ø28x153 | N Series (SN 30..)<br>N..L Series (SN 30..)  |   |
| <b>52355</b> | 09.084.46.12.0 | Rep. Kit for Brake Shoe<br>ø36x147         | -  |  |
| <b>52350</b> | 09.084.46.11.0 | Rep. Kit for Brake Shoe<br>ø36x157         | -  |  |
| <b>53520</b> | 09.084.66.02.0 | Rep. Kit for Brake Shoe<br>ø36x121.5       | -  |  |

| Auger Nr.    | OEM Nr.        | Description                            | Model  | Picture   |
|--------------|----------------|--|--|---|
| <b>53525</b> | 09.084.46.39.0 | Rep. Kit for Brake Shoe<br><br>ø36x145 | N Series (SN 30..)   |    |
| <b>52345</b> | 09.801.02.02.0 | Rep. Kit for Brake Shoe                | H / R Series   |    |
| <b>52346</b> | 09.801.02.03.0 | Rep. Kit for Brake Shoe -              | -  |   |
| <b>52347</b> | 09.801.02.04.0 | Rep. Kit for Brake Shoe -              | -  |  |
| <b>52351</b> | 09.801.02.01.0 | Rep. Kit for Brake Shoe                | H / R Series   |  |
| <b>52773</b> | 05.801.52.72.0 | Rep. Kit for Brake Shoe                | H Series (SN 42..)<br>K Series (SN 36..)<br>H..LL Series (SN 42..)<br>K..LL Series (SN 36..)<br>H (M)..L Series (SN 42..)<br>K..L Series (SN 36..) |  |

| Auger Nr.    | OEM Nr.                          | Description                       | Model   | Picture   |
|--------------|----------------------------------|-----------------------------------|---|---|
| <b>53528</b> | 09.801.02.47.0                   | Rep. Kit for Brake Shoe           | N Series (SN 30..)  |    |
| <b>53529</b> | 09.801.02.45.0                   | Rep. Kit for Brake Shoe           | K Series (SN 36..)<br>K..LL Series (SN 36..)<br>K..L Series (SN 36..)     |    |
| <b>53539</b> | 09.801.02.44.0                   | Rep. Kit for Brake Shoe           | H Series (SN 42..)<br>H..LL Series (SN 42..)<br>H (M)..L Series (SN 42..) |   |
| <b>53543</b> | 09.801.02.46.0                   | Rep. Kit for Brake Shoe           | K Series (SN 36..)  |  |
| <b>52321</b> | 03.084.46.23.0                   | Brake Shoe Pin<br>ø36x145         | H Series (SN 42..)  |  |
| <b>52324</b> | 03.177.23.10.0<br>03.177.23.10.1 | Brake Shoe Pin<br>M20x1.5/ø28x153 | N Series (SN 30..)<br>N..L Series (SN 30..)                               |  |

| Auger Nr.    | OEM Nr.        | Description                 | Model  | Picture   |
|--------------|----------------|-----------------------------|--|---|
| <b>52325</b> | 03.084.46.22.0 | Brake Shoe Pin<br>ø36x135   | H Series (SN 42..)<br>K Series (SN 36..)<br>H..LL Series (SN 42..)<br>K..LL Series (SN 36..)<br>H (M)..L Series (SN 42..)<br>K..L Series (SN 36..)                       |    |
| <b>52327</b> | 03.084.46.04.0 | Brake Shoe Pin<br>ø36x157   | -  |    |
| <b>52330</b> | 03.084.55.11.0 | Brake Shoe Pin<br>ø25x77    | EH Series  |   |
| <b>52769</b> | 03.084.75.24.0 | Brake Shoe Pin<br>ø26x58.5  | H Series (SN 42..)<br>K Series (SN 36..)<br>N Series (SN 30..)<br>H..LL Series (SN 42..)<br>K..LL Series (SN 36..)<br>H (M)..L Series (SN 42..)<br>K..L Series (SN 36..) |  |
| <b>53189</b> | 03.084.46.05.0 | Brake Shoe Pin<br>ø36x147   | -  |  |
| <b>53507</b> | 03.084.66.15.0 | Brake Shoe Pin<br>ø36x121.5 | EH Series  |  |

| Auger Nr.    | OEM Nr.        | Description                               | Model  | Picture   |
|--------------|----------------|---|--|---|
| <b>53511</b> | 03.084.46.30.0 | Brake Shoe Pin<br><br>ø36x145             | N Series (SN 30..)   |    |
| <b>52328</b> | 03.331.34.05.0 | Cam Roller<br><br>ø26xø42x78              | H Series (SN 42..)<br>K Series (SN 36..)<br>H..LL Series (SN 42..)<br>K..LL Series (SN 36..)<br>H (M)..L Series (SN 42..)<br>K..L Series (SN 36..)                       |    |
| <b>52331</b> | 03.331.34.02.0 | Cam Roller<br><br>ø32xø42x78              | EH Series  |   |
| <b>52332</b> | 03.331.34.01.0 | Cam Roller<br><br>ø22xø42x59              | N Series (SN 30..)<br>N..LL Series (SN 30..)<br>N..L Series (SN 30..)  |  |
| <b>52329</b> | 03.200.34.02.0 | Brake Shoe Roller<br><br>ø25.7xø35/ø42x51 | EH Series  |  |
| <b>52770</b> | 05.331.44.02.0 | Brake Shoe Roller<br><br>ø26xø45x33.5     | H Series (SN 42..)<br>K Series (SN 36..)<br>N Series (SN 30..)<br>H..LL Series (SN 42..)<br>K..LL Series (SN 36..)<br>H (M)..L Series (SN 42..)<br>K..L Series (SN 36..) |  |

| Auger Nr.    | OEM Nr.  | Description   | Model   | Picture   |
|--------------|--|---|---|---|
| <b>53512</b> | 03.167.24.01.0   | Lock Plate<br>47x86x27.5  | N Series (SN 30..)  |    |
| <b>52326</b> | 03.167.23.02.0   | Lock Plate<br>52x58x15  | H Series (SN 42..)<br>K Series (SN 36..)<br>H..LL Series (SN 42..)<br>K..LL Series (SN 36..)<br>H (M)..L Series (SN 42..)<br>K..L Series (SN 36..)  |    |
| <b>53515</b> | 03.167.23.09.0   | Lock Plate<br>52x55.5x23  | H Series (SN 42..)<br>K Series (SN 36..)<br>H..LL Series (SN 42..)<br>K..LL Series (SN 36..)<br>H (M)..L Series (SN 42..)<br>K..L Series (SN 36..)  |    |
| <b>52150</b> | 03.112.44.34.0<br>03.112.44.30.0                                     | Brake Camshaft<br>Bushing<br>$\varnothing 42 \times \varnothing 46 \times 72.5$ | H Series (SN 42..)<br>K Series (SN 36..)<br>N Series (SN 30..)<br>H..LL Series (SN 42..)<br>K..LL Series (SN 36..)<br>N..LL Series (SN 30..)<br>H (M)..L Series (SN 42..)<br>K..L Series (SN 36..)<br>N..L Series (SN 30..) |  |
| <b>52322</b> | 03.112.33.08.0   | Brake Shoe Bushing<br>$\varnothing 36 \times \varnothing 40 \times 59$          | H Series (SN 42..)<br>K Series (SN 36..)<br>N Series (SN 30..)<br>H..LL Series (SN 42..)<br>K..LL Series (SN 36..)<br>H (M)..L Series (SN 42..)<br>K..L Series (SN 36..)  |  |
| <b>52323</b> | 03.112.33.04.0   | Brake Shoe Bushing<br>$\varnothing 36 \times \varnothing 40 \times 28$          | -   |  |
| <b>52333</b> | 03.112.22.24.0<br>03.112.22.30.0<br>03.112.22.07.0<br>03.112.22.21.0 | Brake Shoe Bushing<br>$\varnothing 32 \times \varnothing 36 \times 54$          | N Series (SN 30..)<br>N..LL Series (SN 30..)<br>N..L Series (SN 30..)   |  |

| Auger Nr.    | OEM Nr.  | Description                        | Model   | Picture   |
|--------------|--|------------------------------------|---|---|
| <b>52304</b> | 03.084.42.05.0                                     | Brake Shoe Spring Pin<br>ø12x125.5 | KH ../ KR ..  |    |
| <b>52305</b> | 03.084.52.06.0                                     | Brake Shoe Spring Pin<br>ø14x100   | -   |    |
| <b>52306</b> | 03.001.08.03.0<br>03.084.52.28.0                   | Brake Shoe Spring Pin<br>ø12x70.5  | N Series (SN 30..)<br>N..LL Series (SN 30..)<br>N..L Series (SN 30..)                           |   |
| <b>52307</b> | 03.084.42.02.0                                     | Brake Shoe Spring Pin<br>ø12x120   | N Series (SN 30..)<br>N..LL Series (SN 30..)<br>N..L Series (SN 30..)                           |  |
| <b>52308</b> | 03.084.52.08.0                                     | Brake Shoe Spring Pin<br>ø12x52.5  | -   |  |
| <b>52309</b> | 03.084.52.21.0                                     | Brake Shoe Spring Pin<br>ø14x126   | -   |  |
| <b>52768</b> | 03.001.08.05.0<br>03.001.08.01.0<br>03.084.42.01.0 | Brake Shoe Spring Pin<br>ø12x90    | H Series (SN 42..)<br>N Series (SN 30..)<br>H..LL Series (SN 42..)<br>H (M)..L Series (SN 42..) |  |



| Auger Nr.    | OEM Nr.        | Description                        | Model  | Picture   |
|--------------|----------------|------------------------------------|--|---|
| <b>52133</b> | 03.229.02.10.0 | Retainer<br><br>ø10/ø90xø59.6x21.5 | H Series (SN 42..)<br>K Series (SN 36..)<br>N Series (SN 30..) |    |
| <b>52134</b> | 03.229.02.01.0 | Retainer<br><br>ø8.5/ø90xø59.6x17  | EH Series  |    |
| <b>52135</b> | 03.229.02.03.0 | Retainer<br><br>ø8.5/ø90xø59.6x17  | EH Series  |   |
| <b>52136</b> | 03.229.02.09.0 | Retainer<br><br>ø10/ø90xø59.6x21.5 | H Series (SN 42..)<br>K Series (SN 36..)<br>N Series (SN 30..) |  |
| <b>52137</b> | 03.229.02.17.0 | Retainer<br><br>ø10/ø90xø61.5x23   | H Series (SN 42..)<br>K Series (SN 36..)<br>N Series (SN 30..) |  |
| <b>52138</b> | 03.229.02.16.0 | Retainer<br><br>ø10/ø90xø61.5x23   | H Series (SN 42..)<br>K Series (SN 36..)<br>N Series (SN 30..) |  |

| Auger Nr.    | OEM Nr.        | Description                           | Model  | Picture   |
|--------------|----------------|---------------------------------------|--|---|
| <b>52139</b> | 03.229.02.18.0 | Retainer<br><br>ø10/ø90xø61.5x20.5    | H Series (SN 42..)<br>K Series (SN 36..)<br>N Series (SN 30..) |    |
| <b>52140</b> | 03.229.02.19.0 | Retainer<br><br>ø10/ø90xø61.5x20.5    | H Series (SN 42..)<br>K Series (SN 36..)<br>N Series (SN 30..) |    |
| <b>52141</b> | 03.229.02.16.1 | Retainer<br><br>ø10/ø90xø61.5x22.5    | H Series (SN 42..)<br>K Series (SN 36..)<br>N Series (SN 30..) |   |
| <b>52143</b> | 03.113.14.01.0 | Spherical Bearing<br><br>ø42xø59.6x37 | H Series (SN 42..)<br>K Series (SN 36..)<br>N Series (SN 30..) |  |
| <b>52144</b> | 03.113.14.03.0 | Spherical Bearing<br><br>ø42xø61.5x38 | H Series (SN 42..)<br>K Series (SN 36..)<br>N Series (SN 30..) |  |
| <b>54919</b> | 05.377.00.02.0 | Spherical Bearing<br><br>ø42x38       | -  |  |

| Auger Nr.    | OEM Nr.                          | Description  | Model  | Picture   |
|--------------|----------------------------------|--|--|---|
| <b>52145</b> | 03.120.63.01.0<br>03.120.43.09.0 | Dust Cover<br><br>ø39.5x25                         | NH, NR Series  |    |
| <b>52146</b> | 03.120.43.10.0                   | Dust Cover<br><br>ø34x25.5                         | H Series (SN 42..)<br>K Series (SN 36..)<br>N Series (SN 30..) |    |
| <b>52147</b> | 03.120.43.14.0                   | Dust Cover<br><br>ø41x24.5                         | H Series (SN 42..)<br>K Series (SN 36..)<br>N Series (SN 30..) |    |
| <b>52148</b> | 03.120.43.12.0                   | Dust Cover<br><br>ø41x20                           | H Series (SN 42..)<br>K Series (SN 36..)<br>N Series (SN 30..) |  |
| <b>53509</b> | 03.010.91.58.0                   | Dust Cover,<br>Phosphated & Painted<br><br>406x79  | SKH..LL Series (SN SB 3745)                                    |  |
| <b>53510</b> | 03.010.91.59.0                   | Dust Cover,<br>Phosphated & Painted<br><br>ø406x79 | SKH..LL Series (SN SB 3745)                                    |  |
| <b>55505</b> | 03.010.91.53.0                   | Dust Cover,<br>Phosphated & Painted<br><br>406x80  | SKH Series (SB 3745)   |  |

| Auger Nr.    | OEM Nr.        | Description  | Model              | Picture   |
|--------------|----------------|--|--------------------|---|
| <b>52183</b> | 99.00.000.0.93 | Dust Cover Set<br>Phosphated & Painted<br><br>□121xø447x52 | H Series (SN 42..) |    |
| <b>52184</b> | 99.00.000.0.71 | Dust Cover Set<br>Phosphated & Painted<br><br>□124xø447x21 | H Series (SN 42..) |    |
| <b>52185</b> | 99.00.000.0.88 | Dust Cover Set<br>Phosphated & Painted<br><br>□121xø447x21 | H Series (SN 42..) |   |
| <b>52186</b> | 99.00.000.0.80 | Dust Cover Set<br>Phosphated & Painted<br><br>□155xø447x22 | H Series (SN 42..) |  |
| <b>52187</b> | 99.00.000.0.73 | Dust Cover Set<br>Phosphated & Painted<br><br>□155xø447x31 | H Series (SN 42..) |  |
| <b>52188</b> | 99.00.000.0.40 | Dust Cover Set<br>Phosphated & Painted<br><br>ø193xø470x36 | EH Series          |  |







| Auger Nr.    | OEM Nr.        | Description  | Model              | Picture   |
|--------------|----------------|--|--------------------|---|
| <b>52189</b> | 99.00.000.0.85 | Dust Cover Set<br>Phosphated & Painted<br><br>ø131xø447x31   | H Series (SN 42..) |    |
| <b>52190</b> | 99.00.000.0.75 | Dust Cover Set<br>Phosphated & Painted<br><br>□124xø447x31   | H Series (SN 42..) |    |
| <b>52191</b> | 99.00.000.0.42 | Dust Cover Set<br>Phosphated & Painted<br><br>ø160xø470x33   | EH Series          |   |
| <b>52192</b> | 99.00.000.0.95 | Dust Cover Set<br>Phosphated & Painted<br><br>□155xø447x52.5 | H Series (SN 42..) |  |
| <b>52193</b> | 99.00.000.0.76 | Dust Cover Set<br>Phosphated & Painted<br><br>□155xø447x31   | H Series (SN 42..) |  |
| <b>52194</b> | 99.00.000.0.72 | Dust Cover Set<br>Phosphated & Painted<br><br>ø131xø447x22   | H Series (SN 42..) |  |

| Auger Nr.    | OEM Nr.        | Description  | Model              | Picture   |
|--------------|----------------|--|--------------------|---|
| <b>52195</b> | 99.00.000.0.70 | Dust Cover Set<br>Phosphated & Painted<br><br>□125x447x26  | H Series (SN 42..) |    |
| <b>52196</b> | 99.00.000.0.97 | Dust Cover Set<br>Phosphated & Painted<br><br>□121xø447x63 | H Series (SN 42..) |    |
| <b>52197</b> | 99.00.000.0.89 | Dust Cover Set<br>Phosphated & Painted<br><br>□121xø447x31 | H Series (SN 42..) |   |
| <b>52198</b> | 99.00.000.0.94 | Dust Cover Set<br>Phosphated & Painted<br><br>ø130xø447x52 | H Series (SN 42..) |  |
| <b>52199</b> | 99.00.000.0.87 | Dust Cover Set<br>Phosphated & Painted<br><br>□121xø447x35 | H Series (SN 42..) |  |
| <b>52200</b> | 99.00.000.0.98 | Dust Cover Set<br>Phosphated & Painted<br><br>□152xø447x63 | H Series (SN 42..) |  |

| Auger Nr.    | OEM Nr.        | Description  | Model                    | Picture   |
|--------------|----------------|--|--------------------------|---|
| <b>52340</b> | 99.00.000.0.37 | Dust Cover Set<br>Phosphated & Painted<br><br>ø192xø455x35 | EH Series                |    |
| <b>52354</b> | 99.00.000.0.84 | Dust Cover Set<br>Phosphated & Painted<br><br>ø131xø334x28 | N Series (SN 30..)       |    |
| <b>53031</b> | 99.00.000.0.81 | Dust Cover Set<br>Phosphated & Painted<br><br>ø131xø392x28 | K Series (SN 36..)       |   |
| <b>53032</b> | 99.00.000.1.06 | Dust Cover Set<br>Phosphated & Painted<br><br>□121xø390x65 | K Series (SN 36..)       |  |
| <b>53033</b> | 99.00.000.0.83 | Dust Cover Set<br>Phosphated & Painted<br><br>□124xø392x28 | K Series (SN 36..)       |  |
| <b>53521</b> | 09.801.06.19.0 | Dust Cover Set<br>Phosphated & Painted<br><br>ø406x79      | SKH..LL Series (SB 3745) |  |

| Auger Nr.    | OEM Nr.        | Description  | Model              | Picture   |
|--------------|----------------|--|--------------------|---|
| <b>53530</b> | 99.00.000.1.01 | Dust Cover Set<br>Phosphated & Painted<br><br>ø131xø334x5  | N Series (SN 30..) |    |
| <b>53531</b> | 99.00.000.1.09 | Dust Cover Set<br>Phosphated & Painted<br><br>□121xø331x65 | N Series (SN 30..) |    |
| <b>53532</b> | 99.00.000.1.02 | Dust Cover Set<br>Phosphated & Painted<br><br>□121xø334x5  | N Series (SN 30..) |   |
| <b>53533</b> | 99.00.000.1.00 | Dust Cover Set<br>Phosphated & Painted<br><br>ø135xø334x28 | N Series (SN 30..) |  |
| <b>53534</b> | 99.00.000.1.08 | Dust Cover Set<br>Phosphated & Painted<br><br>ø89xø392x28  | K Series (SN 36..) |  |
| <b>53535</b> | 99.00.000.1.03 | Dust Cover Set<br>Phosphated & Painted<br><br>ø131xø334x11 | N Series (SN 30..) |  |



| Auger Nr.    | OEM Nr.                              | Description   | Model   | Picture   |
|--------------|--------------------------------------|---|---|---|
| <b>53536</b> | 99.00.000.1.05                       | Dust Cover Set<br>Phosphated & Painted<br><br>□121xø334x28    | N Series (SN 30..)                                      |    |
| <b>53540</b> | 03.010.99.69.0 S<br>03.010.99.71.0 S | Dust Cover Set<br>Phosphated & Painted<br><br>ø130xø447x63    | -   |    |
| <b>53547</b> | 03.010.96.62.0 S<br>03.010.96.63.0 S | Dust Cover Set<br>Phosphated & Painted<br><br>ø142xø392x28    | -   |   |
| <b>53548</b> | 03.010.98.63.0 S<br>03.010.98.64.0 S | Dust Cover Set<br>Phosphated & Painted<br><br>148/208xø447x32 | -   |  |
| <b>53551</b> | 09.801.06.40.0                       | Dust Cover Set<br>Phosphated & Painted                        | SH Series (SB 4345)<br>SH..LL Series (SB 4309/SB 4345)  |  |
| <b>53552</b> | 09.801.06.41.0                       | Dust Cover Set<br>Phosphated & Painted                        | SH Series (SB 4345)<br>SH..LL Series (SB 4309/ SB 4345) |  |

**Diaphragms - Normal Stroke**
**Auger Nr.: 52576**

O.E.M. Nr. —

Type 9"

**Auger Nr.: 52578**

O.E.M. Nr. —

Type 12"

**Auger Nr.: 52580**

O.E.M. Nr. —

Type 16"

**Auger Nr.: 52581**

O.E.M. Nr. —

Type 20"

**Auger Nr.: 52582**

O.E.M. Nr. —

Type 24"

**Auger Nr.: 52583**

O.E.M. Nr. —

Type 30"

**Auger Nr.: 52584**

O.E.M. Nr. —

Type 36"

**Diaphragms - Long Stroke**
**Auger Nr.: 52585**

O.E.M. Nr. —

Type 16"

**Auger Nr.: 52586**

O.E.M. Nr. —

Type 20"

**Auger Nr.: 52587**

O.E.M. Nr. —

Type 24"

**Auger Nr.: 52588**







O.E.M. Nr. —







Type 30"







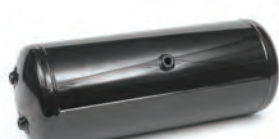

| Auger Nr.    | OEM Nr.  | Description  | Model      | Picture   |
|--------------|--|--|------------|---|
| <b>21004</b> | -  | Service Brake Chamber<br>(for disc brake)<br><br>97.5/111.5xM16x1.5x164                      | T16 STR 57 |    |
| <b>21005</b> | 05.444.32.01.0<br>02.0327.70.00<br>02.0327.71.00<br>05.444.32.02.0 | Service Brake Chamber<br>(for disc brake)<br>(with repair kit)<br><br>97.5/111.5xM16x1.5x164 | T16 STR 57 |    |
| <b>21006</b> | -  | Service Brake Chamber<br>(for disc brake)<br><br>105xM16x1.5x174                             | T20 STR 64 |   |
| <b>21007</b> | 05.444.34.01.0<br>02.0327.74.00<br>02.0327.75.00<br>05.444.34.02.0 | Service Brake Chamber<br>(for disc brake)<br>(with repair kit)<br><br>105/121xM16x1.5x174    | T20 STR 64 |  |
| <b>21008</b> | -  | Service Brake Chamber<br>(for disc brake)<br><br>103xM16x1.5x186                             | T24 STR 64 |  |
| <b>21009</b> | 05.444.36.01.0<br>02.0327.78.00<br>02.0327.79.00<br>05.444.36.02.0 | Service Brake Chamber<br>(for disc brake)<br>(with repair kit)<br><br>103/117.5xM16x1.5x186  | T24 STR 64 |  |

| Auger Nr.    | OEM Nr.   | Description   | Model      | Picture   |
|--------------|---|---|------------|---|
| <b>21010</b> | -   | Service Brake Chamber<br>(for drum brake)<br><br>112.5/126xM16x1.5x164                      | T16 STR 75 |    |
| <b>21011</b> | 05.444.13.01.0<br>02.032.72.70.0  | Service Brake Chamber<br>(for drum brake)<br>(with repair kit)<br><br>112.5/353xM16x1.5x164 | T16 STR 75 |    |
| <b>21012</b> | -   | Service Brake Chamber<br>(for drum brake)<br><br>113/126xM16x1.5x174                        | T20 STR 75 |   |
| <b>21013</b> | 05.444.14.01.0<br>02.032.73.20.0<br>02.033.62.00.0                                    | Service Brake Chamber<br>(for drum brake)<br>(with repair kit)<br><br>113/353xM16x1.5x174   | T20 STR 75 |  |
| <b>21014</b> | -   | Service Brake Chamber<br>(for drum brake)<br><br>112.5/126xM16x1.5x186                      | T24 STR 75 |  |
| <b>21015</b> | 05.444.15.01.0<br>02.032.73.10.0<br>02.0327.31.00<br>05.444.15.10.0<br>05.444.15.11.0 | Service Brake Chamber<br>(for drum brake)<br>(with repair kit)<br><br>112.5/353xM16x1.5x186 | T24 STR 75 |  |
| <b>21016</b> | -   | Service Brake Chamber<br>(for drum brake)<br><br>117.5/131xM16x1.5x208                      | T30 STR 75 |  |





| Auger Nr.    | OEM Nr.        | Description   | Model            | Picture   |
|--------------|----------------|---|------------------|---|
| <b>21017</b> | 05.444.16.01.0 | Service Brake Chamber<br>(for drum brake)<br>(with repair kit)          | T30 STR 75       |    |
|              | 02.032.72.90.0 |   |                  |   |
|              | 05.444.16.10.0 | 117.5/358xM16x1.5x208   |                  |   |
|              | 05.444.16.11.0 |   |                  |   |
| <b>21018</b> | -              | Double Diaphragm Brake<br>Chamber (for drum brake)                      | T24-30 STR 75/75 |    |
|              |                | 274.5/560.5xM16x1.5x208   |                  |   |
| <b>21019</b> | 05.444.20.01.0 | Double Diaphragm Brake<br>Chamber (for drum brake)<br>(with repair kit) | T24-30 STR 75/75 |   |
|              | 02.0327.39.00  |   |                  |   |
|              | 05.444.20.04.0 | 274.5/602.5xM16x1.5x208   |                  |   |
|              | 05.444.20.10.0 |   |                  |   |
|              | 05.444.20.11.0 |   |                  |   |
| <b>21020</b> | -              | Double Diaphragm Brake<br>Chamber (for drum brake)                      | T30-30 STR 75/75 |  |
|              |                | 271.5/557.5xM16x1.5x208   |                  |   |
| <b>21021</b> | 05.444.21.01.0 | Double Diaphragm Brake<br>Chamber (for drum brake)<br>(with repair kit) | T30-30 STR 75/75 |  |
|              | 05.444.21.04.0 |   |                  |   |
|              | 05.444.21.11.0 | 271.5/599.5xM16x1.5x208   |                  |   |
| <b>21000</b> | -              | Double Diaphragm<br>Brake Chamber<br>(for disc brake)                   | T16-24 STR 57/57 |  |
|              |                | 236/337xM16x1.5x186   |                  |   |
| <b>21001</b> | 05.444.41.01.0 | Double Diaphragm Brake<br>Chamber (for disc brake)<br>(with repair kit) | T16-24 STR 57/57 |  |
|              |                | 236/337xM16x1.5x186   |                  |   |



| Auger Nr.    | OEM Nr.                          | Description  | Model            | Picture   |
|--------------|----------------------------------|--|------------------|---|
| <b>21002</b> | -                                | Double Diaphragm Brake Chamber (for disc brake)<br><br>252/353xM16x1.5x186                   | T20-24 STR 64/64 |    |
| <b>21003</b> | 05.444.44.01.0                   | Double Diaphragm Brake Chamber (for disc brake) (with repair kit)<br><br>252/353xM16x1.5x186 | T20-24 STR 64/64 |    |
| <b>54167</b> | 09.801.06.32.0                   | Rep. Kit for Brake Caliper -<br><br>Knorr Type   | -                |   |
| <b>54168</b> | 09.801.02.63.0                   | Rep. Kit for Brake Caliper -<br><br>Knorr Type   | -                |  |
| <b>21904</b> | 02.200.41.30.0<br>10.309.77.42.4 | Air Tank<br><br>ø246x30 L  | -                |  |
| <b>21905</b> | 02.200.41.70.0                   | Air Tank<br><br>ø276x40 L  | -                |  |
| <b>21906</b> | 02.200.41.50.0                   | Air Tank<br><br>ø276x60 L  | -                |  |

| Auger Nr.    | OEM Nr.        | Description           | Model             | Picture   |
|--------------|----------------|-----------------------|-------------------|---|
| <b>31004</b> | 03.088.34.02.0 | Brake Disc<br>290x378 | SB 3745 / SB 6000 |    |
| <b>31005</b> | 03.088.34.04.0 | Brake Disc<br>290x378 | SB 3745 / SB 6000 |    |
| <b>31006</b> | 03.088.34.01.0 | Brake Disc<br>230x377 | SB 3745           |   |
| <b>31007</b> | 03.088.34.03.0 | Brake Disc<br>230x377 | SB 3745           |  |
| <b>31008</b> | 03.088.35.01.0 | Brake Disc<br>290x430 | SB 7000           |  |
| <b>31009</b> | 03.088.35.03.0 | Brake Disc<br>290x430 | SB 4345 / SB 7000 |  |

| Auger Nr.    | OEM Nr.        | Description   | Model  | Picture   |
|--------------|----------------|---|--|---|
| <b>52120</b> | 03.212.24.25.0 | Hub Cap / 6-9 TONS<br>AXLES<br><br>M125x2/SW110/500Nm       | H Series (SN 42..)<br>K Series (SN 36..)<br>N Series (SN 30..)<br>SH Series (SB 4345)<br>SKH Series (SB 3745)<br>H..LL Series (SN 42..)<br>K..LL Series (SN 36..)<br>N..LL Series (SN 30..)<br>H (M)..L Series (SN 42..)<br>K..L Series (SN 36..)<br>N..L Series (SN 30..)<br>SKH..LL Series (SB 3745) |    |
| <b>52121</b> | 03.212.25.08.0 | Hub Cap / 8-9-10-12<br>TONS AXLES<br><br>M135x2/SW110/800Nm | H Series (SN 42..)<br>K Series (SN 36..)<br>N Series (SN 30..)<br>SH Series (SB 4345)<br>SKH Series (SB 3745)<br>H..LL Series (SN 42..)<br>K..LL Series (SN 36..)<br>N..LL Series (SN 30..)<br>H (M)..L Series (SN 42..)<br>K..L Series (SN 36..)<br>N..L Series (SN 30..)<br>SKH..LL Series (SB 3745) |    |
| <b>52122</b> | 03.212.23.09.0 | Hub Cap<br><br>M115x2/SW95/500Nm                            | H Series (SN 42..)<br>K Series (SN 36..)<br>N Series (SN 30..)<br>H..LL Series (SN 42..)<br>K..LL Series (SN 36..)<br>N..LL Series (SN 30..)<br>H (M)..L Series (SN 42..)<br>K..L Series (SN 36..)<br>N..L Series (SN 30..)  |   |
| <b>52123</b> | 03.212.23.02.0 | Hub Cap<br><br>M115x3/SW95/700Nm                            | -  |  |
| <b>52124</b> | 03.212.24.07.0 | Hub Cap / 10-12<br>TONS AXLES<br><br>M125x2/SW110/500Nm     | H Series (SN 42..)<br>K Series (SN 36..)<br>N Series (SN 30..)<br>H..LL Series (SN 42..)<br>K..LL Series (SN 36..)<br>N..LL Series (SN 30..)<br>H (M)..L Series (SN 42..)<br>K..L Series (SN 36..)<br>N..L Series (SN 30..)  |  |
| <b>52125</b> | 03.212.24.02.0 | Hub Cap<br><br>M125x3/SW110/700Nm                           | NH / NR<br>10 -11t   |  |



| Auger Nr.    | OEM Nr.        | Description        | Model                     | Picture   |
|--------------|----------------|--------------------|---------------------------|---|
| <b>52126</b> | 03.212.25.02.0 | Hub Cap / 13-14    | H Series (SN 42..)        |    |
|              | 03.212.05.01.0 | TONS AXLES         | K Series (SN 36..)        |   |
|              |                | M135x3/SW120/700Nm | N Series (SN 30..)        |   |
|              |                |                    | N..LL Series (SN 30..)    |   |
|              |                |                    | H (M)..L Series (SN 42..) |   |
|              |                |                    | K..L Series (SN 36..)     |   |
|              |                |                    | N..L Series (SN 30..)     |   |
| <b>52127</b> | 03.212.26.01.0 | Hub Cap / 16-18    | H Series (SN 42..)        |    |
|              |                | TONS AXLES         | 16 - 18 t                 |   |
|              |                | M155x3/SW120/700Nm |                           |   |
| <b>52128</b> | 03.212.22.01.0 | Hub Cap            | -                         |   |
|              |                | M56x2/SW50         |                           |   |
| <b>52129</b> | 03.212.22.04.0 | Hub Cap            | -                         |  |
|              |                | M84x2/SW70         |                           |   |
| <b>52130</b> | 03.212.22.05.0 | Hub Cap            | -                         |  |
|              |                | M95x2/SW85         |                           |   |
| <b>52131</b> | 03.212.23.01.0 | Hub Cap            | -                         |  |
|              |                | M105x3/SW90        |                           |   |

| Auger Nr.    | OEM Nr.        | Description                       | Model   | Picture  |
|--------------|----------------|-----------------------------------|---|--|
| <b>52132</b> | 03.212.27.01.0 | Hub Cap                           | -   |   |
|              | 03.212.07.01.0 | M230x3/SW120                      |   |  |
| <b>53946</b> | 03.212.25.31.0 | Hub Cap / 8-9-10-12<br>TONS AXLES | H Series (SN 42..)<br>K Series (SN 36..)<br>SH Series (SB 4345)   |   |
|              |                | M136x2.5/SW110/800Nm              | SKH Series (SB 3745)<br>H..LL Series (SN 42..)<br>K..LL Series (SN 36..)<br>SH..LL Series (SB 4309 / SB 4345)<br>SKH..LL Series (SB 3745) |  |
| <b>53975</b> | 03.212.26.14.0 | Hub Cap                           | H Series (SN 42..)  |  |
|              |                | M150x2/SW120/800Nm                | H (M)..L Series (SN 42..)   |  |



| AUGER NR. | O.E.M. NR.                      | A    | B    | C   | REPAIR KIT  |
|-----------|---------------------------------|------|------|-----|-------------|
| 52066     | 03.310.96.05.0                  | ø78  | ø113 | 2.5 | -           |
| 52067     | 03.310.96.06.0                  | ø83  | ø118 | 2.5 | -           |
| 52068     | 03.310.97.07.0                  | ø84  | ø134 | 3   | -           |
| 52069     | 03.310.97.08.0                  | ø88  | ø140 | 3   | -           |
| 52070     | 03.310.96.04.0                  | ø89  | ø124 | 2.5 | -           |
| 52071     | 03.310.97.04.0                  | ø93  | ø144 | 2.5 | -           |
| 52072     | 03.310.97.16.0                  | ø94  | 131  | 2.5 | -           |
| 52073     | 03.310.97.03.0                  | ø98  | ø150 | 2.5 | -           |
| 52074     | 03.310.97.13.0 - 03.310.97.28.0 | ø100 | ø134 | 2.5 | -           |
| 52075     | 03.310.98.07.0                  | ø100 | ø165 | 2.5 | -           |
| 52076     | 03.310.97.32.0                  | ø104 | ø136 | 2.5 | 52346-52351 |
| 52077     | 03.310.97.14.0 - 03.310.97.29.0 | ø105 | ø141 | 2.5 | -           |
| 52078     | 03.310.98.06.0                  | ø105 | ø172 | 2.5 | -           |
| 52079     | 03.310.97.31.0                  | ø110 | ø141 | 2.5 | 52346-52351 |
| 52080     | 03.310.97.15.0 - 03.310.97.27.0 | ø113 | ø155 | 3.5 | -           |
| 52081     | 03.310.98.14.0 - 03.310.98.19.0 | ø118 | ø165 | 3.5 | -           |
| 52082     | 03.310.98.04.0                  | ø118 | ø185 | 3.5 | -           |
| 52083     | 03.310.97.30.0                  | ø120 | ø157 | 2.5 | 52345-52347 |
| 52084     | 03.310.98.13.0                  | ø123 | ø171 | 3.5 | -           |
| 52085     | 03.310.98.02.0                  | ø123 | ø192 | 3.5 | -           |
| 52086     | 03.310.38.20.0                  | ø124 | ø181 | 4   | -           |
| 52087     | 03.310.98.21.0                  | ø128 | ø165 | 2.5 | 52345-52347 |
| 52088     | 03.310.38.21.0                  | ø130 | ø186 | 4   | -           |
| 52089     | 03.310.99.02.0 - 03.310.99.15.0 | ø144 | ø205 | 3.5 | -           |
| 52090     | 03.310.99.01.0 - 03.310.99.16.0 | ø149 | ø212 | 3.5 | -           |
| 52091     | 03.310.98.24.0                  | ø145 | ø173 | 10  | -           |
| 52092     | 03.310.97.22.0                  | ø110 | ø144 | 7   | -           |
| 52093     | 03.310.98.18.0                  | ø125 | ø168 | 7   | -           |
|           |                                 |      |      |     |             |

| Auger Nr.    | OEM Nr.                          | Description  | Model  | Picture  |
|--------------|----------------------------------|--|--|--|
| <b>52175</b> | 03.262.16.03.0                   | Axle Nut<br>M42x2/SW65                               | EH Series<br>8-9 t<br>10-11 t  |                   |
| <b>52176</b> | 03.262.16.02.0                   | Axle Nut<br>M42x3/SW65                               | -  |                   |
| <b>52177</b> | 03.262.17.08.0                   | Axle Nut<br>M52x2/SW80                               | EH Series<br>10-11 t   |                   |
| <b>52178</b> | 03.262.17.03.0<br>03.262.17.11.0 | Axle Nut<br>M60x2/SW85                               | H Series (SN 42..)<br>K Series (SN 36..)<br>N Series (SN 30..)<br>H..LL Series (SN 42..)<br>N..LL Series (SN 30..)<br>H (M)..L Series (SN 42..)<br>K..L Series (SN 36..)<br>N..L Series (SN 30..)                        |                 |
| <b>53517</b> | 03.370.07.62.0                   | Thrust Washer<br>ø96.5xø135x22                       | H Series (SN 42..)<br>K Series (SN 36..)<br>N Series (SN 30..)<br>SH Series (SB 4345)<br>SKH Series (SB 3745)<br>H..LL Series (SN 42..)<br>K..LL Series (SN 36..)<br>N..LL Series (SN 30..)<br>H (M)..L Series (SN 42..) |                 |
| <b>53518</b> | 03.370.07.60.0                   | Thrust Washer<br>ø86xø115x22                         | H Series (SN 42..)<br>K Series (SN 36..)<br>N Series (SN 30..)<br>SH Series (SB 4345)<br>SKH Series (SB 3745)<br>H..LL Series (SN 42..)<br>K..LL Series (SN 36..)<br>N..LL Series (SN 30..)<br>H (M)..L Series (SN 42..) |                 |
| <b>55504</b> | 03.370.07.60.0 TS                | Thrust Washer,<br>With Groove Version<br>ø86xø115x22 | H Series (SN 42..)<br>K Series (SN 36..)<br>N Series (SN 30..)<br>SH Series (SB 4345)<br>SKH Series (SB 3745)<br>H..LL Series (SN 42..)<br>K..LL Series (SN 36..)<br>N..LL Series (SN 30..)<br>H (M)..L Series (SN 42..) | <br>With Groove |

| Auger Nr.    | OEM Nr.        | Description                      | Model   | Picture   |
|--------------|----------------|----------------------------------|---|---|
| <b>53966</b> | 05.370.07.43.0 | Thrust Washer<br><br>ø96xø136x22 | H Series (SN 42..)<br>K Series (SN 36..)<br>H..LL Series (SN 42..)<br>K..LL Series (SN 36..)<br>H (M)..L Series (SN 42..)<br>K..L Series (SN 36..)  |    |
| <b>52201</b> | 03.010.93.33.0 | Dust Cover<br><br>ø84xø128x8.5   | H Series (SN 42..)<br>K Series (SN 36..)<br>N Series (SN 30..)<br>SH Series (SB 4345)<br>SKH Series (SB 3745)<br>H..LL Series (SN 42..)<br>K..LL Series (SN 36..)<br>N..LL Series (SN 30..)<br>H (M)..L Series (SN 42..)<br>K..L Series (SN 36..)<br>N..L Series (SN 30..)<br>SKH..LL Series (SB 3745)                                      |    |
| <b>52202</b> | 03.010.93.34.0 | Dust Cover<br><br>ø94xø148x8.5   | H Series (SN 42..)<br>K Series (SN 36..)<br>N Series (SN 30..)<br>SH Series (SB 4345)<br>SKH Series (SB 3745)<br>H..LL Series (SN 42..)<br>K..LL Series (SN 36..)<br>N..LL Series (SN 30..)<br>H (M)..L Series (SN 42..)<br>K..L Series (SN 36..)<br>N..L Series (SN 30..)<br>SH..LL Series (SB 4309 / SB 4345)<br>SKH..LL Series (SB 3745) |   |
| <b>52203</b> | 03.370.25.16.0 | Dust Cover<br><br>ø53.5xø98x8    | H Series (SN 42..)<br>K Series (SN 36..)<br>N Series (SN 30..)<br>SH Series (SB 4345)<br>SKH Series (SB 3745)<br>H..LL Series (SN 42..)<br>K..LL Series (SN 36..)<br>N..LL Series (SN 30..)<br>H (M)..L Series (SN 42..)<br>K..L Series (SN 36..)<br>N..L Series (SN 30..)<br>SKH..LL Series (SB 3745)                                      |  |
| <b>53996</b> | 03.370.07.45.0 | Thrust Washer<br><br>ø86xø125x22 | N Series (SN 30..)<br>N ..LL Series (SN 30..)<br>N ..L Series (SN 30..)   |  |
| <b>54000</b> | 03.370.07.44.0 | Thrust Washer<br><br>ø96xø145x22 | N Series (SN 30..)<br>N ..L Series (SN 30..)  |  |

| Auger Nr.    | OEM Nr.        | Description               | Model                             | Picture   |
|--------------|----------------|---------------------------|-----------------------------------|---|
| <b>52204</b> | 03.370.26.24.0 | Dust Cover                | H Series (SN 42..)                |    |
|              | 03.370.26.22.0 | ø71xø108x8                | K Series (SN 36..)                |   |
|              |                |                           | N Series (SN 30..)                |   |
|              |                |                           | SH Series (SB 4345)               |   |
|              |                |                           | SKH Series (SB 3745)              |   |
|              |                |                           | H..LL Series (SN 42..)            |   |
|              |                |                           | K..LL Series (SN 36..)            |   |
|              |                |                           | N..LL Series (SN 30..)            |   |
|              |                |                           | H (M)..L Series (SN 42..)         |   |
|              |                |                           | K..L Series (SN 36..)             |   |
|              |                |                           | N..L Series (SN 30..)             |   |
|              |                |                           | SH..LL Series (SB 4309 / SB 4345) |   |
|              |                |                           | SKH..LL Series (SB 3745)          |   |
| <b>53059</b> | 03.010.04.15.0 | Dust Cover                | H Series (SN 42..)                |    |
|              |                | ø84.5xø128.5x5            | K Series (SN 36..)                |   |
|              |                | N Series (SN 30..)        |                                   |   |
|              |                | H..LL Series (SN 42..)    |                                   |   |
|              |                | K..LL Series (SN 36..)    |                                   |   |
|              |                | N..LL Series (SN 30..)    |                                   |   |
|              |                | H (M)..L Series (SN 42..) |                                   |   |
|              |                | K..L Series (SN 36..)     |                                   |   |
|              |                | N..L Series (SN 30..)     |                                   |   |
|              |                |                           |                                   |   |
| <b>53967</b> | 03.010.05.22.0 | Dust Cover                | H Series (SN 42..)                |  |
|              |                | ø95.5xø148x5.5            | K Series (SN 36..)                |   |
|              |                | N Series (SN 30..)        |                                   |   |
|              |                | H..LL Series (SN 42..)    |                                   |   |
|              |                | K..LL Series (SN 36..)    |                                   |   |
|              |                | N ..LL Series (SN 30..)   |                                   |   |
|              |                | H (M)..L Series (SN 42..) |                                   |   |
|              |                | K..L Series (SN 36..)     |                                   |   |
|              |                | N ..L Series (SN 30..)    |                                   |   |
|              |                |                           |                                   |   |
| <b>53998</b> | 03.010.05.21.0 | Dust Cover                | H Series (SN 42..)                |  |
|              |                | ø99xø169x5.5              | K Series (SN 36..)                |   |
|              |                | N Series (SN 30..)        |                                   |   |
|              |                | N ..LL Series (SN 30..)   |                                   |   |
|              |                | H (M)..L Series (SN 42..) |                                   |   |
|              |                | K..L Series (SN 36..)     |                                   |   |
|              |                | N ..L Series (SN 30..)    |                                   |   |
|              |                |                           |                                   |   |
| <b>53999</b> | 03.010.06.12.0 | Dust Cover                | H Series (SN 42..)                |  |
|              |                | ø114.5xø199x5.5           |                                   |   |

| Auger Nr.    | OEM Nr.                       | Description  | Model | Picture  |
|--------------|-------------------------------|--|-------|--|
| <b>20002</b> | 05.429.41.01.0 S<br>4881 MB S | Piston for Air Bellow<br><br>ø247x143              | -     |                                     |
| <b>20004</b> | 05.429.40.91.0 S<br>940 MB S  | Piston for Air Bellow<br><br>ø197x141.5            | -     |                                     |
| <b>20005</b> | 05.429.40.03.0 S<br>941 MB S  | Piston for Air Bellow<br><br>ø197x193              | -     |                                    |
| <b>20032</b> | 05.429.40.01.0 S<br>881 MB S  | Piston for Air Bellow<br><br>ø247x187.6            | -     |                                   |
| <b>20029</b> | 05.429.41.01.0 S1             | Rep. Kit for Air Spring<br><br>ø247xø256x143xM16X2 | -     |  <p>20030<br/>20002<br/>20031</p> |
| <b>20034</b> | 05.429.40.91.0 S1             | Rep. Kit for Air Spring<br><br>ø197xø205x143xM16X2 | -     |  <p>20035<br/>20004<br/>20031</p> |

| Auger Nr.    | OEM Nr.           | Description                                    | Model | Picture   |
|--------------|-------------------|--|-------|---|
| <b>20036</b> | 05.429.40.03.0 S1 | Rep. Kit for Air Spring<br>ø197xø205x187xM16X2 | -     |    |
| <b>20114</b> | 05.429.40.01.0 S1 | Rep. Kit for Air Spring                        | -     |    |
| <b>20030</b> | -                 | Flange for Air Spring<br>M16/ø242x17           | -     |   |
| <b>20035</b> | -                 | Flange for Air Spring<br>M16/ø191x17           | -     |  |
| <b>20031</b> | -                 | Bolt for Air Spring<br>M16/30x128              | -     |  |
| <b>20033</b> | -                 | Bolt for Air Spring<br>M16/30x174              | -     |  |



# 14



## SAUER ACHSEN



| Group                       | Page |
|-----------------------------|------|
| Spring Suspension . . . . . | 001  |
| Stabilizer . . . . .        | 004  |
| Brake . . . . .             | 005  |
| Axle & Wheel . . . . .      | 027  |



| Auger Nr.    | OEM Nr.       | Description                                    | Model   | Picture   |
|--------------|---------------|--|---|---|
| <b>52104</b> | 4 177 3016 00 | Rubber Bushing for Spring<br><br>ø36xø65.5xø68 | VRZ 28<br>VRZ 42<br>VRZ 48  |    |
| <b>52217</b> | 4 177 3010 00 | Rubber Bushing for Spring<br><br>ø30xø68x104   | AR 112 / 113 / 211 / 212 / AR 411 E / EM 411 E<br>213 / 313 AR 411 EH / EM 411 EH<br>AR 311 / EM 311 AR 411 H / EM 411 H<br>AR 311 E / EM 311 E AR 413 / AR 413 H<br>AR 311 EH / EM 311 EH AR 414 / EO 414<br>AR 311 H / EM 311 H AR 414 EH / EO 414 EH<br>AR 314 / EO 314 AR 414 H / EO 414 H<br>AR 314 E / EO 314 E AR 416 / EU 416<br>AR 314 EH / EO 314 EH AR 416 E / EU 416 E<br>AR 314 H / EO 314 H AR 416 EH / EU 416 EH<br>AR 316 / EU 316 AR 416 H / EU 416 H<br>AR 316 E / EU 316 E AR 418 / AR 421<br>AR 316 EH / EU 316 EH MODULAR SYSTEM M /<br>AR 316 H / EU 316 H O / U<br>AR 411 / EM 411 |    |
| <b>52359</b> | 4 177 0008 00 | Rubber Bushing for Spring<br><br>ø24xø59x107   | ---   |   |
| <b>53559</b> | 1 177 2002 00 | Rubber Bushing for Spring<br><br>ø50xø92x121   | VDS16 - VDS 20<br>VDZ 16 - VDZ 20<br>VDS 24 - VDS 20<br>VDS 16 - VDS 24 K<br>VDZ 16 - VDZ 20<br>VLS 22 - VRZ 20   |  |
| <b>53560</b> | 1 177 1001 02 | Rubber Bushing for Spring<br><br>ø30xø55x61.5  | VDS16 - VDS 20<br>VDZ 16 - VDZ 20<br>VDS 24 K - VDS 16<br>VDS 20 - VDS 24<br>VDZ 16 - VDZ 20<br>VLZ 30T - VLZ 40T<br>VLS 22 - VRZ 20<br>VRZ 20  |  |
| <b>52370</b> | 2 095 2039 00 | Rubber Bushing for Spring<br><br>ø15xø40x101   | VDS16 - VDS20<br>VDZ16 - VDZ20<br>VDS 16 - VDS 20<br>VDS 24 - VDS 24 K<br>VDZ 16 - VDZ 20<br>VLZ 30T - VLZ 40T<br>VLS 22 - VRZ 20<br>VRZ 20 T   |  |

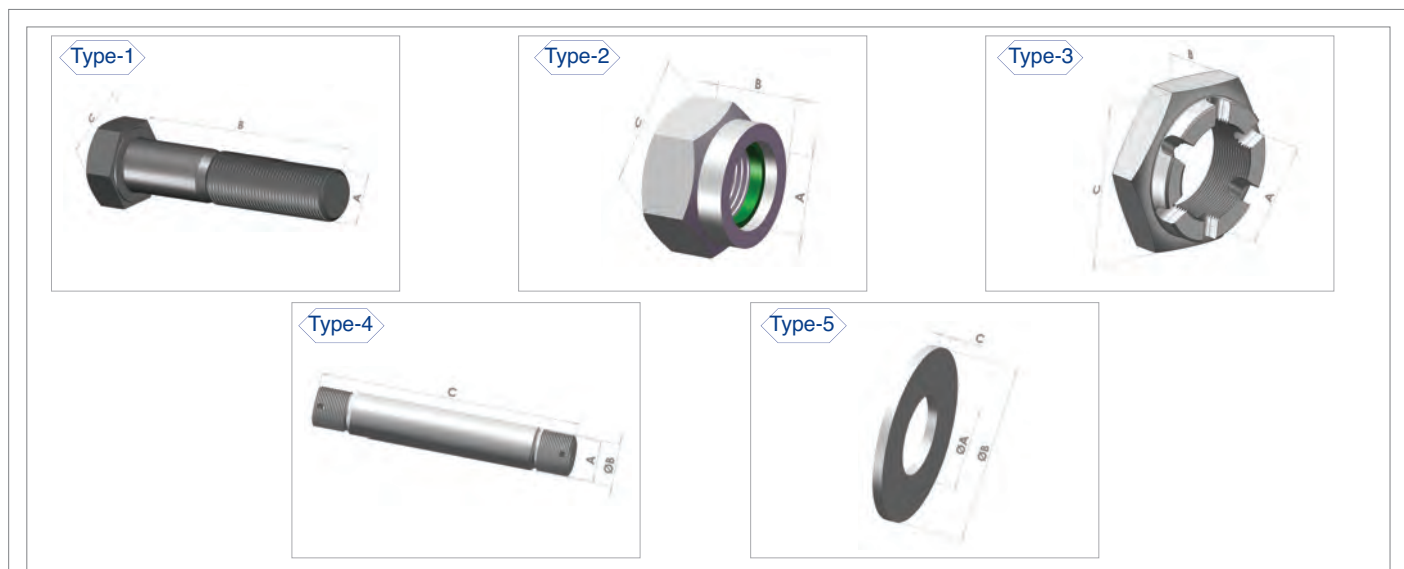

| Auger Nr.    | OEM Nr.       | Description                                     | Model  | Picture  |
|--------------|---------------|---|--|--|
| <b>54281</b> | 4 177 0020 00 | Rubber Bushing for Spring<br><br>ø20xø62x102    | ---  |   |
| <b>54285</b> | 4 177 3026 00 | Rubber Bushing for Spring<br><br>ø31.5xø152x171 | INTRAAX XO<br>INTRAAX XU<br>INTRADISC PLUS PO<br>INTRADISC PLUS PU             |   |
| <b>53555</b> | 4 177 3028 00 | Rubber Bushing for Spring<br><br>ø31.5xø155x114 | SKRLB 9019I O/IU<br>SKRLB 9022I O/IU<br>INTRADISC PLUS IU<br>INTRADISC PLUS IO |  |



| Auger Nr.    | O.E.M. Nr.    | A       | B    | C     | Type | Repair Kit                    |
|--------------|---------------|---------|------|-------|------|-------------------------------|
| <b>54033</b> | 4 343 0080 88 | M30x3.5 | 260  | SW 46 | 1    | 52376                         |
| <b>54034</b> | 4 343 1048 88 | M30x3.5 | 205  | SW 46 | 1    | 55181-53037-53564             |
| <b>54035</b> | 4 343 1053 00 | M30x3.5 | 240  | SW 46 | 1    | 53565                         |
| <b>54796</b> | 4 343 0013 88 | M16x2   | 100  | SW 24 | 1    | 52376                         |
| <b>55276</b> | 4 343 2055 10 | M22x1.5 | 250  | SW 32 | 1    | 55182                         |
| <b>54053</b> | 4 247 4022 80 | M30x3.5 | 30   | SW 46 | 2    | 55181-52376-53037-53564-53565 |
| <b>54058</b> | 4 202 1006 80 | M48x3   | 25   | SW 75 | 3    | 53595                         |
| <b>54794</b> | 1 051 1008 00 | M48x3   | ø50  | 310   | 4    | 53595                         |
| <b>55275</b> | 4 331 5029 00 | ø60     | ø170 | 5     | 5    | 55181-55182                   |

| Auger Nr.    | OEM Nr.                        | Description   | Model  | Picture   |
|--------------|--------------------------------|---|--|---|
| <b>55181</b> | 4 177 3028 00 S                | Rep. Kit Spring Bolt Assembly<br><br>ø31.5xø155x114 | SKRLB 9019I O/U<br>SKRLB 9022I O/U<br>INTRADISC PLUS IU<br>INTRADISC PLUS IO   |    |
| <b>55182</b> | 4 177 3026 00 S                | Rep. Kit Spring Bolt Assembly<br><br>ø31.5xø152x171 | INTRAAX XO<br>INTRAAX XU<br>INTRADISC PLUS PO<br>INTRADISC PLUS PU   |    |
| <b>53037</b> | 3 341 1048 19                  | Rep. Kit Spring Bolt Assembly<br><br>M30x3.5/205    | AR 112 - AR 313 WITH LIFT<br>AR 113 / 211 / 212 / 213<br>AR 311 /EM 311 / 311E/EM311E<br>AR 311H/EM311H / 311EH/EM311EH<br>AR 314/E0 314 / 314E/E0 314E<br>AR 314H/E0 314H / 314EH/E0 314EH<br>AR 316/EU316 / 316E/EU316E<br>AR 316H/EU316H / 316EH/EU316EH<br>AR 411 /EM 411 / 411E/EM411E<br>AR 411H/EM411H / 411EH/EM411EH<br>AR 414/E0 414 / 414E/E0 414E<br>AR 414H/E0 414H / 414EH/E0 414EH<br>AR 416/EU416 / 416E/EU416E<br>AR 416H/EU416H / 416EH/EU416EH<br>AR 413 / 413H / 418 / 421<br>MODULAR SYSTEM M-O-U |   |
| <b>53564</b> | 3 434 3643 00                  | Rep. Kit Spring Bolt Assembly<br><br>ø30xø68x104    | Air suspension series AR/E0/EM/EU  |  |
| <b>53565</b> | 3 434 3644 00                  | Rep. Kit Spring Bolt Assembly<br><br>ø30xø68x104    | Air suspension series M / O / U  |  |
| <b>53595</b> | 3 050 1008 00                  | Rep. Kit Spring Bolt Assembly<br><br>ø50x92x121     | VDS 16 - VDS 20<br>VDZ 16 - VDZ 20<br>VDS 24 - VDS 20<br>VDS16 - VDS 24<br>VDS 24 K - VDZ16<br>VDZ 20 - VLS 22<br>VRZ 20   |  |
| <b>52376</b> | 3 227 0190 00<br>5 399 0020 70 | Rep. Kit Spring Bolt Assembly<br><br>M30x3.5/260    | ---  |  |

| Auger Nr.    | OEM Nr.                        | Description                            | Model  | Picture   |
|--------------|--------------------------------|--|--|---|
| <b>52168</b> | 1 169 0003 01                  | Slider<br>112x158x64                   | VDS 16<br>VDS 20<br>VDS 24<br>VDS 24 K<br>VDZ 16<br>VDZ 20<br>VLS 22<br>VLZ 30 T<br>VLZ 40 T<br>VRZ 20<br>VRZ 20 T |    |
| <b>52169</b> | 1 318 1001 02                  | Slider<br>69/74x109                    | VDS 16<br>VDS 20<br>VDS 24<br>VDS 24 K<br>VDZ 16<br>VDZ 20<br>VLS 22<br>VLZ 30 T<br>VLZ 40 T<br>VRZ 20<br>VRZ 20 T |    |
| <b>51075</b> | 1 230 0047 00                  | Stabilizer Bushing<br>ø25xø35x28       | ---  |   |
| <b>52995</b> | 1 230 0130 00<br>1 230 0063 00 | Stabilizer Plastic Bearing<br>ø49x70   | ---  |  |
| <b>53035</b> | 1 230 0131 00<br>1 230 0060 00 | Stabilizer Plastic Bearing<br>ø46x70   | ---  |  |
| <b>53036</b> | 1 230 0048 00                  | Stabilizer Plastic Bearing<br>ø39.5x70 | ---  |  |





| Auger Nr.    | OEM Nr.                        | Description                        | Model   | Picture   |
|--------------|--------------------------------|------------------------------------|---|---|
| <b>52362</b> | 1 447 0021 01<br>1 447 0031 00 | Brake Shoe Spring<br><br>ø26x190   | RBM 8442 / 8442/12<br>RLBM 8442<br>RLSM 8442 / 9042 / 9042/20 / 11242<br>RSM 8442 / 8442-8 / 9042 / 9042/20 / 11242<br>RZM 8442 / 8442-8 / 11242<br>SKRB 9019 K / 9019 W / 9022 H / 9022 K<br>SKRLS 9037 / 9042 / 9042/20 / 11242<br>SKRLZ 9030 / 9037 / 11030 / 11037<br>SKRS 9019 K / 9022 K / 9030 / 9037-8 / 9037-10<br>SKRS 9042 (Intraax) / 9042/20 / 11019K / 11222K / 11242<br>SKRZ 11019 K / 11030 / 11037-8 / 11037-10 / 11242 / 11222 K<br>SKRZ 9019 K / 9022 K / 9030 / 9037-8 / 9037-10 / 9042 / 9042/20<br>WRLZM 11030 / 11035-8 / 11035-10<br>WRZM 8442 / 8442-8 / 11242<br>SKZRLZ 11030<br>WZRLZM 11030 |    |
| <b>52774</b> | 1 447 0058 00                  | Brake Shoe Spring<br><br>ø32.5x232 | RBM 8442 / 8442/12 - RLBM 8442<br>RLSM 8442 / 9042 / 9042/20 / 11242<br>RSM 8442 / 8442-8 / 9042 / 9042/20 / 11242<br>RZM 8442 / 8442-8 / 11242<br>SKRB 9019 K / 9019 W / 9022 H / 9022 K<br>SKRLS 9037 / 9042 / 9042/20 / 11242<br>SKRLZ 9030 / 9037 / 11030 / 11037<br>SKRS 9019 K / 9022 K / 9030 / 9037-8 / 9037-10<br>SKRS 9042 (Intraax) / 9042/20 / 11019K / 11222K / 11242<br>SKRZ 11019 K / 11030 / 11037-8 / 11037-10 / 11242 / 11222 K<br>SKRZ 9019 K / 9022 K / 9030 / 9037-8 / 9037-10 / 9042 / 9042/20<br>WRLZM 11030 / 11035-8 / 11035-10<br>WRZM 8442 / 8442-8 / 11242 - WZRLZM 11030                   |    |
| <b>52775</b> | 1 447 0033 00                  | Brake Shoe Spring<br><br>ø29x168   | EBN 3130/12 / 4530<br>ESN 4030 / 5030 / 6030<br>EZN 4030 / 4030/12 / 5030 / 6030<br>WESN 5030 / 6030<br>WEZN 5030 / 6030 / 6030/12<br>WRZM 8130 /<br>WRLZM 8130 / 11030<br>WZRLZM 8130 / 11030  |  |
| <b>52776</b> | 1 447 0050 00                  | Brake Shoe Spring<br><br>29.5x220  | EBN 4535<br>EBN 5535<br>WRZM 8435-8<br>WRZM 8435-10<br>WRZM 11035-8<br>WRZM 11035-10<br>WRLZM 8435-8<br>WRLZM 8435-10<br>WRLZM 11035-8<br>WRLZM 11035-10  |  |
| <b>52779</b> | 1 447 0038 00                  | Brake Shoe Spring<br><br>ø25.5x227 | RSM 6542<br>ESN 5542<br>RBM 8442 / 8442/12<br>RLBM 8442<br>RLSM 8442 9042 / 9042/20 / 11242<br>RSM 6242-8 / 6242/12-8 / 6242/12-10<br>RSM 8442 / 8442-8 / 9042 / 9042-20<br>11242   |  |
| <b>53558</b> | 1 447 0060 00                  | Brake Shoe Spring<br><br>ø32x186   | SKRZ 6530<br>SKRS 9030<br>SKRZ 9030<br>SKRZ 11030<br>SKRZ 12030   |  |

| Auger Nr.    | OEM Nr.       | Description                   | Model   | Picture  |  |
|--------------|---------------|-------------------------------|---|--|--|
| <b>52760</b> | 1 447 0037 00 | Return Spring<br>ø25.5x146    | EBN 3140 / 3140-6 / 4040 / 4535 / 4540 / 5535<br>RS 5030<br>RZM 13130<br>SKRLZ 9037<br>SKRS 6537-8 / 6537-10 / 9030 / 9037-8<br>SKRS 9037-10 / 9042(INTRAAX)/9042 SK<br>SKRZ 6530 / 9030 / 9037-8 / 9037-10 / 11030 / 11037-8 / 11037-10 / 12030<br>WRZM 8130 / 8435-8 / 8435-10 / 11030 / 11035-8 / 11035-10   |   |  |
| <b>52780</b> | 1 447 0036 00 | Return Spring<br>ø22.5x180    | EBN 3130/12 / 4530 / 4540 / 4540-6<br>ESN 4030 / 4040 / 4540 / 5030 / 5542 / 6030<br>EZN 4030 / 4030/12 / 5030 / 6030<br>KRS 12242 / 12242/18 / 14242<br>KRZT 14242 TRILEX / 16242 / 16242<br>TRILEX - RBM 8442 / 8442/12<br>RLBM 8442 - RLSM 11242<br>RLSM 8442 / 9042 / 9042/20<br>RSM 6542 / 6242/12-8 / 6242/12-10/8442 / 8442/8 / 9042 / 9042/20 / 11242<br>RZM 11242 / 12242 / 14242 / 16242 / 8442 / 8442/8<br>RZT 14242 / 16242 - SKRLS 11242<br>SKRLZ11030/11037/9030/ 9042/ 9042/20<br>SKRS 9042 / 11242 / 12242 / 9042 SK<br>500 (PLUS) - SKZRLZ 11030 / 12030 |   |  |
| <b>55225</b> | 3 268 0051 00 | Spherical Bearing<br>ø48x78   | KRS 12242<br>KRS 12242/18<br>S11-3720-S11-4218<br>S11-4220-S9-3718<br>S9-4218-S9-4220<br>SK 500/SK 500 PLUS<br>SK RS 12242<br>SK RS 6537-10<br>SK RS 6537-8<br>SK RS 9037-10<br>SK RS 9037-8<br>SK RS 9042 / SK 1000<br>SK RS 9042 INTRAAX<br>SK RS 9042 SK 500<br>SK RS 9042 SK 500<br>plus<br>SK RS 9042/20 H   | SK RS/RZ 9037/11037<br>SK RZ 12037<br>SK RZ 12242<br>SK RZ 9037-10<br>SK RZ 9037-8<br>SK RZ 9042/20<br>SK RZT 12242<br>SKRS 11242<br>SKRS/RZ 9042/11242<br>SKRZ 11037-10<br>SKRZ 11037-8<br>SKRZ 11242<br>SKRZ9042-Z11-3720<br>Z11-4218-Z11-4220<br>Z8-3718-Z9-3720<br>Z9-4218-Z9-4220 |  |
| <b>52218</b> | 3 268 0046 00 | Spherical Bearing<br>ø46x78   | KRS 12242<br>KRZ 14242<br>SKRS 6537-8 / 6537-10 / 9037-8 / 9037-10 / 9042 / 9042/20 / 12242<br>SKRS 9042 INTRAAX / (INTRAAX) SK<br>1000 ET 0 / SK 500 (PLUS)  |   |  |
| <b>52219</b> | 3 268 0045 00 | Spherical Bearing<br>ø38x51.5 | KRS 12242 / 12242/18 / 14242<br>KRZ 14242<br>KRZT 14242 TRILEX / 16242 / 16242<br>TRILEX<br>SKRS 6537-8 / 6537-10 / 9030 / 9037-8 / 9037-10 / 12242<br>SKRS 9042 / 9042/20 / 9042 INTRAAX / 9042 INTRAAX SK 1000 ET 0<br>SKRS 9042 SK 500 (PLUS)<br>SKRZT 12242   |   |  |
| <b>52213</b> | 4 131 0008 00 | Dust Cover<br>ø36.5xø60x17    | EBN 3130/12 / 3140 / 3140-6 / 4040 / 4530 / 4535 / 4540 / 5535 - ES 5030<br>ESN 4030 / 4040 / 4540 / 5030 / 5542 / 6030<br>EZN 4030 / 4030/12 / 5030 / 6030<br>KRS 12242 - KRZ 14242<br>KRZT 14242 TRILEX / 16242 (TRILEX)<br>RBM 8442 / 8442/12<br>RS 5030 - RSM 11242<br>RSM 6542 - RSM 6542/12-8<br>RSM 8442 / 8442-8 / 9042 / 9042/20<br>RZM 8442 / 8442-8 / 11242 / 12242 / 14242 / 16242 - RZT 14242 / 16242<br>SKRLS 9042 / 9042/20 / 11242<br>SKRS 6537-8 / 6537-10 / 9030 / 9037-8 / 9037-10 / 9042 / 9042/20 / 11242 / 12242                                    |   |  |



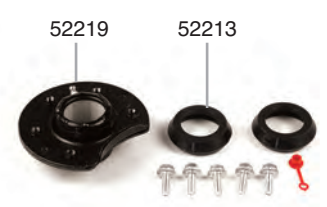

| Auger Nr. | O.E.M. Nr.    | A       | B      | C     | Type | Repair Kit        |
|-----------|---------------|---------|--------|-------|------|-------------------|
| 54870     | 4 373 0010 00 | ø138    | ø160   | 13    | 1    | 52375             |
| 54869     | -             | ø116.5  | ø152.5 | 25.5  | 1    | 52374             |
| 54795     | 1 214 0006 06 | ø32     | 183    | -     | 2    | 53997             |
| 54049     | -             | M16x1.5 | 16     | SW 24 | 3    | 52231             |
| 54833     | 1 151 0013 00 | 35      | 156    | 39    | 4    | 53577             |
| 54834     | 1 151 0008 00 | 35      | 175    | 55    | 4    | 53578-53581-53582 |

| Auger Nr.    | OEM Nr.       | Description                       | Model   | Picture   |
|--------------|---------------|-----------------------------------|---|---|
| <b>55226</b> | 3 268 0050 00 | Rep. Kit for Camshaft<br>ø48x78   | KRS 12242<br>KRS 12242/18<br>S11-3720-S11-4218<br>S11-4220-S9-3718<br>S9-4218-S9-4220<br>SK 500/SK 500 PLUS<br>SK RS 12242<br>SK RS 6537-10<br>SK RS 6537-8<br>SK RS 9037-10<br>SK RS 9037-8<br>SK RS 9042 / SK 1000<br>SK RS 9042 INTRAAX<br>SK RS 9042 SK 500<br>SK RS 9042 SK 500 plus<br>SK RS 9042/20 H<br>SK RS/RZ 9037/11037 |   |
| <b>52220</b> | 3 268 0048 00 | Rep. Kit for Camshaft<br>ø46x78   | KRS 12242 / 12242/18 / 14242<br>KRZ 14242<br>SKRS 11242 / 12242<br>SKRS 6537-8 / 6537-10 / 9037-8 / 9037-10 / 042<br>SKRS 9042 INTRAAX (SK 1000 ET 0)<br>SKRS 9042 SK 1000 ET 0<br>SKRS 9042/20 / 9042 SK 500 (PLUS)  |  |
| <b>52221</b> | 3 268 0047 00 | Rep. Kit for Camshaft<br>ø38x51.5 | KRS 12242 / 12242/18 / 14242<br>KRZ 14242 / 16242<br>KRZT 14242 TRILEX / 16242 TRILEX<br>SKRS 6537-8 / 6537-10 / 11242 / 12242<br>SKRS 9030 / 9037-8 / 9037-10 / 9042<br>SKRS 9042 INTRAAX (SK 1000 ET 0)<br>SKRS 9042/20 / 9042 SK 500 (PLUS)<br>SKRZ 11030 / 11037-8 / 11037-10   |  |
| <b>53569</b> | 3 434 3619 00 | Rep. Kit for Camshaft<br>ø38x51.5 | KRS 14242<br>KRZ 14242  |  |

| Auger Nr.    | OEM Nr.                        | Description                             | Model   | Picture   |
|--------------|--------------------------------|---|---|---|
| <b>52357</b> | 3 434 3639 00                  | Rep. Kit for Camshaft                   | SKRS 9042 / 11242<br>SKRZ 9042 / 11242  |  <p>52213 52218 52760 52219</p>                |
| <b>53570</b> | 3 434 3652 00                  | Rep. Kit for Camshaft                   | SK 500<br>SK 500 plus   |  <p>52219 52213 52218</p> <p>52780</p>         |
| <b>53576</b> | 3 434 3642 00                  | Rep. Kit for Camshaft                   | SK 6537 / 9037 / 11037  |  <p>52219 52218 52760</p> <p>52213</p>        |
| <b>53579</b> | 3 434 3640 00                  | Rep. Kit for Camshaft<br><br>ø38x51.5   | SKRS 6530 - 11030<br>SKRS 9037 / 11037<br>SKRZ 6530 - 11030<br>SKRZ 9037 / 11037  |  <p>52213 52219 52760 52366</p>              |
| <b>52226</b> | 3 434 3620 00<br>3 434 3618 00 | Rep. Kit for Camshaft<br><br>ø38xø60x55 | RBM 8442<br>RLBM 8442<br>RLSM 8442 / 9042 / 11242<br>RSM 8442 / 9042 / 11242<br>RZM 8442 / 11242<br>SKRLS 9042 / 11242<br>SKRS 9042 / 11242<br>SKRZ 9042 / 11242<br>WRZM 8442 / 11242 |  <p>52278 52206 52207 52780</p> <p>52214</p> |
| <b>52227</b> | 3 434 3622 00                  | Rep. Kit for Camshaft<br><br>ø38xø60x55 | SK 9042 / 11242<br>SKRS 9042/11242  |  <p>52213 52207 52205 52780</p>              |







| Auger Nr.    | OEM Nr.       | Description                             | Model   | Picture   |
|--------------|---------------|---|---|---|
| <b>52230</b> | ---           | Rep. Kit for Camshaft<br><br>ø38xø60x55 | ---   |  <p>52214 52207 52213</p>            |
| <b>52232</b> | 3 268 0007 02 | Rep. Kit for Camshaft<br><br>ø38xø60x55 | EBN 3140<br>EBN 3140-6<br>EBN 4040<br>EBN 4540                      |  <p>52214 52207</p>                  |
| <b>52234</b> | 3 434 3638 00 | Rep. Kit for Camshaft<br><br>ø38xø60x55 | SKRS/RZ 9042/11242  |  <p>52213 52207 52366<br/>52780</p> |
| <b>52235</b> | 3 434 3636 00 | Rep. Kit for Camshaft<br><br>ø38xø60x55 | RS/RZ/WRZ 8442-11242<br>EBN/ESN 3140 - 5542<br>EBN 3130 - WE2N 6030 |  <p>52206 52207 52213 52214</p>    |
| <b>53571</b> | 3 434 3614 00 | Rep. Kit for Camshaft<br><br>ø38xø60x55 | SK 6537 / 9037 / 11037  |  <p>52760 52213 52366 52207</p>    |
| <b>53572</b> | 3 434 3613 00 | Rep. Kit for Camshaft<br><br>ø38xø60x55 | SK 6537 / 9037 / 11037  |  <p>52760 52205 52213 52207</p>    |

| Auger Nr.    | OEM Nr.       | Description                             | Model   | Picture  |
|--------------|---------------|---|---|--|
| <b>53573</b> | 3 434 3611 00 | Rep. Kit for Camshaft<br><br>ø38xø60x55 | SK 9042 / 11242   |  <p>53556 52213 52207<br/>52780</p> |
| <b>53574</b> | 3 434 3610 00 | Rep. Kit for Camshaft<br><br>ø38xø60x55 | SKRS 6530-11030<br>SKRZ 6530-11030  |  <p>52760 52213 52366 52207</p>     |
| <b>53575</b> | 3 434 3634 00 | Rep. Kit for Camshaft<br><br>ø38xø60x55 | SKRS 6537-11037<br>SKRZ 6537-11037  |  <p>52213 52780 52205 52207</p>    |
| <b>53580</b> | 3 268 0035 00 | Rep. Kit for Camshaft<br><br>ø38xø60x55 | RSM 6542<br>EBN 3130/12 / 3140 / 3140-6 / 4040 / 4530 /<br>4535 / 4540 / 4540-6 / 5535<br>ES 5030<br>ESN 4030 / 4040 / 4540 / 5030 / 5542 / 6030<br>EZN 4030 / 4030/12 / 5030 / 6030<br>RBM 8442 / 8442/12<br>RSM 11242 / 6242/12-10 / 6242/12-8 8442 /<br>8442/8 / 9042 / 9042/20<br>RZM 11242 / 12242 / 14242 / 16242 / 8442 /<br>8442/8 - WRZM 11242<br>RZT 14242 / 16242 - WESN 5030 / 6030<br>WEZN 5030 / 6030 / 6030/12<br>WRZM 6242 / 6242-8 / 8442 / 8442-8 |  <p>52214 52207<br/>52213</p>     |
| <b>52704</b> | 3 268 0034 00 | Rep. Kit for Camshaft<br><br>ø38xø60x55 | EBN 3130/12 / 3140 / 4040 / 4530 / 4535<br>4540 / 4540/6 / 5535<br>ES 5030 / RS 5030<br>ESN 4030 / 4040 / 4540 / 5030<br>ESN 5542 / 6030<br>EZN 4030 / 4030/12 / 4530 / 6030<br>RBM 8442 / 8442/12  |  <p>52214 52207 52213</p>         |
| <b>52229</b> | ---           | Rep. Kit for Camshaft<br><br>ø38xø70x63 | RZM 11030 / 13130<br>WRZM 8130 / 8435-8 / 8435-10 / 11030 /<br>11035-8 / 11035-10   |  <p>52211 52210 52212</p>         |





| Auger Nr.    | OEM Nr.              | Description                             | Model  | Picture  |
|--------------|----------------------|---|--|--|
| <b>52231</b> | ---                  | Rep. Kit for Camshaft<br><br>ø38xø70x63 | ---  |  <p>52216 52210<br/>54049</p>                           |
| <b>52233</b> | 3 434 3637 00        | Rep. Kit for Camshaft<br><br>ø38xø70x63 | RZ 8130 / 11030<br>WRZ 8130 / 11030<br>WRZ 8435 / 11035  |  <p>52206 52367 52210</p>                               |
| <b>52236</b> | 3 268 0006 00        | Rep. Kit for Camshaft<br><br>ø38xø70x63 | WRZM 8130<br>RZM 11030<br>WRZM 11030<br>RZM 13130<br>WRZM 8435-8<br>WRZM 8435-10<br>WRZM 11035-8<br>WRZM 11035-10  |  <p>52210 52367</p>                                    |
| <b>52374</b> | 3 434 3604 00        | Rep. Kit for Camshaft<br><br>ø38xø70x63 | ---  |  <p>52210 52206 52368 52373 54869<br/>52775 52760</p> |
| <b>53567</b> | 3 268 0037 00        | Rep. Kit for Camshaft<br><br>ø38xø70x63 | RZM 13130<br>WRZM 11030<br>WRZM 11035-10<br>WRZM 11035-8<br>WRZM 8130<br>WRZM 8435-10<br>WRZM 8435-8   |  <p>52367 52210</p>                                   |
| <b>52225</b> | 3 317 0004 00<br>SMB | Rep. Kit for Camshaft<br><br>ø38        | All axles with camshaft dia. 38 mm<br>EBN 3130/12 / 3140 / 3140-6 / 4530 / 4535 / 4540 /<br>4540-6 / 5535 - ES 5030 - RSM 6542<br>ESN 4030 / 4040 / 4540 / 5030 / 5542 / 6030<br>EZN 4030 / 4030/12 / 5030 / 6030<br>RBM 8442 / 8442/12 - RLEBM 8442<br>RLSM 8442 / 9042 / 9042/20 / 11242 - RS 5030<br>RSM 6242/12-8 / 6242/12-10 / 8442 / 8442/8 / 9042<br>/ 9042/20 / 11242 / 6542<br>RZM 8442 / 8442/8 / 11030 / 11242 / 12242 / 13130<br>/ 14242 / 16242<br>RZT 14242 / 16242 - WESN 5030 / 6030<br>WEZN 5030 / 6030 / 6030/12<br>WRLZM 8130 / 8435-8 / 8435-10 / 11030 / 11035-8<br>/ 11035-10 - WZRLZM 8130 / 11030<br>WRZM 6242 / 6242-8 / 8130 / 8435-8 / 8435-10 /<br>8442 / 8442-8 / 11030 / 11035-8 / 11035-10 / 11242 |  <p>52212 52211</p>                                   |

| Auger Nr.    | OEM Nr.       | Description                             | Model   | Picture  |
|--------------|---------------|---|---|--|
| <b>52222</b> | 3 268 0007 01 | Rep. Kit for Camshaft<br><br>ø39xø60x38 | EBN 3130/12 - ES 5030<br>EBN 3140 / 3140-6 / 4040 / 4530 / 4540 / 4540-6<br>ESN 4030 / 4040 / 4540 / 5030 / 5542 / 6030<br>EZN 4030/12 / 5030 / 6030<br>RBM 8442/12 - RS 5030<br>RSM 6242/12-8 / 6242/12-10 / 6542 8442 / 9042/20 / 11242<br>RZM 8442 / 8442-8 / 11242 / 12242 / 14242 / 16242<br>RZT 14242 / 16242<br>SKRS 9037-8 / 9037-10 / 9042/20 / 11242<br>SKRZ 9037-8 / 9037-10 / 9042/20 / 11037-8 / 11242<br>WESN 5030 / 6030-WEZN 5030/6030/12<br>WRZM 6242-8 / 8442-8 / 11242 |  52208 52215                                  |
| <b>52375</b> | 3 434 3600 00 | Rep. Kit for Camshaft<br><br>ø39xø60x38 | ---   |  52206 52368 52373 52208 54870<br>52779 52780 |
| <b>52504</b> | 3 434 3601 00 | Rep. Kit for Camshaft<br><br>ø39xø60x38 | RSM 8442 / 9042 / 11242<br>RBM 8442<br>RLBM 8442<br>RZM 8442 / 11242<br>RLSM 8442 / 9042 / 11242<br>SKRLS 9042 / 11242<br>SKRS 9042 / 11242<br>SKRZ 9042 / 11242<br>WRZM 8442 / 11242   |  52206 52208 52780                           |
| <b>53563</b> | 3 268 0008 01 | Rep. Kit for Camshaft                   | RLBM 8442<br>RLSM 8442<br>RLSM 9042<br>RLSM 9042/20<br>RLSM 11242   |   |
| <b>53566</b> | 3 268 0033 00 | Rep. Kit for Camshaft                   | RLBM 8442<br>RLSM 11242<br>RLSM 8442<br>RLSM 9042<br>RLSM 9042/20<br>SKRLS 11242<br>SKRLS 9042<br>SKRLS 9042/20   |   |
| <b>53568</b> | 3 268 0032 00 | Rep. Kit for Camshaft                   | RLBM 8442<br>RLSM 8442<br>RLSM 9042<br>RLSM 9042/20<br>RLSM 11242<br>SKRLS 9042<br>SKRLS 9042/20<br>SKRLS 11242   |   |

| Auger Nr.    | OEM Nr.       | Description           | Model   | Picture   |
|--------------|---------------|-----------------------|---|---|
| <b>52223</b> | 3 317 0004 00 | Rep. Kit for Camshaft | RSM 6542<br>EBN 3130/12 / 3140 / 3140-6 / 4040 / 4530 / 4535 / 4540 / 4540-6 / 5535<br>ESN 4030 / 4040 / 4540 / 5030 / 5542 / 6030<br>EZN 4030 / 4030/12 / 5030 / 6030<br>RBM 8442 / 8442/12<br>RLBM 8442<br>RLSM 8442 / 9042 / 9042/20 / 11242<br>RS 5030  |    |
| <b>52224</b> | 3 317 0006 00 | Rep. Kit for Camshaft | EBN 3130/12 / 3140-6 / 4040 / 4530 / 4540-6<br>ES 5030<br>ESN 4030 / 4040 / 4540 / 5030 / 5542 / 6030   |    |
| <b>52228</b> | 3 317 0011 00 | Rep. Kit for Camshaft | SKRLS 11242<br>SKRLS 9037 / 9042 / 9042/20<br>SKRLZ 9037 / 11037<br>SKRS 9037-8 / 9037-10 / 9042 / 9042/20 / 9082 / 11242<br>SKRZ 9037-8 / 9037-10 / 9042 / 9042/20 / 11037-8 / 11037-10 / 11242<br>SNK 637/420<br>WRZM 8442  |   |
| <b>52237</b> | 3 317 0010 00 | Rep. Kit for Camshaft | SNK 420<br>SKRS 9042  |  |
| <b>52238</b> | 3 317 0009 00 | Rep. Kit for Camshaft | RSM 9042<br>RSM 9042/20   |  |
| <b>52239</b> | 3 317 0016 00 | Rep. Kit for Camshaft | KRS 12242 / 12242/18 / 14242<br>KRZT 14242 TRILEX / 16242 / 16242 TRILEX<br>SKRLS 9042 / 9042/20/11242<br>SKRLZ 9030 / 11030<br>SKRS 6530 / 6537-8 / 6537-10 / 9030 / 9037-8 / 9037-10 / 11242 / 12242<br>SKRS 9042 / 9042 INTRAAX (SK 1000 ET 0) / SKRS 9042 SK 500 / 9042 SK 1000 ET 0 / 9042/20<br>SKRZ 11030 / 11037-8 / 11037-10 / 11242 / 12030 / 12037 / 12242 |  |

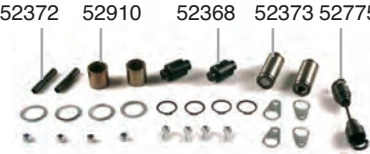





| Auger Nr.    | OEM Nr.       | Description  | Model  | Picture   |
|--------------|---------------|--|--|---|
| <b>52240</b> | 3 317 0036 00 | Rep. Kit for Camshaft  | ---  |    |
| <b>52752</b> | 3 317 0005 00 | Rep. Kit for Camshaft  | camshaft $\varnothing$ 42 mm<br>for axle-type SN420  |    |
| <b>53577</b> | 3 434 3608 00 | Rep. Kit for Brake Shoe<br>$\varnothing$ 20x $\varnothing$ 36x53 | SKRS 6530-11030<br>SKRZ 6530-11030   |   |
| <b>53578</b> | 3 434 3615 00 | Rep. Kit for Brake Shoe<br>$\varnothing$ 20x $\varnothing$ 36x53 | SKRS 6537 - 11037<br>SKRZ 6537 - 11037   |  |
| <b>53581</b> | 3 434 3612 00 | Rep. Kit for Brake Shoe<br>$\varnothing$ 20x $\varnothing$ 36x53 | SK 500<br>SK 9042 / 11242<br>S-, Z-Series 3718<br>S-, Z-Series 3720<br>S-, Z-Series 4218<br>S-, Z-Series 4220<br>KRS(M) / KRZ(M) 14242 |  |
| <b>53582</b> | 3 434 3635 00 | Rep. Kit for Brake Shoe<br>$\varnothing$ 20x $\varnothing$ 36x53 | ---  |  |









| Auger Nr.    | OEM Nr.                            | Description                         | Model   | Picture   |
|--------------|------------------------------------|-------------------------------------|---|---|
| <b>52751</b> | 3 434 3602 00                      | Rep. Kit for Brake Shoe<br>ø31.7    | AXLE TYPES 8442-11242   |    |
| <b>53583</b> | ---                                | Rep. Kit for Brake Shoe<br>ø31.7    | ---   |    |
| <b>53584</b> | ---                                | Rep. Kit for Brake Shoe<br>ø31.7    | ---   |   |
| <b>52781</b> | 3 213 0023 01<br>3 213 0023 02     | Rep. Kit for Brake Shoe<br>ø31.7x73 | EBN 3130/12 / 4530 / 4535 / 5535<br>ESN 4030 / 5030 / 5542 / 6030<br>EZN 4030 / 4030/12 / 5030 / 6030<br>RBM 8442 / 8442/12 - RLBM 8442<br>RLSM 8442 / 9042 / 9042/20 / 11242<br>RS 5030<br>RSM 6242 / 12-8 / 6242/12-10 / 6542 /<br>8442 / 8442-8 / 9042 / 9042/20 / 11242<br>RZM 8442 / 8442-8 / 11030 / 11242 /<br>12242 / 13130 / 14242 / 16242<br>RZT 14242 / 16242 - WESN 5030 / 6030<br>WEZN 5030 / 6030 / 6030/12 |  |
| <b>53562</b> | 3 213 0023 01 S<br>3 213 0023 02 S | Rep. Kit for Brake Shoe<br>ø31.7x73 | EBN 3130/12 / 4530 / 4535 / 5535<br>ESN 4030 / 5030 / 5542 / 6030<br>EZN 4030 / 4030/12 / 5030 / 6030<br>RBM 8442 / 8442/12 - RLBM 8442<br>RLSM 8442 / 9042 / 9042/20 / 11242<br>RS 5030<br>RSM 6242 / 12-8 / 6242/12-10 / 6542 /<br>8442 / 8442-8 / 9042 / 9042/20 / 11242<br>RZM 8442 / 8442-8 / 11030 / 11242 /<br>12242 / 13130 / 14242 / 16242<br>RZT 14242 / 16242 - WESN 5030 / 6030<br>WEZN 5030 / 6030 / 6030/12 |  |
| <b>53997</b> | 3 213 0004 06                      | Rep. Kit for Brake Shoe<br>ø32x183  | ---   |  |

| Auger Nr.    | OEM Nr.                        | Description                         | Model   | Picture   |
|--------------|--------------------------------|-------------------------------------|---|---|
| <b>52373</b> | 1 214 0023 02<br>1 214 0023 01 | Brake Shoe Pin<br><br>ø31.7x73      | RSM 6542<br>EBN 3130/12 / 4530<br>ESN 4030 / 5030 / 5542 / 6030<br>EZN 4030 / 4030/12 / 5030 / 6030   |    |
| <b>52368</b> | 1 265 0007 00                  | Cam Roller<br><br>ø19x31.7x55.5     | RSM 6542<br>EBN 3130/12 / 4530 / 4535 / 5535<br>ESN 4030 / 4030/12 / 5030 / 5542 / 6030<br>EZN 4030 / 5030 / 6030<br>RBM 8442 / 8442-12<br>RLBM 8442<br>RLSM 8442 / 9042 / 9042/20 / 11242<br>RSM 6242/12-8 / 6242/12-10 / 11242<br>RSM 8442 / 8442-8   |    |
| <b>53557</b> | 1 265 0019 00                  | Cam Roller<br><br>ø20xø36x53        | KRS 12242 / 14242 / 12242/18<br>KRZ 16242<br>KRZT 14242 TRILEX<br>SKRS 9042 / 9042/20 / 11242<br>SKRS 6537-8 / 6537-10 / 9030 / 9037-8 / 9037-10 / 11242 / 12242<br>SKRS 9042 / 9042/20 / 9042 INTRAAX / 9042 SK 500 (PLUS) / SK 1000 ET 0<br>SKRZ 11030 / 11037-8 / 11037-10<br>SKRZ 11242 / 12030 / 12037 / 12242<br>SKRZ 6530 / 9030 / 9037-8 / 9037-10 / 9042 / 9042/20<br>SKRZT 12242  |  |
| <b>52369</b> | 1 395 1001 00                  | Brake Fulcrom Pin<br><br>ø6.3x70    | EBN 3130/12 / 4530 - ESN 4030 / 5030 / 6030<br>EZN 4030/12 / 5030 / 6030<br>RBM 8442 / 8442/12 - RLBM 8442<br>RLSM 8442 / 9042 / 9042/20 / 11242<br>RSM 8442 / 8442-8 / 9042 / 9042/20 / 11242<br>RZM 8442 / 8442-8 / 11242 / 13130<br>SKRB 9019 K / 9019 W / 9022 H / 9022 K<br>SKRLS 9037 / 9042 / 9042/20 / 11242<br>SKRLZ 9030 / 9037 / 11030 / 11037<br>SKRS 9019 K / 9022 K / 9030 / 9037-8 / 9037-10<br>SKRS 9042/Intraax/9042/20/11019K/11222K/11242<br>SKRZ 11019 K / 11030 / 11037-8 / 11037-10 / 11242 / 11222 K<br>SKRZ 9022K/9030/9037-8/9037-10 / 9042 / 9042/20<br>SKZRLZ 11030 - WESN 5030 / 6030<br>WEZN 5030 / 6030/12<br>WRLZM 8130 / 8435-8 / 8435-10<br>WRZM 8130 / 8442 / 8442-8 / 11030 / 11242<br>WZRLZM 8130 / 11030 |  |
| <b>52372</b> | 1 395 1013 00                  | Brake Shoe Spring Pin<br><br>ø12x64 | EBN 3130/12 / 4530 / 4535 / 5535<br>ESN 4030 / 5030 / 6030<br>EZN 4030 / 4030/12 / 5030 / 6030<br>RZM 11030 / 13130<br>WESN 5030 / 6030<br>WEZN 5030 / 6030 / 6030/12<br>WRLZM 8130 / 8435-8 / 8435-10 / 11030 / 11035-8 / 11035-10<br>WRZM 8130 / 8435-8 / 8435-10 / 11030 / 11035-8 / 11035-10<br>WZRLZM 8130 / 11030   |  |
| <b>53685</b> | 1 395 1005 00                  | Brake Shoe Spring Pin<br><br>ø12x64 | RSM 6542 - ESN 5542<br>RBM 8442 / 8442/12<br>RLBM 8442<br>RLSM 9042 / 9042/20 / 11242<br>RSM 6242/12-8 / 6242/12-10 / 8442<br>8442/8 9042 9042/20 / 11242<br>RZM 8442 / 8442/8 / 11242 / 12242 / 14242 / 16242 - RZT 14242 / 16242<br>WRZM 6242/ 6242-8/ 8442/8442-8/11242  |  |

| Auger Nr.    | OEM Nr.   | Description                                  | Model   | Picture   |
|--------------|---|--|---|---|
| <b>52205</b> | 4 230 0176 00                                   | Brake Camshaft Bushing<br><br>ø56xø60x33     | SKRS 9037-8 / 9037-10 / 9042 / 9042/20 / 11242<br>SKRLS 9042 / 9042/20 / 11242<br>SKRZ 9037-8 / 9037-10 / 9042 / 11037-8 / 11037-10 / 11242   |    |
| <b>52206</b> | 1 230 0106 04<br>1 230 0106 02<br>1 230 0106 03 | Brake Camshaft Bushing<br><br>ø38.2xø42x44.8 | EBN 3130/12 / 3140 / 3140-6 / 4040 / 4530 / 4535 / 4540 / 4540-6 / 5535<br>ESN 4030 / 4040 / 4540 / 5030 / 5542 / 6030<br>EZN 4030 / 4030/12 / 5030 / 6030<br>RS 5030 - RBM 8442 / 8442/12 - ES 5030<br>RLBM 8442 - RZT 14242 / 16242<br>RLSM 8442 / 9042 / 9042/20 / 11242<br>RSM 6542 / 6542/12-8 / 6542/12-10 / 8442 / 8442-8 / 9042 / 9042/20 / 11242<br>RZM 8442 / 8442-8 11030 / 11242 / 12242 / 13130 / 14242 / 16242<br>SKRLZ 9037 / 9042 / 9042/20 / 11037 / 11242 - WESN 5030 / 6030<br>WEZN 5030 / 6030 / 6030/12<br>WRLZM -8 / 8130 / 8435-10 / 11030 / |    |
| <b>52363</b> | 1 230 0035 00                                   | Brake Shoe Bushing<br><br>ø32xø36x40         | ---   |  |
| <b>52365</b> | 1 230 0144 00                                   | Brake Camshaft Bushing<br><br>ø38xø42x30     | ---   |  |
| <b>52366</b> | 4 230 0180 00                                   | Brake Camshaft Bushing<br><br>ø46xø50x40     | KRZ 14242 / 14242 TRILEX<br>SKRLS 9037 / 9042 / 9042/20 / 11242<br>SKRLZ 9030 / 9037 / 11030 / 11037<br>SKRS 11242 / 9042 (INTRAAX) / 9042/20<br>SKRS 6537-8 / 6537-10 / 9030 / 9037-8 / 9037-10<br>SKRZ 9042/20 / 11030 / 11037-8 / 11037-10 / 11242 / 12030   |  |
| <b>52910</b> | 1 230 0084 01<br>1 230 0084 00                  | Brake Shoe Bushing<br><br>ø32xø35x36.5       | ---   |  |

| Auger Nr.    | OEM Nr.   | Description                              | Model   | Picture   |
|--------------|---|--|---|---|
| <b>53556</b> | 4 230 0172 01                                   | Brake Camshaft Bushing<br><br>ø55xø60x40 | SKRS 9042<br>SKRS 9042/20   |    |
| <b>54282</b> | 1 230 0032 00                                   | Brake Shoe Bushing<br><br>ø32xø36x32     | ---   |    |
| <b>52214</b> | 1 350 2001 04                                   | Retainer<br><br>ø8.5/ø90xø60x12.5        | EBN 3130/12 / 3140 / 4040 / 4535<br>EBN 4540 / 4540-6 / 5535 - v<br>ESN 4030 / 4040 / 4540 / 5030 / 5542 / 6030<br>EZN 5030 / 6030 / 8442 / 8442/12<br>RSM 8442-8 / 6542/12-8 / 6542/12-10 /<br>9042 / 9042/20 / 11242<br>RZM 8442 / 8442-8 / 11242 / 12242 / 14242<br>/ 16242 - WESN 5030 / 6030<br>RZT 14242 / 16242<br>SKRS 9030 / 9037-8 / 9037-10 / 9042<br>(INTRAAX) / 9042/20 / 11242<br>SKRZ 9030 / 9037-8 / 9037-10 / 9042 /<br>9042/20 / 11037-10 / 11037-8 / 11242<br>WESN 5030 / 6030 / 6030/12<br>WRZM 6242/ 6242-8/ 8442/ 8442-8/ 11242 |  |
| <b>52215</b> | 1 350 2001 03<br>1 350 2001 02<br>1 350 2001 01 | Retainer<br><br>ø8.5/ø90xø60x12          | RSM 6542<br>EBN 3140 / 3140-6 / 4040 / 4540 / 4540-6<br>ESN 4040 / 4540 / 5542<br>EZN 5030<br>RBM 8442 / 8442/12<br>RSM 11242 / 6242/12-10 / 6242/12-8 /<br>8442<br>RZM 8442  |  |
| <b>52216</b> | 1 350 2002 01                                   | Retainer<br><br>ø70x13                   | WRZM 8435-8 / 8435-10<br>WRZM 11035-8 / 11035-10  |  |
| <b>52367</b> | 1 350 2005 00                                   | Retainer<br><br>ø70x13                   | RZM 11030<br>RZM 13130<br>WRZM 11030<br>WRZM 11035-10<br>WRZM 11035-8<br>WRZM 8130<br>WRZM 8435-10<br>WRZM 8435-8<br>WRZM 8442  |  |

| Auger Nr.    | OEM Nr.                        | Description                             | Model   | Picture   |
|--------------|--------------------------------|---|---|---|
| <b>52207</b> | 1 230 1002 04<br>3 230 1002 04 | Spherical Bearing<br><br>ø38xø60x55     | EBN 3130/12 / 3140 / 3140-6 / 4040 / 4530 / 4535 / 4540 / 4540-6 / 5535<br>ES 5030 / RS 5030<br>ESN 4030 / 4040 / 4540 / 5030 / 5542 / 6030<br>EZN 4030 / 4030/12 / 5030 / 6030<br>RBM 8442 / 8442/12<br>RSM 11242 / 6542 / 6542/12-10 / 6542/12-8 / 8442 / 8442-8 / 9042 / 9042/20<br>RZM 8442 / 8442-8 / 11242 / 12242 / 14242 / 16242<br>RZT 14242 / 16242<br>SKRS 9030 / 9037-8 / 9037-10 / 9042 (INTRAAX) / 9042/20 / 11242<br>SKFZ 9037-8 / 9037-10 / 9042 / 9042/20 / 11030 / 11037-8 / 11037-10 / 11242<br>WESN 5030 / 6030 |    |
| <b>52208</b> | 1 230 1002 03                  | Spherical Bearing<br><br>ø39xø60x38     | ---   |    |
| <b>52209</b> | 1 230 1001 01<br>1 230 1001 00 | Spherical Bearing<br><br>ø42.5xø59.5x38 | ---   |   |
| <b>52210</b> | 1 230 2001 01<br>3 230 2001 01 | Spherical Bearing<br><br>ø38xø70x63     | RZM 11030 / 13130<br>WRZM 8130 / 8435-8 / 8435-10 / 11030 / 11035-8 / 11035-10  |  |
| <b>52211</b> | 1 072 0018 00<br>1 072 0018 01 | Camshaft Bushing<br><br>ø38xø48x22.5    | ---   |  |
| <b>52212</b> | 1 072 0017 01                  | Camshaft Bushing<br><br>ø38xø48x22.5    | ---   |  |

| Auger Nr.    | OEM Nr.       | Description  | Model   | Picture   |
|--------------|---------------|--|---|---|
| <b>52241</b> | 3 005 0147 00 | Dust Cover Set<br>Phosphated & Painted<br><br>ø150xø462x34 | RSM 6542<br>RSM 9042  |    |
| <b>52242</b> | 3 005 0173 00 | Dust Cover Set<br>Phosphated & Painted<br><br>ø145xø452x32 | KRS 12242 / 12242/18 / 14242<br>KRZ 16242<br>KRZT 16242 TRILEX<br>SKRS 9042 / 11242 / 12242<br>SKRS 9042 INTRAAX (SK 1000 ET 0)<br>SKRS 9042 SK 1000 ET 0<br>SKRS 9042/20 / 9042 SK 500 (PLUS)<br>SKRZ 9042 / 9042/20 / 11242 / 12242 |    |
| <b>52243</b> | 3 005 0117 01 | Dust Cover Set<br>Phosphated & Painted<br><br>ø149xø460x46 | RSM 9042/20   |   |
| <b>52244</b> | 3 005 0141 00 | Dust Cover Set<br>Phosphated & Painted<br><br>ø145xø452x31 | SKRS 9042<br>SKRS 9042/20<br>SKRS 11242<br>SKRZ 9042<br>SKRZ 9042/20<br>SKRZ 11242  |  |
| <b>52245</b> | 3 005 0055 00 | Dust Cover Set<br>Phosphated & Painted<br><br>ø149xø295x50 | WRZM 8130<br>RZM 11030<br>WRZM 11030<br>RZM 13130   |  |
| <b>52246</b> | 3 005 0009 02 | Dust Cover Set<br>Phosphated & Painted<br><br>ø230xø467x65 | RLSM 11242<br>RSM 11242<br>RZM 8442 / 8442-8 / 11242 / 12242 /<br>13130 / 14242 / 16242<br>RZT 14242 / 16242<br>WRZM 6242 / 6242-8 / 8442 / 8442-8 /<br>11242   |  |

| Auger Nr.    | OEM Nr.       | Description  | Model  | Picture   |
|--------------|---------------|--|--|---|
| <b>52377</b> | 3 005 0108 00 | Dust Cover Set<br>Phosphated & Painted<br><br>ø127xø397x24 | WRZM 11035-10<br>WRZM 11035-8<br>WRZM 8435-10<br>WRZM 8435-8 |    |
| <b>53062</b> | 3 005 0037 03 | Dust Cover Set<br>Phosphated & Painted<br><br>ø230xø465x54 | RBM 8442<br>RSM 8442<br>RSM 8442-8<br>RLBM 8442<br>RLSM 8442 |    |
| <b>53171</b> | ---           | Dust Cover Set<br>Phosphated & Painted<br><br>ø230xø445x65 | ---  |   |
| <b>53585</b> | 3 005 0177 00 | Dust Cover Set<br>Phosphated & Painted<br><br>ø155xø450x29 | SKRZT 12242<br>SKRLS 9042<br>SKRLS 9042/20<br>SKRLS 11242    |  |
| <b>53586</b> | 3 005 0135 00 | Dust Cover Set<br>Phosphated & Painted<br><br>ø150xø462x32 | RLBM 8442<br>RLSM 9042                                       |  |
| <b>53587</b> | 3 005 0139 00 | Dust Cover Set<br>Phosphated & Painted<br><br>ø150xø462x46 | RLSM 9042/20<br>RLSM 11242                                   |  |

| Auger Nr.    | OEM Nr.       | Description  | Model  | Picture   |  |
|--------------|---------------|--|--|---|--|
| <b>53588</b> | 3 005 0149 00 | Dust Cover Set<br>Phosphated & Painted<br><br>ø155xø452x27 | SKRLS 9042<br>SKRLS 9042/20<br>SKRLS 11242   |    |  |
| <b>53589</b> | 3 005 0159 00 | Dust Cover Set<br>Phosphated & Painted<br><br>ø127xø400x29 | SKRS 9037-8<br>SKRS 9037-10<br>SKRZ 9037-8<br>SKRZ 9037-10<br>SKRZ 11037-8<br>SKRZ 11037-10  |    |  |
| <b>53590</b> | 3 005 0053 00 | Dust Cover Set<br>Phosphated & Painted<br><br>ø149xø295x23 | EBN 3130/12<br>ESN 4030<br>EZN 4030<br>EZN 4030/12<br>EBN 4530<br>ESN 5030<br>EZN 5030<br>WESN 5030<br>WEZN 5030<br>ESN 6030<br>EZN 6030 | WESN 6030<br>WEZN 6030<br>WEZN 6030/12  |  |
| <b>53591</b> | 3 005 0045 00 | Dust Cover Set<br>Phosphated & Painted<br><br>ø230xø413x21 | ESN 5542<br>RSM 6242/12-8<br>RSM 6242/12-10<br>RBM 8442/12   |  |  |
| <b>53592</b> | 3 005 0125 00 | Dust Cover Set<br>Phosphated & Painted<br><br>ø127xø397x31 | WRZM 8435-8<br>WRZM 8435-10<br>WRZM 11035-8<br>WRZM 11035-10   |  |  |
| <b>53593</b> | 3 005 0161 00 | Dust Cover Set<br>Phosphated & Painted<br><br>ø127xø331x37 | SKRZ 6530<br>SKRS 9030<br>SKRZ 9030<br>SKRZ 11030<br>SKRZ 12030  |  |  |



| Auger Nr.    | OEM Nr.       | Description  | Model   | Picture   |
|--------------|---------------|--|---|---|
| <b>53594</b> | 3 005 0171 00 | Dust Cover Set<br>Phosphated & Painted<br><br>ø127xø400x25 | SKRS 9037-8<br>SKRS 9037-10<br>SKRZ 9037-8<br>SKRZ 9037-10<br>SKRZ 11037-8<br>SKRZ 11037-10<br>SKRZ 12037   |                                        |
| <b>53596</b> | 3 005 0183 00 | Dust Cover Set<br>Phosphated & Painted<br><br>ø155xø331x26 | SKRLZ 9030<br>SKRLZ 11030   |                                        |
| <b>53597</b> | 3 005 0057 00 | Dust Cover Set<br>Phosphated & Painted<br><br>ø140xø349x34 | EBN 4535<br>EBN 5535  |                                       |
| <b>53598</b> | 3 005 0079 00 | Dust Cover Set<br>Phosphated & Painted<br><br>ø149xø295x50 | WRLZM 8130<br>WRLZM 11030   |                                      |
| <b>53599</b> | 3 005 0209 01 | Dust Cover Set<br>Phosphated & Painted<br><br>ø155xø295x50 | SKRLZ 9037<br>SKRLZ 11037   |                                      |
| <b>54559</b> | 3 434 3827 01 | Rep. Kit for Brake Caliper<br><br>Wabco Type               | SK RB 9022 W<br>SK RB 9022 WI INTEGRAL<br>SK RS 9019 W<br>SK RS 9022 W<br>SK RS 11019 W<br>SK RS 11222 W<br>SK RZ 9019 W<br>SK RB 9019 W<br>SK RZ 9022 W<br>SK RZ 11019 W<br>SK RZ 11222 W<br>SK RB 9019 WI INTEGRAL<br>BI9-22W-6<br>B9-22W | <br>55299 55323 55334<br>55337 55354 |

**Diaphragms - Normal Stroke**
**Auger Nr.: 52576**

O.E.M. Nr. —

Type 9"

**Auger Nr.: 52578**

O.E.M. Nr. —

Type 12"

**Auger Nr.: 52580**

O.E.M. Nr. —

Type 16"

**Auger Nr.: 52581**

O.E.M. Nr. —

Type 20"

**Auger Nr.: 52582**

O.E.M. Nr. —

Type 24"

**Auger Nr.: 52583**

O.E.M. Nr. —

Type 30"

**Auger Nr.: 52584**

O.E.M. Nr. —

Type 36"

**Diaphragms - Long Stroke**
**Auger Nr.: 52585**

O.E.M. Nr. —

Type 16"

**Auger Nr.: 52586**

O.E.M. Nr. —

Type 20"

**Auger Nr.: 52587**

O.E.M. Nr. —

Type 24"

**Auger Nr.: 52588**

O.E.M. Nr. —

Type 30"





| Auger Nr.    | OEM Nr.                        | Description  | Model | Picture   |
|--------------|--------------------------------|--|-------|---|
| <b>21004</b> | ---                            | Service Brake Chamber<br>for disc brake<br><br>T16 STR 57<br><br>97.5/111.5xM16x1.5x164                  | ---   |    |
| <b>21005</b> | 3 454 1065 60<br>3 454 1081 60 | Service Brake Chamber<br>for disc brake<br>with rep. kit<br><br>T16 STR 57<br><br>97.5/111.5xM16x1.5x164 | ---   |    |
| <b>21006</b> | ---                            | Service Brake Chamber<br>for disc brake<br>T20 STR 64<br><br>105xM16x1.5x174                             | ---   |   |
| <b>21007</b> | 3 454 1067 60<br>3 454 1082 60 | Service Brake Chamber<br>for disc brake<br>with rep. kit<br>T20 STR 64<br><br>105/121xM16x1.5x174        | ---   |  |
| <b>21008</b> | ---                            | Service Brake Chamber<br>for disc brake<br>T24 STR 64<br><br>103xM16x1.5x186                             | ---   |  |
| <b>21009</b> | 3 454 1069 60                  | Service Brake Chamber<br>for disc brake<br>with rep. kit<br>T24 STR 64<br><br>103/117.5xM16x1.5x186      | ---   |  |

| Auger Nr.    | OEM Nr.       | Description   | Model   | Picture   |
|--------------|---------------|---|---|---|
| <b>21016</b> | ---           | Service Brake Chamber<br>(For Drum Brake)<br><br>117,5/131xM16x1.5<br><br>T30 STR 75                      | ---   |    |
| <b>21017</b> | 4 454 1039 00 | Service Brake Chamber<br>(For Drum Brake)<br>(with repair kit)<br><br>117,5/131xM16x1.5<br><br>T30 STR 75 | ---   |    |
| <b>31029</b> | 4 079 0004 00 | Brake Disc<br><br>211x377   | SK RS 9019K/W/11019W/SK RZ<br>9019K/W /11019K/W |   |
| <b>31030</b> | 4 079 0005 01 | Brake Disc<br><br>196.1x430   | SKRB 9022 H / W / K                             |  |
| <b>31031</b> | 4 079 0007 01 | Brake Disc<br><br>196.1x377   | SKRB 9019 W / K                                 |  |

| Auger Nr.    | OEM Nr.       | Description                  | Model   | Picture   |
|--------------|---------------|------------------------------|---|---|
| <b>52360</b> | 1 304 0016 00 | Hub Cap<br>ø9/140xø165x42.5  | RBM 8442 / 8442/12<br>RLBM 8442<br>RLSM 8442 / 11242<br>RSM 6242-8 / 6242/12-10 / 8442 / 8442-8 / 11242<br>RZM 8442 / 8442-8 / 1130 / 11242 / 12242<br>SKRZT 12242<br>WRLZM-8 / 8130 / 8435-10 / 11030 / 11035-8 / 11035-10<br>WRZM 6242 / 6242-8 / 8130 / 8435-8 / 8435-10 / 8442<br>WRZM 8442-8 / 11030 / 11035-8 / 11035-10 / 11242<br>WZRLZM 8130 / 11030     |    |
| <b>52361</b> | 1 304 0046 01 | Hub Cap<br>ø9/185xø205x39.5  | RSM 6542 / 9042 / 9042/20<br>RLSM 9042 / 9042/20  |    |
| <b>54283</b> | 3 304 0086 00 | Hub Cap<br>ø163.5x66         | SK RZ 6530<br>SK RS 9030<br>SK RZ 9030<br>SK RZ 11030<br>SK RZ 12030<br>SK RZ 12037<br>SK RS 9042 SK 500 (PLUS)<br>SK RS 12242<br>SK RZ 12242<br>KRS 12242/18<br>KRS 12242  |   |
| <b>54284</b> | 4 304 0093 00 | Hub Cap<br>ø131x37.5         | SK RB 9019 K (SN 6)<br>SK RB 9019 W<br>SK RB 9022 K<br>SK RB 9022 K (SK 7)<br>SK RB 9022 W<br>SK RB 9022 H<br>SK RB 9022 H (MK IV)  |  |
| <b>52777</b> | 1 093 0005 00 | Axle Gasket<br>ø119xø158x1   | RBM 8442 / 8442/12<br>RLBM 8442<br>RLSM 8442 / 11242<br>RSM 6242/12-8 / 6242/12-10 / 8442 / 8442-8 / 11242<br>RZM 8442 / 8442-8 / 11030 / 11242 / 12242<br>WRLZM-8 / 8130 / 8435-10 / 11030 / 11035-8 / 11035-10<br>SKRZT 12242<br>WRZM 6242 / 6242-8 / 8130 / 8435-8 / 8435-10 / 8442 / 8442-8<br>WRZM 11030 / 11035-8 / 11035-10 / 11242<br>WZRLZM 8130 / 11030 |  |
| <b>52778</b> | 1 093 0012 00 | Axle Gasket<br>ø165xø9/185x1 | RSM 6542<br>RSM 9042<br>RSM 9042/20<br>RLSM 9042<br>RLSM 9042/20  |  |

| Auger Nr.    | OEM Nr.       | Description                            | Model   | Picture   |
|--------------|---------------|--|---|---|
| <b>54644</b> | 4 230 0170 00 | Axle Bearing Bushing<br><br>ø60xø65x70 | RLBM 8442<br>RLSM 8442/9042/11242<br>RLSM 9042/20<br>SK RLB 9019/9019 IO/IU<br>SK RLB 9022/9022 IO/IU<br>SK RLS 9037/11242<br>SK RLS 9042/9042/20<br>SK RLZ 11030/11037/9030/9037<br>SK ZRLZ 12030 - SKRLB/SKRLS (Z)<br>SK ZRLZ 11030 - SL11-4220<br>SL9-3718/4218 - SZL11-4218/4220<br>WRLZM 11030/11035-8/11035-10<br>WRLZM 8130/8435-8/8435-10<br>WZRLZM 8130/11030<br>ZL11-3020/3720/4220<br>ZL8-3718 - ZL9-3020/3720   |    |
| <b>52176</b> | 1 011 0007 00 | Axle Nut<br><br>M42x3/SW65             | RS 5030<br><br>ESN 4540 / 5542 / 6030 / 5030 / 6030<br><br>EZN 5030 / 6030<br><br>WESN 5030 / 6030<br><br>WEZN 5030 / 6030 / 6030/12<br><br>EBN 5535  |    |
| <b>54003</b> | 4 011 0039 01 | Axle Nut<br><br>M56x2xSW85             | KRS 12242 / 12242/18 - RBM 8442 / 8442/12<br>RLBM 8442 - RLSM 8442 / 11242<br>RSM 6242/12-8 /6242 /12-10 /8442 /8442-8 /11242<br>RZM 8442 / 8442-8 / 11030 / 11242 / 12042<br>SKRLZ 9030 / 11030<br>SKRS 9030 / 9042 SK 500 (PLUS) / 12242<br>SKRZ 6530 / 9030 / 11030 / 12030 / 12037 / 12242<br>SKRZT 12242 - SKZRLZ 11030 / 12030<br>WRLZM 8130 / 8435-8 / 8435-10 / 11030 / 11035-8 / 11035-10<br>WRZM 11030 / 11035-8 / 11035-10<br>WRZM 6242 / 6242-8 / 11242<br>WRZM 8130 / 8435-8 / 8435-10 / 8442 / 8442-8<br>WZRLZ 8130 / 11030 |   |
| <b>54004</b> | 2 011 0040 01 | Axle Nut<br><br>M56x2xSW85             | ---   |  |
| <b>54277</b> | 1 011 0080 00 | Axle Nut,Right<br><br>M72x1.5 R/SW85   | SK RB 9019 K (SN6)<br>SK RB 9019 KI (SN6) INTEGRAL<br>SK RB 9019 W<br>SK RB 9019 WI INTEGRAL<br>SK RB 9022 K<br>SK RB 9022 K (SK7)<br>SK RB 9022 KI (SN 7)INTEGRAL<br>SK RB 9022 KI (SK 7)INTEGRAL<br>SK RB 9022 W<br>SK RB 9022 WI INTEGRAL<br>SK RB 9022 H<br>SK RB 9022 H (MK IV)<br>SK RLB 9019<br>SK RLB 9019 IO/IU<br>SK RLB 9022<br>SK RLB 9022 IO/IU  |  |
| <b>54278</b> | 1 011 0081 00 | Axle Nut,Left<br><br>M72x1.5 L/SW85    | SK RB 9019 K (SN6)<br>SK RB 9022 W<br>SK RB 9019 KI (SN6) INTEGRAL<br>SK RB 9022 WI INTEGRAL<br>SK RB 9019 W<br>SK RB 9022 H<br>SK RB 9019 WI INTEGRAL<br>SK RB 9022 H (MK IV)<br>SK RB 9022 K<br>SK RLB 9019<br>SK RB 9022 K (SK7)<br>SK RLB 9019 IO/IU<br>SK RB 9022 KI (SN 7)INTEGRAL<br>SK RLB 9022<br>SK RB 9022 KI (SK 7)INTEGRAL<br>SK RLB 9022 IO/IU  |  |

| Auger Nr.    | OEM Nr.       | Description                          | Model  | Picture   |
|--------------|---------------|--------------------------------------|--|---|
| <b>54279</b> | 1 011 0070 01 | Axle Nut,Right<br><br>M120x2 R/SW140 | SKRLS 9042 / 9042/20 / 11242<br>SKRS 11019 W / 11222 K (SK7) / 11222 K (SN7) / 11242<br>SKRS 9019 W / 9019K (SN6) / 9022 H (MK IV) / 9022 K (SK 7) / 9022 K (SN 7) / 9022 W<br>SKRS 9042 / 9042/20 / 9042 INTRAAX (SK 1000 ET 0) / 9042 SK 1000 ET 0<br>SKRZ 11019 K (SN 6) / 11019 W / 11222 K (SK7) / 11222 K (SN7) / 11222 W / 11242<br>SKRZ 9019 W / 9019K (SN6) / 9022 K (SK 7) / 9022 K (SN 7) / 9022 W / 9042 / 9042/20   |    |
| <b>54280</b> | 1 011 0071 01 | Axle Nut,Left<br><br>M120x2 L/SW140  | SKRLS 9042 / 9042/20 / 11242<br>SKRS 11222 K (SN7) / 11242 / 9019 W / 9019K (SN6)<br>SKRS 9022 H (MK IV) / 9022 K (SK 7) / 9022 K (SN 7) / 9022 W<br>SKRS 9042 / 9042/20 / 9042 INTRAAX (SK 1000 ET 0) / 9042 SK 1000 ET 0<br>SKRZ 11019 K (SN 6) / 11222 K (SN7) / 11222 K (SK7) / 11222 W / 11242<br>SKRZ 9022 K (SK 7) / 9019 W / 9019K (SN6)<br>SKRZ 9042 / 9042/20 / 9022 W / 11019W  |    |
| <b>54005</b> | 1 345 0008 01 | Lock Washer<br><br>ø56.5xø93x4.5     | KRS 12242 / 12242/18 - RBM 8442 / 8442/12<br>RLBM 8442 - RLBM 8442 / 11242<br>RSM 6242/12-8 / 6242/12-10 / 8442 / 8442-8 / 11242<br>RZM 8442 / 8442-8 / 11030 / 11242 / 12042<br>SKRLZ 9030 / 11030<br>SKRS 9030 / 12242 / 9042 SK 500 (PLUS)<br>SKRZ 6530/9030/11030/12030/12037/12242<br>SKZRLZ 11030 / 12030 - SKRZT 12242<br>WRLZM 8130 / 8435-8 / 8435-10/11030 / 11035-8 / 11035-10<br>WRZM 8435-10 / 11030 / 11035-8 / 11035-10 / 11242<br>WRZM 6242 / 6242-8 / 8130 / 8442 / 8442-8 / 8435-8<br>WZRLZ 8130 / 11030 |  |





# 15

## TRAILOR









| Group                       | Page |
|-----------------------------|------|
| Spring Suspension . . . . . | 001  |
| Brake . . . . .             | 003  |
| Axle & Wheel . . . . .      | 010  |





| Auger Nr. | O.E.M. Nr. | A       | B    | C     | Type | Repair Kit        |
|-----------|------------|---------|------|-------|------|-------------------|
| 54029     | 6113300 A  | M16x1.5 | 164  | SW 24 | 1    | 53755             |
| 54043     | 6502176 T  | M24x3   | 140  | SW 42 | 1    | 53764-53765-53770 |
| 54044     | 6504212 Z  | M30x3.5 | 200  | SW 46 | 1    | 53766             |
| 54048     | 2033000 M  | M20x2.5 | 150  | SW 30 | 1    | 53768-53769       |
| 53299     | 6401000 J  | M20x2.5 | 20   | SW 30 | 2    | 53768-53769       |
| 54049     | 6114000 K  | M16x1.5 | 16   | SW 24 | 2    | 53755             |
| 54051     | -          | M30x3.5 | 27.1 | SW 46 | 2    | 53766             |
| 54050     | -          | M24x3   | 24   | SW 36 | 2    | 53764-53765-53770 |

| Auger Nr.    | OEM Nr.   | Description                                   | Model | Picture   |
|--------------|-----------|---|-------|---|
| <b>52217</b> | 6504210 X | Rubber Bushing for Spring<br>ø30xø68x104      | -     |  |
| <b>53745</b> | 6115000 X | Rubber Bushing for Spring<br>ø19/35xø85.5x113 | -     |  |
| <b>53746</b> | 6127000 M | Rubber Bushing for Spring<br>ø25xø48.5x76     | -     |  |
| <b>53747</b> | 2210000 Z | Rubber Bushing for Spring<br>ø32xø64x55       | -     |  |

| Auger Nr.    | OEM Nr.       | Description   | Model | Picture   |
|--------------|---------------|---|-------|---|
| <b>53764</b> | 6502105 Z     | Rep. Kit Spring Bolt Assembly, Single<br><br>ø25xø48.5x76 | -     |    |
| <b>53765</b> | 6502105 Z (S) | Rep. Kit Spring Bolt Assembly, Double<br><br>ø25xø48.5x76 | -     |    |
| <b>53766</b> | -             | Rep. Kit Spring Bolt Assembly<br><br>ø30xø68x104          | -     |   |
| <b>53768</b> | 2211015 T     | Rep. Kit Spring Bolt Assembly<br><br>ø32xø64x55           | -     |  |
| <b>53769</b> | -             | Rep. Kit Spring Bolt Assembly<br><br>M20x2.5/150          | -     |  |
| <b>53770</b> | -             | Rep. Kit Spring Bolt Assembly<br><br>M24x3/140            | -     |  |
| <b>53755</b> | -             | Rep. Kit Spring Bolt Assembly<br><br>ø19/35xø85.5x113     | -     |  |

## Diaphragms - Normal Stroke

**Auger Nr.: 52576**

O.E.M. Nr. —

Type 9"

**Auger Nr.: 52578**

O.E.M. Nr. —

Type 12"

**Auger Nr.: 52580**

O.E.M. Nr. —

Type 16"

**Auger Nr.: 52581**

O.E.M. Nr. —

Type 20"

**Auger Nr.: 52582**

O.E.M. Nr. —

Type 24"

**Auger Nr.: 52583**

O.E.M. Nr. —

Type 30"

**Auger Nr.: 52584**

O.E.M. Nr. —

Type 36"



## Diaphragms - Long Stroke

**Auger Nr.: 52585**

O.E.M. Nr. —

Type 16"

**Auger Nr.: 52586**

O.E.M. Nr. —

Type 20"

**Auger Nr.: 52587**

O.E.M. Nr. —





Type 24"

**Auger Nr.: 52588**

O.E.M. Nr. —

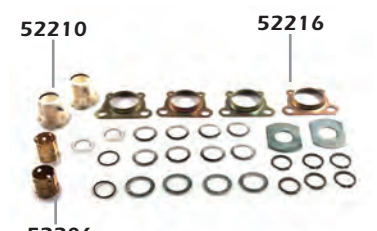
Type 30"

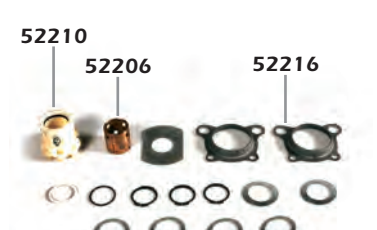
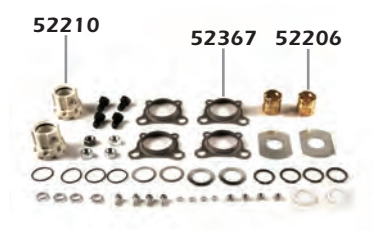

| Auger Nr.    | OEM Nr.       | Description                                     | Model | Picture   |
|--------------|---------------|---|-------|---|
| <b>52275</b> | 6502103 X     | Rep. Kit for Camshaft, Double<br><br>ø38xø70x63 | -     |  <p>52210 52216 52212 52211</p>  |
| <b>52276</b> | 6503723 T     | Rep. Kit for Camshaft, Double<br><br>ø38xø70x63 | -     |  <p>52210 52216<br/>52206</p>    |
| <b>53753</b> | 6502103 X (S) | Rep. Kit for Camshaft, Single<br><br>ø38xø70x63 | -     |  <p>52210 52216 52212 52211</p> |
| <b>53754</b> | 6503723 T (S) | Rep. Kit for Camshaft, Single<br><br>ø38xø70x63 | -     |  <p>52210 52206 52216</p>      |
| <b>53762</b> | -             | Rep. Kit for Camshaft<br><br>ø38xø70x63         | -     |  <p>52210 52367 52206</p>      |
| <b>54675</b> | -             | Rep. Kit for Camshaft<br><br>ø38xø70x63         | -     |  <p>52367 52210 52247</p>      |

| Auger Nr.    | OEM Nr.       | Description                                 | Model | Picture  |
|--------------|---------------|---|-------|--|
| <b>53165</b> | M 010676      | Rep. Kit for Camshaft<br>ø38x509            | -     |  <p>52367</p>                           |
| <b>53841</b> | M 050147      | Rep. Kit for Camshaft<br>ø38x456            | -     |  <p>52216</p>                           |
| <b>53756</b> | 6503338 F     | Rep. Kit for Brake Shoe,<br>Single<br>ø31.7 | -     |  <p>52775 53752 54916 52368</p>        |
| <b>53757</b> | 6503338 F (S) | Rep. Kit for Brake Shoe,<br>Double<br>ø31.7 | -     |  <p>54916 53752 52775 52368</p>       |
| <b>53758</b> | 6502102 W     | Rep. Kit for Brake Shoe,<br>Single<br>ø31.7 | -     |  <p>52891 52921 52368 52910 54916</p> |
| <b>53759</b> | 6502102 W (S) | Rep. Kit for Brake Shoe,<br>Double<br>ø31.7 | -     |  <p>52891 52921 52368 52910 54916</p> |





| Auger Nr.    | OEM Nr.       | Description                              | Model | Picture   |
|--------------|---------------|--|-------|---|
| <b>53767</b> | 6502101 T     | Rep. Kit for Brake Shoe                  | -     |    |
| <b>53760</b> | 6504775 W     | Rep. Kit for Brake Shoe, Single<br>ø31.7 | -     |    |
| <b>53761</b> | 6504775 W (S) | Rep. Kit for Brake Shoe, Double<br>ø31.7 | -     |   |
| <b>53763</b> | -             | Rep. Kit for Brake Shoe<br>ø31.7         | -     |  |
| <b>53771</b> | -             | Rep. Kit for Brake Shoe, Single<br>ø31.7 | -     |  |
| <b>53772</b> | -             | Rep. Kit for Brake Shoe, Double<br>ø31.7 | -     |  |



| Auger Nr.    | OEM Nr.   | Description                                     | Model | Picture  |
|--------------|-----------|---|-------|--|
| <b>53773</b> | -         | Rep. Kit for Brake Shoe,<br>Single<br><br>ø31.7 | -     |  <p>52368 52910 53752 52891<br/>54916</p> |
| <b>53774</b> | -         | Rep. Kit for Brake Shoe,<br>Double<br><br>ø31.7 | -     |  <p>52910 52368 53752 52891<br/>54916</p> |
| <b>52921</b> | 1652010 R | Brake Shoe Pin<br><br>ø31.7x70                  | -     |   |
| <b>53752</b> | 6502382 B | Brake Shoe Pin<br><br>ø31.7x88                  | -     |   |
| <b>52368</b> | 1642000 S | Cam Roller<br><br>ø19x31.7x55.5                 | -     |   |
| <b>54831</b> | 6504774 T | Lock Plate<br><br>ø19,5x52,5                    | -     |   |
| <b>54916</b> | 1646000 J | Brake Shoe Spring Pin<br><br>ø6x15              | -     |   |

| Auger Nr.    | OEM Nr.   | Description                              | Model | Picture   |
|--------------|-----------|--|-------|---|
| <b>52775</b> | 6501811 Y | Brake Shoe Spring<br>ø29x168             | -     |    |
| <b>52891</b> | 1643000 C | Brake Shoe Spring<br>ø28.5x202           | -     |    |
| <b>53849</b> | 7000107 D | Brake Shoe Spring<br>ø28x176             | -     |   |
| <b>52206</b> | 6503721 R | Brake Camshaft Bushing<br>ø38.2xø42x44.8 | -     |  |
| <b>52910</b> | 1650000 S | Brake Shoe Bushing<br>ø32xø35x36.5       | -     |  |
| <b>52216</b> | 1669000 G | Retainer<br>ø70x13                       | -     |  |
| <b>52367</b> | -         | Retainer<br>ø70x13                       | -     |  |

| Auger Nr.    | OEM Nr.   | Description  | Model | Picture   |
|--------------|-----------|--|-------|---|
| <b>52210</b> | 1639000 W | Spherical Bearing<br><br>ø38xø70x63                      | -     |    |
| <b>52211</b> | 1656000 E | Camshaft Bushing<br><br>ø38xø48x22.5                     | -     |    |
| <b>52212</b> | 1655000 W | Camshaft Bushing<br><br>ø38xø48x22.5                     | -     |    |
| <b>52271</b> | 6502810 F | Dust Cover<br>Phosphated & Painted<br><br>ø227.5xø463x66 | -     |  |
| <b>52272</b> | 6504785 Y | Dust Cover<br>Phosphated & Painted<br><br>ø182x460x82    | -     |  |
| <b>52273</b> | 6504771 P | Dust Cover<br>Phosphated & Painted<br><br>ø182xø460x74   | -     |  |
| <b>53751</b> | 6502809 R | Dust Cover<br>Phosphated & Painted<br><br>ø206xø468x76   | -     |  |

| Auger Nr.    | OEM Nr.                | Description                         | Model | Picture   |
|--------------|------------------------|-------------------------------------|-------|---|
| <b>53748</b> | 6503954 M<br>6024000 P | Hub Cap<br><br>ø10/ø152.5xø173x58   | -     |    |
| <b>53749</b> | 6502801 E              | Axle Nut, Left<br><br>M60x2 L/SW77  | -     |    |
| <b>53750</b> | 6502802 F              | Axle Nut, Right<br><br>M60x2 R/SW77 | -     |   |
| <b>54004</b> | 6502188 Z              | Axle Nut<br><br>M56x2xSW85          | -     |  |

# 16

## KASSBOHRER



| Group                           | Page |
|---------------------------------|------|
| Spring Suspension . . . . .     | 001  |
| Brake . . . . .                 | 002  |
| Axle & Wheel . . . . .          | 006  |
| Steering & Suspension . . . . . | 008  |



| Auger Nr.    | OEM Nr.       | Description                                     | Model | Picture   |
|--------------|---------------|---|-------|---|
| <b>52105</b> | 8.241.202.905 | Rubber Bushing for Spring<br><br>ø30xø60x102    | -     |    |
| <b>52108</b> | 8.241.000.421 | Rubber Bushing for Spring<br><br>ø50xø100.5x130 | -     |    |
| <b>52641</b> | 4.771.389.000 | Silent Block<br><br>ø68x77/170                  | -     |   |
| <b>52703</b> | 4.771.388.000 | Silent Block<br><br>ø69x97/190                  | -     |  |
| <b>52168</b> | 8.241.000.430 | Slider<br><br>112/158x64                        | -     |  |
| <b>52169</b> | 8.241.000.422 | Slider<br><br>69/74x109                         | -     |  |

| Auger Nr.    | OEM Nr.       | Description                    | Model | Picture   |
|--------------|---------------|--------------------------------|-------|---|
| <b>52311</b> | 8.241.021.355 | Brake Shoe Spring<br>ø22x155   | -     |    |
| <b>52313</b> | 8.241.999.333 | Brake Shoe Spring<br>ø21x105   | -     |    |
| <b>52764</b> | 8.900.020.184 | Brake Shoe Spring<br>ø23.5x216 | -     |   |
| <b>52765</b> | 8.241.024.267 | Return Spring<br>ø22.5x233     | -     |  |
| <b>53506</b> | 8.241.129.654 | Brake Shoe Spring<br>ø21x178   | -     |  |
| <b>52162</b> | 8.241.000.622 | Rep. Kit for Camshaft          | -     |  |



| Auger Nr.    | OEM Nr.       | Description                           | Model | Picture   |
|--------------|---------------|---------------------------------------|-------|---|
| <b>52325</b> | 8.241.999.330 | Brake Shoe Pin<br>ø36x135             | -     |    |
| <b>52330</b> | 8.241.129.634 | Brake Shoe Pin<br>ø22xø25x77          | -     |    |
| <b>52332</b> | 8.241.999.222 | Cam Roller<br>ø22xø42x59              | -     |   |
| <b>52329</b> | 8.241.129.641 | Brake Shoe Roller<br>ø25.7xø35/ø42x51 | -     |  |
| <b>52306</b> | 8.241.092.582 | Brake Shoe Spring Pin<br>ø12x70.5     | -     |  |
| <b>52307</b> | 8.241.129.630 | Brake Shoe Spring Pin<br>ø12x120      | -     |  |



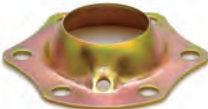

| Auger Nr.    | OEM Nr.          | Description                              | Model | Picture   |
|--------------|------------------|--|-------|---|
| <b>53064</b> | 015-26.22.103-51 | Brake Camshaft Bushing<br><br>ø45xø50x62 | -     |    |
| <b>53065</b> | 015-26.22.101-51 | Brake Camshaft Bushing<br><br>ø45xø50x45 | -     |    |
| <b>52322</b> | 8.241.999.331    | Brake Shoe Bushing<br><br>ø36xø40x59     | -     |   |
| <b>52323</b> | 8.241.000.443    | Brake Shoe Bushing<br><br>ø36xø40x28     | -     |  |
| <b>52333</b> | 8.241.000.894    | Brake Shoe Bushing<br><br>ø32xø36x54     | -     |  |
| <b>52143</b> | 8.241.016.213    | Spherical Bearing<br><br>ø42xø59.6x37    | -     |  |



| Auger Nr.    | OEM Nr.                                    | Description                        | Model                                  | Picture   |
|--------------|--|------------------------------------|--|---|
| <b>52134</b> | 8.241.016.214                              | Retainer<br><br>ø10/ø90xø59.6x17   | -                                      |    |
| <b>52135</b> | 8.241.000.618                              | Retainer<br><br>ø10/ø90xø59.6x17   | -                                      |    |
| <b>52133</b> | 8.241.999.300                              | Retainer<br><br>ø10/ø90xø59.6x21.5 | -                                      |   |
| <b>52136</b> | 8.241.999.301                              | Retainer<br><br>ø10/ø90xø59.6x21.5 | -                                      |  |
| <b>31016</b> | 1.792.411.131<br>1.792.411.131.0<br>351605 | Brake Disc<br><br>194x406xM16X1,5  | S210/S211/S212/S213/<br>S215/S216/S228 |  |
| <b>21904</b> | 8.285.417.000                              | Air Tank<br><br>ø246x30 L          | -                                      |  |

| Auger Nr.    | OEM Nr.          | Description                   | Model | Picture   |
|--------------|------------------|-------------------------------|-------|---|
| <b>54395</b> | 010-24.21.789-31 | Hub Cap<br>M145x3/SW95        | -     |    |
| <b>52122</b> | 8.241.999.292    | Hub Cap<br>M115x2/SW95/500Nm  | -     |    |
| <b>52123</b> | 8.241.016.244    | Hub Cap<br>M115x3/SW95/700Nm  | -     |   |
| <b>52124</b> | 8.241.999.464    | Hub Cap<br>M125x2/SW110/500Nm | -     |  |
| <b>52125</b> | 8.241.037.372    | Hub Cap<br>M125x3/SW110/700Nm | -     |  |
| <b>52126</b> | 8.241.030.286    | Hub Cap<br>M135x3/SW120/700Nm | -     |  |



| Auger Nr. | O.E.M. Nr.                     | A    | B    | C   |
|-----------|--------------------------------|------|------|-----|
| 52074     | 8.241.021.350                  | ø100 | ø134 | 2.5 |
| 52076     | 8.241.999.460                  | ø104 | ø136 | 2.5 |
| 52077     | 8.241.021.349                  | ø105 | ø141 | 2.5 |
| 52079     | 8.241.999.459                  | ø110 | ø141 | 2.5 |
| 52080     | 8.241.037.365                  | ø113 | ø155 | 3.5 |
| 52081     | 8.241.037.364                  | ø118 | ø165 | 3.5 |
| 52083     | 8.241.999.546                  | ø120 | ø157 | 2.5 |
| 52087     | 8.241.999.547<br>8.241.999.447 | ø128 | ø165 | 2.5 |

| Auger Nr.    | OEM Nr.       | Description                  | Model | Picture   |
|--------------|---------------|------------------------------|-------|---|
| <b>52175</b> | 8.241.021.348 | Axle Nut<br>M42x2/SW65       | -     |  |
| <b>52177</b> | 8.241.037.363 | Axle Nut<br>M52x2/SW80       | -     |  |
| <b>53996</b> | 8.241.999.299 | Thrust Washer<br>ø86xø125x22 | -     |  |
| <b>53059</b> | 8.241.999.293 | Dust Cover<br>ø84.5xø128.5x5 | -     |  |

| Auger Nr.    | OEM Nr.         | Description                          | Model   | Picture  |
|--------------|-----------------|--------------------------------------|---------|--|
| <b>51137</b> | 8.226.232.066.0 | Rep. Kit for Axle Rod<br>ø85xø19/130 | -       |   |
| <b>51972</b> | 8.226.296.069.0 | Rep. Kit for Axle Rod<br>ø75xø21/130 | -       |   |
| <b>15105</b> | 82 2629 3000B   | Torque Rod<br>L: 658                 | Travego |  |

# 17

## ROR



| Group                   | Page |
|-------------------------|------|
| Spring Suspension ..... | 001  |
| Brake .....             | 004  |
| Axle & Wheel .....      | 017  |





| Auger Nr.    | OEM Nr.      | Description  | Model   | Picture   |
|--------------|--------------|--|---|---|
| <b>52105</b> | 212 22 609   | Rubber Bushing for Spring<br><br>ø30xø60x102         | FL 9000<br>FL 9000 L/ M<br>FL 11000<br>FL 11000/150<br>FL 11000 L/D/B/LB / CS |    |
| <b>52108</b> | 212 08 093   | Rubber Bushing for Spring<br><br>ø50xø100.5x130      | Indair  |    |
| <b>52118</b> | 212 15 601 R | Rubber Bushing for Spring<br><br>ø30xø57x102         | ---   |   |
| <b>52251</b> | 210 11 746   | Rubber Bushing for Spring<br><br>ø51xø79x106         | M series suspensions  |  |
| <b>52253</b> | 210 20 676   | Rubber Bushing for Spring<br><br>ø41.5xø70/ø89x112.5 | SMT, SM and T series suspensions  |  |
| <b>52255</b> | 212 24 754   | Rubber Bushing for Spring<br><br>ø24xø48.5x58        | TE , TH, TM, TA , TC Series<br>LM / LC / LMC Series<br>T-, U- Series          |  |
| <b>52256</b> | 210 11 745   | Rubber Bushing for Spring<br><br>ø22xø48.5x75        | M & SM series suspensions   |  |

| Auger Nr.    | OEM Nr.    | Description                                     | Model   | Picture   |
|--------------|------------|---|---|---|
| <b>52279</b> | 212 02 104 | Rubber Bushing for Spring<br><br>ø32xø55.5x58.5 | SMT Series  |    |
| <b>53786</b> | 212 23 742 | Rubber Bushing for Spring<br><br>ø30xø60x45     | FL9000M<br>FL11000                                    |    |
| <b>53787</b> | 212 27 205 | Rubber Bushing for Spring<br><br>ø24xø60x45     | FL9000M<br>FL11000                                    |    |
| <b>54681</b> | 212 24 663 | Rubber Bushing for Spring<br><br>ø24xø60x102    | FL9000<br>FL9000NB<br>FL9000L<br>FL9000HLL<br>FL9000M |  |

Type-1



Type-2



Type-3

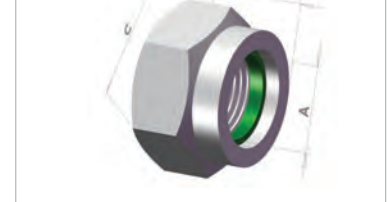

| Auger Nr.    | O.E.M. Nr. | A       | B   | C     | Type | Repair Kit        |
|--------------|------------|---------|-----|-------|------|-------------------|
| <b>54023</b> | 212 06 000 | M24x3   | 288 | SW 36 | 1    | 52264             |
| <b>54024</b> | 212 02 094 | M24x3   | 162 | SW 36 | 1    | 52265             |
| <b>54032</b> | 210 15 626 | M22x2.5 | 142 | SW 32 | 2    | 52263             |
| <b>54044</b> | 212 22 234 | M30x3.5 | 200 | SW 46 | 2    | 53804             |
| <b>54045</b> | 212 23 744 | M30x3.5 | 290 | SW 46 | 2    | 53805             |
| <b>54046</b> | 212 22 233 | M24x3   | 300 | SW 36 | 2    | 53806             |
| <b>54050</b> | 212 06 001 | M24x3   | 24  | SW 36 | 3    | 52264-52265-53806 |
| <b>54052</b> | 210 16 115 | M22x2.5 | 22  | SW 32 | 3    | 52263             |
| <b>54053</b> | 995 27 003 | M30x3.5 | 30  | SW 46 | 3    | 53804-53805       |

| Auger Nr.    | OEM Nr.      | Description  | Model   | Picture   |
|--------------|--------------|--|---|---|
| <b>52263</b> | SUS-1        | Rep. Kit Spring Bolt Assembly<br><br>ø22xø48.5x75        | M & SM Series   |    |
| <b>52264</b> | SUS-2        | Rep. Kit Spring Bolt Assembly<br><br>ø41.5xø70/ø89x112.5 | SMT, SM and T Series  |    |
| <b>52265</b> | SUS-3        | Rep. Kit Spring Bolt Assembly<br><br>ø32xø55.5x58.5      | SMT Series  |   |
| <b>52266</b> | SUS-4        | Rep. Kit Spring Bolt Assembly<br><br>ø51xø79x106         | M Series  |  |
| <b>53804</b> | 212 22 609 S | Rep. Kit Spring Bolt Assembly<br><br>ø30xø60x102         | FL 9000<br>FL 9000 L/ M<br>FL 11000<br>FL 11000/150<br>FL 11000 L/D/B/LB / CS |  |
| <b>53805</b> | 212 23 742 S | Rep. Kit Spring Bolt Assembly<br><br>ø30xø60x45          | FL9000M<br>FL11000  |  |
| <b>53806</b> | 212 27 205 S | Rep. Kit Spring Bolt Assembly<br><br>ø24xø60x45          | FL9000M<br>FL11000  |  |

**Diaphragms - Normal Stroke**

|                         |     |
|-------------------------|-----|
| <b>Auger Nr.: 52576</b> |     |
| O.E.M. Nr. —            |     |
| Type                    | 9"  |
| <b>Auger Nr.: 52578</b> |     |
| O.E.M. Nr. —            |     |
| Type                    | 12" |
| <b>Auger Nr.: 52580</b> |     |
| O.E.M. Nr. —            |     |
| Type                    | 16" |
| <b>Auger Nr.: 52581</b> |     |
| O.E.M. Nr. —            |     |
| Type                    | 20" |
| <b>Auger Nr.: 52582</b> |     |
| O.E.M. Nr. —            |     |
| Type                    | 24" |
| <b>Auger Nr.: 52583</b> |     |
| O.E.M. Nr. —            |     |
| Type                    | 30" |
| <b>Auger Nr.: 52584</b> |     |
| O.E.M. Nr. —            |     |
| Type                    | 36" |

**Diaphragms - Long Stroke**

|                         |     |
|-------------------------|-----|
| <b>Auger Nr.: 52585</b> |     |
| O.E.M. Nr. —            |     |
| Type                    | 16" |
| <b>Auger Nr.: 52586</b> |     |
| O.E.M. Nr. —            |     |
| Type                    | 20" |
| <b>Auger Nr.: 52587</b> |     |
| O.E.M. Nr. —            |     |
| Type                    | 24" |
| <b>Auger Nr.: 52588</b> |     |
| O.E.M. Nr. —            |     |
| Type                    | 30" |



| Auger Nr.    | OEM Nr.    | Description                          | Model   | Picture   |
|--------------|------------|--------------------------------------|---|---|
| <b>52784</b> | 212 05 194 | Brake Shoe Spring<br><br>ø19x140     | Series III<br>TE 9000/9300,<br>T, TA, U, TH, TM Series<br>LM & LMC Series     |    |
| <b>52785</b> | 212 21 224 | Brake Shoe Spring<br><br>ø34x220     | TE 9000 / 9300 Series<br>T, U, TH & TM Series<br>LM & LMC Series<br>TA Series |    |
| <b>52906</b> | 212 20 859 | Brake Shoe Spring<br><br>ø36.5x169.5 | TM Series<br>Series III   |   |
| <b>53779</b> | 210 23 389 | Brake Shoe Spring<br><br>ø29.5x201   | TM Series , INDAIR  |  |
| <b>53788</b> | 210 22 348 | Brake Shoe Spring<br><br>ø30x155     | TM Series   |  |
| <b>54915</b> | 212 10 215 | Return Spring<br><br>ø23x145         | TM, TE, TA Series<br>LM, LC Series  |  |

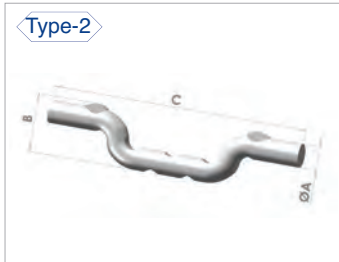

| Auger Nr. | O.E.M. Nr. | A     | B     | C    | Type | Repair Kit   |
|-----------|------------|-------|-------|------|------|--|
| 53210     | 210 23 758 | ø19.5 | 55    | 33   | 1    | 52661-52662-52915<br>52916-53790-53791<br>53801-53810-53803<br>53812 |
| 54831     | -          | ø19.5 | 52.5  | 33.5 | 1    | 53799-53800  |
| 54916     | 210 06 614 | ø6    | 15    | 68   | 2    | 53799-53810-53811<br>53812-53813                                     |
| 54872     | 1229K4795  | ø40.5 | ø67.5 | 8    | 3    | 53041  |

| Auger Nr. | OEM Nr. | Description | Model | Picture |
|-----------|---------|-------------|-------|---------|
|-----------|---------|-------------|-------|---------|

|              |         |                              |                     |  |
|--------------|---------|------------------------------|---------------------|--|
| <b>52717</b> | AXL-111 | Rep. Kit for Camshaft<br>ø38 | T, U, TH, TM Series |  |
|--------------|---------|------------------------------|---------------------|--|



|              |         |                              |                     |  |
|--------------|---------|------------------------------|---------------------|--|
| <b>53067</b> | AXL-131 | Rep. Kit for Camshaft<br>ø38 | T, U, TH, TM Series |  |
|--------------|---------|------------------------------|---------------------|--|







|              |     |                              |           |  |
|--------------|-----|------------------------------|-----------|--|
| <b>53796</b> | --- | Rep. Kit for Camshaft<br>ø38 | TM Series |  |
|--------------|-----|------------------------------|-----------|--|

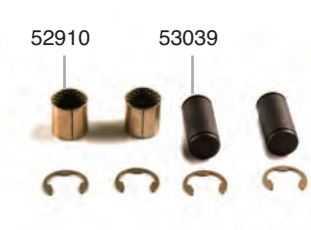
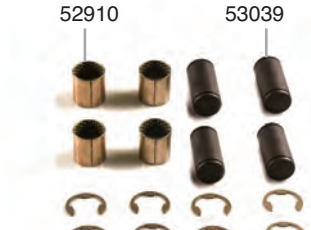
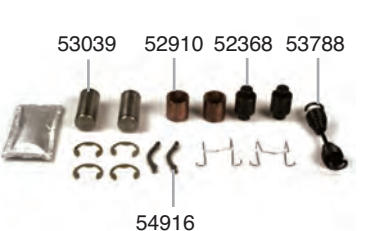

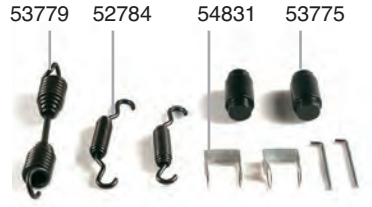

| Auger Nr.    | OEM Nr.    | Description                  | Model                            | Picture |
|--------------|------------|------------------------------|----------------------------------|---------|
| <b>53809</b> | ---        | Rep. Kit for Camshaft<br>ø38 | T, U, TH, TM Series              |         |
| <b>52262</b> | 106 90 588 | Rep. Kit for Camshaft        | TM Series                        |         |
| <b>53808</b> | ---        | Rep. Kit for Camshaft        | TM Series                        |         |
| <b>53066</b> | AXL-124    | Rep. Kit for Camshaft        | All axles with 310/350 mm brakes |         |
| <b>53789</b> | AXL-123    | Rep. Kit for Camshaft        | All axles with 420 mm brakes     |         |
| <b>52716</b> | AXL-112    | Rep. Kit for Camshaft        | TE, TM Series                    |         |

| Auger Nr.    | OEM Nr. | Description             | Model  | Picture   |
|--------------|---------|-------------------------|--|---|
| <b>52260</b> | AXL-132 | Rep. Kit for Camshaft   | T, U, TH und TM Series                       |    |
| <b>52261</b> | AXL-122 | Rep. Kit for Camshaft   | TE 9000/9300, TM Series                      |    |
| <b>53041</b> | AXL-140 | Rep. Kit for Camshaft   | All axles with 420 mm brakes                 |  |
| <b>53791</b> | AXL-LM1 | Rep. Kit for Brake Shoe | 1_2 Axle set suitable for:<br>LM & LMC axles |  |
| <b>53790</b> | AXL-LM4 | Rep. Kit for Brake Shoe | LM & LMC Series                              |  |
| <b>52916</b> | AXL-125 | Rep. Kit for Brake Shoe | TE 9000/9300, TM Series                      |  |



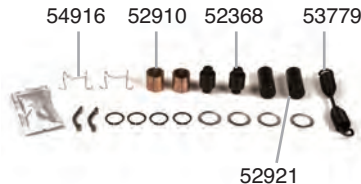





| Auger Nr.    | OEM Nr.    | Description                                     | Model   | Picture   |
|--------------|------------|---|---|---|
| <b>53802</b> | 152 26 632 | Rep. Kit for Brake Shoe<br>ø28                  | TE 9000 / 9300, TM Series<br>LM, LC, LMC Series |    |
| <b>53803</b> | 152 26 262 | Rep. Kit for Brake Shoe<br>ø20                  | LM, LC, LMC Series                              |    |
| <b>52662</b> | AXL-106    | Rep. Kit for Brake Shoe<br>ø31.7                | T, U, TH, TM Series                             |   |
| <b>53797</b> | AXL-6      | Rep. Kit for Brake Shoe<br>Single<br>ø31.7x67.5 | T, U, TH & TM Series                            |  |
| <b>53798</b> | 152 05 204 | Rep. Kit for Brake Shoe<br>Double<br>ø31.7x67.5 | T, U, TH & TM Series                            |  |
| <b>53811</b> | ---        | Rep. Kit for Brake Shoe<br>ø31.7                | TM Series                                       |  |

| Auger Nr.    | OEM Nr. | Description                               | Model                       | Picture   |
|--------------|---------|---|-----------------------------|---|
| <b>53800</b> | AXL-14  | Rep. Kit for Brake Shoe<br>ø25.5xø31.7x57 | All axles with 420mm brakes |    |
| <b>53810</b> | ---     | Rep. Kit for Brake Shoe<br>ø31.7          | ---                         |    |
| <b>53812</b> | ---     | Rep. Kit for Brake Shoe<br>ø31.7          | ---                         |   |
| <b>52661</b> | AXL-126 | Rep. Kit for Brake Shoe<br>ø31.7          | T, U, TH, TM Series         |  |
| <b>52915</b> | AXL-117 | Rep. Kit for Brake Shoe<br>ø31.7          | Series III                  |  |
| <b>53801</b> | ---     | Rep. Kit for Brake Shoe<br>ø31.7          | T, U, TH, TM Series         |  |

| Auger Nr.    | OEM Nr.      | Description                                   | Model   | Picture   |
|--------------|--------------|---|---|---|
| <b>53799</b> | AXL-7        | Rep. Kit for Brake Shoe<br><br>ø19/ø31.7x55.5 | TM Series   |    |
| <b>53813</b> | -            | Rep. Kit for Brake Shoe<br><br>ø31.7          | TM Series   |    |
| <b>53807</b> | 212 21 224 S | Rep. Kit for Brake Shoe<br><br>ø34x220        | TE 9000 / 9300 Series<br>T, U, TH & TM Series<br>LM & LMC Series<br>TA Series |   |
| <b>53778</b> | 210 06 563   | Retainer<br><br>ø70x12.5                      | TM Series   |  |
| <b>52248</b> | 212 04 849   | Dust Cover<br><br>ø36.5x26                    | TE & TM Series<br>TA & TC Series<br>LM & LMC Series                           |  |
| <b>52250</b> | 212 05 667   | Dust Cover<br><br>ø36.5x10                    | TA & TC Series<br>TE, TM Series<br>LM, LC, LMC Series                         |  |

| Auger Nr.    | OEM Nr.       | Description                        | Model  | Picture   |
|--------------|---------------|------------------------------------|--|---|
| <b>52921</b> | 210 20 039    | Brake Shoe Pin<br>ø31.7x70         | U, TM Series   |    |
| <b>53039</b> | 212 05 204    | Brake Shoe Pin<br>ø31.7x67.5       | T, U, TH & TM Series                                       |    |
| <b>53777</b> | ---           | Brake Shoe Pin<br>ø25.5xø28x57     | TE 9000/9300, TM Series<br>LM & LC Series<br>TA, TC Series |    |
| <b>53784</b> | ---           | Brake Shoe Pin<br>ø19xø20x56       | TE 9000/9300, TM Series<br>LM, LC, LMC Series              |  |
| <b>54405</b> | 212 05 193 S1 | Brake Shoe Pin<br>ø25.5xø31.7x56.5 | ---  |  |
| <b>52904</b> | 212 05 193    | Brake Shoe Pin<br>ø25.5xø31.7x56.5 | T, TE, TA, TC, U, TH & TM Series<br>Series III             |  |
| <b>53775</b> | 212 05 193 S  | Brake Shoe Pin<br>ø25.5xø31.7x57   | ---  |  |

| Auger Nr.    | OEM Nr.    | Description                                  | Model  | Picture   |
|--------------|------------|--|--|---|
| <b>52368</b> | 210 06 610 | Cam Roller<br><br>ø19/ø31.7x55.5             | T, U, TH, TM Series<br>TA & TC Series                        |    |
| <b>53776</b> | ---        | Brake Shoe Bushing<br><br>ø28xø35x38         | TE 9000/9300, TM Series<br>LM & LC Series<br>TA, TC Series   |    |
| <b>53783</b> | ---        | Brake Shoe Bushing<br><br>ø20xø31.7x32.5     | TE 9000/9300, TM Series<br>LM, LC, LMC Series                |   |
| <b>52910</b> | 210 16 666 | Brake Shoe Bushing<br><br>ø32xø35x36.5       | Series III<br>TE 9000, TE 9300 Series<br>T, U, TH, TM Series |  |
| <b>52247</b> | 212 04 703 | Brake Camshaft Bushing<br><br>ø38.5xø48x50.5 | TM Self Steer Axle<br>Universal Self Steer Axle              |  |
| <b>52249</b> | 212 09 990 | Brake Camshaft Bushing<br><br>ø43.5xø48x50   | T, U, TH & TM Series<br>Universal Self Steer Axle            |  |

| Auger Nr.    | OEM Nr.                  | Description                              | Model                                   | Picture   |
|--------------|--------------------------|--|---|---|
| <b>52257</b> | 152 13 430               | Spherical Bearing<br><br>ø12.5/63xø38x45 | TE , TH, TM Series<br>LM & LMC Series   |    |
| <b>52258</b> | 152 20 224<br>152 24 821 | Spherical Bearing<br><br>ø42x40          | TE, TM Series<br>LM & LMC Series        |    |
| <b>52259</b> | 152 04 595               | Spherical Bearing<br><br>ø12.5/63xø39x61 | TM Series                               |    |
| <b>53040</b> | A 23105Q1213             | Spherical Bearing<br><br>ø41.5x46        | TA, TM, TC Series<br>LM, LC, LMC Series |  |
| <b>52210</b> | 210 06 585               | Spherical Bearing<br><br>ø38xø70x63      | T, U, TH, TM Series                     |  |
| <b>52211</b> | 212 04 602<br>210 16 723 | Camshaft Bushing<br><br>ø38xø48x22.5     | T, U, TH, TM Series                     |  |
| <b>52212</b> | 212 04 601<br>210 16 722 | Camshaft Bushing<br><br>ø38xø48x22.5     | T, U, TH, TM Series                     |  |

| Auger Nr.    | OEM Nr.                  | Description  | Model                             | Picture   |
|--------------|--------------------------|--|-----------------------------------|---|
| <b>52267</b> | 212 02 329<br>212 02 330 | Dust Cover<br>Phosphated & Painted<br><br>ø152.5xø350x62.5 | TM Series                         |    |
| <b>52268</b> | 210 08 062<br>210 08 063 | Dust Cover<br>Phosphated & Painted<br><br>ø196xø465x76     | TM Series                         |    |
| <b>52269</b> | 212 20 647<br>152 20 648 | Dust Cover<br>Phosphated & Painted<br><br>ø463x62          | TE, TM Series                     |   |
| <b>52270</b> | 212 24 522<br>152 24 518 | Dust Cover<br>Phosphated & Painted<br><br>ø464x63          | LM/LC Series<br>TA, TC, TM Series |  |
| <b>52911</b> | 212 00 920<br>212 00 921 | Dust Cover<br>Phosphated & Painted<br><br>ø196xø465x94     | TM Series                         |  |
| <b>52912</b> | 212 21 567<br>152 21 568 | Dust Cover<br>Phosphated & Painted<br><br>ø463x86          | TM Series<br>TA, TC Series        |  |
| <b>53156</b> | 212 09 705<br>212 09 706 | Dust Cover<br>Phosphated & Painted<br><br>ø164xø385x74     | TM Series                         |  |

| Auger Nr.    | OEM Nr.    | Description                          | Model                   | Picture   |
|--------------|------------|--------------------------------------|-------------------------|---|
| <b>55208</b> | 642 25 252 | Pin for Brake Adjuster<br>ø12.6x58.9 | ---                     |    |
| <b>55222</b> | ST1036     | Brake Adjuster Rep. Kit              | ---                     |    |
| <b>55223</b> | SP7984     | Brake Adjuster Rep. Kit              | ---                     |   |
| <b>31000</b> | 212 24 263 | Brake Disc<br>225x378                | TM ELSA 195 / TM DX 195 |  |
| <b>31001</b> | 212 25 115 | Brake Disc<br>222x378xM16X2          | LM ELSA 195 / LM DX 195 |  |
| <b>31002</b> | 212 12 670 | Brake Disc<br>225x327                | ROR                     |  |
| <b>31003</b> | 212 27 349 | Brake Disc<br>222x378xM16X2          | LM ELSA 195 / LM DX 195 |  |



| Auger Nr.    | OEM Nr.    | Description  | Model          | Picture   |
|--------------|------------|--|----------------|---|
| <b>52900</b> | 212 24 673 | Hub Cap<br>$\varnothing 9/\varnothing 162 \times 15$               | LM/LC Series   |    |
| <b>52907</b> | 212 20 727 | Hub Cap<br>$\varnothing 9/\varnothing 130 \times 8$                | TE Series      |    |
| <b>52908</b> | 212 02 627 | Hub Cap<br>$\varnothing 9 \times 139.5/\varnothing 156 \times 49$  | TM Series      |   |
| <b>53781</b> | 212 23 112 | Hub Cap<br>$\varnothing 9/\varnothing 140 \times 9$                | TM Series      |  |
| <b>54408</b> | 212 26 038 | Hub Cap<br>$\varnothing 8.5/\varnothing 188.5 \times 24$           | TA / TC Series |  |
| <b>54409</b> | 212 26 119 | Axle Gasket<br>$\varnothing 8 \times / \varnothing 188.5 \times 2$ | TA / TC Series |  |



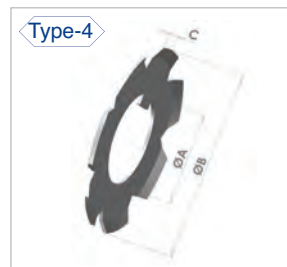

| Auger Nr. | O.E.M. Nr. | A      | B      | C    | Repair Kit |
|-----------|------------|--------|--------|------|------------|
| 54880     | 210 16 330 | ø112   | ø146.5 | 22   | 53792      |
| 54881     | 210 20 663 | ø119   | ø152.5 | 22   | 53793      |
| 54882     | 212 20 158 | ø99.5  | ø135   | 15   | 53795      |
| 54883     | 212 00 321 | ø116.5 | ø152.5 | 25.5 | 53794      |

| Auger Nr.    | OEM Nr. | Description                         | Model                        | Picture  |
|--------------|---------|-------------------------------------|------------------------------|--|
| <b>53792</b> | AXL-101 | Seal Ring Kit<br>ø112xø146.5x22     | U 20000, U 22500             |  <p>54880</p> |
| <b>53793</b> | AXL-102 | Seal Ring Kit<br>ø119xø152.5x22     | TM 20000, TM 22500, TM 25000 |  <p>54881</p> |
| <b>53794</b> | AXL-103 | Seal Ring Kit<br>ø116.5xø152.5x25.5 | TM 20000, TM 22500, TM 25000 |  <p>54883</p> |
| <b>53795</b> | AXL-114 | Seal Ring Kit<br>ø99.5xø135x15      | TE9000, TE9300               |  <p>54882</p> |



| Auger Nr. | O.E.M. Nr. | A        | B      | C      | Type | Repair Kit |
|-----------|------------|----------|--------|--------|------|------------|
| 54406     | 212 24 762 | M82x2    | 18     | SW 112 | 1    | -          |
| 54407     | 212 26 003 | ø86 W12G | 18     | SW 120 | 1    | -          |
| 54804     | 212 10 819 | M65x1.5  | 10     | SW 85  | 1    | 52913      |
| 54805     | 212 20 759 | M36x2    | 12     | SW 55  | 1    | 52914      |
| 54806     | 212 05 571 | M65x1.5  | 13     | SW 95  | 1    | 52913      |
| 54410     | 212 26 090 | ø89      | ø148   | 4      | 2    | -          |
| 54807     | 210 20 818 | ø66      | ø98    | 5.5    | 2    | 52913      |
| 54808     | 212 20 726 | ø36.5    | ø109.5 | 8      | 3    | 52914      |
| 54809     | 212 21 061 | ø36.7    | ø75    | 3.6    | 4    | 52914      |

| Auger Nr.    | OEM Nr.    | Description                                       | Model                               | Picture   |
|--------------|------------|---|-------------------------------------|---|
| <b>52913</b> | AXL-105    | Rep. Kit for Lock Washer Nut                      | TM 20000, TM 22500, TM 25000 Series |  |
| <b>52914</b> | AXL-104    | Rep. Kit for Lock Washer Nut                      | TE 9000/9300                        |  |
| <b>53785</b> | 905 08 004 | Rubber Bushing for Shock Absorber<br>ø19xø44.5x23 | ---                                 |  |



# 18

## YORK SAE GIGANT SMB

| <u>Group</u> | <u>Page</u> |
|--------------|-------------|
|--------------|-------------|

### YORK

|                         |     |
|-------------------------|-----|
| Spring Suspension ..... | 001 |
| Brake .....             | 002 |
| Axle & Wheel .....      | 005 |

### SAE GIGANT





|                    |     |
|--------------------|-----|
| Brake .....        | 006 |
| Axle & Wheel ..... | 027 |







### SMB

|                         |     |
|-------------------------|-----|
| Brake .....             | 009 |
| Spring Suspension ..... | 012 |
| Axle & Wheel .....      | 012 |













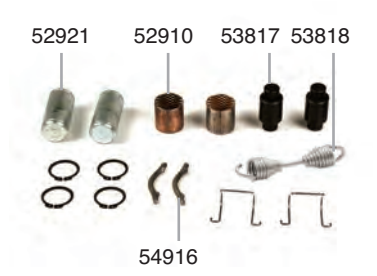



| Auger Nr.    | OEM Nr. | Description  | Model | Picture  |
|--------------|---------|--|-------|--|
| <b>52217</b> | 506242  | Rubber Bushing for Spring<br><br>ø30xø68x104         | ---   |                 |
| <b>52251</b> | 500958  | Rubber Bushing for Spring<br><br>ø51xø79x106         | ---   |                 |
| <b>52253</b> | 503624  | Rubber Bushing for Spring<br><br>ø41.5xø70/ø89x112.5 | ---   |                |
| <b>52279</b> | 770701  | Rubber Bushing for Spring<br><br>ø32xø55.5x58.5      | ---   |               |
| <b>52266</b> | ---     | Rep. Kit Spring Bolt Assembly                        | ---   |  <p>52251</p> |





| Auger Nr.    | OEM Nr. | Description                    | Model | Picture   |
|--------------|---------|--------------------------------|-------|---|
| <b>53779</b> | 503320  | Brake Shoe Spring<br>ø29.5x201 | ---   |    |
| <b>53818</b> | 506498  | Brake Shoe Spring<br>ø37.5x171 | ---   |    |
| <b>53820</b> | 786228  | Brake Shoe Spring<br>ø20x154   | ---   |   |
| <b>53160</b> | 534601  | Rep. Kit for Camshaft<br>ø38   | ---   |  |
| <b>53161</b> | ---     | Rep. Kit for Camshaft<br>ø38   | ---   |  |
| <b>53821</b> | ---     | Rep. Kit for Camshaft<br>ø38   | ---   |  |





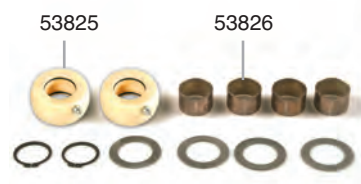

| Auger Nr.    | OEM Nr. | Description                           | Model | Picture   |
|--------------|---------|---------------------------------------|-------|---|
| <b>53822</b> | ---     | Rep. Kit for Camshaft<br><br>ø38      | ---   |    |
| <b>53824</b> | ---     | Rep. Kit for Camshaft<br><br>ø38      | ---   |    |
| <b>53823</b> | ---     | Rep. Kit for Brake Shoe<br><br>ø31.7  | ---   |   |
| <b>53929</b> | ---     | Rep. Kit for Brake Shoe<br><br>ø31.7  | ---   |  |
| <b>53930</b> | ---     | Rep. Kit for Brake Shoe<br><br>ø31.7  | ---   |  |
| <b>54916</b> | 500372  | Brake Shoe Spring Pin<br><br>ø6x68x15 | ---   |  |





| Auger Nr.    | OEM Nr. | Description                              | Model | Picture   |
|--------------|---------|--|-------|---|
| <b>52921</b> | ---     | Brake Shoe Pin<br>ø31.7x70               | ---   |    |
| <b>53817</b> | 500356  | Cam Roller<br>ø19xø28.5x60               | ---   |    |
| <b>52910</b> | 501787  | Brake Shoe Bushing<br>ø32xø35x36.5       | ---   |   |
| <b>53159</b> | 503087  | Brake Camshaft Bushing<br>ø38.5xø47.5x45 | ---   |  |
| <b>53158</b> | 500363  | Retainer<br>ø70x11.5                     | ---   |  |
| <b>53816</b> | 501574  | Retainer<br>ø70x11.5                     | ---   |  |

| Auger Nr.    | OEM Nr.              | Description   | Model | Picture   |
|--------------|----------------------|---|-------|---|
| <b>52210</b> | 500362               | Spherical Bearing<br><br>ø38xø70x63                   | ---   |    |
| <b>53157</b> | 786123               | Camshaft Bushing<br><br>ø39xø48x45                    | ---   |    |
| <b>53819</b> | 502765               | Camshaft Bushing<br><br>ø39xø48x46                    | ---   |   |
| <b>53814</b> | 500808/9             | Dust Cover<br>Phosphated & Painted<br><br>ø132xø430x9 | ---   |  |
| <b>53815</b> | 501875/6             | Dust Cover<br>Phosphated & Painted<br><br>ø133xø466x9 | ---   |  |
| <b>54419</b> | 502461 S<br>502462 S | Rep. Kit for Lock Washer<br>Nut<br><br>ø62 16G 3/8"   | ---   |  |

| Auger Nr.    | OEM Nr.  | Description                             | Model | Picture   |
|--------------|----------|---|-------|---|
| <b>53836</b> | ---      | Rep. Kit for Camshaft<br><br>ø37xø70x32 | ---   |    |
| <b>53838</b> | 08902022 | Rep. Kit for Camshaft<br><br>ø37xø70x32 | ---   |    |
| <b>53837</b> | 08910060 | Rep. Kit for Brake Shoe<br><br>ø27      | ---   |   |
| <b>53839</b> | ---      | Rep. Kit for Brake Shoe<br><br>ø20      | ---   |  |
| <b>53840</b> | ---      | Rep. Kit for Brake Shoe<br><br>ø16      | ---   |  |

| Auger Nr.    | OEM Nr.  | Description                         | Model | Picture   |
|--------------|----------|-------------------------------------|-------|---|
| <b>53825</b> | 08307075 | Spherical Bearing<br><br>ø37xø70x32 | ---   |    |
| <b>53827</b> | 08709045 | Brake Shoe Pin<br><br>ø27x81        | ---   |    |
| <b>53829</b> | 08804062 | Brake Shoe Pin<br><br>ø20x48        | ---   |   |
| <b>53830</b> | 08804086 | Brake Shoe Pin<br><br>ø16x48        | ---   |  |
| <b>53831</b> | 06311046 | Brake Shoe Roller<br><br>ø20xø45x23 | ---   |  |
| <b>53832</b> | 05703006 | Brake Shoe Roller<br><br>ø16xø45x23 | ---   |  |

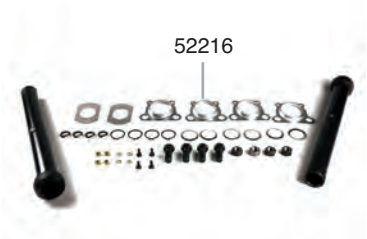



| Auger Nr.    | OEM Nr.  | Description  | Model | Picture   |
|--------------|----------|--|-------|---|
| <b>53826</b> | 02001004 | Brake Camshaft Bushing<br><br>ø37xø40x25               | ---   |    |
| <b>53828</b> | 02001001 | Brake Shoe Bushing<br><br>ø27xø30x20                   | ---   |    |
| <b>53833</b> | 08803055 | Dust Cover<br>Phosphated & Painted<br><br>ø153xø341x38 | ---   |   |
| <b>53834</b> | 08612004 | Dust Cover<br>Phosphated & Painted<br><br>ø147xø397x38 | ---   |  |
| <b>53835</b> | 08206009 | Dust Cover<br>Phosphated & Painted<br><br>ø198xø461x80 | ---   |  |

| Auger Nr.    | OEM Nr.  | Description                      | Model | Picture   |
|--------------|----------|----------------------------------|-------|---|
| <b>52920</b> | M 002874 | Brake Shoe Spring<br>ø32x204     | ---   |    |
| <b>53849</b> | M 007150 | Brake Shoe Spring<br>ø28x176     | ---   |    |
| <b>53165</b> | M 010676 | Rep. Kit for Camshaft<br>ø38x509 | ---   |   |
| <b>53841</b> | M 050147 | Rep. Kit for Camshaft<br>ø38x456 | ---   |  |
| <b>54413</b> | M 010552 | Rep. Kit for Brake Shoe          | ---   |  |
| <b>52782</b> | M009279  | Rep. Kit for Brake Shoe<br>ø31.7 | ---   |  |

| Auger Nr.    | OEM Nr.  | Description                       | Model | Picture   |
|--------------|----------|-----------------------------------|-------|---|
| <b>52921</b> | M 002866 | Brake Shoe Pin<br>ø31.7x70        | ---   |    |
| <b>52368</b> | M 002971 | Cam Roller<br>ø19x31.7x55.5       | ---   |    |
| <b>53848</b> | M 007371 | Cam Roller<br>ø19/ø25x57          | ---   |   |
| <b>52216</b> | ---      | Retainer<br>ø70x13                | ---   |  |
| <b>52367</b> | M 003060 | Retainer<br>ø70x13                | ---   |  |
| <b>54831</b> | M 002693 | Lock Plater<br>ø19.5x52.5         | ---   |  |
| <b>54916</b> | M 003060 | Brake Shoe Spring Pin<br>ø6x68x15 | ---   |  |



| Auger Nr.    | OEM Nr.              | Description  | Model | Picture   |
|--------------|----------------------|--|-------|---|
| <b>54678</b> | M 009309             | Dust Cover Set<br>Phosphated & Painted<br><br>ø128xø303x22 | ---   |    |
| <b>54679</b> | M 051275             | Dust Cover Set<br>Phosphated & Painted                     | ---   |    |
| <b>54680</b> | M 009260             | Dust Cover Set<br>Phosphated & Painted                     | ---   |   |
| <b>52272</b> | M 010544             | Dust Cover Set<br>Phosphated & Painted<br><br>ø182xø460x82 | ---   |  |
| <b>52273</b> | M 007363             | Dust Cover Set<br>Phosphated & Painted<br><br>ø182xø460x74 | ---   |  |
| <b>54676</b> | M 046565<br>M 046573 | Dust Cover<br>Phosphated & Painted                         | ---   |  |
| <b>54677</b> | M 002904<br>M 002912 | Dust Cover<br>Phosphated & Painted                         | ---   |  |

| Auger Nr.    | OEM Nr.  | Description                                  | Model | Picture   |
|--------------|----------|--|-------|---|
| <b>52217</b> | M 001502 | Rubber Bushing for Spring<br><br>ø30xø68x104 | ---   |    |
| <b>53847</b> | M 008892 | Shaft Seal for Axle<br><br>ø108xø153x30      | ---   |    |
| <b>54411</b> | M 002564 | Axle Nut, Right<br><br>M88x2 R/25xSW120      | ---   |   |
| <b>54412</b> | M 007916 | Axle Nut, Left<br><br>M88x2 L/25xSW120       | ---   |  |



# 19

## FRUEHAUF



| Group                   | Page |
|-------------------------|------|
| Spring Suspension ..... | 001  |
| Brake .....             | 003  |
| Axle & Wheel .....      | 012  |



| Auger Nr.    | OEM Nr.      | Description                                     | Model | Picture   |
|--------------|--------------|---|-------|---|
| <b>52217</b> | M001502      | Rubber Bushing for Spring<br><br>ø30xø68x104    | ---   |    |
| <b>52279</b> | UJA-0033-001 | Rubber Bushing for Spring<br><br>ø32xø55.5x58.5 | ---   |    |
| <b>52282</b> | UJA-0030-001 | Rubber Bushing for Spring<br><br>ø52xø90x111.5  | ---   |  |

Type-1







Type-2

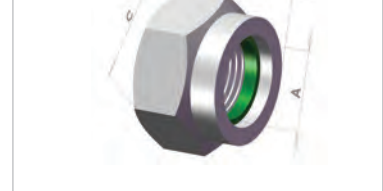

Type-3



| Auger Nr.    | O.E.M. Nr. | A       | B     | C     | Type | Repair Kit  |
|--------------|------------|---------|-------|-------|------|-------------|
| <b>54021</b> | UJA0324001 | M24x1.5 | 272.5 | ø51   | 1    | 52286-53204 |
| <b>54022</b> | UJA0034001 | M24x1.5 | 154   | ø31.5 | 1    | 52287-53205 |
| <b>54041</b> | -          | M30x3.5 | 210   | SW 46 | 2    | 53856       |
| <b>54053</b> | -          | M30x3.5 | 30    | SW 46 | 3    | 53856       |

| Auger Nr.    | OEM Nr.  | Description   | Model | Picture   |
|--------------|----------|---|-------|---|
| <b>52286</b> | 100114   | Rep. Kit Spring Bolt Assembly, Double<br><br>ø52xø90x111.5  | ---   |    |
| <b>52287</b> | 100113   | Rep. Kit Spring Bolt Assembly, Double<br><br>ø32xø55.5x58.5 | ---   |    |
| <b>53204</b> | 100114 S | Rep. Kit Spring Bolt Assembly, Single<br><br>ø52xø90x111.5  | ---   |   |
| <b>53205</b> | 100113 S | Rep. Kit Spring Bolt Assembly, Single<br><br>ø32xø55.5x58.5 | ---   |  |
| <b>53856</b> | M008949  | Rep. Kit Spring Bolt Assembly<br><br>M30x3.5/210            | ---   |  |

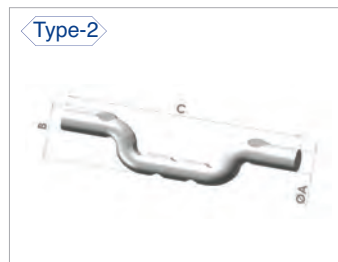

| Auger Nr. | O.E.M. Nr.              | A     | B    | C    | Type | Repair Kit                             |
|-----------|-------------------------|-------|------|------|------|--|
| 53210     | -                       | ø19.5 | 55   | 33   | 1    | 53855                                  |
| 54831     | AJA-0506-001<br>M002693 | ø19.5 | 52.5 | 33.5 | 1    | 53858-52782-53167-53854-53857          |
| 54916     | M003001                 | ø6    | 15   | 68   | 2    | 52782-53167-53854-53855<br>53857-53858 |

| Auger Nr. | OEM Nr. | Description | Model | Picture |
|-----------|---------|-------------|-------|---------|
|-----------|---------|-------------|-------|---------|

**53165**

M010676

Rep. Kit for Camshaft  
ø38x509

---

**53841**

M050147

Rep. Kit for Camshaft  
ø38x456

---

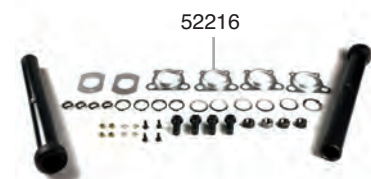
**52288**

CF-1014969

Rep. Kit for Camshaft,  
Single  
ø40xø64x38

---





**52289**

---

Rep. Kit for Camshaft,  
Double  
ø40xø64x38

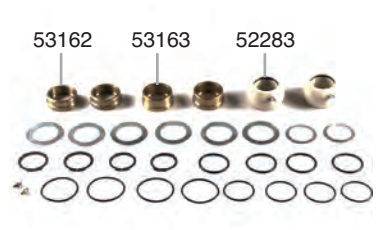
---







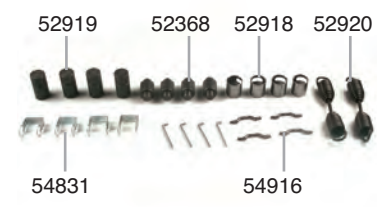



| Auger Nr.    | OEM Nr.         | Description                                     | Model | Picture   |
|--------------|-----------------|---|-------|---|
| <b>53164</b> | AEJA-0442-001 S | Rep. Kit for Camshaft<br><br>ø40xø64x38         | ---   |    |
| <b>53851</b> | AEJB-0003-002   | Rep. Kit for Camshaft, Single<br><br>ø40xø64x38 | ---   |    |
| <b>53852</b> | AEJB-0003-001   | Rep. Kit for Camshaft, Double<br><br>ø40xø64x38 | ---   |   |
| <b>53853</b> | ARJA-0199-702   | Rep. Kit for Camshaft<br><br>ø40xø64x38         | ---   |  |
| <b>52290</b> | CF-100149       | Rep. Kit for Camshaft<br><br>ø38xø70x63         | ---   |  |
| <b>52782</b> | M009279         | Rep. Kit for Brake Shoe<br><br>ø31.7            | ---   |  |



| Auger Nr.    | OEM Nr.        | Description                      | Model | Picture  |
|--------------|----------------|----------------------------------|-------|--|
| <b>53167</b> | ARJA- 0199-703 | Rep. Kit for Brake Shoe<br>ø31.7 | ---   |  <p>54831 52919 52920 52918 52368<br/>54916</p>   |
| <b>53854</b> | ---            | Rep. Kit for Brake Shoe<br>ø31.7 | ---   |  <p>52919 52368 52918 52920<br/>54831 54916</p>   |
| <b>53855</b> | ---            | Rep. Kit for Brake Shoe<br>ø31.7 | ---   |  <p>52918 52368 52919 52920<br/>54916 53210</p>  |
| <b>53857</b> | ---            | Rep. Kit for Brake Shoe<br>ø31.7 | ---   |  <p>54831 53848 52921 53849<br/>54916</p>       |
| <b>53858</b> | ---            | Rep. Kit for Brake Shoe<br>ø31.7 | ---   |  <p>52918 52919 53848 53849<br/>54916 54831</p> |

| Auger Nr.    | OEM Nr.                  | Description  | Model | Picture   |
|--------------|--------------------------|--|-------|---|
| <b>52368</b> | AJA-0504-001<br>M-002971 | Cam Roller<br>$\varnothing 19 \times \varnothing 31.7 \times 55.5$           | ---   |    |
| <b>53848</b> | AJA-0504-002             | Cam Roller<br>$\varnothing 19 / \varnothing 25 \times 57$                    | ---   |    |
| <b>52921</b> | M-002866                 | Brake Shoe Pin<br>$\varnothing 31.7 \times 70$                               | ---   |   |
| <b>52919</b> | AJA-0507-001             | Brake Shoe Pin<br>$\varnothing 31.7 \times 62.5$                             | ---   |  |
| <b>52918</b> | AJA-0558-001             | Brake Shoe Bushing<br>$\varnothing 32 \times \varnothing 35 \times 37$       | ---   |  |
| <b>53162</b> | AJA-0753-002             | Brake Camshaft Bushing<br>$\varnothing 41 \times \varnothing 50.7 \times 19$ | ---   |  |
| <b>53163</b> | AJA-0753-001             | Brake Camshaft Bushing<br>$\varnothing 41.5 \times \varnothing 51 \times 23$ | ---   |  |

| Auger Nr.    | OEM Nr.                 | Description   | Model | Picture   |
|--------------|-------------------------|---|-------|---|
| <b>54909</b> | ---                     | Bronze Bushing<br>$\varnothing 41.2 \times \varnothing 50.9 / \varnothing 54 \times 51$ | ---   |    |
| <b>52210</b> | CF-1001312              | Spherical Bearing<br>$\varnothing 38 \times \varnothing 70 \times 63$                   | ---   |    |
| <b>52283</b> | AEJA-0442-001           | Spherical Bearing<br>$\varnothing 40 \times \varnothing 64 \times 38$                   | ---   |   |
| <b>52278</b> | AEJA-0441-002A          | Camshaft Bushing<br>$\varnothing 41 \times \varnothing 51 \times 22$                    | ---   |  |
| <b>52281</b> | AEJA-0441-001           | Camshaft Bushing<br>$\varnothing 41 \times \varnothing 51 \times 22$                    | ---   |  |
| <b>52920</b> | AJB-0119-001<br>M002874 | Brake Shoe Spring<br>$\varnothing 32 \times 204$  | ---   |  |
| <b>53849</b> | AJA-0487-001            | Brake Shoe Spring<br>$\varnothing 28 \times 176$  | ---   |  |

| Auger Nr.    | OEM Nr.                      | Description  | Model | Picture   |
|--------------|------------------------------|--|-------|---|
| <b>53842</b> | AJB-0001-001<br>AJB-0002-001 | Retainer<br><br>ø10.5/69.5xø64x20                      | ---   |    |
| <b>52216</b> | ---                          | Retainer<br><br>ø70x13                                 | ---   |    |
| <b>52367</b> | M003060                      | Retainer<br><br>ø70x13                                 | ---   |   |
| <b>52277</b> | AJA-0483-001<br>AJA-0483-002 | Dust Cover<br>Phosphated & Painted<br><br>ø197xø463x72 | ---   |  |
| <b>52280</b> | AJB-0006-001<br>AJB-0006-002 | Dust Cover<br>Phosphated & Painted<br><br>ø178xø460x38 | ---   |  |
| <b>52917</b> | ARJB-0006-701                | Dust Cover<br>Phosphated & Painted<br><br>ø178xø460x38 | ---   |  |

## Diaphragms - Normal Stroke

**Auger Nr.: 52576**

O.E.M. Nr. —

Type 9"

**Auger Nr.: 52578**

O.E.M. Nr. —

Type 12"

**Auger Nr.: 52580**

O.E.M. Nr. —

Type 16"

**Auger Nr.: 52581**

O.E.M. Nr. —

Type 20"

**Auger Nr.: 52582**

O.E.M. Nr. —

Type 24"

**Auger Nr.: 52583**

O.E.M. Nr. —

Type 30"

**Auger Nr.: 52584**

O.E.M. Nr. —

Type 36"



## Diaphragms - Long Stroke

**Auger Nr.: 52585**

O.E.M. Nr. —

Type 16"

**Auger Nr.: 52586**

O.E.M. Nr. —

Type 20"

**Auger Nr.: 52587**

O.E.M. Nr. —







Type 24"





**Auger Nr.: 52588**

O.E.M. Nr. —

Type 30"



| Auger Nr.    | OEM Nr.                   | Description  | Model | Picture   |
|--------------|---------------------------|--|-------|---|
| <b>21004</b> | ---                       | Service Brake Chamber<br>(For Disc Brake)<br><br>T16 STR 57<br><br>97.5/111.5xM16x1.5x164                  | ---   |    |
| <b>21005</b> | AJV4526                   | Service Brake Chamber<br>(For Disc Brake)<br>with rep. kit<br><br>T16 STR 57<br><br>97.5/111.5xM16x1.5x164 | ---   |    |
| <b>21010</b> | ---                       | Service Brake Chamber<br>(For Drum Brake)<br><br>112.5/126xM16x1.5<br><br>T16 STR 75                       | ---   |   |
| <b>21011</b> | AFA9104001<br>ASX0014-018 | Service Brake Chamber<br>(For Drum Brake)<br>(with repair kit)<br><br>112.5/126xM16x1.5<br><br>T16 STR 75  | ---   |  |
| <b>21012</b> | ---                       | Service Brake Chamber<br>(For Drum Brake)<br><br>113/126xM16x1.5<br><br>T20 STR 75                         | ---   |  |
| <b>21013</b> | ASX0014-019               | Service Brake Chamber<br>(For Drum Brake)<br>(with repair kit)<br><br>113/126xM16x1.5<br><br>T20 STR 75    | ---   |  |

| Auger Nr.    | OEM Nr.                     | Description   | Model   | Picture   |
|--------------|-----------------------------|---|---|---|
| <b>21014</b> | ---                         | Service Brake Chamber<br>(For Drum Brake)<br><br>112,5/126xM16x1.5<br><br>T24 STR 75                      | ---   |    |
| <b>21015</b> | 1H312161-609<br>ASX0014-020 | Service Brake Chamber<br>(For Drum Brake)<br>(with repair kit)<br><br>112,5/126xM16x1.5<br><br>T24 STR 75 | ---   |    |
| <b>21016</b> | ---                         | Service Brake Chamber<br>(For Drum Brake)<br><br>117,5/131xM16x1.5<br><br>T30 STR 75                      | ---   |   |
| <b>21017</b> | ASX0014-021<br>M020272-03   | Service Brake Chamber<br>(For Drum Brake)<br>(with repair kit)<br><br>117,5/131xM16x1.5<br><br>T30 STR 75 | ---   |  |
| <b>31013</b> | MO 69018                    | Brake Disc<br><br>260x432   | D1 / H1 / K1AXLE / PAN22 / PAN22-1 /<br>SB 7000 |  |

| Auger Nr.    | OEM Nr.        | Description                          | Model | Picture   |
|--------------|----------------|--------------------------------------|-------|---|
| <b>53844</b> | AJA-0577-001   | Hub Cap<br>ø158 W8G/167              | ---   |    |
| <b>53845</b> | AJA-0492-001   | Hub Cap, Plastic<br>ø158 W8G/76.5    | ---   |    |
| <b>53846</b> | AJA-0492-001 S | Hub Cap, Aluminium<br>ø158 W8G/73.5  | ---   |   |
| <b>53847</b> | M008892        | Shaft Seal for Axle<br>ø108xø153x30  | ---   |  |
| <b>53843</b> | AJA-0407-001   | Lock Washer<br>ø89x128.5x6           | ---   |  |
| <b>54414</b> | CR-26722-01    | Rep. Kit for Bearing<br>ø31x54/60x89 | ---   |  |



# 20

## UNIVERSAL PARTS

| Group                                   | Page |
|---|------|
| Brake Caliper . . . . .                 | 001  |
| Brake . . . . .                         | 023  |
| Valves . . . . .                        | 028  |
| Air Line Filters & Valves . . . . .     | 029  |
| Cylinders . . . . .                     | 030  |
| Couplings . . . . .                     | 031  |
| Air Brake Coils . . . . .               | 032  |
| Sockets & Plugs . . . . .               | 034  |
| Electrical Cables . . . . .             | 035  |
| ABS Cables . . . . .                    | 036  |
| Adapter Cables . . . . .                | 037  |
| ABS-EBS Plugs & Sockets-Coils . . . . . | 038  |
| Tank Caps . . . . .                     | 039  |
| Air Tanks . . . . .                     | 039  |
| Trailer Parts . . . . .                 | 040  |





### Screws



| Auger Nr. | A       | B    | C    | Repair Kit  |
|-----------|---------|------|------|---|
| 55295     | M18x1.5 | 90   | SW14 | 54171   |
| 55296     | M18x1.5 | 150  | SW14 | 54171   |
| 55297     | M18x1.5 | 95   | SW14 | 54175-54532-54546<br>54549-54557  |
| 55298     | M18x1.5 | 120  | SW14 | 54175-54546-54549   |
| 55299     | M16x1.5 | 80   | SW14 | 53866-53872-53873<br>54558-54559-54562<br>54569   |
| 55300     | M20x1.5 | 90   | SW17 | 53867-54170-54529<br>54550  |
| 55301     | M20x1.5 | 150  | SW17 | 53867-53874-54170<br>54529-54548-54550<br>54552   |
| 55305     | M20x1.5 | 100  | SW17 | 53874-54548-54552   |
| 55306     | M16x1.5 | 86.5 | SW14 | 53875-53876-53884<br>53886-53887-53888<br>53889-53890-54069<br>54070-54071-54522<br>54526-54684-54686 |
| 55307     | M16x1.5 | 80   | SW14 | 53877-53887-53888<br>53889-54069-54070<br>54071-54684   |
| 55308     | M16x1.5 | 150  | SW14 | 53877-53882<br>53890-54685  |
| 55309     | M16x1.5 | 125  | SW14 | 53882-53885   |
| 55310     | M16x1.5 | 140  | SW14 | 53885-53886<br>54686-53884  |
| 55311     | M16x1.5 | 75   | SW14 | 54524   |
| 55312     | M16x1.5 | 70   | SW14 | 54526   |
| 55313     | M12x1.5 | 90   | SW10 | 54528   |
| 55314     | M6x1    | 20   | SW5  | 54528   |
| 55315     | M20x2   | 85   | SW17 | 54551-54554-54530   |
| 55316     | M20x2   | 125  | SW17 | 54530-54551-54553<br>54554-54556  |

### Screws



| Auger Nr. | A        | B     | C     | Type | Repair Kit                 |
|-----------|----------|-------|-------|------|----------------------------|
| 55317     | M18x1.5  | 135   | SW14  | 1    | 54532                      |
| 55318     | M16x1.5  | 55    | SW14  | 1    | 53866-53872<br>53873       |
| 55319     | M12x1.25 | 85    | SW10  | 1    | 54538-54541<br>54543       |
| 55320     | M12x1.25 | 85    | SW10  | 1    | 54540                      |
| 55321     | M12x1.25 | 95    | SW10  | 1    | 54544                      |
| 55322     | M16x1.5  | 130   | SW14  | 1    | 54558-54569                |
| 55323     | M16x1.5  | 120   | SW14  | 1    | 54559-54562                |
| 55324     | M8x1.25  | 22    | SW6   | 1    | 54560                      |
| 55325     | M16x1.5  | 70    | SW14  | 1    | 54565-54566<br>54561       |
| 55326     | M16x1.5  | 90    | SW14  | 1    | 54561-54565<br>54566       |
| 55328     | M16x1.5  | 110   | SW14  | 1    | 54568                      |
| 55329     | M8x1.25  | 40    | SW5   | 1    | 55176                      |
| 55330     | M8x1.25  | 16    | SW5   | 1    | 55176                      |
| 55384     | M16x1.5  | 40    | SW14  | 1    | 54170-54171<br>54173       |
| 55294     | M16x1.5  | 40    | 18.15 | 2    | 54169-54172                |
| 55302     | M14x1.5  | 40    | 16.4  | 2    | 53868-53869<br>54169-54172 |
| 55327     | M10x1    | 40    | 9.3   | 2    | 54565                      |
| 55303     | M18x1.5  | 81.5  | 17,8  | 3    | 53869-54169                |
| 55304     | M18x1.5  | 119.5 | 17,8  | 3    | 53869-54169<br>54172       |

### Dust Covers



| Auger Nr. | A            | B           | C    | Type | Repair Kit  |
|-----------|--------------|-------------|------|------|---|
| 55331     | ø30/ø35,5    | ø51,5       | 36.5 | 1    | 53876-53877-53882-53887-53888<br>53889-53890-54069-54070-54071<br>54522-54526-54684-54685-54686 |
| 55332     | ø16          | ø37         | 23   | 2    | 54528   |
| 55333     | ø25          | ø40.2       | 41   | 3    | 54524   |
| 55334     | ø35/ø37.5    | ø51.5       | 34   | 4    | 54558-54559-54562-54569   |
| 55335     | ø23.5 / ø30  | ø42         | 26   | 5    | 54561-54565-54566   |
| 55336     | ø29/ø46.5    | ø51.5       | 37   | 6    | 53884-53885-53886   |
| 55337     | ø35/ø37.5    | ø51.5       | 33   | 7    | 54559   |
| 55338     | ø23.5 / ø35  | ø46 / ø47.5 | 28   | 8    | 54560-54568   |
| 55339     | ø20/ø34      | ø45         | 33   | 9    | 53883   |
| 55340     | ø38/ø64,5    | ø72.5       | 30.5 | 10   | 53883   |
| 55341     | ø12.5 / ø16  | ø22         | 22   | 11   | 54567   |
| 55342     | ø17.5/ ø19.7 | ø33.5       | 31   | 12   | 54533-54534-54535-54536-54537<br>54538-54539-54540-54541-54542<br>54543-54544-54545-55179       |
| 55343     | ø26          | ø42.5       | 27.5 | 13   | 54529   |
| 55346     | ø42          | 121X 170    | 13   | 14   | 55176   |

### Dust Covers



| Auger Nr.    | A            | B          | C     | Type | Repair Kit                             |
|--------------|--------------|------------|-------|------|--|
| <b>55344</b> | ø33,5/ ø34,5 | ø43        | 48,5  | 1    | 53875-53884-53886-53890<br>54522-54686 |
| <b>55345</b> | ø31/ ø32     | ø40        | 46    | 2    | 53877-54070-54684                      |
| <b>55347</b> | ø18          | ø68/ ø74,5 | 24,5  | 3    | 53878-54168-54178                      |
| <b>55348</b> | ø18          | ø65/ø74    | 22.75 | 4    | 53881-54167                            |
| <b>55349</b> | ø18          | ø69/ø74    | 22    | 5    | 54523                                  |
| <b>55350</b> | ø18          | ø68/ ø70,5 | 30.5  | 6    | 54558-54562                            |
| <b>55351</b> | ø32/ø43      | ø84        | 14    | 7    | 53870-53871-54173-54174                |
| <b>55352</b> | ø30.5        | ø85        | 9.5   | 8    | 53883                                  |
| <b>55353</b> | ø47          | ø82        | 17    | 9    | 54528                                  |
| <b>55354</b> | ø31          | ø72.5      | 11    | 10   | 54559-54561-54565-54566                |
| <b>55355</b> | ø55          | ø95        | 14    | 11   | 54560                                  |
| <b>55356</b> | ø34          | ø69.5      | 6.5   | 12   | 54527                                  |
| <b>55357</b> | ø68          | ø98        | 9.5   | 13   | 54563                                  |
| <b>55358</b> | ø41.5        | ø84        | 7     | 14   | 54570                                  |

### Dust Covers





| Auger Nr. | A          | B     | C    | Type | Repair Kit   |
|-----------|------------|-------|------|------|--|
| 55359     | ø47.5      | ø74   | 15   | 1    | 54535-54536  |
| 55360     | ø58        | ø85   | 14.5 | 2    | 54534-54537-55179  |
| 55361     | ø19        | ø32.5 | 6.5  | 3    | 54534-54536-54539-55179  |
| 55362     | ø49/ ø60.2 | ø74   | 13   | 4    | 54533-54539-54545  |
| 55363     | ø32        | ø59   | 7.75 | 5    | 54564  |
| 55364     | ø30        | ø51.5 | 22   | 6    | 54531-54547  |
| 55365     | ø29        | ø51.5 | 22   | 7    | 53874  |
| 55366     | ø27        | ø48   | 19.5 | 8    | 54532-54555  |
| 55367     | ø22/ ø32.5 | ø65   | 25   | 9    | 54547  |
| 55368     | ø24/ø35    | ø56   | 25.5 | 10   | 54175-54546-54549  |
| 55369     | ø29        | ø51.5 | 24   | 11   | 53868-53869-54169-54170-54171<br>54172-54173-54529-54530-54531<br>54547-54548-54550-54551-54553<br>54554-54556-55286 |
| 55370     | ø33/ø35    | ø69   | 15.5 | 12   | 54167  |
| 55371     | ø33/ø35    | ø73   | 15.5 | 13   | 54168  |
| 55372     | ø35        | ø73   | 14.5 | 14   | 54178  |

### Dust Covers







| Auger Nr. | A       | B     | C     | Type | Repair Kit                             |
|-----------|---------|-------|-------|------|--|
| 55373     | ø35     | ø70   | 14    | 1    | 53881                                  |
| 55374     | ø19     | ø64.5 | 21,75 | 2    | 53872-53873                            |
| 55375     | ø21     | ø48.5 | 20.5  | 3    | 53872-53873                            |
| 55376     | ø25/ø31 | ø40   | 64    | 4    | 53887-53888-53889-54069-54071          |
| 55377     | ø33/ø36 | ø45   | 96    | 5    | 53882-53885                            |
| 55378     | ø46     | ø52.5 | 40    | 6    | 53877-53882-53890-54072<br>54685-54686 |
| 55379     | ø37.5   | ø53.5 | 37    | 7    | 54558-54569                            |
| 55380     | ø42/ø47 | ø55   | 46    | 8    | 53884                                  |
| 55381     | ø46.5   | ø52.5 | 26    | 9    | 53885-53886                            |
| 55382     | ø8/ø12  | ø19.5 | 13.5  | 10   | 54547                                  |
| 55383     | ø21     | ø40   | 18    | 11   | 54557                                  |







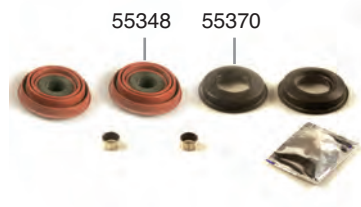







| Auger Nr.    | OEM Nr.       | Description                              | Model | Picture   |
|--------------|---------------|--|-------|---|
| <b>53875</b> | II 368470064  | Rep. Kit for Brake Caliper<br>Knorr Type | ---   |    |
| <b>53876</b> | K 000696      | Rep. Kit for Brake Caliper<br>Knorr Type | ---   |    |
| <b>53877</b> | K 000687      | Rep. Kit for Brake Caliper<br>Knorr Type | ---   |   |
| <b>53878</b> | II 304130065  | Rep. Kit for Brake Caliper<br>Knorr Type | ---   |  |
| <b>53879</b> | II 39769F0063 | Rep. Kit for Brake Caliper<br>Knorr Type | ---   |  |
| <b>53880</b> | K 000945      | Rep. Kit for Brake Caliper<br>Knorr Type | ---   |  |







| Auger Nr.    | OEM Nr.      | Description                              | Model | Picture   |
|--------------|--------------|--|-------|---|
| <b>53881</b> | K 001300     | Rep. Kit for Brake Caliper<br>Knorr Type | ---   |    |
| <b>53882</b> | II 358510062 | Rep. Kit for Brake Caliper<br>Knorr Type | ---   |    |
| <b>53883</b> | 9316 1192    | Rep. Kit for Brake Caliper<br>Knorr Type | ---   |   |
| <b>53884</b> | II 197140062 | Rep. Kit for Brake Caliper<br>Knorr Type | ---   |  |
| <b>53885</b> | II 179320062 | Rep. Kit for Brake Caliper<br>Knorr Type | ---   |  |
| <b>53886</b> | II 197330062 | Rep. Kit for Brake Caliper<br>Knorr Type | ---   |  |



| Auger Nr.    | OEM Nr.                                      | Description                              | Model | Picture  |
|--------------|--|--|-------|--|
| <b>53887</b> | K 001274                                     | Rep. Kit for Brake Caliper<br>Knorr Type | ---   |  <p>55376 55331 55307<br/>55306</p>         |
| <b>53888</b> | K 000375                                     | Rep. Kit for Brake Caliper<br>Knorr Type | ---   |  <p>55331 55306<br/>55307 55376</p>         |
| <b>53889</b> | 4254 1412                                    | Rep. Kit for Brake Caliper<br>Knorr Type | ---   |  <p>55306 55307 55331 55376</p>            |
| <b>53890</b> | II 339680062<br>II 328090062<br>II 369100062 | Rep. Kit for Brake Caliper<br>Knorr Type | ---   |  <p>55344 55378 55331<br/>55308 55306</p> |
| <b>54068</b> | K 000029                                     | Rep. Kit for Brake Caliper<br>Knorr Type | ---   |   |
| <b>54069</b> | K 000472                                     | Rep. Kit for Brake Caliper<br>Knorr Type | ---   |  <p>55376 55331 55307 55306</p>           |

| Auger Nr.    | OEM Nr.  | Description                              | Model | Picture   |
|--------------|----------|--|-------|---|
| <b>54070</b> | K 001925 | Rep. Kit for Brake Caliper<br>Knorr Type | ---   |    |
| <b>54071</b> | K 001532 | Rep. Kit for Brake Caliper<br>Knorr Type | ---   |    |
| <b>54072</b> | K 001301 | Rep. Kit for Brake Caliper<br>Knorr Type | ---   |   |
| <b>54167</b> | K 010603 | Rep. Kit for Brake Caliper<br>Knorr Type | ---   |  |
| <b>54168</b> | K 010604 | Rep. Kit for Brake Caliper<br>Knorr Type | ---   |  |
| <b>54178</b> | K 000944 | Rep. Kit for Brake Caliper<br>Knorr Type | ---   |  |

| Auger Nr.    | OEM Nr.       | Description                              | Model | Picture  |
|--------------|---------------|--|-------|--|
| <b>54522</b> | II 39769F0062 | Rep. Kit for Brake Caliper<br>Knorr Type | ---   |  <p>55344 55331<br/>55306</p>         |
| <b>54523</b> | K 001929      | Rep. Kit for Brake Caliper<br>Knorr Type | ---   |  <p>55349</p>                         |
| <b>54524</b> | K 001928      | Rep. Kit for Brake Caliper<br>Knorr Type | ---   |  <p>55333 55311 55292</p>            |
| <b>54525</b> | K 003902      | Rep. Kit for Brake Caliper<br>Knorr Type | ---   |                                     |
| <b>54526</b> | K 004100      | Rep. Kit for Brake Caliper<br>Knorr Type | ---   |  <p>55331 55312<br/>55306</p>       |
| <b>54684</b> | K 001915      | Rep. Kit for Brake Caliper<br>Knorr Type | ---   |  <p>55331 55345<br/>55306 55307</p> |



| Auger Nr.    | OEM Nr.   | Description                              | Model | Picture   |
|--------------|-----------|--|-------|---|
| <b>54685</b> | K 000935  | Rep. Kit for Brake Caliper<br>Knorr Type | ---   |    |
| <b>54686</b> | K 000132  | Rep. Kit for Brake Caliper<br>Knorr Type | ---   |    |
| <b>53866</b> | MCK1171/N | Rep. Kit for Brake Caliper<br>Ror Type   | ---   |  |
| <b>53867</b> | MCK1102/N | Rep. Kit for Brake Caliper<br>Ror Type   | ---   |  |
| <b>53868</b> | MCK1253   | Rep. Kit for Brake Caliper<br>Ror Type   | ---   |  |
| <b>53869</b> | MCK1254   | Rep. Kit for Brake Caliper<br>Ror Type   | ---   |  |

| Auger Nr.    | OEM Nr.      | Description                            | Model | Picture  |
|--------------|--------------|--|-------|--|
| <b>53870</b> | MCK1139      | Rep. Kit for Brake Caliper<br>Ror Type | ---   |  <p>55351</p>                               |
| <b>53871</b> | MCK1238      | Rep. Kit for Brake Caliper<br>Ror Type | ---   |  <p>55351</p>                               |
| <b>53872</b> | MCK1171      | Rep. Kit for Brake Caliper<br>Ror Type | ---   |  <p>55299 55318<br/>55374 55375</p>        |
| <b>53873</b> | MCK1192      | Rep. Kit for Brake Caliper<br>Ror Type | ---   |  <p>55299 55318<br/>55374 55375</p>       |
| <b>53874</b> | 5001 837 006 | Rep. Kit for Brake Caliper<br>Ror Type | ---   |  <p>55305 55301<br/>55365</p>             |
| <b>54169</b> | 5001 866 989 | Rep. Kit for Brake Caliper<br>Ror Type | ---   |  <p>55304 55303 55369<br/>55294 55302</p> |







| Auger Nr.    | OEM Nr.                      | Description                            | Model | Picture   |
|--------------|------------------------------|--|-------|---|
| <b>54170</b> | MCK1086                      | Rep. Kit for Brake Caliper<br>Ror Type | ---   |  <p>55301 55300 55384<br/>55369</p>  |
| <b>54171</b> | MCK1243                      | Rep. Kit for Brake Caliper<br>Ror Type | ---   |  <p>55296 55295 55384 55369</p>      |
| <b>54172</b> | 5001 866 400                 | Rep. Kit for Brake Caliper<br>Ror Type | ---   |  <p>55302 55369 55294<br/>55304</p> |
| <b>54173</b> | 5001 858 718<br>5001 860 792 | Rep. Kit for Brake Caliper<br>Ror Type | ---   |  <p>55369 55384<br/>55351</p>      |
| <b>54174</b> | 5001 866 398                 | Rep. Kit for Brake Caliper<br>Ror Type | ---   |  <p>55351</p>                      |
| <b>54175</b> | 5001 822 994                 | Rep. Kit for Brake Caliper<br>Ror Type | ---   |  <p>55297 55298<br/>55368</p>      |













| Auger Nr.    | OEM Nr. | Description                            | Model | Picture  |
|--------------|---------|--|-------|--|
| <b>54529</b> | MCK1103 | Rep. Kit for Brake Caliper<br>Ror Type | ---   |  <p>55301 55300<br/>55369 55343</p> |
| <b>54530</b> | MCK1134 | Rep. Kit for Brake Caliper<br>Ror Type | ---   |  <p>55315 55369<br/>55316</p>       |
| <b>54531</b> | SJ4077  | Rep. Kit for Brake Caliper<br>Ror Type | ---   |  <p>55364 55369</p>                |
| <b>54532</b> | SJ4052  | Rep. Kit for Brake Caliper<br>Ror Type | ---   |  <p>55366 55317 55297</p>         |
| <b>54533</b> | SP8597  | Rep. Kit for Brake Caliper<br>Ror Type | ---   |  <p>55362 55342</p>               |
| <b>54534</b> | SP9670  | Rep. Kit for Brake Caliper<br>Ror Type | ---   |  <p>55342 55360<br/>55361</p>     |





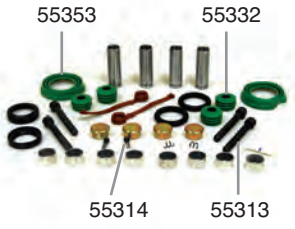

| Auger Nr.    | OEM Nr. | Description                            | Model | Picture  |
|--------------|---------|--|-------|--|
| <b>54535</b> | SP8567  | Rep. Kit for Brake Caliper<br>Ror Type | ---   |  <p>55359 55342</p>             |
| <b>54536</b> | SP9669  | Rep. Kit for Brake Caliper<br>Ror Type | ---   |  <p>55359<br/>55342 55361</p>   |
| <b>54537</b> | SP8564  | Rep. Kit for Brake Caliper<br>Ror Type | ---   |  <p>55342 55360</p>            |
| <b>54538</b> | SJ1034  | Rep. Kit for Brake Caliper<br>Ror Type | ---   |  <p>55319 55342</p>           |
| <b>54539</b> | SJ1030  | Rep. Kit for Brake Caliper             | ---   |  <p>55362<br/>55342 55361</p> |
| <b>54540</b> | SP8565  | Rep. Kit for Brake Caliper<br>Ror Type | ---   |  <p>55342<br/>55320</p>       |







| Auger Nr.    | OEM Nr. | Description                            | Model | Picture  |
|--------------|---------|--|-------|--|
| <b>54541</b> | SJ1022  | Rep. Kit for Brake Caliper<br>Ror Type | ---   |  <p>55319 55342</p>         |
| <b>54542</b> | SP8566  | Rep. Kit for Brake Caliper<br>Ror Type | ---   |  <p>55342</p>               |
| <b>54543</b> | SJ1035  | Rep. Kit for Brake Caliper<br>Ror Type | ---   |  <p>55319 55342</p>        |
| <b>54544</b> | SP8902  | Rep. Kit for Brake Caliper<br>Ror Type | ---   |  <p>55342 55321</p>       |
| <b>54545</b> | SJ1037  | Rep. Kit for Brake Caliper<br>Ror Type | ---   |  <p>55342 55362</p>       |
| <b>54546</b> | SJ1213  | Rep. Kit for Brake Caliper<br>Ror Type | ---   |  <p>55368 55298 55297</p> |

| Auger Nr.    | OEM Nr.           | Description                            | Model | Picture  |
|--------------|-------------------|--|-------|--|
| <b>54547</b> | SJ4078            | Rep. Kit for Brake Caliper<br>Ror Type | ---   |  <p>55364 55367 55369<br/>55382 55285</p> |
| <b>54548</b> | SJ4076            | Rep. Kit for Brake Caliper<br>Ror Type | ---   |  <p>55301 55305 55369</p>                 |
| <b>54549</b> | MCK1213<br>SJ4011 | Rep. Kit for Brake Caliper<br>Ror Type | ---   |  <p>55298 55368<br/>55297</p>            |
| <b>54550</b> | MCK1102           | Rep. Kit for Brake Caliper<br>Ror Type | ---   |  <p>55301 55369<br/>55300</p>           |
| <b>54551</b> | MCK1116           | Rep. Kit for Brake Caliper<br>Ror Type | ---   |  <p>55369 55315<br/>55316</p>           |
| <b>54552</b> | SJ4021            | Rep. Kit for Brake Caliper<br>Ror Type | ---   |  <p>55301 55305</p>                     |

| Auger Nr.    | OEM Nr.      | Description                            | Model | Picture  |
|--------------|--------------|--|-------|--|
| <b>54553</b> | MCK1135      | Rep. Kit for Brake Caliper<br>Ror Type | ---   |  <p>55316<br/>55369</p>         |
| <b>54554</b> | MCK1299      | Rep. Kit for Brake Caliper<br>Ror Type | ---   |  <p>55316 55315<br/>55369</p>   |
| <b>54555</b> | SJ4053       | Rep. Kit for Brake Caliper<br>Ror Type | ---   |  <p>55366</p>                  |
| <b>54556</b> | MCK1118      | Rep. Kit for Brake Caliper<br>Ror Type | ---   |  <p>55316<br/>55369</p>       |
| <b>54557</b> | 5000 821 966 | Rep. Kit for Brake Caliper<br>Ror Type | ---   |  <p>55383 55297</p>           |
| <b>55176</b> | 5001 831 176 | Rep. Kit for Brake Caliper<br>Ror Type | ---   |  <p>55346 55329<br/>55330</p> |

| Auger Nr.    | OEM Nr.    | Description                              | Model | Picture  |
|--------------|------------|--|-------|--|
| <b>55179</b> | SJ1033     | Rep. Kit for Brake Caliper<br>Ror Type   | ---   |  <p>55360 55342<br/>55361</p>               |
| <b>55180</b> | SJ1018     | Rep. Kit for Brake Caliper<br>Ror Type   | ---   |   |
| <b>54527</b> | 12999199VT | Rep. Kit for Brake Caliper<br>Wabco Type | ---   |  <p>55356</p>                              |
| <b>54528</b> | 12999729VT | Rep. Kit for Brake Caliper<br>Wabco Type | ---   |  <p>55353 55332<br/>55314 55313</p>       |
| <b>54558</b> | 12999677VT | Rep. Kit for Brake Caliper<br>Wabco Type | ---   |  <p>55350 55334 55379<br/>55299 55322</p> |
| <b>54559</b> | 12999738VT | Rep. Kit for Brake Caliper<br>Wabco Type | ---   |  <p>55299 55323 55334<br/>55337 55354</p> |

| Auger Nr.    | OEM Nr.    | Description                              | Model | Picture   |
|--------------|------------|--|-------|---|
| <b>54560</b> | 12999552VT | Rep. Kit for Brake Caliper<br>Wabco Type | ---   |    |
| <b>54561</b> | 12999704VT | Rep. Kit for Brake Caliper<br>Wabco Type | ---   |    |
| <b>54562</b> | 12999746VT | Rep. Kit for Brake Caliper<br>Wabco Type | ---   |   |
| <b>54563</b> | 12999076VT | Rep. Kit for Brake Caliper<br>Wabco Type | ---   |  |
| <b>54564</b> | 12999197VT | Rep. Kit for Brake Caliper<br>Wabco Type | ---   |  |
| <b>54565</b> | 12999580VT | Rep. Kit for Brake Caliper<br>Wabco Type | ---   |  |

| Auger Nr.    | OEM Nr.    | Description                              | Model | Picture  |
|--------------|------------|--|-------|--|
| <b>54566</b> | 12999699VT | Rep. Kit for Brake Caliper<br>Wabco Type | ---   |  <p>55335<br/>55326 55325 55354</p>   |
| <b>54567</b> | 12999543VT | Rep. Kit for Brake Caliper<br>Wabco Type | ---   |  <p>55341</p>                         |
| <b>54568</b> | 12999551VT | Rep. Kit for Brake Caliper<br>Wabco Type | ---   |  <p>55328<br/>55338</p>              |
| <b>54569</b> | 12999678VT | Rep. Kit for Brake Caliper<br>Wabco Type | ---   |  <p>55334 55299 55379<br/>55322</p> |
| <b>54570</b> | 12999141VT | Rep. Kit for Brake Caliper<br>Wabco Type | ---   |  <p>55358</p>                       |
| <b>55286</b> | -          | Rep. Kit for Brake Caliper               | ---   |  <p>55369</p>                       |



## Diaphragms - Normal Stroke

**Auger Nr.: 52576**

O.E.M. Nr. 897 120 492.4

Type 9"

**Auger Nr.: 52578**

O.E.M. Nr. 897 120 505.4

Typ / Type 12"

**Auger Nr.: 52580**

O.E.M. Nr. 897 120 510.4

Type 16"

**Auger Nr.: 52581**

O.E.M. Nr. 897 120 520.4

Type 20"

**Auger Nr.: 52582**

O.E.M. Nr. 897 120 530.4

Type 24"

**Auger Nr.: 52583**

O.E.M. Nr. 897 120 540.4

Type 30"

**Auger Nr.: 52584**

O.E.M. Nr. 897 120 550.4

Type 36"



## Diaphragms - Long Stroke

**Auger Nr.: 52585**

O.E.M. Nr. 897 120 516.4

Type 16"

**Auger Nr.: 52586**

O.E.M. Nr. 897 120 526.4

Type 20"

**Auger Nr.: 52587**

O.E.M. Nr. 897 120 534.4

Type 24"

**Auger Nr.: 52588**

O.E.M. Nr. 897 120 546.4

Type 30"



### Double Diaphragm Brake Chamber (for disc brake)

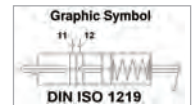
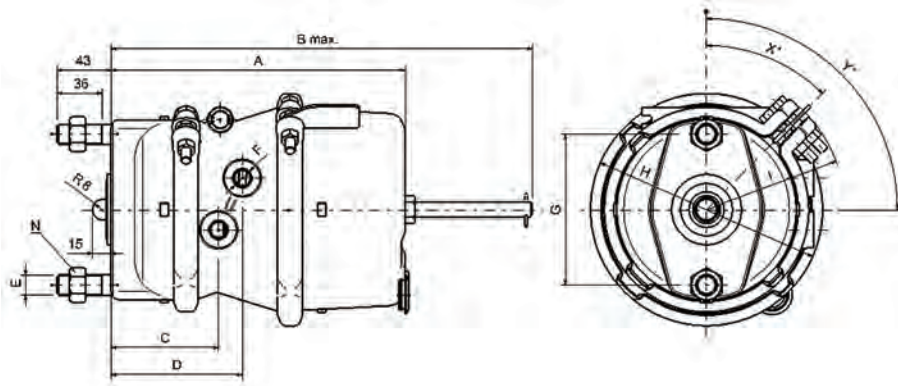

| Auger Nr. | Type  | A   | B   | C           | D     | E                                     | F       | G                | H   | I   | N (Nut) |
|-----------|-------|-----|-----|-------------|-------|---------------------------------------|---------|------------------|-----|-----|---------|
| 21000     | 16x24 | 236 | 337 | 86          | 105   | M16x1,5                               | M16x1,5 | 120.7            | 186 | 111 | -       |
| 21001     | 16x24 | 236 | 337 | 86          | 105   | M16x1,5                               | M16x1,5 | 120.7            | 186 | 111 | x       |
| 21002     | 20x24 | 252 | 353 | 93.5        | 113.5 | M16x1,5                               | M16x1,5 | 120.7            | 186 | 111 | -       |
| 21003     | 20x24 | 252 | 353 | 93.5        | 113.5 | M16x1,5                               | M16x1,5 | 120.7            | 186 | 111 | x       |
| Auger Nr. | Type  | X   | Y   | Weight (Kg) |       | Operation Pressure                    |         | : 10 Bar         |     |     |         |
| 21000     | 16x24 | 270 | 90  | 7.2         |       | Temperature Range                     |         | : -40 C° / 80 C° |     |     |         |
| 21001     | 16x24 | -45 | 240 | 7.3         |       | Medium                                |         | : Air            |     |     |         |
| 21002     | 20x24 | 270 | 90  | 7.6         |       | Force of Return Spring at Stroke 0 mm |         | : 150+30 / -20 N |     |     |         |
| 21003     | 20x24 | -45 | 240 | 7.7         |       | Stroke                                |         | : 57...64 Stroke |     |     |         |

#### Auger Nr.: 21000



Knorr Part Nr: BS7304

Stroke: 57 / 57

Type: 16 x 24"

#### Auger Nr.: 21001



with rep. kit

Bpw Nr: 05.444.41.01.0

Stroke: 57 / 57

Type: 16 x 24"

#### Auger Nr.: 21002



Knorr Part Nr: ---

Stroke: 64 / 64

Type: 20 x 24"

#### Auger Nr.: 21003



with rep. kit

Bpw Nr: 05.444.44.01.0

Stroke: 64 / 64

Type: 20 x 24"

## Service Brake Chamber (for disc brake)

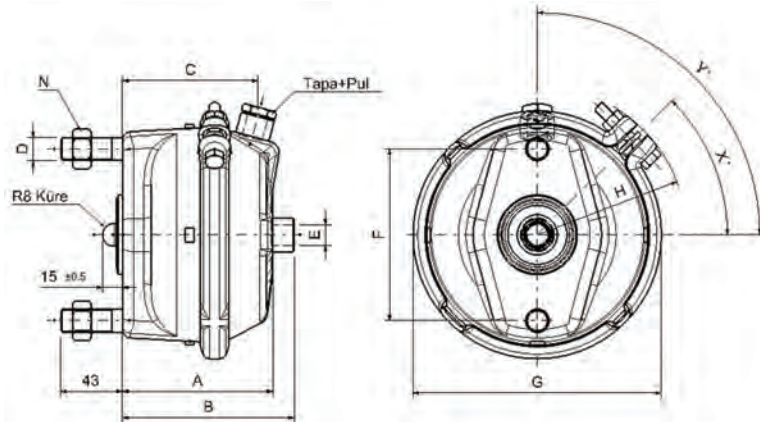

| Auger Nr. | Type | A    | B     | C    | D,E     | F     | G   | H     | X    | Y    | Cap+N<br>Washer | Weight |
|-----------|------|------|-------|------|---------|-------|-----|-------|------|------|-----------------|--------|
| 21004     | 16   | 97.5 | -     | 86   | M16x1,5 | 120.7 | 164 | 101   | -45  | -180 | -               | 2,9kg  |
| 21005     | 16   | 97.5 | 111.5 | 86   | M16x1,5 | 120.7 | 164 | 101   | -210 | -210 | x               | 3kg    |
| 21006     | 20   | 105  | -     | 95   | M16x1,5 | 120.7 | 174 | 104.5 | -45  | -180 | -               | 3,3kg  |
| 21007     | 20   | 105  | 121   | 95   | M16x1,5 | 120.7 | 174 | 104.5 | -210 | -210 | x               | 3,4kg  |
| 21008     | 24   | 103  | -     | 93.5 | M16x1,5 | 120.7 | 186 | 111   | -45  | -180 | -               | 3,5kg  |
| 21009     | 24   | 103  | 117   | 93.5 | M16x1,5 | 120.7 | 186 | 111   | -210 | -210 | x               | 3,6kg  |

|                    |                 |                                       |                 |
|--------------------|-----------------|---------------------------------------|-----------------|
| Operation Pressure | :10 Bar         | Force of Return Spring at Stroke 0 mm | :150+30 / -20 N |
| Temperature Range  | :-40 C° / 80 C° | Stroke                                | :57...64 Stroke |
| Medium             | :Air            |                                       |                 |

## Auger Nr.: 21004



Knorr Part Nr: BS3300  
Stroke: 57  
Type: 16"

## Auger Nr.: 21005

Mercedes Nr : 006 420 52 24  
Daf Nr : 1505 241  
B. Achsen Nr: 05.444.32.01.0  
05.444.32.02.0  
02.0327.70.00  
02.0327.71.00  
Fruehauf Nr : AJV4526  
S. Achsen Nr : 3 454 1065 60  
3 454 1081 60



with rep. kit

Krone Nr: 5812866-58128660 Wabco: 4231047100 Kögel: 334652  
Stroke: 57  
Type: 16"

## Auger Nr.: 21006



Knorr Part Nr: BS3404  
Stroke: 64  
Type: 20"

## Auger Nr.: 21007

Mercedes Nr : 007 420 12 24  
Daf Nr : 1517 954  
B. Achsen Nr: 05.444.34.01.0  
05.444.34.02.0  
02.0327.74.00  
02.0327.75.00  
S. Achsen Nr : 3 454 1067 60  
3 454 1082 60



with rep. kit

Krone Nr: --- Wabco: 4235050000 Kögel: 337900  
Stroke: 64  
Type: 20"

## Auger Nr.: 21008



Knorr Part Nr: BS3509  
Stroke: 64  
Type: 24"

## Auger Nr.: 21009

Mercedes Nr : 007 420 14 24  
Daf Nr : 1517 956  
B. Achsen Nr: 05.444.36.01.0  
05.444.36.02.0  
02.0327.78.00  
02.0327.79.00  
S. Achsen Nr : 3 454 1069 60



with rep. kit

Krone Nr: --- Wabco: 4235060010 Kögel: 337902  
Stroke: 64  
Type: 24"

### Service Brake Chamber (for drum brake)

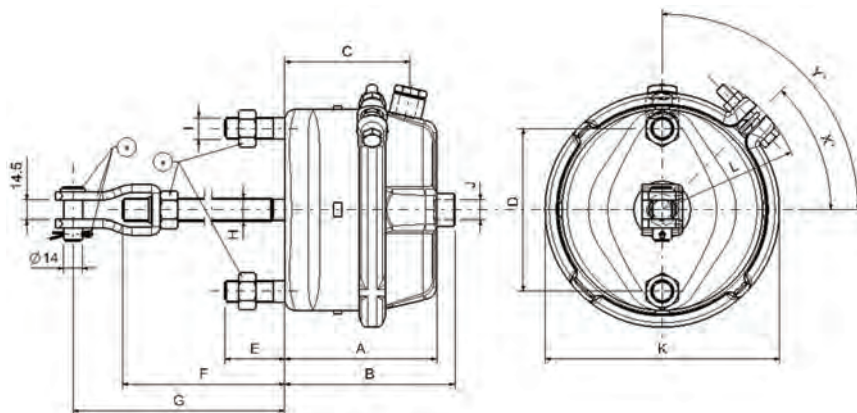

| Auger Nr. | Type | A     | B   | C    | D     | E    | F   | G   | H,I,J   | K   | L     | X   | Y   | ** | Weight |
|-----------|------|-------|-----|------|-------|------|-----|-----|---------|-----|-------|-----|-----|----|--------|
| 21010     | 16   | 112.5 | 126 | 93   | 120.7 | 43   | 185 | -   | M16x1,5 | 164 | 100   | -45 | 90  | -  | 3.05   |
| 21011     | 16   | 112.5 | 126 | 93   | 120.7 | 43   | 185 | 227 | M16x1,5 | 164 | 100   | 135 | -90 | X  | 3.10   |
| 21012     | 20   | 113   | 126 | 93   | 120.7 | 44   | 185 | -   | M16x1,5 | 174 | 104.5 | -45 | 90  | -  | 3.10   |
| 21013     | 20   | 113   | 126 | 93   | 120.7 | 44   | 185 | 227 | M16x1,5 | 174 | 104.5 | 135 | -90 | X  | 3.50   |
| 21014     | 24   | 112.5 | 126 | 92.5 | 120.7 | 44   | 185 | -   | M16x1,5 | 186 | 111   | -45 | 90  | -  | 3.30   |
| 21015     | 24   | 112.5 | 126 | 92.5 | 120.7 | 44   | 185 | 227 | M16x1,5 | 186 | 111   | 135 | -90 | X  | 3.70   |
| 21016     | 30   | 117.5 | 131 | 96.5 | 120.7 | 43.5 | 185 | -   | M16x1,5 | 208 | 121   | -45 | 90  | -  | 4.05   |
| 21017     | 30   | 117.5 | 131 | 96.5 | 120.7 | 43.5 | 185 | 227 | M16x1,5 | 208 | 121   | 135 | -90 | X  | 4.45   |

|                    |                 |                                       |                 |
|--------------------|-----------------|---------------------------------------|-----------------|
| Operation Pressure | :10 Bar         | Force of Return Spring at Stroke 0 mm | :150+30 / -20 N |
| Temperature Range  | :-40 C° / 80 C° | Stroke                                | :57...64 Stroke |
| Medium             | :Air            |                                       |                 |

| Auger Nr.:21010       | Auger Nr.:21011   | Auger Nr.:21012       | Auger Nr.:21013  |
|-----------------------|---|-----------------------|--|
|                       | with rep. kit<br>   |                       | with rep. kit<br>  |
| Knorr Part Nr: BZ3370 | Krone Nr: 945157<br>Wabco Nr: 4231049000<br>Kögel Nr: 79537 | Knorr Part Nr: BX3417 | Krone Nr: 945154<br>Wabco Nr: 4231059000<br>Kögel Nr: 175202-79302 |
| Stroke: 75            | Stroke: 75  | Stroke: 75            | Stroke: 75   |
| Type: 16"             | Type: 16"   | Type: 20"             | Type: 20"  |

| Auger Nr.:21014       | Auger Nr.:21015  | Auger Nr.:21016       | Auger Nr.:21017  |
|-----------------------|--|-----------------------|--|
|                       | with rep. kit<br>  |                       | with rep. kit<br>  |
| Knorr Part Nr: BX3535 | Krone Nr: 945153<br>Wabco Nr: 4231069000<br>Kögel Nr: 175203-77348-79303 | Knorr Part Nr: BX3605 | Krone Nr: 945152<br>Wabco Nr: 4231079000<br>Kögel Nr: 175204-79545 |
| Stroke: 75            | Stroke: 75   | Stroke: 75            | Stroke: 75   |
| Type: 24"             | Type: 24"  | Type: 30"             | Type: 30"  |

## Double Diaphragm Brake Chamber (for drum brake)

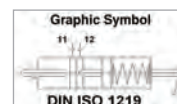
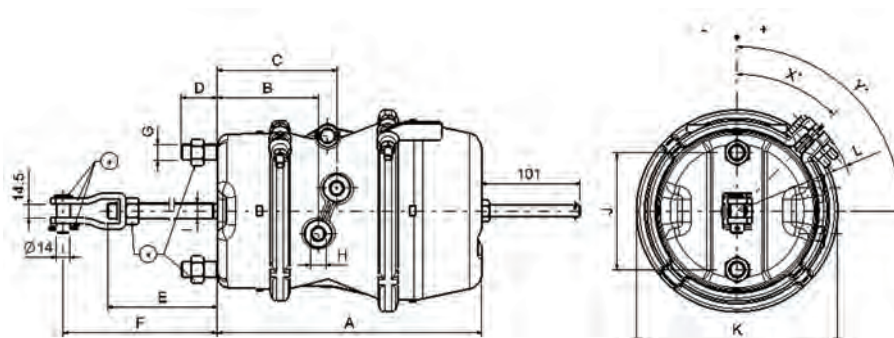

| Auger Nr. | Type  | A     | B     | C     | D  | E   | F   | G,H,I   | J     | K   | L   | '**' |
|-----------|-------|-------|-------|-------|----|-----|-----|---------|-------|-----|-----|------|
| 21018     | 24x30 | 274.5 | 104.5 | 123.5 | 37 | 185 | 227 | M16x1,5 | 120.7 | 208 | 121 | -    |
| 21019     | 24x30 | 274.5 | 104.5 | 123.5 | 37 | 185 | 227 | M16x1,5 | 120.7 | 208 | 121 | x    |
| 21020     | 30x30 | 271.5 | 102.5 | 121.5 | 37 | 185 | 227 | M16x1,5 | 120.7 | 208 | 121 | -    |
| 21021     | 30x30 | 271.5 | 102.5 | 121.5 | 37 | 185 | 227 | M16x1,5 | 120.7 | 208 | 121 | x    |

| Auger Nr. | Type  | X   | Y   | Weight (Kg) |
|-----------|-------|-----|-----|-------------|
| 21018     | 24x30 | 135 | 270 | 9.1         |
| 21019     | 24x30 | 135 | 270 | 9.5         |
| 21020     | 30x30 | 135 | 270 | 9.7         |
| 21021     | 30x30 | 135 | 270 | 10.1        |

|                                       |                  |
|---------------------------------------|------------------|
| Operation Pressure                    | : 10 Bar         |
| Temperature Range                     | : -40 C° / 80 C° |
| Medium                                | : Air            |
| Force of Return Spring at Stroke 0 mm | : 150+30 / -20 N |
| Stroke                                | : 75 Stroke      |

### Auger Nr.: 21018



|                |          |                |     |
|----------------|----------|----------------|-----|
| Knorr Part Nr: | ---      | Krone Part Nr: | --- |
| Wabco Part Nr: | ---      | Kögel Part Nr: | --- |
| Stroke:        | 75 / 75  |                |     |
| Type:          | 24 x 30" |                |     |

### Auger Nr.: 21019

R.V.I. Nr : 5021 170 326  
 Daf Nr : 1325 352  
 B. Achsen Nr: 05.444.20.01.0  
 05.444.20.04.0  
 05.444.20.10.0  
 05.444.20.11.0  
 02.0327.39.00  
 Schmitz Nr : 050408



with rep. kit

|                |            |                |         |
|----------------|------------|----------------|---------|
| Knorr Part Nr: | BX 7515    | Krone Part Nr: | 0945470 |
| Wabco Part Nr: | 9253713000 | Kögel Part Nr: | 335890  |
| Stroke:        | 75 / 75    |                |         |
| Type:          | 24 x 30"   |                |         |

### Auger Nr.: 21020



|                |          |                |     |
|----------------|----------|----------------|-----|
| Knorr Part Nr: | ---      | Krone Part Nr: | --- |
| Wabco Part Nr: | ---      | Kögel Part Nr: | --- |
| Stroke:        | 75 / 75  |                |     |
| Type:          | 30 x 30" |                |     |



### Auger Nr.: 21021

R.V.I. Nr : 5021 170 327  
 Daf Nr : 1325 351  
 B. Achsen Nr: 05.444.21.01.0  
 05.444.21.04.0  
 05.444.21.11.0



with rep. kit

|                |            |                |        |
|----------------|------------|----------------|--------|
| Knorr Part Nr: | ---        | Krone Part Nr: | ---    |
| Wabco Part Nr: | 9253723000 | Kögel Part Nr: | 343320 |
| Stroke:        | 75 / 75    |                |        |
| Type:          | 30 x 30"   |                |        |

| Auger Nr.    | OEM Nr.  | Description                         | Model | Picture   |
|--------------|--|-------------------------------------|-------|---|
| <b>52509</b> | 4325000200<br>4520021000<br>4520021070<br>0004291431 | Shut-off valve                      | ---   |  |
| <b>55385</b> | -  | Double Check Valve<br>M16x1.5       | ---   |  |
| <b>55386</b> | -  | Double Check Valve<br>3/8 - 18 NPTF | ---   |  |

### Quick Release Valves

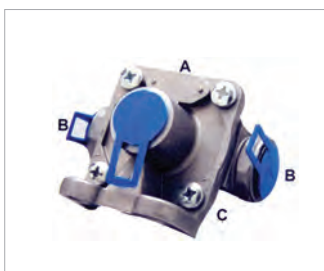

| Auger Nr.    | A - Supply    | B - Delivery  | C - Exhaust   |
|--------------|---------------|---------------|---------------|
| <b>52708</b> | M22x1.5       | M22x1.5       | M22x1.5       |
| <b>54770</b> | M22x1.5       | M16x1.5       | -             |
| <b>54771</b> | M16x1.5       | M16x1.5       | -             |
| <b>54772</b> | 3/8 - 18 NPTF | 3/8 - 18 NPTF | -             |
| <b>54773</b> | 1/2 - 14 NPTF | 3/8 - 18 NPTF | -             |
| <b>54774</b> | 3/8 - 18 NPTF | 3/8 - 18 NPTF | 3/8 - 18 NPTF |
| <b>54775</b> | 3/8 - 18 NPTF | 1/4 - 18 NPTF | 3/8 - 18 NPTF |
| <b>54776</b> | 1/4 - 18 NPTF | 1/4 - 18 NPTF | 3/8 - 18 NPTF |
| <b>54777</b> | 1/2 - 14 NPTF | 1/4 - 18 NPTF | 3/8 - 18 NPTF |
| <b>54778</b> | M16x1.5       | M16x1.5       | M16x1.5       |
| <b>54779</b> | 1/2 - 14 NPTF | 3/8 - 18 NPTF | 3/8 - 18 NPTF |
| <b>54780</b> | M22x1.5       | M16x1.5       | M16x1.5       |
| <b>54781</b> | M22x1.5       | M22x1.5       | M16x1.5       |

| Auger Nr.    | OEM Nr.   | Description                    | Model | Picture   |
|--------------|---|--------------------------------|-------|---|
| <b>52674</b> | 463 013 11 00<br>000 434 23 01<br>(MERCEDES)<br><br>B0 481 007 0 29<br>W463 013 110 0 | Brake Valve<br><br>M12x1.5     | ---   |    |
| <b>52675</b> | 463 013 11 40<br>000 434 24 01<br>(MERCEDES)<br><br>B0 481 007 0 10<br>W463 013 114 0 | Control Valve<br><br>M12x1.5   | ---   |    |
| <b>52676</b> | 934 300 00 10<br>000 434 08 07<br>(MERCEDES)<br><br>B0 481 019 002<br>W934 300 003 0  | Drain valve<br><br>M22x1.5     | ---   |  |
| <b>52632</b> | 432 500 02 00   | Air Line Filter<br><br>M22x1.5 | ---   |  |
| <b>54782</b> | ---   | Air Line Filter<br><br>M16x1.5 | ---   |  |



| Auger Nr.    | OEM Number  | Description    | Dimension      | Stroke  | Type |
|--------------|---|----------------|----------------|---------|------|
| <b>52593</b> | Universal Nr : SZ 11159<br>Mercedes Nr :<br>000 072 15 12 - 000 072 18 12<br>000 072 19 12 - 000 072 22 12  | Air Cylinder   | ø24 - M8       | 32 / 50 | 1    |
| <b>52594</b> | Mercedes Nr : 000 072 01 12<br>Universal Nr : SZ 1115   | Air Cylinder   | ø24 - M6       | 32 / 50 | 1    |
| <b>52595</b> | Mercedes Nr :<br>000 430 48 26 - 000 430 49 26<br>000 430 30 26 - 000 430 32 26<br>000 429 00 00 - 000482 024001<br>Universal Nr : SZ 1161 - SZ 1114<br>SZ 1124 - SZ 1130 | Brake Cylinder | ø28 - M8       | 48      | 2    |
| <b>54702</b> | Mercedes Nr : 000 430 01 26<br>421 411 08 60 - 421 411 30 10  | Brake Cylinder | ø35 - M12x1.75 | 85      | 3    |
| <b>54703</b> | Mercedes Nr :<br>000 430 06 26 - 048 200 60 13<br>421 411 02 50 - 421 411 30 60<br>000 430 06 26 - 000 430 10 26<br>Universal Nr : SZ 1208                                | Brake Cylinder | ø35 - M8       | 85      | 3    |
| <b>54704</b> | Mercedes Nr :<br>421 411 08 60 - 048 200 60 09<br>421 411 02 00 - 421 411 02 30<br>000 430 02 26 - 000 430 01 26<br>000 430 34 26<br>Universal Nr : SZ 1200               | Brake Cylinder | ø35 - M10      | 85      | 3    |
| <b>54705</b> | Mercedes Nr : 000 072 01 12<br>Man Nr : 81 15701 6112<br>81 15701 6079 - 81 15701 6099<br>81 15700 9006 - 81 15701 5001<br>81 15701 6091 - 81 15701 6119<br>81 15701 6116 | Air Cylinder   | ø50 - M10      | 50      | 4    |
| <b>54706</b> | Mercedes Nr :000 140 04 59<br>000 140 03 59 - 000 140 08 59<br>000 140 07 59<br>Universal Nr : SZ 1200  | Air Cylinder   | ø50 - M10      | 48      | 5    |
| <b>54707</b> | Mercedes Nr :<br>355 070 04 75 - 447 070 01 75  | Air Cylinder   | ø19 - M6       | 19      | 6    |



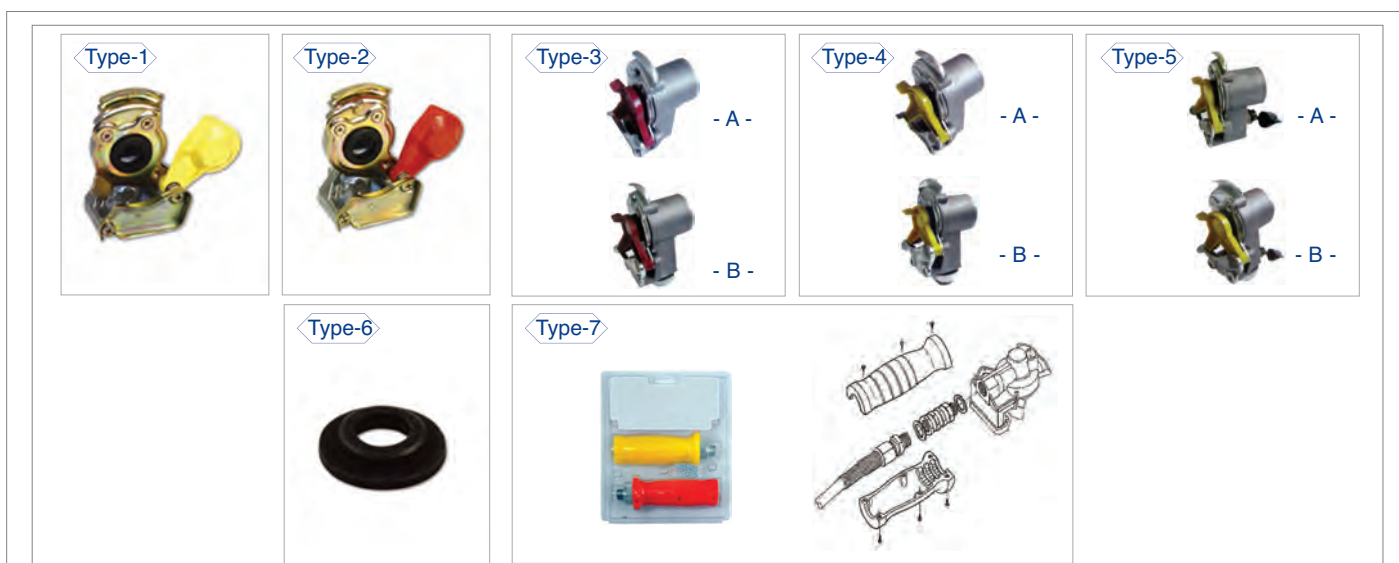



| Auger Nr. | OEM Number  | Description  | Type |
|-----------|---|--|------|
| 52515     | Universal Nr : 452 200 212 0<br>Mercedes Nr : 000 429 36 30<br>Man Nr : 81.51220.6025<br>Iveco Nr : 4680 365 - 6157 8000<br>Volvo Nr : 1505 065<br>R.V.I Nr : 5000 440 155  | Automatic Coupling<br>(For Brake-Yellow)<br>M22x1.5                      | 1    |
| 52516     | Mercedes Nr : 000 429 40 30 - 000 429 81 30<br>Volvo Nr : 1584 599 - 8157 984<br>Universal Nr : 952 200 222 0<br>Man Nr : 81.5122.06093<br>R.V.I Nr : 5000 442 714<br>Daf Nr : 0632 566<br>Iveco Nr : 2515 210<br>Scania Nr : 318 159 | Automatic Coupling<br>(For Brake-Yellow)<br>M16x1.5                      | 1    |
| 52519     | Universal Nr : 452 200 012 0<br>Mercedes Nr : 000 429 34 30<br>Man Nr : 81.5122.06033   | Standart Coupling (For Brake-Yellow)<br>M22x1.5                          | 1    |
| 52520     | Universal Nr : 952 200 022 0<br>Mercedes Nr : 000 429 59 30 - 000 429 79 30<br>Man Nr : 81.51220.6038 - 81.51220.6040<br>Iveco Nr : 2516 345 -2516 835<br>Scania Nr : 330 302   | Standart Coupling (For Brake-Yellow)<br>M16x1.5                          | 1    |
| 52513     | Universal Nr : 452 200 211 0<br>Iveco Nr : 4680 365 - 6157 7724<br>Mercedes Nr : 000 429 35 30<br>Man Nr : 81.51220.6024<br>R.V.I. Nr : 5000 440 154<br>Daf Nr : 0109 915<br>Volvo Nr : 1504 064                                      | Automatic Coupling<br>(For Emergency-Red)<br>M22x1.5                     | 2    |
| 52514     | Universal Nr : 952 200 221 0<br>Mercedes Nr : 000 429 80 30 - 000 429 39 30<br>Volvo Nr : 1584598 - 8157983<br>Man Nr : 81.51220.6094<br>R.V.I. Nr : 5000 442 713<br>Iveco Nr : 2515298   | Automatic Coupling<br>(For Emergency-Red)<br>M16x1.5                     | 2    |
| 52517     | Universal Nr : 452 200 011 0<br>Man Nr : 88.51220.6003<br>Daf Nr : 0109912<br>Iveco Nr : 2519879  | Standart Coupling (For Emergency-Red)<br>M22x1.5                         | 2    |
| 52518     | Universal Nr : 952 200 021 0<br>R.V.I. Nr : 5000 60 8011<br>Man Nr : 81.51220.6075<br>Mercedes Nr : 000 429 79 30<br>Iveco Nr : 60135772<br>Scania Nr : 330301  | Standart Coupling (For Emergency-Red)<br>M16x1.5                         | 2    |
| 54687     | Universal Nr : 952 201 004 0  | Filter Coupling - Red - Semitrailer<br>M16x1.5                           | 3A   |
| 54688     | Universal Nr : 952 201 002 0  | Filter Coupling - Red (with nut)- Drawbar Tralier<br>M16x1.5             | 3B   |
| 54689     | Universal Nr : 952 201 003 0  | Filter Coupling - Yellow - Semitrailer<br>M16x1.5                        | 4A   |
| 54690     | Universal Nr : 952 201 001 0  | Filter Coupling - Yellow (with nut)<br>Drawbar Tralier M16x1.5           | 4B   |
| 54691     | Universal Nr : 952 201 008 0  | Filter Coupling - with test connector<br>Semitrailer M16x1.5             | 5A   |
| 54692     | Universal Nr : 952 201 007 0  | Filter Coupling - with test connector and nut<br>Drawbar Tralier M16x1.5 | 5B   |
| 52590     | Universal Nr : 897 550 020 4  | Rubber Seal Ring $\varnothing 19 \times \varnothing 28.5 \times 41.5$    | 6    |
| 54767     | -   | Handle Grip for Air Coupling - M16                                       | 7    |
| 54768     | -   | Handle Grip for Air Coupling - M22                                       | 7    |
| 54769     | -   | Handle Grip for Air Coupling - 1/2"                                      | 7    |

**Air Brake Coils (DIN 19638) Polyethilen Material**

| Auger Nr. | Description                    | End Fittings | Working / Total Length | Nr. of Turns / Dia |
|-----------|--------------------------------|--------------|------------------------|--------------------|
| 55387     | Air Brake Coils - Yellow PE    | M16x1.5      | 5 mt. / 6 mt.          | 20 / 76            |
| 55388     | Air Brake Coils - Red PE       | M16x1.5      | 5 mt. / 6 mt.          | 20 / 76            |
| 55389     | Air Brake Coils - Black/Yellow | M16x1.5      | 5 mt. / 6 mt.          | 20 / 76            |
| 55390     | Air Brake Coils - Black/Red    | M16x1.5      | 5 mt. / 6 mt.          | 20 / 76            |
| 55391     | Air Brake Coils - Yellow PE    | M16x1.5      | 5.50 mt. / 6.30 mt.    | 22 / 76            |
| 55392     | Air Brake Coils - Red PE       | M16x1.5      | 5.50 mt. / 6.30 mt.    | 22 / 76            |
| 55393     | Air Brake Coils - Black/Yellow | M16x1.5      | 5.50 mt. / 6.30 mt.    | 22 / 76            |
| 55394     | Air Brake Coils - Black/Red    | M16x1.5      | 5.50 mt. / 6.30 mt.    | 22 / 76            |
| 55395     | Air Brake Coils - Yellow PE    | M22x1.5      | 5 mt. / 6 mt.          | 20 / 76            |
| 55396     | Air Brake Coils - Red PE       | M22x1.5      | 5 mt. / 6 mt.          | 20 / 76            |
| 55397     | Air Brake Coils - Black/Yellow | M22x1.5      | 5 mt. / 6 mt.          | 20 / 76            |
| 55398     | Air Brake Coils - Black/Red    | M22x1.5      | 5 mt. / 6 mt.          | 20 / 76            |
| 55399     | Air Brake Coils - Yellow PE    | M22x1.5      | 5.50 mt. / 6.30 mt.    | 22 / 76            |
| 55400     | Air Brake Coils - Red PE       | M22x1.5      | 5.50 mt. / 6.30 mt.    | 22 / 76            |
| 55401     | Air Brake Coils - Black/Yellow | M22x1.5      | 5.50 mt. / 6.30 mt.    | 22 / 76            |
| 55402     | Air Brake Coils - Black/Red    | M22x1.5      | 5.50 mt. / 6.30 mt.    | 22 / 76            |
| 55403     | Air Brake Coils - Yellow PE    | 1/2" BSP     | 5 mt. / 6 mt.          | 20 / 76            |
| 55404     | Air Brake Coils - Red PE       | 1/2" BSP     | 5 mt. / 6 mt.          | 20 / 76            |
| 55405     | Air Brake Coils - Black/Yellow | 1/2" BSP     | 5 mt. / 6 mt.          | 20 / 76            |
| 55406     | Air Brake Coils - Black/Red    | 1/2" BSP     | 5 mt. / 6 mt.          | 20 / 76            |
| 55407     | Air Brake Coils - Yellow PE    | 1/2" BSP     | 5.50 mt. / 6.30 mt.    | 22 / 76            |
| 55408     | Air Brake Coils - Red PE       | 1/2" BSP     | 5.50 mt. / 6.30 mt.    | 22 / 76            |
| 55409     | Air Brake Coils - Black/Yellow | 1/2" BSP     | 5.50 mt. / 6.30 mt.    | 22 / 76            |
| 55410     | Air Brake Coils - Black/Red    | 1/2" BSP     | 5.50 mt. / 6.30 mt.    | 22 / 76            |

| Auger Nr.    | OEM Nr. | Description   | Model | Picture   |
|--------------|---------|---|-------|---|
| <b>55411</b> | -       | Air Cleaner Hose, Red<br>Blowgun for trucks,<br>1gun + 1 PE Airflex<br><br>L: 5.50 mt. / M12x1.5    | -     |  |
| <b>55412</b> | -       | Air Cleaner Hose, Yellow<br>Blowgun for trucks,<br>1gun + 1 PE Airflex<br><br>L: 5.50 mt. / M12x1.5 | -     |  |

## Air Brake Coils (DIN 74323-73378) Polyamid Material

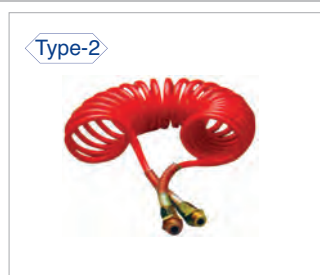

| Auger Nr. | Description                          | Working Length/Total Length | Nr. of Turns / Dia | Type |
|-----------|--------------------------------------|-----------------------------|--------------------|------|
| 54751     | Air Brake Coils<br>Yellow - M16x1.5  | 5.50 mt. / 6.60 mt.         | 20 / 90            | 1    |
| 54753     | Air Brake Coils<br>Yellow - M22x1.5  | 5.50 mt. / 6.60 mt.         | 20 / 90            | 1    |
| 54755     | Air Brake Coils<br>Yellow - 1/2" BSP | 5.50 mt. / 6.60 mt.         | 20 / 90            | 1    |
| 54752     | Air Brake Coils<br>Red - M16x1.5     | 5.50 mt. / 6.60 mt.         | 20 / 90            | 2    |
| 54754     | Air Brake Coils<br>Red - M22x1.5     | 5.50 mt. / 6.60 mt.         | 20 / 90            | 2    |
| 54756     | Air Brake Coils<br>Red - 1/2" BSP    | 5.50 mt. / 6.60 mt.         | 20 / 90            | 2    |

## Air Brake Coils for Trucks (DIN 74323) (ø12x9mm)

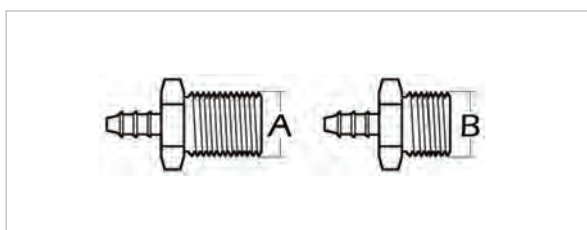

| Auger Nr. | Description                    | Thread A / Thread B                | Nr. of Turns / Dia | Mark                             |
|-----------|--------------------------------|------------------------------------|--------------------|----------------------------------|
| 54763     | Air Brake Coils - Black/Red    | M16x1.5 / M16x1.5                  | 20 / 90            | Volvo                            |
| 54764     | Air Brake Coils - Black/Yellow | M16x1.5 / M16x1.5                  | 20 / 90            | Volvo                            |
| 54765     | Air Brake Coils - Black/Red    | M22x1.5 / M22x1.5                  | 20 / 90            | Mercedes                         |
| 54766     | Air Brake Coils - Black/Yellow | M22x1.5 / M22x1.5                  | 20 / 90            | Mercedes                         |
| 54757     | Air Brake Coils - Black/Red    | M18x1.5-34 mm. /<br>M16x1.5-34 mm. | 20 / 90            | Man / Mercedes<br>Scania / Volvo |
| 54758     | Air Brake Coils - Black/Yellow | M18x1.5-34 mm. /<br>M16x1.5-34 mm. | 20 / 90            | Man / Mercedes<br>Scania / Volvo |
| 54759     | Air Brake Coils - Black/Red    | M18x1.5 / M16x1.5                  | 20 / 90            | Man / Mercedes<br>Scania / Volvo |
| 54760     | Air Brake Coils - Black/Yellow | M18x1.5 / M16x1.5                  | 20 / 90            | Man / Mercedes<br>Scania / Volvo |
| 54761     | Air Brake Coils - Black/Red    | M18x1.5-34 mm. / M16x1.5           | 20 / 90            | Man / Mercedes<br>Scania / Volvo |
| 54762     | Air Brake Coils - Black/Yellow | M18x1.5-34 mm. / M16x1.5           | 20 / 90            | Man / Mercedes<br>Scania / Volvo |



| Auger Nr. | OEM Number       | Description  | Type |
|-----------|------------------|--|------|
| 52521     | 8 JA 003 831 001 | 7 Pole Aluminium Plug - 24 V. - N Type Screw or Flat - Black   | 1A   |
| 52591     | 8 JA 003 832 001 | 7 Pole Aluminium Plug - 24 V. - S Type Screw or Flat - White   | 1B   |
| 54715     | -                | 7 Pole Plastic Plug - 24 V. - N Type Screw or Flat - Black     | 2A   |
| 54716     | -                | 7 Pole Plastic Plug - 24 V. - S Type Screw or Flat - White     | 2B   |
| 52522     | 8 JA 003 883 001 | 7 Pole Aluminium Socket - 24 V. - N Type Screw - Black         | 3A   |
| 54731     | -                | 7 Pole Aluminium Socket - 24 V. - N Type Flat - Black          | 3A   |
| 52592     | 8 JA 003 834 001 | 7 Pole Aluminium Socket - 24 V. - S Type Screw - White         | 3B   |
| 54732     | -                | 7 Pole Aluminium Socket - 24 V. - S Type Flat - White          | 3B   |
| 54723     | -                | 7 Pole Plastic Socket - 24 V. - N Type Screw - Black           | 4A   |
| 54729     | -                | 7 Pole Plastic Socket - 24 V. - N Type Flat - Black            | 4A   |
| 54724     | -                | 7 Pole Plastic Socket - 24 V. - S Type Screw - White           | 4B   |
| 54730     | -                | 7 Pole Plastic Socket - 24 V. - S Type Flat - White            | 4B   |
| 54721     | -                | 7 Pole Aluminium Plug - 12 V. - N Type Screw or Flat - Black   | 5A   |
| 54722     | -                | 7 Pole Aluminium Plug - 12 V. - S Type Screw or Flat - White   | 5B   |
| 54733     | -                | 7 Pole Aluminium Socket - 12 V. - N Type Screw or Flat - Black | 6A   |
| 54734     | -                | 7 Pole Aluminium Socket - 12 V. - S Type Screw or Flat - White | 6B   |

## Trailer Electrical Cables - Polyethilen Material



| Auger Nr. | Description                                       | Dimension                        | Type |
|-----------|---|----------------------------------|------|
| 52523     | N Type Black Aluminium Plugs - 24 V - Black Cable | 4.50 M. - Inner Diameter: 44 mm. | 1    |
| 54708     | N Type Black Plastic Plugs - 24 V - Black Cable   | 4.50 M. - Inner Diameter: 44 mm. | 2    |
| 54709     | S Type White Aluminium Plugs - 24 V - Black Cable | 4.50 M. - Inner Diameter: 44 mm. | 3    |
| 54710     | S Type White Plastic Plugs - 24 V - Black Cable   | 4.50 M. - Inner Diameter: 44 mm. | 3    |
| 54711     | S Type White Plastic Plugs - 24 V - Green Cable   | 4.50 M. - Inner Diameter: 44 mm. | 3    |
| 54712     | S Type White Plastic Plugs - 24 V - Green Cable   | 4.50 M. - Inner Diameter: 44 mm. | 3    |
| 54713     | N Type Black Metal Plugs - 12 V - Black Cable     | 4.50 M. - Inner Diameter: 44 mm. | 4    |
| 54714     | S Type Black Metal Plugs - 12 V - Black Cable     | 4.50 M. - Inner Diameter: 44 mm. | 4    |

## Trailer Electrical Cables - Polyurethan Material







| Auger Nr. | Description                                       | Dimension                        | Type |
|-----------|---|----------------------------------|------|
| 55413     | N Type Black Aluminium Plugs - 24 V - Black Cable | 4.50 M. - Inner Diameter: 44 mm. | 1    |
| 55414     | N Type Black Plastic Plugs - 24 V - Black Cable   | 4.50 M. - Inner Diameter: 44 mm. | 2    |
| 55415     | S Type White Aluminium Plugs - 24 V - Black Cable | 4.50 M. - Inner Diameter: 44 mm. | 3    |
| 55416     | S Type White Plastic Plugs - 24 V - Black Cable   | 4.50 M. - Inner Diameter: 44 mm. | 3    |
| 55417     | S Type White Plastic Plugs - 24 V - Green Cable   | 4.50 M. - Inner Diameter: 44 mm. | 3    |
| 55418     | S Type White Plastic Plugs - 24 V - Green Cable   | 4.50 M. - Inner Diameter: 44 mm. | 3    |
| 55419     | N Type Black Metal Plugs - 12 V - Black Cable     | 4.50 M. - Inner Diameter: 44 mm. | 4    |
| 55420     | S Type Black Metal Plugs - 12 V - Black Cable     | 4.50 M. - Inner Diameter: 44 mm. | 4    |

**Trailer ABS Cable - ADR Plugs (ISO 12098) Polyurethan Material**



| Auger Nr. | Description   | Dimension   |
|-----------|---|---|
| 54743     | 15 Pole Electrical - Coil GGVS<br>( with 2 Plugs 15 - Poles ) | Inner Diameter: ø44 mm. (12x1.5 mm <sup>2</sup> / 3x2.5 mm <sup>2</sup> ) - 3.00 m. |
| 54744     | 15 Pole Electrical - Coil GGVS<br>( with 2 Plugs 15 - Poles ) | Inner Diameter: ø44 mm. (12x1.5 mm <sup>2</sup> / 3x2.5 mm <sup>2</sup> ) - 3.50 m. |
| 54745     | 15 Pole Electrical - Coil GGVS<br>( with 2 Plugs 15 - Poles ) | Inner Diameter: ø44 mm. (12x1.5 mm <sup>2</sup> / 3x2.5 mm <sup>2</sup> ) - 4.00 m. |
| 54746     | 15 Pole Electrical - Coil GGVS<br>( with 2 Plugs 15 - Poles ) | Inner Diameter: ø44 mm. (12x1.5 mm <sup>2</sup> / 3x2.5 mm <sup>2</sup> ) - 4.50 m. |

**Contact Allocations for 15 Pole  
ISO 12098 15 Core Cable**

|            |   |  |
|------------|---|--|
| 1-Yellow   |  | Left Hand Direction Indicator              |
| 2-Green    |  | Right Hand Direction Indicator             |
| 3-Blue     |  | Rear Fog Light                             |
| 4-White    |  | Common Return                              |
| 5-Black    |  | Left Hand Rear Position and Marker Lights  |
| 6-Brown    |  | Right Hand Rear Position and Marker Lights |
| 7-Red      |  | Stop Lights                                |
| 8-Pink     |  | Reversing Light                            |
| 9-Orange   |  | Power Supply Steady Constant               |
| 10-Grey    |  | Worn Brake Lining Sensor                   |
| 11-W.Black |  | Pressure Sensor for Spring Brake           |
| 12-W.Blue  |  | Axle Lifting Device                        |
| 13-W.Red   |  | Common Return for Data Lines               |
| 14-W.Green |  | Canh                                       |
| 15-W.Brown |  | Canl                                       |

## Trailer Adapter Cable (ISO 12098) Polyurethan Material

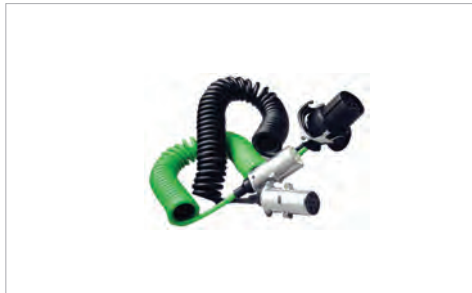

| Auger Nr. | Description  | Dimension   |
|-----------|--|---|
| 54747     | 15 Pole Adapter Coil - Connection from Truck with 15 Pole Socket to Trailer with Socket Type S / N | Alum. Pulg7-Poles(6x1mm/1x2 mm) 24V. Type N-ISO 1185/Type S-ISO 373<br>Inner Diameter: ø40 mm. - 3.00 mt. (15 Pole Adapter Coil N Type) |
| 54748     | 15 Pole Adapter Coil - Connection from Truck with 15 Pole Socket to Trailer with Socket Type S / N | Alum. Pulg7-Poles(6x1mm/1x2 mm) 24V. Type N-ISO 1185/Type S-ISO 373<br>Inner Diameter: ø40 mm. - 3.50 mt.                               |
| 54749     | 15 Pole Adapter Coil - Connection from Truck with 15 Pole Socket to Trailer with Socket Type S / N | Alum. Pulg7-Poles(6x1mm/1x2 mm) 24V. Type N-ISO 1185/Type S-ISO 373<br>Inner Diameter: ø40 mm. - 4.0 mt.                                |
| 54750     | 15 Pole Adapter Coil - Connection from Truck with 15 Pole Socket to Trailer with Socket Type S / N | Alum. Pulg7-Poles(6x1mm/1x2 mm) 24V. Type N-ISO 1185/Type S-ISO 373<br>Inner Diameter: ø40 mm. - 4.50 mt.                               |

## Also Deliverable in Green Colour Supplementary Cable

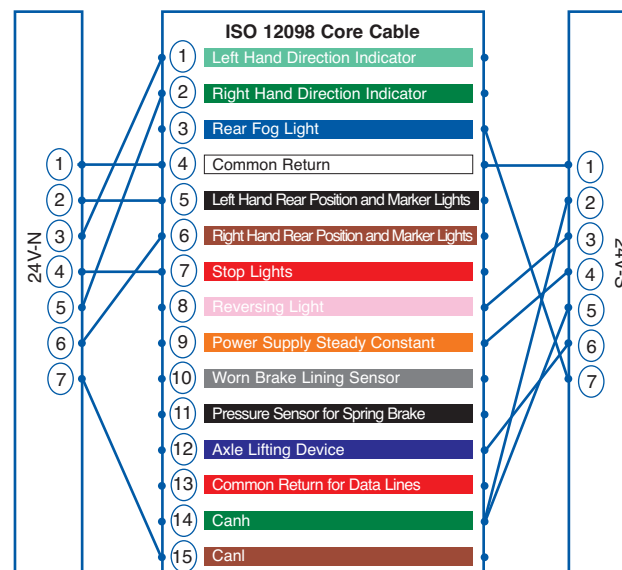

### ABS - EBS Coils - ADR Plugs (ISO 7638) - Polyurethan Material



| Auger Nr.    | Description   | Dimension  |
|--------------|---|--|
| <b>54735</b> | 5 Pole ABS - Coil GGVS<br>(with 2 ABS Plugs 5 Poles)              | Inner Diameter: ø44 mm. (3x1.5 mm <sup>2</sup> / 2x2.5 mm <sup>2</sup> ) - 3.00 m. |
| <b>54736</b> | 5 Pole ABS - Coil GGVS<br>(with 2 ABS Plugs 5 Poles)              | Inner Diameter: ø44 mm. (3x1.5 mm <sup>2</sup> / 2x2.5 mm <sup>2</sup> ) - 3.50 m. |
| <b>54737</b> | 5 Pole ABS - Coil GGVS<br>(with 2 ABS Plugs 5 Poles)              | Inner Diameter: ø44 mm. (3x1.5 mm <sup>2</sup> / 2x2.5 mm <sup>2</sup> ) - 4.00 m. |
| <b>54738</b> | 5 Pole ABS - Coil GGVS<br>(with 2 ABS Plugs 5 Poles)              | Inner Diameter: ø44 mm. (3x1.5 mm <sup>2</sup> / 2x2.5 mm <sup>2</sup> ) - 4.50 m. |
| <b>54739</b> | 7 Pole EBS - Electrical - Coil GGVS<br>(with 2 EBS Plugs 7 Poles) | Inner Diameter: ø44 mm. (5x1.5 mm <sup>2</sup> / 2x2.5 mm <sup>2</sup> ) - 3.00 m. |
| <b>54740</b> | 7 Pole EBS - Electrical - Coil GGVS<br>(with 2 EBS Plugs 7 Poles) | Inner Diameter: ø44 mm. (5x1.5 mm <sup>2</sup> / 2x2.5 mm <sup>2</sup> ) - 3.50 m. |
| <b>54741</b> | 7 Pole EBS - Electrical - Coil GGVS<br>(with 2 EBS Plugs 7 Poles) | Inner Diameter: ø44 mm. (5x1.5 mm <sup>2</sup> / 2x2.5 mm <sup>2</sup> ) - 4.00 m. |
| <b>54742</b> | 7 Pole EBS - Electrical - Coil GGVS<br>(with 2 EBS Plugs 7 Poles) | Inner Diameter: ø44 mm. (5x1.5 mm <sup>2</sup> / 2x2.5 mm <sup>2</sup> ) - 4.50 m. |

### Plugs & Sockets ADR Certified



| Auger Nr.    | OEM Number                                    | Description  | Type    |
|--------------|---|--------------|---------|
| <b>54717</b> | 446 008 39 02                                 | ABS Plug     | 5 Pole  |
| <b>54718</b> | 446 008 41 42 - 6500664 - 1505282             | EBS Plug     | 7 Pole  |
| <b>54719</b> | -   | ABS Plug     | 15 Pole |
| <b>54720</b> | -   | Adapter Plug |         |
| <b>54725</b> | 6500657 - 446 008 38 02<br>11058261 - 1506023 | ABS Socket   | 5 Pole  |
| <b>54726</b> | 4460084042-6500662-1506027                    | EBS Socket   | 7 Pole  |
| <b>54727</b> | -   | ABS Socket   | 15 Pole |
| <b>54728</b> | -   | Park Socket  |         |



Type-1



Type-2



Type-3



Type-4



| Auger Nr. | Description                                       | Type |
|-----------|---|------|
| 54696     | Aluminium Tank Cap with Key - ø60 / Jost Type     | 1    |
| 54700     | Aluminium Tank Cap with Key - ø80 / Jost Type     | 1    |
| 54695     | Aluminium Tank Cap without Key - ø60 / Jost Type  | 2    |
| 54699     | Aluminium Tank Cap without Key - / Jost Type      | 2    |
| 54694     | Galvanized Tank Cap with Key - ø60 / Jost Type    | 3    |
| 54698     | Galvanized Tank Cap with Key - ø80 / Jost Type    | 3    |
| 54701     | Galvanized Tank Cap with Key - ø40 / Jost Type    | 3    |
| 54693     | Galvanized Tank Cap without Key - ø60 / Jost Type | 4    |
| 54697     | Galvanized Tank Cap without Key - ø80 / Jost Type | 4    |

## Air Tanks

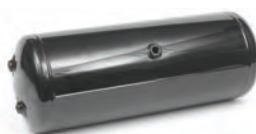

| Auger Nr. | OEM Number    | Dia. | Capacity | Lenght | Thread  |
|-----------|---------------|------|----------|--------|---------|
| 21900     | -             | ø206 | 10 L     | 357    | M22x1.5 |
| 21901     | -             | ø206 | 15 L     | 522    | M22x1.5 |
| 21902     | 950 420 003 0 | ø206 | 20 L     | 662    | M22x1.5 |
| 21903     | 950 520 003 0 | ø246 | 20 L     | 502    | M22x1.5 |
| 21904     | 950 530 002 0 | ø246 | 30 L     | 702    | M22x1.5 |
| 21905     | 950 740 002 0 | ø276 | 40 L     | 747    | M22x1.5 |
| 21906     | 950 760 002 0 | ø276 | 60 L     | 1102   | M22x1.5 |
| 21907     | -             | ø310 | 60 L     | 873    | M22x1.5 |
| 21908     | -             | ø310 | 80 L     | 1135   | M22x1.5 |
| 21909     |               | ø396 | 60 L     | 567    | M22x1.5 |
| 21910     | 950 080 002 0 | ø396 | 80 L     | 732    | M22x1.5 |
| 21911     | 950 100 002 0 | ø396 | 100 L    | 902    | M22x1.5 |
| 21912     | -             | ø396 | 120 L    | 1048   | M22x1.5 |
| 21951     | 950 730 005 0 | ø276 | 30 L     | -      | -       |

| Auger Nr.    | OEM Nr. | Description                                     | Model | Picture   |
|--------------|---------|---|-------|---|
| <b>53045</b> | ---     | Spring Pin Set for Trailer<br>M24x1.5/ø30x192   | ---   |    |
| <b>53046</b> | ---     | Spring Pin Set for Trailer<br>M24x1.5/ø30x190.5 | ---   |    |
| <b>53047</b> | ---     | Spring Pin Set for Trailer<br>M22x1.5/ø28x163.5 | ---   |   |
| <b>53048</b> | ---     | Spring Pin Set for Trailer<br>M24x1.5/ø30x164   | ---   |  |
| <b>53049</b> | ---     | Spring Pin Set for Trailer<br>M20x1.5/ø26x142   | ---   |  |



